

# GO RHINO®

## INSTALLATION INSTRUCTIONS

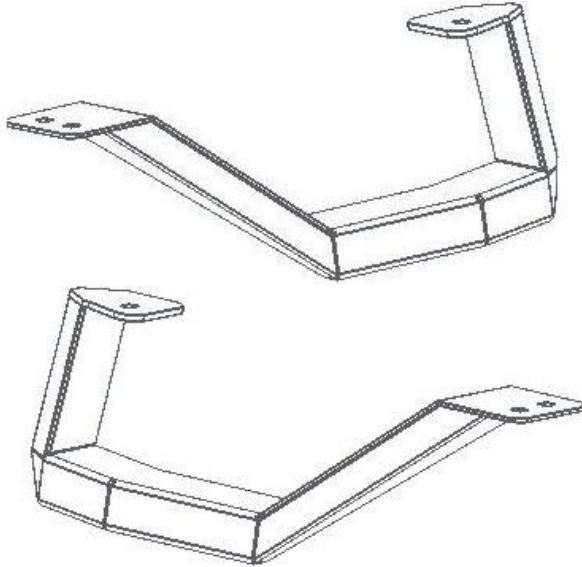

### PART NO.

- 69420000T
- 69420000PC

### PRODUCT DESCRIPTION:

- Straight RB Drop Steps

### PRODUCT SAFETY & LEGAL DISCLAIMER

- **IMPORTANT READ ALL INSTRUCTIONS CAREFULLY BEFORE INSTALLING, FAILURE TO DO SO MAY CAUSE PERSONAL INJURY OR DAMAGE TO PRODUCT AND/OR PROPERTY.**
- **Review the product package and contents prior to beginning the installation.** Take care when opening the packaging and removing items. If a return is needed you will want to return the product in its original packaging if possible.
- This instruction guide is provided as a GENERAL installation guide, some vehicles vary dimensionally and may require additional steps.
- Test fit the product on the vehicle prior to any third party modifications and or finishing. The manufacturer and/or distributors do not accept responsibility for third party charges, labor and or third part replacement modifications. Some modifications may void the factory warranty.
- Exercise due-diligence when installing this product. The manufacturer and distributors of this product do not accept any responsibility for vehicle damage or personal injury resulting from the installation of this product. Careless installation and operation can result in serious injury or equipment damage.
- This product is for general off-road use. All liability for installation and use rests with the owner/operator.
- **INSTALLER:** Once installation is complete, please return this guide along with other documentation included in this product back to the consumer for future reference. The manufacturer/distributors of this product do not guarantee this particular version will be available at a later date.



## INSTALLATION INSTRUCTIONS

### INJURY HAZARD

Please complete a shop and tool inspection prior to beginning the installation.

- Always make sure you have a clean, dry and well lit work area.
- Always remove jewelry, loose fitting clothing and wear protective gloves and eye protection.
- Always use extreme caution when jacking or raising a vehicle for work. Set the emergency brake and use tire/wheel blocks and jack stands. Refer to the vehicle manufacturer hand book. Utilize the vehicle manufacturers designated lifting points.
- Always use appropriate and adequate care in lifting parts during disassembly and installation. Seek help in lifting heavy or large items into place. Utilize jacks and or lifting devices when available.
- Always insure products are secure during disassembly and installation.
- Always wear eye protection and take steps to protect any exposed skin during the installations. Drilling, cutting and grinding plastic and metal may create flying particles that can cause injury.
- Always use extreme caution when drilling, cutting and or grinding on a vehicle. Thoroughly inspect the area to be drilled, on both sides of material, prior to modification and relocate any objects that may become damaged.
- Always assemble and tighten all fasteners per the installation instructions.
- Always route electrical cables carefully. Avoid moving parts, parts that may become hot and rough or sharp edges.
- Always insulate and protect all exposed wiring and electrical connections.

### MAINTENANCE AND CARE

- Always perform regular inspections and maintenance on mounts and related fasteners.
- Periodically check and tighten all fasteners.
- Stripped, fractured, or bent fasteners must be replaced.
- After washing the vehicle make sure to fully dry all surfaces.
- In areas with cold temperatures make sure to wash the product often to remove harmful materials used on road ways.
- Never use abrasive cleaners or polish compounds. Clean with a gentle soap and water. If you use wax use a non-abrasive automotive wax such as pure carnauba wax.

### WARNING

Some products have been designed to work together with factory rear sensor systems, factory forward facing sensor systems and factory air bags.

- Installation of some of these products may alter the factory sensor system performance.
- Factory sensors may read shackles or hooks protruding from the fairlead and or tow hooks.
- All sensor testing is completed by Go Rhino Products and or third party testing labs on modified vehicles.
- Sensor sensitivity, factory sensor housing, orientation, and operating conditions are all variables that will influence functionality of the sensors.
- Installation of some product may effect the factory air bag systems.
- Some products allow the use of third party products such as winches, shackles, hooks, etc. Follow the respective manufacturers operating instructions for use with our products.
- Make sure to fully understand the product, it's intended use and operation prior to use.
- Above all... be safe!

# GO RHINO®

## INSTALLATION INSTRUCTIONS

PARTS INCLUDED IN THIS LIST:

ITEM	QTY.	DESCRIPTION	ITEM	QTY.	DESCRIPTION
A	8	5/16" X 1" Hex Head Screw	E	2	Auxiliary Bracket
B	8	5/16" Lock washer	F	1	Driver Straight Drop Step
C	8	5/16" Flat Washer	G	1	Passenger Straight Drop Step
D	2	U-Bracket			

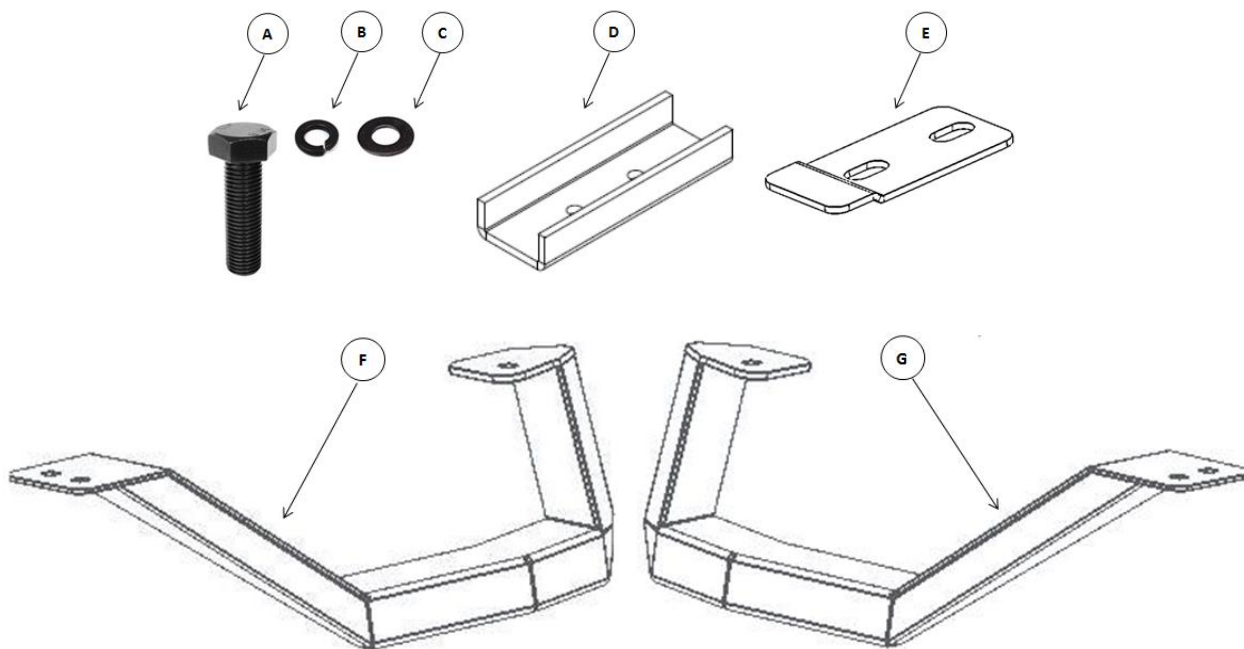

Go Rhino recommends you, the installer, read this installation instruction manual from front to back before installing the product.

### TOOLS NEEDED FOR INSTALLATION:

- ½" Wrench or Socket and Ratchet

ESTIMATED TIME FOR INSTALLATION:

30 Min.

# GORRHINO®

## INSTALLATION INSTRUCTIONS

Typical RB Drop Step attachment to RB10 Running Board, driver side front or rear door position.

**Step-1** Attach the Auxiliary Bracket to the U-Bracket using (1) 5/16" x 1" hex head screw, (1) 5/16" lock washer and (1) 5/16" flat washer. Do not tighten the screw, (FIGURE 1).

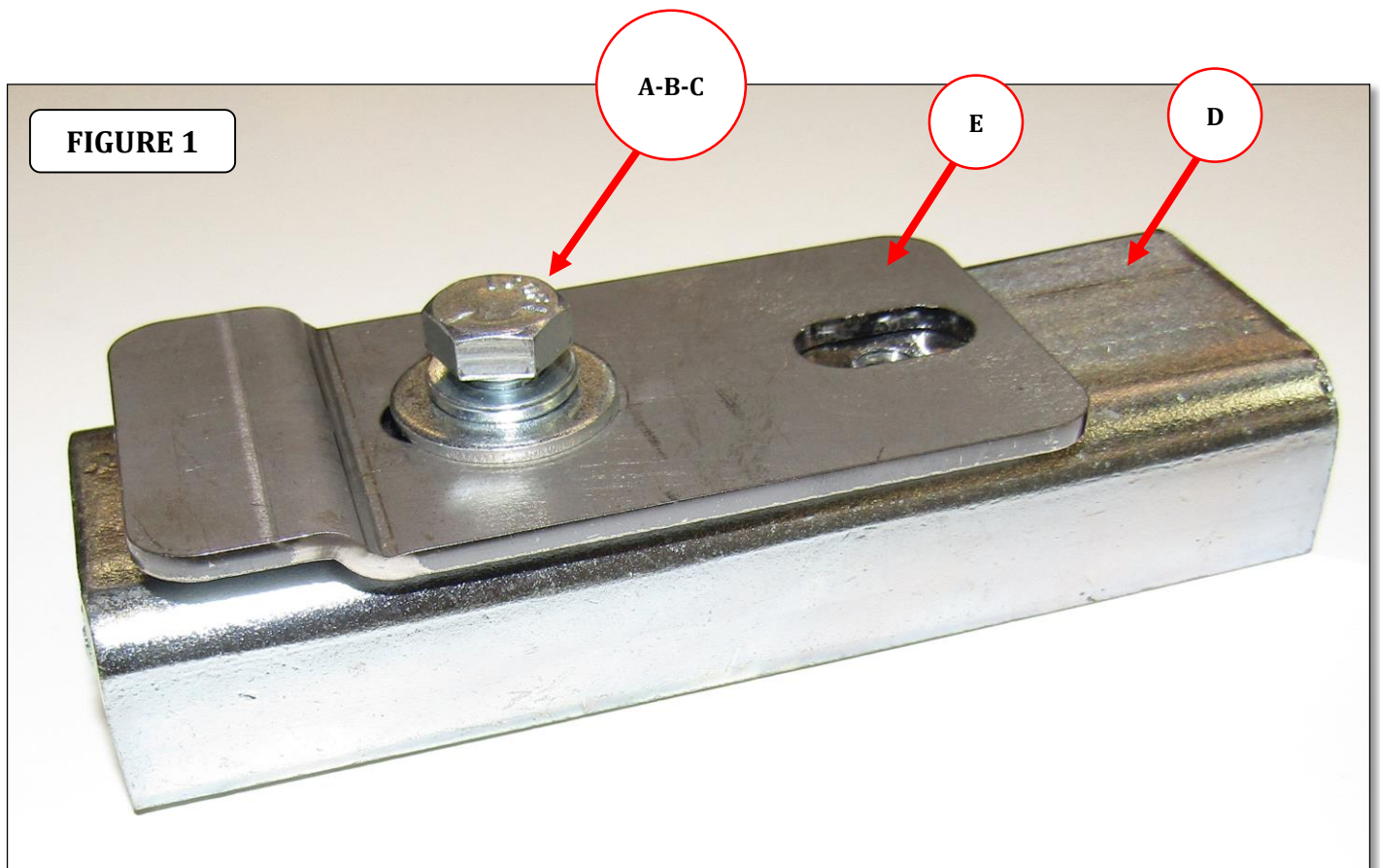

# GORRHINO®

## INSTALLATION INSTRUCTIONS

Typical RB Drop Step attachment to RB10 Running Board, driver side front or rear door position.

**Step-2** Determine the desired location of the driver side RB Drop Step on the RB10 Running Board, then position (1) U-Bracket toward the front of the vehicle and the Auxiliary Bracket and U-Bracket assembly toward the rear of the vehicle in the opening on the underside of the RB10 Running Board, (FIGURE 2).

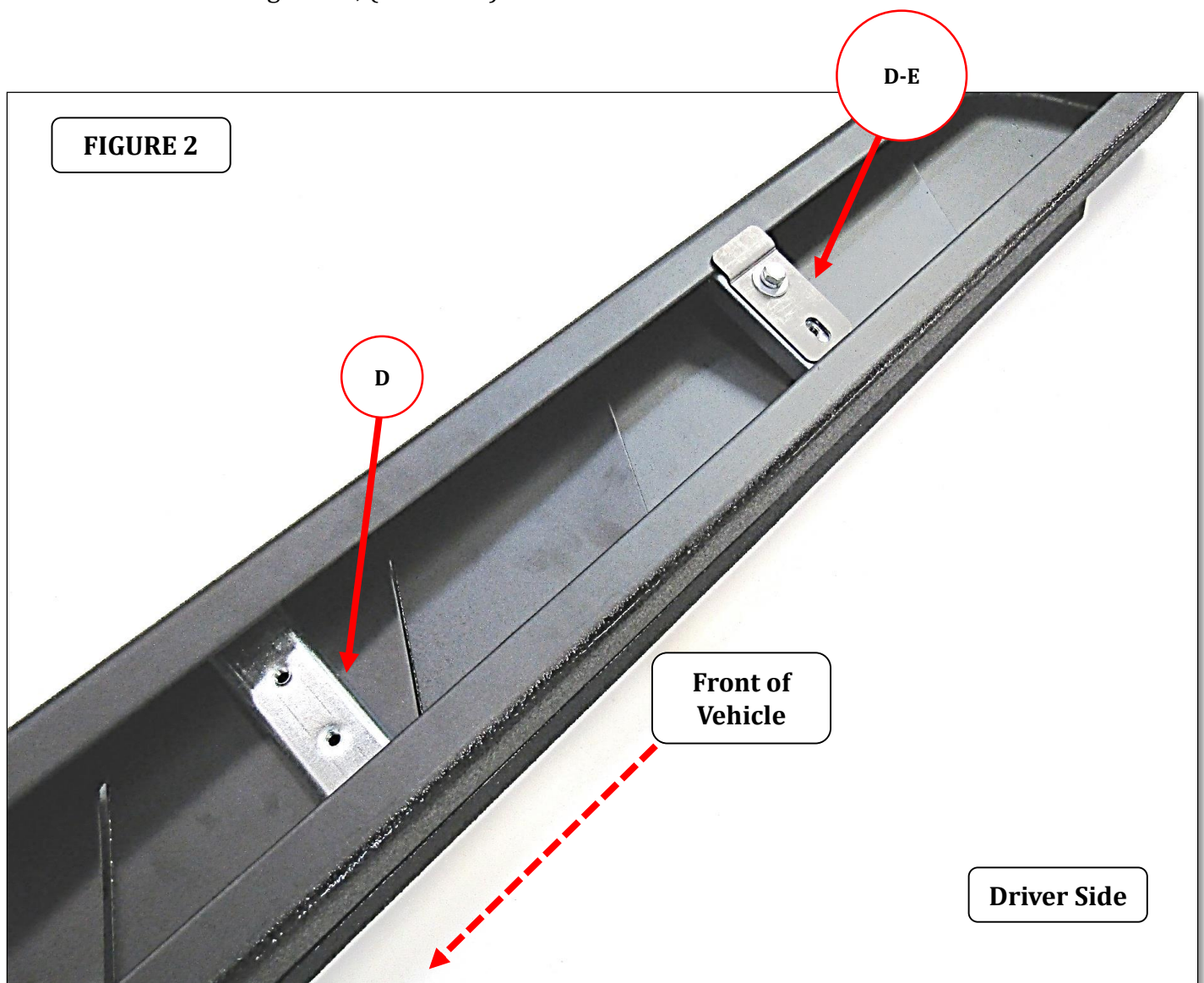



# GORRHINO<sup>®</sup>

## INSTALLATION INSTRUCTIONS

Typical RB Drop Step attachment to RB10 Running Board, driver side front or rear door position.

**Step-3a** Attach the driver side RB Drop Step to the RB10 Running Board using the U-Brackets (3) 5/16" flat washers, (3) 5/16" lock washers and (3) 5/16" x 1" hex head screws, (FIGURE 3). Tighten all screws securing the RB Drop Step, U-Brackets and Auxiliary bracket to the R10 Running Board. Repeat steps for the passenger side.

FIGURE 3

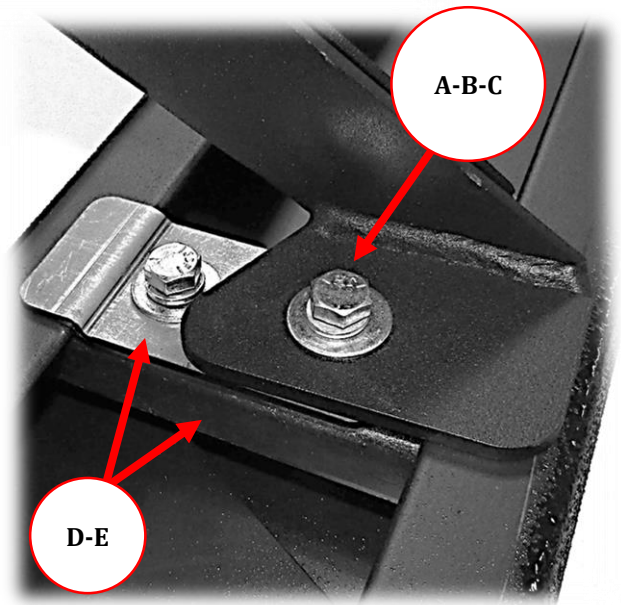
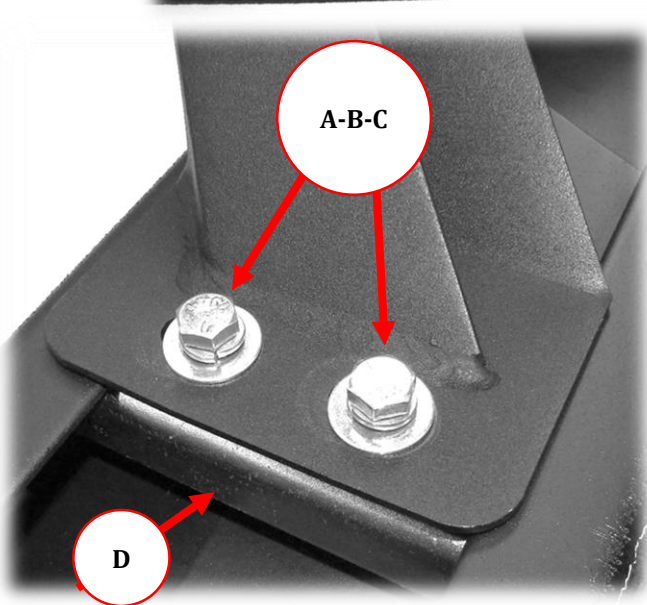

# GO RHINO®

## INSTALLATION INSTRUCTIONS

Typical RB Drop Step attachment to RB10 Running Board, Jeep Wrangler 4 door driver side rear door position.

**Step-3b** Attach the driver side RB Drop Step to the RB10 Running Board using the U-Brackets (3) 5/16" flat washers, (3) 5/16" lock washers and (3) 5/16" x 1" hex head screws, (FIGURE 4). Tighten all screws securing the RB Drop Step, U-Brackets and Auxiliary bracket to the R10 Running Board. Repeat steps for the passenger side.

FIGURE 4

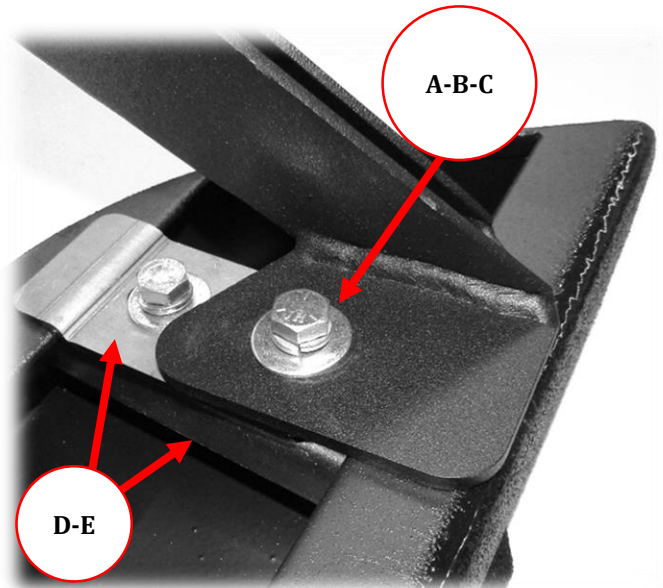
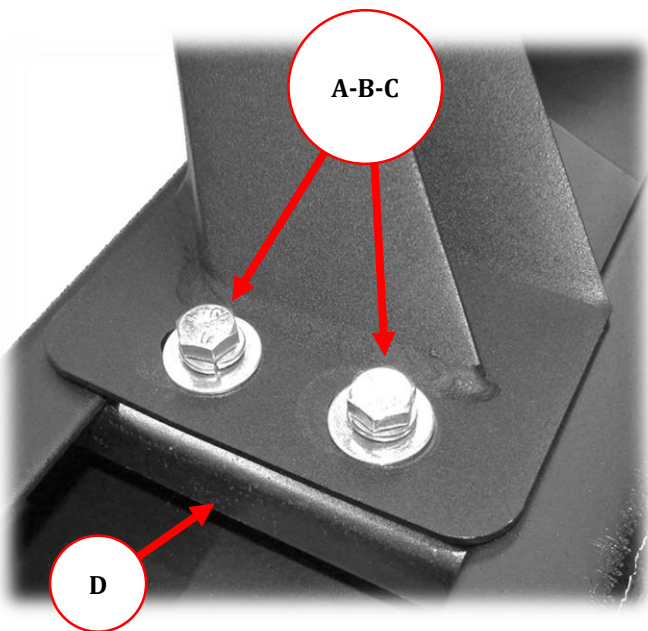

# GORRHINO<sup>®</sup>

## INSTALLATION INSTRUCTIONS

Typical RB Drop Step attachment to RB20 Running Board, driver side front or rear door position.

**Step-1** Attach the Auxiliary Bracket to the U-Bracket using (1) 5/16" x 1" hex head screw, (1) 5/16" lock washer and (1) 5/16" flat washer. Do not tighten the screw, (FIGURE 1).

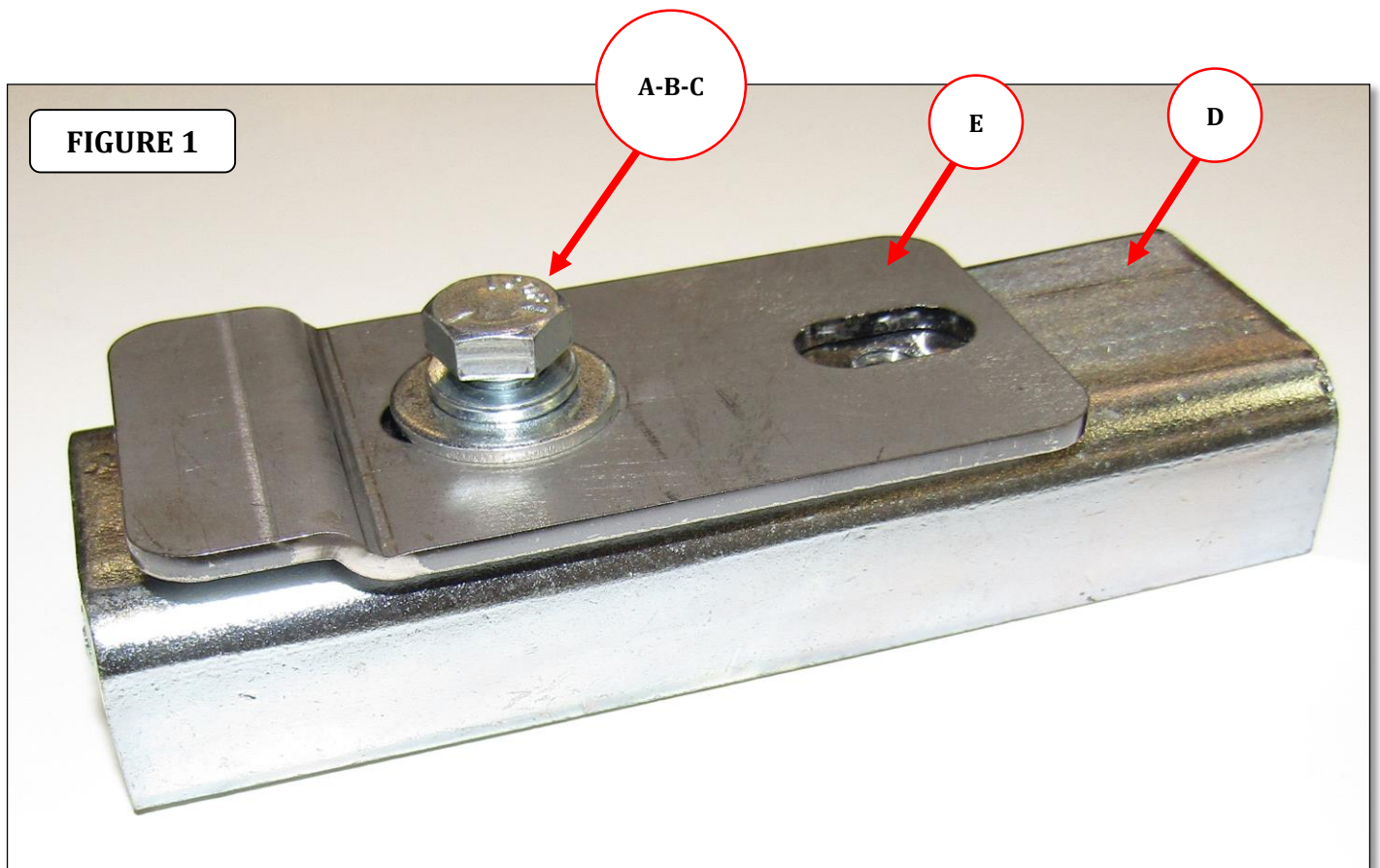



# GORRHINO®

## INSTALLATION INSTRUCTIONS

Typical RB Drop Step attachment to RB20 Running Board, driver side front or rear door position.

**Step-2** Determine the desired location of the driver side RB Drop Step on the RB20 Running Board, then position (1) U-Bracket toward the front of the vehicle and the Auxiliary Bracket and U-Bracket assembly toward the rear of the vehicle in the opening on the underside of the RB20 Running Board, (FIGURE 2).

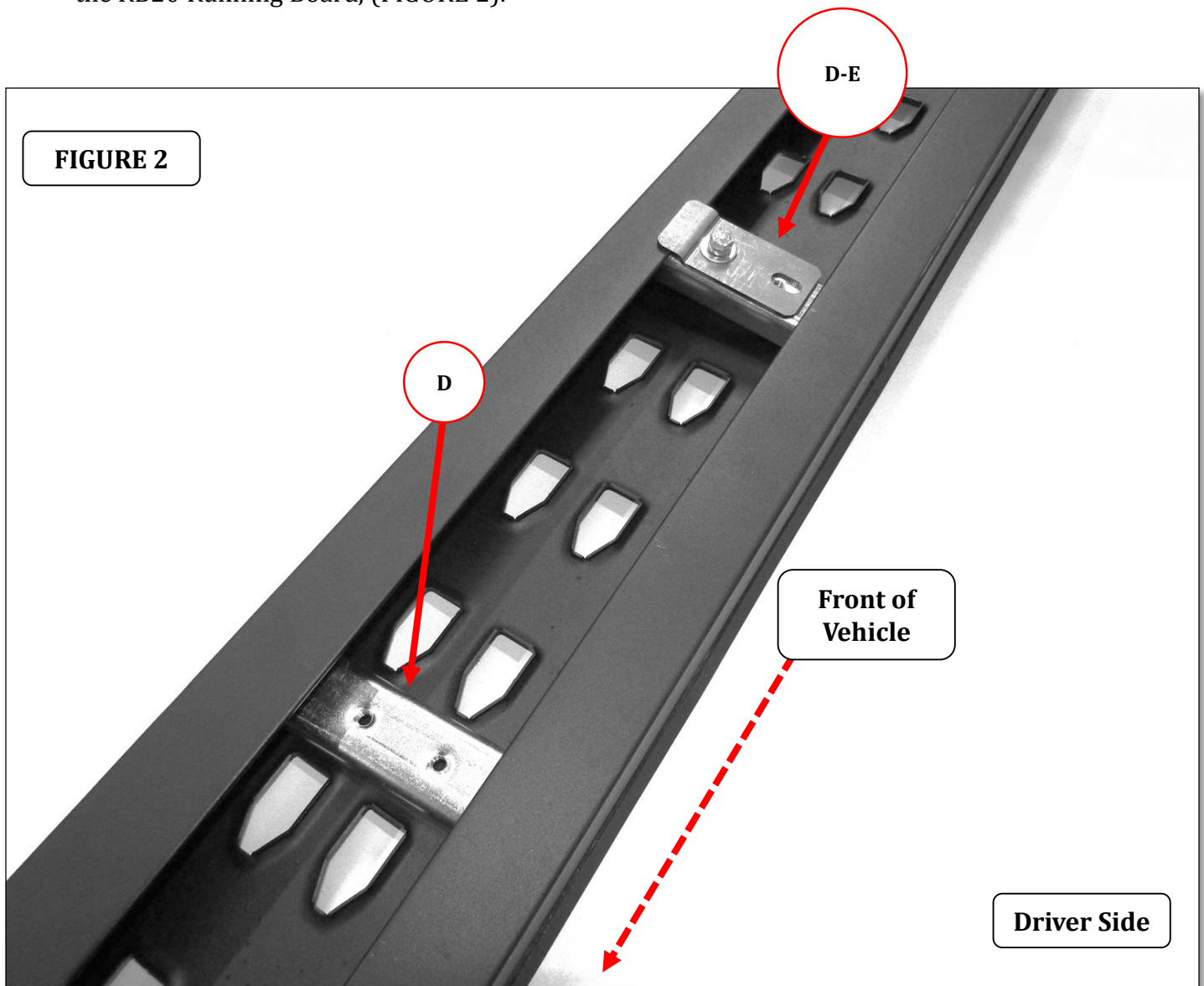

# GORRHINO<sup>®</sup>

## INSTALLATION INSTRUCTIONS

Typical RB Drop Step attachment to RB20 Running Board, driver side front or rear door position.

**Step-3a** Attach the driver side RB Drop Step to the RB20 Running Board using the U-Brackets (3) 5/16" flat washers, (3) 5/16" lock washers and (3) 5/16" x 1" hex head screws, (FIGURE 3). Tighten all screws securing the RB Drop Step, U-Brackets and Auxiliary bracket to the R20 Running Board. Repeat steps for the passenger side.

FIGURE 3

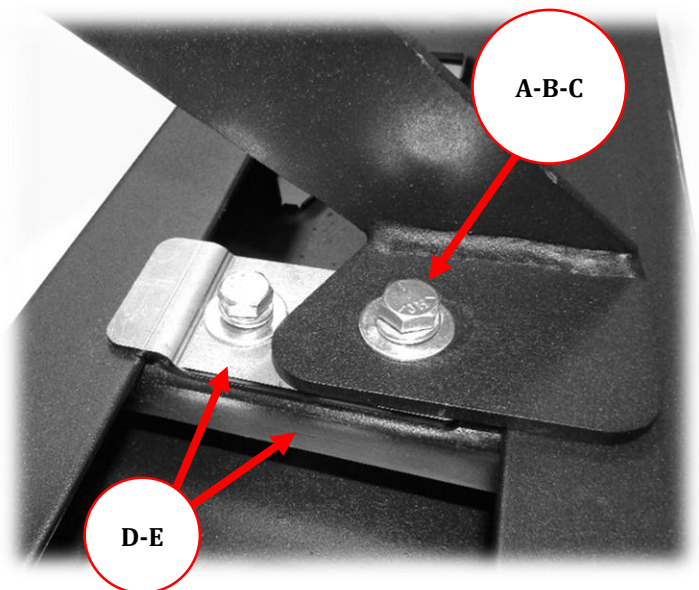
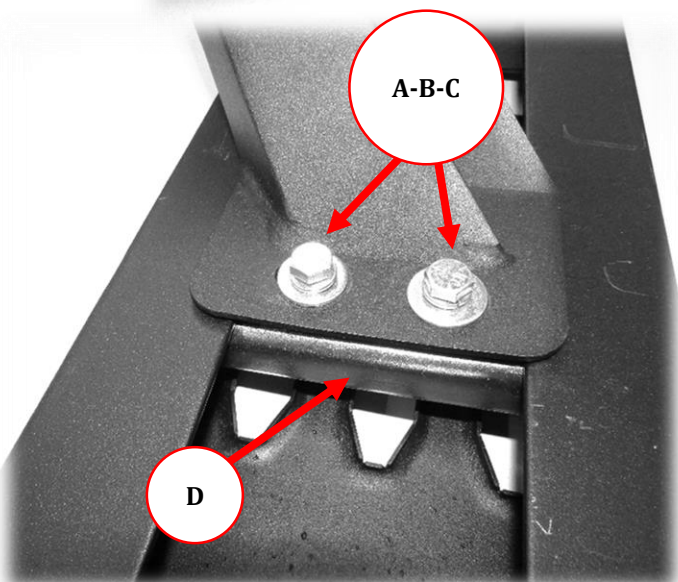

# GORRHINO®

## INSTALLATION INSTRUCTIONS

Typical RB Drop Step attachment to RB20 Running Board, Jeep Wrangler 4 door driver side rear door position.

**Step-3b** Attach the driver side RB Drop Step to the RB20 Running Board using the U-Brackets (3) 5/16" flat washers, (3) 5/16" lock washers and (3) 5/16" x 1" hex head screws, (FIGURE 4). Tighten all screws securing the RB Drop Step and U-Brackets to the R20 Running Board. Repeat steps for the passenger side.

FIGURE 4

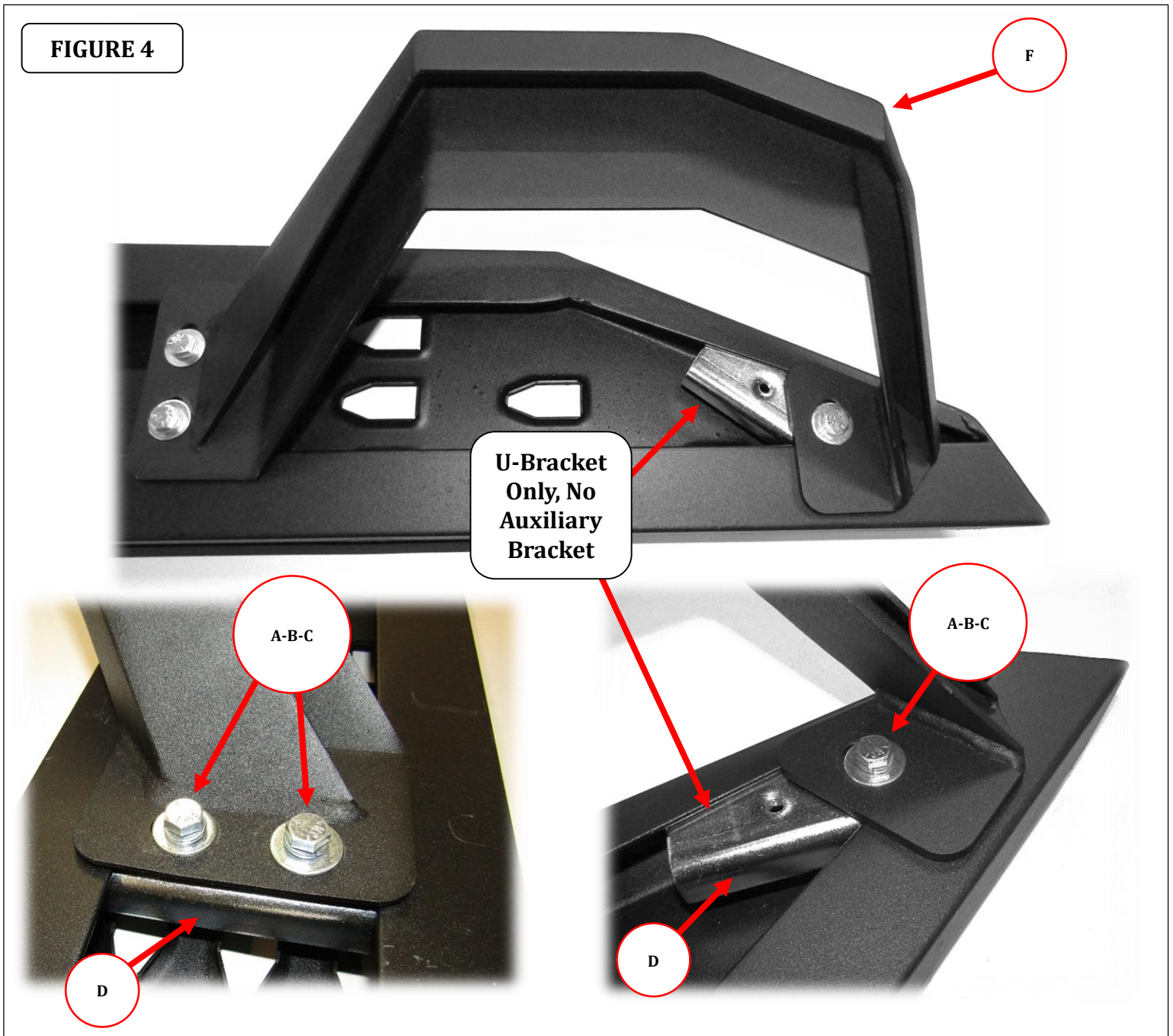

# INSTALLATION INSTRUCTIONS

RB10/RB20  
RUNNING BOARDS

## TOYOTA TUNDRA CREW MAX

**63441687**

**69441687**

Parts list				
Item	QTY	Códe	Description	Max Torque
1	1 set	630087/690087	Running Boards	
2	1 set	6344154AA	Front Bracket	
3	2 sets	6344154BA	Rear and rear center bracket	
4	1 set	6344154CA	Front center bracket	
5	8 piece	6300874AA/4BA	U-bracket	
6	32 piece		M8 x 30mm SEMS Bolts	18 Lb. Ft.

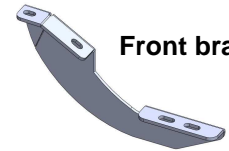

**Front bracket**

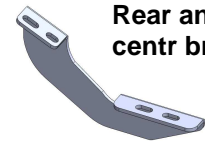

**Rear and rear  
centr bracket**

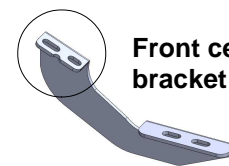

**Front center  
bracket**

### Required Tools (Not included)

- A. Ratchet w/ extension
- B. 12 mm socket
- C. 13 mm socket
- D. 15 mm socket

**1.-** Before beginning the installation, please read all directions carefully and verify that all necessary hardware is accounted for. If any parts are missing, stop the installation and contact your distributor immediately.

**2.-** To maintain and care this product keep it clean and do not use abrasive cleaners or polish waxes. We recommend to use only non-abrasive automotive wax such as pure carnauba to avoid scratches and rust.

**3.-** The approximate installation time is 45 min.



3. To install **middle and rear brackets** use two M8 x 30mm SEMS bolts for each bracket. See **Picture 4** and repeat it in the opposite side. Leave loose.

1. See pictures **1, 2 Y 3** and locate the holes where the brackets are going to be installed.

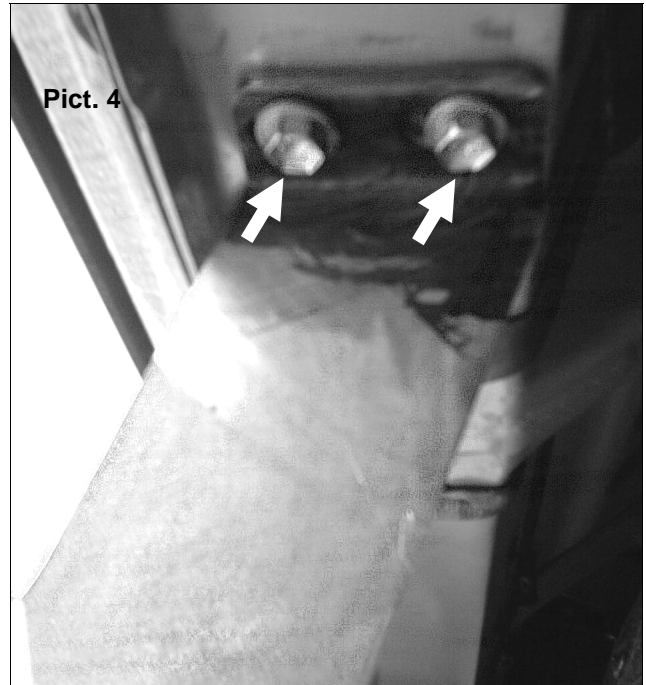
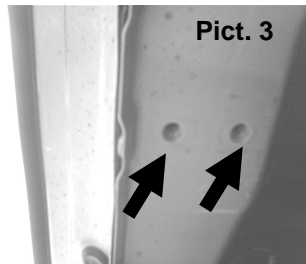
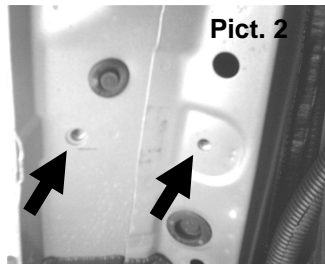
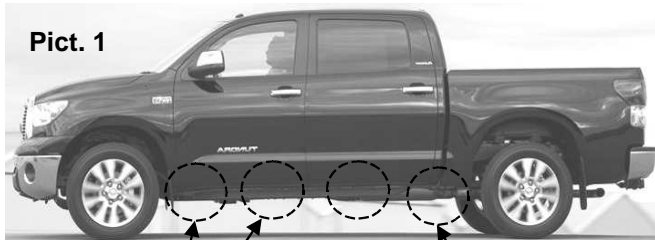

2. For the **Front bracket** install two M8 x 30mm SEMS bolts. See **Picture 5** and repeat it in the opposite side of the vehicle. Leave loose.

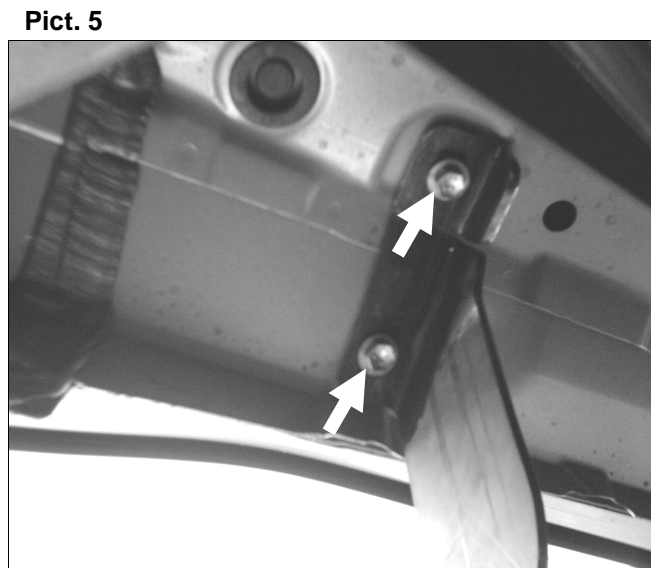

4. Place the running board on top of the mounting brackets. Position the (4) U-brackets inside the running board body, and align the U-brackets with the mounting brackets. Attach the running board and U-brackets to each mounting brackets using (2) M8 x 30mm SEMS bolts. ILLUSTRATION 1.

**ILLUSTRATION 1**

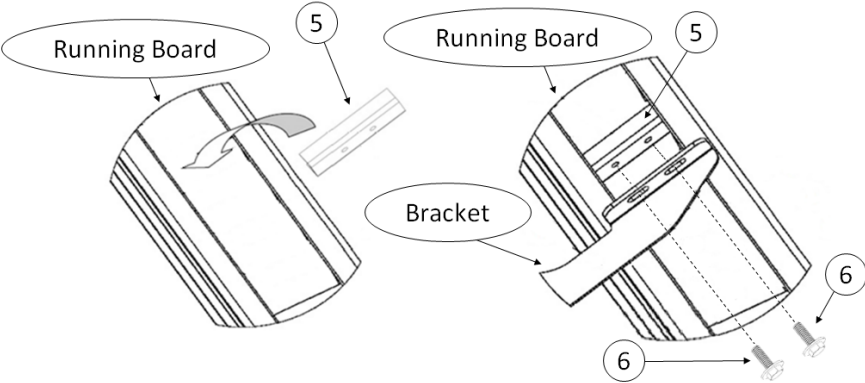

**Pict. 6**

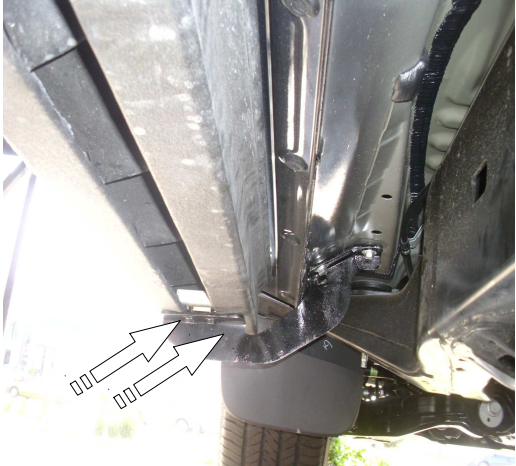

- 5. Align the running board and then tighten all bolts.
- 6. Periodically check your product because it may need a re-tighten of bolts.
- 7. Fill the warranty card and place it inside your vehicle's glove box.

