



## Installation Instructions

### BR11 Front Bumper Replacement Part # 24280T

2015 - 2018 Chevrolet Silverado 2500HD & 3500HD 2/4WD

(Excludes models with Driver Alert Package)

Do not attempt to install this product on any vehicle other than the one listed above!

#### Parts List

Item	Qty.	Part #	Description
1	1	24280T	Bumper Replacement Shell
2	1		Passenger Side Frame Bracket
3	1		Driver Side Frame Bracket
4	2		Spacer Plate
5	1		Driver Side Vent Cover
6	1		Passenger Side Vent Cover
7	1		Winch Cover
8	2		Light Pod Plate
9	1		License Plate Bracket
<b>Required for Installation (Sold Separately)</b>			
10	1	24173TW	Mounting Plate/Winch Tray

Item	Qty.	Part #	Description	Torque
11	12		1/2" x 1 1/2" Hex Bolt	65 Ft. Lbs
12	6		1/2" x 1 1/2" Carriage Bolt	65 Ft. Lbs
13	20		1/2" Flat Washer	
14	18		1/2" Lock Washer	
15	12		1/2" Hex Nut	
16	38		1/4" x 3/4" Button Head Bolt	71 In. Lbs
17	10		1/4" Nylon Lock Nut	
18	6		3/8" x 1 1/4" Hex Bolt	30 Ft. Lbs
19	6		3/8" Lock Washer	
20	6		3/8" Flat Washer	
21	6		3/8" Hex Nut	
22	4		Hole plug	

ILLUSTRATION #1

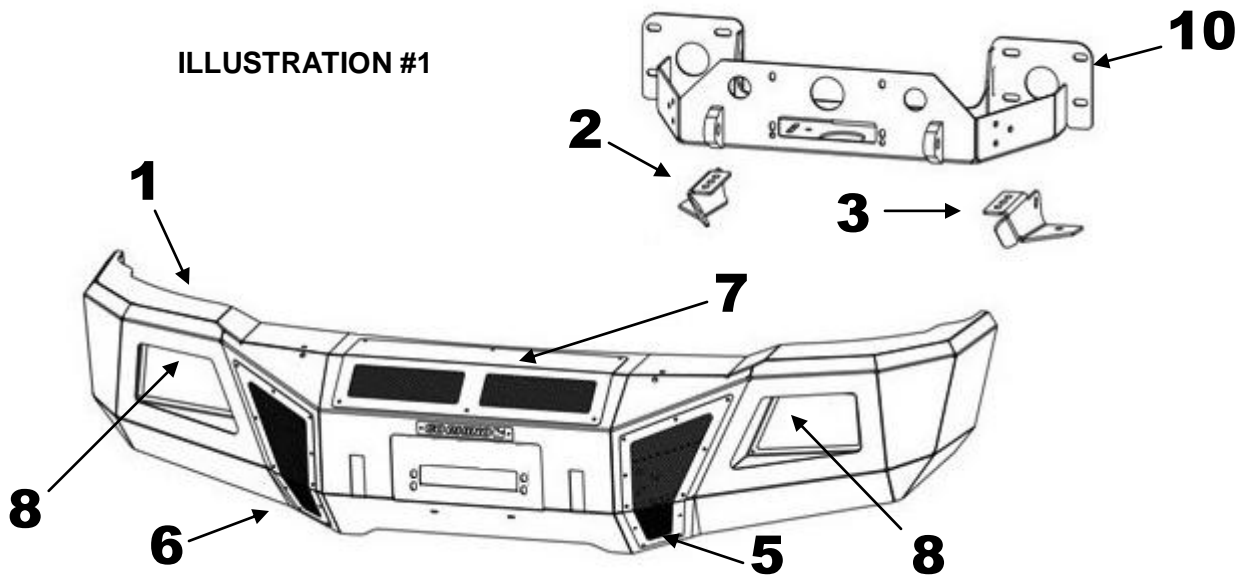

#### Tool Required:

7mm, 10mm, 15mm, 18mm, 21mm, 7/16", 9/16" & 3/4" Sockets

18mm, 7/16", 9/16" & 3/4" Wrenches

Slotted Blade Screw Driver

5/32" Hex Key

Ratchet, Ratchet Extensions & Swivel Joint Adapter

Approximate installation time: 90 min

Read the assembly and installation instructions completely and verify that all of the parts listed are accounted for.

## Front Bumper Removal

**Step-1** Open the hood and locate the (12) plastic push pins (6) per side securing the radiator cover. Using a flat blade screw driver, pull the head of the push pins up, remove push pins and lift radiator cover off. This will allow access to the bolts securing the top of the grille, (Photo 1).

**Step-2** Remove the (4) screws (2) per side securing the top of the grille, (Photo 2).

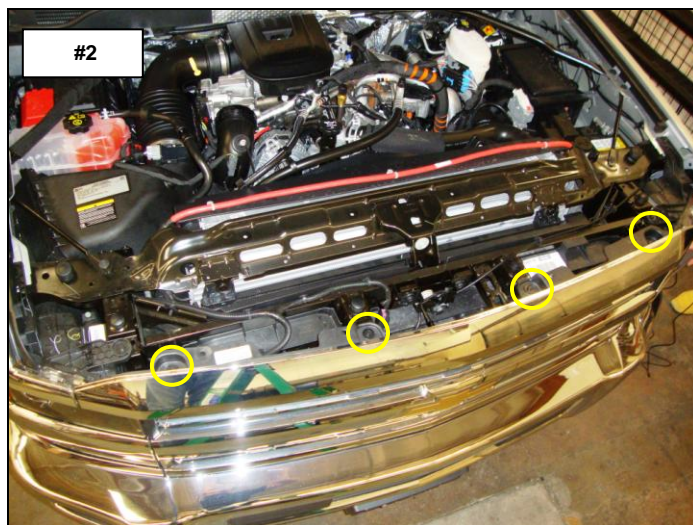
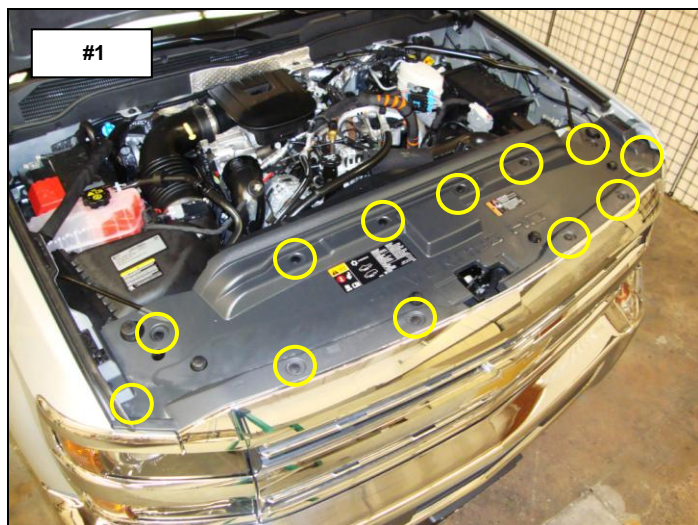

**Step-3** Working from side to side gently pull outward to unsnap the clips and remove the grille, (Photo 3).

**Step-4** Disconnect the bumper electrical harness from vehicle, (Photo 4).

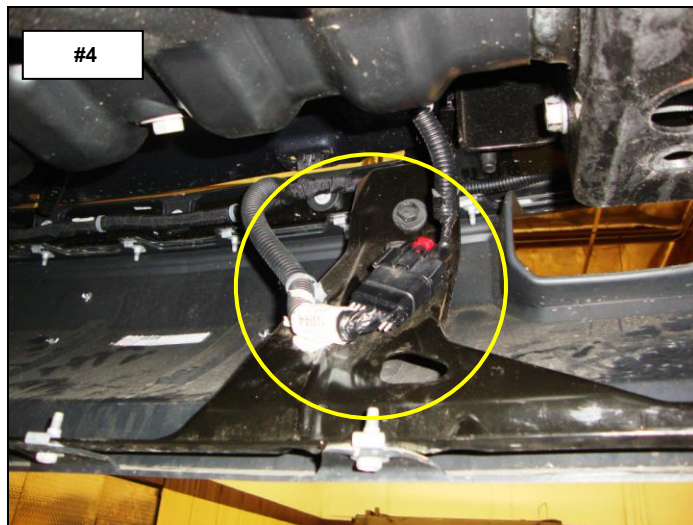
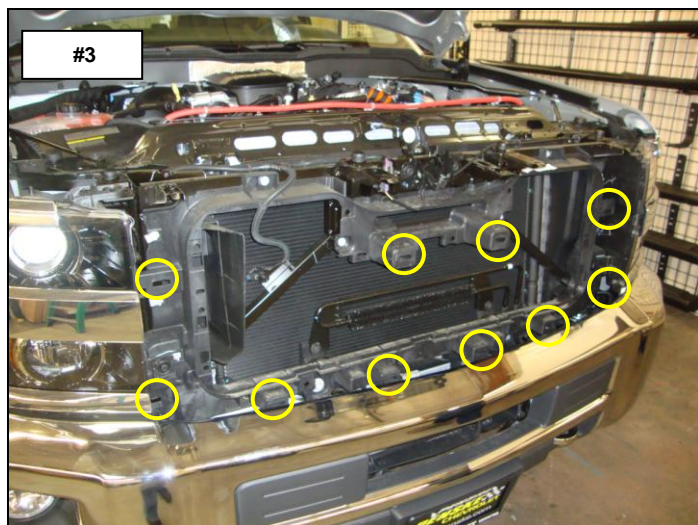



**Step-4** On each side of the vehicle, remove the bolt securing the outer bumper support bar to the bumper and loosen the (2) bolts securing the opposite end of the support bar to the frame body mount bracket, (Photo 5).

**Step-5** With assistance support the bumper, and remove the bolts (4) per side securing the bumper and bracket assembly to the frame. Remove the bumper from the vehicle, (Photo 6). Retain the factory bolts to attach the winch tray to the vehicle.

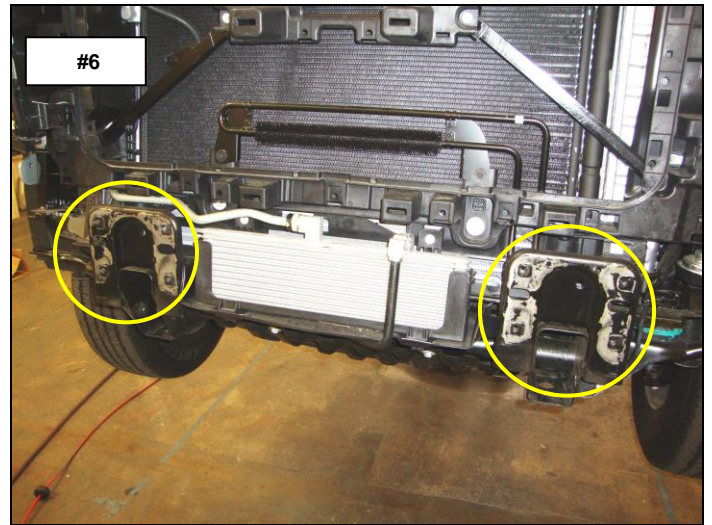
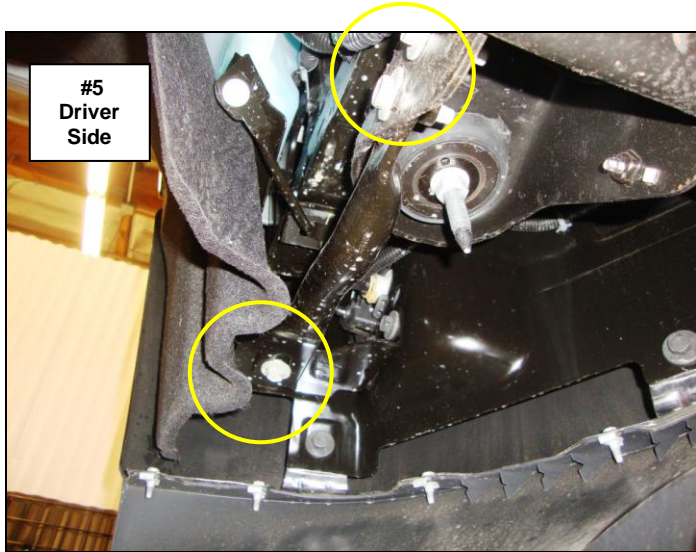

### BR10 Bumper Replacement Installation

**Step-1** Remove the nuts bolts and tow hook from the frame, (Photo 7). Note: The tow hook will not be reinstalled.

**Step-2** Install the driver's side frame bracket by positioning the bracket on the side and bottom of the frame, align the holes and secure the bracket to the frame using (2) ½" x 1 ½" hex bolts, (2) ½" flat washers, (2) ½" lock washers and (2) ½" hex nuts, (Photo 8). Leave the nuts and bolts loose for final adjustment. Repeat this step to install the passenger side frame bracket.

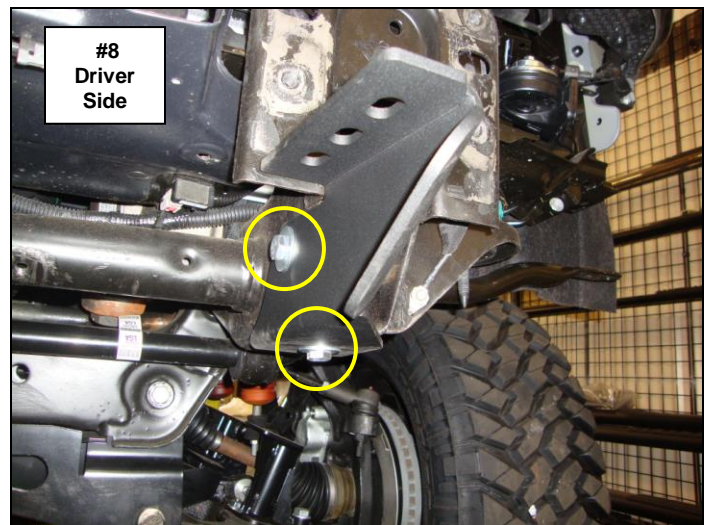
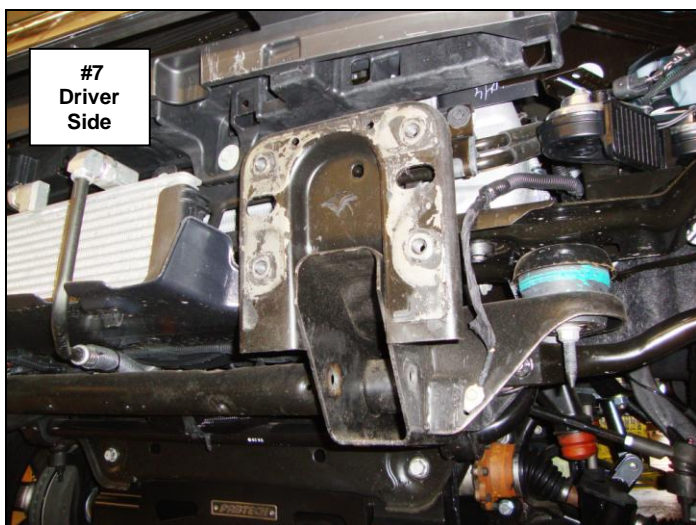



**Step-3** Rest the winch tray on top of the frame brackets. Position one of the spacer plates between the winch tray mounting flange and frame, align the spacer plate with the (2) upper holes in the frame and winch tray mounting flange and reinstall the (4) factory bolts. Position the remaining spacer plate between the winch tray flange and frame on the passenger side and reinstall the factory bolts. Secure the winch tray to each frame bracket using (3) ½" x 1 ½" carriage bolts, (3) ½" flat washers, (3) ½" lock washers and (3) ½" hex nuts, (Photo 9 & 10). Leave the nuts and bolts loose for final adjustment.

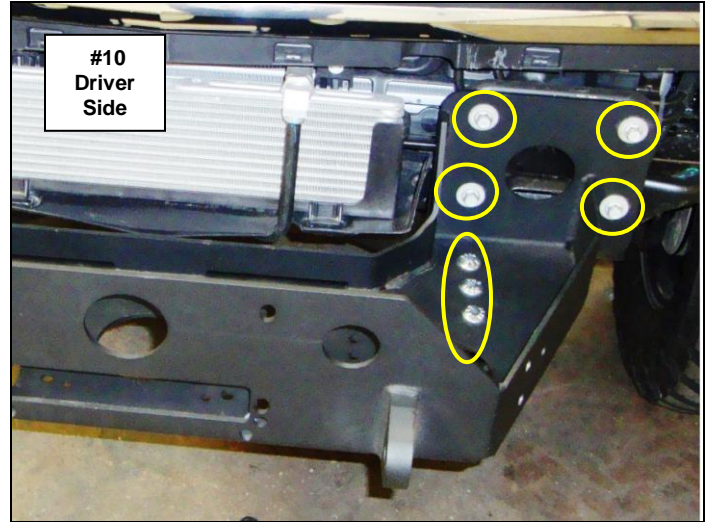
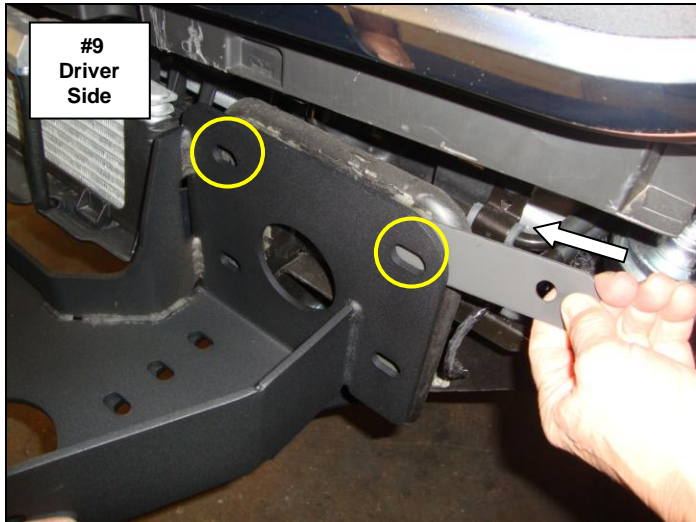

**Step-4** Use a reference point on the vehicle, measure and adjust the winch tray so the side to side alignment on the vehicle is equal, then finger tighten all factory and supplied nuts and bolts securing the winch tray and frame brackets, (Photo 11 & 12).



If you are installing a winch, place the winch in the winch tray and refer to the winch manufacturer's instructions for installation. Do not install the fairlead at this time.

**Step-5** With assistance lift the bumper shell up to the vehicle, align the holes in the bumper brackets with the weld nuts on the winch tray and secure the bumper shell brackets to each side of the winch tray using (3) ½" x 1 ½" hex bolts, (3) ½" lock washers and (3) ½" flat washers, (Photo 13 & 14). Leave the bolts loose for final adjustment.

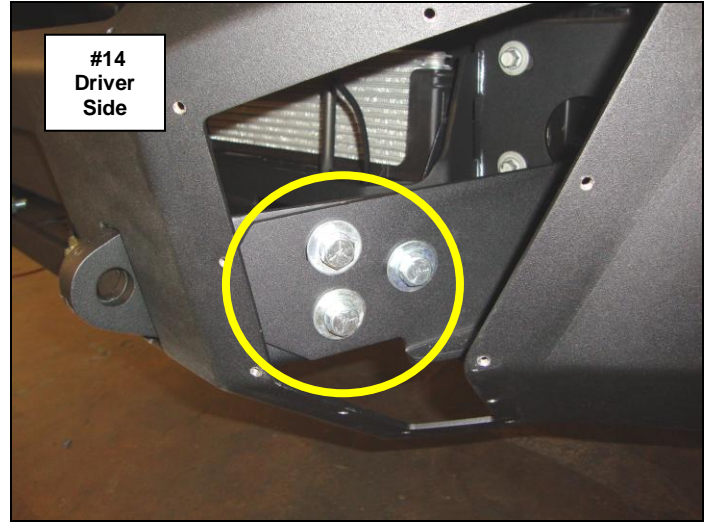

**Step-6** Align the holes and attach each factory bumper support bar to each of the bumper shell support brackets using (1) ½" x 1 ½" hex bolt, (2) ½" flat washers, (1) ½" lock washer and (1) ½" hex nut, (Photo 15).

**Step-7** Align the bumper shell with the vehicle and tighten all factory and supplied nuts and bolts, (Photo 16).

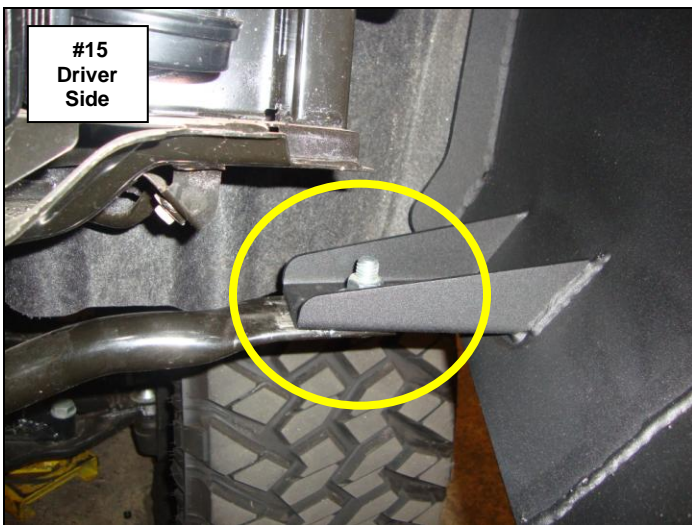

If installing a winch, install the roller fairlead to the bumper shell at this time. Refer to the winch manufacturer's instructions for installation. If installing an optional light bar, install the light bar to the bumper replacement at this time. Refer to the light bar instructions for installation.



**Step-8** Locate the holes in the face and top of the bumper shell and install the light bar to each side of the bumper shell using (2) 3/8" x 1 1/4" hex bolts, (2) 3/8" flat washers, (2) 3/8" lock washers and (2) 3/8" hex nuts, (Photo 17 & 18). Tighten the nuts and bolts.

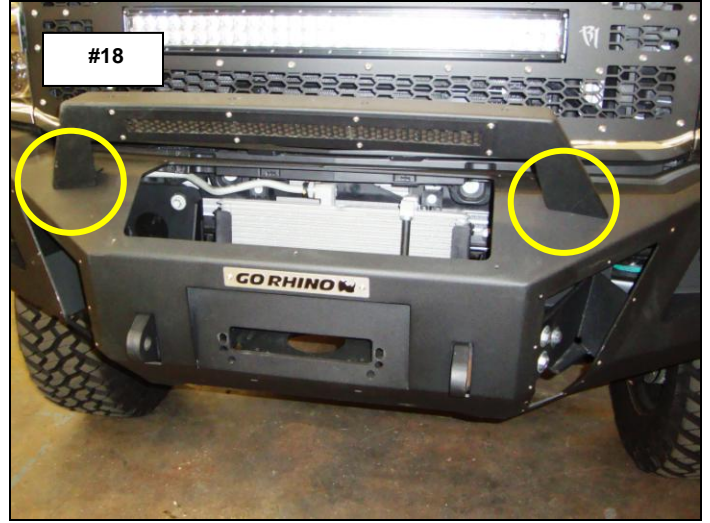

**Step-9** Install the winch cover and driver and passenger side front vent covers to the bumper shell using the supplied 1/4" x 3/4" button head bolts, (Photo 19 & 20). **Note:** Do not over tighten bolts, reference tightening torque (71 In-Lbs).

**Step-10** Install the flush mount light pods to the bumper shell using (4) 1/4" x 3/4" button head bolts and (4) 1/4" nylon lock nuts, (Photo 20). **Note:** Do not over tighten bolts, reference tightening torque (71 In-Lbs).

**Step-11** If desired, trim the bottom of the driver and passenger side fender liner to match the replacement bumper. Remember to check and retighten the factory and supplied nuts and bolts periodically.



If your state law requires a front license plate, attach the license plate bracket to the holes in the face of the bumper shell, using the supplied 3/8" bolts, washers and nuts, and the license plate to the (2) obround holes in the license plate bracket using the supplied 1/4" bolts and nuts.

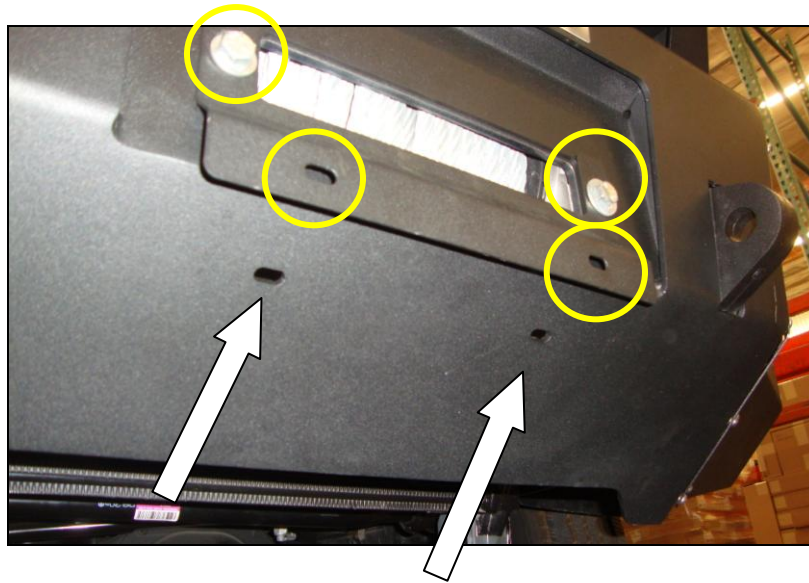

If installing a winch, attach the license plate directly to the (2) obround holes in the lower face of the bumper shell using the supplied 1/4" bolts and nuts. Remember to check and retighten all factory and supplied nuts and bolts periodically.