



## Installation Instructions

### BR11 Front Bumper Replacement Part # 24177T

2011-2014 Chevrolet Silverado 2500HD & 3500HD 2/4 WHD

Do not attempt to install this product on any vehicle other than the one listed above!

#### Parts List

Item	Qty.	Part #	Description	Item	Qty.	Part #	Description	Torque
1	1		Bumper Replacement Shell	14	20		1/2" x 1 1/2" Hex Bolt	64 Ft. Lbs
2	1		Driver Frame Bracket	15	6		1/2" x 1 1/2" Carriage Bolt	64 Ft. Lbs
3	1		Passenger Frame Bracket	16	36		1/2" Flat Washer	
4	1		Driver Auxiliary Bracket	17	26		1/2" Lock Washer	
5	1		Passenger Auxiliary Bracket	18	20		1/2" Hex Nut	
6	1		Driver Support Bracket	19	6		3/8" x 1 1/4" Hex Bolt	26 Ft. Lbs
7	1		Passenger Support Bracket	20	6		3/8" Lock Washer	
8	1		Driver Vent Cover	21	10		3/8" Flat Washer	
9	1		Passenger Vent Cover	22	6		3/8" Hex Nut	
10	1		Winch Cover	23	38		1/4" x 3/4" Button Head Bolt	71 In. Lbs
11	2		Light Pod Plate	24	10		1/4" Nylon Lock Nut	
12	1		License Plate Bracket	25	4		Hole Plug	
<b>Required for Installation (Sold Separately)</b>								
13	1	24273TW	Mounting Plate/Winch Tray					

ILLUSTRATION #1

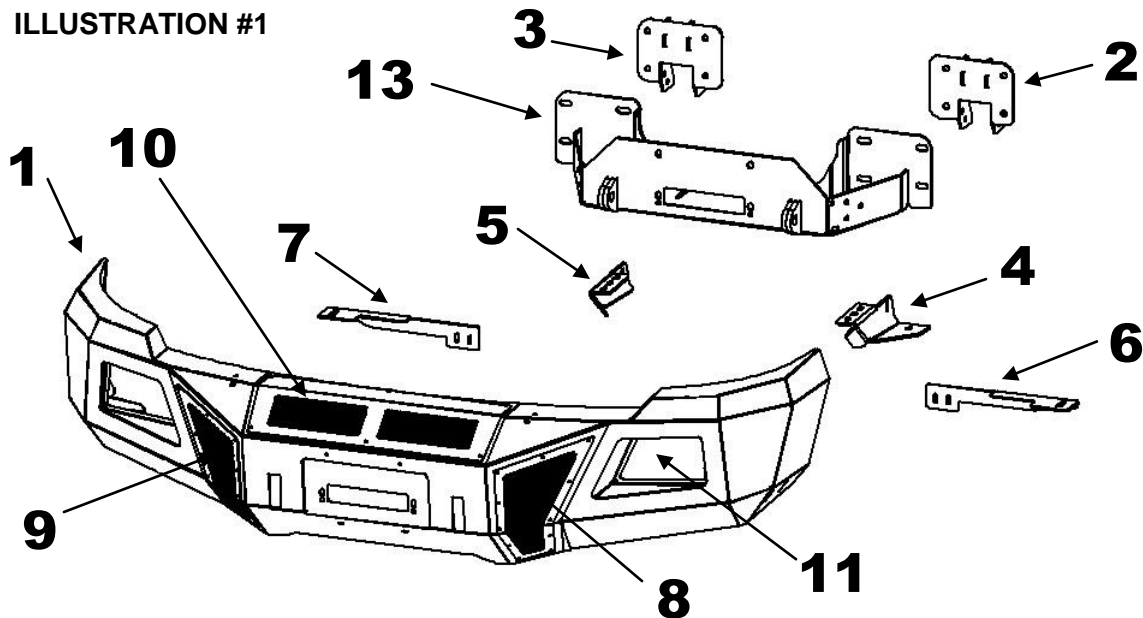

#### Tool Required:

10mm, 15mm, 18mm, 21mm, 7/16", 9/16" & 3/4" Sockets  
 18mm, 7/16", 9/16" & 3/4" Wrenches  
 Slotted Blade Screw Driver  
 5/32" Hex Key  
 Ratchet, Ratchet Extensions & Swivel Joint Adapter

Approximate installation time: 2 hrs.

Read the assembly and installation instructions completely and verify that all of the parts listed are accounted for. If you have defective, missing or damaged parts or need assistance, please contact Go Rhino Products for fast, friendly customer service at: Phone Number / 714-257-7392 / Fax Number / 714-672-0278 / email: [warranty@gorhino.com](mailto:warranty@gorhino.com)

## Front Bumper Removal

**Step-1** Detach the rubber splash shield by removing the (6) plastic push in connectors securing the shield to the center of the bumper, (Photo 1).

**Step-2** Remove the screws (2) per side securing the plastic inner fender to the bumper using a 10mm socket and ratchet, (Photo 2).



**Step-3** If equipped, disconnect the wiring harness from each of the fog lights, (Photo 3).

**Step-4** Remove the bolts (3) per side securing the outer bumper support bar to the body mount bracket and to the bumper using a 15mm socket and ratchet, (Photo 4).

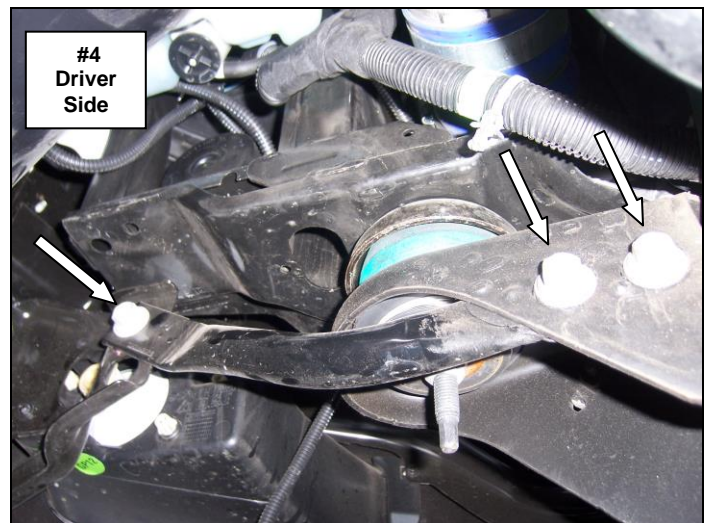
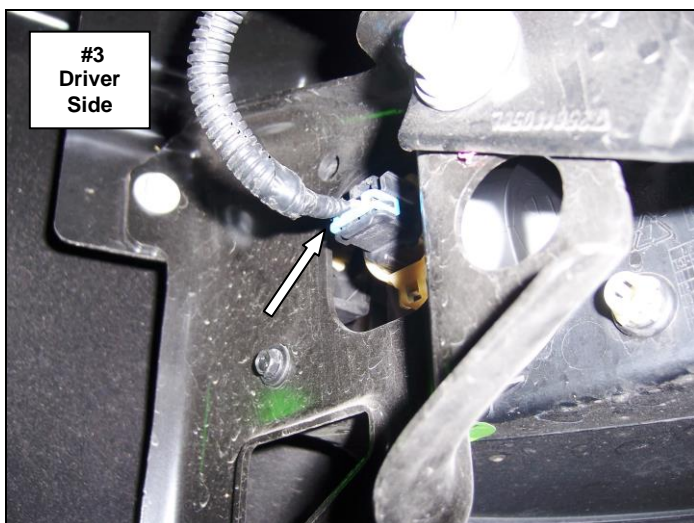

**Step-5** Remove the nut and bolts' securing each of the tow hooks to the frame using an 18mm wrench, socket, and ratchet, (Photo 5). Pull the hooks out from the front and remove from the vehicle.

**Step-6** Remove the nuts (2) per side from the paired bolts securing the bumper brackets to the frame using a 21mm socket and ratchet, (Photo 5). **Caution:** Do not remove the paired bolts.

**Step-7** With assistance support the bumper, remove the paired bolts; pull the bumper down, and forward away from the vehicle. Retain the nuts and paired bolts to attach the replacement bumper brackets.

**Step-8** Remove the (4) remaining plastic push in connectors and the rubber splash shield from the vehicle, (Photo 6). Discard the splash shield.

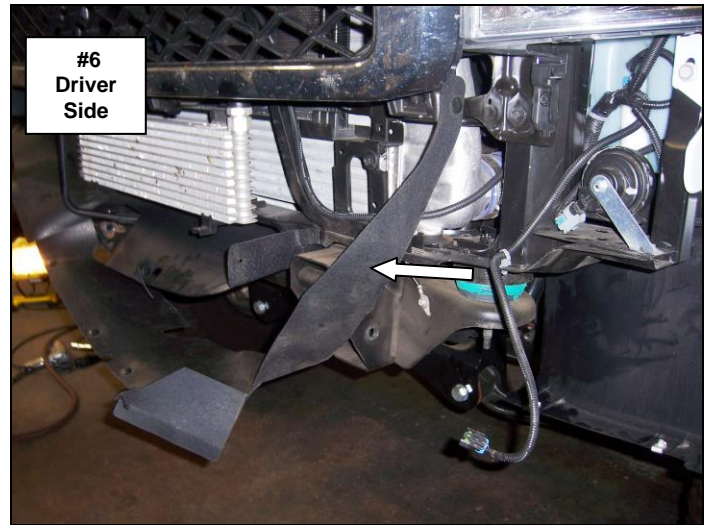
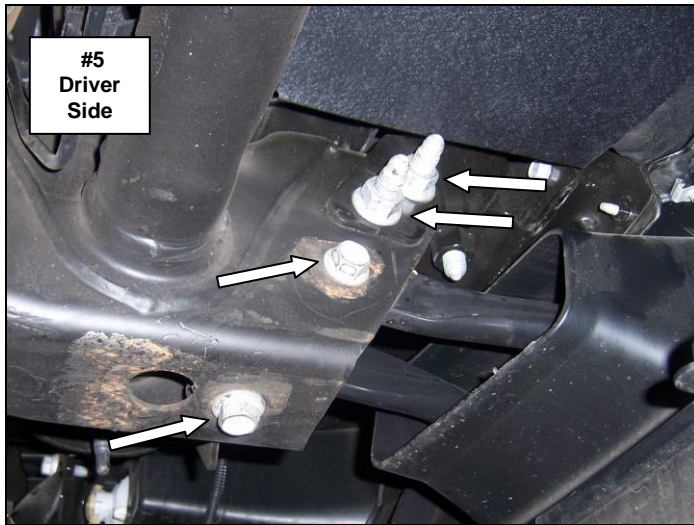

### Bumper Replacement Installation

**Step-1** Install the driver's side frame bracket by positioning the bracket over the frame, align the holes and secure the bracket to the frame using the factory paired bolts and nuts, (Photo 1). Leave the nuts and bolts loose for final adjustment. Repeat this step to install the passenger side frame bracket.

**Step-2** Install the driver's side auxiliary bracket by positioning the bracket on the side and bottom of the frame, align the holes and secure the bracket to the frame using (2) 1/2" x 1 1/2" hex bolts, (2) 1/2" flat washers, (2) 1/2" lock washers and (2) 1/2" hex nuts, (Photo 2). Leave the nuts and bolts loose for final adjustment. Repeat this step to install the passenger side auxiliary bracket.

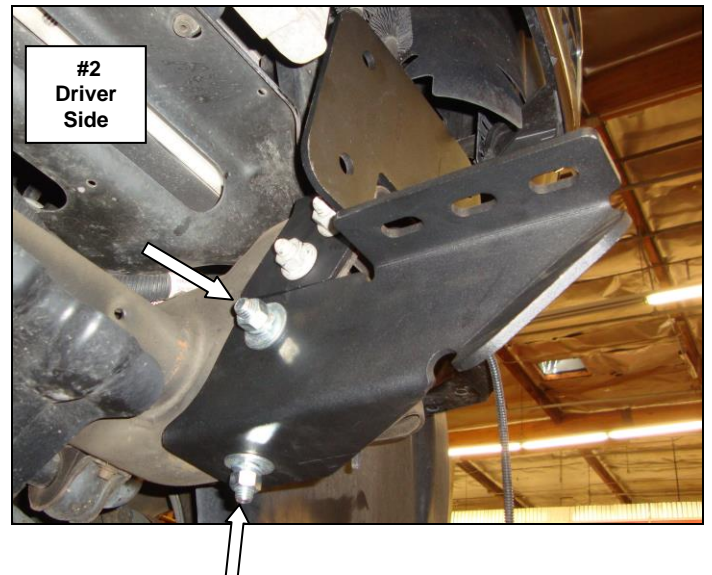
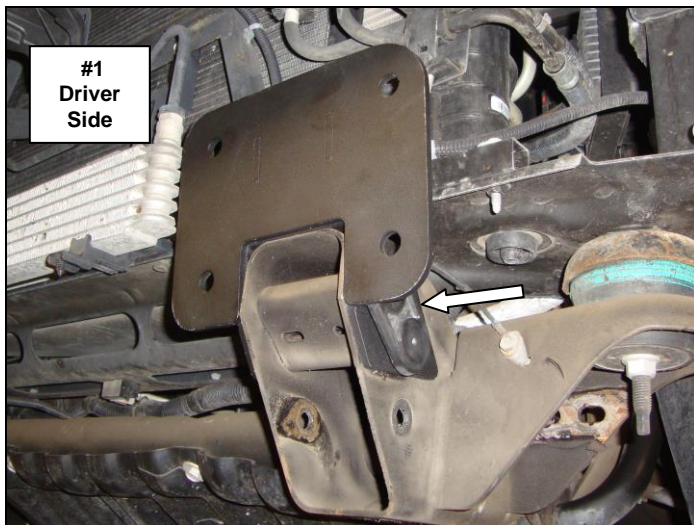

**Step-3** Position the winch tray on top of the auxiliary brackets. Secure the winch tray to each frame bracket using (4) 1/2" x 1 1/2" hex bolts, (8) 1/2" flat washers, (4) 1/2" lock washers and (4) 1/2" hex nuts, and to the auxiliary bracket using (3) 1/2" x 1 1/2" carriage bolts, (3) 1/2" flat washers, (3) 1/2" lock washers and (3) 1/2" hex nuts, (Photo 3 & 4). Leave the nuts and bolts loose for final adjustment.



**Step-4** Center the mounting plate/winch tray with the vehicle then tighten the nuts and bolts securing the auxiliary brackets to the frame. Finger tighten all factory and supplied nuts and bolts securing the mounting plate/winch tray and frame brackets.

If you are installing a winch, place the winch in the winch tray and refer to the winch manufacturer's instructions for installation. Do not install the fairlead at this time.

**Step-5** With assistance lift the bumper shell up to the vehicle, align the holes in the bumper shell brackets with the weld nuts on the winch tray and secure the bumper shell brackets to each side of the winch tray using (3) 1/2" x 1 1/2" hex bolts, (3) 1/2" lock washers and (3) 1/2" flat washers, (Photo 6). Leave the bolts loose for final adjustment.

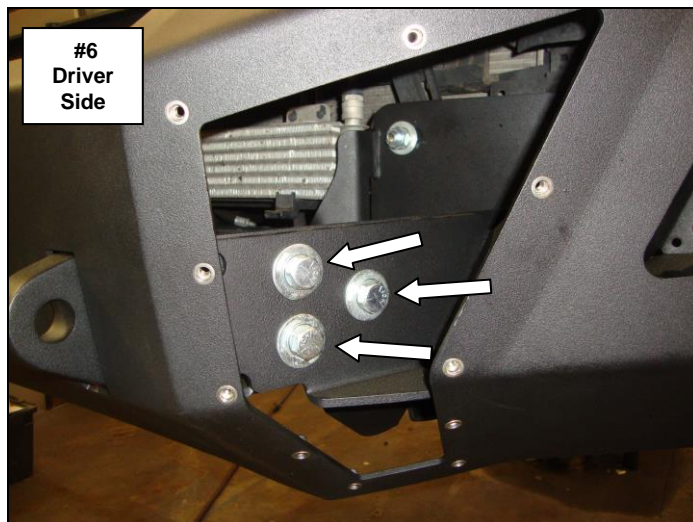

**Step-6** Align the holes and attach each bumper support bracket to the vehicle frame using (2) 3/8" x 1 1/4" hex bolts, (2) 3/8" flat washers, (2) 3/8" lock washers and (2) 3/8" hex nuts, and to the replacement bumper bracket using (1) 1/2" x 1 1/2" hex bolt, (2) 1/2" flat washers, (1) 1/2" lock washer and (1) 1/2" hex nut, (Photo 7).

**Step-7** With assistance align the replacement bumper with the vehicle and tighten all factory and supplied nuts and bolts, (Photo 8).

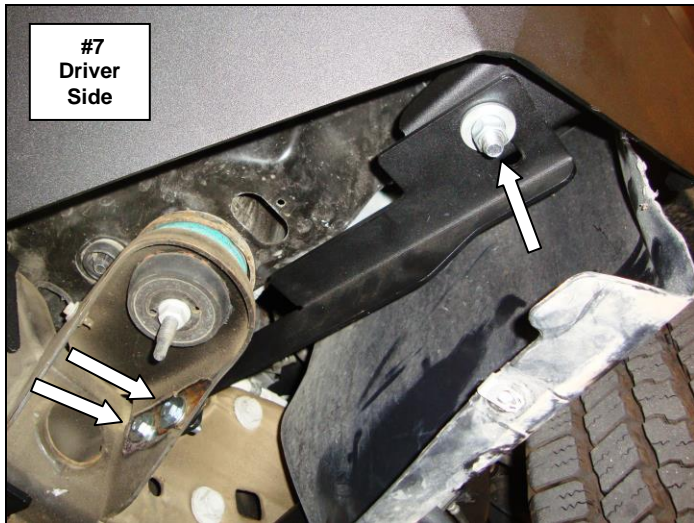

If installing a winch, install the roller fairlead to the bumper shell at this time. Refer to the winch manufacturer's instructions for installation. If installing an optional light bar, install the light bar to the bumper replacement at this time. Refer to the light bar instructions for installation.

**Step-9** Install the driver and passenger side front vent covers to the bumper using the supplied 1/4" x 3/4" button head bolts, Install the flush mount light pods to the bumper using (4) 1/4" x 3/4" button head bolts and (4) 1/4" nylon lock nuts, (Photo 9).

**Step-10** Trim the bottom of the driver and passenger side fender liner to match the replacement bumper. Remember to check and retighten the factory and supplied nuts and bolts periodically.



**Step-11** If your state law requires a front license plate, attach the license plate bracket to the holes in the face of the bumper shell, using the supplied 3/8" bolts, washers and nuts, and the license plate to the (2) obround holes in the license plate bracket using the supplied 1/4" bolts and nuts.

If installing a winch, attach the license plate directly to the (2) obround holes in the lower face of the bumper shell using the supplied 1/4" bolts and nuts.

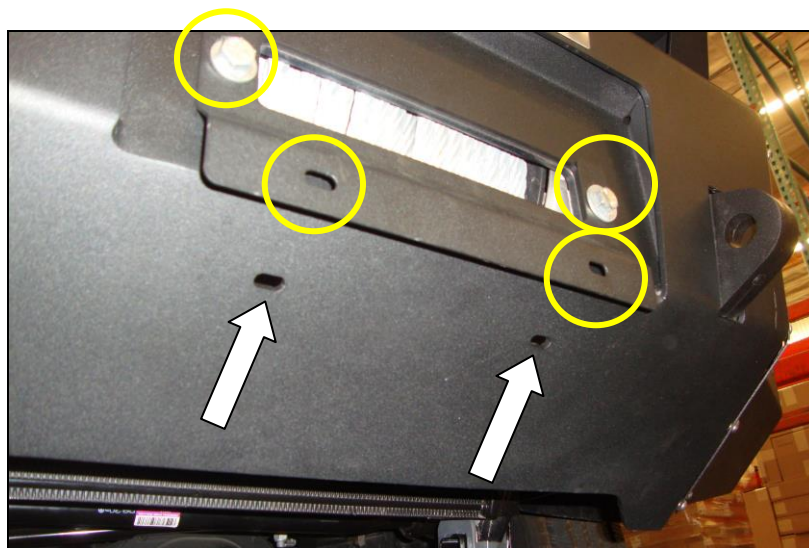

Remember to check and retighten all factory and supplied nuts and bolts periodically.