

GO RHINO! PRODUCTS 3000 SERIES INSTALLATION INSTRUCTIONS

2003-12 CHEVROLET EXPRESS VAN PART NO. 3155M

QTY PARTS DESCRIPTION

4	5/16" X 1" HEX BOLTS
4	5/16" U-NUTS
4	5/16" X 1" BUTTON HEAD BOLTS
4	5/16" LOCK NUTS
4	5/16" FLAT WASHERS
4	5/16" LOCK WASHERS
14	3/8" X 1 1/4" HEX BOLTS
8	3/8" HEX NUTS
10	3/8" FLAT WASHERS
14	3/8" LOCK WASHERS
2	1/2" X 1 1/2" HEX BOLTS
2	1/2" LOCK WASHERS
2	1/2" HEX NUTS
2	NYLON FLANGE WASHERS
2	31551 LOWER BRACKETS

QTY PARTS DESCRIPTION

1	31552D DRIVER UPPER BRACKET
1	31552P PASSENGER UPPER BRACKET
2	3155 SIDE PLATES
1	ST3006 35 3/4" BOTTOM STEP TUBE
1	TT3006 35 3/4" TOP TUBE
1	CP3006 35 3/4" CENTER PLATE
1	3156WP PASSENGER BRUSH GUARD
1	3156WD DRIVER BRUSH GUARD
1	C7P PASSENGER HEAD LIGHT PROTECTOR
1	C7D DRIVER HEAD LIGHT PROTECTOR
2	1/4" X 3/4" BUTTON HEAD BOLTS
2	1/4" SOCKET SCREWS

ASSEMBLY INSTRUCTIONS

STEP-1 BEGIN THE GRILLE AND BRUSH GUARD ASSEMBLY BY LAYING THE COMPONENTS OUT ON A PROTECTIVE SURFACE.

STEP-2 POSITION THE GRILLE GUARD SIDE PLATES WITH THE FRONT EDGE DOWN AND THE BOTTOM STEP TUBE BETWEEN THE SIDE PLATES.

STEP-3 LOOSELY ATTACH THE BOTTOM STEP TUBE TO THE GRILLE GUARD SIDE PLATES USING (4) 3/8" X 1 1/4" HEX BOLTS AND (4) 3/8" LOCK WASHERS.

STEP-4 INSERT THE FLANGE WASHERS IN THE SIDE PLATES. POSITION THE TOP TUBE BETWEEN THE GRILLE GUARD SIDE PLATES, AND SLIDE THE BRUSH GUARDS THROUGH THE SIDE PLATES, FLANGED WASHERS AND INTO THE TOP TUBE.

STEP-5 POSITION THE CENTER PLATE BETWEEN THE GRILLE GUARD SIDE PLATES, WITH THE **SLOTTED HOLES** IN THE CENTER PLATE DOWN.

STEP-6 INSERT ONE PER SIDE, 3/8" X 1 1/4" HEX BOLT THROUGH THE HOLE IN THE SIDE PLATE AND SLOTTED HOLES IN THE CENTER PLATE WITH THE **THREADS EXTENDING INWARD** AND INSTALL FLAT WASHERS, LOCK WASHER AND HEX NUTS. DO NOT TIGHTEN.

STEP-7 INSTALL LOCK AND FLAT WASHERS ON (2) 3/8" X 1 1/4" HEX BOLTS, AND INSERT THE BOLTS (ONE PER SIDE) THROUGH THE ROUND HOLES IN THE CENTER AND SIDE PLATE WITH THE **THREADS EXTENDING OUTWARD**. ATTACH THE BRUSH GUARDS TO THE SIDE PLATES USING THESE BOLTS.

STEP-8 ALIGN THE GRILLE AND BRUSH GUARD ASSEMBLY AND TIGHTEN ALL NUTS AND BOLTS. NOTE: SECURE THE TOP TUBE USING THE 1/4" SOCKET SCREWS.

STEP-9 ATTACH THE HEAD LIGHT PROTECTORS TO THE BRUSH GUARDS USING THE 1/4" X 3/4" BUTTON HEAD BOLTS AND TO THE SIDE PLATES USING THE 5/16" X 1" BUTTON HEAD BOLTS AND LOCK NUTS.

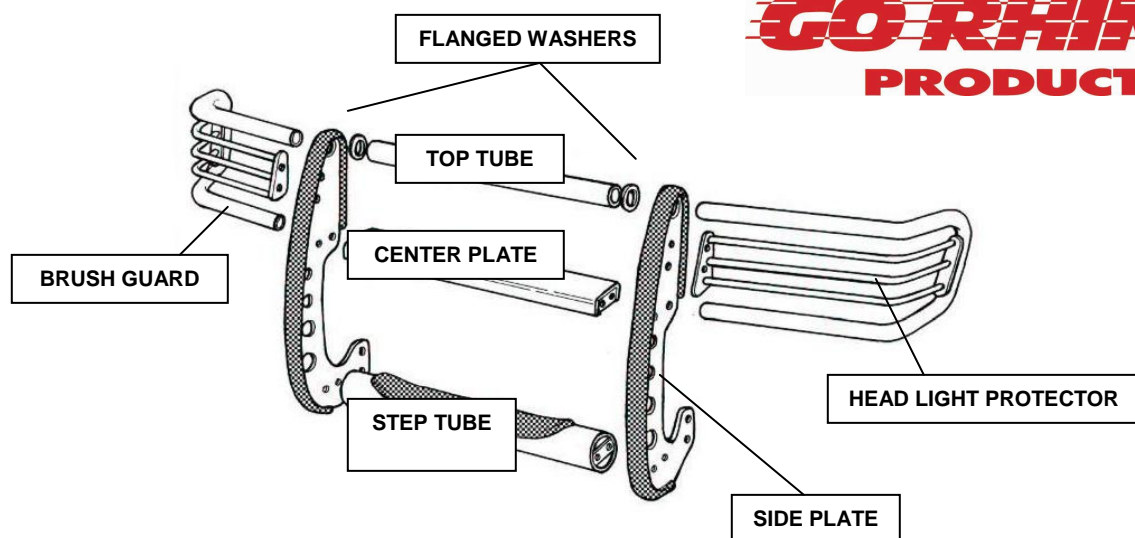

INSTALLATION INSTRUCTIONS

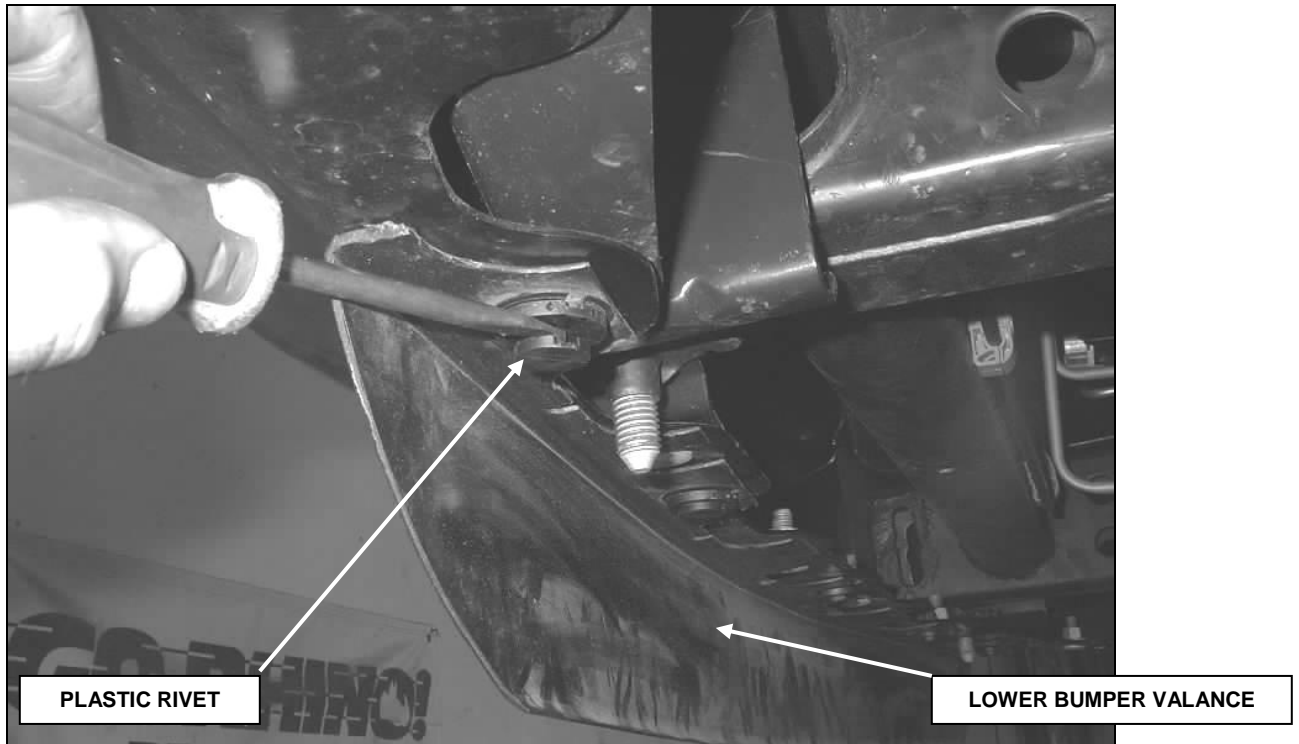

STEP-1 REMOVE THE PLASTIC RIVETS, AND BUMPER VALANCE FROM THE BOTTOM OF THE BUMPER.



STEP-2 BEGINNING WITH THE DRIVER SIDE, REMOVE THE NUT AND UPPER BUMPER BOLT. THE BOLT IS LOCATED ON THE BACK EDGE AT THE TOP OF THE BUMPER. THIS LOCATION WILL SERVE AS THE UPPER BRACKET MOUNTING POINT.

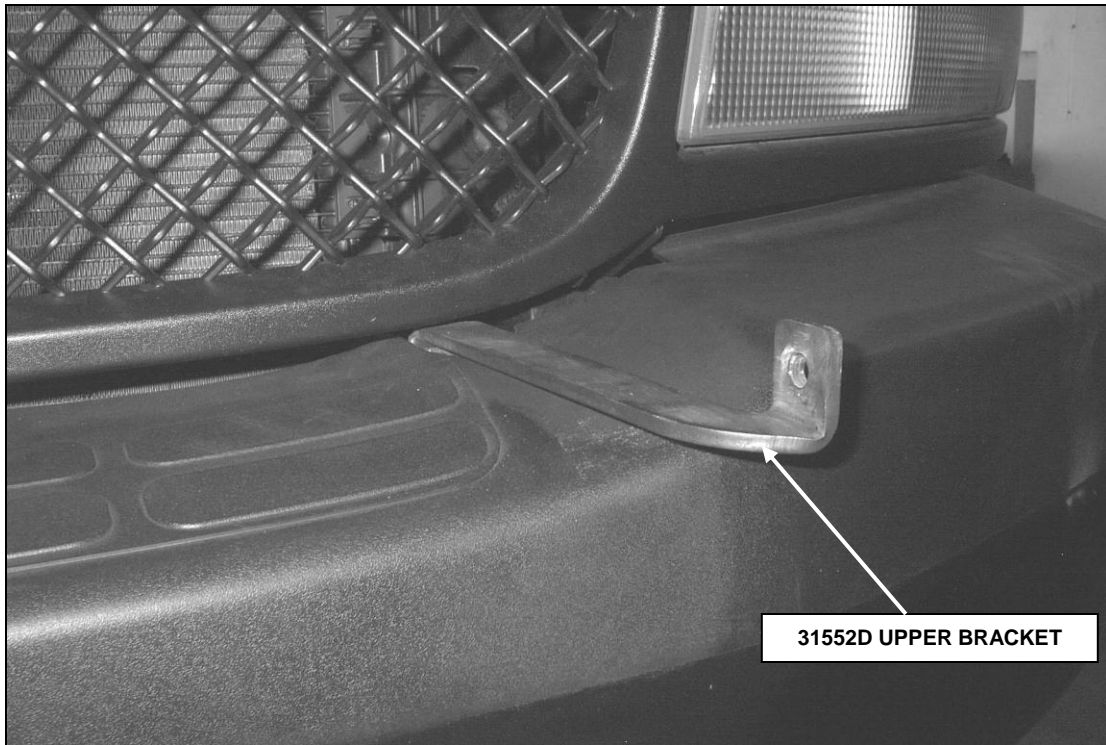

STEP-3 POSITION 31552D UPPER BRACKET BETWEEN THE GRILLE AND THE BUMPER.

STEP-4 ATTACH THE UPPER BRACKET TO THE BUMPER USING THE 1/2" X 1 1/2" HEX BOLT, LOCK WASHER AND HEX NUT AS SHOWN. REPEAT STEPS 2, 3, AND 4 TO INSTALL THE PASSENGER SIDE BRACKET.

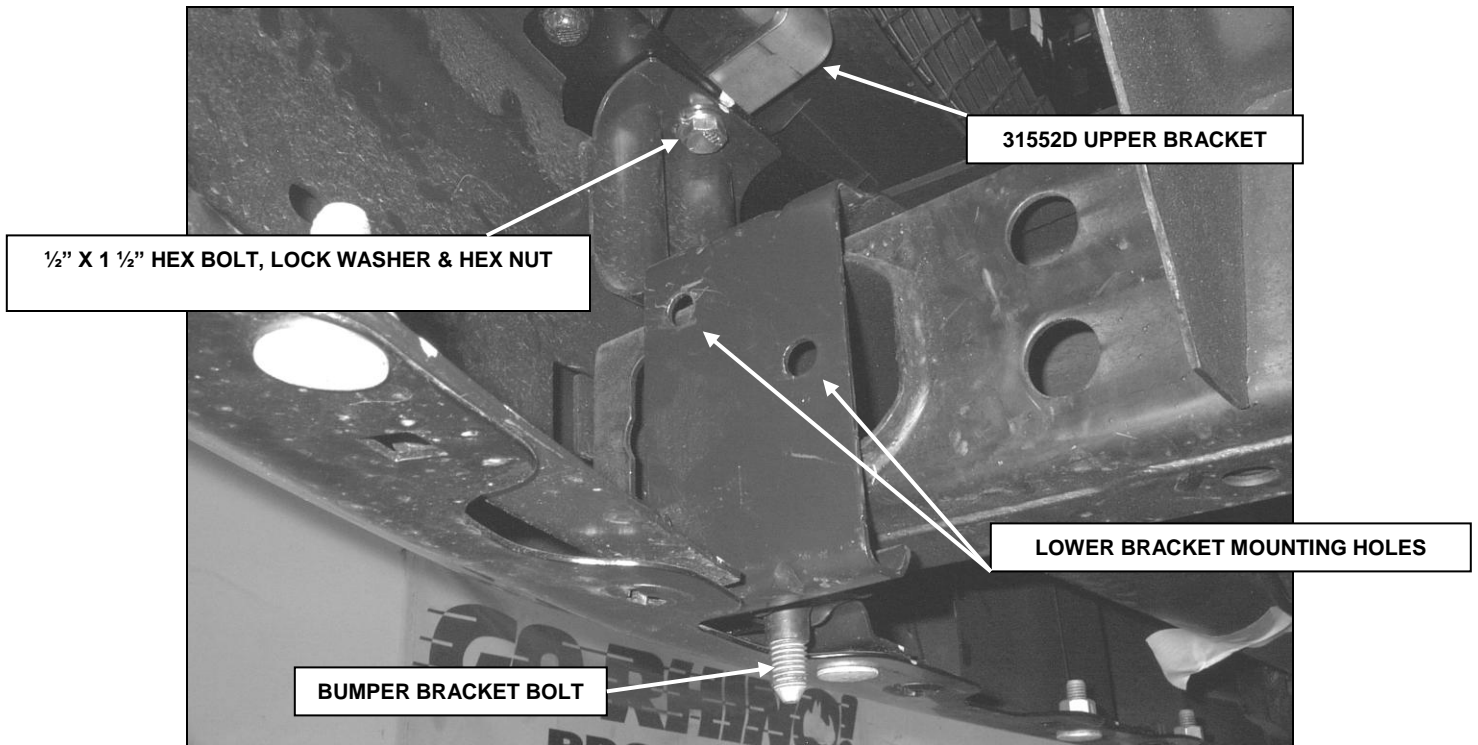

STEP-5 LOCATE THE HOLES IN THE BUMPER BRACKET. THESE HOLES WILL SERVE AS THE LOWER BRACKET MOUNTING POINTS.

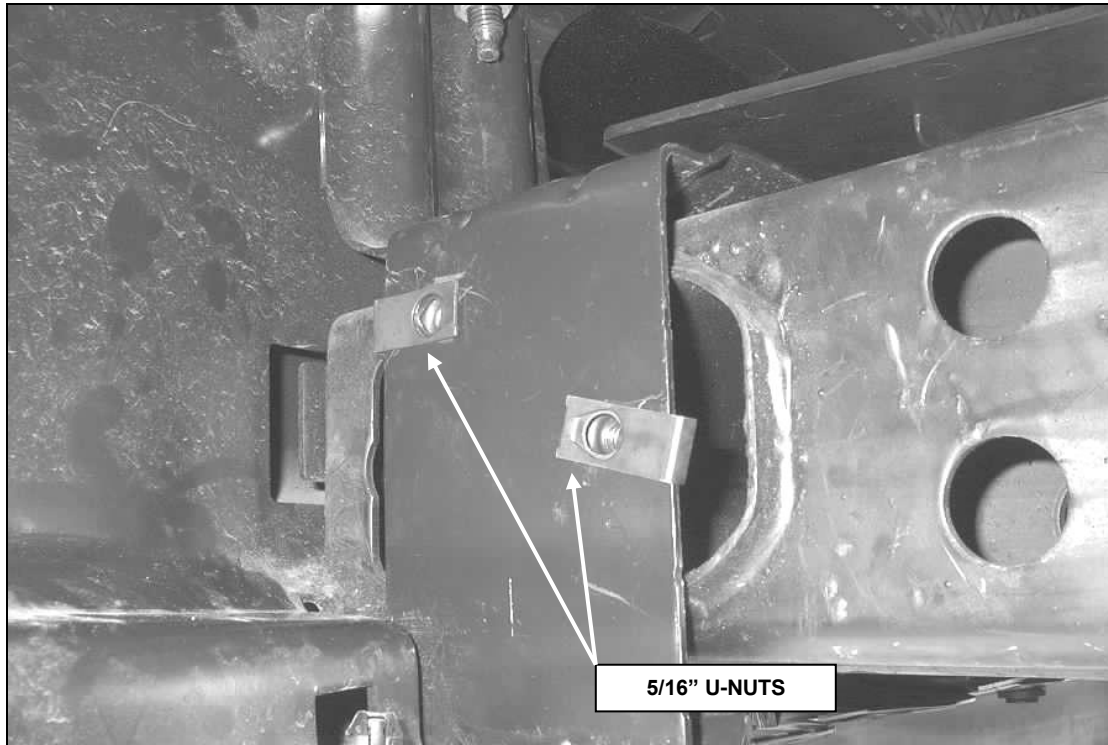

STEP-6 INSTALL THE 5/16" U-NUTS ON THE BUMPER BRACKET AS SHOWN. NOTE: IT MAY BE NECESSARY TO LOOSEN THE BUMPER BRACKET BOLTS, AND SLIGHTLY PRY THE BUMPER BRACKET AWAY FROM THE FRAME TO INSTALL THE FRONT U-NUT.

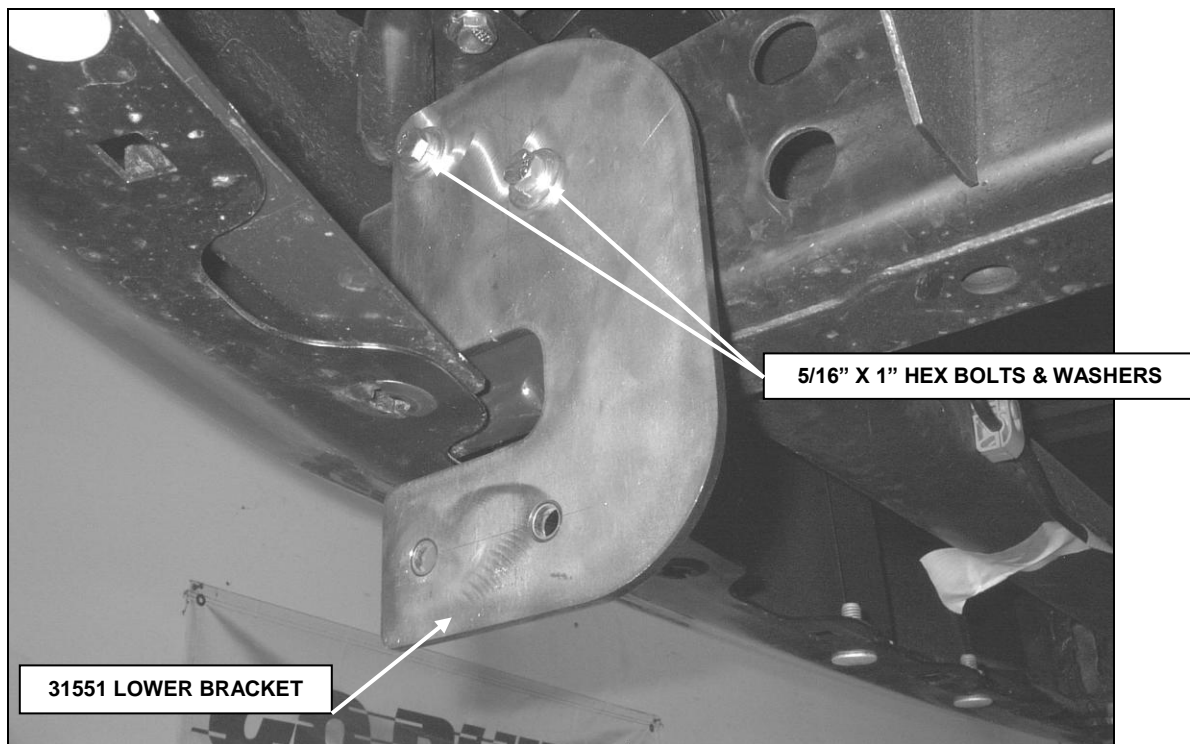

STEP-7 LOOSELY ATTACH ONE OF THE 31551 LOWER BRACKETS TO THE BUMPER BRACKET USING 5/16" X 1" HEX BOLTS, FLAT WASHERS AND LOCK WASHERS. REPEAT STEPS 5, 6, AND 7 TO INSTALL THE PASSENGER SIDE.

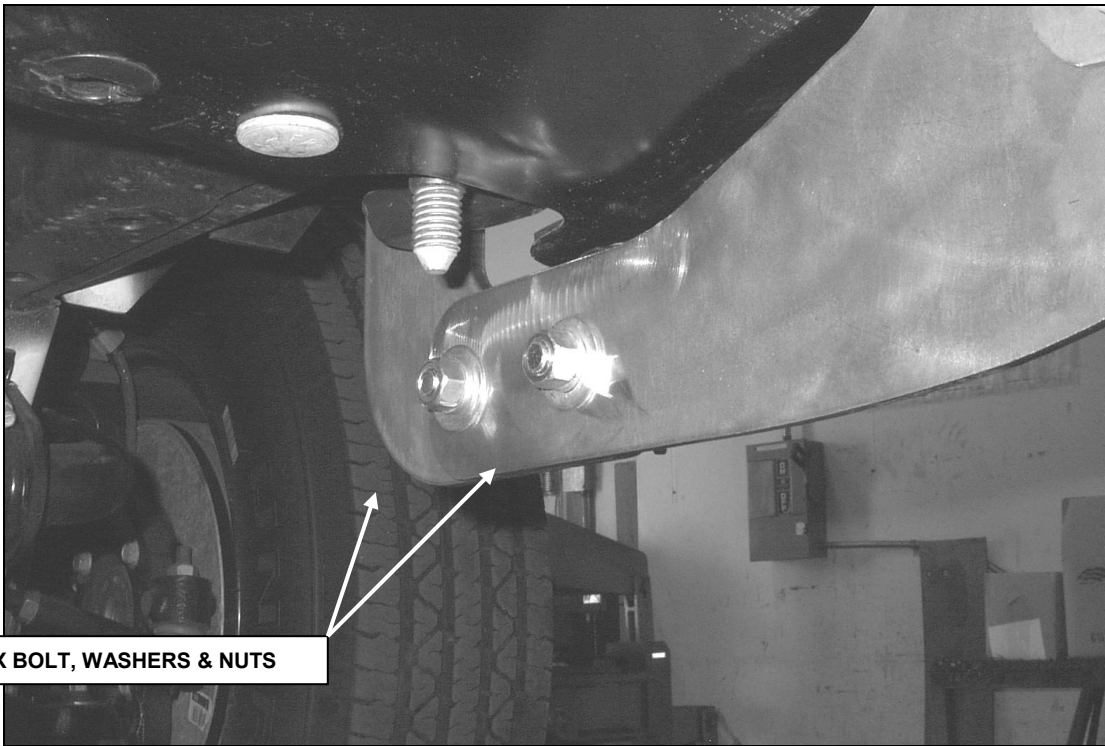

STEP-8 ATTACH THE GRILLE GUARD ASSEMBLY TO THE LOWER BRACKETS, USING THE 3/8" x 1 1/4" HEX BOLTS, LOCK WASHERS, FLAT WASHERS AND HEX NUTS.

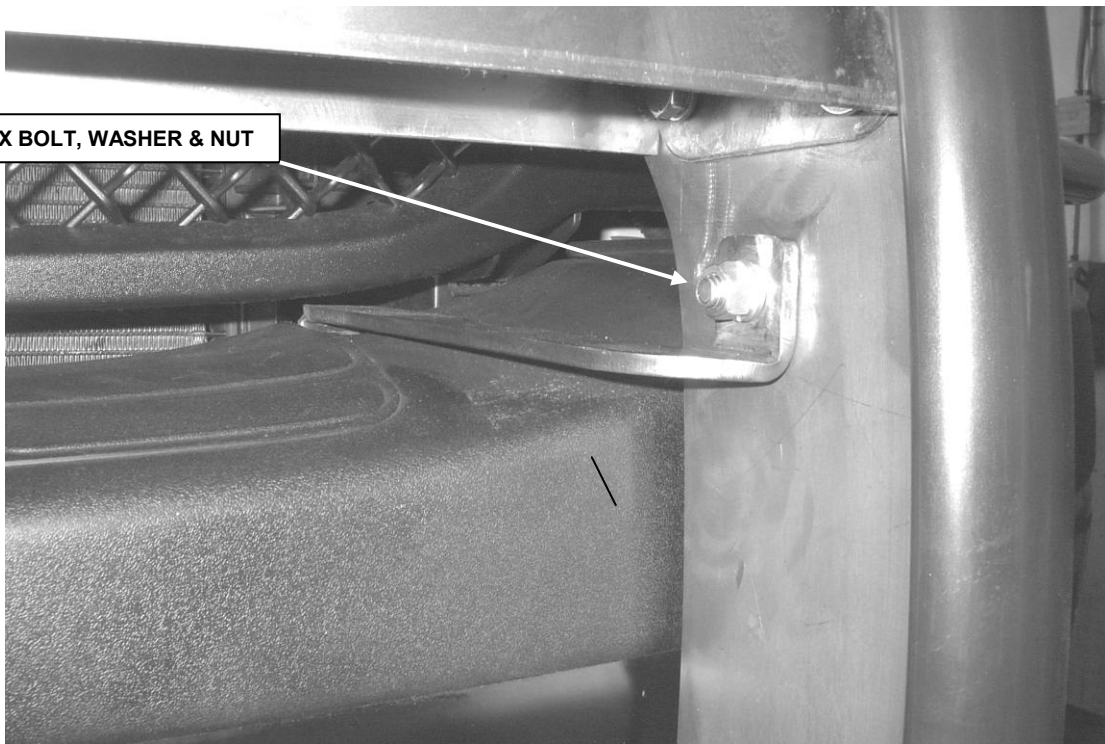

STEP-8 ATTACH THE GRILLE GUARD ASSEMBLY TO THE UPPER BRACKETS USING THE 3/8 X 1" HEX BOLTS, LOCK WASHERS, FLAT WASHERS AND HEX NUTS.

STEP-9 ALIGN THE GRILLE GUARD ASSEMBLY WITH THE FRONT OF THE VEHICLE AND TIGHTEN ALL MOUNTING NUTS AND BOLTS.

STEP-10 NOTCH THE LOWER BUMPER VALANCE TO CLEAR THE LOWER BRACKETS, AND REATTACH USING THE FACTORY RIVETS.