

UNSTOPPABLE  **GERBER®**

PRODUCT

CATALOG



Badassador (noun) – doing whatever it takes, even if that's everything you got; finding out you have more inside than you thought; out there in the woods and swamp and sea, in it; the act of being Unstoppable.



AMERICAN SPIRIT

Built through grit, passion and hard work, Gerber's competitive spirit is unwavering.



ORIGINAL INNOVATOR

Gerber products challenge the status quo, and bring new solutions to common problems.



BORN ON THE BATTLEFIELD

Gerber understands trust, and knows great products can be the difference between life and death.



BUILT TO ENDURE

Made to save time or save the day, Gerber tools are built for use and will stand the test of time.



KNIVES



NEW

Ø6 AUTO™ 1ØTH ANNIVERSARY EDITION

Honoring the American heritage and time-tested durability of the Ø6 Automatic family, Gerber proudly presents an innovative evolution of everything that made the original the best in its class. The Ø6 Automatic 1Øth Anniversary knife is a special edition celebration of Gerber's craftsmanship, design, and spirit. Thoughtful upgrades nod to Gerber's continued service to the US military: the Olive Drab green aluminum handle, the specialty stone washed finish on the S3ØV blade, as well as the commemorative reverse flag laser mark honoring those who serve. Born on the battlefield and tested everywhere else, this is a collectible not to be missed.

BLADE LENGTH:	3.8"
OVERALL LENGTH:	8.7"
HANDLE:	CERAKOTE® COATED ALUMINUM
BLADE:	S3ØV



"This is till this day my favorite knife of all time. Sharp, heavy, durable, and time tested. Buying another because my first one is missing."

★★★★★
DYLAN PRESTON

- CERAKOTE® COATED ALUMINUM HANDLES
- S3ØV BLADE W/ STONE WASHED FINISH
- PUSH BUTTON DEPLOYMENT
- 1ØTH ANNIVERSARY REVERSE FLAG LASER MARK
- POCKET CLIP FOR CONVENIENT STORAGE



BOX 22-ØØ1263 FINE EDGE/DROP POINT OLIVE DRAB GREEN AUTO KNIVES AVAILABLE THROUGH AUTHORIZED DEALERS ONLY.

NEW

AIRLIFT™

A smart mashup of two best-selling designs, the Airlift offers the durable steel frame of the Paraframe with the streamlined blade and handle design of the RipStop. The result is an everyday carry knife that is light in the pocket yet surprisingly resilient in use.

BLADE LENGTH:	2.8"
OVERALL LENGTH:	7"
HANDLE:	STAINLESS STEEL
BLADE:	5CR15MOV



*Product rendering

- ALL STEEL CONSTRUCTION
- DUAL THUMBSTUDS
- FRAME LOCK
- POCKET CLIP
- SLIM PROFILE

BOX	30-001347	FINE EDGE/CLIP POINT	FRAME LOCK	ONE-HAND OPEN	LANYARD HOLE	CHAMPAGNE
BLISTER	31-003316	FINE EDGE/CLIP POINT	FRAME LOCK	ONE-HAND OPEN	LANYARD HOLE	CHAMPAGNE
BOX	30-001347	FINE EDGE/CLIP POINT	FRAME LOCK	ONE-HAND OPEN	LANYARD HOLE	BLACK
BLISTER	31-003316	FINE EDGE/CLIP POINT	FRAME LOCK	ONE-HAND OPEN	LANYARD HOLE	BLACK

NEW

COMMUTER™

The Commuter is an everyday carry pocket folding knife designed and built in Gerber's Portland factory. It is just as portable as the ever-popular LST and American made US1 yet offers a slightly heftier design to fit into a larger hand. It can still be carried comfortably in a pocket, purse or backpack with very little weight added and offers an easy to open solution to daily tasks.

BLADE LENGTH:	3.0"
OVERALL LENGTH:	7.2"
HANDLE:	GLASS-FILLED NYLON W/ RUBBER INSERTS
BLADE:	42ØHC



- LIGHTWEIGHT
- 42ØHC BLADE W/ STONE WASHED FINISH
- NAIL NICK OPENING
- LOCK BACK MECHANISM
- POCKET CLIP FOR CONVENIENT STORAGE

BLISTER 31-ØØ3136 FINE EDGE/DROP POINT FINGER JIMPING LOCK BACK MECHANISM NAIL NICK OPENING

NEW

COVERT™ AUTO



BLADE LENGTH:	8.7"
OVERALL LENGTH:	3.8"
HANDLE:	TYPE III ANODIZED 6061 ALUMINUM
BLADE:	S30V



- PERFECTLY BALANCED KNIFE
- S30V AMERICAN STEEL BLADE
- SPRING-LOADED AUTOMATIC RELEASE
- PLUNGE LOCK
- LANYARD HOLE

BOX	30-001306	FINE EDGE	TACTICAL GRAY, BLACK OXIDE	PLUNGE LOCK	LANAYRD HOLE	POCKET CLIP
BOX	30-001307	FINE EDGE	TACTICAL GRAY, STONEWASH	PLUNGE LOCK	LANAYRD HOLE	POCKET CLIP

NEW

EDICT™ GREEN

An evolution of the popular Gerber Edict, this knife was designed for everyday carry. The full size, drop point blade features a fine edge with no serrations, allowing for maximum cutting and slicing capabilities. Constructed of American 154CM steel, the blade offers excellent edge retention and features Gerber's standard glass bead finish for minimal reflection. Dual thumbstuds allow for quick one-handed blade deployment and the knife's lock back closing mechanism provides structural integrity in heavy-duty applications. The glass-filled nylon handle features a large palm swell, a finger guard for heavy-duty work, and a rubberized diamond texture for a secure grip in all weather conditions. Proudly made in Portland, OR. .

BLADE LENGTH:	3.6"
OVERALL LENGTH:	8.5"
HANDLE:	GLASS-FILLED NYLON W/ RUBBER OVERMOLD
BLADE:	154CM



- RUBBERIZED DIAMOND TEXTURED HANDLE
- LOCK BACK MECHANISM
- DUAL THUMBSTUDS
- LANYARD HOLE
- POCKET CLIP

BOX 30-001300 FINE EDGE/DROP POINT 154CM BLADE LOCK BACK MECHANISM LANYARD HOLE POCKET CLIP

NEW

HAUL™ A0

The Ignition is a modern, stylized assisted opening knife that springs into action via the dual thumbstuds. Once open, the cross-bolt safety feature secures the blade in place – an easy to operate plunge lock disengages the blade and keeps it safely stowed when not in use.

BLADE LENGTH:	3.1"
OVERALL LENGTH:	7.9"
HANDLE:	GLASS-FILLED TEXTURED NYLON
BLADE:	3CR15MOV



*Product rendering

- ASSISTED OPENING
- SAFETY LOCK
- DUAL THUMBSTUDS
- POCKET CLIP
- LANYARD HOLE

BOX	30-001397	FINE EDGE/DROP POINT	PLUNGE LOCK	DUAL THUMBSTUDS	POCKET CLIP	LANYARD HOLE	BLUE
BLISTER	31-003350	FINE EDGE/DROP POINT	PLUNGE LOCK	DUAL THUMBSTUDS	POCKET CLIP	LANYARD HOLE	BLUE
BOX	30-001398	FINE EDGE/DROP POINT	PLUNGE LOCK	DUAL THUMBSTUDS	POCKET CLIP	LANYARD HOLE	RED
BLISTER	31-003351	FINE EDGE/DROP POINT	PLUNGE LOCK	DUAL THUMBSTUDS	POCKET CLIP	LANYARD HOLE	RED

NEW

INDEX™

The bold colors and angular design of the Index finger flipper knife reflect the rugged, everyday use that it was intended for. The finger flipper gives quick access to the blade while also acting as an extra finger guard while the blade is deployed. A pocket clip and lanyard hole are ideal for daily carry.

BLADE LENGTH:	3.3"
OVERALL LENGTH:	7.8"
HANDLE:	ANODIZED STAMPED ALUMINUM
BLADE:	5CR15MOV



*Product rendering

- FINGER FLIPPER BLADE TANG
- TEXTURED ANODIZED ALUMINUM HANDLE SCALES
- DUAL THUMBSTUDS
- LINER LOCK

BOX	30-001356	FINE EDGE/DROP POINT	LINER LOCK	FINGER FLIPPER	POCKET CLIP	LANYARD HOLE	BLUE
BLISTER	31-003325	FINE EDGE/DROP POINT	LINER LOCK	FINGER FLIPPER	POCKET CLIP	LANYARD HOLE	BLUE
BOX	30-001355	FINE EDGE/DROP POINT	LINER LOCK	FINGER FLIPPER	POCKET CLIP	LANYARD HOLE	RED
BLISTER	31-003323	FINE EDGE/DROP POINT	LINER LOCK	FINGER FLIPPER	POCKET CLIP	LANYARD HOLE	RED
BLISTER	31-003324	FINE EDGE/DROP POINT	LINER LOCK	FINGER FLIPPER	POCKET CLIP	LANYARD HOLE	RED, EFS

NEW

MINI COVERT™ AUTO

An evolution of the best-in-class Applegate-Fairbairn folder, this compact version features a spring-loaded auto release that deploys the S30V blade at the touch of a button. Updated with new handle colors and blade finishes, this classic is not to be missed.



BLADE LENGTH:	2.8"
OVERALL LENGTH:	6.5"
HANDLE:	TYPE III HARD ANODIZED ALUMINUM HANDLE
BLADE:	S30V



*Product rendering



- S30V AMERICAN STEEL
- PLUNGE LOCK
- PUSH BUTTON DEPLOYMENT
- POCKET CLIP
- LANYARD HOLE

BOX	30-001396	FINE EDGE/SPEAR POINT	S30V STEEL BLADE	COYOTE/BLACK OXIDE	POCKET CLIP
BOX	30-001394	FINE EDGE/SPEAR POINT	S30V STEEL BLADE	BLACK/BLACK OXIDE	POCKET CLIP
BOX	30-001395	FINE EDGE/SPEAR POINT	S30V STEEL BLADE	TACTICAL GRAY/STONEWASH	POCKET CLIP

NEW

ONE-FLIP™

With a unique and stylish aesthetic, the One-Flip quickly grabs attention. The finger flipper quickly deploys the graceful blade, acting as an extra finger guard when in use. Textured anodized aluminum handle scales provide grip and add distinctive flair to this everyday carry knife.

BLADE LENGTH:	3.2"
OVERALL LENGTH:	7.7"
HANDLE:	ANODIZED STAMPED ALUMINUM
BLADE:	5CR15MOV



*Product rendering



- FINGER FLIPPER BLADE TANG
- DUAL THUMBSTUDS
- TEXTURED ANODIZED ALUMINUM HANDLE
- LINER LOCK
- LANYARD HOLE

BLISTER	31-003319	FINE EDGE/DROP POINT	POCKET CLIP	LINER LOCK	GREEN
BOX	30-001354	FINE EDGE/DROP POINT	POCKET CLIP	LINER LOCK	BLUE
BLISTER	31-003321	FINE EDGE/DROP POINT	POCKET CLIP	LINER LOCK	BLUE
BLISTER	31-003322	FINE EDGE/DROP POINT	POCKET CLIP	LINER LOCK	BLUE, EFS

NEW

PARALITE™

An everyday carry knife should be durable and easy to operate in a pinch – the Paralite does just that. With an all steel construction and a robust modern drop point blade, this slim knife fits into your pocket yet is surprisingly strong. Dual thumbstuds grant easy access to the blade and the frame lock makes it simple to close with one hand.

BLADE LENGTH:	3"
OVERALL LENGTH:	7.1"
HANDLE:	STAINLESS STEEL
BLADE:	5CR15MOV



*Product rendering

- ONE-HAND OPENING
- DUAL THUMBSTUDS
- FRAME LOCK
- ALL STEEL CONSTRUCTION
- POCKET CLIP

BOX	30-001344	FINE EDGE/DROP POINT	DUAL THUMBSTUDS	FRAME LOCK	POCKET CLIP	ROSE/BLUE
BLISTER	31-003310	FINE EDGE/DROP POINT	DUAL THUMBSTUDS	FRAME LOCK	POCKET CLIP	ROSE/BLUE
BOX	30-001345	FINE EDGE/DROP POINT	DUAL THUMBSTUDS	FRAME LOCK	POCKET CLIP	CHAMPAGNE
BLISTER	31-003312	FINE EDGE/DROP POINT	DUAL THUMBSTUDS	FRAME LOCK	POCKET CLIP	CHAMPAGNE

NEW

PROPEL™ AUTO

Building on the field-proven performance and fast, one-handed blade deployment of the long-popular Ø6 Auto knife, the Propel packs the same level of full size utility and durability in a slimmer, more pocket-friendly profile. Updated with new handle colors and blade finishes, it is the perfect addition to your arsenal.

BLADE LENGTH:	3.5"
OVERALL LENGTH:	8.5"
HANDLE:	G-1Ø
BLADE:	S3ØV



- S3ØV AMERICAN STEEL
- PLUNGE LOCK
- PUSH BUTTON DEPLOYMENT
- 3-POSITION POCKET CLIP
- LANYARD HOLE

BOX	3Ø-ØØ1317	SERRATED/TANTO	OD GREEN/BLACK OXIDE	3-POSITION POCKET CLIP	LANYARD HOLE
BOX	3Ø-ØØ13Ø7	FINE EDGE/TANTO	OD GREEN/BLACK OXIDE	3-POSITION POCKET CLIP	LANYARD HOLE
BOX	3Ø-ØØ13Ø9	FINE EDGE/TANTO	OD GREEN/STONEWASH	3-POSITION POCKET CLIP	LANYARD HOLE

NEW

POCKET SQUARE™

The Pocket Square is a great addition to Gerber's pocket clip folding knives. Designed in Portland this modern design resonates with the digitally oriented, urban carry crowd. With squared edges and an ambidextrous or removable pocket clip, this knife can be carried wherever it is needed. The unique thumb-lift allows easy access from both sides.

BLADE LENGTH:	2.9"
OVERALL LENGTH:	6.8"
HANDLE:	MACHINED ALUMINUM/ GLASS-FILLED NYLON
BLADE:	7CR17MOV



- LINER LOCK MECHANISM
- DUAL ACCESS THUMB LIFT
- AMBIDEXTROUS LOW RISE POCKET CLIP
- MACHINED ALUMINUM OR
GLASS-FILLED NYLON HANDLE

BOX	30-001363	FINE EDGE/DROP POINT	MACHINE ALUMINUM HANDLE	THUMB LIFT	AMBIDEXTROUS POCKET CLIP
BLISTER	30-003130	FINE EDGE/DROP POINT	MACHINE ALUMINUM HANDLE	THUMB LIFT	AMBIDEXTROUS POCKET CLIP
BOX	30-001362	FINE EDGE/DROP POINT	GLASS-FILLED NYLON HANDLE	THUMB LIFT	AMBIDEXTROUS POCKET CLIP
BLISTER	30-003129	FINE EDGE/DROP POINT	GLASS-FILLED NYLON HANDLE	THUMB LIFT	AMBIDEXTROUS POCKET CLIP

NEW

SHARK BELLY™

An update to a classic and proven design, the Shark Belly is an everyday carry that is affordable, dependable, and made in the USA. The scratch-resistant wire clip means it can be worn anywhere you choose; the flat top serrations can be sharpened and are practical for a knife that gets daily use.

BLADE LENGTH:	3.2"
OVERALL LENGTH:	7.8"
HANDLE:	GLASS-FILLED NYLON
BLADE:	42ØHC



- ONE HAND OPEN
- AMBIDEXTROUS OPENING
- LOCK BACK MECHANISM
- SCRATCH RESISTANT WIRE POCKET CLIP
- LANYARD HOLE

BLISTER	31-003216	SERRATED/SHEEPSFOOT	SHARPENABLE SERRATIONS	WIRE POCKET CLIP	LANYARD HOLE
BLISTER	31-003214	FINE EDGE/SHEEPSFOOT	LOCK BACK MECHANISM	WIRE POCKET CLIP	LANYARD HOLE

NEW

VITAL™ BIG GAME FOLDER

The Vital Big Game Folder ensures both safe operation and precise utility with the safety-focused push button exchangeable blade system. The intuitive workhorse has a surgically sharp, full size blade that is now even larger, offering additional purchase when working through large game. Sheath included.

BLADE LENGTH:	4.9"
OVERALL LENGTH:	11"
HANDLE:	GRIPPY OVERMOLD
BLADE:	42ØJ2

See new blade carriers on
page 145



- 42ØJ2 STEEL
- LOCK BACK MECHANISM
- POCKET CLIP
- LANYARD HOLE
- SHEATH

BLISTER 31-ØØ3Ø53 42ØJ2 BLADE STEEL PUSH BUTTON BLADE CHANGE ERGONOMIC GRIP SHEATH

B.O.S.S. TECH™

BALLS OF STAINLESS STEEL

**GERBER'S SMOOTHEST,
MOST CONSISTENT
DEPLOYMENT EVER.**

BALL-BEARING SYSTEM:

- + STAINLESS STEEL BALLS REDUCE FRICTION FOR SEAMLESS OPENING.
- + CAGE SYSTEM KEEPS BALLS CONTAINED FOR STABLE PERFORMANCE OVER TIME.



LESS FRICTION,
MORE STABILITY

NEW

US-ASSIST™

NEW

US-ASSIST™

Designed and built in Portland, Oregon, the US-Assist offers Gerber's smoothest, most consistent deployment to date.

Including B.O.S.S. Tech, it features a ball-bearing system to reduce friction & provide stable performance for the long haul.

BLADE LENGTH:	3.0"
OVERALL LENGTH:	7.2"
HANDLE:	GLASS-FILLED NYLON
BLADE:	S30V OR 420HC



"It opens really fast and smooth, every time."

ALICIA ELFVING, OREGON

B.O.S.S. TECH™

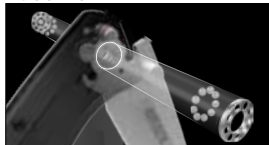

- BALL-BEARING DEPLOYMENT SYSTEM
- PLUNGE LOCK CROSSBOLT SYSTEM
- DUAL RAMPED THUMBSTUDS
- SCRATCH-RESISTANT CLIP

BOX	30-001205	FINE EDGE	S30V BLADE	PLUNGE LOCK	DUAL THUMBSTUDS	POCKET CLIP
BOX	30-001206	FINE EDGE	420HC BLADE	PLUNGE LOCK	DUAL THUMBSTUDS	POCKET CLIP
BLISTER	31-003105	FINE EDGE	420HC BLADE	PLUNGE LOCK	DUAL THUMBSTUDS	POCKET CLIP
BOX	30-001294	SERRATED	420HC BLADE	PLUNGE LOCK	DUAL THUMBSTUDS	POCKET CLIP
BLISTER	31-003240	SERRATED	420HC BLADE	PLUNGE LOCK	DUAL THUMBSTUDS	POCKET CLIP



BASIC™

While lightweight and slim, this knife boasts a partially serrated fixed blade, anchored in a full tang application. A TacHide™ overmold keeps the handle secure and comfortable for any condition, an innovative sheath lets you choose where to carry.

BLADE LENGTH:	3.4"
WEIGHT:	3.8 OZ
HANDLE:	TACHIDE™
SHEATH:	INCLUDED
BLADE:	FULL TANG



BLISTER 31-000367 SERRATED/DROP POINT MOLDED PLASTIC SHEATH W/ REVERSIBLE CLIP

BIG ROCK™ CAMP KNIFE

Designed for hunting yet versatile enough for utilitarian use, this sturdy knife has a 4.5 inch fixed blade that will handle a myriad of outdoor tasks easily. With a glass-filled nylon core and a TacHide™ overmold, the handle is ready for all day use.

BLADE LENGTH:	4.5"
WEIGHT:	6.4 OZ
HANDLE:	TACHIDE™
SHEATH:	INCLUDED
BLADE:	FULL TANG



BOX	22-01589	FINE EDGE/DROP POINT	BLACK POLYMER-LINED CLOTH SHEATH
BLISTER	22-41588	SERRATED/DROP POINT	BLACK POLYMER-LINED CLOTH SHEATH
BOX	22-01588	SERRATED/DROP POINT	BLACK POLYMER-LINED CLOTH SHEATH

CFB™ [COMBAT FIXED BLADE]

The Combat Fixed Blade is tough, indestructible, and reliable. The full tang 154CM stainless steel tanto blade offers maximum strength and the partially serrated edge gives versatility. The molded plastic sheath can be worn on MOLLE, as well as your belt.

BLADE LENGTH:	4.3"
WEIGHT:	4.9 OZ
HANDLE:	RUBBERIZED GRIP
SHEATH:	INCLUDED
BLADE:	154CM STEEL



"It feels glorious in your hand and it's extremely light."

★★★★★

RICHARD, NORTH CAROLINA



BG COMPACT FIXED BLADE™

Compact and indestructible, this knife was designed to be the survival tool that stays close at hand. A durable rubber handle is ergonomically shaped for better grip; the handy blade is housed in a plastic sheath that can clip anywhere.

BLADE LENGTH:	3.4"
WEIGHT:	3.8 OZ
HANDLE:	DURABLE RUBBER
SHEATH:	INCLUDED
BLADE:	7CR17MOV STEEL



BOX 22-01145DS SERRATED/TANTO BLACK FIBERGLASS REINFORCED NYLON SHEATH

BLISTER 31-002946 FINE EDGE/DROP POINT MOLDED PLASTIC SHEATH W/ REVERSIBLE CLIP
BLISTER 31-001066 SERRATED/DROP POINT MOLDED PLASTIC SHEATH W/ REVERSIBLE CLIP

CRISIS HOOK KNIFE™

This featherweight knife is engineered for emergency situations: a hook knife that cuts seatbelts, cords, or rope. The elongated profile and blunt tip provide versatile use, never fearing to injure those being rescued. A glass-breaker pommel is part of the handle.

BLADE LENGTH:	2.9"
WEIGHT:	3.0 OZ
HANDLE:	STEEL W/ RUBBER OVERMOLD
SHEATH:	INCLUDED
BLADE:	420C STEEL



BOX 30-000590 SINGLE BEVEL + HOOK TAN499 FRICTION LOCK, MOLLE-COMPATIBLE SHEATH

EPIC™

Cook, eat, drink, and be merry. With a blunt tip and a bottle opener, this compact knife is loaded with every feature a camper needs. A reversible pocket clip is designed for right or left carry, and a locking sheath adds versatile carry options.

BLADE LENGTH:	3.5"
WEIGHT:	5.1 OZ
HANDLE:	TEXTURED GLASS-FILLED NYLON
SHEATH:	INCLUDED
BLADE:	FULL TANG



BLISTER BOX 31-000368 30-000176 SERRATED/DROP POINT SERRATED/DROP POINT MOLDED PLASTIC SHEATH MOLDED PLASTIC SHEATH REVERSIBLE POCKET CLIP REVERSIBLE POCKET CLIP

FREEMAN™ GUIDE

This knife was created for one reason: to be your go-to knife on the hunt. Full tang construction gives added strength to the 4 inch blade, while larger finger grooves offer comfort for all day use. The TacHide™ overmold provides secure grip in any weather.

BLADE LENGTH:	4.0"
WEIGHT:	4.4 OZ
SHEATH:	INCLUDED
HANDLE:	TACHIDE™
BLADE:	FULL TANG



BLISTER	31-000589	FINE EDGE/GUT HOOK	BLACK POLYMER LINED CLOTH SHEATH
BLISTER	31-000588	FINE EDGE/DROP POINT	BLACK POLYMER LINED CLOTH SHEATH

FREESCAPE™ CAMP KITCHEN KIT

This kit has everything you need at the campground: the Camp Kitchen Knife and the Paring knife live within a carrying case that functions as a cutting board and features a built-in sharpener. With extra storage space, this dishwasher-safe kit is a must.

CUTTING BOARD:	
OVERALL DIMENSION:	11.2" X 10.1" X 1.3"
CUTTING SURFACE:	10.1" X 8.2"
WEIGHT:	31.5 OZ
MATERIAL:	POLYPROPYLENE CUTTING BOARD CARBIDE BLADE SHARPENER



"If you're planning to prepare meals from scratch, bring along the Gerber Freescape Camp Kitchen Kit"

— MEN'S JOURNAL



WRAP	30-001041	FINE EDGE/MODIFIED SHEEPSFOOT BLADE	CASE HAS CUTTING SURFACE + BLADE SHARPENER
------	-----------	-------------------------------------	--

FREESCAPE™ CAMP KITCHEN KNIFE

Inspired by a Santoku chef's knife, this tool has a modified sheepfoot blade that is nimble enough for kitchen tasks yet strong enough for the campsite. The full tang construction gives added stability and the rubberized handle feels secure in hand.

BLADE LENGTH:	3.8"
WEIGHT:	6.5 OZ
SHEATH:	INCLUDED
HANDLE:	TEXTURED RUBBER
BLADE:	7CR17MOV



BLISTER 31-002533 FINE EDGE/MODIFIED SHEEPSFOOT BLADE REFLECTIVE SHEATH W/ BELT LOOP

FREESCAPE™ PARING KNIFE

This clever knife is the perfect campsite sidekick, the full fine edge blade excels at food prep while the rubberized handle and slim profile make comfortable work of any task. It is dishwasher safe, making this knife user friendly at home or in the wild.

BLADE LENGTH:	3.0"
WEIGHT:	1.2 OZ
SHEATH:	INCLUDED
HANDLE:	TEXTURED RUBBER
BLADE:	7CR17MOV



BLISTER 31-002886 FINE EDGE/MODIFIED SHEEPSFOOT BLADE REFLECTIVE SHEATH W/ BELT LOOP

GATOR® FILLET

With thoughtful details and masterful craftsmanship, this tough yet nimble knife should be on hand when you reel in the big one. With full tang construction in a slim profile, a Gator Grip® handle, and a sheath with a built in sharpener, it is a must have.

BLADE LENGTH:	6" / 7"
WEIGHT:	4.2 OZ / 4.4 OZ
SHEATH:	INCLUDED
HANDLE:	GATOR GRIP®
BLADE:	42ØHC



BLISTER	7523Ø	FINE EDGE / 6"	MOLDED PLASTIC SHEATH W/ BUILT-IN SHARPENER
BLISTER	75231	FINE EDGE / 7"	MOLDED PLASTIC SHEATH W/ BUILT-IN SHARPENER

GATOR® FIXED

With an iconic design, the Gator series has become synonymous with craftsmanship and field-tested durability. The full tang construction partners with the patented Gator Grip® handle to offer unsurpassed comfort and ease of use.

BLADE LENGTH:	4.5"
WEIGHT:	5.4 OZ
SHEATH:	INCLUDED
HANDLE:	GATOR GRIP®
BLADE:	42ØHC



Sheath
Made
in China

BLISTER	469Ø6	FINE EDGE/GUT HOOK	BLACK NYLON W/ MOLDED PLASTIC INSERT
BOX	Ø69Ø6	FINE EDGE/GUT HOOK	BLACK NYLON W/ MOLDED PLASTIC INSERT
BLISTER	469Ø4	FINE EDGE/DROP POINT	BLACK NYLON W/ MOLDED PLASTIC INSERT
BOX	Ø69Ø4	FINE EDGE/DROP POINT	BLACK NYLON W/ MOLDED PLASTIC INSERT



NEW

GATOR® PREMIUM FIXED BLADE

The elevated, first-class reincarnation of the original, this knife offers American made excellence with premium materials. The full tang S30V steel blade will last generations, an upgraded Gator Grip® handle and steel bolsters give ultimate control.

BLADE LENGTH:	4.0"
WEIGHT:	8.0 OZ
SHEATH:	INCLUDED
HANDLE:	PREMIUM GATOR GRIP®
BLADE:	S30V



GDC HOOK KNIFE™

Easily accessible and stealth, this 2 inch stainless steel hook knife is designed for both daily use or emergencies. The innovative ring design and thumb grip offer a surprising amount of stability, while the included sheath offers secure storage.

OVERALL LENGTH:	2.0"
WEIGHT:	.27 OZ
SHEATH:	INCLUDED
HANDLE:	6061 T6 ALUMINUM
BLADE:	7CR17MOV



BOX	30-001083	FINE EDGE/DROP POINT	PREMIUM LEATHER SHEATH
BOX	30-001082	FINE EDGE/GUT HOOK	PREMIUM LEATHER SHEATH

BLISTER	31-001695	FINE EDGE	KEYCHAIN RING ON SHEATH
---------	-----------	-----------	-------------------------

GDC MONEY CLIP™

Slim, portable, and holding up to five credit cards in the clip, this tool also contains a discreet 1.75 inch fine edge blade. Easily stored in your pocket and simple to deploy, this tool is seamlessly integrated into any daily task.

BLADE LENGTH:	1.7"
WEIGHT:	2.9 OZ
BODY:	TITANIUM-COATED STEEL BODY
SHEATH:	INCLUDED
BLADE:	7CR17MOV



BLISTER	31-002521	FINE EDGE	SHEATH HOLDS 5 CREDIT CARDS
	30-000883	FINE EDGE	SHEATH HOLDS 5 CREDIT CARDS

GHOSTRIKE® SERIES FIXED BLADE KNIFE / DELUXE KIT



This ultra-light self defense knife has a customizable sheath system that offers low profile or open carry. The fine edge blade is made of durable 420HC steel, a compact skeletal frame keeps it light in hand, and a rubber overmold gives optimal grip.

BLADE LENGTH:	3.3"
WEIGHT:	[W/ SHEATH] 3.6 OZ
	[W/ ANKLE WRAP] 6.0 OZ
SHEATH:	INCLUDED
HANDLE:	RUBBERIZED DIAMOND-TEXTURE GRIP
BLADE:	420HC
	[CERAMIC COATED BLADE]



"This is a well thought-out package that serves the needs of everyone from the foot patrol officer to the undercover bicyclist."

★★★★★

PHILLIP DERUNTZ, COMMISSIONER



31-002720 / 30-001006
sheath + neoprene ankle strap
Neoprene Ankle Strap Made in China

BLISTER	31-002719	FINE EDGE/DROP POINT	MODULAR GLASS-FILLED NYLON SHEATH
BOX	30-001005	FINE EDGE/DROP POINT	MODULAR GLASS-FILLED NYLON SHEATH
BLISTER	31-002720	FINE EDGE/DROP POINT	MODULAR GLASS-FILLED NYLON SHEATH W/ NEOPRENE ANKLE WRAP
BOX	30-001006	FINE EDGE/DROP POINT	MODULAR GLASS-FILLED NYLON SHEATH W/ NEOPRENE ANKLE WRAP

GHOSTRIKE® SERIES PUNCH KNIFE

This skeletonized t-handle fixed blade is designed for self-defense situations. A rubberized handle gives superior control for the 420HC steel blade. The glass-filled nylon sheath can be strung around the neck or worn on a tactical belt for access.

BLADE LENGTH:	2.5"
WEIGHT:	3.6 OZ
LANYARD:	550 CORD
SHEATH:	INCLUDED
HANDLE:	RUBBERIZED DIAMOND-TEXTURE GRIP
BLADE:	420HC STEEL [CERAMIC COATED BLADE]



GUARDIAN BACK-UP®

This professional fixed blade knife is built for self defense. Featuring a non-reflective black blade coating, this agile knife is stealth. The compact design and double edge blade make it extremely versatile, an adjustable tension sheath can be individually customized.

BLADE LENGTH:	3.4"
WEIGHT:	3.0 OZ
	TANTO: 3.4 OZ
SHEATH:	INCLUDED
HANDLE:	TACHIDE™
BLADE:	HIGH CARBON STAINLESS



45803 / 05803
sheath



31-000559
sheath
Sheath Made
in China

BLISTER BOX	31-002721 30-001007	FINE EDGE/DROP POINT FINE EDGE/DROP POINT	GLASS-FILLED NYLON SHEATH W/ 550 CORD FOR NECK CARRY GLASS-FILLED NYLON SHEATH W/ 550 CORD FOR NECK CARRY
-------------	------------------------	--	--

BLISTER BOX	45803 05803	FINE EDGE/DOUBLE BEVEL FINE EDGE/DOUBLE BEVEL	ADJUSTABLE TENSION MOLDED PLASTIC SHEATH ADJUSTABLE TENSION MOLDED PLASTIC SHEATH
BLISTER	31-000559	SERRATED/TANTO	ADJUSTABLE TENSION MOLDED PLASTIC SHEATH

LMF™ II

Field tested with American troops, this 10 inch survival knife was engineered in partnership with our country's bravest. This MOLLE-compatible knife is rugged and versatile, with a partially serrated blade that can also serve as pommel or a spear. The sheath includes a built-in blade sharpener.

BLADE LENGTH:	4.8"
WEIGHT:	11.0 OZ
SHEATH:	INCLUDED
HANDLE:	TACHIDE™
BLADE:	420HC



Infantry
sheath, strap
Sheath Made
in China



ASEK System + Survival
sheath, straps, strap cutter w/ sheath

"Outstanding knife."
★★★★★
KELLY DAMINER, OREGON



BOX	22-01400	SERRATED/DROP POINT	COYOTE BROWN	SHEATH, STRAPS, STRAP CUTTER W/ SHEATH (SURVIVAL)
BLISTER	22-41400	SERRATED/DROP POINT	COYOTE BROWN	SHEATH, STRAPS, STRAP CUTTER W/ SHEATH (SURVIVAL)
BOX	22-01629	SERRATED/DROP POINT	BLACK	SHEATH + STRAPS (INFANTRY)
BLISTER	22-41629	SERRATED/DROP POINT	BLACK	SHEATH + STRAPS (INFANTRY)
BOX	22-01463	SERRATED/DROP POINT	COYOTE BROWN	SHEATH + STRAPS (INFANTRY)
BLISTER	22-41463	SERRATED/DROP POINT	COYOTE BROWN	SHEATH + STRAPS (INFANTRY)
BOX	22-01626	SERRATED/DROP POINT	FG504 GREEN	SHEATH + STRAPS (INFANTRY)
BOX	22-01627G	SERRATED/DROP POINT	FG504 GREEN	SHEATH, STRAPS, STRAP CUTTER W/ SHEATH (ASEK)



MARK II™

First introduced in 1966, this combat knife has stood the test of time. Specifically designed for survival applications, the black oxide coated 420HC blade is double serrated. The die cast aluminum handle and well-placed bolsters give secure grip.

BLADE LENGTH:	6.5"
WEIGHT:	8.0 OZ
SHEATH:	INCLUDED
HANDLE:	ALUMINUM
BLADE:	420HC



Sheath Made
in China



BOX	22-01874	SERRATED/DOUBLE BEVEL	BLACK SHEATH + STRAPS
-----	----------	-----------------------	-----------------------

MOMENT™ FIELD DRESS KIT

This cleaning kit offers thorough and efficient field dressing, as well as cutting and quartering an animal. The two knife kit has two full tang blades, the larger with a gut hook feature. Both have a molded rubber handle for comfort and can be sheathed together.

BLADE LENGTH:	3.6" LARGE
	3.3" SMALL
WEIGHT:	9.6 OZ (KIT)
SHEATH:	INCLUDED
HANDLE:	NYLON CORE W/ RUBBER
	OVERMOLD
BLADE:	5CR15MOV



BLISTER 31-002218 FINE EDGE/LARGE GUT HOOK + SMALL DROP POINT POLYMER-LINED CLOTH SHEATH

MOMENT™ FIXED BLADE

For unmatched control and precision, this full tang fixed blade knife offers a balanced design and comfortable grip. The fine edge, drop point blade affords ultimate utility for hunting and camping tasks alike. Gut hook feature also available.

BLADE LENGTH:	3.6"
WEIGHT:	7.2 OZ
SHEATH:	INCLUDED
HANDLE:	NYLON CORE W/ RUBBER
	OVERMOLD
BLADE:	5CR15MOV



"Excellent balance and a great grip. The blade is just the right size for a multitude of chores from field dressing to bushcraft work."

★★★★★
TIRATORE, MINNESOTA

BLISTER 31-002197 FINE EDGE/DROP POINT POLYMER-LINED CLOTH SHEATH
BLISTER 31-002200 FINE EDGE/GUT HOOK POLYMER-LINED CLOTH SHEATH

MYTH® COMPACT FIXED BLADE

For unmatched control and precision, this compact full tang fixed blade knife offers a balanced design and comfortable grip. The smaller blade is perfect for detail work and the included sheath has a built-in sharpener to keep you on the move.

BLADE LENGTH:	3.3"
WEIGHT:	1.0 OZ
SHEATH:	INCLUDED
HANDLE:	TEXTURED RUBBER
BLADE:	7CR17MOV



BLISTER 31-001156 FINE EDGE/DROP POINT POLYMER SHEATH W/ INTEGRATED SHARPENER

MYTH® E-Z OPEN

With a lightweight body directly molded onto the full tang blade, this knife is ideal for long and clean upward cuts. A hard plastic ball overmold tip ensures you never puncture your game. Created for quick field dressing, a sheath with sharpener is included.

BLADE LENGTH:	3.5"
WEIGHT:	2.6 OZ
SHEATH:	INCLUDED
HANDLE:	TEXTURED RUBBER
BLADE:	7CR17MOV



BLISTER 31-001168 FINE EDGE POLYMER SHEATH W/ INTEGRATED SHARPENER

MYTH® FIELD DRESS KIT

This packable dual knife kit offers a complete field dressing solution, packaged together in a compact, puncture-proof sheath. A built-in carbide sharpener is included to keep you on the go and always ready.

BLADE LENGTH:	GUT HOOK: 3.75"
	SMALL DROP POINT: 3.25"
WEIGHT:	GUT HOOK: 4.9 OZ
	SMALL DROP POINT: 1.0 OZ
SHEATH:	INCLUDED
HANDLE:	TEXTURED RUBBER
BLADE:	7CR17MOV



MYTH® FIXED BLADE PRO

Designed by professional hunters and guides, this knife is a new standard. A full tang high-carbon stainless steel blade is anchored by a soft rubberized handle, allowing for safe, quick field dressing or camp tasks. The dual-lock sheath includes a built-in carbide sharpener.

BLADE LENGTH:	3.8"
WEIGHT:	4.7 OZ
SHEATH:	INCLUDED
HANDLE:	TEXTURED RUBBER
BLADE:	7CR17MOV



BLISTER 31-001159 FINE EDGE/GUT HOOK + SMALL DROP POINT POLYMER SHEATH W/ INTEGRATED SHARPENER

BLISTER 31-001092 FINE EDGE/DROP POINT POLYMER SHEATH W/ INTEGRATED CARBIDE SHARPENER
BLISTER 31-001095 FINE EDGE/GUT HOOK POLYMER SHEATH W/ INTEGRATED CARBIDE SHARPENER

PRODIGY™

Based on the award-winning LMF II, this smaller knife packs the same punch. The full tang 420HC American steel blade is beefy, coated with ceramic for corrosion resistance and reduced visibility. A friction lock, MOLLE-compatible sheath is included.

BLADE LENGTH:	4.8"
WEIGHT:	7.2 OZ
SHEATH:	INCLUDED
HANDLE:	TACHIDE™
BLADE:	420HC



*"I would trust this knife with my life.
Keep up the good work...."*

★★★★★

DAVID PRIDEMORE, SHERIFF



Sheath Made
in China

BLISTER	31-000558	SERRATED/TANTO POINT	CAMO NYLON SHEATH
BLISTER	22-41121	SERRATED/DROP POINT	BLACK SHEATH
BOX	22-01121	SERRATED/DROP POINT	BLACK SHEATH



RIVER SHORTY™

An excellent water sports knife, it meets the unique needs of rafting, paddling, and diving. A sturdy stainless steel blade, lightweight glass-filled nylon handle, and deliberately blunt tip ensure you can carry it on any number of watery excursions.

BLADE LENGTH:	3.0"
WEIGHT:	4.0 OZ
SHEATH:	INCLUDED
HANDLE:	GLASS-FILLED NYLON
BLADE:	420HC



BLISTER	31-002645	SERRATED / DOUBLE EDGE	GREEN W/ BLACK MOLDED PLASTIC SHEATH
BOX	30-000967	SERRATED / DOUBLE EDGE	BLACK W/ BLACK MOLDED PLASTIC SHEATH

BG PARACORD FIXED BLADE™

Offering maximum utility, this knife serves many purposes. A full tang blade partners with nearly 4 feet of paracord to give you added versatility when you are out in the wild. A lightweight, slim sheath has a removable clip to give added packing options.

BLADE LENGTH:	3.3"
WEIGHT:	5.8 OZ
SHEATH:	INCLUDED
HANDLE:	PARACORD
BLADE:	7CR17MOV STEEL



SILVER TRIDENT™

Built for Special Ops personnel, this knife has the most technically advanced handle on a combat knife. Resistant to heat, UV light, and chemicals, it never quits. The 154CM double-edged blade is heat treated for edge retention, flexibility, and strength.

BLADE LENGTH:	6.5"
WEIGHT:	8.0 OZ
SHEATH:	INCLUDED
HANDLE:	HYTREL®
BLADE:	154CM



"Pictures do not do the knife justice. You have to put one in your hands to really appreciate quality, feel and appearance... Thank you again."

★★★★★

TEDDY DELACERDA, RETIRED LAW ENFORCEMENT



BLISTER 31-001683 FINE EDGE / DROP POINT FULL TANG CONSTRUCTION 45" OF PARACORD MAKE UP THE HANDLE PADDING

BOX 06995 SERRATED / DOUBLE EDGE RESISTANT TO HEAT, UV LIGHT & CHEMICALS BLACK SHEATH + CORD

STEADFAST™

This knife is engineered for daily use, a stainless steel clip point blade is anchored in a full tang application. Tough and durable, the ergonomic handle has finger grooves for comfort. The nylon sheath includes a protective insert for storage.

BLADE LENGTH:	6.0"
WEIGHT:	11 OZ
SHEATH:	INCLUDED
HANDLE:	OVERMOLD
BLADE:	440A STEEL



BOX 22-01120 FINE EDGE / DROP POINT FULL TANG CONSTRUCTION ERGONOMIC CONTOURED HANDLE NYLON SHEATH

STRAP CUTTER™

With an innovative design that shields the cutting edge, this tool serves its purpose in emergency situations. The 420HC steel hook knife cuts through anything, the molded rubber grip and finger hole add stability, and a glass breaker wastes no time.

OVERALL LENGTH:	4.4"
WEIGHT:	5.4 OZ
SHEATH:	INCLUDED
HANDLE:	INJECTION MOLDED RUBBER GRIP
BLADE:	420HC



BOX	22-01943	SINGLE BEVEL W/ HOOK	FG504 GREEN	MOLDED PLASTIC SHEATH
BOX	30-000132	SINGLE BEVEL W/ HOOK	COYOTE BROWN	MOLDED PLASTIC SHEATH
BOX	22-01944	SINGLE BEVEL W/ HOOK	BLACK	MOLDED PLASTIC SHEATH



"Best seat belt cutter I've used, cuts through pants and boots."



JEFF, SEARCH & RESCUE MEDIC

NEW

STRONGARM™

With a full tang, 420HC steel blade and rubberized diamond-texture grip, this is a knife you can bet your life on. A MOLLE-compatible multi-mount sheath system offers optimal customization, keeping your knife ever at the ready in combat situations.

BLADE LENGTH:	4.8"
WEIGHT:	7.2 OZ
SHEATH:	INCLUDED
HANDLE: GLASS-FILLED NYLON W/ RUBBER	
BLADE:	420HC

"Gerber really hit it out of the park with this one! Put simply, this is one of the finest production knives I've ever owned."

★★★★★
DARREN, WASHINGTON

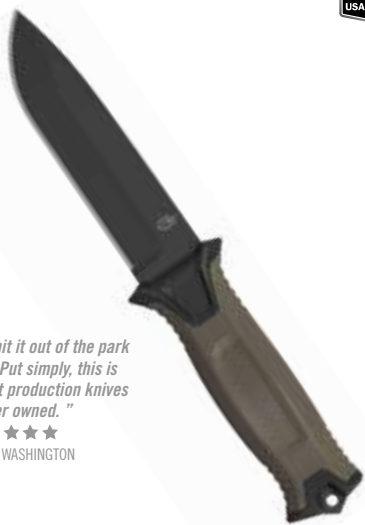

BG ULTIMATE KNIFE™

Loaded with innovations and backed by Bear, this knife has everything. The knife features a half serrated, drop point blade, a textured rubber grip, a steel pommel, and an emergency whistle. The durable sheath has a sharpener and a firestarter.

BLADE LENGTH:	4.8"
WEIGHT:	11.2 OZ
SHEATH:	INCLUDED
HANDLE:	TEXTURED RUBBER GRIP
BLADE:	HIGH CARBON STAINLESS

"This knife not only delivers, it excels."

★★★★★

KRIS BLOUCH, WILDERNESS PROFESSIONAL



Sheath + Fire Starter

BLISTER	31-002882	FINE EDGE/DROP POINT	FULL TANG	BLACK SHEATH
BOX	30-001038	FINE EDGE/DROP POINT	FULL TANG	BLACK SHEATH
BLISTER	31-002931	FINE EDGE/DROP POINT	FULL TANG	COYOTE BROWN SHEATH
BOX	30-001058	FINE EDGE/DROP POINT	FULL TANG	COYOTE BROWN SHEATH
BLISTER	31-002933	SERRATED/DROP POINT	FULL TANG	BLACK SHEATH
BOX	30-001060	SERRATED/DROP POINT	FULL TANG	BLACK SHEATH
BLISTER	31-002932	SERRATED/DROP POINT	FULL TANG	COYOTE BROWN SHEATH
BOX	30-001059	SERRATED/DROP POINT	FULL TANG	COYOTE BROWN SHEATH

BLISTER	31-001063	FINE EDGE/DROP POINT	SHEATH + FIRE STARTER
BLISTER	31-000751	SERRATED/DROP POINT	SHEATH + FIRE STARTER

BG ULTIMATE PRO FIXED BLADE

In the wild you need to depend on your knife. This full tang, fine edge fixed blade gives you peace of mind with a beefy rubberized handle and an oversized bolster, a military-grade sheath keeps it close at hand. Multiple survival features seal the deal.

BLADE LENGTH:	4.8"
WEIGHT:	13.7 OZ
SHEATH:	INCLUDED
HANDLE:	RUBBER OVERMOLD
BLADE:	9CR19MOV



Sheath + Fire Starter

BLISTER 31-001901 FINE EDGE/DROP POINT SHEATH + FIRE STARTER

BG ULTRA COMPACT FIXED BLADE™

The smallest version of Bear's favorite knife, this tool is light in weight not in function. A full tang blade, an ergonomic handle, a well-placed bolster, and a textured thumb rise provide a secure grip and ease of use. The paracord lanyard or sheath keep it nearby.

BLADE LENGTH:	3.3"
WEIGHT:	4.5 OZ
HANDLE:	MOLDED RUBBER
SHEATH:	INCLUDED
BLADE:	7CR17MOV



BLISTER 31-001516 FINE EDGE/DROP POINT SHEATH + LANYARD CORD

VITAL™ FIXED BLADE

Featuring one of the safest Exchange-A-Blade options out there, the surgically sharp blade cuts through game easily, requiring no extra tool if you need to replace the blade on the fly. The orange handle is easily spotted and a large finger choil adds stability.

BLADE LENGTH:	2.8"
WEIGHT:	1.6 OZ
HANDLE:	RUBBER OVERMOLD
BLADE:	#60 RAZOR REPLACEABLE



Sheath + Replacement Blades

BLISTER 31-003006 FINE EDGE/EXCHANGE-A-BLADE REPLACEMENT BLADES + SHEATH

VITAL™ SKIN AND GUT KNIFE

With a highly visual orange handle featuring intuitive finger grooves, this unique blade with adjoining gut hook affords the user unparalleled ease in dressing big game - saving body strain and time.

BLADE LENGTH:	2.6"
WEIGHT:	4.4 OZ
SHEATH:	INCLUDED
HANDLE:	RUBBER OVERMOLD



"I am very pleased with this product. I would recommend this to any average hunter."

★★★★★
GLENN KROWL



BLISTER 31-002743 FINE EDGE /GUT KNIFE CLOTH SHEATH

VITAL™ ZIP

Featherlight and portable, this innovative tool was designed for gaining fast, easy access to whatever your day brings you. An efficient slicing tool with a high carbon stainless steel utility blade and comfortable finger hole, this tool's versatility is unmatched.

BLADE:	STANDARD UTILITY BLADE
WEIGHT:	2.4 OZ
SHEATH:	INCLUDED
HANDLE:	RUBBER OVERMOLD



Sheath + Replacement Blades

BLISTER 31-002745 FINE EDGE/STANDARD UTILITY DROP POINT CLOTH SHEATH

WARRANT™

Slim. Lightweight. Black. This discreet knife features a partially serrated, tanto blade that is ideal for tactical and survival applications. The machined aluminum handle is light in hand to reduce strain, the snap closure sheath ensures your knife is always nearby.

BLADE LENGTH:	4.5"
WEIGHT:	5.4 OZ
SHEATH:	INCLUDED
HANDLE:	ALUMINUM
BLADE:	5CR15MOV



"I have one of these and it is on the front of my go bag at all times. This is the knife that I chose to take with me to hell and back and it has served in that role perfectly. It has ridden with me on every mission I have done over here in Afghanistan and continues to stay sharp and at the ready. When I look for something that can be counted on no matter what, I look to Gerber."

★★★★★

ALEXANDER, UH60 BLACKHAWK CREW CHIEF

BLISTER 31-000560 SERRATED/TANTO LINED DIGITAL CAMO SHEATH W/ LEG STRAPS

Ø6 F.A.S.T.™

Tough and ever at the ready, this knife was developed to confidently handle tactical situations. The tanto blade is deployed at lightning speed with the F.A.S.T. opening mechanism, while the textured G-1Ø composite handle keeps the knife securely in hand.

BLADE LENGTH:	3.8"
WEIGHT:	5.7 OZ
HANDLE:	G-1Ø COMPOSITE



BLISTER	31-ØØØ216	SERRATED/TANTO	ASSISTED OPENING W/ SIDE LOCK & SAFETY
BOX	3Ø-ØØØ118	SERRATED/TANTO	ASSISTED OPENING W/ SIDE LOCK & SAFETY

ANSWER™ F.A.S.T.

Developed to provide lightning-fast access to a blade when most needed, this knife is a tactical innovator. Dual thumbstuds operate in conjunction with a smart safety-slide lock to offer an intuitive ease of utility, while the sturdy tanto blade solves problems in a snap.

BLADE LENGTH:	3.3"
WEIGHT:	4.9 OZ
HANDLE:	ANODIZED ALUMINUM W/ TEXTURED INLAY



BLISTER	22-4197Ø	SERRATED/TANTO	ASSISTED OPENING W/ SIDE LOCK & SAFETY
---------	----------	----------------	--

ANSWER™ F.A.S.T. SM

The thoughtfully designed smaller sibling, this knife provides reliably quick access to a drop point, fine edge blade that handles jobs big and small with ease. All the knife you need, in a compact 2.6 ounce package.

BLADE LENGTH:	2.8"
WEIGHT:	2.6 OZ
HANDLE:	ANODIZED ALUMINUM W/ TEXTURED INLAY



BLISTER	31-000578	FINE EDGE/DROP POINT	ASSISTED OPENING W/ SIDE LOCK & SAFETY
---------	-----------	----------------------	--

APPLEGATE-FAIRBAIRN™ COVERT F.A.S.T.

Backed by the speed of F.A.S.T. technology, this knife is designed to partner quick deployment with reliable ease of use. The tough titanium coated blade teams up with a superior G-10 composite handle to provide the ultimate tool for any task.

BLADE LENGTH:	3.7"
WEIGHT:	4.9 OZ
HANDLE:	G-10 COMPOSITE



BLISTER	22-41966	SERRATED	ASSISTED OPENING W/ SIDE LOCK & SAFETY
BOX	22-01966	SERRATED	ASSISTED OPENING W/ SIDE LOCK & SAFETY

APPLEGATE-FAIRBAIRN™ MINI COVERT F.A.S.T.

Backed by the speed of F.A.S.T. technology, this compact knife is designed to partner quick deployment with reliable ease of use. The tough titanium coated blade teams up with a superior G-10 composite handle, proving that size isn't always everything.

BLADE LENGTH:	2.9"
WEIGHT:	3.2 OZ
HANDLE:	G-10 COMPOSITE



BLISTER BOX	22-41967	SERRATED	ASSISTED OPENING W/ SIDE LOCK & SAFETY
BOX	22-01967	SERRATED	ASSISTED OPENING W/ SIDE LOCK & SAFETY

CONTRAST™ AO

With superior materials and a utilitarian design, this knife easily bridges the gap between function and style. The F.A.S.T. 2.0 mechanism ensures one-hand deployment while the G-10 composite handle keeps the knife securely in hand.

BLADE LENGTH:	3.0"
WEIGHT:	3.3 OZ
HANDLE:	G-10 COMPOSITE & 3CR13 STEEL



"Absolutely great knife. Had it for over a year used it in about every condition and no rust, no faults, nothing."

★★★★

EZEKIEL, ILLINOIS

BLISTER BOX	31-002269	SERRATED/DROP POINT	ASSISTED OPENING W/ PLUNGE LOCK
BLISTER BOX	30-000784	SERRATED/DROP POINT	ASSISTED OPENING W/ PLUNGE LOCK
BLISTER BOX	31-001711	FINE EDGE/DROP POINT	ASSISTED OPENING W/ PLUNGE LOCK
BOX	30-000643	FINE EDGE/DROP POINT	ASSISTED OPENING W/ PLUNGE LOCK

F.A.S.T. DRAW™

As Gerber's first assisted opening knife produced, this knife inspired innovation and helped to define a brand. The lightning-quick opening mechanism is still employed today, yet the classic, functional design is all its own.

BLADE LENGTH:	3.0"
WEIGHT:	3.6 OZ
HANDLE:	GLASS-FILLED NYLON



*"The assisted opening is smooth
and also quiet."*



ANT MAN, PENNSYLVANIA

BLISTER	22-47162	FINE EDGE/DROP POINT	ASSISTED OPENING W/ SIDE LOCK & SAFETY
BOX	22-07162	FINE EDGE/DROP POINT	ASSISTED OPENING W/ SIDE LOCK & SAFETY
BLISTER	22-47161	SERRATED/DROP POINT	ASSISTED OPENING W/ SIDE LOCK & SAFETY
BOX	22-07161	SERRATED/DROP POINT	ASSISTED OPENING W/ SIDE LOCK & SAFETY

F.A.S.T. DRAW™ TANTO

The evolution of the knife that inspired innovation and helped define a brand, this tanto blade version features the lightning-quick F.A.S.T. 2.0 opening mechanism. Sturdy thumbstuds make one-hand opening a cinch, while the reliable plunge lock secures the blade in use and storage.

BLADE LENGTH:	3.0"
WEIGHT:	3.6 OZ
HANDLE:	GLASS-FILLED NYLON



BLISTER	31-001751	SERRATED/TANTO	ASSISTED OPENING W/ PLUNGE LOCK
---------	-----------	----------------	---------------------------------

MINI F.A.S.T. DRAW™

Extremely capable and the perfect everyday companion, this miniature version offers the same quick, reliable deployment and functional design as the original. Safety focused and portable, this knife handles daily tasks with ease.

BLADE LENGTH:	2.1"
WEIGHT:	1.9 OZ
HANDLE:	GLASS-FILLED NYLON



BLISTER	22-41526	FINE EDGE/DROP POINT	ASSISTED OPENING W/ SIDE LOCK & SAFETY
BLISTER	22-41525	SERRATED/DROP POINT	ASSISTED OPENING W/ SIDE LOCK & SAFETY

MINI F.A.S.T. DRAW™ TANTO

The compact evolution of the knife that inspired innovation and helped define a brand, this tanto blade version features the lightning-quick F.A.S.T. 2.0 opening mechanism. Sturdy thumbstuds make one-hand opening a cinch, while the reliable plunge lock secures the blade in use and storage.

BLADE LENGTH:	2.1"
WEIGHT:	1.9 OZ
HANDLE:	GLASS-FILLED NYLON



BLISTER	31-001753	FINE EDGE/TANTO	ASSISTED OPENING W/ PLUNGE LOCK
---------	-----------	-----------------	---------------------------------

FULLBACK™

A workhorse to tackle any job, this knife features a sturdy 3.25 mm thick Wharncliffe blade partnered with a hefty, durable handle for comfort in hand. Quick deployment comes from the F.A.S.T. 2.0 mechanism, anchored by both a plunge lock and a cross bolt safety feature when in use.

BLADE LENGTH:	2.8"
WEIGHT:	3.4 OZ
HANDLE:	GLASS-FILLED NYLON
BLADE:	7CR17MOV



BLISTER 31-003011 FINE EDGE/DROP POINT ASSISTED OPENING W/ PLUNGE LOCK & SAFETY

INSTANT™

Tactically inspired yet ideal for everyday use, this knife is designed to fit comfortably in hand and pocket. An ultra-light design partners with a powerful opening mechanism and a G-10 composite handle for unrivaled stability and ease of use. The ball-bearing pivot feature delivers a smooth opening.

BLADE LENGTH:	3.2"
WEIGHT:	4.0 OZ
HANDLE:	G-10 COMPOSITE



BLISTER 31-002184 SERRATED/DROP POINT ASSISTED OPENING W/ PLUNGE LOCK
BOX 30-000752 SERRATED/DROP POINT ASSISTED OPENING W/ PLUNGE LOCK

OUTRIGGER™

Designed to be your reliable daily carry knife, the Outrigger blends together thoughtful design elements and Gerber ingenuity. Lean in design but not in function, this knife is always ready with a lightning quick opening mechanism, a safe plunge lock, and a grippy handle texture.

BLADE LENGTH:	3.0"
WEIGHT:	2.0 OZ
HANDLE:	ALUMINUM W/ RUBBER OVERMOLD



BLISTER	31-001761	FINE EDGE/DROP POINT	ASSISTED OPENING W/ PLUNGE LOCK
BOX	30-000689	FINE EDGE/DROP POINT	ASSISTED OPENING W/ PLUNGE LOCK
BLISTER	31-001944	SERRATED/DROP POINT	ASSISTED OPENING W/ PLUNGE LOCK
BOX	30-000707	SERRATED/DROP POINT	ASSISTED OPENING W/ PLUNGE LOCK

OUTRIGGER™ XL

The big brother of your daily carry knife, this knife blends together thoughtful design elements and Gerber ingenuity. The larger profile affords more cutting surface as well as added comfort for bigger hands; this knife was built to handle the tough jobs.

BLADE LENGTH:	3.4"
WEIGHT:	2.5 OZ
HANDLE:	ALUMINUM W/ RUBBER OVERMOLD



"Great knife, nice and sharp right out of the box. The quality of this knife is why I chose and continue to choose Gerber knives."

★★★★★
BOBBY ASHLEY

BLISTER	31-001763	SERRATED/DROP POINT	ASSISTED OPENING W/ PLUNGE LOCK
BOX	30-000690	SERRATED/DROP POINT	ASSISTED OPENING W/ PLUNGE LOCK

MINI OUTRIGGER™

The miniature version of your daily carry knife, this knife blends together thoughtful design elements and Gerber ingenuity. Virtually weightless but big on ability, it is always ready with a lightning quick opening mechanism, a safe plunge lock, and a grippy handle texture.

BLADE LENGTH:	2.5"
WEIGHT:	1.3 OZ
HANDLE:	ALUMINUM W/ RUBBER OVERMOLD



BLISTER BOX	31-001759 30-000688	FINE EDGE/DROP POINT FINE EDGE/DROP POINT	ASSISTED OPENING W/ PLUNGE LOCK ASSISTED OPENING W/ PLUNGE LOCK
-------------	------------------------	--	--

PROPEL™ AO

Developed to serve military and law enforcement, this tactical addition is a knife you can bet your life on. Premium design offers a stealth black oxide 420HC steel blade, a grippy G-10 composite handle, and innovative blade deployment that keeps safety front of mind.

BLADE LENGTH:	3.5"
WEIGHT:	4.3 OZ
HANDLE:	G-10 COMPOSITE
BLADE:	BLACK 420HC DOWNRANGE S30V



"Excellent tool!!! Used during force on force and gunnery in both wet and dry conditions and performs like a champ every time. I have been using Gerber tools for a long time and this is by far the best tool so far I've used."

★★★★★

RAUL C5, ACTIVE DUTY

BOX	30-000840	SERRATED/TANTO	BLACK	420HC	ASSISTED OPENING W/ PLUNGE LOCK & SAFETY
BOX	30-000841	SERRATED/TANTO	DOWNRANGE	S30V	ASSISTED OPENING W/ PLUNGE LOCK & SAFETY



SKYRIDGE™

The unique design and color will grab your attention, the advanced engineering and comfort in hand will hold it. The generous handle is a sturdy base for the smooth one-hand blade deployment, while the muscular drop point blade gives maximum utility for any task.

BLADE LENGTH:	3.3"
WEIGHT:	4.8 OZ
HANDLE:	GLASS-FILLED NYLON
BLADE:	7CR17MOV



"VERY SOLID KNIFE. THE ASSISTED OPENER IS QUICK AND PRECISE."

★★★★

DAVE, MONTANA

BG SURVIVAL™ AO

Featuring the F.A.S.T. 2.0 assisted opening technology, the partially serrated blade deploys quickly when your life depends on it. With both a plunge lock and a safety lock, this knife is safe in use and in pocket.

BLADE LENGTH:	3.0"
WEIGHT:	3.3 OZ
HANDLE:	TEXTURED RUBBER GRIP
BLADE:	7CR17MOV



BLISTER 31-002856 FINE EDGE/DROP POINT ASSISTED OPENING W/ PLUNGE LOCK & SAFETY

BLISTER 31-002530 SERRATED/DROP POINT ASSISTED OPENING W/ PLUNGE LOCK & SAFETY

SWAGGER™ AO

When being prepared is paramount, the Swagger AO is the everyday tactical blade for the job. With silky-smooth deployment anchored by a reliable plunge lock, the partially serrated blade confidently takes on any task.

BLADE LENGTH:	3.3"
WEIGHT:	2.8 OZ
HANDLE:	G-1Ø COMPOSITE



MINI SWAGGER™ AO

When space is at a premium, this smaller version keeps you prepared without sacrificing function. With silky-smooth deployment anchored by a reliable plunge lock, the 2.8 inch blade confidently takes on any task.

BLADE LENGTH:	2.8"
WEIGHT:	1.8 OZ
HANDLE:	G-1Ø COMPOSITE



"This is one of the best knives I've ever had in my hand! I have been carting a knife in my pocket for ten years, and it is hard to impress me with a knife, but when I find one that works like it says its supposed to, and a company that will back it up, you've got my business for life."

★★★★

SCOTT HENDRICKS, CARPENTER

BLISTER BOX	31-ØØ17Ø9 3Ø-ØØØ642	SERRATED/DROP POINT SERRATED/DROP POINT	ASSISTED OPENING W/ PLUNGE LOCK & SAFETY ASSISTED OPENING W/ PLUNGE LOCK & SAFETY
-------------	------------------------	--	--

BLISTER BOX	31-ØØ17Ø5 3Ø-ØØØ641	FINE EDGE/DROP POINT SERRATED/DROP POINT	ASSISTED OPENING W/ PLUNGE LOCK & SAFETY ASSISTED OPENING W/ PLUNGE LOCK & SAFETY
-------------	------------------------	---	--

VENTURE™

Sleek function and modern design define the polished Venture, the perfect pocket companion. Featuring true one-hand engagement, a spring-assisted blade rotates on a ball-bearing pivot for smooth deployment. A sturdy titanium handle and thumb plunge lock keep the blade secure in and out of use.

BLADE LENGTH:	3.3"
WEIGHT:	4.2 OZ
HANDLE:	TITANIUM
BLADE:	7CR17MOV



BLISTER BOX	31-001021 30-000405	SERRATED/DROP POINT SERRATED/DROP POINT	ASSISTED OPENING W/ PLUNGE LOCK ASSISTED OPENING W/ PLUNGE LOCK
-------------	------------------------	--	--



NEW

Ø6 AUTOMATIC™

Fully automatic and ready for anything, this knife has a premium design that sets it apart. With a corrosion resistant S30V steel blade anchored by an oversize blade release button, a strikingommel, and a lanyard hole - you are never unprepared.

BLADE LENGTH:	3.8"
WEIGHT:	6.3 OZ
HANDLE:	ANODIZED ALUMINUM
BLADE:	S30V

Credentials required.

"In 2ØØ6, during combat operations in Iraq, this knife was issued to my platoon. 4 combat deployments later and she's still holding on strong. This is my favorite knife by far! I am going on 1Ø years with her and I haven't had one complaint."

★★★★★

RG Ø311, US ARMY



BOX 3Ø-ØØØ377	SERRATED/DROP POINT	CORROSION RESISTANT	STRIKING POMMEL	OVERSIZE BLADE RELEASE BUTTON
BOX 3Ø-ØØØ85Ø	SERRATED/TANTO	CORROSION RESISTANT	STRIKING POMMEL	OVERSIZE BLADE RELEASE BUTTON
BOX 3Ø-ØØØ193	SERRATED/TANTO G-1Ø	CORROSION RESISTANT	STRIKING POMMEL	OVERSIZE BLADE RELEASE BUTTON
BOX 3Ø-ØØ1295	FINE EDGE/DROP POINT	STRIKING POMMEL	OVERSIZE BLADE RELEASE BUTTON	NEW
BOX 3Ø-ØØ1297	FINE EDGE/TANTO	STRIKING POMMEL	OVERSIZE BLADE RELEASE BUTTON	NEW
BOX 3Ø-ØØ1296	FINE EDGE/TANTO G-1Ø	STRIKING POMMEL	OVERSIZE BLADE RELEASE BUTTON	NEW

**APPLEGATE-FAIRBAIRN™ COVERT AUTOMATIC**

An evolution of the best-in-class Applegate-Fairbairn folder, this knife features a spring-loaded auto release that deploys at the touch of a button. With premium S30V steel and a perfectly balanced design, this tactical folder is a sure favorite.

BLADE LENGTH:	3.8"
WEIGHT:	5.Ø OZ
HANDLE:	ANODIZED ALUMINUM
BLADE:	S30V

Credentials required.

"This is possibly the best blade I've ever carried on or off duty. It is light weight, very concealable and opens quickly."

★★★★★

"BLUTO", LE NARCOTICS



BOX 3Ø-ØØØ137	SERRATED/DROP POINT	SPRING LOADED AUTO RELEASE	S30V STEEL BLADE
---------------	---------------------	----------------------------	------------------

APPLEGATE-FAIRBAIRN™ MINI COVERT AUTOMATIC

An evolution of the best-in-class Applegate-Fairbairn folder, this compact version features a spring-loaded auto release that deploys at the touch of a button. With premium S30V steel and a perfectly balanced design, this discreet folder is a sure favorite.

BLADE LENGTH:	2.8"
WEIGHT:	2.1 OZ
HANDLE:	ANODIZED ALUMINUM
BLADE:	S30V



D.M.F.™ [DUAL MULTI FUNCTION] AUTOMATIC

DMF stands for Dual Multi Function, perfectly fitting for this auto knife that springs into action ambidextrously. The robust design features a G-10 composite handle, beefy S30V tanto blade, and a striking pommel for emergencies, keeping you ever at the ready.

BLADE LENGTH:	3.5"
WEIGHT:	8.5 OZ
HANDLE:	G-10 COMPOSITE
BLADE:	S30V

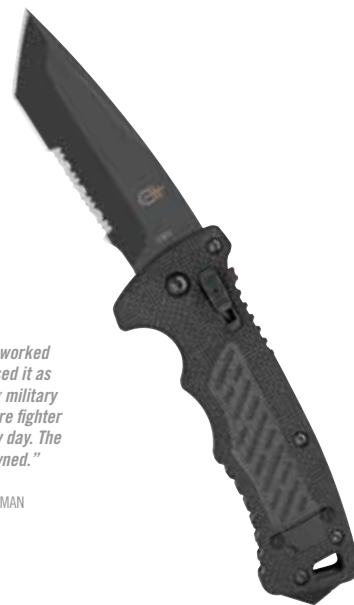

"The DMF auto folder has worked perfectly for me, I have used it as a back up while conducting military law enforcement and as a fire fighter now, i carry it with me every day. The best knife i have ever owned."



CHUCK , DAMAGE CONTROLMAN

BOX 30-000244 SERRATED/DROP POINT SPRING LOADED AUTO RELEASE S30V STEEL BLADE

BOX 30-000190 SERRATED/TANTO G-10 COMPOSITE HANDLE S30V STEEL BLADE STRIKING POMMEL

EMERSON ALLIANCE™ AUTOMATIC

Built for the demands of the tactical user, this knife offers fully automatic deployment, a stealth black oxide-coated 154CM blade, and a 6061-T6 anodized aluminum handle.

BLADE LENGTH:	3.4"
WEIGHT:	6.0 OZ
HANDLE:	ANODIZED ALUMINUM
BLADE:	154CM



PROPEL™ AUTOMATIC

Durable, fast to deploy, and rugged. This knife is a one-hand opening workhorse with a 420HC tanto blade that can cut through anything; the black oxide coating and G-10 composite handle minimize slip to keep you safe in critical conditions.

BLADE LENGTH:	3.5"
WEIGHT:	4.3 OZ
HANDLE:	G-10 COMPOSITE
BLADE:	DOWNRANGE: S30V
	BLACK: 420HC



"Love this knife. Quality lock-up, feel, and comfortable to control. Extremely easy to deploy the blade with gloves on."

★★★★★

UNNAMED, USAF SPECIAL OPERATIONS

BOX	22-07158	SERRATED/DROP POINT	BLACK OXIDE COATED 154CM BLADE
-----	----------	---------------------	--------------------------------

BOX	30-000717	SERRATED/TANTO	DOWNRANGE	G-10 COMPOSITE HANDLE
BOX	30-000842	SERRATED/TANTO	BLACK	G-10 COMPOSITE HANDLE

Ø6 COMBAT FOLDER™

American made and ready for anything, this knife has a premium design that sets it apart. With a corrosion resistant S30V steel drop point blade anchored by a sturdy plunge lock, a striking pommel, and a reversible pocket clip you are never unprepared.

BLADE LENGTH:	3.8"
WEIGHT:	8.6 OZ
HANDLE:	ALUMINUM
BLADE:	S30V



AIRFOIL™

A sleek and modern design make the Airfoil a fashionable addition. The aluminum handle adds nearly no weight for effortless opening and comfortable ease of use. A smartly ribbed spine and a refined drop point blade add functional value.

BLADE LENGTH:	2.7"
WEIGHT:	2.2 OZ
HANDLE:	ALUMINUM



BOX	30-000308	SERRATED/DROP POINT	REVERSIBLE POCKET CLIP [OPTIONAL CARRY]
BOX	30-000462	FINE EDGE/DROP POINT	REVERSIBLE POCKET CLIP [OPTIONAL CARRY]

BLISTER	31-002825	FINE EDGE/DROP POINT	T-SHAPED DUAL THUMBSTUDS
---------	-----------	----------------------	--------------------------

AIR RANGER™

A distinctively different every day carry, this elegant folder features a black G-10 composite handle that offers superior grip for deployment and use. Dual thumb studs afford ambidextrous one-hand deployment and a liner lock keeps the blade steadily in place.

BLADE LENGTH:	3.3"
WEIGHT:	2.6 OZ
HANDLE:	G-10 COMPOSITE



BLISTER 31-002950 FINE EDGE/DROP POINT BLACK G-10

AIR RANGER™

This elegant folder is a sophisticated addition to any pocket, the unique handle features a crosshatch pattern etched on aluminum for steadiness. Dual thumbstuds deploy the partially serrated blade, a pocket clip cleanly keeps it tethered nearby.

BLADE LENGTH:	3.3"
WEIGHT:	2.6 OZ
HANDLE:	ALUMINUM



BLISTER 45860 SERRATED/CLIP POINT ONE-HAND OPENING

APPLEGATE-FAIRBAIRN™ COVERT

Leading the ranks of the best-in-class tactical folding knives, the Covert has earned a reputation for strength, durability, and balance. The 154CM steel blade, glass-filled nylon handle, and patented rotolock combine to make an unsurpassable tool.

BLADE LENGTH:	3.8"
WEIGHT:	4.2 OZ
HANDLE:	GLASS-FILLED NYLON
BLADE:	154CM

"Bought mine in the PX at Camp Victory in Baghdad 2004. Solid as a rock and is my everyday companion in my pocket. I'd buy another in a heartbeat if I ever lost this one."

★★★★★
ANDY C, IRAQ VET



APPLEGATE-FAIRBAIRN™ MINI COVERT

The compact version of the best-in-class tactical folding knife, this knife has the soul of the larger version in a portable size. The 154CM steel blade, glass-filled nylon handle, and patented rotolock combine to make an unsurpassable tool.

BLADE LENGTH:	2.9"
WEIGHT:	2.2 OZ
HANDLE:	GLASS-FILLED NYLON
BLADE:	154CM



BOX	05785	SERRATED/DOUBLE BEVEL	TITANIUM NITRIDE COATED BLADE	PATENTED ROTOLOCK MECHANISM
BLISTER	45786	SERRATED/DOUBLE BEVEL	TITANIUM NITRIDE COATED BLADE	PATENTED ROTOLOCK MECHANISM
BOX	05786	SERRATED/DOUBLE BEVEL	TITANIUM NITRIDE COATED BLADE	PATENTED ROTOLOCK MECHANISM

BLISTER	22-47177	SERRATED/DOUBLE BEVEL	TITANIUM NITRIDE COATING	LINER LOCK
BLISTER	46924	SERRATED/DOUBLE BEVEL	STAINLESS	LINER LOCK

AR™ [ALUMINUM RUBBER] 3.0

Designed as a dependable everyday carry, this knife is tailored, elegant, and offers a low profile in pocket. A partially serrated blade lends itself to an array of activities, while the mixture of an aluminum and rubber handle provides lightweight traction.

BLADE LENGTH:	3.0"
WEIGHT:	2.8 OZ
HANDLE:	ALUMINUM TACHIDE™



BLISTER	45864	SERRATED/DROP POINT	TITANIUM NITRIDE COATED BLADE
BOX	05849	SERRATED/DROP POINT	TITANIUM NITRIDE COATED BLADE
BOX	05848	FINE EDGE/DROP POINT	TITANIUM NITRIDE COATED BLADE

COHORT™

With a minimalist design to keep it light and discreet, this knife disappears in your pocket until needed. Dual thumbstuds offer quick, one-handed deployment of the 3 inch drop point blade. A liner lock holds the blade in place and requires little effort to close.

BLADE LENGTH:	3.0"
WEIGHT:	2.6 OZ
HANDLE:	ALUMINUM
BLADE:	7CR17MOV



"Great piece, good blade, lightweight, well balanced and super pocket for everyday use. Great for any activity!"

★★★★
MORPHOS, EXPLORER

BLISTER	31-003089	FINE EDGE/DROP POINT	DUAL THUMBSTUDS	LIGHTWEIGHT
BOX	30-001202	FINE EDGE/DROP POINT	DUAL THUMBSTUDS	LIGHTWEIGHT

CONTRAST™

Don't be fooled by this lightweight knife, it offers show-stopping style and high performance features. The combo G-10 composite and stainless steel handle give superior grip and unrivaled aesthetic. The frame lock is easy to use and keeps the profile slim.

BLADE LENGTH:	3.0"
WEIGHT:	3.2 OZ
HANDLE:	G-10 COMPOSITE
BLADE:	7CR17MOV



BLISTER BOX	31-000596	SERRATED/DROP POINT	G-10 COMPOSITE/STAINLESS STEEL HANDLE
BLISTER BOX	30-000259	SERRATED/DROP POINT	G-10 COMPOSITE/STAINLESS STEEL HANDLE
BLISTER BOX	31-000595	FINE EDGE/DROP POINT	G-10 COMPOSITE/STAINLESS STEEL HANDLE
BLISTER BOX	30-000258	FINE EDGE/DROP POINT	G-10 COMPOSITE/STAINLESS STEEL HANDLE

COUNTERPART™

A sleek combination of tactical styling and everyday carry features, this knife is stripped down to the bare essentials. The ultra-light G-10 composite handle is dependable in any condition, the finger flip opening is speedy, and the drop point blade never fails.

BLADE LENGTH:	3.0"
WEIGHT:	3.3 OZ
HANDLE:	G-10 COMPOSITE
BLADE:	7CR17MOV



BLISTER BOX	31-001719	FINE EDGE/DROP POINT	BLACK	INTEGRATED FINGER GUARD FOR ADDED PROTECTION
-------------	-----------	----------------------	-------	--

DECREE™

The S3ØV modified tanto blade provides superior piercing ability, easily accessed by the thumbstuds or finger flipper. Black ceramic protects the blade against corrosion; a glass-filled nylon, rubberized diamond texture handle is tough and easy to grip.

BLADE LENGTH:	3.7"
WEIGHT:	4.8 OZ
HANDLE:	RUBBERIZED DIAMOND-TEXTURE
BLADE:	S3ØV

"Excellent blade...
awesome folding knife."
★★★★★
OSVALDO



D.M.F.™ [DUAL MULTI FUNCTION]

DMF stands for Dual Multi Function, perfectly fitting for this folding knife that springs into action ambidextrously. The robust design features a G-1Ø composite handle, beefy S3ØV modified clip point blade, and a striking pommel for emergencies, keeping you ever at the ready.

BLADE LENGTH:	3.5"
WEIGHT:	6.2 OZ
HANDLE:	G-1Ø COMPOSITE
BLADE:	S3ØV



BLISTER	31-002718	SERRATED/MODIFIED TANTO	TEMPERED STEEL GLASS BREAKER
BOX	30-001004	SERRATED/MODIFIED TANTO	TEMPERED STEEL GLASS BREAKER

BLISTER	31-000582	SERRATED/MODIFIED CLIP POINT	MANUAL OPENING (NO SPRINGS)
BLISTER	31-000583	SERRATED/TANTO	MANUAL OPENING (NO SPRINGS)

E.A.B. [EXCHANGE-A-BLADE] LITE™

The Gerber Exchange-A-Blade pocket knife employs contractor grade utility blades that can easily be replaced, keeping you ready and on the go. A stainless steel body and liner lock construction keep this tool sturdy and stable while in use.

BLADE LENGTH: 1.5"
WEIGHT: 2.3 OZ
HANDLE: STAINLESS STEEL



"This knife is in my pocket everywhere I go. It's light weight and rugged. I can barely feel it in my pocket. It's perfect for what I do for a living. I move around a lot and need a blade at the drop of the dime. The blade screw makes things simple and handy. The swing arm is fluid and smooth. I would be lost without this little guy."

★★★★★

ADAM ARSENAULT, FURNITURE WORKER

BLISTER 31-000345 FINE EDGE/UTILITY BLADE CONTRACTOR-GRADE REPLACEABLE UTILITY BLADE

E.A.B. [EXCHANGE-A-BLADE]™

The Gerber Exchange-A-Blade pocket knife employs contractor grade utility blades that can easily be replaced, keeping you ready and on the go. A stainless steel body and liner lock construction keep this tool sturdy and stable while in use.

BLADE LENGTH: 1.5"
WEIGHT: 2.4 OZ
HANDLE: STAINLESS STEEL



BLISTER 22-41830 FINE EDGE/UTILITY BLADE USES STANDARD OR CONTRACTOR GRADE UTILITY BLADE

EDGE®

This utility knife is loaded with on-the-site features: a spring lock for easy press and release blade replacement, a pocket clip for easy carry, and an easily available utility blade. It is available with a rubber or anodized aluminum handle option.

BLADE LENGTH:	1.1"
WEIGHT:	ALUMINUM: 3.5 OZ
	TACHIDE™: 2.8 OZ
HANDLE:	TACHIDE™ OR ALUMINUM



BLISTER	31-000669	FINE EDGE/UTILITY BLADE	BLUE TACHIDE™ HANDLE
BLISTER	31-000668	FINE EDGE/UTILITY BLADE	BLACK TACHIDE™ HANDLE
BLISTER	31-000666	FINE EDGE/UTILITY BLADE	BLACK ALUMINUM HANDLE

EDICT™

Designed for soldiers and first responders, this tough knife has a full size, fine edge tanto blade for maximum piercing and slicing capabilities. The 154CM steel blade is anchored with a lock back design providing structural integrity in heavy-duty applications.

BLADE LENGTH:	3.6"
WEIGHT:	3.6 OZ
HANDLE:	RUBBERIZED DIAMOND-TEXTURE
BLADE:	154CM



BLISTER	31-002761	FINE EDGE/TANTO	BLACK
BOX	30-001020	FINE EDGE/TANTO	BLACK



EVO™

One of the lightest knives that Gerber makes, the EVO has multiple openings in the anodized aluminum handle. The fine edge blade is made of 7Cr17MoV steel to aid in corrosion resistance. The thumbstud and finger flipper allow for true one-handed opening and engagement.

BLADE LENGTH:	3.4"
	EVO JR: 2.8"
	EVO LARGE: 3.5"
	EVO MID: 3.1"
WEIGHT:	2.8 OZ
	EVO JR: 1.8 OZ
	EVO LARGE: 3.0 OZ
	EVO MID: 2.4 OZ
HANDLE:	ALUMINUM
BLADE:	7CR17MOV

"I have had this knife for over 5 years. I use it for countless jobs on and off duty. I carry it so much the black has worn off the handle so its mostly silver now. I have used it to jimmy locks, pry windows, break windows, cut everything you can think of. This knife has far outlasted much more expensive knives I have owned. This and a Gerber multitool are with me everywhere I go!!"

★★★★★
CHRIS, FIREFIGHTER/EMT



BLISTER	22-41432	SERRATED/DROP POINT	EVO
BLISTER	22-41433	FINE EDGE/DROP POINT	EVO
BLISTER	22-41492	FINE EDGE/DROP POINT	EVO JR
BLISTER	22-41493	SERRATED/DROP POINT	EVO JR
BLISTER	31-001755	SERRATED/TANTO	EVO LARGE
BOX	30-000656	SERRATED/TANTO	EVO LARGE
BLISTER	31-000486	SERRATED/TANTO	EVO MID

E-Z OUT™

Profoundly versatile and easy to use, this knife is meant to tackle your daily life. With a rugged polycarbonate handle that also has SoftGrip® inserts, this handle offers superior grip. Easily deploy the blade with a well-placed cutout, as the name suggests.

BLADE LENGTH:	DPSF: 3.5"
	JR: 2.4"
	RESCUE: 3.5"
	SKELETON: 3.5"
WEIGHT:	DPSF: 2.8 OZ
	JR: 1.4 OZ
	RESCUE: 2.4 OZ
	SKELETON: 2.6 OZ
HANDLE:	GLASS-FILLED NYLON W/ TACHIDE™ INLAY

"Great knife. I carry it every day at work. It can be hard to find a knife that is easy for a woman's hands. This one is easy to work with and easy to hold."

★★★★★
B.W., RANGER



DPSF version



Rescue version

BOX	22-01648G	SERRATED/BLACK BLADE	DPSF	S30V BLADE STEEL
BOX	22-01643G	SERRATED/SATIN BLADE	DPSF	S30V BLADE STEEL
BOX	06551	SERRATED	JR	
BOX	06501	FINE EDGE	JR	
BOX	06971	SERRATED	RESCUE	YELLOW HANDLE
BLISTER	06701	FINE EDGE/CLIP POINT	SKELETON	
BLISTER	46751	SERRATED/CLIP POINT	SKELETON	
BOX	06751	SERRATED/CLIP POINT	SKELETON	



HINDERER CLS™ [COMBAT LIFE SAVER]

Designed for tactical situations, Gerber adds the CLS model [Combat Life Saver]. The blade is made of 440A steel, coated in a stealth non-reflective black finish. The design also features a seat belt cutter, window punch, and oxygen tank wrench.

BLADE LENGTH:	3.5"
WEIGHT:	5.6 OZ
HANDLE:	GLASS-FILLED NYLON
BLADE:	7CR17MOV

"Shatters windows like a champ. Still cuts seatbelts with ease and the knife holds its edge really well. And you can't beat having an O2 wrench on hand when you need it."

★★★★★
RYAN LOPEZ, EMT



BLISTER BOX	22-41870 22-01870	SERRATED/FINE EDGE SERRATED/FINE EDGE	SAFETY HOOK CUTTER, WINDOW PUNCH + O ² TANK WRENCH SAFETY HOOK CUTTER, WINDOW PUNCH + O ² TANK WRENCH
-------------	----------------------	--	--

ICON™

Large. Stealth. Rugged. This tactical folder handles anything your day throws your way. With a 4.25 inch tanto blade that is held in place by a sturdy liner lock, you will never feel unprepared. Dual thumbstuds allow for accessible one-hand opening.

BLADE LENGTH:	4.3"
WEIGHT:	4.7 OZ
HANDLE:	ANODIZED ALUMINUM W/ TEXTURED INLAY
BLADE:	7CR17MOV



BLISTER BOX	31-000372	SERRATED/TANTO	DUAL THUMBSTUDS FOR ONE-HAND OPENING
-------------	-----------	----------------	--------------------------------------

KIOWA™

Fashioned after the namesake helicopter, this tactical folder takes no prisoners. The aggressively sculpted handle is ideal for comfort in defensive postures, the 3 inch tanto blade is stealthily effective, and the partially serrated blade offers versatile use.

BLADE LENGTH:	3.0"
WEIGHT:	3.4 OZ
HANDLE:	GLASS-FILLED NYLON
BLADE:	HIGH CARBON STAINLESS



"Got this knife for work a year ago ...This is the only knife to survive my daily use for a year straight. It's very tough and easy to sharpen. If it can survive constant use in a coal mine 6 days a week its a good EDC choice."



BRANDON, MINER

BLISTER 22-41405 SERRATED/TANTO ONE-HAND OPENING

MOMENT™ POCKET FOLDER

For unmatched control and precision, this folder offers a balanced design and comfortable grip. The fine edge, drop point blade affords ultimate utility for hunting and camping tasks alike.

BLADE LENGTH:	3.0"
WEIGHT:	2.5 OZ
HANDLE:	STEEL W/ RUBBER OVERMOLD
BLADE:	5CR15MOV



BLISTER 31-002215 FINE EDGE/DROP POINT GLASS BEAD BLADE FINISH FOR LOW REFLECTIVITY

MYTH® POCKET FOLDER

This folder is the compact counterpart to the Fixed Blade Pro, providing secure grip in any weather with its soft rubberized handle. The high carbon stainless steel blade is durable and lightweight, making quick work of game dressing in the field.

BLADE LENGTH:	3.0"
WEIGHT:	2.7 OZ
HANDLE:	TEXTURED RUBBER
BLADE:	7CR17MOV

"This is one of the best knives I have had the pleasure of using, and the fact that it is a well made knife like all Gerbers that I have used makes it even better!!! Buy one and enjoy."



TODD, GERBER KNIFE FAN



BLISTER	31-001088	FINE EDGE/DROP POINT	TEXTURED RUBBER HANDLE
---------	-----------	----------------------	------------------------

OBSIDIAN™

This knife is a multi-functional addition to your toolbox. A sturdy drop point blade is deployed by dual thumbstuds for one-hand opening, a plunge lock keeps the blade safely in use or storage. Also includes cross and flat head drivers, a file, and a bottle opener.

BLADE LENGTH:	3.0"
WEIGHT:	4.6 OZ
HANDLE:	GLASS-FILLED NYLON
BLADE:	44Ø STAINLESS



BLISTER	22-41021	FINE EDGE/DROP POINT	PHILLIPS & FLAT DRIVERS, FILE + BOTTLE OPENER
BOX	22-01021	FINE EDGE/DROP POINT	PHILLIPS & FLAT DRIVERS, FILE + BOTTLE OPENER
BLISTER	22-41022	SERRATED/DROP POINT	PHILLIPS & FLAT DRIVERS, FILE + BOTTLE OPENER

ORDER™

This American-made tactical folder is thoughtfully designed and lightweight for use over the long haul. A 420HC black ceramic-coated blade, rubberized diamond-texture handle, sturdy clip, and partially serrated blade ensure preparedness.

BLADE LENGTH:	3.1"
WEIGHT:	2.6 OZ
HANDLE:	RUBBERIZED DIAMOND-TEXTURE
BLADE:	420HC



BLISTER	31-002733	SERRATED/THUMB HOLE	LOCK BACK OPENING/CLOSING MECHANISM
BOX	30-001011	SERRATED/THUMB HOLE	LOCK BACK OPENING/CLOSING MECHANISM



PARAFRAME™

This lightweight everyday carry knife has an open frame that is the ultimate in minimalist design. Easy to clean, carry, and open, the Paraframe is an effortless addition to your pocket or belt clip. Available in multiple blade variations, this knife handles it all.

BLADE LENGTH:	TANTO: 2.9"
	NAIL NICK: 2.9"
	PARAFRAME I: 3.0"
	PARAFRAME II: 3.5"
WEIGHT:	TANTO: 2.9 OZ
	NAIL NICK: 2.6 OZ
	PARAFRAME I: 2.6 OZ
	PARAFRAME II: 4.3 OZ
HANDLE:	STEEL



BLISTER	31-001731	SERRATED/TANTO	PARAFRAME, TANTO	BLACK TITANIUM NITRIDE-COATED BLADE
BOX	30-000652	SERRATED/TANTO	PARAFRAME, TANTO	BLACK TITANIUM NITRIDE-COATED BLADE
BLISTER	22-48444	FINE EDGE/CLIP POINT	PARAFRAME I	
BOX	22-08444	FINE EDGE/CLIP POINT	PARAFRAME I	
BLISTER	22-48443	SERRATED/CLIP POINT	PARAFRAME I	
BLISTER	22-48446	FINE EDGE/CLIP POINT	PARAFRAME I	TITANIUM NITRIDE
BOX	22-08446	FINE EDGE/CLIP POINT	PARAFRAME I	TITANIUM NITRIDE
BLISTER	22-48445	SERRATED/CLIP POINT	PARAFRAME I	TITANIUM NITRIDE
BOX	22-08445	SERRATED/CLIP POINT	PARAFRAME I	TITANIUM NITRIDE
BLISTER	22-48448	FINE EDGE/CLIP POINT	PARAFRAME II	
BLISTER	22-48447	SERRATED EDGE/CLIP POINT	PARAFRAME II	
BLISTER	31-001734	FINE EDGE/TANTO	PARAFRAME II	TITANIUM NITRIDE

PARAFRAME™ MINI

This lightweight everyday carry knife has an open frame that is the ultimate in minimalist design. Easy to clean, carry, and open, the Paraframe is an effortless addition to your pocket or belt clip. Available in multiple blade variations, this knife handles it all.

BLADE LENGTH:	2.2"
	TANTO: 2.9"
WEIGHT:	1.4 OZ
	TANTO: 2.9 OZ
HANDLE:	GLASS-FILLED NYLON

"This knife exceeded my expectations! Been carrying it everyday since I bought it."

★★★★★

AARON, DESIGNER



BLISTER	22-48485	FINE EDGE/CLIP POINT	PARAFRAME MINI
BOX	22-08485	FINE EDGE/CLIP POINT	PARAFRAME MINI
BLISTER	22-48484	SERRATED/CLIP POINT	PARAFRAME MINI
BLISTER	31-001729	FINE EDGE/TANTO	PARAFRAME MINI
BOX	30-000651	FINE EDGE/TANTO	PARAFRAME MINI

BLACK TITANIUM NITRIDE-COATED BLADE

POWERFRAME™

A more aggressive take on the Paraframe, this knife has the same open frame design handle but adds an angular edge. The entire knife is titanium coated for corrosion resistance. A fine edge blade is successful with both detail work and tough jobs.

BLADE LENGTH:	3.0"
WEIGHT:	3.2 OZ
HANDLE:	STAINLESS STEEL

"This is a great little knife. I have had it for 6-7 years as a back up to my Applegate Folder and my DMF Auto. It also serves as my "gentlemen's" knife when in business casual attire. It is a great pocket knife, easy to sharpen, light weight, comfortable in your pocket, and keeps a decent edge. Its very easy and quick to deploy the blade, as well as easy to keep clean. It is one of my favorite knives."

★★★★★

OZZY, MILITARY ELECTRICIAN



BLISTER	22-41965	FINE EDGE/DROP POINT	TITANIUM COATED STAINLESS STEEL
BLISTER	22-41964	SERRATED/DROP POINT	TITANIUM COATED STAINLESS STEEL

PR™ 2.5

The ultimate in comfort, this pocket folder employs a revolutionary triple-injection overmold on the handle. The superiorly soft grip is ideal to use everyday, the sturdy liner lock secures the blade so you can. One-hand opening is a cinch with the thumb plate.

BLADE LENGTH:	2.5"
WEIGHT:	1.7 OZ
HANDLE:	GLASS-FILLED NYLON W/ TACHIDE™ INSERTS



BLISTER 22-41579 FINE EDGE/DROP POINT THUMB DIAL FOR ONE-HANDED OPENING

RAZORFISH™

Thoughtfully blending practical function and inspired design into one polished package, this knife springs into action with a finger flipper. A Wharncliffe style blade offers dual cutting edges, a stamped fish bone grooved handle lends a stylishly confident grip.

BLADE LENGTH:	2.8"
WEIGHT:	3.3 OZ
HANDLE:	ALUMINUM
BLADE:	7CR17MOV



BLISTER 31-003013 FINE EDGE/DROP POINT PARACORD CUTTER

REMIX™

The undeniable focus of the minimal design, the circular ring in the handle provides intrigue as well as additional stability while in use. With a corrosion resistant fine edge blade, the Remix is a surprisingly tough addition to your daily pocket.

BLADE LENGTH:	TACTICAL: 3.0"
	OPEN FRAME: 2.9"
WEIGHT:	TACTICAL: 4.6 OZ
	OPEN FRAME: 4.2 OZ
HANDLE:	TACTICAL: G-10 COMPOSITE
	OPEN FRAME ANODIZED ALUMINUM
BLADE:	TACTICAL 7CR17MOV



"This knife just feels like it's supposed to be in your hand."



RYAN FITZ, ALABAMA

Tactical version

BLISTER	31-001098	SERRATED/TANTO	REMIX TACTICAL	THUMB LIFT	LINER LOCK
BOX	30-000433	SERRATED/TANTO	REMIX TACTICAL	THUMB LIFT	LINER LOCK
BLISTER	22-41968	FINE EDGE/DROP POINT	OPEN FRAME DESIGN	THUMBSTUDS	LINER LOCK
BLISTER	22-41969	SERRATED/DROP POINT	OPEN FRAME DESIGN	THUMBSTUDS	LINER LOCK

MINI-REMIX™

The undeniable focus of the minimal design, the circular ring in the handle provides intrigue as well as additional stability while in use. With a corrosion resistant fine edge blade, the Remix is a surprisingly tough addition to your daily routine.

BLADE LENGTH:	2.1"
WEIGHT:	2.2 OZ
HANDLE:	STAINLESS STEEL & ANODIZED ALUMINUM



BLISTER	31-000346	FINE EDGE/DROP POINT	OPEN FRAME	THUMBSTUDS	FRAME LOCK
---------	-----------	----------------------	------------	------------	------------

RIDGE™

This pint-sized monster is the toughest ounce and half you will put in your pocket. A straight, non-stick stainless steel blade applies even cutting pressure, a smart liner lock keeps the blade secure. The open handle doubles as a money clip for added versatility.

BLADE LENGTH: 2.0"
WEIGHT: 1.4 OZ
HANDLE: STAINLESS STEEL



"Best knife I've ever had. For the past 6 or 7 years I've had one on my keychain and use it almost daily."

★★★★★
AARON, TEXAS

RIPSTOP™

With a super-lightweight frame lock design, this knife delivers surprising strength and functionality. The streamlined handle adds no bulk to the slim profile, making it the perfect mate for your pocket. Opening and closing are a cinch with dual thumbstuds.

BLADE LENGTH: RIPSTOP I: 2.3"
RIPSTOP II: 3.0"
WEIGHT: RIPSTOP I: 2.0 OZ
RIPSTOP II: 3.0 OZ
HANDLE: STAINLESS STEEL
BLADE: HIGH CARBON STAINLESS



"Bought this knife for camping but I found out it works perfect for me at work... I would recommend it to any one looking for a DURABLE knife"

★★★★★
JOSE, SUPERVISOR

BLISTER 45898 SERRATED/TANTO BLACK HANDLE DOUBLES AS MONEY CLIP FRAME LOCK

BLISTER	22-41614	FINE EDGE/DROP POINT	RIPSTOP I	DUAL THUMBSTUDS
BOX	22-01614	FINE EDGE/DROP POINT	RIPSTOP I	DUAL THUMBSTUDS
BLISTER	22-41613	SERRATED/DROP POINT	RIPSTOP I	DUAL THUMBSTUDS
BLISTER	22-41616	SERRATED/DROP POINT	RIPSTOP II	STURDY POCKET CLIP

SAFETY AUTO HOOK [S.A.H.]™

Built of American ingenuity, this versatile knife was designed for emergencies when every second counts. The 42ØHC modified drop point blade partners with an auto hook that deploys instantly to secure the situation. A premium G-1Ø composite handle offers superior stability.

BLADE LENGTH:	3.6"
WEIGHT:	6.7 OZ
HANDLE:	G-1Ø COMPOSITE
BLADE:	42ØHC



SB™ 2.5

When you need to travel light this knife won't weigh you down, literally. At only 1.6 ounces, the smart design features weight- reducing cutouts. Dual thumbstuds make easy work of opening the high carbon stainless steel blade.

BLADE LENGTH:	2.5"
WEIGHT:	1.6 OZ
HANDLE:	ALUMINUM



"Great pocket knife. Perfect size for the 5th pocket on jeans. Holds an edge well, good for boxes, packing straps, strapping tape, smaller ropes."

★★★★★
TOBIAS, MACHINIST/WELDER

BOX 3Ø-ØØØ185 SERRATED/MODIFIED DROP POINT AUTO HOOK - DEPLOYS W/ BUTTON AFTER RELEASING SAFETY

BLISTER 22-41535 FINE EDGE HIGH CARBON STEEL BLADE POCKET CLIP

BG SCOUT™

This survival knife for scouting is full of features to keep you safe. This lightweight portable folder offers a surprisingly tough drop point blade, ideal for cutting rope and edge retention. The rubber grip and lock back mechanism keep the blade in place.

BLADE LENGTH:	3.3"
WEIGHT:	2.6 OZ
HANDLE:	TEXTURED RUBBER



BLISTER	31-000754	SERRATED/DROP POINT	THIN AND LIGHTWEIGHT
BLISTER	31-002948	FINE EDGE/DROP POINT	DUAL THUMBSTUDS

SWAGGER™

This tactical folder is engineered to be stealthily effective, with a machine styled black blade and a matching G-10 composite handle. The drop point blade is partially serrated on the full size and fully fine edge on the miniature version, a sturdy frame lock adds confident application.

BLADE LENGTH:	SWAGGER: 3.3"
	MINI SWAGGER: 2.8"
WEIGHT:	SWAGGER: 4.4 OZ
	MINI SWAGGER: 2.9 OZ
HANDLE:	G-10 COMPOSITE



BLISTER	31-000594	SERRATED/DROP POINT	SWAGGER	G-10/STAINLESS STEEL HANDLE
BLISTER	31-000593	FINE EDGE/DROP POINT	MINI SWAGGER	G-10/STAINLESS STEEL HANDLE

TORCH™ I

When duty calls, you need to be prepared: the Torch I is always ready with textured glass-filled nylon inserts in the grippy handle. A matte black tanto blade is stealth and effective, easily opened with one hand courtesy of dual thumbstuds or a finger flipper.

BLADE LENGTH:	2.7"
WEIGHT:	3.2 OZ
HANDLE:	STAINLESS STEEL W/ GLASS-FILLED NYLON



TORCH™ II

Inspired by the Torch I, this version employs G-10 composite inserts in the handle for additional grip in tricky situations. A matte black tanto blade is stealth and effective, easily opened with one hand courtesy of dual thumbstuds or a finger flipper.

BLADE LENGTH:	3.5"
WEIGHT:	5.9 OZ
HANDLE:	STAINLESS STEEL W/ MACHINED G-10 COMPOSITE



BLISTER 22-41584 SERRATED/TANTO TORCH I FINGER FLIP DOUBLES AS FINGER GUARD

BLISTER 22-41586 SERRATED/TANTO TORCH II DUAL THUMBSTUDS FOR ONE-HAND OPENING

NEW

39 SERIES™ MICARTA

Named for its unique handle material, the Micarta clip folder is an innovative design that bridges the gap between style and utility. Premium S30V steel is fashioned into a fine edge blade, holding a razor sharp edge and providing first-class corrosion resistance.

BLADE LENGTH:	3.3"
WEIGHT:	3.8 OZ
HANDLE:	MACHINED MICARTA W/ HIGH-DENSITY POLYMER BOLSTER
BLADE:	CPM-S30V

Outside

39 Series Micarta Gets
the Win in Outside
Summer Buyer's Guide

APRIL 26, 2016



VITAL™ POCKET FOLDER

Featuring one of the safest Exchange-A-Blade options out there, a surgically sharp blade cuts through game easily, requiring no extra tool if you need to replace the blade on the fly. The orange handle is easily spotted and a large finger choil adds stability.

BLADE LENGTH:	2.8"
WEIGHT:	1.3 OZ
HANDLE:	RUBBER OVERMOLD
BLADE:	#60 RAZOR BLADE



2014



BOX 30-001062 FINE EDGE/DROP POINT LARGE THUMB LIFT

BLISTER 31-002736 SERRATED/DROP POINT HIGH-VISUAL ORANGE; EASIER TO SPOT

APPLEGATE-FAIRBAIRN COMBAT FOLDER™

Honoring the late Colonel Rex Applegate, this first-class tactical folder is designed for close quarter combat situations. Unrivaled strength meets perfected balance in the form of a glass-filled nylon handle opposite a high-carbon stainless steel blade.

BLADE LENGTH:	4.5"
WEIGHT:	7.4 OZ
SHEATH:	INCLUDED
HANDLE:	GLASS-FILLED NYLON
BLADE:	HIGH CARBON STAINLESS



"Issued to me just shy of 10 years ago, it has survived multiple combat tours, being abused as everything from a daily use knife, to can opener, and even a pry bar on several occasions..."



DREW, US ARMY SPECIAL FORCES



Sheath made in China

BLISTER	45780	SERRATED/DOUBLE BEVEL	PATENTED ROTO-LOCK SYSTEM
BOX	05780	SERRATED/DOUBLE BEVEL	PATENTED ROTO-LOCK SYSTEM



BG FOLDING SHEATH KNIFE™

Loaded with innovations and backed by Bear, this knife has everything. With a 3.6 inch drop point blade, a textured rubber grip, dual thumbstuds, and a sturdy lock back design you are never unprepared. A military-grade sheath is durable and lightweight.

BLADE LENGTH:	3.6"
WEIGHT:	4.3 OZ
SHEATH:	INCLUDED
HANDLE:	TEXTURED RUBBER GRIP
BLADE:	7CR17MOV



"I have had this tool for two years and it is still solid after going thru wood, mud, water and much much more. The knife still feels and looks brand new after a good cleaning. Love this knife."



LEVI REAUME



BLISTER	31-002947	FINE EDGE/DROP POINT	SHEATH	DUAL THUMBSTUDS
BLISTER	31-000752	SERRATED/DROP POINT	SHEATH	LOCK BACK

FREEMAN™ GUIDE FOLDER

This knife was created for one reason: to be your go-to knife on the hunt. Folding application gives added portability to the 4 inch blade, while larger finger grooves offer comfort for all day use. The Tachide™ overmold provides secure grip in any weather.

BLADE LENGTH:	4.0"
WEIGHT:	6.6 OZ
SHEATH:	INCLUDED
HANDLE:	TACHIDE™
BLADE:	5CR15MOV



"Fantastic! This knife is amazing! I bought this because I wanted a gut hook knife, and I could not have made a better purchase. The grip is amazing, the knife is heavy for maximum control, the blade keeps its edge nicely, and the hook is very useful. My favorite knife I've ever owned by far!"

★★★★★
FRANK ARTERBERRY



BLISTER	31-000592	SERRATED/GUT HOOK	POLYMER-LINED CLOTH SHEATH
BLISTER	31-000591	FINE EDGE/DROP POINT	POLYMER-LINED CLOTH SHEATH

FREESCAPE™ FOLDING SHEATH KNIFE

This robust blade is ready for any adventure. Designed with safety in mind, this folding knife has a safety and a secondary lock to keep it securely open or closed. The 7Cr17MoV steel blade handles a myriad of tasks with ease, a grippy handle ensures stability.

BLADE LENGTH:	3.5"
WEIGHT:	4.3 OZ
SHEATH:	INCLUDED
HANDLE:	TEXTURED RUBBER GRIP
BLADE:	7CR17MOV



"I have had this knife for 5 months and I use it every day. The knife shows no signs of damage and the blade is very sharp still."

★★★★★
GRANT



BLISTER	31-002527	SERRATED/DROP POINT	SAFETY SLIDER KEEPS BLADE CLOSED WHEN ENGAGED
---------	-----------	---------------------	---

GATOR®

With an iconic design, the Gator® series has become synonymous with craftsmanship and field-tested durability. A portable folding application partners with the patented Gator Grip® handle to offer unsurpassed comfort and ease of use.

BLADE LENGTH:	3.8"
WEIGHT:	5.4 OZ
SHEATH:	INCLUDED
HANDLE:	GATOR GRIP®
BLADE:	154CM
CLIP POINT/GUT HOOK 42ØHC	



"This Gator 154cm is the sharpest and nicest knife in my bag! Made in USA also."



ARNIE HOYT, OUTDOORSMAN/HUNTER



GATOR® II w/ E-Z GUT HOOK

Built on the successful Gator® design, this version features an updated ergonomic handle, built-in thumb rests, and notched spine grips for maximum grip. An optional gut hook blade is also included for when things get messy.

BLADE LENGTH:	3.6"
WEIGHT:	4.4 OZ
SHEATH:	INCLUDED
HANDLE:	GATOR GRIP®
BLADE:	42ØHC



Sheath made in China



BOX	06064	FINE EDGE/DROP POINT	GATOR GRIP® HANDLE TEXTURE FOR MAXIMUM GRIP
BLISTER	46079	SERRATED/CLIP POINT	LOCK-BACK MECHANISM SECURES BLADE IN OPEN POSITION
BOX	06079	SERRATED/CLIP POINT	LOCK-BACK MECHANISM SECURES BLADE IN OPEN POSITION
BLISTER	46932	FINE EDGE/GUT HOOK	GATOR GRIP® HANDLE TEXTURE FOR MAXIMUM GRIP
BOX	06932	FINE EDGE/GUT HOOK	GATOR GRIP® HANDLE TEXTURE FOR MAXIMUM GRIP
BLISTER	46069	FINE EDGE/CLIP POINT	GATOR GRIP® HANDLE TEXTURE FOR MAXIMUM GRIP
BOX	06069	FINE EDGE/CLIP POINT	GATOR GRIP® HANDLE TEXTURE FOR MAXIMUM GRIP

BLISTER	22-41417	SERRATED/DROP POINT	E-Z GUT HOOK
---------	----------	---------------------	--------------

GATORMATE®

Detail oriented and compact, this smaller version is perfectly designed for clean cuts and moments that demand finesse. Outfitted with the same dependable Gator Grip®, this pocket folder is sure to be a consistent companion.

BLADE LENGTH:	3.1"
WEIGHT:	3.0 OZ
SHEATH:	INCLUDED
HANDLE:	GATOR GRIP®
BLADE:	42ØHC



Sheath made in China



GATOR® PREMIUM

The elevated, first-class reincarnation of the original, this knife offers American-made excellence with premium materials. The S30V steel blade will last generations, an upgraded Gator Grip® handle and steel bolsters give ultimate control.

BLADE LENGTH:	3.6"
WEIGHT:	4.8 OZ
SHEATH:	INCLUDED
HANDLE:	GATOR GRIP®
BLADE:	CPM-S30V



"I just got this in the mail and it is a great knife. It feels solid, like you can really put it to use, and the gator skin is like nothing I've seen. Very well done Gerber."

★★★★★
KEITH, HUNTER



BOX 06149 FINE EDGE/CLIP POINT GATOR GRIP® HANDLE TEXTURE FOR MAXIMUM GRIP

BOX 30-001085 FINE EDGE/CLIP POINT ONE HAND OPENING LEATHER SHEATH
BOX 30-001086 FINE EDGE/GUT HOOK ONE HAND OPENING LEATHER SHEATH

HINDERER RESCUE™

Engineered for those brave souls running into the fire, this beefy knife can be handled in turn-out gloves and operated in confidence with life-saving features. No ordinary knife, it has a hook cutter, a window punch, and an oxygen tank valve opening.

BLADE LENGTH:	3.5"
WEIGHT:	5.6 OZ
SHEATH:	INCLUDED
HANDLE:	GLASS-FILLED NYLON
BLADE:	7CR17MOV



"Knife is very handy and useful for day to day activities as a firefighter. I have used this tool to open locked doors, break windows, cut seat belts, cut ropes of different sizes, and many many more things."



STEVE BERTUCCIO, CAPTAIN



BLISTER BOX	22-41534 22-Ø1534	SERRATED/BLUNT TIP SERRATED/BLUNT TIP	HOOK CUTTER HOOK CUTTER	WINDOW PUNCH WINDOW PUNCH	Ø ² TANK VALVE OPENER Ø ² TANK VALVE OPENER
-------------	----------------------	--	----------------------------	------------------------------	--

MOMENT™

For unmatched control and precision, this folder offers a balanced design and comfortable grip. The fine edge, drop point blade affords ultimate utility for hunting and camping tasks alike.

BLADE LENGTH:	3.5"
WEIGHT:	5.6 OZ
SHEATH:	INCLUDED
HANDLE:	NYLON CORE W/ RUBBER OVERMOLD
BLADE:	5CR15MOV



BLISTER	31-ØØ2212	FINE EDGE/GUT HOOK	POMMEL W/ LANYARD HOLE	GLASS BEAD BLADE FINISH
BLISTER	31-ØØ22Ø9	FINE EDGE/DROP POINT	POMMEL W/ LANYARD HOLE	GLASS BEAD BLADE FINISH

MYTH® FOLDER

Compact and quiet, this folder is the perfect companion to take with you on the hunt. A rubberized handle is comfortable for the long haul, a drop point blade is ideal for any field work you stumble upon. A low-profile sheath includes a built-in carbide sharpener.

BLADE LENGTH:	3.5"
WEIGHT:	3.1 OZ
SHEATH:	INCLUDED
HANDLE:	TEXTURED RUBBER
BLADE:	HIGH CARBON STAINLESS



"I have had Myth for 4 or 5 years and use it day in and day out for opening boxes, cutting zip ties, rope and plastic banding material at work. It is the only knife I carry any more... I am 67 years old and have been an avid outdoorsman all my life and would never part with this knife. Thanks for a product that performs as it should!!"



STEVE SHIPP, LODGE ASSOCIATE

BLISTER	31-001164	FINE EDGE/DROP POINT	TEXTURED RUBBER HANDLE SHEATH W/ INTEGRATED SHARPENER
BLISTER	31-001160	FINE EDGE/GUT HOOK	TEXTURED RUBBER HANDLE SHEATH W/ INTEGRATED SHARPENER



BG GRANDFATHER™ KNIFE

Gerber's decades of experience and Bear Grylls' sense of adventure collide in this nostalgic pocket knife. The classic design is complimented with 7 utilitarian features to keep this tool relevant and useful. Made for everyday use and adventure alike.

BLADE LENGTH: 2.8"
WEIGHT: 3.5 OZ
HANDLE: STEEL W/ RUBBER OVERMOLD



"Awesome I love it !! Got It for my survival tin but I ended up using the tin it came with. I put 20 waterproof matches, a sharpener, emergency blanket, Gerber Bear Grylls waterproof fire starter, band aids, alcohol pads...that's everything I put in my kit."

★★★★★
CHASE LAWSON

BLISTER 31-002181 FINE EDGE BLADE, FLAT DRIVER, PHILLIPS DRIVER, CORKSCREW, BOTTLE OPENER, FILE + LANYARD RING



GDC TECH SKIN™ POCKET KNIFE

A thoughtful fusion of useful materials and smart design, the GDC Tech Skin has a completely rubberized handle and thumbstud. The added grip allows for confident use, no matter the task. A 2.5 inch drop point blade is securely kept in place by a lock back.

BLADE LENGTH:	2.5"
WEIGHT:	2.2 OZ
HANDLE:	ZYTEL 101
BLADE:	7CR17MOV

"Can't say enough about the piece. Great design, practical, light. Genius!"



JOHN C, CONSULTANT



BLISTER BOX	31-001693 30-000636	FINE EDGE/DROP POINT FINE EDGE/DROP POINT	LOCK BACK SAFETY FUNCTION LOCK BACK SAFETY FUNCTION
-------------	------------------------	--	--

LST™ [LIGHTWEIGHT, STRONG, TOUGH]

Brought to market by none other than Pete Gerber himself, this little knife has a big history. With a handle completely constructed of all synthetic materials, it set a new standard in craftsmanship. Also featuring a 420HC blade and built in America, this classic can't be missed.

BLADE LENGTH:	2.6"
	ULTRALIGHT: 2.0"
WEIGHT:	1.2 OZ
	ULTRALIGHT: 0.6
HANDLE:	GLASS-FILLED NYLON
BLADE:	420HC



BLISTER BOX	46009 22-06009	FINE EDGE/DROP POINT FINE EDGE/DROP POINT	TACTILE TEXTURED HANDLE TACTILE TEXTURED HANDLE	LOCK-BACK DESIGN LOCK-BACK DESIGN
BLISTER BOX	46050 22-06050	FINE EDGE/DROP POINT FINE EDGE/DROP POINT	ULTRALIGHT LST ULTRALIGHT LST	LOCK-BACK DESIGN LOCK-BACK DESIGN

2.5" BOLSTER STAG™

This iconic folder features a genuine stag handle and a large polished clip blade, nodding to knife-making hallmarks yet adding modern muscle for daily use. With a locking blade and classic filigree etching, this knife is one to be passed down for generations.

BLADE LENGTH:	2.5"
WEIGHT:	2.6 OZ
HANDLE:	GENUINE STAG



"This is my favorite everyday use knife. It's a classy looking knife and reminds me of a pocket knife my grandfather carried. The bag is also a nice touch it keeps the knife protected when I carry it with me. This is a knife I will pass on to my son. Another great knife."

★★★★★
STEVE, CAMPER

BOLSTER 22-41052 FINE EDGE/CLIP POINT LOCKING BLADE BRONZE LINER GENUINE STAG HANDLE

STL™ [STRONG, THIN, LIGHT] 2.0

Strong. Thin. Light. The STL is a one ounce powerhouse that fights above its weight class. A cut out in the blade offers easy one-handed opening, and an ultra-thin blade is perfect for detailed jobs. A lanyard hole ensures it will always be on hand and ready.

BLADE LENGTH:	2.0"
WEIGHT:	1.0 OZ
HANDLE:	STAINLESS STEEL
BLADE:	7CR17MOV



BOLSTER 22-41122 FINE EDGE/DROP POINT BLACK CUT-OUT FOR ONE-HANDED OPENING

STL™ [STRONG, THIN, LIGHT] 2.5

Strong. Thin. Light. The STL 2.5 is an evolution of the original, still light at 1.5 ounces yet strong enough for your daily tasks. A cut out in the blade offers easy one-handed opening, and the ultra-thin blade is longer for added value. A lanyard hole ensures it will always be on hand and ready.

BLADE LENGTH:	2.6"
WEIGHT:	1.5 OZ
HANDLE:	STAINLESS STEEL
BLADE:	7CR17MOV



BLISTER 31-000716 FINE EDGE/DROP POINT BLACK STAINLESS STEEL HANDLE

US1™

Drawing on decades of experience perfecting the folding pocket knife, the US1 is an American made testament to great design. The best-in-class 420HC blade is deployed with a simple nail nick and held in check by an easy to operate lock back design.

BLADE LENGTH:	2.6"
WEIGHT:	1 OZ
HANDLE:	30% GLASS-FILLED NYLON W/ RUBBER OVERMOLD
BLADE:	420HC



"This is a great knife. Light weight. Lock-back. Great blade length. Made in the USA. And non-serrated!!"

★★★★
SCOTT, VIRGINIA



BLISTER 31-003040 FINE EDGE/DROP POINT THIN AND LIGHTWEIGHT NAIL NICK



CUTTING TOOLS



NEW

BROADCUT™ MACHETE

The modern version of the traditional jungle tribesmen's machete, the Broadcut Machete is as effective as the name suggests. The heavy fine edge blade is corrosion resistant and makes short work of dense brush. An innovative hook + cut notch is engineered into the blade, an ideal tool for manipulating troublesome vines and branches for removal. With a comfortable rubber grip and a large finger choil, this tool is designed for the long days and tough tasks.

OVERALL LENGTH:	19.7"
BLADE LENGTH:	13.1"
WEIGHT:	18.07 LBS
SHEATH:	INCLUDED



- HOOK + CUT NOTCH
- THICK, FULL TANG STAINLESS STEEL BLADE
- IMPROVED GRIP COMFORT
- CORROSION RESISTANT
- SLIM, BELT CARRY SHEATH
- SAFETY LANYARD

BLISTER 31-003152 FINE EDGE FULL TANG SAFETY LANYARD SLIM, BELT CARRY SHEATH

NEW

COMPACT CLEARPATH™ MACHETE

For back-country travel when every bit of weight is accounted for, the Compact Clearpath Machete is the tough, packable tool to bring along for the ride. The thoughtful design partners a corrosion-resistant, dual function stainless steel blade with the confidence of the tactile Gator Grip® handle. The two-sided blade has both a fine edge for hacking brush and vines and a crosscut saw edge for cutting branches, limbs, and small trees. When you head into the brush, never be without the Compact Clearpath Machete

OVERALL LENGTH:	17.3"
BLADE LENGTH:	11"
WEIGHT:	18.07 LBS
SHEATH:	INCLUDED



- GATOR GRIP® HANDLE
- CROSSCUT SAWTOOTH TECHNOLOGY
- COMPACT, PACKABLE SHEATH
- CORROSION-RESISTANT STAINLESS STEEL BLADE
- SAFETY LANYARD FOR TETHERING

BLISTER 31-003154 CROSSCUT SAWTOOTH BLADE GATOR GRIP® HANDLE SAFETY LANYARD COMPACT SHEATH

PTFE

COATING TECHNOLOGY

GERBER'S BEST PERFORMING AXE BLADE.

FRICITION RESISTANT:

+ CHOPS 3X DEEPER.

HIGH HEAT RESISTANT:

+ UP TO 600° F.

CORROSION RESISTANT:

+ NO CHEMICAL/WATER DAMAGE.

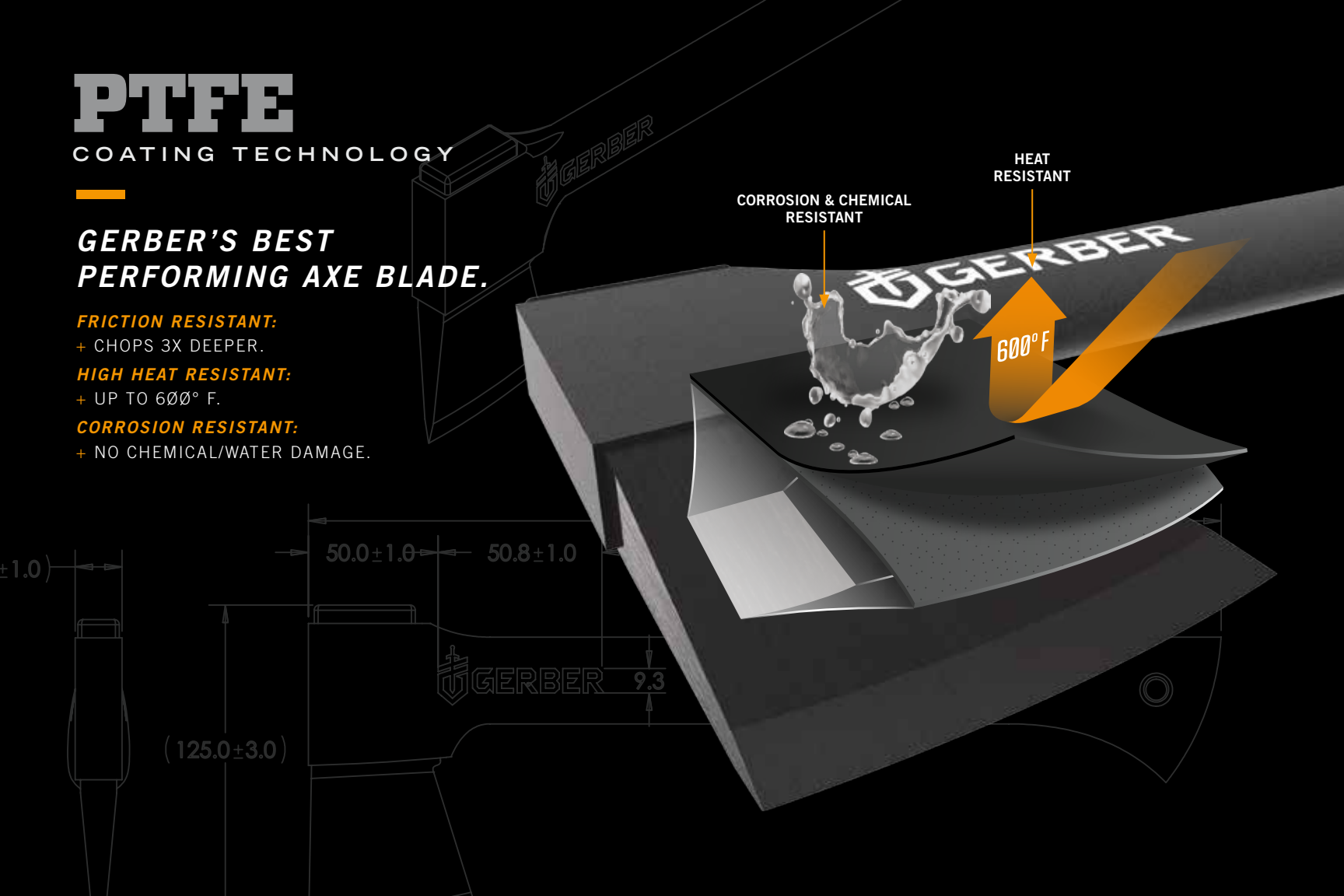

9" HATCHET™

The 9" Hatchet is a portable axe that travels well in the kit of hikers and outdoor aficionados; its compact size makes it ideal for chopping kindling and splitting small logs. The new black PTFE coating along the blade is engineered for a smooth, deep cuts.

OVERALL LENGTH:	9"
BLADE LENGTH:	2.7"
WEIGHT:	1.15 LBS
SHEATH:	INCLUDED
HANDLE:	FIBERCOMP™



PTFE COATING TECHNOLOGY

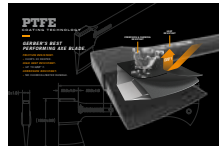

14" HATCHET™

The 14" Hatchet combines light heft and an ultra-sharp blade to offer unbeatable edge retention; its portable size makes it ideal for splitting medium-sized and smaller logs. The new black PTFE coating along the blade is engineered for a smooth, deep cuts.

OVERALL LENGTH:	14"
BLADE LENGTH:	2.7"
WEIGHT:	1.5 LBS
SHEATH:	INCLUDED
HANDLE:	FIBERCOMP™



PTFE COATING TECHNOLOGY

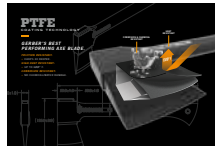

HANG CARD 31-002648 FINE EDGE FORGED STEEL HEAD EXCELLENT EDGE RETENTION COMPOSITE SHEATH

HANG CARD 31-002647 FINE EDGE FORGED STEEL HEAD EXCELLENT EDGE RETENTION COMPOSITE SHEATH

23.5" AXE™

Light in the handle and tough in the blade, the 23.5" Axe delivers a solid, easy swing with superior control. A new black PTFE coating on the blade ensures it slices through wood without sticking and a forged head that splits wood evenly. A chop that is up to three times deeper than average.

OVERALL LENGTH:	23.5"
BLADE LENGTH:	3.5"
WEIGHT:	3.6 LBS
SHEATH:	INCLUDED
HANDLE:	FIBERCOMP™



PTFE COATING TECHNOLOGY

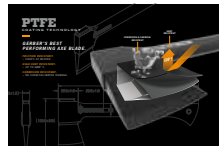

"I've had my Gerber XL Axe II for around a week now...it is damn good at splitting wood, finally cleared all of the tree limbs from the back yard and have a decent pile of fire wood, Thanks Gerber!"

★★★★★
DIMITRI, PROUD OWNER

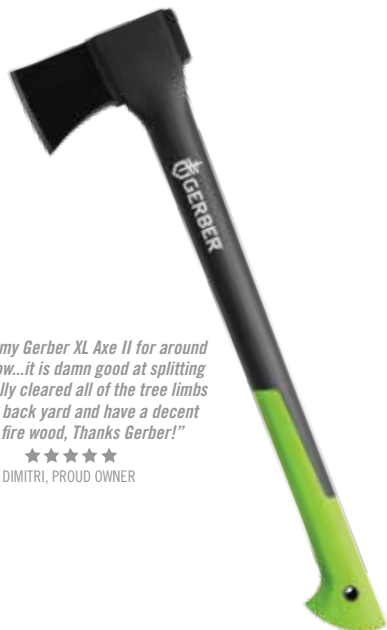

36" POWER SPLITTING AXE™

Gerber's largest axe offering, this tool is designed for maximum power when splitting logs and chopping roots. A weighted stainless steel head and black PTFE coated blade easily splits large-sized logs in one clean attempt without sticking. The sizable handle is tough and easy to grip.

OVERALL LENGTH:	36"
BLADE LENGTH:	2.6"
WEIGHT:	6.6 LBS
SHEATH:	INCLUDED
HANDLE:	FIBERCOMP™



PTFE COATING TECHNOLOGY

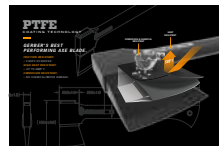

HANG CARD 31-002651 FINE EDGE FORGED STEEL HEAD EXCELLENT EDGE RETENTION COMPOSITE SHEATH

HANG CARD 31-003636 FINE EDGE FORGED STEEL HEAD EXCELLENT EDGE RETENTION COMPOSITE SHEATH

17.5" FREESCAPE HATCHET™

This evolved hatchet features efficient strength in a slim profile. With a new black PTFE coating on the blade and a unique grind technique, the steel blade is sharper than ever. Expect clean cuts far longer than average from this smart axe, for use at the campsite and beyond.

OVERALL LENGTH:	17.3"
BLADE LENGTH:	2.9"
WEIGHT:	2.3 LBS
SHEATH:	INCLUDED
HANDLE:	FIBERCOMP™



PTFE COATING TECHNOLOGY

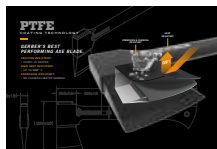

DOWNRANGE TOMAHAWK™

A marvel of simplicity, this tool has a single-minded goal: to settle the breaching argument. No barrier is a match for the beveled edge axe head, the hammer head element, or the pry bar built into the tan G-10 composite handle. A 420HRC steel body won't break under pressure.

OVERALL LENGTH:	19.3"
WEIGHT:	1.9 LBS
SHEATH:	INCLUDED
HANDLE:	G-10 COMPOSITE



Sheath Made in China

"I've had the Downrange Tomahawk close to a year now. It's been with me everywhere both on and off duty. Used hammer to break locks, and the axe blade goes through everything - wood, brick and metal."

★★★★★

DAN, FEDERAL OFFICER

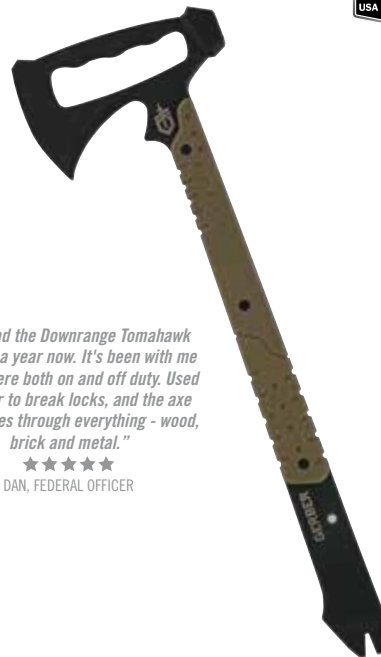

HANG CARD 31-002536 FINE EDGE FORGED STEEL HEAD EXCELLENT EDGE RETENTION COMPOSITE SHEATH

BOX 30-000715 FINE EDGE MOLLE-COMPATIBLE SHEATH INTEGRATED PRYING HANDLE

GATOR® COMBO AXE™

This stout combo fits perfectly in hand, offering double the utility with a fixed blade knife fitting snugly into the handle cavity. With Gerber's renowned Gator Grip® offering unparalleled comfort on both tools and a forged steel axe head, you will quit long before your tools do.

OVERALL LENGTH:	8.8"
BLADE LENGTH:	2.7"
WEIGHT:	1.5 LBS
SHEATH:	INCLUDED
HANDLE:	GATOR GRIP®



BLISTER 31-001054 FINE EDGE FORGED STEEL HEAD GLASS-FILLED NYLON HANDLE NYLON SHEATH

GATOR® COMBO AXE™ II

Perfect for the outdoor adventurer, this compact all-conditions axe offers great utility and a surprising addition. With a longer handle than the original and a forged steel head, the Gator® axe has optimal striking force. The grippy handle also houses a coarse blade handsaw.

OVERALL LENGTH:	15.6"
BLADE LENGTH:	2.7"
WEIGHT:	1.6 LBS
SHEATH:	INCLUDED
HANDLE:	GATOR GRIP®



BLISTER 22-41420 FINE EDGE/SERRATED FORGED STEEL HEAD GLASS-FILLED NYLON HANDLE NYLON SHEATH

MYTH HATCHET™

This robust-bellied hatchet expertly skins and chops the biggest game the hunt brings in. Easily taken into the field, the portable and ultra-sharp blade holds an edge to prevent body strain and offer faster chopping. A sturdy sheath keeps it safely secured.

OVERALL LENGTH:	8.5"
BLADE LENGTH:	3.5"
WEIGHT:	14.6 OZ
SHEATH:	INCLUDED



BG SURVIVAL HATCHET™

With a compact size and slim profile, this survival hatchet earns its spot in your pack at only 1.4 pounds. A 3.5 inch blade couples with a well-proportioned design, providing a tool that chops well above its weight class.

OVERALL LENGTH:	9.5"
BLADE LENGTH:	3.5"
WEIGHT:	20.8 OZ
SHEATH:	INCLUDED
HANDLE:	NYLON
BLADE:	5CR13



"BEST HATCHET EVER!!! It is a great hatchet that I hope to have for the rest of my life, great sheath great job GERBER."

★★★★★

FRANK MIDDLETON

BLISTER 31-002698 FINE EDGE FULL TANG EXCELLENT EDGE RETENTION COMPOSITE SHEATH

BLISTER 31-002070 FINE EDGE FULL-TANG, HIGH CARBON STEEL CONSTRUCTION CANVAS SHEATH

BG COMPACT PARANG™

The Compact Parang is a more convenient size for the long haul, a shoulder-friendly answer to a full-size machete. The stout, full tang blade takes on brush and campsite tasks alike, the oversized bolster and rubber grip add comfort for multiple swings.

OVERALL LENGTH:	15"
BLADE LENGTH:	9.3"
WEIGHT:	13.6 OZ
SHEATH:	INCLUDED
HANDLE:	POLYPROPYLENE
BLADE:	CARBON STEEL



BLISTER 31-002072 FINE EDGE FULL TANG CONSTRUCTION HIGH CARBON STEEL BLADE NYLON SHEATH

GATOR® BOLO MACHETE™

Based on the classic shape used for decades of clearing, chopping, and cutting, comes the updated Bolo. The ergonomic handle shape, the full tang construction, and the slip-proof grip offer smart design upgrades. Part trimmer, part axe, all business.

OVERALL LENGTH:	22.5"
BLADE LENGTH:	15.5"
WEIGHT:	20.8 OZ
SHEATH:	INCLUDED
HANDLE:	GATOR GRIP®
BLADE:	CARBON STEEL

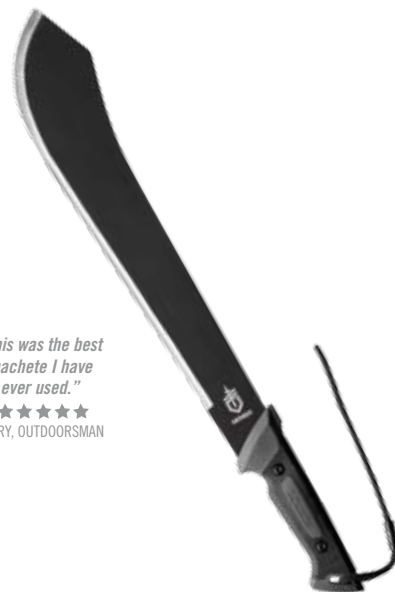

"This was the best machete I have ever used."
★★★★★
LARRY, OUTDOORSMAN

BLISTER 31-002076 FINE EDGE FULL-TANG CONSTRUCTION LANYARD NYLON SHEATH

GATOR® BRUSH THINNER™

When the day calls for clearing brush, limbs, and debris reach for this dramatically shaped machete. The high carbon steel blade is sturdy and reliable in crowded areas, the non-stick coating reduces friction for multiple cuts, and the Gator Grip® prevents slippage.

OVERALL LENGTH:	19.5"
BLADE LENGTH:	9"
WEIGHT:	14.3 OZ
SHEATH:	INCLUDED
HANDLE:	GATOR GRIP®
BLADE:	CARBON STEEL

"I have carried this machete for about 5 years. It holds it's edge and is very useful when trimming branches. It is extremely versatile and useful, This is a must have tool for anyone."

★★★★★
DON KYLLONEN



GATOR® BUSH MACHETE™

With a classic multi-purpose design, this machete has an impressive 17.9 inch full tang blade that is evenly weighted and precision ground for minimal exertion. Confidently secured by the Gator Grip® handle, paracord lanyard, and sheath, go into the wild prepared.

OVERALL LENGTH:	24"
BLADE LENGTH:	17.9"
WEIGHT:	18.7 OZ
SHEATH:	INCLUDED
HANDLE:	GATOR GRIP®

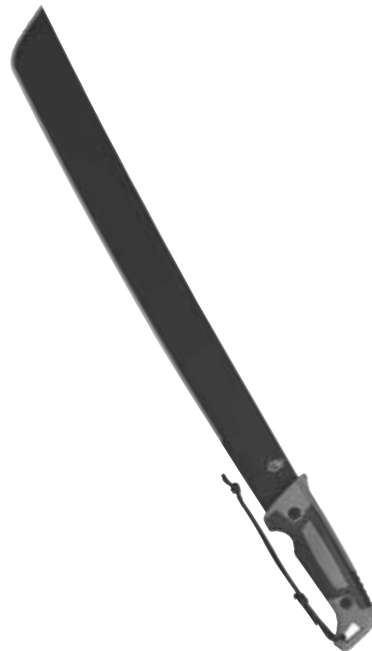

BLISTER 31-000083 FINE EDGE SHAPED CARBON STEEL BLADE CONTOURED NYLON SHEATH

BLISTER 31-002848 FINE EDGE FULL TANG CONSTRUCTION ADJUSTABLE LANYARD NYLON SHEATH

GATOR® GOLOK MACHETE™

Featuring the thickest blade in Gerber's machete line, the Golok is built to handle tough underbrush and stubborn green wood. A dual tapered blade design allows for less strain, more efficiency. A Gator Grip® handle feels snug in hand even after multiple swings.

OVERALL LENGTH:	19"
BLADE LENGTH:	12"
WEIGHT:	25.3 OZ
SHEATH:	INCLUDED
HANDLE:	GATOR GRIP®
BLADE:	CARBON STEEL

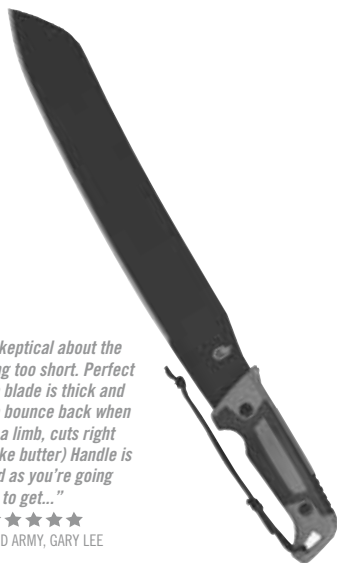

"I was skeptical about the blade being too short. Perfect size. The blade is thick and heavy (no bounce back when you hit a limb, cuts right through like butter) Handle is as solid as you're going to get..."

★★★★★
RETIRED ARMY, GARY LEE

BLISTER 31-002850 FINE EDGE DUAL TAPERED BLADE DESIGN GATOR GRIP® OVERMOLD HANDLE

GATOR® KUKRI MACHETE™

This triple threat machete is a workhorse: a pointed tip pierces with accuracy, a wide midsection chops with power and ease, a narrow area above the handle is ideal for whittling or carving. With full tang construction and a Gator Grip®, this tool is a no-brainer.

OVERALL LENGTH:	19"
BLADE LENGTH:	12"
WEIGHT:	14.4 OZ
SHEATH:	INCLUDED
HANDLE:	GATOR GRIP®
BLADE:	CARBON STEEL



BLISTER 31-002074 FINE EDGE FULL TANG CONSTRUCTION LANYARD

GATOR® MACHETE™

This dual purpose machete solves two obstacles: chopping and sawing. Successful at both, the 18 inch blade features a full performance saw on one side, a 15 inch fine edge blade on the other. With a Gator Grip® handle to keep it secure, it is ready for anything.

OVERALL LENGTH:	25.7"
BLADE LENGTH:	18"
WEIGHT:	18 OZ
SHEATH:	INCLUDED
HANDLE:	GATOR GRIP®
BLADE:	CARBON STEEL



GATOR® MACHETE JR™

Built just as tough but shorter and more packable, this version keeps the same dual blade. Perfect for back-country travel, the fine edge tackles brush and vines while the saw cuts limbs and small trees. The Gator Grip® keeps tasks comfortable and securely in hand.

OVERALL LENGTH:	18.8"
BLADE LENGTH:	11.3"
WEIGHT:	14.3 OZ
SHEATH:	INCLUDED
HANDLE:	GATOR GRIP®
BLADE:	CARBON STEEL



"This is a serious machete and I've put it through the paces clearing mountain ash and alder. I've used it to limb pine and cotton wood with branches that I thought I'd need an axe for..."

★★★★

PATRICK LACE, PROVINCIAL PARK MANAGER

BLISTER 31-000758 FINE EDGE DESIGNED FOR CUTTING AND CHOPPING GATOR GRIP® HANDLE TEXTURE NYLON SHEATH

BLISTER 31-000759 FINE EDGE DESIGNED FOR CUTTING AND CHOPPING GATOR GRIP® HANDLE TEXTURE NYLON SHEATH

GATOR® MACHETE PRO™

The best of the best, this machete features a truly multi-purpose design. The corrosion-resistant blade is fashioned to chop, gather, cut, dig, or sharpen; the Gator Grip® handle ensures comfort throughout. A military-grade sheath is mold and mildew resistant.

OVERALL LENGTH:	16.5"
BLADE LENGTH:	10.5"
WEIGHT:	17.9 OZ
SHEATH:	INCLUDED
HANDLE:	GATOR GRIP®
BLADE:	CARBON STEEL

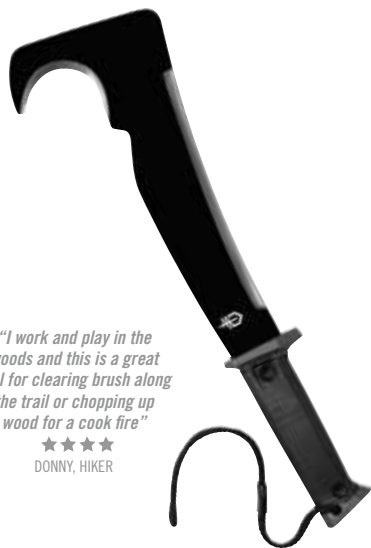

"I work and play in the woods and this is a great tool for clearing brush along the trail or chopping up wood for a cook fire"

★★★★
DONNY, HIKER



BG SURVIVAL PARANG™

A modern version of the jungle tribesmen's tool, this Parang machete is upgraded with the survival acumen of Bear Grylls. A full tang, angled blade is ideal for clearing and holds an edge. The rubber grip keeps it firmly in hand and a lanyard keeps it nearby.

OVERALL LENGTH:	19.5"
BLADE LENGTH:	13.5"
WEIGHT:	19.4 OZ
SHEATH:	INCLUDED
HANDLE:	POLYPROPYLENE
BLADE:	CARBON STEEL



BLISTER 31-000705 FINE EDGE DESIGNED FOR CHOPPING, GATHERING + CUTTING, DIGGING, AND SHARPENING

BLISTER 31-002289 FINE EDGE ANGLED BLADE FULL TANG CONSTRUCTION NYLON SHEATH

MYTH® FOLDING LOPPER™

Designed by professional hunters and guides, this tool is an innovative and clever way to prep a campsite or clear the trail. Grippy handles cleanly fold down for easy storage, all-metal construction ensures longevity, and a low-friction coating keeps the blades smooth.

OVERALL LENGTH:	14.4"
WEIGHT:	27.2 OZ
HANDLE:	RUBBER OVERMOLD
BLADE:	COATED SK5 STEEL



BLISTER 31-002699 FINE EDGE TEXTURED RUBBER HANDLE INLAIS LOW-FRICTION COATED BLADES

MYTH® RATCHETING PRUNER™

For easy sight lines with minimal effort, look no further. The precision-ground blades handle tough branches while staying sharp, the low-friction coating keeps sap off. The structured ratcheting system and rubber handle offer superior power in use.

OVERALL LENGTH:	8.0"
BLADE LENGTH:	2.1"
WEIGHT:	6.5 OZ
HANDLE:	RUBBER OVERMOLD
BLADE:	COATED SK5 STEEL



BLISTER 31-002749 FINE EDGE TEXTURED RUBBER HANDLE INLAIS RATCHET SYSTEM FOR MINIMAL STRAIN

VITAL™ TAKE-A-PART SHEARS

With highly visual orange handles and a design aimed for comfort, these efficient serrated shears are built to break down small game. Release the pivot pin, separate the two blades, and cleanup is a breeze. For the hunt, for the kitchen, keep 'em on hand.

OVERALL LENGTH:	8.0"
WEIGHT:	16 OZ
SHEATH:	INCLUDED



BLISTER 31-002747 FINE EDGE HIGH-VISIBILITY ORANGE RUBBER OVERMOLD HANDLE NYLON SHEATH



NEW

FREESCAPE CAMP SAW™

Portable. Safe. Functional. This innovative saw folds up flat for transport and utilizes 4 pivot points upon release to create a secure handle grip and 12 inch cutting surface. Bright green accents are easy to spot at the campsite, keeping you aware and safe.

OPEN:	14.7" X 6.6" X 1.1"
CLOSED:	13.8" X 1.8" X 1.1"
BLADE LENGTH:	12"
WEIGHT :	15.3 OZ
HANDLE:	RUBBER OVERMOLD GRIP



EXCHANGE-A-BLADE SAW™

As pull saws go, the Exchange-A-Blade is the ultimate in versatility. The interchangeable blades are sharp, durable, and designed with purpose. The coarse blade is ideal for wood, the fine blade for bone. Replacement blades are available in each.

OVERALL LENGTH:	14.2"
BLADE LENGTH:	6.2"
WEIGHT:	7.8 OZ
HANDLE:	GLASS-FILLED NYLON W/ GATOR GRIP® INSERTS



"Loved this unit. Cut many a moose and whitetail deer rib cage and never a problem. Trimmed lots of branches for my tree stands. Over the past dozen years or so it was main stay."

★★★★★
HUNTER, JIM STINSON

BLISTER 31-002820 FOLDS DOWN FLAT W/O REMOVAL OF PARTS INNOVATIVE DESIGN

BLISTER 46036	COARSE/WOOD & FINE/BONE	HIGH CARBON STAINLESS STEEL BLADES
BLISTER 70176	FINE/BONE REPLACEMENT BLADE	HIGH CARBON STAINLESS STEEL BLADE
BLISTER 70151	COARSE/WOOD REPLACEMENT BLADE	HIGH CARBON STAINLESS STEEL BLADE

GATOR® EXCHANGE-A-BLADE SAW™

The same saw types as the Exchange-A-Blade Saw, yet this version features the iconic Gator Grip® on the handle for superior grip and comfort. The high carbon stainless steel blade channel and improved blade exchange mechanism make for a seamless transition.

OVERALL LENGTH:	15.5"
BLADE LENGTH:	6.7"
WEIGHT:	10.8 OZ
HANDLE:	GATOR GRIP®

"I got this today and I am quite pleased with it. I used it to trim a troublesome bush. It cut easily all of the tree limbs and branches including a couple that were 3.5 inches in diameter. It did the job easily that is all anyone would want."



TIM LEYVA



BLISTER 22-41457 COARSE/WOOD & FINE/BONE GATOR GRIP® OVERMOLD ON HANDLE

GATOR® SAW I™

The modern interpretation of the traditional collapsible saw, this version adds advanced design and materials. Every component is made of durable stainless steel, save for the handle that is upgraded with the secure Gator Grip®. Includes coarse and fine blades.

OVERALL LENGTH:	13.1"
BLADE LENGTH:	10"
WEIGHT:	24 OZ
SHEATH:	INCLUDED
HANDLE:	GATOR GRIP®



BLISTER 22-49472 SNAP FIT ASSEMBLY PUSH/PULL SAWING ACTION

GATOR® SAW III™

This sheathed, packable field saw offers the ultimate in versatility. The collapsible frame format is ideal for long days in the field, and the added wing nut securement ensures your blade stays put. With a bone saw, a wood saw, and a chain saw, you are covered.

OVERALL LENGTH:	23.3"
BLADE LENGTH:	10" BONE/WOOD
	20" CHAIN SAW
WEIGHT:	32 OZ
SHEATH:	INCLUDED
HANDLE:	GATOR GRIP®



Sheath + Blades

BLISTER 22-41514

COMPACT

FINE, COARSE + CHAIN SAW

MOMENT FIXED BLADE SAW™

With an efficient design, this fixed blade saw saves body strain and time. With a clever blunt hooked tip and simple structure, easily saw through big game without fear of harming the meat. The ergonomic T-handle and advanced serrations do the hard work, not you.

OVERALL LENGTH:	7.5"
BLADE LENGTH:	5.3"
WEIGHT:	3 OZ
SHEATH:	INCLUDED
HANDLE:	MOLDED RUBBER GRIP



BLISTER

31-002751

ERGONOMIC RUBBER HANDLE

FULL TANG CONSTRUCTION

SLIDING SAW™

Sliding out from the handle in use, this blade is ideal for small brush, tree branches, and limbs. Crosscut teeth cut on the forward and backward stroke for maximum cutting ability, a rubberized handle keeps the tool securely in hand.

OVERALL LENGTH:	14.8"
BLADE LENGTH:	6.5"
WEIGHT:	5 OZ
HANDLE:	GLASS-FILLED NYLON



BLISTER 22-41773 CROSSCUT TEETH BLADE STORES IN HANDLE

MYTH® FIXED BLADE SAW™

Cleaning and dressing large game takes time and effort, luckily you have the portable Myth® Fixed Blade Saw. With a T-handle and a coated carbon steel blade, this stout hybrid handles wood and bone equally well. At the campsite, in the field, don't be without it.

OVERALL LENGTH:	10"
BLADE LENGTH:	6.7"
WEIGHT:	3.9 OZ
SHEATH:	INCLUDED
HANDLE:	NYLON W/ RUBBER OVERMOLD



BLISTER 31-002094 TITANIUM NITRIDE PVD-COATED BLADE POLYMER SHEATH

MYTH® FOLDING SAW™

Carefully designed, the Myth® Folding Saw has a functional design that proves its versatility. The 6 inch dual edge blade works through bones, antlers, and wood alike with both fine and coarse teeth. Discreetly folded away when not in use, a plunge lock keeps it secure.

OVERALL LENGTH:	15.5"
BLADE LENGTH:	6.7"
WEIGHT:	8.3 OZ
HANDLE:	TEXTURED RUBBER



BLISTER 31-001167 TEXTURED RUBBER HANDLE INLAYS PLUNGE LOCK

VITAL™ PACK SAW

This unique tool does exactly what it promises: sawing easily through the bones of big game animals in comfort. The highly visual orange handle is rubberized and designed to fit in your hand securely while sawing. Serrations are set to optimize efficiency and body strain.

OVERALL LENGTH:	6"
BLADE LENGTH:	3.4"
WEIGHT:	2.7 OZ
HANDLE:	GLASS-FILLED POLYMER W/ RUBBER OVERMOLD



BLISTER 31-002742 TEXTURED RUBBER HANDLE BONE SAW HIGHLY VISIBLE ORANGE



MULTI-TOOLS



CENTER AXIS TECH™

**THE ONLY MULTI-TOOL THAT
OPERATES LIKE A REAL SCREWDRIVER.**

MAXIMUM TORQUE + PERFORMANCE.

- + CENTER AXIS ALIGNMENT
- + 3.25 INCH LONG DRIVER
- + STANDARD MAGNETIC BIT SET

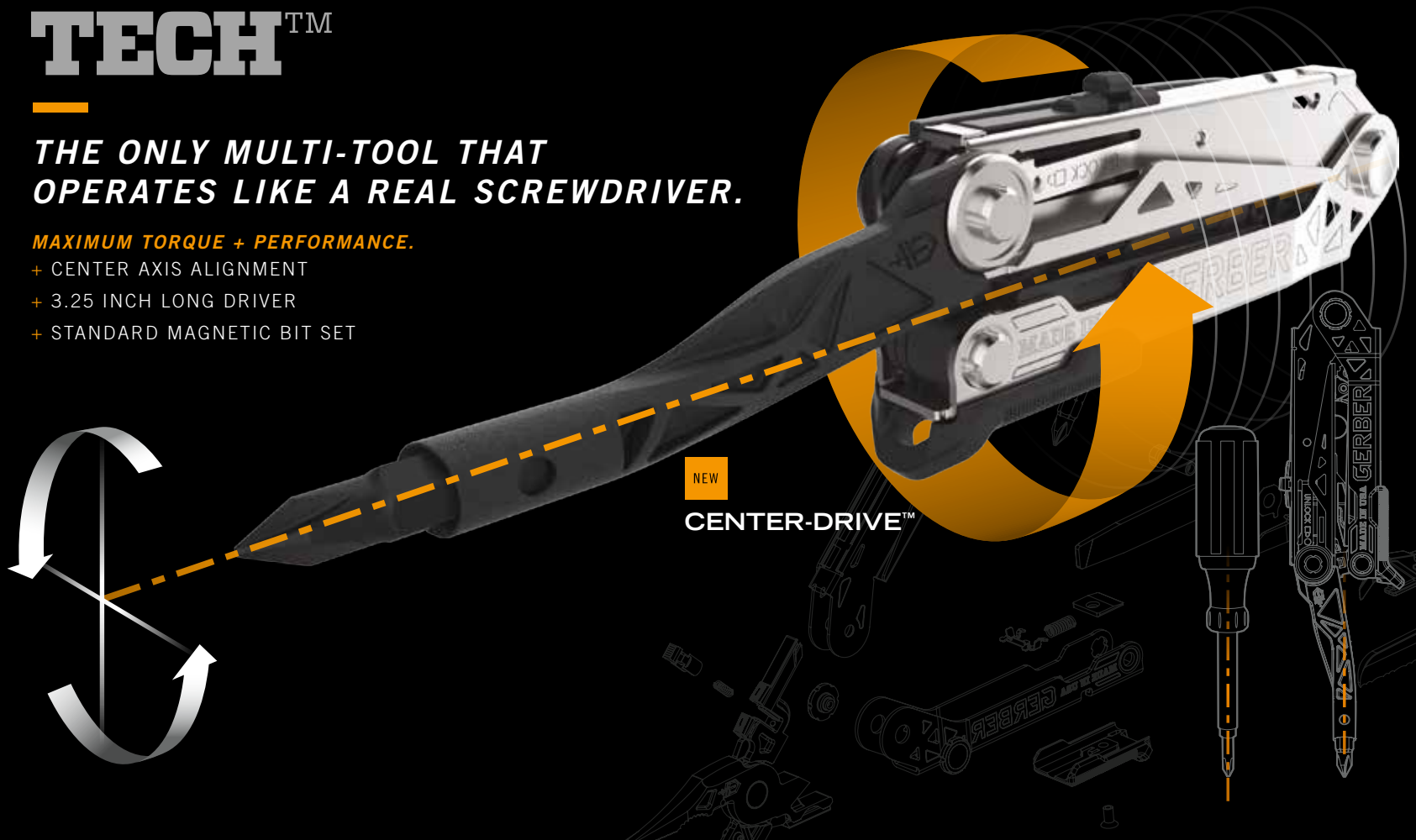

NEW

CENTER-DRIVE™

NEW

CENTER-DRIVE™

The Center-Drive offers uncompromising performance through revolutionary design. It has an innovative center-axis driver that opens to align like a real screw driver, a 30% longer outboard blade, and one-thumb opening sliding jaws. Full size, real tools - the multi-tool just got a reality check.

CLOSED LENGTH:	4.7"
OPEN LENGTH:	6.6"
WEIGHT:	9.5 OZ

CENTER AXIS TECH™



*"This tool has everything I need,
and nothing I don't."*

ALICIA ELFVING GERBER BADASSADOR

BOX	30-001193	ROTATABLE CARBIDE WIRE CUTTERS + STRIPPERS	PRY BAR, NAIL PULLER + BOTTLE OPENER	SHEATH
BLISTER	31-003073	ROTATABLE CARBIDE WIRE CUTTERS + STRIPPERS	PRY BAR, NAIL PULLER + BOTTLE OPENER	SHEATH
BOX	30-001194	ROTATABLE CARBIDE WIRE CUTTERS + STRIPPERS	PRY BAR, NAIL PULLER + BOTTLE OPENER	BITSET + SHEATH
BLISTER	31-003074	ROTATABLE CARBIDE WIRE CUTTERS + STRIPPERS	PRY BAR, NAIL PULLER + BOTTLE OPENER	BITSET + SHEATH
BOX	30-001195	ROTATABLE CARBIDE WIRE CUTTERS + STRIPPERS	PRY BAR, NAIL PULLER + BOTTLE OPENER	MOLLE SHEATH
BLISTER	31-003075	ROTATABLE CARBIDE WIRE CUTTERS + STRIPPERS	PRY BAR, NAIL PULLER + BOTTLE OPENER	MOLLE SHEATH
BOX	30-001196	ROTATABLE CARBIDE WIRE CUTTERS + STRIPPERS	PRY BAR, NAIL PULLER + BOTTLE OPENER	BITSET + MOLLE SHEATH
BLISTER	31-003076	ROTATABLE CARBIDE WIRE CUTTERS + STRIPPERS	PRY BAR, NAIL PULLER + BOTTLE OPENER	BITSET + MOLLE SHEATH

- ONE THUMB OPENING SYSTEM
- SPRING-LOADED PLIERS
- CENTER AXIS DRIVER
- FULL SIZE FINE EDGE BLADE
- SHEATH INCLUDED



Bitset



DIESEL™

Big. Tough. Capable. Versatile. The Diesel is all of these things and more, available to you at the flick of a wrist. With true one-handed deployment, this tool is the ultimate in efficiency. The industrial strength components are larger and stronger, for the toughest of jobs.

OVERALL LENGTH: 6.6"
CLOSED LENGTH: 4.9"
WEIGHT: 8.6 OZ

- Partially serrated blade
- V-cut wire cutters
- Small, medium, & large flat drivers
- Phillips driver
- Scissors
- File
- Bottle opener
- Can opener
- Saw



"Very tough and very useful!"



JEREMY, NEW ZEALAND



22-41470 /
22-01470
Stainless

BLISTER	22-41545	NEEDLE NOSE PLIERS	SAFT.PLUS™ LOCKING KNIFE & TOOLS	BLACK
BOX	22-01545	NEEDLE NOSE PLIERS	SAFT.PLUS™ LOCKING KNIFE & TOOLS	BLACK
BLISTER	22-41470	NEEDLE NOSE PLIERS	SAFT.PLUS™ LOCKING KNIFE & TOOLS	STAINLESS
BOX	22-01470	NEEDLE NOSE PLIERS	SAFT.PLUS™ LOCKING KNIFE & TOOLS	STAINLESS



MP400™ COMPACT SPORT

Building on the success of the larger one-hand opening models, this compact version is nimble but just as tough. Built to solve for everyday snags, this tool has 12 carefully chosen components packed into an unobtrusive 7 ounce package. Built in the USA, built to last.

OVERALL LENGTH:	5.6"
CLOSED LENGTH:	4.4"
WEIGHT:	6.8 OZ

- Partially serrated blade
- Wire cutters
- Wire stripper
- Small, medium & large flat drivers
- Phillips driver
- Scissors
- Bottle opener
- Can opener

"Love it. Would not go to the woods without it."

★★★★★
VEARL WILLIAMS



45500 / 05500
Stainless



MP600™ BASIC

As the #1 selling multi-tool platform to the US military, the MP600 series has been to hell and back. Serving those who serve, this tool is built to be tough and accessible. A one-hand opening design is crucial, as is the durable stainless body, the variety of 14 tools, and multiple versions that are specialized for any situation.

OVERALL LENGTH:	6.4"
CLOSED LENGTH:	4.9"
WEIGHT:	9.0 OZ

- Fine edge blade
- Serrated blade
- Wire crimper
- Jaw wire cutters
- Small, medium & large flat drivers
- Phillips driver
- File
- Ruler
- Bottle opener
- Can opener
- Key chain ring

"One of the best tools I've ever owned."

★★★★★
JASON C, USMC VETERAN



47550 / 07550
Black



BLISTER	45509	NEEDLE NOSE PLIERS	SAF.T.PLUS™ LOCKING KNIFE & TOOLS	BLACK
BOX	05509	NEEDLE NOSE PLIERS	SAF.T.PLUS™ LOCKING KNIFE & TOOLS	BLACK
BLISTER	45500	NEEDLE NOSE PLIERS	SAF.T.PLUS™ LOCKING KNIFE & TOOLS	STAINLESS
BOX	05500	NEEDLE NOSE PLIERS	SAF.T.PLUS™ LOCKING KNIFE & TOOLS	STAINLESS

BLISTER	47530	NEEDLE NOSE PLIERS	SAF.T.PLUS™ LOCKING KNIFE & TOOLS	STAINLESS
BOX	07530	NEEDLE NOSE PLIERS	SAF.T.PLUS™ LOCKING KNIFE & TOOLS	STAINLESS
BLISTER	47550	NEEDLE NOSE PLIERS	SAF.T.PLUS™ LOCKING KNIFE & TOOLS	BLACK
BOX	07550	BLUNT NOSE PLIERS	SAF.T.PLUS™ LOCKING KNIFE & TOOLS	STAINLESS

MP600™ CARBIDE

As the #1 selling multi-tool platform to the US military, the MP600 series has been to hell and back. Still inclusive of everything that makes the original great, this version of the tool features replaceable Tungsten Carbide wire cutters. Some situations require a little extra grit.

OVERALL LENGTH:	6.4"
CLOSED LENGTH:	4.9"
WEIGHT:	9.0 OZ

- Fine edge blade
- Serrated blade
- Wire crimper
- Tungsten carbide cutters
- Small, medium & large flat drivers
- Phillips driver
- Saf.T.Plus™ locking knife & tools
- File
- Ruler
- Bottle opener
- Can opener
- Key chain ring



BOX	07500 / 07500G	BLUNT NOSE PLIERS	STAINLESS	
BOX	07505G	BLUNT NOSE PLIERS	STAINLESS	LEATHER SHEATH
BLISTER	07510G	BLUNT NOSE PLIERS	STAINLESS	TOOL KIT
BOX	07520	BLUNT NOSE PLIERS	BLACK	
BOX	07520G1	BLUNT NOSE PLIERS	BLACK	BERRY SHEATH
BLISTER	07530G	NEEDLE NOSE PLIERS	STAINLESS	
BOX	07535G	NEEDLE NOSE PLIERS	STAINLESS	LEATHER SHEATH
BOX	07550G1	NEEDLE NOSE PLIERS	BLACK	BERRY SHEATH
BOX	30-000314	NEEDLE NOSE PLIERS	BLACK	LEATHER SHEATH
BOX	30-000453	NEEDLE NOSE PLIERS	BLACK	TAN499 BERRY SHEATH
BOX	30-000952	NEEDLE NOSE PLIERS	BLACK BLADELESS	SCISSORS
				REMGKIT® SAW



MP600 PRO SCOUT™

As the #1 selling multi-tool platform to the US military, the MP600 series has been to hell and back. Serving those who serve, this tool is built to be tough and accessible. A one-hand opening design is crucial, as is the durable stainless body, the variety of 14 tools, and multiple versions that are specialized for any situation.

OVERALL LENGTH:	6.6"
CLOSED LENGTH:	5.0"
WEIGHT:	9.0 OZ

- Partially serrated blade
- Wire cutters
- Wire crimper
- Small & medium flat drivers
- Phillips driver
- Scissors
- RemGrit® saw
- File
- Ruler
- Bottle opener
- Can opener



BLISTER	47563	NEEDLE NOSE PLIERS	SAF.T.PLUS™ LOCKING KNIFE & TOOLS	STAINLESS
BOX	07563	NEEDLE NOSE PLIERS	SAF.T.PLUS™ LOCKING KNIFE & TOOLS	STAINLESS
BOX	07564	NEEDLE NOSE PLIERS	SAF.T.PLUS™ LOCKING KNIFE & TOOLS	STAINLESS W/ TOOLKIT



MP600™ D.E.T.

Designed specifically with the combat engineer in mind, this version of the MP600 is built to offer compact versatility. Covered in a black, non-reflective coating that won't give you away, this tool is easily accessible with one hand. Built with task-specific tools, this tool is invaluable.

OVERALL LENGTH:	6.6"
CLOSED LENGTH:	5.0"
WEIGHT:	9.0 OZ

- C4 punch
- Blasting cap crimper
- Partially serrated blade
- Wire cutters
- Wire crimper
- Large flat driver
- Phillips driver
- RemGrit® saw
- File
- Ruler
- Can opener
- Key chain ring



"I have used this piece of kit during my past four deployments. Probably my most used tool of all."

★★★★★
JOHN LIDER, US ARMY



MP600-ST™ [SIGHT TOOL]

Built on the successful one-handed design of the MP600 series, this updated version has a more focused objective. With a longer Phillips driver, a serrated/fine edge blade, a carbon scraper for maintenance, and a front sight adjustment tool it will quickly be indispensable.

OVERALL LENGTH:	6.5"
CLOSED LENGTH:	4.0"
WEIGHT:	9.6 OZ

- Stainless steel w/ black oxide finish
- M4/M16 Front sight post adjustment tool
- Carbon scraper
- Partially serrated blade
- Carbide wire cutters
- Small & medium flat drivers
- Long reach Phillips driver
- Scissors
- File
- Bottle opener
- Can opener
- Saw
- Key chain ring



Sheath Made in China

BOX 07400 NEEDLE NOSE PLIERS SAF.T.PLUS™ LOCKING KNIFE & TOOLS NON-REFLECTIVE BLACK FINISH

BLISTER BOX	31-001519	NEEDLE NOSE PLIERS	SAF.T.PLUS™ LOCKING KNIFE & TOOLS BLACK	SHEATH
BOX	30-000588	NEEDLE NOSE PLIERS	SAF.T.PLUS™ LOCKING KNIFE & TOOLS BLACK	SHEATH
BOX	30-000513	NEEDLE NOSE PLIERS	SAF.T.PLUS™ LOCKING KNIFE & TOOLS BLACK	BERRY SHEATH

BG COMPACT TOOL™

Compact enough to fit on your keychain or in your pocket yet reliably versatile with 10 tools, this pint-sized multi-tool doesn't skimp when it's backed by Bear. The only compact multi-plier with 2 full size blades, you will never be unprepared with this in tow.

OVERALL LENGTH:	4.3"
CLOSED LENGTH:	2.5"
WEIGHT:	3.0 OZ

- Fine edge blade
- Wire cutters
- Small & medium flat drivers
- Phillips driver
- Tweezers
- Bottle opener
- Key chain ring
- Priorities of Survival Pocket Guide



BLISTER	31-000750	NEEDLE NOSE PLIERS	PRIORITIES OF SURVIVAL POCKET GUIDE
---------	-----------	--------------------	-------------------------------------

CRUCIAL™

This light, everyday carry multi-plier gets an unexpected upgrade with professional-grade tools that are reliably tough. Made of stainless steel and available in multiple colors, this tool has precise needle nose pliers and 8 other components secured in a convenient butterfly style.

OVERALL LENGTH:	5.5"
CLOSED LENGTH:	3.6"
WEIGHT:	5.0Z

- Stainless steel
- Liner lock
- Partially serrated blade
- Large flat driver
- Phillips head driver
- Bottle opener

"Great little pocket tool. Handy to have, saves a few extra trips to the truck to get a screw driver, etc."

★★★★
JORDAN PLUMBER



31-001518
w/ strap cutter

BLISTER	31-002951	NEEDLE NOSE PLIERS	BLUE	CARABINER CLIP
BOX	30-001079	NEEDLE NOSE PLIERS	BLUE	CARABINER CLIP
BLISTER	31-001518	NEEDLE NOSE PLIERS	BLACK W/STRAP CUTTER	BLACK STAINLESS STEEL
BLISTER	31-000014	NEEDLE NOSE PLIERS	GRAY	CARABINER CLIP
BOX	30-000016	NEEDLE NOSE PLIERS	GRAY	CARABINER CLIP
BLISTER	31-000238	NEEDLE NOSE PLIERS	GREEN	CARABINER CLIP
BOX	30-000140	NEEDLE NOSE PLIERS	GREEN	CARABINER CLIP

DIME™

The idea is simple: always be prepared. The Dime is a mini multi-plier with an impressive list of features, ensuring you are ready for anything. This butterfly open tool fits on your keychain yet has 12 useful tools. Available in multiple colors and a bladeless version as well.

OVERALL LENGTH:	4.3"
CLOSED LENGTH:	2.8"
WEIGHT:	2.2 OZ
STEEL:	3CR13



Bladeless

- Stainless steel
- Spring-loaded jaw
- Spring-loaded scissors
- Retail package opener, except Bladeless 31-001023 / 30-002777
- Fine edge blade, except Bladeless 31-001023 / 30-002777
- Wire cutters
- Small & medium flat drivers
- Tweezers
- File
- Bottle opener
- Key chain ring

BLISTER	31-002937	NEEDLE NOSE PLIERS	PURPLE	RETAIL PACKAGE OPENER
BLISTER	31-001040	NEEDLE NOSE PLIERS	RED	RETAIL PACKAGE OPENER
BOX	30-000417	NEEDLE NOSE PLIERS	RED	RETAIL PACKAGE OPENER
BLISTER	31-001132	NEEDLE NOSE PLIERS	GREEN	RETAIL PACKAGE OPENER
BLISTER	31-001134	NEEDLE NOSE PLIERS	BLACK	RETAIL PACKAGE OPENER
BOX	30-000469	NEEDLE NOSE PLIERS	BLACK	RETAIL PACKAGE OPENER
BLISTER	31-001023	NEEDLE NOSE PLIERS	BLACK	CARRY ON FRIENDLY, BLADELESS ZIPPER HOOK
BOX	30-002777	NEEDLE NOSE PLIERS	BLACK	CARRY ON FRIENDLY, BLADELESS ZIPPER HOOK

EVO TOOL™

Based on the sleek, simple style of its knife counterparts, this tool is no frills and features easily accessed outboard components. Every component is locking, ensuring a confident grip and safety. Housed in a nylon sheath, this 12 feature tool is always nearby.

OVERALL LENGTH:	6.0"
CLOSED LENGTH:	3.9"
WEIGHT:	9.3 OZ



- Stainless steel E-coat
- Thumbstud
- Scissors
- Fine edge blade
- Serrated blade
- Wire cutters
- Small & medium flat drivers
- Phillips driver
- Bottle opener
- Can opener
- Saw
- Key chain ring

BLISTER	22-41771	NEEDLE NOSE PLIERS	SAFT.PLUS™ LOCKING KNIFE & TOOLS	SHEATH
---------	----------	--------------------	----------------------------------	--------

MP1™

Simple doesn't have to mean boring. On the contrary, the MP1 Multi-Plier is proof that when done with care and 12 professional-grade components, simple can be all you need. A butterfly open design, high quality carbon steel, and spring-loaded pliers are only the beginning.

OVERALL LENGTH:	6.9"
CLOSED LENGTH:	4.4"
WEIGHT:	8 OZ

- Forged, spring-loaded plier jaws
- Textured G-10 composite handles
- Large fine edge blade
- Large serrated blade
- Utility blade/scraper
- Wire stripper
- Diagonal cutters
- Small & large flat drivers
- Magnetic bit driver w/ #2 Phillips
- Pry bar
- Bottle opener
- Key chain ring



BLISTER	31-001142	NEEDLE NOSE PLIERS	2 POSITION [HORIZONTAL/VERTICAL] SHEATH
BOX	30-000477	NEEDLE NOSE PLIERS	2 POSITION [HORIZONTAL/VERTICAL] SHEATH
BOX	30-001009	NEEDLE NOSE PLIERS	BERRY SHEATH – TAN499



MP1-AR™ WEAPONS TOOL

As an ally to the US military, Gerber understands the specific needs of those who serve. This new evolution of a classic is focused on weapons cleaning and maintenance, loaded with task-specific tools and a 12 piece universal bit set. A MOLLE-compatible sheath is included.

OVERALL LENGTH:	7.3"
CLOSED LENGTH:	4.3"
WEIGHT W/SHEATH:	9.7 OZ

- Forged, spring-loaded plier jaws
- Large fine edge blade
- Large serrated blade
- Carbon scraper
- Takedown pin punch
- Dental-style carbon pick
- Wire stripper
- Wire cutter
- Magnetic bit driver w/
 - Torx bits
 - Hex bits
 - Phillips bits
 - Front sight adjustment tool
 - Trigger assembly pin punch

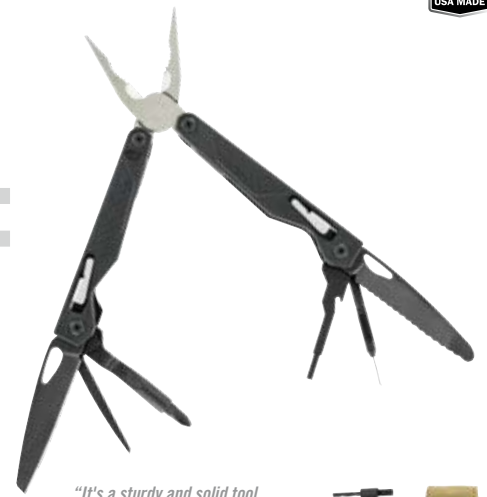

"It's a sturdy and solid tool and all of the implements are actually useful...it exudes quality, and attention to detail is second to none. Highly recommended. Big thumbs up."



GEOFF METAK, SGT. MAJOR 4TH MARINE LOGISTICS GROUP

BLISTER	31-002779	NEEDLE NOSE PLIERS	MOLLE COMPATIBLE COYOTE SHEATH	12 PIECE BIT SET
BOX	30-001024	NEEDLE NOSE PLIERS	MOLLE COMPATIBLE COYOTE SHEATH	12 PIECE BIT SET



MP1-MRO™ [MAINTENANCE, REPAIR & OPERATIONS] TOOL

As an ally to the US military, Gerber understands the specific needs of those who serve. This new evolution of a classic is focused on maintenance, repairs, and operations, loaded with task-specific tools for your vehicle and a 12 piece universal bit set. A MOLLE-compatible sheath is included.

OVERALL LENGTH:	7.3"
CLOSED LENGTH:	4.3"
WEIGHT:	9.7 OZ

- Forged, spring-loaded plier jaws
- 42ØHC fine edge blade
- 42ØHC serrated blade w/ hook blade
- Utility blade
- Cotter pin hook
- File w/ tire tread gauge
- Pry bar w/ bottle opener



Bit Set



LEGEND MP800™

In terms of reliable comfort, the Legend has no equal. With a strong stainless steel body and contoured aluminum handles with tactile rubber inserts, this tool remains steadily in hand for tough jobs. Spring-loaded pliers relieve hand strain while each tool serves a purpose.

OVERALL LENGTH:	6.6"
CLOSED LENGTH:	4.3"
WEIGHT:	9.8 OZ

- Stainless steel E-coat
- Aluminum handles w/ rubber inserts
- RemGrit® saw
- Partially serrated blade
- Tungsten carbide cutters
- Small, medium, & large flat drivers
- Phillips driver
- Scissors
- File
- Bottle opener
- Key chain ring



"I would rather forget my lunch than this tool when going to work. Used daily for over 2 years and have been dropped several times from height and still going strong!"

★★★★★

CURTIS TALLEY,

WIND TURBINE TECHNICIAN



BOX	30-001031	NEEDLE NOSE PLIERS	SPRING-LOADED PLIER JAWS	12 PIECE BIT SET
-----	-----------	--------------------	--------------------------	------------------

BLISTER	48239	NEEDLE NOSE PLIERS	SAFT.PLUS™ LOCKING KNIFE & TOOLS SHEATH
BOX	08239	NEEDLE NOSE PLIERS	SAFT.PLUS™ LOCKING KNIFE & TOOLS SHEATH
BLISTER	08239G1	NEEDLE NOSE PLIERS	SAFT.PLUS™ LOCKING KNIFE & TOOLS BERRY COMPLIANT SHEATH

SPLICE POCKET TOOL™

This handy pocket tool is small in size, not in function. With a convenient butterfly open design and 8 useful components, this keychain ready mini tool is never too far out of reach.

OVERALL LENGTH:	4.0"
CLOSED LENGTH:	2.4"
WEIGHT:	2.5 OZ

- Stainless steel / black
- Fine edge blade
- Serrated blade
- Small & medium flat drivers
- Scissors
- File
- Bottle opener
- Key chain ring



BLISTER 31-000013 SCISSORS BLACK

STRATA™

Slim, sleek, and stock full of functionality, this everyday carry multi-plier is loaded with easily accessible outboard components. The butterfly open design features spring-loaded pliers for reduced strain over long use, as well as 13 other useful tools for your daily tasks.

OVERALL LENGTH:	6.0"
CLOSED LENGTH:	4.0"
WEIGHT:	9.8 OZ

- Stainless steel E-coat
- Partially serrated blade
- Tungsten carbide cutters
- Small & large flat drivers
- Phillips driver
- Scissors
- Retail package opener
- File
- Bottle opener
- Can opener
- Saw
- Key chain ring



"...I am outdoors hunting when I'm not outdoors working. I have had several of the other tools from the first on the market and this is far superior in quality. Biggest advantages of this tool are the locking blades and spring-loaded main tool/pliers. They just keep getting better. Excellent quality and grade."

★★★★★
BRENT, FORESTER

BLISTER 31-000334 NEEDLE NOSE PLIERS SAFET.PLUS™ LOCKING KNIFE & TOOLS

SUSPENSION™

A field-tested classic that never disappoints, the Suspension is the benchmark tool of convenience and durability. The easily accessed butterfly design features spring-loaded pliers and a lightweight frame for long days and tired hands. With 12 other tools, you're always ready.

OVERALL LENGTH:	6.0"
CLOSED LENGTH:	4.0"
WEIGHT:	9.6 OZ

- Open frame design
- Spring-loaded plier jaws
- Fine edge blade
- Serrated blade
- Wire cutters
- Small & medium flat drivers
- Phillips driver
- Scissors
- File
- Bottle opener
- Can opener
- Saw
- Key chain ring



"This is an awesome, yet practical tool ideal for the everyday adventurer."



NOAH ROWLAND, EDC SPECIALIST



BLISTER BOX	22-41471 22-01471	NEEDLE NOSE PLIERS NEEDLE NOSE PLIERS	SAFT.PLUS™ LOCKING KNIFE & TOOLS SAFT.PLUS™ LOCKING KNIFE & TOOLS	STAINLESS TI-NITRIDE SHEATH
-------------	----------------------	--	--	--------------------------------

BG ULTIMATE TOOL™

With rugged construction, spring-loaded pliers, outboard locking tools, and an extra grippy handle, this is Bear Grylls' go-to survival tool. Containing 12 stainless steel, weather-resistant tools that lock while in use, this is a safe, reliable multi-plier to have in the wild.

OVERALL LENGTH:	6.3"
CLOSED LENGTH:	4.0"
WEIGHT:	8.8 OZ

- Spring-loaded plier jaws
- Ergonomic, textured rubber grip
- Stainless steel, weather-resistant components
- Fine edge blade
- Serrated blade
- Wire cutters
- Small & medium flat drivers
- Phillips driver
- Scissors
- Bottle opener
- Can opener
- Saw
- Key chain ring
- Priorities of Survival Pocket Guide



BLISTER BOX	31-000749	NEEDLE NOSE PLIERS	SAFT.PLUS™ LOCKING KNIFE & TOOLS	SHEATH
-------------	-----------	--------------------	----------------------------------	--------

WISE POCKET TOOL™

Stripped to the bare bones of a multiplier, this compact pocket companion has everything you need and nothing you don't. With a keychain attachment to always keep it handy, you will find unlimited uses for daily tasks. Easy to open, easy to use, indispensable.

OVERALL LENGTH:	4.0"
CLOSED LENGTH:	2.4"
WEIGHT:	2.5 OZ

- Stainless steel / black
- Fine edge blade
- Serrated blade
- Small & medium flat drivers
- File
- Bottle opener
- Key chain ring



BLISTER 31-000021 NEEDLE NOSE PLIERS BLACK



NEW

SHORT STACK™ – AR-15 MAINTENANCE TOOL

The answer to your field cleaning and maintenance needs, this revolutionary three-piece design is magnetic, smartly designed, and able to fit snugly into Magpul MOE and MIAD pistol grips. Always on hand and the first of its kind, this tool is loaded with weapon-specific features.

OVERALL LENGTH: 2.9"
WEIGHT: 2.8 OZ

- Windage & elevation site adjustment tool
- Firing pin scraper
- Buffer tube wrench
- Cleaning cable pull through handle
- 4mm wrench
- T10 Torx
- #0 cross driver
- 1/8" hex
- Bolt carrier scraper
- 1/2" 3/8" & 3/4" wrench
- 7mm M-Lok wrench
- Fits inside Magpul, MOE & MIAD grips



"Received mine and put it to use right away. As with all Gerber products I own, this tool is awesome. It is a must have for any AR owner. Thanks Gerber I love it."

★★★★★
RICK CRAMER



SHARD KEYCHAIN TOOL™

Perhaps the most simply designed tool in your arsenal, this keychain companion should not be underestimated. With 7 essentials functions built in, this airline-safe tool is ideal for everyday travel and tasks. A titanium nitride coating protects against corrosion for long use.

OVERALL LENGTH: 2.75"
WEIGHT: 0.6 OZ

- Stainless steel
- Wire stripper
- Small & medium flat drivers
- Phillips driver
- Pry bar
- Bottle opener
- Key chain ring



BLISTER 31-00297 420HC TOOLS MULTIPLE SCRAPING SURFACES
BOX 30-001113 420HC TOOLS MULTIPLE SCRAPING SURFACES

BOX 22-01769 AIRLINE SAFE TITANIUM-NITRIDE COATED 7 FUNCTIONS

NEW

SPAN ARCHERY SOLID STATE TOOL™

Proudly built in America, this revolutionary tool offers 19 different functions on one solid state structure. Providing bow-hunting enthusiasts with essential repair and maintenance tools, this portable workhorse is endlessly customizable to fit your needs in the field.

OVERALL LENGTH:	8.2"
WEIGHT:	3.2 OZ
MAX CUT. DIA.:	.75:
STEEL:	42ØHC

- 19 Tools - 1 solid state
- 1/4" Standard bit tip driver
- Bit tip storage
- Torque generating design
- Integrated blade sharpener
- Broadhead wrench
- 3X hex wrench
- Bottle opener



BLISTER 31-ØØ2944

CAST ALUMINUM W/ TPR MOLDED GRIP HANDLE

NEW

SPAN SHOTGUN SOLID STATE TOOL™

Proudly built in America, this revolutionary tool offers 14 different functions on one solid state structure. Providing shotgun-hunting enthusiasts with essential repair and maintenance tools, this portable workhorse is endlessly customizable to fit your needs in the field.

OVERALL LENGTH:	8.2"
WEIGHT:	3.2 OZ
MAX CUT. DIA.:	.75:
STEEL:	42ØHC

- 14 Tools - 1 solid state
- 1/4" Standard bit tip driver
- Bit tip storage
- Torque generating design
- 6 bit tips
- Pin punch
- 3X hex wrench
- Choke tube wrench
- Bottle opener



BLISTER 31-ØØ2945

CAST ALUMINUM W/ TPR MOLDED GRIP HANDLE

CABLE DAWG™

Originally developed for US military communications personnel, this invaluable tool is a specialized, industrial-grade multi-tool for work on fiber optic, IT, and cable systems. Loaded with industry-specific features, the Cable Dawg will save you multiple trips to the toolbox.

OVERALL LENGTH: 7.5"
WEIGHT: 13.1 OZ

- Spring-loaded plier jaws
- Partially serrated blade w/ jacket cutter
- Wire cutter
- Wire stripper
- Cable cutter
- CAT5 jacket cutter
- RJ45 crimper head
- Detachable component handle
- Magnetic driver extension
- Multiple driver storage compartment

"Great tool! Used this downrange on deployments all over CENTCOM."

★★★★
BRANDON, NAVY IT



CREW SERVED WEAPONS TOOL™

Compact and durable, the Crew Served Weapons Tool is the answer to the battlefield maintenance of the US Army's two most fielded automatic weapons' systems: The M249 Squad Automatic Weapon and M240 Crew Served Weapon. MOLLE-compatible sheath included.

OVERALL LENGTH: 3.8" X 1.3" X .96"
WEIGHT: 4.5 OZ

M240 Features

- Gas block:
 - barrel scraper
 - outer groove scraper
 - shoulder scraper
 - port punch
- Piston:
 - scraper

M249 Features

- Gas block:
 - removal tool
 - barrel scraper
 - shoulder scraper
 - inner groove scraper
 - outer groove scraper
 - port punch
- Piston:
 - inner cup scraper
 - outer groove scraper
- Gas tube:
 - inner groove scraper

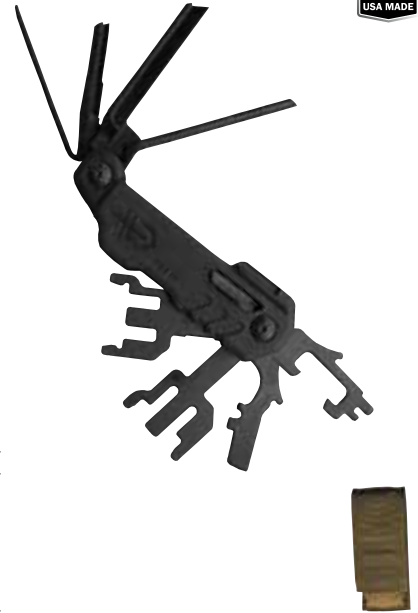

BOX	30-000399	GLASS-FILLED NYLON MOLDED HANDLES	BLACK SHEATH
BOX	30-000397	GLASS-FILLED NYLON MOLDED HANDLES	COYOTE BROWN SHEATH
BOX	30-000398	GLASS-FILLED NYLON MOLDED HANDLES	MULTI-CAM SHEATH

BOX	30-000853	M240 & M249 AUTOMATIC WEAPONS TOOL	MOLLE-COMPATIBLE SHEATH
-----	-----------	------------------------------------	-------------------------

CURVE™

Creatively styled yet functional for everyday use, this keychain compatible tool is perfectly sized to be ready when you need it. Surprisingly strong and secure, the tool's components lock while in use to ensure safety.

OVERALL LENGTH:	3.5"
CLOSED LENGTH:	2.3"
WEIGHT:	1.0 OZ



- Stainless steel
- Fine edge blade
- Small & medium flat drivers
- Phillips driver
- File
- Bottle opener
- Carabiner

BLISTER	31-000116	SAF.T.PLUS™ LOCKING KNIFE & TOOLS	BLUE
BLISTER	31-000206	SAF.T.PLUS™ LOCKING KNIFE & TOOLS	GRAY

eFECT™ / eFECT™ II

The first of its kind, the eFECT weapons maintenance tool was created for the distinct purpose of cleaning and maintaining an AR15/M16/M4 variant firearm. With direct input from US military personnel, each component has been thoughtfully designed.

OVERALL LENGTH:	EFFECT: 8.0"
	EFFECT II: 5.7"
CLOSED LENGTH:	3.5"
WEIGHT:	EFFECT: 3.2 OZ
	EFFECT II: 5.4 OZ

eFECT

- Stainless steel - black
- Takedown punch
- Carbon scraper
- Front sight post adjuster
- Flat driver/scraper
- Interchangeable tool: OTIS™ nylon end brush
- Interchangeable Tool: OTIS™ curved pick

eFECT II

- Stainless steel - black
- Takedown pin punch
- M249 carbon scraper
- M4 / M16 bolt scraper
- Detachable dental style carbon pick
- Flat head driver



"I was given one of these to field test. Love it, worked on all of our weapon systems. Have to guard it though... the Infantry guys are always looking to steal it."

★★★★★

ERIC DAVIS, ARMY EOD

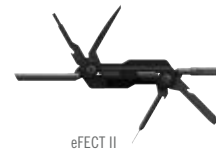

eFECT II



TAN499

BLISTER	31-000049	EFFECT MILITARY MAINTENANCE TOOL	SAF.T.PLUS™ LOCKING	SHEATH
BOX	30-000030	EFFECT MILITARY MAINTENANCE TOOL	SAF.T.PLUS™ LOCKING	SHEATH
BLISTER	31-002782	EFFECT II, AR-15 MAINTENANCE TOOL	SAF.T.PLUS™ LOCKING	MOLLE-COMPATIBLE SHEATH
BOX	30-001025	EFFECT II, AR-15 MAINTENANCE TOOL	SAF.T.PLUS™ LOCKING	MOLLE-COMPATIBLE SHEATH

GDC™ – GERBER DAILY CARRY, ZIP BLADE

Gerber understands that being prepared isn't a one time occurrence, it is a way of life. The Gerber Daily Carry series is designed to keep you one step ahead with portable, easy to use tools that connect to your zipper or keychain. The range of tools can handle any task.



BLADE LENGTH:	.7"
OVERALL LENGTH:	GDC BLADE: 2.3"
	GDC LIGHT: 1.8"
WEIGHT:	GDC BLADE: 3.2 OZ
HANDLE:	CR13
BLADE:	7CR17

- Blade
- Utility blade
- Frame lock
- Light
- 8 Lumen LED light
- Momentary on
- Bottle opener
- [2] CR1616 Lithium batteries included



Zip Light

BLISTER	31-001742	QUICK RELEASE CLIP	ZIPPER ATTACHMENT	GDC ZIP BLADE
BLISTER	31-001745	QUICK RELEASE CLIP	ZIPPER ATTACHMENT	GDC ZIP LIGHT

BG GREENHORN TOOL™

With a focus on ease of use and safety and backed by Bear, the Greenhorn tool features 7 functions in one pocket-friendly package. Earn your stripes with a blunt tip large fine edge blade, full-size Phillips driver, flat driver, bottle opener, can opener, pick, and tweezers.

OVERALL LENGTH:	3.2" X .9" X .8"
BLADE LENGTH:	2.3"
WEIGHT:	2.4 OZ
STEEL:	5CR15MOV

- 7 tools
- Blunted tip fine edge blade
- Medium flat driver
- Phillips driver
- Bottle opener
- Can opener
- Tweezers
- Pick



BLISTER	31-002784	LARGE THUMB STUD	POLYPROPYLENE W/ RUBBER OVERMOLD SCALES
---------	-----------	------------------	---

BG POCKET TOOL™

An evolution of the classic tool, this version features the survival acumen of Bear Grylls. This portable tool has 5 essential tools you need for any job: a large fine edge blade, bottle opener, Phillips head driver, and small/medium flat driver secured by a tough rubber handle.

OPEN LENGTH:	5.5"
CLOSED LENGTH:	4.0"
WEIGHT:	2.9 OZ
BLADE:	5CR15

- 5 components
- Fine edge blade
- Small & medium flat drivers
- Phillips driver
- Bottle opener
- Priorities of Survival Pocket Guide



BLISTER

31-001050

RUBBERIZED HANDLE

5CR15 STAINLESS STEEL



10 PIECE TOOL KIT™

For added functionality no multi-plier should be without, grab this 10 piece universal bit set that is compatible with multiple multi-plier platforms. With an adapter and 3 sizes each of flat head, cross point, and hex head bits, there isn't much won't be able to do.



"I have used mine with my Gerber too many times to count. From sighting in a gun to adjusting the sights on my bow. And it has saved my butt i don't know how many times when in the field while I was in the USMC. I was a Comm guy, and not the field radio kind, I supplied phone and internet in the middle of nowhere. Our kits were never complete, and most times I never even looked. I would just grab my Gerber, it was always on my belt. Love my Gerber."

★★★★★

HEATH STEVENS, US MARINE VETERAN

BLISTER 45200

FOR MP400, MP600, MP650, MP700 & MP800

CARBIDE CUTTER INSERT REPLACEMENTS™

Servicing a number of the Gerber multi-plier platforms, these carbide cutter insert replacements are a lifesaver. Once you have used all three rotations of the current insert, replacement is a breeze with the T8 wrench, 4 replacement screws, and 2 included replacement blades.



BLISTER 48252

FOR MP600 BASIC [SELECT MODELS ONLY], MP800 LEGEND



LIGHTING



BG HANDS-FREE TORCH™

No matter the problem you are solving for in the wild, you are more than likely going to need your hands. The Hands-Free Torch is an adjustable head lamp with three settings [bright, low, off] that allow you to tackle any task, hands-free or otherwise.

OVERALL LENGTH:	2.5"
OVERALL WIDTH:	1.3"
WEIGHT:	1.65 OZ
BATTERIES:	[1] AAA
MODES:	HIGH/LOW/OFF

- LED
- Low: 8 lumens/15 hrs
- High: 25 lumens/5 hrs
- Adjustable lamp
- Hands-free
- Priorities of Survival Guide



BLISTER	31-001028	WHITE LIGHT	1-AAA ALKALINE BATTERY	HEADBAND STOWS EXTRA BATTERY
---------	-----------	-------------	------------------------	------------------------------

CORTEX™ FLASHLIGHT

Adaptability is a part of life for the modern tactical professional, every item must be worth its weight. The Cortex flashlight can utilize multiple power sources, running on 3 lithium CR123 or 2 AA batteries. With a max output of 675 lumens and a strobe option, you will never be in the dark.

OVERALL LENGTH:	6.2"
WEIGHT:	4.8 OZ
BATTERIES:	[3] LITHIUM CR123 OR [2] AA
MODES:	HIGH/LOW/STROBE

- LED [Cree XML]
- AA / Low: 28 lumens/15 hrs
- AA/ High: 390 lumens/1 hr
- CR123 / Low: 30 lumens/40 hrs
- CR123 / High: 675 lumens/1.75 hrs
- Water penetration rating: IPX7



BLISTER	31-001879	WHITE LIGHT	2-AA ALKALINE BATTERIES	ALUMINUM
BOX	30-000821	WHITE LIGHT	2-AA ALKALINE BATTERIES	ALUMINUM



CORTEX COMPACT™ FLASHLIGHT

Adaptability is a part of life for the modern tactical professional, every item must be worth its weight. This compact flashlight can utilize multiple power sources, running on 1 lithium CR123 or 1 AA battery. With a max output of 175 lumens and a strobe option, you will never be in the dark.

OVERALL LENGTH:	4.0"
WEIGHT:	2.1 OZ
BATTERIES:	[1] LITHIUM CR123 OR [1] AA
MODES:	HIGH/LOW/STROBE

- LED [Cree XPG]
- AA / Low: 30 lumens/4.5 hrs
- AA/ High: 150 lumens/.75 hr
- CR123 / Low: 30 lumens/9 hrs
- CR123 / High: 175 lumens/2 hrs



FREESCAPE™ FLASHLIGHT

With bright green accents and a body designed to keep it from rolling, this flashlight is easy to find and use at the campsite. With a textured handle and an IPX7 water-resistance rating, it is reliable to use in any weather. Three lighting modes are ignited by a tail cap switch.

OVERALL LENGTH:	9.1"
WEIGHT:	6.5 OZ
BATTERIES:	[2] AA
MODES:	RED/LOW/HIGH

- LED [Cree XPG]
- Red LED [Osram]
- Low: 50 lumens/8 hrs
- High: 200 lumens/4 hrs
- Red: 40 lumens
- Water penetration rating: IPX7
- Anti-roll shape
- Lanyard loop



BLISTER	31-002308	WHITE LIGHT	1-AA ALKALINE BATTERY	ALUMINUM
BOX	30-000610	WHITE LIGHT	1-AA ALKALINE BATTERY	ALUMINUM

BLISTER	31-002560	WHITE/RED LIGHT	MOMENTARY ON/OFF	PUSH BUTTON ON/OFF TAIL CAP SWITCH
---------	-----------	-----------------	------------------	------------------------------------

FREESCAPE™ LANTERN

Featuring Freetouch Technology, the Freescape series of lanterns ignite with a gentle tap. Touch the ring to turn on, off, or brighten or hold contact to dim slowly. Clever power-kill functionality prevents battery loss when stored, spring-loaded handles easily clip to tent or tree.

OVERALL LENGTH:	LARGE: 9.1"
	SMALL: 5.9"
WEIGHT, W/O BATTERIES:	LARGE: 20.6 OZ
	SMALL: 8.3 OZ
BATTERIES:	LARGE: [4] D
	SMALL: [3] AA
MODES:	LOW/HIGH

- LED [Cree XM-L2]
- Large: Low: 15 lumens/240 hrs
- Large: High: 300 lumens/15 hrs
- Small: Low: 5 lumens/40 hrs
- Small: High: 80 lumens/10 hrs
- Water penetration rating: IPX4
- On/off power switch
- Freetouch technology output ring: tap on/off
- Grippy rubber footings
- LED battery life indicators
- Spring-loaded handle clip



Small Lantern

BOX	30-000932	WHITE LIGHT	FREESCAPE LARGE LANTERN	SPRING-LOADED HANDLE
BOX	30-000933	WHITE LIGHT	FREESCAPE SMALL LANTERN	BOTTOM + SIDE LANTERNS

HFR-M™ LIGHT w/ HELMET MOUNT

The Hands Free Recon light has a thoughtfully efficient design, it can be mounted on helmet, MOLLE vest, table-top, or held in hand. With 4 color outputs [white, red, NVIS, IR] and light modes [low, medium, high, beacon] this versatile light is ideal for any situation.

OVERALL LENGTH:	2.9"
WEIGHT:	W/ CR123 BATTERY: 3.9 OZ
	W/ HELMET MOUNT: 5.0 OZ
	W/ AA BATTERY: 4.2 OZ
BATTERIES:	[1] AA OR [1] CR123
MODES:	HIGH/LOW/STROBE

- Runtime: 6 hrs
- 59/100 lumen burst capability
- Reversible universal clip
- MOLLE mount
- Helmet mount
- 360° light articulation
- NVIS low detection by NVGs, & full color rendering for map reading



BOX	30-000287	WHITE/RED/NVIS/IR LIGHT	PARACORD ADAPTABLE	6 HOUR RUNTIME
-----	-----------	-------------------------	--------------------	----------------

INFINITY™ ULTRA TASK LIGHT

When space for gear is limited but need for bright light is mandatory, grab this pint-sized LED light. A water resistant body and epoxy coated circuit guarantee reliable performance, time after time. Speaking of time, it runs for 60 hours on the included AA battery.

OVERALL LENGTH:	3.3"
WEIGHT:	2.2 OZ
BATTERIES:	[1] AA
MODE:	STEADY WHITE

- LED
- 6 lumens/60 hrs
- Waterproof to 3 meters
- Pocket clip



BLISTER 22-80012 WHITE LIGHT ANODIZED AIRCRAFT ALUMINUM AA BATTERY

MYTH® BLOOD TRACKING LIGHT

If the perfect shot is hard to make, tracking your game after the fact can be near impossible. Developed to enhance the color red in low-light conditions, this light offers the option to toggle between primary and blood tracking modes. The rubber shell keeps it securely in hand.

OVERALL LENGTH:	7.0"
WEIGHT:	7.2 OZ
BATTERIES:	[4] AA
MODES:	TRACK/GRAY CAST

- LED w/ optimized spectrum
- 33 lumens/5.5 hrs
- Water penetration rating: IPX4
- 2 button switchable lighting
- Lanyard hole on tail end



"Excellent product that does exactly what is expected. Blood trails are much easier to follow in those low light conditions."

★★★★
RON WOLBERT, OWNER
BEAR'S DEN PRECISION BOW TUNING

BLISTER 31-001863 BLUE/RED/GRAY LIGHT 4-AA ALKALINE BATTERIES RUBBER OVERMOLD

MYTH® FLASHLIGHT

The easiest go-to in campsite and field-bound lighting, this flashlight can be carried alongside the Myth Blood Tracking light as an intuitive hunting duo. Although compact, the bright white LED light is powerful at 200 lumens on high/50 on low. Tracking is a cinch with this in hand.

OVERALL LENGTH:	7.0"
WEIGHT:	7.2 OZ
BATTERIES:	[4] AA
MODES:	LOW/MEDIUM/HIGH

- LED [Cree XP-G R5]
- Low: 50 lumens
- High: 200 lumens/2 hrs
- Water penetration rating: IPX4
- SK5 tool steel w/ titanium nitride PVD coating
- Single tail button



BLISTER 31-002998 WHITE LIGHT 4-AA ALKALINE BATTERIES GLASS-FILLED NYLON W/ RUBBER OVERMOLD

MYTH® SPOTLIGHT

Developed for low-light hunting needs, this compact tool features a powerful 650 lumen light that can be used to track, flush, or simply highlight game location. Mounted on belt, on pack, or in hand this two mode light [650/90 lm] has you covered with red and green lenses.

OVERALL LENGTH:	5.0"
WEIGHT:	20 OZ

- LED
- Low: 90 lumens/45 hrs
- High: 650 lumens/4 hrs
- Rechargeable lithium ion battery pack
- Standard 1/4-20 UNC thread for tripod, and boat mounted use
- Belt clip



BLISTER 31-001857 WHITE LIGHT W/RED + GREEN LENSES HARD NYLON W/ RUBBER OVERMOLD

RECON™

Engineered for the tactical enthusiast and soldier alike, the American made Recon series of products are efficient and versatile. Rugged yet lightweight, both are made of sturdy aluminum. Various lens and lumen options are available, depending on your needs.



OVERALL LENGTH:	RECON TASK: 3.3"
	RECON-M II: 5.75"
WEIGHT:	RECON TASK: 2.6 OZ
	RECON-M II: 4.75 OZ
BATTERIES:	[1] AA
MODES:	ON/OFF

- LED [Cree XML]
- Recon: 3 lumens/28hrs
- Recon-M II: White 55 lumens/5 hrs
- Recon-M II: Red 1 lumen/1 hr
- Recon-M II: NVIS 3.5 lumens/3.5 hrs
- Integrated lens filters change output color
- Pocket clip
- Recon-M II: Weatherproof
- Recon-M II: Aggressive knurling
- Recon-M II: Lanyard hole



Recon-M II

BLISTER	22-80016	WHITE/RED/BLUE/GREEN LIGHT	RECON TASK LIGHT	LOW WATT LED W/ PROPRIETARY DIAL TECHNOLOGY
BOX	22-80132	WHITE/RED/NVIS/IR LIGHT	RECON-M II FLASHLIGHT	REVERSIBLE MOLLE ADAPTABLE CLIP

LIGHTING





EQUIPMENT



QUIET DEPLOY™

WITH VELCRO® BRAND TECHNOLOGY

GERBER'S QUIETEST SHEATH.

COVERT:

- + UNIDIRECTIONAL HOOKS FOR REDUCED AUDIBLE RESONANCE

DURABLE:

- + UNIFORM HOOK GEOMETRY FOR SLIDING DISENGAGEMENT & LASTING PERFORMANCE

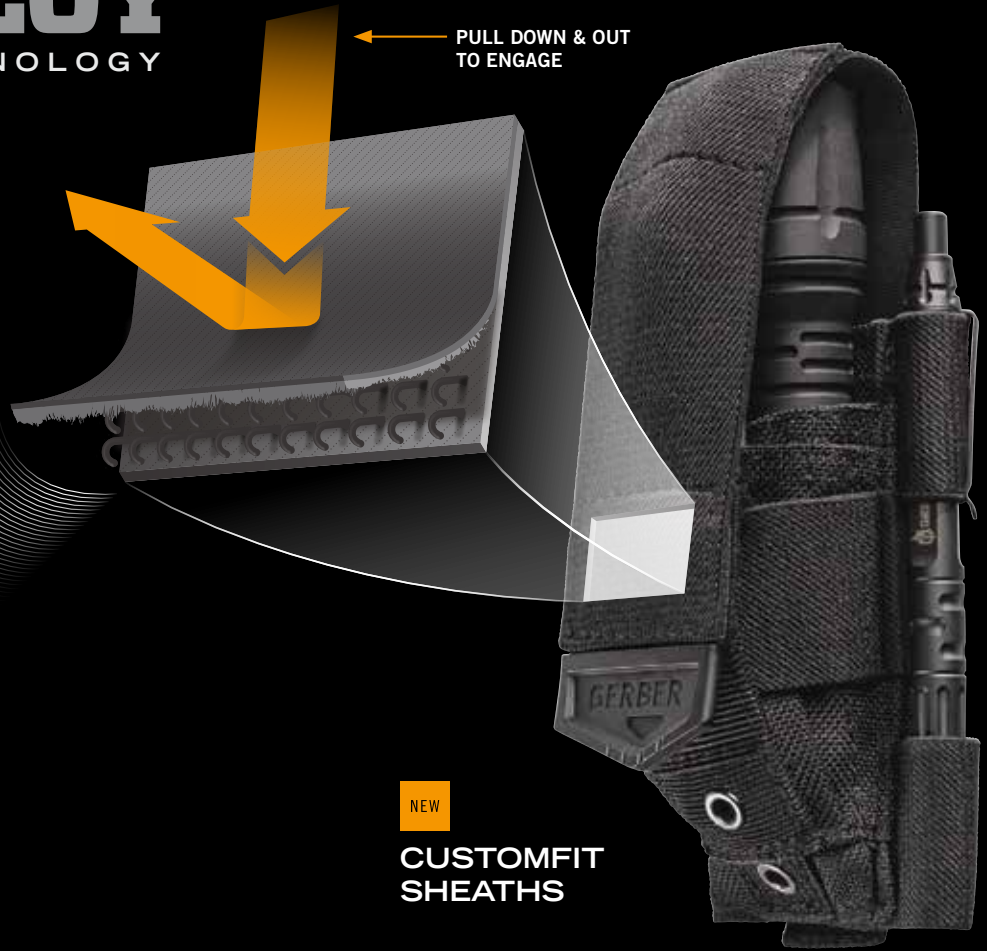

PULL DOWN & OUT
TO ENGAGE



115



UNIDIRECTIONAL



NYLON RESIN

NEW

CUSTOMFIT
SHEATHS

NEW

CUSTOM FIT™ SHEATHS

The CustomFit™ Dual Sheath is designed to create a custom fit for a wide array of product combinations including folding knives, multi-tools and hand-held flashlights. The patent-pending, richly featured sheath includes a quick access back panel that allows the user to customize the sheath to perfectly fit the tools selected for the task, job or mission of the day. Holding two items plus a pen, this sheath is easily customizable for any pairing of tools you need to take on the day. The Quiet Deploy™ technology allows the user to simply pull down the front tab for stealth-like access. With the CustomFit™ Dual Sheath, they'll never hear you coming.

The CustomFit™ Quad Sheath holds four items plus a pen.

QUIET DEPLOY™ TECHNOLOGY



CustomFit™ Dual Sheath



CustomFit™ Quad Sheath

- EASY ACCESS PANEL
- ONE-WRAP® FASTENER TOP STRAP
- QUIET DEPLOY™ W/VELCRO® BRAND PULL TAB
- SIDE TENSIONER STRAP
- 2-POSITION BELT CARRY
- TOP + BOTTOM SECURITY TABS ON BACK PANEL

BACKER CARD 30-001223	DUAL SHEATH	MOLLE COMPATIBLE	HOLDS 2 ITEMS + PEN
BACKER CARD 30-001222	DUAL SHEATH/BERRY COMPLIANT	MOLLE COMPATIBLE	HOLDS 2 ITEMS + PEN
BACKER CARD 30-001225	QUAD SHEATH	MOLLE COMPATIBLE	HOLDS 4 ITEMS + PEN
BACKER CARD 30-001224	QUAD SHEATH/BERRY COMPLIANT	MOLLE COMPATIBLE	HOLDS 2 ITEMS + PEN

NEW

FIRESTARTER™

Surviving the unexpected is about being prepared and a key factor to tackling the wild in confidence is the ability to build a fire. Gerber's Fire Starter is a compact, packable survival tool that is easily attached to a backpack or keychain with a lanyard. With built-in water-resistant tinder storage, an easy to spark ferrocerium rod, a sturdy metal striker, and a 100 decibel emergency whistle, your chances of staying alive are infinitely greater with this handy tool.

OVERALL LENGTH:	4.7"
DIAMETER:	.9"
WEIGHT:	2.6 OZ



- FERROCERIUM ROD + METAL STRIKER
- IPX4 WATER-RESISTANT STORAGE COMPARTMENT
- COTTON TINDER
- 100 dB EMERGENCY WHISTLE ON LANYARD CORD

BLISTER 31-003114 FERROCERIUM ROD + METAL STRIKER WATER RESISTANT STORAGE FOR TINDER EMERGENCY WHISTLE LANYARD CORD

NEW

IMPROMPTU PEN™

Originally designed as a rescue tool for first responders, the Impromptu is machined from steel and coated with Cerakote® for the ultimate in corrosion and chemical resistance. Featuring a tempered steel glass breaker and a replaceable Rite in the Rain® ink cartridge, this tool is so much more than a pen.

OVERALL LENGTH: 5.6"
DIAMETER: Ø.5"
WEIGHT: 1.0 OZ



- MACHINED STEEL BODY
- CARBIDE GLASS-BREAKER TIP
- PUSH BUTTON PEN
- RITE IN THE RAIN® INK CARTRIDGE
- STAINLESS STEEL POCKET CLIP
- NEW SILVER AND GOLD VERSIONS

BLISTER	31-003226	CARBIDE GLASS-BREAKER TIP	RITE IN THE RAIN® INK CARTRIDGE	GOLD	NEW
BLISTER	31-003227	CARBIDE GLASS-BREAKER TIP	RITE IN THE RAIN® INK CARTRIDGE	SILVER	NEW
BLISTER	31-001880	CARBIDE GLASS-BREAKER TIP	RITE IN THE RAIN® INK CARTRIDGE	BLACK	

NEW

QUIET DEPLOY SINGLE SHEATH™

The Quiet Deploy™ Single Sheath is designed with a flexible fit, accommodating an array of products including folding knives, multi-tools and hand-held flashlights. Simply pull down the front tab for stealth-like access to the item of your choice plus a pen, stowing your sheath on MOLLE, vertically, or horizontally on your belt.



Back



QUIET DEPLOY™ TECHNOLOGY



- HOLDS LARGE OR MID-SIZE ITEM + PEN
- MOLLE-COMPATIBLE
- ADJUSTABLE TOP STRAP
- FLEXIBLE SIDE-TO-SIDE ELASTIC
- 2-POSITION BELT CARRY
- IN BLACK OR COYOTE BROWN

BACKERCARD	31-003327	QUIET DEPLOY™ W/ VELCRO® BRAND TECHNOLOGY PULL TAB	MOLLE-COMPATIBLE	BLACK
BACKERCARD	31-003328	QUIET DEPLOY™ W/ VELCRO® BRAND TECHNOLOGY PULL TAB	MOLLE-COMPATIBLE	COYOTE BROWN

NEW

VITAL™ BIG GAME FOLDER REPLACEMENT BLADES

Ready at a moment's notice, this quiet carry case prevents blades from rattling and offers stealth use in field. The hard case is safely stowed and extracted without risk of injury, storing both new and used blades in separate cavities for easy distinction. Available for purchase with blunt tip or drop point blades.

BLADE LENGTH: DROP POINT: 4.8"
BLUNT TIP: 4.9"
WEIGHT: 2.8 OZ
CASE: POLYPROPYLENE W/
SILICONE DAMPENER
BLADE: 42ØJ2



Drop Point



Blunt Tip

- NEW BLADE CAVITY + USED BLADE CAVITY
- HARD CASE MAINTAINS USER SAFETY WHILE IN PACK
- SPECIAL TECHNOLOGY PREVENTS RATTLING
- AVAILABLE WITH BLUNT TIP OR DROP POINT BLADES

BOX	30-003085	NEW BLADE + USED BLADE CAVITY	SPECIAL TECHNOLOGY PREVENTS RATTLING	DROP POINT
BOX	30-003086	NEW BLADE + USED BLADE CAVITY	SPECIAL TECHNOLOGY PREVENTS RATTLING	BLUNT TIP

BG SURVIVAL BELT™

Anything that is backed by Bear Grylls is worth its weight in gold in the wild. Every bit a wearable webbing belt, it can also be used as a rope or strap should you need. Hidden within the waterproof buckle is fishing supplies, a signaling mirror, and a screwdriver. Fashionably wild.

OVERALL LENGTH: 48"

- Heavy nylon webbing
- Hidden compartment in buckle houses:
 - fishing line, hooks & weights
 - snare wire
 - signaling mirror
- Rear of buckle, removable mini flat & Phillips drivers, removable bottle opener
- Priorities of Survival Pocket Guide

"I got a bunch of these for myself and friends for Christmas a few years back and still wear mine. I volunteer with C.A.P. for search and rescue and it is part of my uniform now, I never go on sortie without it..."

★★★★★

ANUEL NEVELS, SEARCH & RESCUE



BG SURVIVAL BLANKET™

You will never be caught out in the cold with this portable insurance policy. Large, robust, and reusable, this 8'x5' blanket will weather the elements as a tent, blanket, or mat. The orange side adds visibility when lost and the reflective silver side traps in heat to stay warm.

OVERALL LENGTH: 94.5" X 60"
THICKNESS: 12 MICRONS

- Lightweight
- Compact
- Low density polyethylene
- Durable
- Tear resistant
- Packaged in reusable bag
- The Priorities of Survival printed on surface



BELT 31-001771 FISHING SUPPLIES USE AS ROPE OR STRAP

RE-USABLE BAG 31-001785 ORANGE SIDE FOR VISIBILITY USE AS BLANKET USE AS HEAT SHIELD

BG SURVIVAL BRACELET™

Surviving the wild often comes down to being prepared. This survival bracelet is designed for everyday wear, always on hand to be of use when things go south. Constructed of 12 feet of high-strength paracord, and including an emergency whistle, you are ready for anything.

OVERALL LENGTH: 11.5'



- Paracord for survival emergency
- One-hand size adjustment
- One size fits most
- 12' of paracord
- Priorities of Survival Pocket Guide

BLISTER 31-001773 12' OF PARACORD WHISTLE ONE SIZE FITS MOST

BG SURVIVAL LANYARD™

This lanyard looks unassuming enough as a keychain or on a backpack, but when needed it unleashes 6 feet of high-strength paracord to save the day. Use it to secure a splint, lash timber for shelter, or keep your food out of the way. A small whistle is included for emergencies.

OVERALL LENGTH: 5"



- Paracord for survival emergency
- Emergency whistle
- Attaches to packs, keychain, etc.
- 6' of paracord
- Priorities of Survival Pocket Guide

BLISTER 31-001788 6' OF PARACORD WHISTLE HIGH STRENGTH PARACORD

BG SURVIVAL PONCHO™

Made of light-yet-tough, waterproof, windproof polyethylene this hooded poncho is designed to keep you moving no matter what Mother Nature has planned. It is one-size-fits-all and quick to use on yourself, to cover food and supplies, or as a makeshift tent.

OVERALL LENGTH: 48"



- Bear Grylls logo on chest
- Lightweight
- Protection from wet weather
- Hooded
- Doubles as rescue marker [flag]
- Packaged in re-usable bag
- Priorities of Survival Pocket Guide

RE-USABLE BAG 31-001790 HOODED DOUBLES AS RESCUE MARKER/FLAG LIGHTWEIGHT

BG SURVIVAL WHISTLE™

Featuring an ear-piercing 120 decibels, this survival whistle is your go-to signal for help. With no moving parts to freeze, jam, or deteriorate, you can rely on it to work in the most critical moments. Easily attachable to keychains or packs, the break-away lanyard keeps it close at hand.

OVERALL LENGTH: 2.1" X 1.1" X .9"

WEIGHT: .8 OZ

- Cushioned mouth guard [CMG]
- Distinct, loud crisp sound
- No moving parts
- Heard above ambient noise
- Chambers self clear when submerged
- Priorities of Survival Pocket Guide



BLISTER 31-002786 CUSHIONED MOUTH GUARD 120 DECIBELS BREAK-AWAY LANYARD

VITAL™ REPLACEMENT BLADES

Ready at a moment's notice, the highly visual orange case is easy to locate and operate on the fly. There are 12 replacement blades in the cavity, safely extracted without worry of reaching into a bag for a loose blade. The waste compartment keeps used blades in one place.

BLADE LENGTH: 2.8"
BLADE: 42ØHC



- For use w/ Vital Pocket Folder EAB
- Exchange-a-blade
- Easy to locate orange case
- Easy to use
- Safe to use
- 12 replacement blades per pack

BLISTER 31-002739 STORES USED BLADES SAFELY 12 BLADES PER PACK #60 RAZOR 42ØHC



DING DONG™

When ringing the doorbell isn't a reality but the need to get through a barrier is, the Ding Dong combines 3 essential breaching tools. Constructed of premium American materials and MOLLE compatible, this sledgehammer, battering ram, pry bar hybrid is all business.

OVERALL LENGTH: 27"
WEIGHT: 12.25 LBS

- Forged and machined head
- Forged pry bar end
- Molded fiberglass handle
- MOLLE-compatible carrying system w/ quick release strap



MINI PRY BAR™

Some breaching operations aren't planned. This compact pry bar is easily carried on your kit for the moment you need it. Virtually indestructible, the simple and purpose-driven design has a forged steel body and a glass-filled handle that is insulated up to 1,000 volts.

OVERALL LENGTH: 11"
WEIGHT: 7.4 OZ

- Forged steel pry bar
- Black oxide coating
- Insulated glass-filled nylon handle
- Paracord leash
- Finger guard &ommel lanyard holes



BOX 30-000790 STEEL + FIBERGLASS FORGED HEAD + PRY BAR MOLLE COMPATIBLE

BOX 30-001057 FORGED STEEL INSULATED TO 1,000 VOLTS PARACORD LEASH

BG SURVIVAL BASIC KIT™

The Basic Kit's mantra: Stay prepared. Stay Alive. Includes: waterproof bag, Mini Paraframe knife, emergency whistle, fire starter, waterproof matches, snare wire, emergency cord, fire tinder, ripstop nylon bag, land to air rescue instructions, and Bear's Priorities of Survival Guide.

BAG: 4.5" X 5"
WEIGHT: 4.2 OZ



"This is a decent little kit to get your survival equipment kit started."



SAMUEL, AIRCREW SURVIVAL
EQUIPMENTMAN, USN

- Waterproof bag
- First aid supplies
- Gerber Paraframe Mini
- Emergency whistle
- Fire starter
- Cotton ball – fire tinder
- Waterproof matches
- Snare wire
- Emergency cord
- Land to air rescue & SOS instructions
- Priorities of Survival Pocket Guide

BLISTER 31-000700 11 PIECE KIT WHISTLE PARAFRAME MINI INCLUDED

ENGINEER'S KIT™

Thoughtfully designed with the most sensitive of combat situations in mind, this kit can be relied upon to be discreet, careful, and dependable. Includes a titanium shaft w/ 3 titanium probe tips, 3 nylon probe tips, a nylon handle, Recon M II flashlight, and Concertina Cutters.

OVERALL LENGTH: 9" X 5"
TOTAL WEIGHT: 2.7 LBS



- Mine probe system
- MP600 D.E.T.
- Recon-M II flashlight
- Concertina Cutter
- MOLLE-compatible sheath

BOX 30-000126 MINE PROBE SYSTEM COYOTE BROWN MOLLE-COMPATIBLE SHEATH



GUN CLEANING KIT CONTENTS

	M4 / M16 KIT 22-01100	7.62MM RIFLE KIT 22-01101	50 CALIBER KIT 22-01104	SHOTGUN KIT 22-01103	9MM & .45 PISTOL KIT 22-01102	PISTOL / SMG KIT 22-01106	RIFLE / SHOTGUN / PISTOL KIT 22-01105
BORE BRUSHES	.22 CALIBER						X
	.30 CALIBER		X				X
	.35 CALIBER	X					
	.38 CALIBER						
	.38 CALIBER NYLON					X	X
	.40 CALIBER				X		X
	.45 CALIBER		X			X	X
	.58 CALIBER			X			
	5.56 MM	X					
	12 GAUGE			X	X		X
	8" .50 CALIBER CABLE			X			
	40" .50 CALIBER CABLE			X			
CABLES	12" PISTOL CABLE					X	X
	20" RIFLE CABLE					X	
	8" CABLE	X	X			X	
	8" CABLE W/ .30 CALIBER TIP				X	X	X
	30" RIFLE CABLE	X	X		X		X
	5.56 MM	X					X
SLOTTED TIPS	.30 CALIBER	X	X		X	X	X
	SHOTGUN			X			X
OTHER COMPONENTS	.50 CALIBER		X				
	MP600 MULTI-PLIER	X	X	X	X	X	X
	RED LED FLASHLIGHT	X	X	X	X	X	X
	BORE REFLECTOR / FLAG SAFETY	X	X	X	X	X	X
	CLP	X	X	X	X	X	X
	SOLVENT					X	
	PANOPLY PATCHES		X	X	X	X	X
	5.56 PATCHES	X					
	PATCH SAVER				X		X
	Q-TIPS® COTTON SWABS	X					
	T-HANDLE & OBSTRUCTION REMOVER	X	X	X	X	X	X
	NATO ADAPTER	X	X		X	X	X
	SHOTGUN BRUSH ADAPTER						X
	FEMALE ROD HANDLE	X	X	X	X	X	X
	MALE ROD HANDLE				X		X
	SHORT A/P BRUSH	X	X	X	X	X	X
	NYLON END BRUSH	X	X	X		X	X
	BRASS SCRAPER	X	X	X		X	X
BRASS PICK	X	X			X	X	
PIN PUNCH						X	
LENS CLEANER	X						
MOHAIR LENS BRUSH		X					

GUN CLEANING KITS™

Each gun cleaning kit has been developed to cater to a specific gun, giving you every resource you need to clean and maintain your weapon at home or in the field. Each kit varies slightly in tools, but all are contained within a MOLLE-compatible sheath.

WEIGHT:	M4 / M16 32.0 OZ
	7.62MM RIFLE 22.4 OZ
	5Ø CALIBER 24.8 OZ
	SHOTGUN 22.2 OZ
	9MM / .45 PISTOL 2Ø.2 OZ
	PISTOL / SMG 22.2 OZ
	RIFLE / SHOTGUN / PISTOL 32.2 OZ

"Best all round cleaning kit in the world. I got mine from my son, he was issued one in Afgan. Little large for everyday carry, but stick this in your bag and you'll not use anything else. Extra room in case for some added items I wanted to carry too. Love this thing!"

★★★★★

VORNDAMR, RETIRED MILITARY



INDIVIDUAL DEPLOYMENT [ID] KITS™

This kit puts individual equipment close at hand in an easy to carry, MOLLE compatible sheath. Made in America for the American soldier, this allows the user to maintain their weapon, keep a light source nearby, cut out of an emergency, and tackle any task needing a multi-tool.

SHEATH W/ COMPONENTS:	4" X 2" X 6"
WEIGHT:	24 OZ

- eFECT tool
- Recon-M II flashlight
- Needle nose MP6ØØ w/ carbide cutters
- MOLLE compatible sheath w/ outboard strap cutter
- Sheath available in Coyote Brown or Multi-Cam

"Great Kit! This kit is truly a great piece of gear. All made in the USA; well thought out and designed. The flashlight has IR capability...Well done Gerber!"

★★★★★
INF82GRUNT



Coyote Brown



Multi-Cam



BOX	22-Ø11ØØ	M4 / M16 KIT	MOLLE-COMPATIBLE SHEATH
BOX	22-Ø11Ø1	7.62MM RIFLE KIT	MOLLE-COMPATIBLE SHEATH
BOX	22-Ø11Ø4	5Ø CALIBER KIT	MOLLE-COMPATIBLE SHEATH
BOX	22-Ø11Ø3	SHOTGUN KIT	MOLLE-COMPATIBLE SHEATH
BOX	22-Ø11Ø2	9MM / .45 PISTOL KIT	MOLLE-COMPATIBLE SHEATH
BOX	22-Ø11Ø6	PISTOL / SMG KIT	MOLLE-COMPATIBLE SHEATH
BOX	22-Ø11Ø5	RIFLE / SHOTGUN/ PISTOL KIT	MOLLE-COMPATIBLE SHEATH

BOX	3Ø-ØØØ366	COYOTE BROWN SHEATH	COYOTE BROWN STRAP CUTTER	MOLLE-COMPATIBLE SHEATH
BOX	3Ø-ØØØ367	MULTI-CAM SHEATH	TAN STRAP CUTTER	MOLLE-COMPATIBLE SHEATH

INDIVIDUAL SURVEILLANCE KIT [ISK]™

Designed for Federal agencies, the Individual Surveillance Kit provides the operator with key implements for remote surveillance. The professional-grade equipment has been hand-picked to serve a very distinct purpose in the field, housed in a heavy-duty nylon bag.

DIMENSIONS: 7.1" X 29" X 4.3"
WEIGHT: 13 LBS



- Cable Dawg communications tool
- E-Tool folding shovel
- 9" hatchet
- Gator folding saw
- Cortex flashlight w/ [2] AA batteries
- MP600
- Crisis Hook knife

MAINTENANCE KIT™

Teaming together the first-in-class MP600 tool and the Firecracker LED flashlight, Gerber has enabled the user to maintain and illuminate no matter the time or conditions. The one-handed multi-plier in one hand, the flashlight in the other: unstoppable.

OVERALL LENGTH: 6.6"
WEIGHT: 13.8 OZ



- Fine edge blade
- Serrated blade
- Wire cutter
- Wire crimper
- Small, medium & large flat drivers
- Phillips driver
- RemGrit® saw
- File
- Ruler
- Bottle opener
- Can opener
- Key chain ring
- LED Flashlight

"I was given a slightly older version of this set and it was on my side my whole time in the Guard. It withstood any and all abuse I could throw at it. I still have it today... A must for anyone who is wanting a great tool kit that wears easily. Thanks much!"

★★★★★

CORY, US COAST GUARD

BOX 30-001012 PROFESSIONAL-GRADE HEAVY DUTY STORAGE/CARRYING CASE

BLISTER 07570 NEEDLE NOSE PLIERS FIRECRACKER LED FLASHLIGHT BALLISTIC NYLON SHEATH

MINE PROBE KIT™

Probe shallow. Probe deep. Probe as conditions dictate with the Basic or Deluxe Mine Kit Probe Kit. Engineered from titanium and sensitive enough to transmit even the lightest contact, these kits are built to perform in the most sensitive of tasks.

WEIGHT: BASIC KIT: 13.6 OZ
DELUXE KIT: 22 OZ



- 3 nylon probe tips
- 3 titanium probe tips
- Titanium shaft
- Nylon handle
- Infinity Ultra task light [Deluxe kit only]
- MP6ØØ D.E.T. [Deluxe kit only]
- MOLLE & Berry compatible black sheath



Deluxe Mine Probe Kit



OFF-ROAD / SURVIVAL / SUV KIT™

Meant to be kept in your vehicle, this kit equips the user with tough emergency tools that save the day. With a compact size it can be stored anywhere and easily accessed when the time comes, you don't want to be downrange or down the road without it.

CASE DIMENSIONS: 12" X 11" X 3"
WEIGHT: 194 OZ

- MP6ØØ
- E-Tool folding shovel
- 9" hatchet
- Exchange-A-Blade folding saw
- Cortex flashlight w/ [2] AA batteries
- Concertina wire cutter



"I received one of these kits while in Iraq in 2ØØ5. I carried it while I was in Iraq. I carried it when I got home in my off-road vehicle it was a wonderful piece of equipment I wish I still had it, thank you Gerber"

★★★★★

PETER BERRY, US ARMY RETIRED

BOX	Ø5984	BASIC MINE PROBE KIT	MOLLE & BERRY-COMPATIBLE SHEATH	USA MADE
BOX	Ø5982	DELUXE MINE PROBE KIT	INFINITY ULTRA LIGHT	MP6ØØ D.E.T.

BOX	Ø5635	NEEDLE NOSE PLIERS	FIRST AID KIT	COMPACT DURABLE CASE
-----	-------	--------------------	---------------	----------------------

BG SURVIVAL ULTIMATE KIT™

A survival kit built for hostile environments, this is the kit you hope not to use but are sure glad to have if you need it. The 16 piece kit lives in a zippered, waterproof bag that is easily packed. Imagined by Bear and backed by Gerber, it may just save your life someday.

OVERALL LENGTH: 4.5" X 5"
WEIGHT: 4.2 OZ



- Survival blanket
- Signaling mirror
- Miniature light
- Fine edge blade
- Wire cutters
- Small & medium flat driver
- Phillips driver
- Tweezers
- Waxed thread
- Fishing kit
- Sewing kit
- Fire starter
- Cotton ball - fire tinder
- Waterproof matches
- Emergency cord
- Saw
- Bottle opener
- Key chain ring
- Land to air rescue & SOS instructions
- Priorities of Survival Pocket Guide

"Great kit, I keep one in each of my vehicles, and my emergency kit. I have not had to use them, but I know from all my Gerber products I own that it will serve me well when needed."

★★★★★
KENNY, PRIOR MILITARY

BLISTER 31-000701 NEEDLE NOSE PLIERS FISHING KIT LIGHTWEIGHT, WATERPROOF BAG



BG FIELD SHARPENER™

The ideal companion for the well-equipped adventurer, this sharpener has two rod shaped diamond-coated sharpeners to cater to serrated blades. Coarse carbide and fine ceramic inserts will keep you fine edge blades in tip top shape. The hard plastic sheath keeps it all secure.

OVERALL LENGTH: 4.5"
WEIGHT: 2.3 OZ



- Sharpens serrated edge blades
- Sharpens fine edge blades
- Coarse carbide insert
- Fine ceramic insert
- Pocket sized
- Grippy handle
- Lanyard hole
- Priorities of Survival Pocket Guide

BLISTER 31-001270 POCKET SIZED 2 SIZES OF DIAMOND RODS

DIAMOND KNIFE SHARPENER™

Even with high quality steel and excellent craftsmanship, every knife must ultimately be sharpened. This triple diamond-plated design is durable and sharpens both serrated and fine edge blades.

OPEN LENGTH: 7.4"
CLOSED LENGTH: 5.6"
WEIGHT: 1.6 OZ

- Sharpens serrated edge blades
- Sharpens fine edge blades
- Hook sharpener



"Best knife sharpener ever. I bought one of these a couple of years ago and so far its been the best portable knife sharpener I've ever had. It takes the place of most stones, its light and small."

★★★★★
ERIC HIRST

BLISTER 09841 TRIPLE DIAMOND-PLATED DESIGN HOOK SHARPENER

MYTH® FIELD SHARPENER™

The ideal companion for the well-equipped hunter, this sharpener has two diamond-coated serration sharpeners and comes with carbide and ceramic inserts for sharpening in the field. This packable tool is a butterfly open design, keeping it secure and safe when not in use.

OVERALL LENGTH:	7.2"
CLOSED LENGTH:	4.0"
WEIGHT:	2.4 OZ

- 2 diamond-coated serration sharpeners
- Carbide insert
- Ceramic insert
- Butterfly-style handles



POCKET SHARPENER, CERAMIC™

Even with high quality steel and excellent craftsmanship, every knife must ultimately be sharpened. This sharpener features fine ceramic rods for razor sharpness and coarse ceramic rods for aggressive sharpening.

OVERALL LENGTH:	2.0"
WEIGHT:	.6 OZ

- Fine ceramic rods
- Coarse ceramic rods



BLISTER 31-001526 CARBIDE INSERT CERAMIC INSERT TEXTURED RUBBER HANDLE INLAYS

BOX 04307 FINE CERAMIC RODS COARSE CERAMIC RODS

ENTRENCHING TOOL [E-TOOL]™ FOLDING SPADE

At only 2.3 pounds, this NATO approved entrenching tool folds up to be a portable powerhouse. With a glass-filled nylon handle, powder-coated boron carbon steel blade, and 7075 aluminum shaft it is as tough as you need.

OVERALL LENGTH:	23.4"
CLOSED LENGTH:	9.25"
WEIGHT:	37.3 OZ

- Lightweight
- NATO approved
- Glass-filled nylon handle
- Powder-coated boron carbon steel spade



E-Tool closed

ENTRENCHING TOOL [E-TOOL]™ w/ SHEATH

At only 2.3 pounds, this NATO approved entrenching tool folds up to be a portable powerhouse. With a glass-filled nylon handle, powder-coated boron carbon steel blade, and 7075 aluminum shaft it is as tough as you need. The foliage green sheath is H harness, web belt, and MOLLE compatible.

OVERALL LENGTH:	23.4"
CLOSED LENGTH:	9.4"
WEIGHT:	53 OZ

- Lightweight
- NATO approved
- Glass-filled nylon handle
- Powder-coated boron carbon steel spade
- H Harness, web belt & MOLLE-compatible sheath



E-Tool closed



E-Tool sheath

BOX 05942 NATO APPROVED GLASS-FILLED NYLON HANDLE

BOX 22-01062 H HARNESS, WEB BELT & MOLLE-COMPATIBLE SHEATH ANODIZED 7075 ALUMINUM SHAFT

ENTRENCHING TOOL [E-TOOL]™ w/ PICK

A military-grade digging tool, this powder-coated carbon steel shovel head is built for digging trenches and holes. With a serrated blade edge, anodized aluminum shaft, and glass-filled nylon handle this tool handles all types of difficult terrain. The head folds back to expose a handy and tough pick feature.

OVERALL LENGTH:	23.8"
CLOSED LENGTH:	9.25"
WEIGHT:	37.3 OZ



- Pick
- Lightweight
- NATO approved
- Glass-filled nylon handle
- Powder-coated boron carbon steel spade



E-Tool closed

GORGE™ FOLDING SHOVEL

This lightweight, foldable shovel is ideal to bring along on back-country trips. A glass-filled nylon shaft and rubberized handle secure the grip for digging or hammering. Use as a spade or fold back to reveal a hammer for pounding, easily fold away with the push of a button.

OVERALL LENGTH:	16.5"
CLOSED LENGTH:	9.25"
WEIGHT:	28 OZ



- Easy-to-use push button slide mechanism
- Heavy duty pick
- Hammer
- Draw string bag



Gorge closed



Gorge bag

BOX 22-01945

POWDER-COATED CARBON STEEL SHOVEL HEAD W/SERRATED BLADE

PICK

BOX

22-41578

PUSH BUTTON SLIDE MECHANISM

GLASS-FILLED NYLON HANDLE

BG CANTEEN™

Inspired by the classic military canteen and nesting cup, Bear partners with Gerber to provide an updated design with a BPA-free water bottle, snug nylon sheath, and leak-proof lock top. Suitable to boil water and designed to minimize wasted drops, its the ideal companion.

DIMENSIONS: 10" X 6" X 3"
WEIGHT: 12.5 OZ

- Food grade aluminum cup
- BPA-free water bottle
- Snug sheath
- Textured exterior
- Leak-proof lock top
- 1 Liter capacity
- Priorities of Survival Pocket Guide

"This is a great canteen. We have two of them. They function great, no leaks at the cap, hold a lot of water. We use them every weekend, and love the cup."

★★★★★
HOMER, HIKER & CAMPER



BG COMPACT COMPASS™

When the sun or stars aren't readily available, you'll require another way to get your bearings in the wild - enter the Compact Compass. Secure it with a lanyard and never worry, with no batteries it is always reliable. The durable ABS plastic body will outlast any adventure you may find yourself on.

OVERALL LENGTH: 2.3"

- Zipper pull
- Plastic body
- Compact size
- Priorities of Survival Pocket Guide



BLISTER 31-001062 BPA-FREE BOTTLE HEAT RESISTANT SILICONE HANDLES SNUG SHEATH

BLISTER 31-001777 ZIPPER PULL COMPACT SIZE ABS PLASTIC BODY

BG COMPACT FIRE STARTER™

A key factor to surviving in the wild is the ability to build a fire, with this compact 2 piece design you never have to worry. Water-resistant and easy to grip, it is capable of operation regardless of the elements.

LENGTH:	3.4"
DIAMETER:	.6"
WEIGHT:	.8 OZ

- 2-piece design
- Easy to use
- Rubber overmold
- Paracord lanyard
- Lightweight
- Priorities of Survival Pocket Guide

"Just got this and have already started making big fires. Love it. Thanks Gerber."

★★★★★
CHODE FAYDE



BG FIRE STARTER™

Rigorously tested and backed by Bear, the watertight construction of this tool makes it a convenient one to have on hand. With at least 8,000 strikes to provide a spark, it is an indispensable insurance policy to have in the event you need fire for warmth or food.

OVERALL LENGTH:	4.8"
WEIGHT:	2.6 OZ

- Compact carry
- Ferrocium rod & metal striker
- Lanyard
- Emergency whistle
- Waterproof tinder storage
- Land to air rescue & SOS instructions
- Priorities of Survival Pocket Guide



BLISTER 31-002554 WATER RESISTANT PARACORD LANYARD ATTACHES TO KEYCHAIN, PACK OR ZIPPER

BLISTER 31-000699 8,000+ STRIKES WHISTLE LAND TO AIR RESCUE & SOS INSTRUCTIONS

BG TINDERBOX™

With a easily gripped rubber exterior and oblong shape for easy use in the palm, the tinderbox gives its user access to immediate fire starting ability. The revolutionary tool has a grater-like steel surface to create fine tinder, which can then be easily dispensed to light a fire.

LENGTH:	5.75"
WIDTH:	2.25"
HEIGHT:	1.1"
WEIGHT:	3.0 OZ

- Unique tinder cutter w/ cover
- C304 stainless cutter
- Polypropylene cutter cover
- Rubber overmold to keep secure
- Polycarbonate/ABS w/ TPE overmold
- Magnifying glass
- Emergency signaling mirror
- Tinder capturing box to keep dry
- Priorities of Survival Pocket Guide



BLISTER 31-002557 TINDER CUTTER MAGNIFYING GLASS SIGNALING MIRROR



PTFE

COATING TECHNOLOGY

GERBER'S BEST PERFORMING AXE BLADE.

- FRICTION RESISTANT:**
+ CHOPS 3X DEEPER.
- HIGH HEAT RESISTANT:**
+ UP TO 600° F.
- CORROSION RESISTANT:**
+ NO CHEMICAL/WATER DAMAGE.

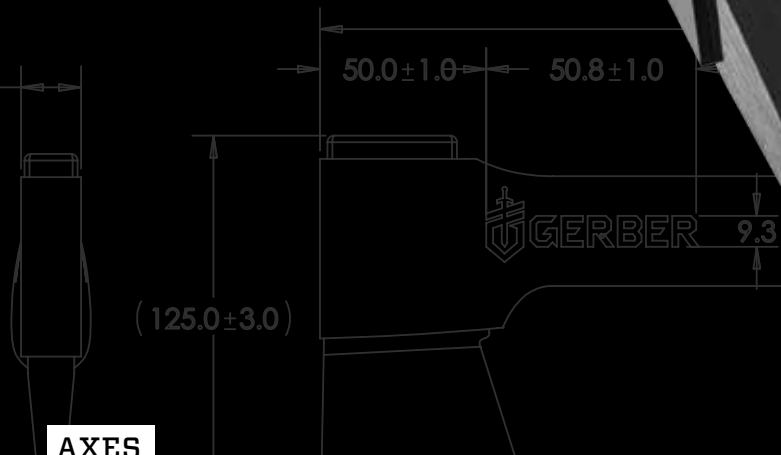
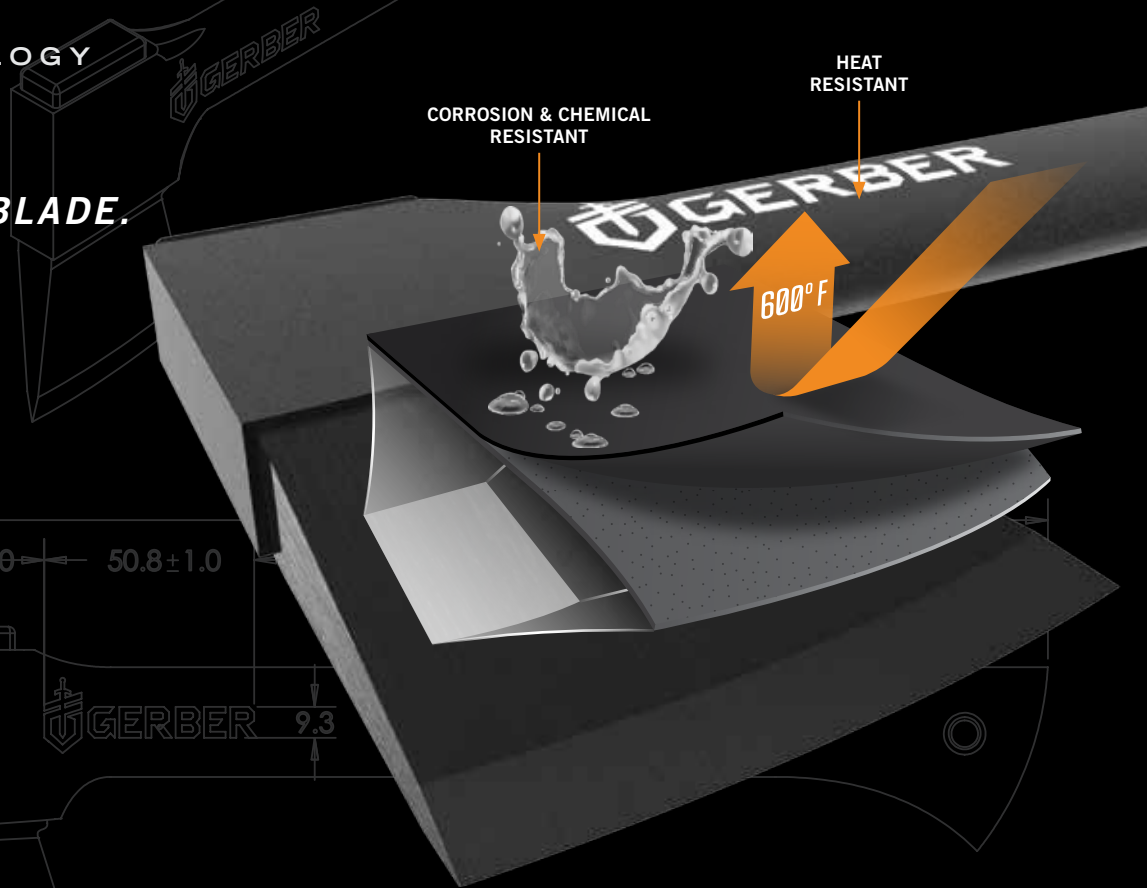

AXES

9" HATCHET™



Hang card 31-002648

14" HATCHET™



Hang card 31-002647

23.5" AXE™



Hang card 31-002651

NEW 36" POWER SPLITTING AXE™



Hang card 31-003636

GATOR® COMBO AXE™



Hang card 31-001054

GATOR® COMBO AXE™ II



Hang card 22-41420

Products shown are not to scale.

MACHETES

NEW COMPACT CLEARPATH MACHETE™

For back-country travel when every bit of weight is accounted for, the Compact Clearpath Machete is the tough, packable tool to bring along for the ride. The thoughtful design partners a corrosion-resistant, dual function stainless steel blade with the confidence of the tactile Gator Grip® handle. The two-sided blade has both a fine edge for hacking brush and vines and a crosscut saw edge for cutting branches, limbs, and small trees. When you head into the brush, never be without the Compact Clearpath Machete.



Blister 31-003154
Box 30-001228

GATOR® BOLO MACHETE™



Blister 31-002076

GATOR® BUSH MACHETE™



Blister 31-002848

GATOR® GOLOK MACHETE™



Blister 31-002850

GATOR® KUKRI MACHETE™



Blister 31-002074

GATOR® MACHETE PRO™



Blister 31-000705

GATOR® MACHETE JR™



Blister 31-000759

GATOR® MACHETE™



Blister 31-000758

Products shown are not to scale.

MULTI-TOOLS

MP600™ CARBIDE BLUNT NOSE



Box 07500

MP600™ CARBIDE BLUNT NOSE



Box 07520

MP600™ CARBIDE NEEDLE NOSE



Bliester 47530
Box 07530

MP600™ CARBIDE NEEDLE NOSE



Bliester 47550
Box 07550

KNIVES

RIVER SHORTY™



"The River Shorty is the classic, do anything, utility boat knife, canoe knife, PFD knife, inflatable knife. The new high visibility green handle is a great plus; the only real improvement needed."

★★★★

INSTRUCTOR/BOAT CREW



Bliester 31-002645 green handle w/ black sheath
Box 30-000967 black handle + sheath

STRONGARM™



"Gerber really hit it out of the park with this one! Put simply, this is one of the finest production knives I've ever owned."

★★★★★

DARREN, WASHINGTON



Bliester	31-002882	Fine edge	Black handle + black sheath
Box	30-001038	Fine edge	Black handle + black sheath
Bliester	31-002931	Fine edge	Coyote Brown handle + sheath
Box	30-001058	Fine edge	Coyote Brown sheath + sheath
Bliester	31-002933	Serrated	Black handle + black sheath
Box	30-001060	Serrated	Black handle + black sheath
Bliester	31-002932	Serrated	Coyote Brown handle + sheath [shown above]
Box	30-001059	Serrated	Coyote Brown handle + sheath

Products shown are not to scale.

FREESCAPE SERIES

FREESCAPE™ CAMP KITCHEN KNIFE



Blister 31-002533

FREESCAPE™ PARING KNIFE



Blister 31-002886

FREESCAPE™ FOLDING SHEATH KNIFE



Blister: 31-002527

FREESCAPE™ CAMP KITCHEN KIT



Wrap 30-001041



NEW FREESCAPE CAMP SAW™



Blister 31-002820

17.5" FREESCAPE HATCHET™



Hang card 31-002536

FREESCAPE™ LANTERN



Box 30-000932 large
Box 30-000933 small

FREESCAPE™ FLASHLIGHT



Blister 31-002560

B.O.S.S. TECH™

BALLS OF STAINLESS STEEL

**GERBER'S SMOOTHEST,
MOST CONSISTENT
DEPLOYMENT EVER.**

BALL-BEARING SYSTEM:

- + STAINLESS STEEL BALLS REDUCE FRICTION FOR SEAMLESS OPENING.
- + CAGE SYSTEM KEEPS BALLS CONTAINED FOR STABLE PERFORMANCE OVER TIME.



LESS FRICTION,
MORE STABILITY



NEW

US-ASSIST™

NEW

US-ASSIST™

The US-Assist. Designed and built in Portland, Oregon, this assisted-opening knife offers Gerber's smoothest, most consistent deployment to date. Including B.O.S.S. Tech™, it features a ball-bearing system to reduce friction & provide stable performance for the long haul. Intuitively designed and painstakingly tested, the US-Assist is the next generation of the everyday pocket knife.

BLADE LENGTH:	3.0"
OVERALL LENGTH:	7.2"
HANDLE:	GLASS-FILLED NYLON
BLADE:	S30V OR 420HC



"It opens really fast and smooth, every time."

ALICIA ELFVING, OREGON



B.O.S.S. TECH™

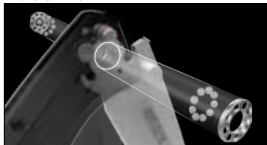

- BALL-BEARING DEPLOYMENT SYSTEM
- PLUNGE LOCK CROSSBOLT SYSTEM
- DUAL RAMPED THUMBSTUDS
- SCRATCH-RESISTANT CLIP

BOX	30-001205	FINE EDGE	S30V BLADE	PLUNGE LOCK	DUAL THUMBSTUDS	POCKET CLIP
BOX	30-001206	FINE EDGE	420HC BLADE	PLUNGE LOCK	DUAL THUMBSTUDS	POCKET CLIP
BLISTER	31-003105	FINE EDGE	420HC BLADE	PLUNGE LOCK	DUAL THUMBSTUDS	POCKET CLIP
BOX	30-001294	SERRATED	420HC BLADE	PLUNGE LOCK	DUAL THUMBSTUDS	POCKET CLIP
BLISTER	31-003240	SERRATED	420HC BLADE	PLUNGE LOCK	DUAL THUMBSTUDS	POCKET CLIP

NEW

Ø6 AUTO™ 1ØTH ANNIVERSARY EDITION

Honoring the American heritage and time-tested durability of the Ø6 Automatic family, Gerber proudly presents an innovative evolution of everything that made the original the best in its class. The Ø6 Automatic 1Øth Anniversary knife is a special edition celebration of Gerber's craftsmanship, design, and spirit. Thoughtful upgrades nod to Gerber's continued service to the US military: the Olive Drab green aluminum handle, the specialty stone washed finish on the S3ØV blade, as well as the commemorative reverse flag laser mark honoring those who serve. Born on the battlefield and tested everywhere else, this is a collectible not to be missed.

BLADE LENGTH:	3.8"
OVERALL LENGTH:	8.7"
HANDLE: CERAKOTE® COATED ALUMINUM	
BLADE:	S3ØV

Credentials required.



"In 2ØØ6, during combat operations in Iraq, this knife was issued to my platoon. 4 combat deployments later and she's still holding on strong. This is my favorite knife by far! I am going on 1Ø years with her and I haven't had one complaint."

RG Ø311, US ARMY

- CERAKOTE® COATED ALUMINUM HANDLES
- S3ØV BLADE W/ STONE WASHED FINISH
- PUSH BUTTON DEPLOYMENT
- 1ØTH ANNIVERSARY REVERSE FLAG LASER MARK
- POCKET CLIP FOR CONVENIENT STORAGE



NEW

EDICT™ GREEN

An evolution of the popular Gerber Edict, this knife was designed for everyday carry. The full size, drop point blade features a fine edge with no serrations, allowing for maximum cutting and slicing capabilities. Constructed of American 154CM steel, the blade offers excellent edge retention and features Gerber's standard glass bead finish for minimal reflection. Dual thumbstuds allow for quick one-handed blade deployment and the knife's lock back closing mechanism provides structural integrity in heavy-duty applications. The glass-filled nylon handle features a large palm swell, a finger guard for heavy-duty work, and a rubberized diamond texture for a secure grip in all weather conditions. Proudly made in Portland, OR.

BLADE LENGTH: 3.6"
OVERALL LENGTH: 8.5"
HANDLE: GLASS-FILLED NYLON
W/ RUBBER OVERMOLD
BLADE: 154CM



- RUBBERIZED DIAMOND TEXTURED HANDLE
- LOCKBACK MECHANISM
- DUAL THUMBSTUDS
- LANYARD HOLE
- POCKET CLIP

CFB™ [COMBAT FIXED BLADE]

The Combat Fixed Blade is tough, indestructible, and reliable. The full tang 154CM stainless steel tanto blade offers maximum strength and the partially serrated edge gives versatility. The molded plastic sheath can be worn on MOLLE, as well as your belt.

BLADE LENGTH:	4.3"
WEIGHT:	4.9 OZ
HANDLE:	RUBBERIZED GRIP
SHEATH:	INCLUDED
BLADE:	154CM STEEL



"It feels glorious in your hand and it's extremely light."

★★★★★

RICHARD, NORTH CAROLINA



CRISIS HOOK KNIFE™

This featherweight knife is engineered for emergency situations: a hook knife that cuts seatbelts, cords, or rope. The elongated profile and blunt tip provide versatile use, never fearing to injure those being rescued. A glass-breaker pommel is part of the handle.

BLADE LENGTH:	2.9"
WEIGHT:	3.0 OZ
HANDLE:	STEEL W/ RUBBER OVERMOLD
SHEATH:	INCLUDED
BLADE:	420C STEEL



BOX 22-01145DS SERRATED/TANTO BLACK FIBERGLASS REINFORCED NYLON SHEATH

BOX 30-000590 SINGLE BEVEL + HOOK TAN499 FRICTION LOCK, MOLLE-COMPATIBLE SHEATH

GHOSTRIKE® SERIES FIXED BLADE KNIFE / DELUXE KIT

This ultra-light self defense knife has a customizable sheath system that offers low profile or open carry. The fine edge blade is made of durable 420HC steel, a compact skeletal frame keeps it light in hand, and a rubber overmold gives optimal grip.

BLADE LENGTH:	3.3"
WEIGHT:	[W/ SHEATH] 3.6 OZ
	[W/ ANKLE WRAP] 6.0 OZ
SHEATH:	INCLUDED
HANDLE:	RUBBERIZED DIAMOND-TEXTURE GRIP
BLADE:	420HC [CERAMIC COATED BLADE]

"This is a well thought-out package that serves the needs of everyone from the foot patrol officer to the undercover bicyclist."

★★★★★

PHILLIP DERUNTZ, COMMISSIONER



31-002720 / 30-001006
sheath + neoprene ankle strap
Neoprene Ankle Strap Made in China

BLISTER BOX	31-002719	FINE EDGE/DROP POINT	MODULAR GLASS-FILLED NYLON SHEATH
BLISTER BOX	30-001005	FINE EDGE/DROP POINT	MODULAR GLASS-FILLED NYLON SHEATH
BLISTER BOX	31-002720	FINE EDGE/DROP POINT	MODULAR GLASS-FILLED NYLON SHEATH W/ NEOPRENE ANKLE WRAP
BLISTER BOX	30-001006	FINE EDGE/DROP POINT	MODULAR GLASS-FILLED NYLON SHEATH W/ NEOPRENE ANKLE WRAP



GHOSTRIKE® SERIES PUNCH KNIFE

This skeletonized t-handle fixed blade is designed for self-defense situations. A rubberized handle gives superior control for the 420HC steel blade. The glass-filled nylon sheath can be strung around the neck or worn on a tactical belt for access.

BLADE LENGTH:	2.5"
WEIGHT:	3.6 OZ
LANYARD:	550 CORD
SHEATH:	INCLUDED
HANDLE:	RUBBERIZED DIAMOND-TEXTURE GRIP
BLADE:	420HC STEEL [CERAMIC COATED BLADE]



BLISTER BOX	31-002721	FINE EDGE/DROP POINT	GLASS-FILLED NYLON SHEATH W/ 550 CORD FOR NECK CARRY
	30-001007	FINE EDGE/DROP POINT	GLASS-FILLED NYLON SHEATH W/ 550 CORD FOR NECK CARRY



GUARDIAN BACK-UP®

This professional fixed blade knife is built for self defense. Featuring a non-reflective black blade coating, this agile knife is stealth. The compact design and double edge blade make it extremely versatile, an adjustable tension sheath can be individually customized.

BLADE LENGTH:	3.4"
WEIGHT:	3.0 OZ
TANTO:	3.4 OZ
SHEATH:	INCLUDED
HANDLE:	TACHIDE™
BLADE:	HIGH CARBON STAINLESS



45803 / 05803
sheath

31-000559
sheath
Sheath Made
in China

BLISTER	45803	FINE EDGE/DOUBLE BEVEL	ADJUSTABLE TENSION MOLDED PLASTIC SHEATH
BOX	05803	FINE EDGE/DOUBLE BEVEL	ADJUSTABLE TENSION MOLDED PLASTIC SHEATH
BLISTER	31-000559	SERRATED/TANTO	ADJUSTABLE TENSION MOLDED PLASTIC SHEATH



LMF™ II

Field tested with American troops, this 10 inch survival knife was engineered in partnership with our country's bravest. This MOLLE-compatible knife is rugged and versatile, with a partially serrated blade that can also serve as pommel or a spear. The sheath includes a built-in blade sharpener.

BLADE LENGTH:	4.8"
WEIGHT:	11.0 OZ
SHEATH:	INCLUDED
HANDLE:	TACHIDE™
BLADE:	420HC



Infantry
sheath, strap
Sheath Made
in China

ASEK System + Survival
sheath, straps, strap cutter w/ sheath

"Outstanding knife."
★★★★★
KELLY DAMINER, OREGON



BOX	22-01400	SERRATED/DROP POINT	COYOTE BROWN	SHEATH, STRAPS, STRAP CUTTER W/ SHEATH [SURVIVAL]
BLISTER	22-41400	SERRATED/DROP POINT	COYOTE BROWN	SHEATH, STRAPS, STRAP CUTTER W/ SHEATH [SURVIVAL]
BOX	22-01629	SERRATED/DROP POINT	BLACK	SHEATH + STRAPS [INFANTRY]
BLISTER	22-41629	SERRATED/DROP POINT	BLACK	SHEATH + STRAPS [INFANTRY]
BOX	22-01463	SERRATED/DROP POINT	COYOTE BROWN	SHEATH + STRAPS [INFANTRY]
BLISTER	22-41463	SERRATED/DROP POINT	COYOTE BROWN	SHEATH + STRAPS [INFANTRY]
BOX	22-01626	SERRATED/DROP POINT	FG504 GREEN	SHEATH + STRAPS [INFANTRY]
BOX	22-01627G	SERRATED/DROP POINT	FG504 GREEN	SHEATH, STRAPS, STRAP CUTTER W/ SHEATH [ASEK] BERRY

MARK II™

First introduced in 1966, this combat knife has stood the test of time. Specifically designed for survival applications, the black oxide coated 420HC blade is double serrated. The die cast aluminum handle and well-placed bolsters give secure grip.

BLADE LENGTH:	6.5"
WEIGHT:	8.0 OZ
SHEATH:	INCLUDED
HANDLE:	ALUMINUM
BLADE:	420HC



Sheath Made
in China

BOX 22-01874 SERRATED/DOUBLE BEVEL BLACK SHEATH + STRAPS

PRODIGY™

Based on the award-winning LMF II, this smaller knife packs the same punch. The full tang 420HC American steel blade is beefy, coated with ceramic for corrosion resistance and reduced visibility. A friction lock, MOLLE-compatible sheath is included.

BLADE LENGTH:	4.8"
WEIGHT:	7.2 OZ
SHEATH:	INCLUDED
HANDLE:	TACHIDE™
BLADE:	420HC



Sheath Made
in China

*"I would trust this knife with my life.
Keep up the good work...."*

★★★★★

DAVID PRIDEMORE, SHERIFF

BLISTER	31-000558	SERRATED/TANTO POINT	CAMO NYLON SHEATH
BLISTER	22-41121	SERRATED/DROP POINT	BLACK SHEATH
BOX	22-01121	SERRATED/DROP POINT	BLACK SHEATH

RIVER SHORTY™

An excellent water sports knife, it meets the unique needs of rafting, paddling, and diving. A sturdy stainless steel blade, lightweight glass-filled nylon handle, and deliberately blunt tip ensure you can carry it on any number of watery excursions.

BLADE LENGTH:	3.0"
WEIGHT:	4.0 OZ
SHEATH:	INCLUDED
HANDLE:	GLASS-FILLED NYLON
BLADE:	420HC



SILVER TRIDENT™

Built for Special Ops personnel, this knife has the most technically advanced handle on a combat knife. Resistant to heat, UV light, and chemicals, it never quits. The 154CM double-edged blade is heat treated for edge retention, flexibility, and strength.

BLADE LENGTH:	6.5"
WEIGHT:	8.0 OZ
SHEATH:	INCLUDED
HANDLE:	HYTREL®
BLADE:	154CM



"Pictures do not do the knife justice. You have to put one in your hands to really appreciate quality, feel and appearance..."

★★★★★

TEDDY DELACERDA, RETIRED LAW ENFORCEMENT

BLISTER BOX	31-002645 30-000967	SERRATED / DOUBLE EDGE SERRATED / DOUBLE EDGE	GREEN W/ BLACK MOLDED PLASTIC SHEATH BLACK W/ BLACK MOLDED PLASTIC SHEATH
-------------	------------------------	--	--

BOX	06995	SERRATED / DOUBLE EDGE	RESISTANT TO HEAT, UV LIGHT & CHEMICALS	BLACK SHEATH + CORD
-----	-------	------------------------	---	---------------------

STRAP CUTTER™

With an innovative design that shields the cutting edge, this tool serves its purpose in emergency situations. The 42ØHC steel hook knife cuts through anything, the molded rubber grip and finger hole add stability, and a glass breaker wastes no time.

OVERALL LENGTH:	4.4"
WEIGHT:	5.4 OZ
SHEATH:	INCLUDED
HANDLE:	INJECTION MOLDED RUBBER GRIP
BLADE:	42ØHC



"Best seat belt cutter I've used, cuts through pants and boots."



JEFF, SEARCH & RESCUE MEDIC



BOX	22-Ø1943	SINGLE BEVEL W/ HOOK	FG504 GREEN	MOLDED PLASTIC SHEATH
BOX	3Ø-ØØØ132	SINGLE BEVEL W/ HOOK	COYOTE BROWN	MOLDED PLASTIC SHEATH
BOX	22-Ø1944	SINGLE BEVEL W/ HOOK	BLACK	MOLDED PLASTIC SHEATH

NEW

STRONGARM™

With a full tang, 42ØHC steel blade and rubberized diamond-texture grip, this is a knife you can bet your life on. A MOLLE-compatible multi-mount sheath system offers optimal customization, keeping your knife ever at the ready in combat situations.

BLADE LENGTH:	4.8"
WEIGHT:	7.2 OZ
SHEATH:	INCLUDED
HANDLE:	GLASS-FILLED NYLON W/ RUBBER
BLADE:	42ØHC



"Put simply, this is one of the finest production knives I've ever owned."



DARREN, WASHINGTON



BLISTER	31-ØØ2882	FINE EDGE/DROP POINT	FULL TANG BLACK SHEATH	BERRY
BOX	3Ø-ØØ1Ø38	FINE EDGE/DROP POINT	FULL TANG BLACK SHEATH	BERRY
BLISTER	31-ØØ2931	FINE EDGE/DROP POINT	FULL TANG COYOTE BROWN SHEATH	BERRY
BOX	3Ø-ØØ1Ø58	FINE EDGE/DROP POINT	FULL TANG COYOTE BROWN SHEATH	BERRY
BLISTER	31-ØØ2933	SERRATED/DROP POINT	FULL TANG BLACK SHEATH	BERRY
BOX	3Ø-ØØ1Ø6Ø	SERRATED/DROP POINT	FULL TANG BLACK SHEATH	BERRY
BLISTER	31-ØØ2932	SERRATED/DROP POINT	FULL TANG COYOTE BROWN SHEATH	BERRY
BOX	3Ø-ØØ1Ø59	SERRATED/DROP POINT	FULL TANG COYOTE BROWN SHEATH	BERRY

PROPEL™ AO

Developed to serve military and law enforcement, this tactical addition is a knife you can bet your life on. Premium design offers a stealth black oxide 420HC steel blade, a grippy G-10 composite handle, and innovative blade deployment that keeps safety front of mind.

BLADE LENGTH:	3.5"
WEIGHT:	4.3 OZ
HANDLE:	G-10 COMPOSITE
BLADE:	BLACK 420HC
	DOWNRANGE S30V



"I have been using Gerber tools for a long time and this is by far the best tool so far I've used."



RAUL C5, ACTIVE DUTY

BOX	30-000840	SERRATED/TANTO	BLACK	420HC	ASSISTED OPENING W/ PLUNGE LOCK & SAFETY
BOX	30-000841	SERRATED/TANTO	DOWNRANGE	S30V	ASSISTED OPENING W/ PLUNGE LOCK & SAFETY
BOX	30-000845	SERRATED/TANTO	BLACK	S30V	ASSISTED OPENING W/ PLUNGE LOCK & SAFETY



NEW

Ø6 AUTOMATIC™

Fully automatic and ready for anything, this knife has a premium design that sets it apart. With a corrosion resistant S30V steel blade anchored by an oversize blade release button, a striking pommel, and a lanyard hole - you are never unprepared.

BLADE LENGTH: 3.8"
 WEIGHT: 6.3 OZ
 HANDLE: ANODIZED ALUMINUM
 BLADE: S30V

Credentials required.



"In 2006, during combat operations in Iraq, this knife was issued to my platoon. 4 combat deployments later and she's still holding on strong. This is my favorite knife by far! I am going on 10 years with her and I haven't had one complaint."

★★★★★

RG 0311, US ARMY



BOX 30-000377	SERRATED/DROP POINT	CORROSION RESISTANT	STRIKING POMMEL	OVERSIZE BLADE RELEASE BUTTON	
BOX 30-000850	SERRATED/TANTO	CORROSION RESISTANT	STRIKING POMMEL	OVERSIZE BLADE RELEASE BUTTON	
BOX 30-000193	SERRATED/TANTO G-10	CORROSION RESISTANT	STRIKING POMMEL	OVERSIZE BLADE RELEASE BUTTON	
BOX 30-001295	FINE EDGE/DROP POINT	STRIKING POMMEL	OVERSIZE BLADE RELEASE BUTTON	NEW	
BOX 30-001297	FINE EDGE/TANTO	STRIKING POMMEL	OVERSIZE BLADE RELEASE BUTTON	NEW	
BOX 30-001296	FINE EDGE/TANTO G-10	STRIKING POMMEL	OVERSIZE BLADE RELEASE BUTTON	NEW	



APPLEGATE-FAIRBAIRN™ COVERT AUTOMATIC

An evolution of the best-in-class Applegate-Fairbairn folder, this knife features a spring-loaded auto release that deploys at the touch of a button. With premium S30V steel and a perfectly balanced design, this tactical folder is a sure favorite.

BLADE LENGTH: 3.8"
 WEIGHT: 5.0 OZ
 HANDLE: ANODIZED ALUMINUM
 BLADE: S30V

Credentials required.



"This is possibly the best blade I've ever carried on or off duty. It is light weight, very concealable and opens quickly."

★★★★★

"BLUTO", LE NARCOTICS



BOX 30-000137 SERRATED/DROP POINT SPRING LOADED AUTO RELEASE S30V STEEL BLADE

APPLEGATE-FAIRBAIRN™ MINI COVERT AUTOMATIC

An evolution of the best-in-class Applegate-Fairbairn folder, this compact version features a spring-loaded auto release that deploys at the touch of a button. With premium S30V steel and a perfectly balanced design, this discreet folder is a sure favorite.

BLADE LENGTH:	2.8"
WEIGHT:	2.1 OZ
HANDLE:	ANODIZED ALUMINUM
BLADE:	S30V

Credentials required.



D.M.F.™ [DUAL MULTI FUNCTION] AUTOMATIC

DMF stands for Dual Multi Function, perfectly fitting for this auto knife that springs into action ambidextrously. The robust design features a G-10 composite handle, beefy S30V tanto blade, and a striking pommel for emergencies, keeping you ever at the ready.

BLADE LENGTH:	3.5"
WEIGHT:	8.5 OZ
HANDLE:	G-10 COMPOSITE
BLADE:	S30V

Credentials required.



"The DMF auto folder has worked perfectly for me."

★★★★★

CHUCK , DAMAGE CONTROLMAN

BOX 30-000244 SERRATED/DROP POINT SPRING LOADED AUTO RELEASE S30V STEEL BLADE

BOX 30-000190 SERRATED/TANTO G-10 COMPOSITE HANDLE S30V STEEL BLADE STRIKING POMMEL

EMERSON ALLIANCE™ AUTOMATIC

Built for the demands of the tactical user, this knife offers fully automatic deployment, a stealth black oxide-coated 154CM blade, and a 6061-T6 anodized aluminum handle.

BLADE LENGTH:	3.4"
WEIGHT:	6.0 OZ
HANDLE:	ANODIZED ALUMINUM
BLADE:	154CM

Credentials required.



PROPEL™ AUTOMATIC

Durable, fast to deploy, and rugged. This knife is a one-hand opening workhorse with a S30V tanto blade that can cut through anything; the black oxide coating and G-10 composite handle minimize slip to keep you safe in critical conditions.

BLADE LENGTH:	3.5"
WEIGHT:	4.3 OZ
HANDLE:	G-10 COMPOSITE
BLADE:	DOWNRANGE: S30V
	BLACK: 420HC

Credentials required.



"Love this knife. Quality lock-up, feel, and comfortable to control. Extremely easy to deploy the blade with gloves on."

★★★★★
UNNAMED, USAF SPECIAL OPERATIONS

BOX	22-07158	SERRATED/DROP POINT	BLACK OXIDE COATED 154CM BLADE
-----	----------	---------------------	--------------------------------

BOX	30-000717	SERRATED/TANTO	DOWNRANGE	G-10 COMPOSITE HANDLE
BOX	30-000842	SERRATED/TANTO	BLACK	G-10 COMPOSITE HANDLE

Ø6 COMBAT FOLDER™

American made and ready for anything, this knife has a premium design that sets it apart. With a corrosion resistant S30V steel drop point blade anchored by a sturdy plunge lock, a striking pommel, and a reversible pocket clip you are never unprepared.

BLADE LENGTH:	3.8"
WEIGHT:	8.6 OZ
HANDLE:	ALUMINIUM
BLADE:	S30V



APPLEGATE-FAIRBAIRN™ COVERT

Leading the ranks of the best-in-class tactical folding knives, the Covert has earned a reputation for strength, durability, and balance. The 154CM steel blade, glass-filled nylon handle, and patented rotolock combine to make an unsurpassable tool.

BLADE LENGTH:	3.8"
WEIGHT:	4.2 OZ
HANDLE:	GLASS-FILLED NYLON
BLADE:	154CM



"Bought mine in the PX at Camp Victory in Baghdad 2004. Solid as a rock and is my everyday companion in my pocket. I'd buy another in a heartbeat if I ever lost this one."

★★★★★
ANDY C, IRAQ VET

BOX	30-000308	SERRATED/DROP POINT	REVERSIBLE POCKET CLIP [OPTIONAL CARRY]
BOX	30-000462	FINE EDGE/DROP POINT	REVERSIBLE POCKET CLIP [OPTIONAL CARRY]

BOX	05785	SERRATED/DOUBLE BEVEL	PATENTED ROTOLOCK MECHANISM
BLISTER	45786	SERRATED/DOUBLE BEVEL	TITANIUM NITRIDE COATED BLADE
BOX	05786	SERRATED/DOUBLE BEVEL	TITANIUM NITRIDE COATED BLADE

DECREE™

The S3ØV modified tanto blade provides superior piercing ability, easily accessed by the thumbstuds or finger flipper. Black ceramic protects the blade against corrosion; a glass-filled nylon, rubberized diamond texture handle is tough and easy to grip.

BLADE LENGTH: 3.7"
WEIGHT: 4.8 OZ
HANDLE: RUBBERIZED
DIAMOND-TEXTURE
BLADE: S3ØV



*"Excellent blade...
awesome folding knife."*



OSVALDO



BLISTER BOX	31-002718 30-001004	SERRATED/MODIFIED TANTO SERRATED/MODIFIED TANTO	TEMPERED STEEL GLASS BREAKER TEMPERED STEEL GLASS BREAKER
-------------	------------------------	--	--



EDICT™

Designed for soldiers and first responders, this tough knife has a full size, fine edge tanto blade for maximum piercing and slicing capabilities. The 154CM steel blade is anchored with a lock back design providing structural integrity in heavy-duty applications.

BLADE LENGTH:	3.6"
WEIGHT:	3.6 OZ
HANDLE:	RUBBERIZED DIAMOND-TEXTURE
BLADE:	154CM



BLISTER	31-002761	FINE EDGE/TANTO	BLACK
BOX	30-001020	FINE EDGE/TANTO	BLACK



E-Z OUT™

Profoundly versatile and easy to use, this knife is meant to tackle your daily life. With a rugged polycarbonate handle that also has SoftGrip® inserts, this handle offers superior grip. Easily deploy the blade with a well-placed cutout, as the name suggests.

BLADE LENGTH:	DPSF: 3.5"
	JR: 2.4"
	RESCUE: 3.5"
	SKELETON: 3.5"
WEIGHT:	DPSF: 2.8 OZ
	JR: 1.4 OZ
	RESCUE: 2.4 OZ
	SKELETON: 2.6 OZ
HANDLE:	GLASS-FILLED NYLON W/ TACHIDE™ INLAY



DPSF version



BOX	22-01648G	SERRATED/BLACK BLADE	DPSF	S30V BLADE STEEL
BOX	22-01643G	SERRATED/SATIN BLADE	DPSF	S30V BLADE STEEL
BOX	06551	SERRATED	JR	
BOX	06501	FINE EDGE	JR	
BOX	06971	SERRATED	RESCUE	YELLOW HANDLE
BLISTER	06701	FINE EDGE/CLIP POINT	SKELETON	
BLISTER	46751	SERRATED/CLIP POINT	SKELETON	
BOX	06751	SERRATED/CLIP POINT	SKELETON	

ORDER™

This American-made tactical folder is thoughtfully designed and lightweight for use over the long haul. A 420HC black ceramic-coated blade, rubberized diamond-texture handle, sturdy pocket clip, and partially serrated blade ensure preparedness.

BLADE LENGTH:	3.1"
WEIGHT:	2.6 OZ
HANDLE:	RUBBERIZED
DIAMOND-TEXTURE	
BLADE:	420HC



SAFETY AUTO HOOK [S.A.H.]™

Built of American ingenuity, this versatile knife was designed for emergencies when every second counts. The 420HC modified drop point blade partners with an auto hook that deploys instantly to secure the situation. A premium G-10 composite handle offers superior stability.

BLADE LENGTH:	3.6"
WEIGHT:	6.7 OZ
HANDLE:	G-10 COMPOSITE
BLADE:	420HC



BLISTER BOX	31-002733 30-001011	SERRATED/THUMB HOLE SERRATED/THUMB HOLE	LOCK BACK OPENING/CLOSING MECHANISM LOCK BACK OPENING/CLOSING MECHANISM
-------------	------------------------	--	--

BOX	30-000185	SERRATED/MODIFIED DROP POINT AUTO HOOK - DEPLOYS W/ BUTTON AFTER RELEASING SAFETY
-----	-----------	---

APPLEGATE-FAIRBAIRN™ COMBAT FOLDER

Honoring the late Colonel Rex Applegate, this first-class tactical folder is designed for close quarter combat situations. Unrivalled strength meets perfected balance in the form of a glass-filled nylon handle opposite a high-carbon stainless steel blade.

BLADE LENGTH: 4.5"
WEIGHT: 7.4 OZ
SHEATH: INCLUDED
HANDLE: GLASS-FILLED NYLON
BLADE: HIGH CARBON STAINLESS



"Issued to me just shy of 10 years ago, it has survived multiple combat tours, being abused as everything from a daily use knife, to a can opener, and even a pry bar on several occasions..."



DREW, US ARMY SPECIAL FORCES



BLISTER BOX	45780 ø5780	SERRATED/DOUBLE BEVEL	PATENTED ROTO-LOCK SYSTEM	BERRY COMPLIANT SHEATH
		SERRATED/DOUBLE BEVEL	PATENTED ROTO-LOCK SYSTEM	BERRY COMPLIANT SHEATH

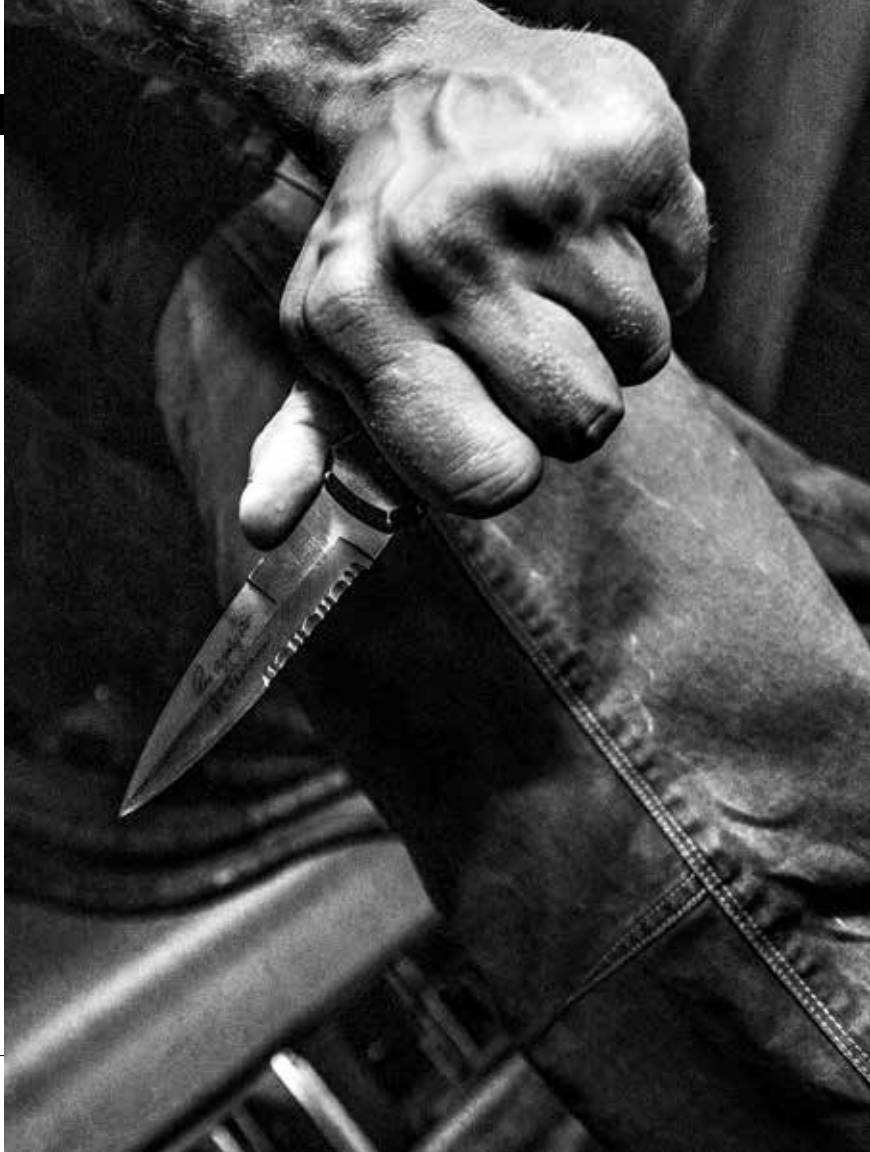

GATOR®

With an iconic design, the Gator® series has become synonymous with craftsmanship and field-tested durability. A portable folding application partners with the patented Gator Grip® handle to offer unsurpassed comfort and ease of use.

BLADE LENGTH:	3.8"
WEIGHT:	5.4 OZ
SHEATH:	INCLUDED
HANDLE:	GATOR GRIP®
BLADE:	154CM
CLIP POINT/GUT HOOK 42ØHC	



"This Gator 154cm is the sharpest and nicest knife in my bag! Made in USA also."

★★★★★

ARNIE HOYT, OUTDOORSMAN/HUNTER



GATORMATE®

Detail oriented and compact, this smaller version is perfectly designed for clean cuts and moments that demand finesse. Outfitted with the same dependable Gator Grip®, this pocket folder is sure to be a consistent companion.

BLADE LENGTH:	3.1"
WEIGHT:	3.Ø OZ
SHEATH:	INCLUDED
HANDLE:	GATOR GRIP®
BLADE:	42ØHC



Sheath made in China



Sheath made in China

BLISTER BOX	46Ø79	SERRATED/CLIP POINT	LOCK-BACK MECHANISM SECURES BLADE IN OPEN POSITION
BLISTER BOX	Ø6Ø79	SERRATED/CLIP POINT	LOCK-BACK MECHANISM SECURES BLADE IN OPEN POSITION
BLISTER BOX	46Ø69	FINE EDGE/CLIP POINT	GATOR GRIP® HANDLE TEXTURE FOR MAXIMUM GRIP
BLISTER BOX	Ø6Ø69	FINE EDGE/CLIP POINT	GATOR GRIP® HANDLE TEXTURE FOR MAXIMUM GRIP

BOX	Ø6149	FINE EDGE/CLIP POINT	GATOR GRIP® HANDLE TEXTURE FOR MAXIMUM GRIP
-----	-------	----------------------	---

LST™ [LIGHTWEIGHT, STRONG, TOUGH]

Brought to market by none other than Pete Gerber himself, this little knife has a big history. With a handle completely constructed of all synthetic materials, it set a new standard in craftsmanship. Also featuring a 42ØHC blade and built in America, this classic can't be missed.

BLADE LENGTH: 2.6"
ULTRALIGHT: 2.0"
WEIGHT: 1.2 OZ
ULTRALIGHT: 0.6
HANDLE: GLASS-FILLED NYLON
BLADE: 42ØHC



US1™

Drawing on decades of experience perfecting the folding pocket knife, the US1 is an American made testament to great design. The best-in-class 42ØHC blade is deployed with a simple nail nick and held in check by an easy to operate lock back design.

BLADE LENGTH: 2.6"
WEIGHT: 1 OZ
HANDLE: 30% GLASS-FILLED NYLON
W/ RUBBER OVERMOLD
BLADE: 42ØHC



"This is a great knife. Light weight. Lock-back. Great blade length. Made in the USA. And non-serrated!!"

★★★★
SCOTT, VIRGINIA

BLISTER	46009	FINE EDGE/DROP POINT	TACTILE TEXTURED HANDLE	LOCK-BACK DESIGN
BOX	22-06009	FINE EDGE/DROP POINT	TACTILE TEXTURED HANDLE	LOCK-BACK DESIGN
BLISTER	46050	FINE EDGE/DROP POINT	ULTRALIGHT LST	LOCK-BACK DESIGN
BOX	22-06050	FINE EDGE/DROP POINT	ULTRALIGHT LST	LOCK-BACK DESIGN

BLISTER	31-003040	FINE EDGE/DROP POINT	THIN AND LIGHTWEIGHT	NAIL NICK
---------	-----------	----------------------	----------------------	-----------

DOWNRANGE TOMAHAWK™

A marvel of simplicity, this tool has a single-minded goal: to settle the breaching argument. No barrier is a match for the beveled edge axe head, the hammer head element, or the pry bar built into the tan G-10 composite handle. A 420HC steel body won't break under pressure.

OVERALL LENGTH: 19.3"
WEIGHT: 1.9 LBS
SHEATH: INCLUDED
HANDLE: G-10 COMPOSITE

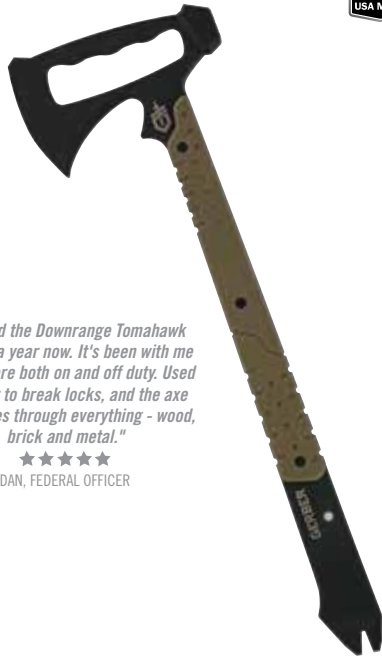

"I've had the Downrange Tomahawk close to a year now. It's been with me everywhere both on and off duty. Used hammer to break locks, and the axe blade goes through everything - wood, brick and metal."

★★★★★

DAN, FEDERAL OFFICER



Sheath Made
in China

BOX 30-000715 FINE EDGE MOLLE- COMPATIBLE SHEATH INTEGRATED PRYING HANDLE BERRY



CENTER AXIS TECH™

**THE ONLY MULTI-TOOL THAT
OPERATES LIKE A REAL SCREWDRIVER.**

MAXIMUM TORQUE + PERFORMANCE.

- + CENTER AXIS ALIGNMENT
- + 3.25 INCH LONG DRIVER
- + STANDARD MAGNETIC BIT SET



NEW

CENTER-DRIVE™

NEW

CENTER-DRIVE™

The Center-Drive. Gerber's new multi-tool that offers uncompromising performance through revolutionary design. The innovative center-axis driver opens to align like a real screw driver, yielding maximum torque and rotation. No productivity is sacrificed with the addition of a 30% longer outboard blade and one-thumb opening sliding jaws. Full size, real tools - the multi-tool just got a reality check.

CLOSED LENGTH:	4.7"
OPEN LENGTH:	6.6"
WEIGHT:	9.5 OZ

CENTER AXIS TECH™

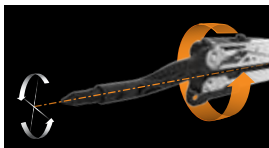

*"This tool has everything I need,
and nothing I don't."*

Alicia Elfving Gerber Badassador
| MOTORCYCLIST, PHOTOGRAPHER, JOURNALIST

BOX 30-001193	ROTATABLE CARBIDE WIRE CUTTERS + STRIPPERS	PRY BAR, NAIL PULLER + BOTTLE OPENER	SHEATH
BLISTER 31-003073	ROTATABLE CARBIDE WIRE CUTTERS + STRIPPERS	PRY BAR, NAIL PULLER + BOTTLE OPENER	SHEATH
BOX 30-001194	ROTATABLE CARBIDE WIRE CUTTERS + STRIPPERS	PRY BAR, NAIL PULLER + BOTTLE OPENER	BITSET + SHEATH
BLISTER 31-003074	ROTATABLE CARBIDE WIRE CUTTERS + STRIPPERS	PRY BAR, NAIL PULLER + BOTTLE OPENER	BITSET + SHEATH
BOX 30-001195	ROTATABLE CARBIDE WIRE CUTTERS + STRIPPERS	PRY BAR, NAIL PULLER + BOTTLE OPENER	MOLLE SHEATH
BLISTER 31-003075	ROTATABLE CARBIDE WIRE CUTTERS + STRIPPERS	PRY BAR, NAIL PULLER + BOTTLE OPENER	MOLLE SHEATH
BOX 30-001196	ROTATABLE CARBIDE WIRE CUTTERS + STRIPPERS	PRY BAR, NAIL PULLER + BOTTLE OPENER	BITSET + MOLLE SHEATH
BLISTER 31-003076	ROTATABLE CARBIDE WIRE CUTTERS + STRIPPERS	PRY BAR, NAIL PULLER + BOTTLE OPENER	BITSET + MOLLE SHEATH

- ONE THUMB OPENING SYSTEM
- SPRING-LOADED PLIERS
- CENTER AXIS DRIVER
- FULL SIZE FINE EDGE BLADE
- SHEATH INCLUDED



Bitset



DIESEL™

Big. Tough. Capable. Versatile. The Diesel is all of these things and more, available to you at the flick of a wrist. With true one-handed deployment, this tool is the ultimate in efficiency. The industrial strength components are larger and stronger, for the toughest of jobs.

OVERALL LENGTH: 6.6"
CLOSED LENGTH: 4.9"
WEIGHT: 8.6 OZ

- Partially serrated blade
- V-cut wire cutters
- Small, medium, & large flat drivers
- Phillips driver
- Scissors
- File
- Bottle opener
- Can opener
- Saw



"Very tough and very useful!"



JEREMY, NEW ZEALAND



22-41470 /
22-01470
Stainless



MP400™ COMPACT SPORT

Building on the success of the larger one-hand opening models, this compact version is nimble but just as tough. Built to solve for everyday snags, this tool has 12 carefully chosen components packed into an unobtrusive 7 ounce package. Built in the USA, built to last.

OVERALL LENGTH: 5.6"
CLOSED LENGTH: 4.4"
WEIGHT: 6.8 OZ

- Partially serrated blade
- Wire cutters
- Wire stripper
- Small, medium & large flat drivers
- Phillips driver
- Scissors
- Bottle opener
- Can opener

"Love it. Would not go to the woods without it."



VEARL WILLIAMS



45500 / 05500
Stainless



BLISTER	22-41545	NEEDLE NOSE PLIERS	SAFT.PLUS™ LOCKING KNIFE & TOOLS	BLACK
BOX	22-01545	NEEDLE NOSE PLIERS	SAFT.PLUS™ LOCKING KNIFE & TOOLS	BLACK
BLISTER	22-41470	NEEDLE NOSE PLIERS	SAFT.PLUS™ LOCKING KNIFE & TOOLS	STAINLESS
BOX	22-01470	NEEDLE NOSE PLIERS	SAFT.PLUS™ LOCKING KNIFE & TOOLS	STAINLESS

BLISTER	22-45509	NEEDLE NOSE PLIERS	SAFT.PLUS™ LOCKING KNIFE & TOOLS	BLACK
BOX	22-05509	NEEDLE NOSE PLIERS	SAFT.PLUS™ LOCKING KNIFE & TOOLS	BLACK
BLISTER	45500	NEEDLE NOSE PLIERS	SAFT.PLUS™ LOCKING KNIFE & TOOLS	STAINLESS
BOX	05500	NEEDLE NOSE PLIERS	SAFT.PLUS™ LOCKING KNIFE & TOOLS	STAINLESS

MP600™ BASIC

As the #1 selling multi-tool platform to the US military, the MP600 series has been to hell and back. Serving those who serve, this tool is built to be tough and accessible. A one-hand opening design is crucial, as is the durable stainless body, the variety of 14 tools, and multiple versions that are specialized for any situation.

OVERALL LENGTH: 6.4"
 CLOSED LENGTH: 4.9"
 WEIGHT: 9.0 OZ

- Fine edge blade
- Serrated blade
- Wire crimper
- Jaw wire cutters
- Small, medium & large flat drivers
- Phillips driver
- File
- Ruler
- Bottle opener
- Can opener
- Key chain ring

"One of the best tools I've ever owned."



JASON C, USMC VETERAN



47550 / 07550
 Black



BLISTER	47530	NEEDLE NOSE PLIERS	SAFT.PLUS™ LOCKING KNIFE & TOOLS	STAINLESS
BOX	07530	NEEDLE NOSE PLIERS	SAFT.PLUS™ LOCKING KNIFE & TOOLS	STAINLESS
BLISTER	47550	NEEDLE NOSE PLIERS	SAFT.PLUS™ LOCKING KNIFE & TOOLS	BLACK
BOX	07550	BLUNT NOSE PLIERS	SAFT.PLUS™ LOCKING KNIFE & TOOLS	STAINLESS



MP600™ CARBIDE

As the #1 selling multi-tool platform to the US military, the MP600 series has been to hell and back. Still inclusive of everything that makes the original great, this version of the tool features replaceable Tungsten Carbide wire cutters. Some situations require a little extra grit.

OVERALL LENGTH:	6.4"
CLOSED LENGTH:	4.9"
WEIGHT:	9.0 OZ

- Fine edge blade
- Serrated blade
- Wire crimper
- Tungsten carbide cutters
- Small, medium & large flat drivers
- Phillips driver
- Saf.T.Plus™ locking knife & tools
- File
- Ruler
- Bottle opener
- Can opener
- Key chain ring

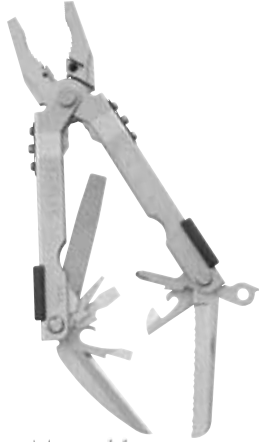

Ø7510G
Tool kit Made in
China & Taiwan



BOX	Ø7500 / Ø7500G	BLUNT NOSE PLIERS	STAINLESS		Ø7500 BERRY SHEATH
BOX	Ø7505G	BLUNT NOSE PLIERS	STAINLESS		LEATHER SHEATH
BLISTER	Ø7510G	BLUNT NOSE PLIERS	STAINLESS	TOOL KIT	BERRY SHEATH
BOX	Ø7520	BLUNT NOSE PLIERS	BLACK		
BOX	Ø7520G1	BLUNT NOSE PLIERS	BLACK		BERRY SHEATH
BLISTER	Ø7530G	NEEDLE NOSE PLIERS	STAINLESS		BERRY SHEATH
BOX	Ø7535G	NEEDLE NOSE PLIERS	STAINLESS		LEATHER SHEATH
BOX	Ø7550G1	NEEDLE NOSE PLIERS	BLACK		BERRY SHEATH
BOX	30-000314	NEEDLE NOSE PLIERS	BLACK		LEATHER SHEATH
BOX	30-000453	NEEDLE NOSE PLIERS	BLACK		TAN499 BERRY SHEATH
BOX	30-000952	NEEDLE NOSE PLIERS	BLACK BLADELESS	SCISSORS	REMGRIT® SAW

MP600 PRO SCOUT™

As the #1 selling multi-tool platform to the US military, the MP600 series has been to hell and back. Serving those who serve, this tool is built to be tough and accessible. A one-hand opening design is crucial, as is the durable stainless body, the variety of 14 tools, and multiple versions that are specialized for any situation.

OVERALL LENGTH:	6.6"
CLOSED LENGTH:	5.0"
WEIGHT:	9.0 OZ

- Partially serrated blade
- Wire cutters
- Wire crimper
- Small & medium flat drivers
- Phillips driver
- Scissors
- RemGrit® saw
- File
- Ruler
- Bottle opener
- Can opener



Ø7564
Tool Kit

Sheath
Made
in China

BLISTER	47563	NEEDLE NOSE PLIERS	SAFT.PLUS™ LOCKING KNIFE & TOOLS	STAINLESS
BOX	Ø7563	NEEDLE NOSE PLIERS	SAFT.PLUS™ LOCKING KNIFE & TOOLS	STAINLESS
BOX	Ø7564	NEEDLE NOSE PLIERS	SAFT.PLUS™ LOCKING KNIFE & TOOLS	STAINLESS W/ TOOLKIT

MP600™ D.E.T.

Designed specifically with the combat engineer in mind, this version of the MP600 is built to offer compact versatility. Covered in a black, non-reflective coating that won't give you away, this tool is easily accessible with one hand. Built with task-specific tools, this tool is invaluable.

OVERALL LENGTH: 6.6"
CLOSED LENGTH: 5.0"
WEIGHT: 9.0 OZ

- C4 punch
- Blasting cap crimper
- Partially serrated blade
- Wire cutters
- Wire crimper
- Large flat driver
- Phillips driver
- RemGrit® saw
- File
- Ruler
- Can opener
- Key chain ring



"I have used this piece of kit during my past four deployments. Probably my most used tool of all."



JOHN LIDER, US ARMY



MP600-ST™ [SIGHT TOOL]

Built on the successful one-handed design of the MP600 series, this updated version has a more focused objective. With a longer Phillips driver, a serrated/fine edge blade, a carbon scraper for maintenance, and a front sight adjustment tool it will quickly be indispensable.

OVERALL LENGTH: 6.5"
CLOSED LENGTH: 4.0"
WEIGHT: 9.6 OZ

- Stainless steel w/ black oxide finish
- M4/M16 Front sight post adjustment tool
- Carbon scraper
- Partially serrated blade
- Carbide wire cutters
- Small & medium flat drivers
- Long reach Phillips driver
- Scissors
- File
- Bottle opener
- Can opener
- Saw
- Key chain ring



BOX 07400 NEEDLE NOSE PLIERS SAF.T.PLUS™ LOCKING KNIFE & TOOLS NON-REFLECTIVE BLACK FINISH BERRY SHEATH

BLISTER	31-001519	NEEDLE NOSE PLIERS	SAF.T.PLUS™ LOCKING KNIFE & TOOLS BLACK	SHEATH
BOX	30-000588	NEEDLE NOSE PLIERS	SAF.T.PLUS™ LOCKING KNIFE & TOOLS BLACK	SHEATH
BOX	30-000513	NEEDLE NOSE PLIERS	SAF.T.PLUS™ LOCKING KNIFE & TOOLS BLACK	BERRY SHEATH

MP1™

Simple doesn't have to mean boring. On the contrary, the MP1 Multi-Plier is proof that when done with care and 12 professional-grade components, simple can be all you need. A butterfly open design, high quality carbon steel, and spring-loaded pliers are only the beginning.

OVERALL LENGTH:	6.9"
CLOSED LENGTH:	4.4"
WEIGHT:	8 OZ

- Forged, spring-loaded plier jaws
- Textured G-1Ø composite handles
- Large fine edge blade
- Large serrated blade
- Utility blade/scraper
- Wire stripper
- Diagonal cutters
- Small & large flat drivers
- Magnetic bit driver w/ #2 Phillips
- Pry bar
- Bottle opener
- Key chain ring



Sheath
Made
in China



Berry
TAN499

BLISTER	31-001142	NEEDLE NOSE PLIERS	2 POSITION (HORIZONTAL/VERTICAL) SHEATH
BOX	30-000477	NEEDLE NOSE PLIERS	2 POSITION (HORIZONTAL/VERTICAL) SHEATH
BOX	30-001009	NEEDLE NOSE PLIERS	BERRY SHEATH – TAN499



MP1-AR™ WEAPONS TOOL

As an ally to the US military, Gerber understands the specific needs of those who serve. This new evolution of a classic is focused on weapons cleaning and maintenance, loaded with task-specific tools and a 12 piece universal bit set. A MOLLE-compatible sheath is included.

OVERALL LENGTH:	7.3"
CLOSED LENGTH:	4.3"
WEIGHT W/SHEATH:	9.7 OZ

- Forged, spring-loaded plier jaws
- Large fine edge blade
- Large serrated blade
- Carbon scraper
- Takedown pin punch
- Dental-style carbon pick
- Wire stripper
- Wire cutter
- Magnetic bit driver w/
 - Torx bits
 - Hex bits
 - Phillips bits
 - Front sight adjustment tool
 - Trigger assembly pin punch



"It's a sturdy and solid tool and all of the implements are actually useful...it exudes quality, and attention to detail is second to none. Highly recommended. Big thumbs up."



GEOFF METAK, SGT. MAJOR 4TH MARINE LOGISTICS GROUP



Bit Set



BLISTER	31-002779	NEEDLE NOSE PLIERS	MOLLE-COMPATIBLE COYOTE SHEATH	12 PIECE BIT SET
BOX	30-001024	NEEDLE NOSE PLIERS	MOLLE-COMPATIBLE COYOTE SHEATH	12 PIECE BIT SET
BOX	30-001180	NEEDLE NOSE PLIERS	BERRY SHEATH – BLACK	12 PIECE BIT SET

MP1-MRO™ [MAINTENANCE, REPAIR & OPERATIONS] TOOL

As an ally to the US military, Gerber understands the specific needs of those who serve. This new evolution of a classic is focused on maintenance, repairs, and operations, loaded with task-specific tools for your vehicle and a 12 piece universal bit set. A MOLLE-compatible sheath is included.

OVERALL LENGTH: 7.3"
CLOSED LENGTH: 4.3"
WEIGHT: 9.7 OZ

- Forged, spring-loaded plier jaws
- 42ØHC fine edge blade
- 42ØHC serrated blade w/ hook blade
- Utility blade
- Cotter pin hook
- File w/ tire tread gauge
- Pry bar w/ bottle opener



Bit Set



LEGEND MP8ØØ™

In terms of reliable comfort, the Legend has no equal. With a strong stainless steel body and contoured aluminum handles with tactile rubber inserts, this tool remains steadily in hand for tough jobs. Spring-loaded pliers relieve hand strain while each tool serves a purpose.

OVERALL LENGTH: 6.6"
CLOSED LENGTH: 4.3"
WEIGHT: 9.8 OZ

- Stainless steel E-coat
- Aluminum handles w/ rubber inserts
- RemGrit® saw
- Partially serrated blade
- Tungsten carbide cutters
- Small, medium, & large flat drivers
- Phillips driver
- Scissors
- File
- Bottle opener
- Key chain ring



"I would rather forget my lunch than this tool when going to work. Used daily for over 2 years and have been dropped several times from height and still going strong!"

★★★★★

CURTIS TALLEY,
WIND TURBINE TECHNICIAN



BOX	3Ø-ØØ1Ø31	NEEDLE NOSE PLIERS	SPRING-LOADED PLIER JAWS	12 PIECE BIT SET
BOX	3Ø-ØØ1179	NEEDLE NOSE PLIERS	SPRING-LOADED PLIER JAWS	BERRY SHEATH - BLACK 12 PIECE BIT SET

BLISTER	48239	NEEDLE NOSE PLIERS	SAFT.PLUS™ LOCKING KNIFE & TOOLS SHEATH
BOX	Ø8239	NEEDLE NOSE PLIERS	SAFT.PLUS™ LOCKING KNIFE & TOOLS SHEATH
BLISTER	Ø8239G1	NEEDLE NOSE PLIERS	SAFT.PLUS™ LOCKING KNIFE & TOOLS BERRY COMPLIANT SHEATH

NEW

SHORT STACK™ – AR-15 MAINTENANCE TOOL

The answer to your field cleaning and maintenance needs, this revolutionary three-piece design is magnetic, smartly designed, and able to fit snugly into Magpul MOE and MIAD pistol grips. Always on hand and the first of its kind, this tool is loaded with weapon-specific features.

OVERALL LENGTH: 2.9"
WEIGHT: 2.8 OZ

- Windage & elevation site adjustment tool
- Firing pin scraper
- Buffer tube wrench
- Cleaning cable pull through handle
- 4mm wrench
- T10 Torx
- #0 cross driver
- 1/8" hex
- Bolt carrier scraper
- 1/2" 3/8" & 3/4" wrench
- 7mm M-Lok wrench
- Fits inside Magpul, MOE & MIAD grips



"As with all Gerber products I own, this tool is awesome. It is a must have for any AR owner. Thanks Gerber I love it."

RICK CRAMER
★★★★★



BLISTER	31-002997	420HC TOOLS	MULTIPLE SCRAPING SURFACES
BOX	30-001113	420HC TOOLS	MULTIPLE SCRAPING SURFACES



CREW SERVED WEAPONS TOOL™

Compact and durable, the Crew Served Weapons Tool is the answer to the battlefield maintenance of the US Army's two most fielded automatic weapons' systems: The M249 Squad Automatic Weapon and M240 Crew Served Weapon. MOLLE-compatible sheath included.

OVERALL LENGTH: 3.8" X 1.3" X .96"
WEIGHT: 4.5 OZ

M240 Features

- Gas block:
 - barrel scraper
 - outer groove scraper
 - shoulder scraper
 - port punch
- Piston:
 - scraper

M249 Features

- Gas block:
 - removal tool
 - barrel scraper
 - shoulder scraper
 - inner groove scraper
 - outer groove scraper
 - port punch
- Piston:
 - inner cup scraper
 - outer groove scraper
- Gas tube:
 - inner groove scraper

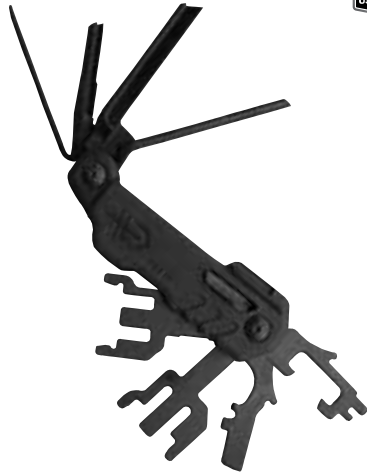

eFECT™ / eFECT™ II

The first of its kind, the eFECT weapons maintenance tool was created for the distinct purpose of cleaning and maintaining an AR15/M16/M4 variant firearm. With direct input from US military personnel, each component has been thoughtfully designed.

OVERALL LENGTH: eFECT: 8.0"
eFECT II: 5.7"
CLOSED LENGTH: 3.5"
WEIGHT: eFECT: 3.2 OZ
eFECT II: 5.4 OZ

eFECT

- Stainless steel - black
- Takedown punch
- Carbon scraper
- Front sight post adjuster
- Flat driver/scraper
- Interchangeable tool: OTIS™ nylon end brush
- Interchangeable Tool: OTIS™ curved pick

eFECT II

- Stainless steel - black
- Takedown pin punch
- M249 carbon scraper
- M4 / M16 bolt scraper
- Detachable dental style carbon pick
- Flat head driver



"I was given one of these to field test. Love it, worked on all of our weapon systems. Have to guard it though... the Infantry guys are always looking to steal it."

★★★★★

ERIC DAVIS, ARMY EOD



eFECT II



eFECT II sheath



eFECT sheath

BLISTER BOX	31-000049	eFECT MILITARY MAINTENANCE TOOL	SAF.T.PLUS™ LOCKING	SHEATH
BLISTER BOX	30-000030	eFECT MILITARY MAINTENANCE TOOL	SAF.T.PLUS™ LOCKING	BLACK BERRY SHEATH
BLISTER BOX	31-002782	eFECT II, AR-15 MAINTENANCE TOOL	SAF.T.PLUS™ LOCKING	TAN499 MOLLE-COMPATIBLE SHEATH
BLISTER BOX	30-001025	eFECT II, AR-15 MAINTENANCE TOOL	SAF.T.PLUS™ LOCKING	TAN499 MOLLE-COMPATIBLE SHEATH

BOX 30-000853 M240 & M249 AUTOMATIC WEAPONS TOOL MOLLE-COMPATIBLE BERRY SHEATH

CABLE DAWG™

Originally developed for US military communications personnel, this invaluable tool is a specialized, industrial-grade multi-tool for work on fiber optic, IT, and cable systems. Loaded with industry-specific features, the Cable Dawg will save you multiple trips to the toolbox.

OVERALL LENGTH: 7.5"
WEIGHT: 13.1 OZ

- Spring-loaded plier jaws
- Partially serrated blade w/ jacket cutter
- Wire cutter
- Wire stripper
- Cable cutter
- CAT5 jacket cutter
- RJ45 crimper head
- Detachable component handle
- Magnetic driver extension
- Multiple driver storage compartment

"Great tool! Used this downrange on deployments all over CENTCOM."

★★★★★

BRANDON, NAVY IT



BOX	30-000399	GLASS-FILLED NYLON MOLDED HANDLES	BLACK SHEATH
BOX	30-000397	GLASS-FILLED NYLON MOLDED HANDLES	COYOTE BROWN BERRY SHEATH
BOX	30-000398	GLASS-FILLED NYLON MOLDED HANDLES	MULTI-CAM BERRY SHEATH



CARBIDE CUTTER INSERT REPLACEMENTS™

Servicing a number of the Gerber multiplier platforms, these carbide cutter insert replacements are a lifesaver. Once you have used all three rotations of the current insert, replacement is a breeze with the T8 wrench, 4 replacement screws, and 2 included replacement blades.



BLISTER 48252 FOR MP6ØØ BASIC (SELECT MODELS ONLY), MP8ØØ LEGEND

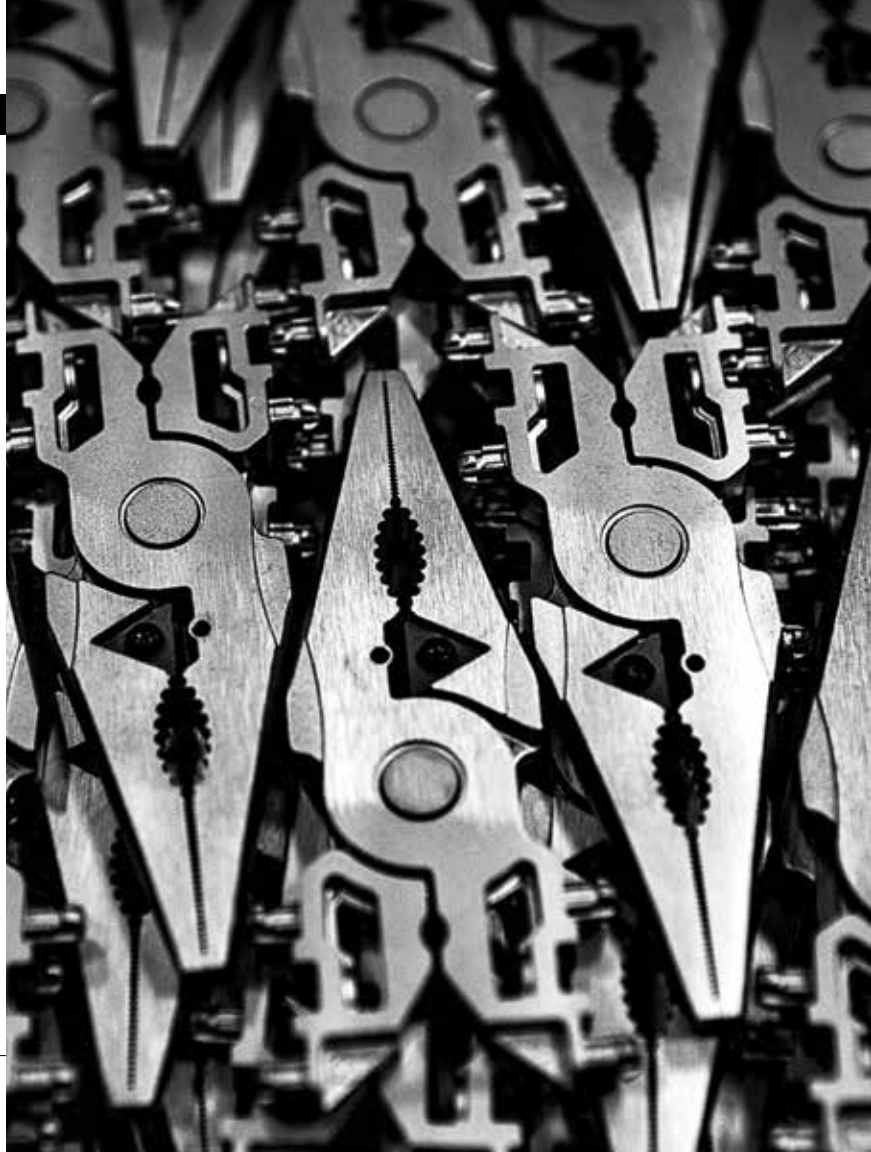

CORTEX™ FLASHLIGHT

Adaptability is a part of life for the modern tactical professional, every item must be worth its weight. The Cortex flashlight can utilize multiple power sources, running on 3 lithium CR123 or 2 AA batteries. With a max output of 675 lumens and a strobe option, you will never be in the dark.

OVERALL LENGTH:	6.2"
WEIGHT:	4.8 OZ
BATTERIES:	[3] LITHIUM CR123 OR [2] AA
MODES:	HIGH/LOW/STROBE

- LED [Cree XML]
- AA / Low: 28 lumens/15 hrs
- AA/ High: 390 lumens/1 hr
- CR123 / Low: 30 lumens/40 hrs
- CR123 / High: 675 lumens/1.75 hrs
- Water penetration rating: IPX7



CORTEX COMPACT™ FLASHLIGHT

Adaptability is a part of life for the modern tactical professional, every item must be worth its weight. This compact flashlight can utilize multiple power sources, running on 1 lithium CR123 or 1 AA battery. With a max output of 175 lumens and a strobe option, you will never be in the dark.

OVERALL LENGTH:	4.0"
WEIGHT:	2.1 OZ
BATTERIES:	[1] LITHIUM CR123 OR [1] AA
MODES:	HIGH/LOW/STROBE

- LED [Cree XPG]
- AA / Low: 30 lumens/4.5 hrs
- AA/ High: 150 lumens/.75 hr
- CR123 / Low: 30 lumens/9 hrs
- CR123 / High: 175 lumens/2 hrs



BLISTER BOX	31-001879 30-000821	WHITE LIGHT WHITE LIGHT	2-AA ALKALINE BATTERIES 2-AA ALKALINE BATTERIES	ALUMINUM ALUMINUM
-------------	------------------------	----------------------------	--	----------------------

BLISTER BOX	31-002308 30-000610	WHITE LIGHT WHITE LIGHT	1-AA ALKALINE BATTERY 1-AA ALKALINE BATTERY	ALUMINUM ALUMINUM
-------------	------------------------	----------------------------	--	----------------------

HFR-M™ LIGHT w/ HELMET MOUNT

The Hands Free Recon light has a thoughtfully efficient design, it can be mounted on helmet, MOLLE vest, table-top, or held in hand. With 4 color outputs (white, red, NVIS, IR) and light modes (low, medium, high, beacon) this versatile light is ideal for any situation.

OVERALL LENGTH: 2.9"
WEIGHT: W/ CR123 BATTERY: 3.9 OZ
W/ HELMET MOUNT: 5.0 OZ
W/ AA BATTERY: 4.2 OZ
BATTERIES: [1] AA OR [1] CR123
MODES: HIGH/LOW/STROBE

- Runtime: 6 hrs
- 59/100 lumen burst capability
- Reversible universal clip
- MOLLE mount
- Helmet mount
- 360° light articulation
- NVIS low detection by NVGs, & full color rendering for map reading



RECON-M II™

Engineered for the tactical enthusiast and soldier alike, the American made Recon series of products are efficient and versatile. Rugged yet lightweight, they are made of sturdy aluminum. Various lens and lumen options are available, depending on your needs.

OVERALL LENGTH: 5.75"
WEIGHT: 4.75 OZ
BATTERIES: [1] AA
MODES: ON/OFF

- LED [Cree XML]
- Recon-M II: White 55 lumens/5 hrs
- Recon-M II: Red 1 lumen/1 hr
- Recon-M II: NVIS 3.5 lumens/3.5 hrs
- Integrated lens filters change output color
- Pocket clip
- Recon-M II: Weatherproof
- Recon-M II: Aggressive knurling
- Recon-M II: Lanyard hole



BOX 30-000287 WHITE/RED/NVIS/IR LIGHT PARACORD ADAPTABLE 6 HOUR RUNTIME

BOX 22-80132 WHITE/RED/NVIS/IR LIGHT RECON-M II FLASHLIGHT REVERSIBLE MOLLE-COMPATIBLE CLIP

QUIET DEPLOY™

WITH VELCRO® BRAND TECHNOLOGY

GERBER'S QUIETEST SHEATH.

COVERT:

- + UNIDIRECTIONAL HOOKS FOR REDUCED AUDIBLE RESONANCE

DURABLE:

- + UNIFORM HOOK GEOMETRY FOR SLIDING DISENGAGEMENT & LASTING PERFORMANCE

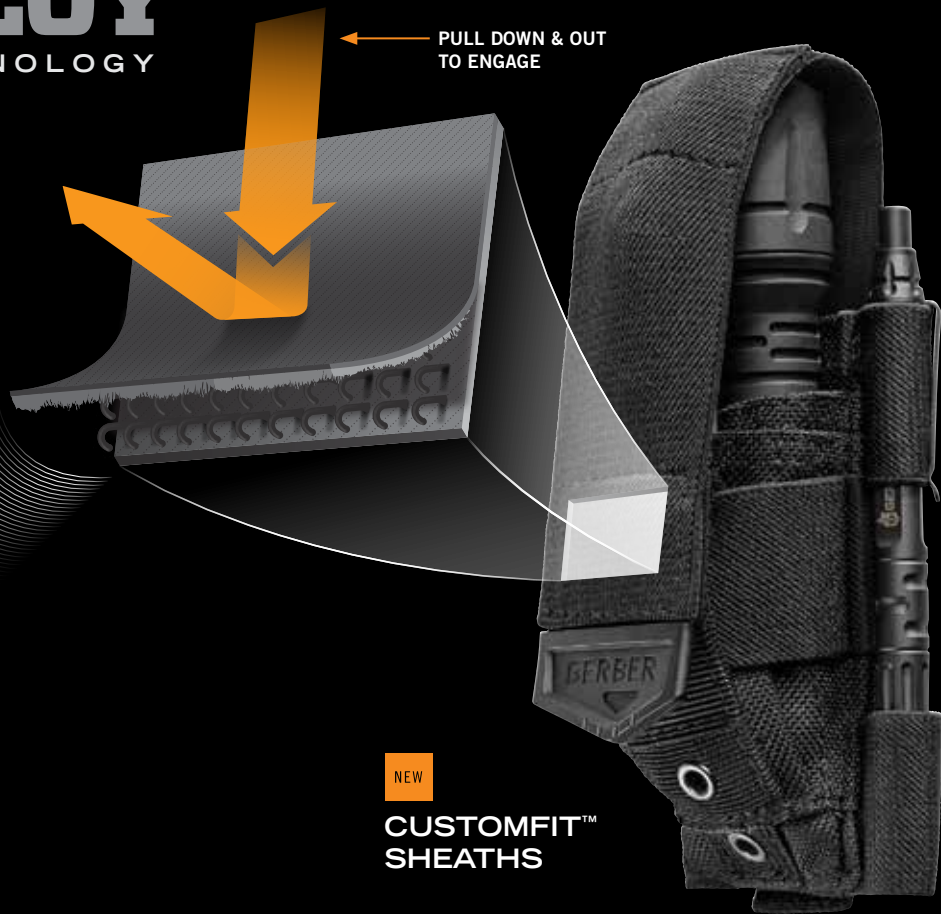

NEW

CUSTOMFIT™
SHEATHS

NEW

CUSTOMFIT™ SHEATHS

The CustomFit™ Dual Sheath is designed to create a custom fit for a wide array of product combinations including folding knives, multi-tools and hand-held flashlights. The patent-pending, richly featured sheath includes a quick access back panel that allows the user to customize the sheath to perfectly fit the tools selected for the task, job or mission of the day. Holding two items plus a pen, this sheath is easily customizable for any pairing of tools you need to take on the day. The Quiet Deploy™ technology allows the user to simply pull down the front tab for stealth-like access. With the CustomFit™ Dual Sheath, they'll never hear you coming.

The CustomFit™ Quad Sheath holds four items plus a pen.

QUIET DEPLOY™ TECHNOLOGY



CustomFit™ Dual Sheath



CustomFit™ Quad Sheath

- EASY ACCESS PANEL
- ONE-WRAP® FASTENER TOP STRAP
- QUIET DEPLOY™ W/VELCRO® BRAND PULL TAB
- SIDE TENSIONER STRAP
- 2-POSITION BELT CARRY
- TOP + BOTTOM SECURITY TABS ON BACK PANEL

BACKER CARD	30-001223	DUAL SHEATH	MOLLE COMPATIBLE	HOLDS 2 ITEMS + PEN
BACKER CARD	30-001222	DUAL SHEATH/BERRY COMPLIANT	MOLLE COMPATIBLE	HOLDS 2 ITEMS + PEN
BACKER CARD	30-001225	QUAD SHEATH	MOLLE COMPATIBLE	HOLDS 4 ITEMS + PEN
BACKER CARD	30-001224	QUAD SHEATH/BERRY COMPLIANT	MOLLE COMPATIBLE	HOLDS 2 ITEMS + PEN

DING DONG™

When ringing the doorbell isn't a reality but the need to get through a barrier is, the Ding Dong combines 3 essential breaching tools. Constructed of premium American materials and MOLLE compatible, this sledgehammer, battering ram, pry bar hybrid is all business.

OVERALL LENGTH: 27"
WEIGHT: 12.25 LBS

- Forged and machined head
- Forged pry bar end
- Molded fiberglass handle
- MOLLE-compatible carrying system w/ quick release strap



BOX 30-000790 STEEL + FIBERGLASS FORGED HEAD + PRY BAR MOLLE-COMPATIBLE SHEATH

ENGINEER'S KIT™

Thoughtfully designed with the most sensitive of combat situations in mind, this kit can be relied upon to be discreet, careful, and dependable. Includes a titanium shaft w/ 3 titanium probe tips, 3 nylon probe tips, a nylon handle, Recon M II flashlight, and Concertina Cutters.

OVERALL LENGTH: 9" X 5"
TOTAL WEIGHT: 2.7 LBS

- Mine probe system
- MP600 D.E.T.
- Recon-M II flashlight
- Concertina Cutter
- MOLLE-compatible, Berry sheath



BOX 30-000126 MINE PROBE SYSTEM COYOTE BROWN SHEATH MOLLE-COMPATIBLE BERRY SHEATH



GUN CLEANING KITS™

Each gun cleaning kit has been developed to cater to a specific gun, giving you every resource you need to clean and maintain your weapon at home or in the field. Each kit varies slightly in tools, but all are contained within a MOLLE-compatible sheath.

WEIGHT: M4 / M16 32.0 OZ
7.62MM RIFLE 22.4 OZ
5Ø CALIBER 24.8 OZ
SHOTGUN 22.2 OZ
9MM / .45 PISTOL 20.2 OZ
PISTOL / SMG 22.2 OZ
RIFLE / SHOTGUN / PISTOL 32.2 OZ

"Best all round cleaning kit in the world. I got mine from my son, he was issued one in Afgan. Little large for everyday carry, but stick this in your bag and you'll not use anything else. Extra room in case for some added items I wanted to carry too. Love this thing!"

★★★★★

VORNDAMR, RETIRED MILITARY



BOX	22-01100	M4 / M16 KIT	MOLLE-COMPATIBLE BERRY SHEATH
BOX	22-01101	7.62MM RIFLE KIT	MOLLE-COMPATIBLE BERRY SHEATH
BOX	22-01104	5Ø CALIBER KIT	MOLLE-COMPATIBLE BERRY SHEATH
BOX	22-01103	SHOTGUN KIT	MOLLE-COMPATIBLE BERRY SHEATH
BOX	22-01102	9MM / .45 PISTOL KIT	MOLLE-COMPATIBLE BERRY SHEATH
BOX	22-01106	PISTOL / SMG KIT	MOLLE-COMPATIBLE BERRY SHEATH
BOX	22-01105	RIFLE / SHOTGUN / PISTOL KIT	MOLLE-COMPATIBLE BERRY SHEATH

GUN CLEANING KIT CONTENTS

	M4 / M16 Kit 22-01100	7.62mm Rifle Kit 22-01101	50 Caliber Kit 22-01104	Shotgun Kit 22-01103	9mm & .45 Pistol Kit 22-01102	Pistol / SMG Kit 22-01106	Rifle / Shotgun / Pistol Kit 22-01105
Bore brushes	.22 caliber						X
	.30 caliber		X				X
	.35 caliber	X					
	.38 caliber						
	.38 caliber nylon					X	X
	.40 caliber				X		X
	.45 caliber		X			X	X
	.58 caliber			X			
	5.56 mm	X					
	12 gauge			X	X		X
	8" .50 caliber cable			X			
	40" .50 caliber cable			X			
Cables	12" pistol cable					X	X
	20" rifle cable					X	
	8" cable	X	X		X		
	8" cable w/ .30 caliber tip					X	X
	30" rifle cable	X	X		X		X
Slotted tips	5.56 mm	X					X
	.30 caliber	X	X		X	X	X
	Shotgun				X		X
	.50 caliber			X			
	MP600 Multi-Plier	X	X	X	X	X	X
	Red LED flashlight	X	X	X	X	X	X
	Bore reflector / flag safety	X	X	X	X	X	X
	CLP	X	X	X	X	X	X
	Solvent						X
	Panoply patches		X	X	X	X	X
Other components	5.56 patches	X					
	Patch saver				X		X
	Q-tips® cotton swabs	X					
	T-Handle & obstruction remover	X	X	X	X	X	X
	NATO adapter	X	X		X	X	X
	Shotgun brush adapter						X
	Female rod handle	X	X	X	X	X	X
	Male rod handle				X		
	Short A/P brush	X	X	X	X	X	X
	Nylon end brush	X	X	X	X	X	X
	Brass scraper	X	X	X	X	X	X
	Brass pick	X	X		X	X	X
	Pin punch					X	X
	Lens cleaner	X					
Mohair lens brush		X					

INDIVIDUAL DEPLOYMENT [ID] KITS™

This kit puts individual equipment close at hand in an easy to carry, MOLLE-compatible sheath. Made in America for the American soldier, this allows the user to maintain their weapon, keep a light source nearby, cut out of an emergency, and tackle any task needing a multi-tool.

SHEATH W/ COMPONENTS: 4" X 2" X 6"
WEIGHT: 24 OZ

- eFECT tool
- Recon-M II flashlight
- Needle nose MP6ØØ w/ carbide cutters
- MOLLE-compatible sheath w/ outboard strap cutter
- Sheath available in Coyote Brown or Multi-Cam

"Great Kit! This kit is truly a great piece of gear. All made in the USA; well thought out and designed. The flashlight has IR capability...Well done Gerber!"

★★★★★
INF82GRUNT



Coyote Brown



Multi-Cam



BOX	30-000366	COYOTE BROWN SHEATH	COYOTE BROWN STRAP CUTTER	MOLLE-COMPATIBLE BERRY SHEATH
BOX	30-000367	MULTI-CAM SHEATH	TAN STRAP CUTTER	MOLLE-COMPATIBLE BERRY SHEATH

INDIVIDUAL SURVEILLANCE KIT [ISK]™

Designed for Federal agencies, the Individual Surveillance Kit provides the operator with key implements for remote surveillance. The professional-grade equipment has been hand-picked to serve a very distinct purpose in the field, housed in a heavy-duty nylon bag.

DIMENSIONS: 7.1" X 29" X 4.3"
WEIGHT: 13 LBS

- Cable Dawg communications tool
- E-Tool folding shovel
- 9" hatchet
- Gator folding saw
- Cortex flashlight w/ [2] AA batteries
- MP6000
- Crisis Hook knife



MAINTENANCE KIT™

Teaming together the first-in-class MP6000 tool and the Firecracker LED flashlight, Gerber has enabled the user to maintain and illuminate no matter the time or conditions. The one-handed multi-plier in one hand, the flashlight in the other: unstoppable.

OVERALL LENGTH: 6.6"
WEIGHT: 13.8 OZ

- Fine edge blade
- Serrated blade
- Wire cutter
- Wire crimper
- Small, medium & large flat drivers
- Phillips driver
- RemGrit® saw
- File
- Ruler
- Bottle opener
- Can opener
- Key chain ring
- LED Flashlight

"I was given a slightly older version of this set and it was on my side my whole time in the Guard. It withstood any and all abuse I could through at it. I still have it today... A must for anyone who is wanting a great tool kit that wears easily. Thanks much!"

★★★★★

CORY, US COAST GUARD



BOX 30-001012 PROFESSIONAL-GRADE HEAVY DUTY STORAGE/CARRYING CASE

BLISTER 07570 NEEDLE NOSE PLIERS FIRECRACKER LED FLASHLIGHT BALLISTIC NYLON SHEATH

MINE PROBE KIT™

Probe shallow. Probe deep. Probe as conditions dictate with the Basic or Deluxe Mine Kit Probe Kit. Engineered from titanium and sensitive enough to transmit even the lightest contact, these kits are built to perform in the most sensitive of tasks.

WEIGHT: BASIC KIT: 13.6 OZ
DELUXE KIT: 22 OZ



- 3 nylon probe tips
- 3 titanium probe tips
- Titanium shaft
- Nylon handle
- Infinity Ultra task light [Deluxe kit only]
- MP6ØØ D.E.T. [Deluxe kit only]
- MOLLE & Berry-compatible black sheath



Deluxe Mine Probe Kit



OFF-ROAD / SURVIVAL / SUV KIT™

Meant to be kept in your vehicle, this kit equips the user with tough emergency tools that save the day. With a compact size it can be stored anywhere and easily accessed when the time comes, you don't want to be downrange or down the road without it.

CASE DIMENSIONS: 12" X 11" X 3"
WEIGHT: 194 OZ

- MP6ØØ
- E-Tool folding shovel
- 9" hatchet
- Exchange-A-Blade folding saw
- Cortex flashlight w/ [2] AA batteries
- Concertina wire cutter
- First Aid kit



BOX	Ø5984	BASIC MINE PROBE KIT			MOLLE-COMPATIBLE BERRY SHEATH
BOX	Ø5982	DELUXE MINE PROBE KIT	INFINITY ULTRA LIGHT	MP6ØØ D.E.T.	MOLLE-COMPATIBLE BERRY SHEATH

BOX	Ø5635	NEEDLE NOSE PLIERS	FIRST AID KIT	COMPACT DURABLE CASE
-----	-------	--------------------	---------------	----------------------

ENTRENCHING TOOL [E-TOOL]™ FOLDING SPADE

At only 2.3 pounds, this NATO approved entrenching tool folds up to be a portable powerhouse. With a glass-filled nylon handle, powder-coated boron carbon steel blade, and 7075 aluminum shaft it is as tough as you need.

OVERALL LENGTH:	23.4"
CLOSED LENGTH:	9.25"
WEIGHT:	37.3 OZ

- Lightweight
- NATO approved
- Glass-filled nylon handle
- Powder-coated boron carbon steel spade



E-Tool closed

ENTRENCHING TOOL [E-TOOL]™ w/ SHEATH

At only 2.3 pounds, this NATO approved entrenching tool folds up to be a portable powerhouse. With a glass-filled nylon handle, powder-coated boron carbon steel blade, and 7075 aluminum shaft it is as tough as you need. The foliage green sheath is H harness, web belt, and MOLLE compatible.

OVERALL LENGTH:	23.4"
CLOSED LENGTH:	9.4"
WEIGHT:	53 OZ

- Lightweight
- NATO approved
- Glass-filled nylon handle
- Powder-coated boron carbon steel spade
- H Harness, web belt & MOLLE-compatible sheath



E-Tool closed



E-Tool sheath



BOX 05942 NATO APPROVED GLASS-FILLED NYLON HANDLE

BOX 22-01062 H HARNESS, WEB BELT & MOLLE-COMPATIBLE SHEATH ANODIZED 7075 ALUMINUM SHAFT

ENTRENCHING TOOL [E-TOOL]™ w/ PICK

A military-grade digging tool, this powder-coated carbon steel shovel head is built for digging trenches and holes. With a serrated blade edge, anodized aluminum shaft, and glass-filled nylon handle this tool handles all types of difficult terrain. The head folds back to expose a handy and tough pick feature.

OVERALL LENGTH:	23.8"
CLOSED LENGTH:	9.25"
WEIGHT:	37.3 OZ

- Pick
- Lightweight
- NATO approved
- Glass-filled nylon handle
- Powder-coated boron carbon steel spade



E-Tool closed

BOX 22-01945 POWDER-COATED CARBON STEEL SHOVEL HEAD W/SERRATED BLADE PICK



IMPROMPTU PEN™

Developed in collaboration with law enforcement professionals, this American made pen is not your average writing implement. Sure, it takes notes - in the rain, snow, or otherwise. But it also has a tough machined steel body and integrated glass-breaker tip, just in case.

OVERALL LENGTH:	5.6"
DIAMETER:	Ø.5"
WEIGHT:	1.0 OZ

- Machined steel body
- Stainless steel pocket clip
- Carbide glass-breaker tip
- Push button pen
- Rite in the Rain® ink cartridge
- Black anodized

"In grease, rain and dirt, this thing has been consistent and reliable"



JAMES KENNY, OFFICER



BLISTER 31-001880 RITE IN THE RAIN® INK CARTRIDGE CARBIDE GLASS-BREAKER TIP



MINI PRY BAR™

Some breaching operations aren't planned. This compact pry bar is easily carried on your kit for the moment you need it. Virtually indestructible, the simple and purpose-driven design has a forged steel body and a glass-filled handle that is insulated up to 1,000 volts.

OVERALL LENGTH: 11"
WEIGHT: 7.4 OZ

- Forged steel pry bar
- Black oxide coating
- Insulated glass-filled nylon handle
- Paracord leash
- Finger guard & pommel lanyard holes



BOX 30-001057 FORGED STEEL INSULATED TO 1,000 VOLTS PARACORD LEASH BERRY

EQUIPMENT

PART #	NSN	DESCRIPTION
30-000074	5110-01-576-8918	Concertina Wire Cutter, Coyote Sheath
30-000126	5180-01-578-4886	Engineers Kit, Coyote Brown
22-01945	5120-01-530-9641	E-Tool, Entrenching Tool, Folding Spade, w/ Pick
22-01062	5120-01-580-7174	E-Tool, Entrenching Tool, Folding Spade, Plastic Foilage Green Sheath
05942	5120-01-476-7556	E-Tool, Entrenching Tool, Folding Spade, Without Sheath
30-000366	5180-01-598-2249	ID Kit - Individual Deployment Kit, Coyote Brown Sheath
30-000367	5180-01-598-2251	ID Kit - Individual Deployment Kit, Multi-Cam Sheath
07570	5110-01-462-3402	Maintenance Kit
05984	5180-01-516-3233	Mine Probe Kit, Basic
05982	5180-01-516-3229	Mine Probe Kit, Deluxe
05635	5180-01-457-5621	Off-Road Survival Kit
22-01104	5180-01-516-3224	Weapons Cleaning Kit - 50 Cal
22-01101	5180-01-516-3218	Weapons Cleaning Kit - 7.62mm
22-01103	5180-01-516-3222	Weapons Cleaning Kit - Combat Shotgun
22-01102	5180-01-516-3220	Weapons Cleaning Kit - Pistol/Subgun, 9mm
22-01106	5180-01-516-3227	Weapons Cleaning Kit - Rifle/Subgun, 9mm - 45mm
22-01100	5180-01-516-3219	Weapons Cleaning Kit - Rifle, 5.56
22-01105	5180-01-516-3225	Weapons Cleaning Kit - Rifle, Shotgun and Pistol

MULTI-TOOLS

PART #	NSN	DESCRIPTION
30-000398	5110-01-598-2248	Cable Dawg, Multi-Cam Sheath
30-000399	5110-01-598-2253	Cable Dawg, Black Sheath
30-000853	5110-01-641-4777	Crew Served Weapons [CSW] Tool
07400	5110-01-462-3400	D.E.T. Multi-Plier®, Needle Nose, Black
22-01545	5110-01-540-0186	Diesel Multi-Plier®, Needle Nose, Black
22-01470	5110-01-540-0152	Diesel Multi-Plier®, Needle Nose, Stainless
30-000030	5120-01-578-4888	eFECT Weapons Tool
07563	5110-01-451-4945	MP 600 - Pro-Scout Multi-Plier®, Needle Nose, Stainless
07510G	5110-01-385-7354	MP 600 - Blunt Nose Multi-Plier® Tool Kit, stainless
07520G1	5110-01-346-5341	MP 600 - Blunt Nose Multi-Plier®, Black
07500G	5110-01-346-5339	MP 600 - Blunt Nose Multi-Plier®, Stainless
07505G	5110-01-346-5340	MP 600 - Blunt Nose Multi-Plier®, Stainless
07564	5110-01-529-1631	MP 600 - Needle Nose Multi-Plier® Tool Kit, Stainless
07550G1	5110-01-394-6252	MP 600 - Needle Nose Multi-Plier®, Black
30-000314	5110-01-321-8805	MP 600 - Needle Nose Multi-Plier®, Black
30-000453	5110-01-592-2581	MP 600 - Needle Nose Multi-Plier®, Black, RFI Tool w/ Tan499 Sheath
05500	5110-01-462-3405	MP 400 - Needle Nose Multi-Plier®, Stainless
07530G	5110-01-394-6249	MP 600 - Needle Nose Multi-Plier®, Stainless
07535G	5110-01-394-6251	MP 600 - Needle Nose Multi-Plier®, Stainless
30-000513	5110-01-604-2057	MP 600-ST, Black, Tan499 Sheath
08239G1	5110-01-475-2144	MP 800 - Legend Multi-Plier®

KNIVES

PART #	NSN	DESCRIPTION
30-000193	5110-01-516-3243	06 Automatic G-10, Tanto, Black, Serrated
30-000462	1095-01-535-5724	06 Combat Folder, Drop Point, Fine Edge
30-000308	1095-01-535-5733	06 Combat Folder, Drop Point, Serrated
05785	5110-01-451-4943	Applegate-Fairbairn® Covert™, Folding
30-000137	5110-01-539-9990	Applegate-Fairbairn® Covert™, Folding, Automatic, Black Handle, Satin
05786	5110-01-516-3228	Applegate-Fairbairn® Covert™, Folding, Black
05780	5110-01-436-1548	Applegate-Fairbairn® Double Bevel, Folding, Black
22-01145DS	1095-01-466-8569	CFB - Combat Fixed Blade Knife, Tanto, Fixed Blade
30-000523	1095-01-431-3393	De Facto Fixed Blade, Tan499, Ceramic Coated
30-000190	1095-01-600-0972	DMF Automatic, Black, Tanto, G-10
22-07158	5110-01-516-3244	Emerson Alliance, Automatic, Black, Serrated
22-01648G	5110-01-452-2215	E-Z Out® DPSF - S30V Black
22-01643G	5110-01-451-0707	E-Z Out® DPSF - S30V Satin
06501	5110-01-414-4917	E-Z Out® Junior, Folding, Clip Point
06551	5110-01-414-4920	E-Z Out® Junior, Folding, Serrated
06971	5110-01-516-3237	E-Z Out® Rescue, Folding, Blunt Tip, Serrated, Yellow Handle
06701	5110-01-414-4918	E-Z Out® Skeleton, Folding, Clip Point
06751	5110-01-414-4916	E-Z Out® Skeleton, Folding, Serrated
06151	5110-01-385-7235	Gator Mate®, Folding, Serrated
06149	5110-01-385-7392	Gator Mate®, Folding, Clip Point
06069	5110-01-395-0291	Gator®, Folding, Clip Point
06079	5110-01-369-9340	Gator®, Folding, Serrated
22-01534	5110-01-574-0611	Hinderer Rescue™, Blunt Tip, Serrated
22-01627G	1095-01-552-5218	LMF II ASEK, Fixed Blade, Foilage Green
22-01400	7340-00-098-4327	LMF II Survival, Fixed Blade, Coyote Brown
30-000845	1095-01-598-4472	Propel AO - Assisted Opening, Black, S30V
30-000967	5110-01-438-9501	River Shorty, Black Handle, Serrated
30-000185	1095-01-600-0970	S.A.H. - Safety Auto Hook Knife, Black, Modified Drop Point Blade, Automatic Safety Hook
22-01944	5110-01-578-4890	Strap Cutter, Black
30-000132	5110-01-578-4889	Strap Cutter, Coyote Brown
22-01943	2590-01-576-2424	Strap Cutter, Foilage Green

LIGHTING

PART #	NSN	DESCRIPTION
30-000610	6230-01-503-9513	Cortex Compact Flashlight
30-000821	6230-01-574-2749	Cortex Flashlight
30-000287	6230-01-600-0971	HFR-M Flashlight
22-80132	6230-01-574-2739	Recon-M II Flashlight

QUIET DEPLOY™

WITH VELCRO® BRAND TECHNOLOGY

GERBER'S QUIETEST SHEATH.

COVERT:

+ UNIDIRECTIONAL HOOKS FOR REDUCED AUDIBLE RESONANCE

DURABLE:

+ UNIFORM HOOK GEOMETRY FOR SLIDING DISENGAGEMENT & LASTING PERFORMANCE

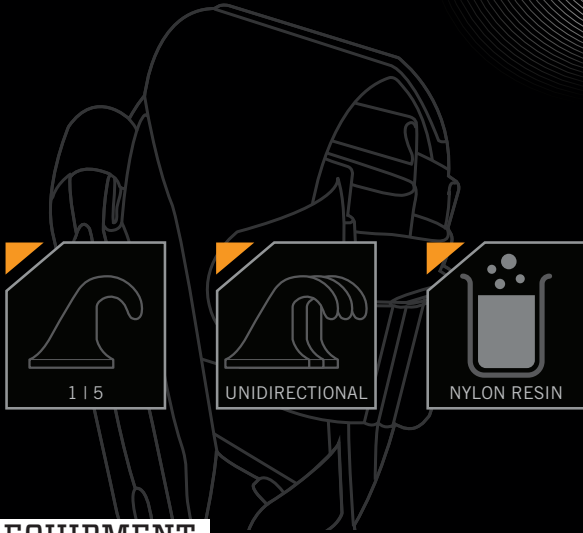
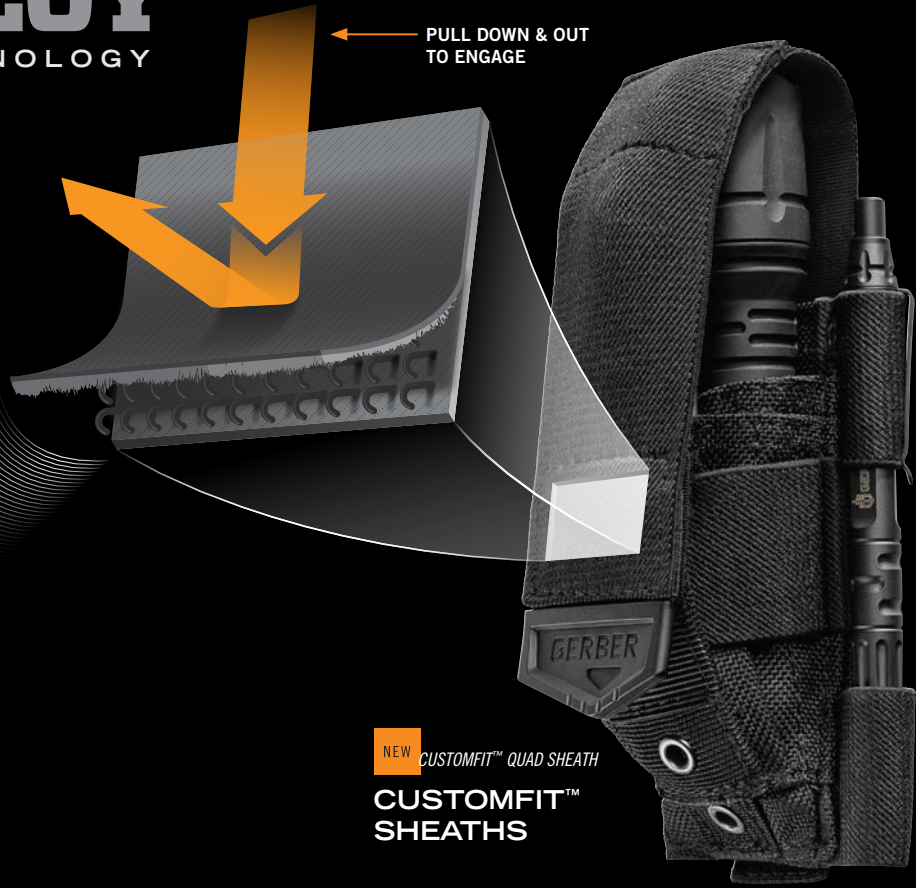

NEW CUSTOMFIT™ QUAD SHEATH

CUSTOMFIT™ SHEATHS

EQUIPMENT

NEW CUSTOMFIT™ SHEATHS



Dual Sheath

Quad Sheath

CARD 30-001223 DUAL/MOLLE-COMPATIBLE
 CARD 30-001222 DUAL/BERRY-COMPLIANT/MOLLE-COMPATIBLE
 CARD 30-001225 QUAD/MOLLE-COMPATIBLE
 CARD 30-001224 QUAD/BERRY-COMPLIANT/MOLLE-COMPATIBLE

ENTRENCHING TOOL [E-TOOL]™ FOLDING SPADE



Sheath, 22-01062 only

With pick, 22-01945 only

BOX 05942 NATO APPROVED 7075 ALUMINUM SHAFT
 BOX 22-01062 HARNESS, WEB BELT, MOLLE-COMPATIBLE
 BOX 22-01945 NATO APPROVED 7075 ALUMINUM SHAFT

FOLDING SPADE



BOX 30-000075 7075 ALUMINUM SHAFT

IMPROMPTU PEN™



BLISTER 31-001880 RITE IN THE RAIN® INK CARTRIDGE

MINI PRY BAR™



BOX 30-001057 FORGED STEEL INSULATED TO 1,000 VOLTS

DING DONG™



Molle-compatible Sheath

BOX 30-000790 STEEL+ FIBERGLASS FORGED HEAD/PRY BAR

MACHETES

NEW COMPACT CLEARPATH™



BLISTER 31-003154 CROSSCUT SAWTOOTH BLADE

NEW BROADCUT™



BLISTER 31-000758 SAFETY LANYARD

KNIVES

Ø6 COMBAT FOLDER™



BLISTER 30-000308 SERRATED/DROP POINT
 BOX 30-000462 FINE EDGE/DROP POINT

AIR RANGER™



BLISTER 31-002950 FINE EDGE/DROP POINT BLACK G-10
 BLISTER 45860 SERRATED/CLIP POINT

AR™ 3.Ø



BLISTER 45864 SERRATED/DROP POINT
 BOX 05849 SERRATED/DROP POINT
 BOX 05848 FINE EDGE/DROP POINT

BASIC™



BLISTER 31-000367 SERRATED/DROP POINT

E.A.B. [EXCHANGE-A-BLADE]™



BLISTER 22-41830 FINE EDGE/UTILITY BLADE

E.A.B. LITE™



BLISTER 31-000345 FINE EDGE/UTILITY BLADE

EDGE®



BLISTER 31-000669 BLUE TACHIDE™ HANDLE
 BLISTER 31-000668 BLACK TACHIDE™ HANDLE
 BLISTER 31-000666 BLACK ALUMINUM HANDLE

FULLBACK™



BLISTER 31-000311 FINE EDGE/DROP POINT

INSTANT™



BLISTER 31-002184 SERRATED/DROP POINT ASSISTED OPENING
 BOX 30-000752 SERRATED/DROP POINT ASSISTED OPENING

OBSIDIAN™



BLISTER 22-41021 FINE EDGE/DROP POINT
 BOX 22-01021 FINE EDGE/DROP POINT
 BLISTER 22-41022 SERRATED/DROP POINT

REMIX™



Tactical version

BLISTER 31-001098 SERRATED/TANTO TACTICAL
 BOX 30-000433 SERRATED/TANTO TACTICAL
 BLISTER 22-41968 FINE EDGE/DROP POINT
 BLISTER 22-41969 SERRATED/DROP POINT

MINI-REMIX™



BLISTER 31-000346 FINE EDGE/DROP POINT

LST™



BLISTER 46009 FINE EDGE/DROP POINT
 BOX 22-06009 FINE EDGE/DROP POINT
 BLISTER 46050 FINE EDGE/DROP POINT ULTRALIGHT LST
 BOX 22-06050 FINE EDGE/DROP POINT ULTRALIGHT LST

Ø6 F.A.S.T.™



BLISTER 31-000216 SERRATED/TANTO ASSISTED OPENING
 BOX 30-000118 SERRATED/TANTO ASSISTED OPENING

Ø6 AUTOMATIC™



BOX 30-000377 SERRATED/DROP POINT
 BOX 30-000850 SERRATED/TANTO
 BOX 30-000193 SERRATED/TANTO G-10

US1™



BLISTER 31-000340 FINE EDGE/DROP POINT

NEW

US-ASSIST™

The US-Assist. Designed and built in Portland, Oregon, this assisted-opening knife offers Gerber's smoothest, most consistent deployment to date. Including B.O.S.S. Tech™, it features a ball-bearing system to reduce friction & provide stable performance for the long haul. Intuitively designed and painstakingly tested, the US-Assist is the next generation of the everyday pocket knife.



BLADE LENGTH:	3.0"
OVERALL LENGTH:	7.2"
HANDLE:	GLASS-FILLED NYLON
BLADE:	S30V OR 420HC

"It opens really fast and smooth, every time."

ALICIA ELFVING, OREGON

B.O.S.S. TECH™ [Balls of Stainless Steel]

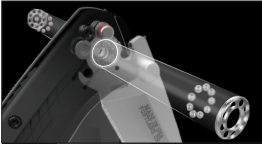

- BALL-BEARING DEPLOYMENT SYSTEM
- PLUNGE LOCK CROSSBOLT SYSTEM
- DUAL RAMPED THUMBSTUDS
- SCRATCH-RESISTANT CLIP

BOX	30-001205	FINE EDGE	S30V BLADE	PLUNGE LOCK	DUAL THUMBSTUDS	POCKET CLIP
BOX	30-001206	FINE EDGE	420HC BLADE	PLUNGE LOCK	DUAL THUMBSTUDS	POCKET CLIP
BLISTER	31-003105	FINE EDGE	420HC BLADE	PLUNGE LOCK	DUAL THUMBSTUDS	POCKET CLIP
BOX	30-001294	SERRATED	420HC BLADE	PLUNGE LOCK	DUAL THUMBSTUDS	POCKET CLIP
BLISTER	31-003240	SERRATED	420HC BLADE	PLUNGE LOCK	DUAL THUMBSTUDS	POCKET CLIP

NEW

CENTER-DRIVE™

The Center-Drive. Gerber's new multi-tool that offers uncompromising performance through revolutionary design. The innovative center-axis driver opens to align like a real screw driver, yielding maximum torque and rotation. No productivity is sacrificed with the addition of a 30% longer outboard blade and one-thumb opening sliding jaws. Full size, real tools - the multi-tool just got a reality check.



CLOSED LENGTH:	4.7"
OPEN LENGTH:	6.6"
WEIGHT:	9.5 OZ

"Everything I need, and none of the crap I don't."

- SHAWN, OMAHA, NE

CENTER AXIS TECH™



- ONE-THUMB OPENING SYSTEM
- SPRING-LOADED PLIERS
- CENTER AXIS DRIVER
- FULL SIZE FINE EDGE BLADE
- SHEATH INCLUDED



BOX	30-001193	ROTATABLE CARBIDE WIRE CUTTERS + STRIPPERS	PRY BAR, NAIL PULLER + BOTTLE OPENER	SHEATH
BLISTER	31-003073	ROTATABLE CARBIDE WIRE CUTTERS + STRIPPERS	PRY BAR, NAIL PULLER + BOTTLE OPENER	SHEATH
BOX	30-001194	ROTATABLE CARBIDE WIRE CUTTERS + STRIPPERS	PRY BAR, NAIL PULLER + BOTTLE OPENER	BITSET + SHEATH
BLISTER	31-003074	ROTATABLE CARBIDE WIRE CUTTERS + STRIPPERS	PRY BAR, NAIL PULLER + BOTTLE OPENER	BITSET + SHEATH
BOX	30-001195	ROTATABLE CARBIDE WIRE CUTTERS + STRIPPERS	PRY BAR, NAIL PULLER + BOTTLE OPENER	MOLLE SHEATH
BLISTER	31-003075	ROTATABLE CARBIDE WIRE CUTTERS + STRIPPERS	PRY BAR, NAIL PULLER + BOTTLE OPENER	MOLLE SHEATH
BOX	30-001196	ROTATABLE CARBIDE WIRE CUTTERS + STRIPPERS	PRY BAR, NAIL PULLER + BOTTLE OPENER	BITSET + MOLLE SHEATH
BLISTER	31-003076	ROTATABLE CARBIDE WIRE CUTTERS + STRIPPERS	PRY BAR, NAIL PULLER + BOTTLE OPENER	BITSET + MOLLE SHEATH

Products shown are not to scale.

GDC [GERBER DAILY CARRY]

GDC HOOK KNIFE™



BLISTER 31-001695 FINE EDGE

GDC MONEY CLIP™



BLISTER 31-002521 FINE EDGE
BOX 30-000883 FINE EDGE

GDC TECH SKIN™ POCKET KNIFE



BLISTER 31-001693 FINE EDGE/DROP POINT
BOX 30-000636 FINE EDGE/DROP POINT

GDC – ZIP BLADE™ / ZIP LIGHT™



BLISTER 31-001742 GDC ZIP BLADE
BLISTER 31-001745 GDC ZIP LIGHT

MULTI-TOOLS

CABLE DAWG™



BOX 30-000399 BLACK SHEATH
BOX 30-000397 COYOTE BROWN SHEATH
BOX 30-000398 MULTI-CAM SHEATH

DIESEL™



BLISTER 22-41545 NEEDLE NOSE BLACK
BOX 22-01545 NEEDLE NOSE BLACK
BLISTER 22-41470 NEEDLE NOSE STAINLESS
BOX 22-01470 NEEDLE NOSE STAINLESS

22-41470 / 22-01470
Stainless

DIME™



BLISTER 31-002937 PURPLE RETAIL PACKAGE OPENER
BLISTER 31-001040 RED RETAIL PACKAGE OPENER
BOX 30-000417 RED RETAIL PACKAGE OPENER
BLISTER 31-001132 GREEN RETAIL PACKAGE OPENER
BLISTER 31-001134 BLACK RETAIL PACKAGE OPENER
BOX 30-000469 BLACK RETAIL PACKAGE OPENER
BLISTER 31-001023 BLACK BLADELESS
BOX 30-002777 BLACK BLADELESS

Bladeless

MP1™



BLISTER 31-001142 NEEDLE NOSE
BOX 30-000477 NEEDLE NOSE

MP400™ COMPACT SPORT



BLISTER 45509 NEEDLE NOSE BLACK
BOX 05509 NEEDLE NOSE BLACK
BLISTER 45500 NEEDLE NOSE STAINLESS
BOX 05500 NEEDLE NOSE STAINLESS

45500 / 05500
Stainless

MP600™ BASIC



BLISTER 47530 NEEDLE NOSE STAINLESS
BOX 07530 NEEDLE NOSE STAINLESS
BLISTER 47550 NEEDLE NOSE BLACK
BOX 07550 BLUNT NOSE STAINLESS

47550 / 07550
Black

MP600™ CARBIDE

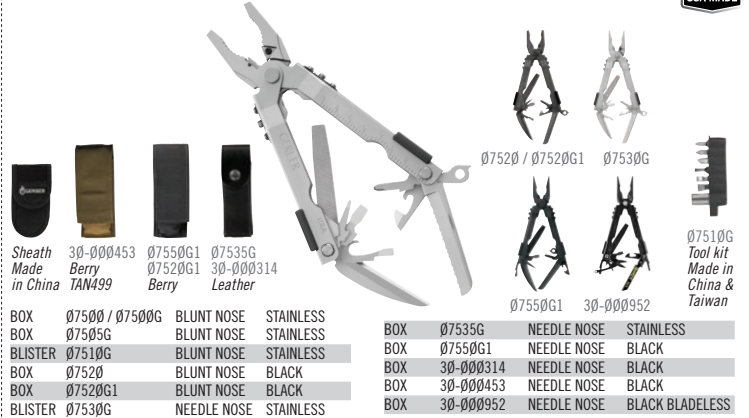

Sheath Made in China
30-000453 Berry TAIN499
07550G1 Berry
07535G 30-000314 Leather

BOX 07500 / 07500G BLUNT NOSE STAINLESS
BOX 07505G BLUNT NOSE STAINLESS
BLISTER 07510G BLUNT NOSE STAINLESS
BOX 07520 BLUNT NOSE BLACK
BOX 07520G1 BLUNT NOSE BLACK
BLISTER 07530G NEEDLE NOSE STAINLESS

07520 / 07520G1 07530G

07550G1 30-000952

07510G Tool kit Made in China & Taiwan

BOX 07535G NEEDLE NOSE STAINLESS
BOX 07550G1 NEEDLE NOSE BLACK
BOX 30-000314 NEEDLE NOSE BLACK
BOX 30-000453 NEEDLE NOSE BLACK
BOX 30-000952 NEEDLE NOSE BLACK BLADELESS

MP600 PRO SCOUT™



BLISTER 47563 NEEDLE NOSE STAINLESS
BOX 07563 NEEDLE NOSE STAINLESS
BOX 07564 NEEDLE NOSE STAINLESS W/ TOOLKIT

Sheath Made in China

07564 Tool Kit

MP600-ST™ [SIGHT TOOL]



BLISTER 47563 NEEDLE NOSE STAINLESS
BOX 07563 NEEDLE NOSE STAINLESS
BOX 07564 NEEDLE NOSE STAINLESS W/ TOOLKIT

Sheath Made in China

LEGEND MP800™



BLISTER 48239 NEEDLE NOSE
BOX 08239 NEEDLE NOSE
BLISTER 08239G1 NEEDLE NOSE BERRY SHEATH

SUSPENSION™



BLISTER 22-41471 NEEDLE NOSE STAINLESS TI-NITRIDE
BOX 22-01471 NEEDLE NOSE STAINLESS TI-NITRIDE

WISE POCKET TOOL™



BLISTER 31-000021 NEEDLE NOSE PLIERS BLACK

VITAL™ POCKET FOLDER

Featuring one of the safest Exchange-A-Blade options out there, a surgically sharp blade cuts through game easily, requiring no extra tool if you need to replace the blade on the fly. The orange handle is easily spotted and a large finger choil adds stability.



"Took two nice deer this evening, a buck and a doe and used one Vital #60 blade to skin and quarter both deer, when we finished the blade was still sharp, highly satisfied with this product and recommend this knife to everyone."

★★★★★

WASEY HARRISON, Mississippi

BLISTER 31-002736 FINE EDGE/DROP POINT

VITAL™ FIXED BLADE



Sheath + Replacement Blades

BLISTER 31-003006 FINE EDGE/EXCHANGE-A-BLADE

VITAL™ TAKE-A-PART SHEARS



BLISTER 31-002747 FINE EDGE

VITAL™ PACK SAW



BLISTER 31-002742 BONE SAW

VITAL™ ZIP



Sheath + Replacement Blades

BLISTER 31-002745 STANDARD UTILITY DROP POINT

VITAL™ SKIN AND GUT KNIFE



BLISTER 31-002743 FINE EDGE /GUT KNIFE

VITAL™ REPLACEMENT BLADES



BLISTER 31-002739 #60 RAZOR 420HC

GATOR® SERIES

NEW GATOR® PREMIUM

The elevated, first-class reincarnation of the original, this knife offers American-made excellence with premium materials. The full tang S30V steel blade will last generations, an upgraded Gator Grip handle and steel bolsters give ultimate control.



"I just got this in the mail and it is a great knife. It feels solid, like you can really put it to use, and the gator skin is like nothing I've seen. Very well done Gerber."

★★★★★
KEITH, HUNTER



Leather Sheath

BOX 30-001085 FINE EDGE/CLIP POINT FOLDING
BOX 30-001086 FINE EDGE/GUT HOOK FOLDING

NEW GATOR® PREMIUM FIXED

The elevated, first-class reincarnation of the original, this knife offers American-made excellence with premium materials. The full tang S30V steel blade will last generations, an upgraded Gator Grip handle and steel bolsters give ultimate control.



Leather Sheath

BOX 30-001083 FINE EDGE/DROP POINT FIXED BLADE
BOX 30-001082 FINE EDGE/GUT HOOK FIXED BLADE

GATOR® FOLDING



Sheath made in China



BOX 06064 FINE EDGE/DROP POINT
BLISTER 46079 SERRATED/CLIP POINT
BOX 06079 SERRATED/CLIP POINT
BLISTER 46932 FINE EDGE/GUT HOOK
BOX 06932 FINE EDGE/GUT HOOK
BLISTER 46069 FINE EDGE/CLIP POINT
BOX 06069 FINE EDGE/CLIP POINT

GATOR® FIXED



Sheath made in China



BLISTER 46906 FINE EDGE/GUT HOOK
BOX 06906 FINE EDGE/GUT HOOK
BLISTER 46904 FINE EDGE/DROP POINT
BOX 06904 FINE EDGE/DROP POINT

GATOR® FILLET



BLISTER 75230 FINE EDGE / 6" FIXED BLADE
BLISTER 75231 FINE EDGE / 7" FIXED BLADE



GATOR® II w/ E-Z GUT HOOK



Sheath made in China



E-Z Gut Hook

BLISTER 22-41417 SERRATED/DROP POINT FOLDING

GATORMATE®



Sheath made in China



BOX 06149 FINE EDGE/CLIP POINT FOLDING

GATOR® EXCHANGE-A-BLADE SAW



BLISTER 22-41457 COARSE/WOOD & FINE/BONE

GATOR® SAW I



BLISTER 22-49472 COARSE + FINE BLADES



GATOR® SAW III



Sheath + Blades

BLISTER 22-41514 FINE, COARSE + CHAIN SAW

GATOR® BRUSH THINNER



BLISTER 31-000083 FINE EDGE



GATOR® COMBO AXE



BLISTER 31-001054 FINE EDGE



GATOR® COMBO AXE II



BLISTER 22-41420 FINE EDGE/SERRATED



SPAN TOOLS

NEW SPAN ARCHERY SOLID STATE TOOL™

Proudly built in America, this revolutionary tool offers 19 different functions on one solid state structure. Providing bow-hunting enthusiasts with essential repair and maintenance tools, this portable workhorse is endlessly customizable to fit your needs in the field.



BLISTER 31-002944 CAST ALUMINUM W/ TPR MOLDED GRIP HANDLE

NEW SPAN SHOTGUN SOLID STATE TOOL™

Proudly built in America, this revolutionary tool offers 14 different functions on one solid state structure. Providing shotgun-hunting enthusiasts with essential repair and maintenance tools, this portable workhorse is endlessly customizable to fit your needs in the field.



BLISTER 31-002945 CAST ALUMINUM W/ TPR MOLDED GRIP HANDLE

MOMENT SERIES

MOMENT™



BLISTER 31-002212 FINE EDGE/GUT HOOK FOLDING
BLISTER 31-002209 FINE EDGE/DROP POINT FOLDING

MOMENT™ FIXED



BLISTER 31-002197 FINE EDGE/DROP POINT FIXED BLADE
BLISTER 31-002200 FINE EDGE/GUT HOOK FIXED BLADE

MOMENT™ POCKET FOLDER



BLISTER 31-002215 FINE EDGE/DROP POINT FOLDING

MOMENT™ FIELD DRESS KIT



BLISTER 31-002218

MOMENT™ FIELD DRESS KIT II



BLISTER 31-002680

MOMENT™ FIELD DRESS KIT III



BLISTER 31-002683I

MOMENT™ FIELD DRESS KIT IV



BLISTER 31-002686

MOMENT™ FIXED BLADE SAW



BLISTER 31-002751 SERRATED SHEATH INCLUDED

Products shown are not to scale.

MYTH SERIES

MYTH® FOLDER



BLISTER 31-001164 FINE EDGE/DROP POINT FOLDING
 BLISTER 31-001160 FINE EDGE/GUT HOOK FOLDING

MYTH® POCKET FOLDER



BLISTER 31-001088 FINE EDGE/DROP POINT FOLDING

MYTH® FIXED BLADE PRO



BLISTER 31-001092 FINE EDGE/DROP POINT FIXED BLADE
 BLISTER 31-001095 FINE EDGE/GUT HOOK FIXED BLADE

MYTH® COMPACT FIXED BLADE



BLISTER 31-001156 FINE EDGE/DROP POINT FIXED BLADE

MYTH® FIELD DRESS KIT



BLISTER 31-001159 FINE EDGE/GUT HOOK + DROP POINT

MYTH® E-Z OPEN



BLISTER 31-001168 FINE EDGE FIXED BLADE

MYTH® FOLDING SAW



BLISTER 31-001167 DUAL EDGE [FINE + COARSE] BLADE

MYTH® FIXED BLADE SAW



BLISTER 31-002094 SERRATED SHEATH INCLUDED

MYTH® HATCHET



BLISTER 31-002698 FINE EDGE

MYTH® FOLDING LOPPER



BLISTER 31-002699 FINE EDGE

MYTH® RATCHETING PRUNER



BLISTER 31-002749 FINE EDGE

MYTH® FIELD SHARPENER



BLISTER 31-001526

MYTH® BLOOD TRACKING LIGHT



BLISTER 31-001863 BLUE/RED/GRAY LIGHT 4-AA

MYTH® FLASHLIGHT



BLISTER 31-002998 WHITE LIGHT 4-AA

MYTH® SPOTLIGHT



Red + Green Lenses

BLISTER 31-001857 WHITE LIGHT

Products shown are not to scale.

Check out the collection of camo gear we offer.