



VGA RESOLUTION ARTICULATING PROBE



**P16HPART
P16HP2ART
P16HP3ART**

Please read this manual carefully and thoroughly before using this product.

TABLE OF CONTENTS

Introduction	2 – 3
Key Features	3
Safety Instruction	4
What's in the Case	4
Product Overview	4
Setup Instructions	5
Attach To Borescope	5
Operating Instructions	5 – 9
Using the Three Control Buttons	6 – 7
Attaching the Mirrored Viewing Tip (Optional)	7 – 8
Using the Holding Tube (Optional)	8 – 9
Specifications	9 – 10
Operating & Maintenance Tips	10 – 11

INTRODUCTION

Thank you for purchasing General Tools & Instruments' (General's) P16HPART, P16HP2ART or P16HP3ART VGA Resolution Articulating Probe. Please read this manual carefully and thoroughly before using the probe.

The P16HPART is the 1-meter long version of a high-performance, soft metal, camera-tipped articulating probe that captures video and still images at VGA (640 x 480 pixel) resolution. The P16HP2ART and P16HP3ART are the 2-meter and 3-meter long versions of the P16HPART. This manual uses the term P16HPART to refer to all three versions.

The P16HPART's five super-bright LEDs make it particularly suitable for inspecting dark environments and viewing parts and structures within them. The articulation function is provided by a wheel on the probe controller for remotely adjusting the angle of the probe tip while it is within a tight space in order to inspect targets outside the camera's nominal field of view.

The probe is compatible with:

- General's DCS1600, DCS1600ART, DCS1800, DCS1700, DCS800 and DCS2000 High-Performance Recording Video Borescope Inspection Systems
- H16, H8 and H17 Handheld Recording Consoles (the DCS1600, DCS800 and DCS1700 Systems without a probe)
- The DCS1800-TR Transmitting Probe Handle/Controller, which enables video and images captured by the probe to be viewed on the console of a DCS1800ART system

KEY FEATURES

- Five super-bright white LEDs (three forward-facing and two side-facing) support capture of 640 x 480 pixel (VGA) resolution video and still images
- 0.23 in. (6mm) diameter probe goes deep into tight spaces
- P16HPART probe articulates 155° up and 155° down ($\pm 155^\circ$); P16HP2ART and P16HP3ART articulate $\pm 145^\circ \pm 135^\circ$, respectively
- Light boost, anti-reflection and 90° image rotation buttons on probe controller
- Superior optics tailored for close-focus viewing from 0.4 in. to 12 in. (10 to 300mm) over 87° (diagonal) field of view
- 0.9 in. (23mm) long stainless steel camera head is immune to bathroom toilet cleaner, unleaded gasoline, diesel fuel, brake/transmission fluid and machine oil
- Probe is waterproof to IP67 standard
- Includes 70° mirrored viewing tip and a holding tube that effectively converts the soft metal probe to a rigid probe of 990mm length and 12mm diameter

SAFETY INSTRUCTION

CAUTION! Do not use the P16HPART to inspect ducts or areas known or suspected to contain live electric wiring

WHAT'S IN THE CASE

The VGA Resolution Articulating Probe comes in a hard plastic case inside a cardboard box along with a 70° mirrored viewing tip, a disassembled 990mm long holding tube and this user's manual.

PRODUCT OVERVIEW

Fig. 1 shows the controls and key structures of the P16HPART. Familiarize yourself with their names and functions before moving on to the Setup Instructions and Operating Instructions.

Fig. 1. The controls and key structures of the P16HPART

1. Soft metal probe
2. Flexible-obedient, remote-controlled neck
3. Stainless steel camera head with three forward-facing LEDs and two side-facing LEDs
4. Stainless steel accessory alignment ring
5. Black metal thread protector ring
6. Red rubber protective cap
7. Probe controller body
8. Articulation angle control wheel with locking lever
9. Light boost button
10. 90° rotation button
11. Anti-reflection button
12. Button lock switch
13. Probe connector cable
14. Probe connector

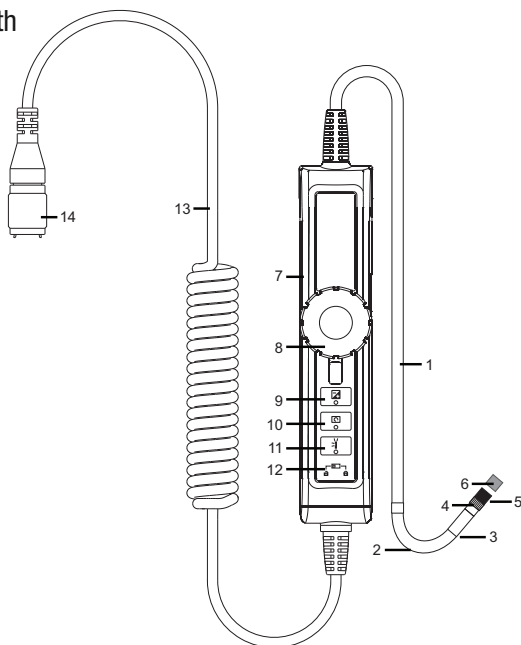

SETUP INSTRUCTIONS

ATTACH TO BORESCOPE

To attach the probe to a borescope console or to the DCS1800-TR handle/controller, retract the metal collar of the Probe connector (Fig. 1, Callout 14) to expose the alignment key, which is marked by a dot. Keeping the collar pulled back, align this dot with the dot on the connector of your borescope console or handle/ controller and push the two connectors together. To secure the connection, push the collar forward and turn it clockwise until tight.

OPERATING INSTRUCTIONS

For general guidelines on using the probe as an inspection tool, refer to the Operating Instructions section of the user's manual for your borescope or borescope console. Also see the Operating & Maintenance Tips section of this manual beginning on p. 10.

Before attempting to articulate the probe, make sure that the lever below the articulation angle control wheel (Fig. 1, Callout 8) is pointing downward.

To bend the probe neck (Fig. 1, Callout 2) **and tip** to the left, turn the wheel clockwise. To bend the probe neck and tip to the right, turn the wheel counterclockwise. **To lock the wheel and the probe's articulation angle**, move the lever below the wheel to the left (see figure above).

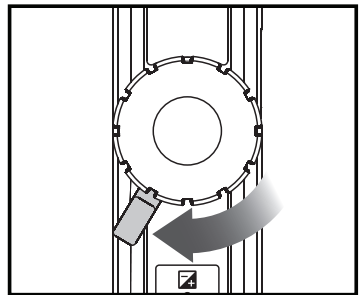

To adjust the intensity of the LEDs at the tip of the P16HPART, roll the thumbwheel on your borescope, borescope console or probe handle/controller forward or back.

Remember to remove the red rubber protective cap from the tip of the probe before using it.

USING THE THREE CONTROL BUTTONS

To boost the intensity of the three LEDs normally providing camera lighting, press the  button. Doing so lights a red LED behind the button and increases the brightness of video and images, as shown below.



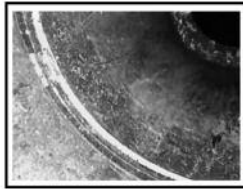

BEFORE BOOST



AFTER BOOST

This feature can help you cope with very low-light conditions. When recording with the boost feature activated, you must hold the probe very steady or your videos and images will be blurred.

To rotate the probe's field of view, use the  button. Pressing the button once backlights the button red and rotates the frame clockwise by 90°. Pressing it a second time rotates the frame by an additional 90°, in effect turning the original view upside-down. Pressing the  button a third time rotates the field of view yet another 90°. Pressing the button a fourth time restores the original view and extinguishes the red button backlight.

To remove glare, reflections or spots from the field of view, use the  button. Pressing the button adds a red backlight to it, just like the other two buttons on the VGA Resolution Articulating Probe controller.

This anti-reflection feature of the P16HPART is most useful for eliminating reflections of the three forward-facing LEDs in the camera head from shiny surfaces. Note that pushing the  button extinguishes the three forward-facing LEDs and shifts responsibility for camera lighting to the two side-facing LEDs. The net effect, as shown below, is a clearer and more-readable image.



WITHOUT ANTI-REFLECTION



WITH ANTI-REFLECTION

You can also use the anti-reflection function to remove glare created by the P16HPART's mirrored viewing tip (see the next section of this manual for installation and alignment instructions). The pair of images below illustrates the net positive effect.

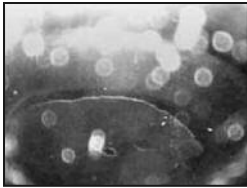

**MIRRORED VIEW
WITHOUT ANTI-REFLECTION**

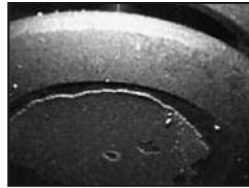

**MIRRORED VIEW
WITH ANTI-REFLECTION**

ATTACHING THE MIRRORED VIEWING TIP (OPTIONAL)

The P16HPART comes with a 70° mirrored viewing tip. To attach it to the probe:

1. Pull off the red rubber protective cap (Fig. 1, Callout 6).

2. Unscrew and remove the black metal thread protector ring (Callout 5), as shown at right.

3. Turn the stainless steel accessory alignment ring (Callout 4) clockwise to move it away from the probe tip. Keep turning until the ring can travel no further.

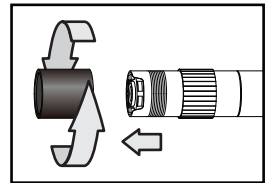

4. Screw the mirrored viewing tip onto the camera head (Callout 3) by turning it clockwise, as shown at right. Keep turning until the viewing tip is as far from the probe tip as possible. In this position, it can rotate freely.

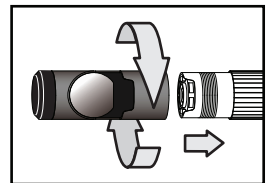

5. Press the  button to activate the two-side facing LEDs.

6. Slowly turn the mirrored viewing tip counterclockwise to move it toward the probe tip. Once the threads of the tip grip the camera head, continue turning only until the two LEDs are clearly visible through the gap in the tip's housing.

7. Secure the tip with the thumb and forefinger of one hand and use your other hand to turn the alignment ring clockwise. Keep turning the ring until its leading edge contacts the mirrored viewing tip, locking it in place. The

pair of figures below illustrate the incorrect (left) and correct (right) orientation of the mirror with respect to the LEDs.

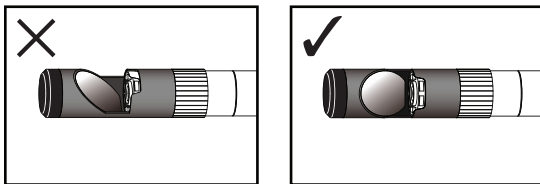

Remove the blue circular protective film from the mirror by pulling on its tab with a tweezers.

USING THE HOLDING TUBE (OPTIONAL)

Each of the three soft metal VGA articulating probes comes with a steel holding tube that effectively converts it to a rigid probe of 990mm length and 12mm diameter (the length and outer diameter of the tube). Use the holding tube whenever you need to inspect an area above your head (the top of a structure, for example) or below your knees, or any area that you cannot get closer to horizontally than 1 m away.

To assemble the holding tube, first screw the threaded end of the tube section with the handle and locking collar (the 540mm section shown in the top photo below) into one side of the 21mm long threaded coupling. Then screw the threaded end of the shorter (450mm long) section into the other side of the coupling (middle photo) to create a 990mm long hollow tube (bottom photo) with a mechanism to lock a probe inside it.



To insert the probe into the holding tube:

1. Make sure the lever

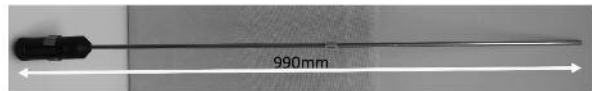

below the articulation angle control wheel (Fig. 1, Callout 8) on the probe controller is pointing downward (the unlocked position).

2. Rotate the wheel to straighten the probe tip (set the articulation angle to 0°).
3. Lock the tip in place by moving the lever to the left.
4. Make sure the locking collar on the tube handle is in the unlocked position (see left photo at right).
5. Feed the probe—articulating tip first—through the bottom of the tube handle until the probe's camera head and articulation mechanism extend just past the end of the tube (see drawing at right).
6. Lock the probe in place by moving the collar to the locked position (see right photo above)



UNLOCKED



LOCKED

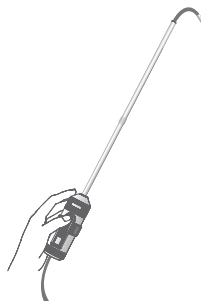

SPECIFICATIONS

Probe Type	Soft metal
Probe Length/Articulation Angle	P16HPART: 1m (3.3 ft.)/ $\pm 155^\circ$ P16HP2ART: 2m (6.6 ft.)/ $\pm 145^\circ$ P16HP3ART: 3m (9.8 ft.)/ $\pm 135^\circ$
Camera Head Diameter, Type	0.23 in. (6mm), Stainless steel
Camera Head Diameter with Thread Protector	0.26 in. (6.5mm)
Camera Head Length	0.9 in. (23mm)
Camera Resolution	VGA (640 x 480 pixels)
Camera Depth of Field	0.25 to 12 in. (6.4 to 300mm)
Camera Field of View	87° (diagonal)
Camera Lighting	3 forward-facing LEDs + 2 side-facing LEDs

Operating Temperature	-4° to 140°F (-20° to 60°C)
Dimensions of Probe Controller	5.47 x 1.38 x 1.26 in. (139 x 35 x 32mm)
Weight of Controller	7.76 oz. (220g)

OPERATING & MAINTENANCE TIPS

The probe is flexible to make it easy for you to inspect hard-to-reach areas. Never insert or bend it by force, and never over-bend any part of the probe. Specifically:

- Do not bend the last 1 to 2 inches (25 to 50mm) of the probe by more than 70°
- Do not bend the probe at any other point by more than 90°
- The probe's neck is a particularly sensitive area. Never apply heavy weights or forces to the neck. Never try to bend the neck by hand; use only the control wheel. Before storing the probe, straighten the neck.

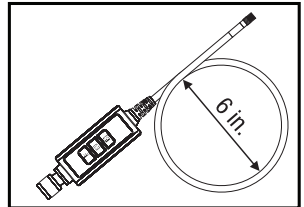
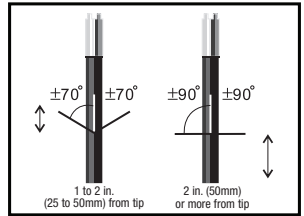

To avoid permanently damaging the delicate wires and fiber optic cables inside the probe, never curl it into a circle with a diameter of less than 6 in. (150mm).

Never use the probe or camera head to modify surroundings or to clear pathways or clogged areas.

DO NOT try to rotate the articulation angle control wheel beyond its limits.

The camera head, LEDs and thread protector ring are waterproof, but not acid-proof or fire-proof. Do not touch acidic, corrosive or hot materials or they will ruin the head.

Cover the camera-tipped end of the probe with the protective red rubber cap when not using it. Remember to remove the cap from the tip of the probe before using it again.

Unless you wish to install the 70° mirrored viewing tip, do not remove the thread protector ring (Fig. 1, Callout 5). Never use the probe without attaching either an accessory or the thread protector ring to it.

Never use the probe as a hammer or hook.

When inspecting a vehicle, shut off the engine. Metal and liquid under the hood may be hot. Do not get hot oil or gas on the camera head.

If condensation forms inside the camera lens, let it evaporate before using the probe again.

Because the VGA Resolution Probe has three extra-bright LEDs that require more power than the LEDs of General's QVGA (320 x 240 pixel) resolution probes, using the P16HPART will drain the batteries of your borescope more quickly. You will have to recharge your borescope more often.

Do not try to disassemble any part of the probe. Doing so creates an electrical hazard, could damage the probe, and voids the limited warranty.

Do not use any corrosive liquid—such as alcohol—to clean the probe body or camera head. Use a cotton swab and a mild fluid detergent to clean the body and head.