

PARTS LIST:

1	Bull Bar	2	10-1.5mm x 35mm Hex Bolts
2	Tube Brackets (Bull Bar) passenger or driver side	2	10mm Lock Washers
2	Upper Frame Brackets (models w/o tow hooks only)	4	10mm x 27mm OD x 3mm Flat Washers
1	Driver/Left Mounting Bracket	2	10-1.5mm Hex Nuts
1	Passenger/Right Mounting Bracket	4	8-1.25mm x 35mm Hex Bolts
1	Driver/Left Support Bracket	4	8mm Lock Washers
1	Passenger/Right Support Bracket	4	8mm x 22mm OD x 2mm Flat Washers
2	12-1.5mm x 30mm Special Fine Thread Hex Bolt (for models w/o tow hooks only)	2	5-.8mm x 15mm Button Head Allen Bolt
4	12-1.75mm x 35mm Hex Bolts	4	5mm x 10mm OD x 1mm Flat Washers
14	12mm x 32mm OD x 3mm Flat Washers	2	5mm Nylon Lock Nuts
10	12mm Lock Washers	1	Wrench (Allen bolt)
8	12-1.75mm Hex Nuts		

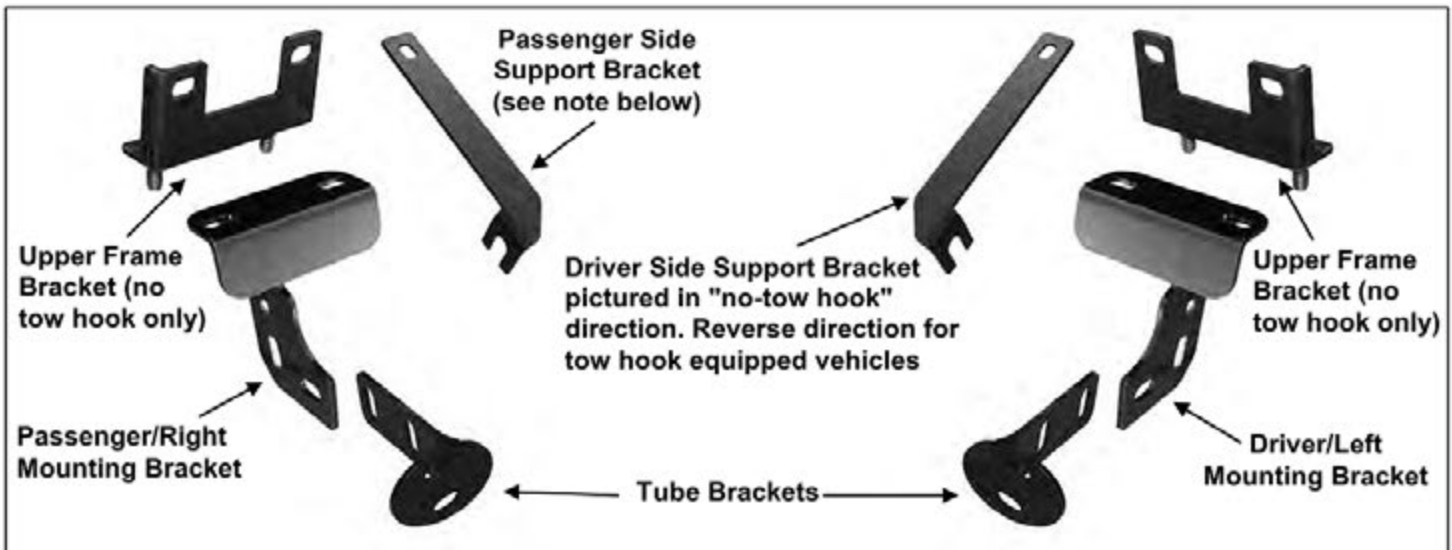

PROCEDURE:

REMOVE CONTENTS FROM BOX. VERIFY ALL PARTS ARE PRESENT. READ INSTRUCTIONS CAREFULLY BEFORE STARTING INSTALLATION. CUTTING IS REQUIRED. ASSISTANCE IS RECOMMENDED.

INSTALLATION MAY INTERFERE WITH FRONT BUMPER MOUNTED SENSORS. NOT RECOMMENDED FOR VEHICLES WITH "ACTIVE" LASER GUIDED CRUISE CONTROL SYSTEMS.

1. Start installation under the front bumper and carefully remove the plastic splash guard. **NOTE:** Depending on the model of truck, the splash guard may be attached to the bottom of the truck with hex bolts and several two-piece plastic push-in clips, (Figure 1A). Remove all hex bolts then locate the clips behind the bumper cover. Pry up on the center pin of the clip with a small flat blade screwdriver and remove the entire clip, (Figure 1B). Pay close attention to the type and location of all factory hardware for reinstallation. **IMPORTANT:** The splash guard may also be attached at the ends of the bumper cover with rivets. Use wire cutters to remove the rivets. Once all fasteners have been removed, move the splash guard to a clean stable work area.
2. Next, determine if the truck is equipped with tow hooks.

For models without tow hooks:

 - a. Remove the hex nuts from the two lower bumper bolts, (Figure 2).

- b. Select (1) Upper Frame Bracket, (will fit left or right-without tow hooks only), and the driver side Mounting Bracket, **(Figure 3)**. Bolt the two Brackets together with (2) 12mm Flat Washers, (2) 12mm Lock Washers and (2) 12mm Hex Nuts. Do not tighten at this time.
- c. Insert the Mounting Bracket assembly up from behind the bumper. Line up the holes in the Mounting Bracket with the (2) bumper bolts. Attach the Bracket assembly to the bumper bolts with the (2) factory hex nuts. Snug but do not fully tighten the hardware, **(Figure 5)**.

NOTE: On some vehicles, it may be easier to assemble the two-piece bracket on the vehicle. Install the Upper Frame Bracket first, then bolt the Mounting Bracket to the bottom as previously described.

- d. Select the driver side Lower Support Bracket. Attach the bent end of the Support Bracket to the inside of the top hole in the Mounting Bracket with the included (1) 10mm x 35mm Hex Bolt, (2) 10mm Flat Washers, (1) 10mm Lock Washer and (1) 10mm Hex Nut, **(Figure 4A)**. **NOTE:** On models without tow hooks, Support Bracket can be installed in either direction, **(Figures 4A & 4B)**.
- e. Attach the inner end of the Support Bracket to the frame with (1) 12-1.5mm x 30mm **Special Fine Thread** Hex Bolt, (1) 12mm Lock Washer and (1) 12mm Flat Washer, **(Figure 5)**. **IMPORTANT:** The hole in the bottom of the frame is **fine thread**. Only use the 12-1.5mm x 30mm Fine Thread Hex Bolt provided in the hardware kit. Snug but do not tighten all hardware at this time.

For models with tow hooks:

- a. Remove the (2) hex nuts holding the front of the tow hook to the bottom of the bumper bracket, **(Figure 6)**. Leave the rear hex bolt tight for the moment.
 - b. Select the driver side Mounting Bracket, **(Figure 7)**. Attach the Mounting Bracket to the (2) tow hook mounting studs with the (2) factory hex nuts. Do not tighten hardware at this time.
 - c. Loosen the rear tow hook bolt. Slide the inner bent end of the driver side Support Bracket between the bolt and the tow hook or replace with the included (1) 12-1.5mm x 30mm **Special Fine Thread** Hex Bolt, (1) 12mm Lock Washer and (1) 12mm Flat Washer, **(Figure 7)**. Do not tighten hardware at this time.
 - d. Line up the flat forward end of the Support Bracket with the inside of the Mounting Bracket. The Support Bracket will attach to the lower rear hole in the Bracket. Do not attach at this time.
3. Repeat the appropriate **Step 2** for the passenger side Mounting Bracket installation.
 4. Next, select (1) Tube Mounting Bracket, **(Figure 8)**. Bolt the Bracket to the end of the Bull Bar with (2) 8mm x 35mm Hex Bolts, (2) 8mm Lock Washers and (2) 8mm Flat Washers, **(Figure 9)**. Leave hardware loose at this time. Repeat this **Step** to install the passenger side Tube Bracket.
 5. With help, position the Bull Bar with Tube Brackets up to the inside of the Mounting Brackets. Use the included (4) 12-1.75mm x 35mm Hex Bolts, (8) 12mm Flat Washers, (4) 12mm Lock Washers and (4) 12mm Hex Nuts to attach the Tube Brackets to the Mounting Brackets, **(Figures 9 & 10)**. **NOTE:** On vehicles with tow hooks, insert the 12mm rear Hex Bolt through the rear hole in the Mounting Bracket, the Tube Bracket in the middle and out through the flat end of the Support Bracket, **(Figure 7)**. Do not tighten hardware at this time.
 6. Stand back from the vehicle and check to see that the Bull Bar is centered and level on the vehicle and adjust as necessary. Tighten only the hardware securing the Mounting Brackets to the vehicle first. Next tighten only the (4) 8mm Hex Bolts securing the Tube Brackets to the Bull Bar as described in **Step 4**. Do not tighten the 12mm hardware attaching the Tube Brackets to the Mounting Brackets. Remove the Bull Bar with Tube Brackets attached.
 7. Hold the splash guard up to the bumper cover and align it with the mounting points, **(Figure 11)**. Mark the location of the Mounting Brackets onto the back of the splash guard, **(Figures 11—13)**. Cut an approximately 1" wide by 4" long slot in the splash guard, **(Figure 13)**. **NOTE:** The size of the slot is an estimate only and may vary due to different factory designs for the splash guards and front bumper covers. Also, additional cutting may be required to clear the Support Bracket on vehicles equipped with tow hooks. **IMPORTANT:** To avoid weakening the splash guard, do not cut the slot any larger than necessary. Do not cut through the front or back edges of the cover, **(Figure 13)**. Make several small cuts first and check the fit often for a clean installation.
 8. Reinstall the splash guard using the factory hardware. Use the included (2) 5mm x 15mm Allen Bolts, (4) 5mm Flat Washers and (2) 5mm Lock Nuts at the ends of the splash guard if required, **(Figure 14)**.
 9. Reinstall the Bull Bar described in **Step 5**, **(Figure 10)**.
 10. Level and adjust the Bull Bar and tighten all hardware.

11. Do periodic inspections to the installation to make sure that all hardware is secure and tight.

To protect your investment, wax this product after installing. Regular waxing is recommended to add a protective layer over the finish. Do not use any type of polish or wax that may contain abrasives that could damage the finish.

For stainless steel: Aluminum polish may be used to polish small scratches and scuffs on the finish. Mild soap may be used also to clean the Bull Bar.

For gloss black finishes: Mild soap may be used to clean the Bull Bar.

Driver Side Installation Pictured

Pry up the center pin to
remove the complete fastener

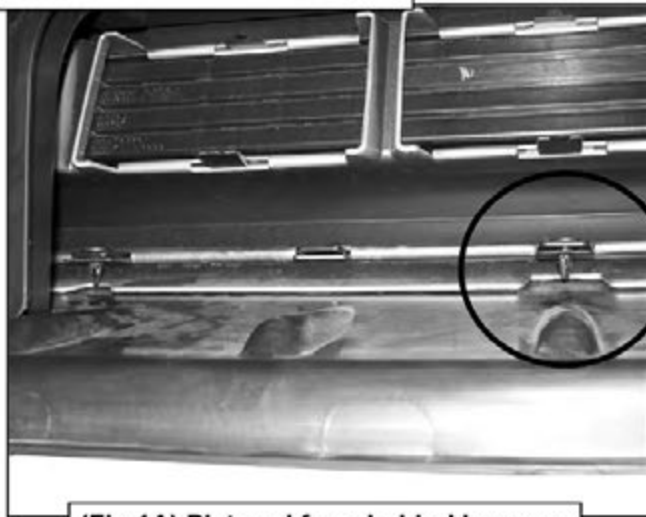

(Fig 1A) Pictured from behind bumper

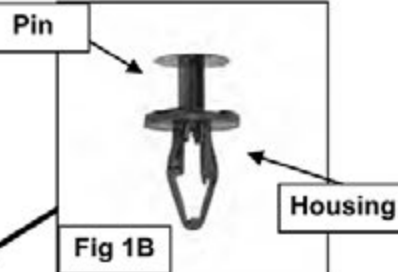

Remove the (2) factory hex nuts
from the lower bumper bolts

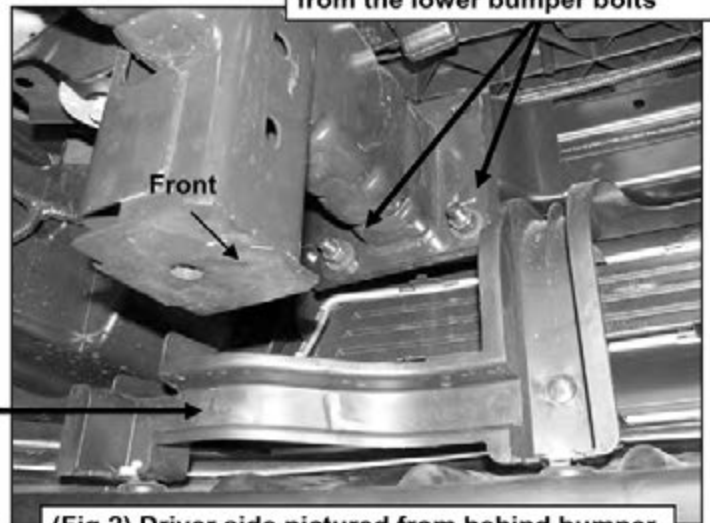

(Fig 2) Driver side pictured from behind bumper
(no tow hook model with bumper support)

Bumper support

Driver Side Installation Pictured

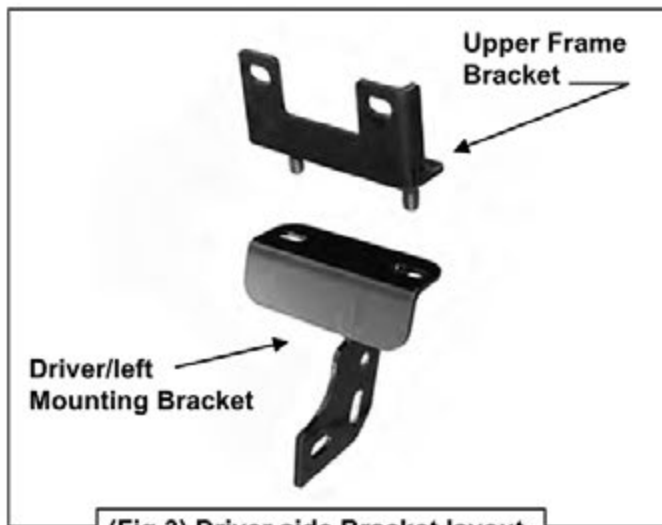

(Fig 3) Driver side Bracket layout in "no tow hook" position

- (1) 10mm x 35mm Hex Bolt
- (2) 10mm Flat Washers
- (1) 10mm Lock Washer
- (1) 10mm Hex Nut



(Fig 4A) Driver side Support Bracket in "no tow hook-with bumper support" position

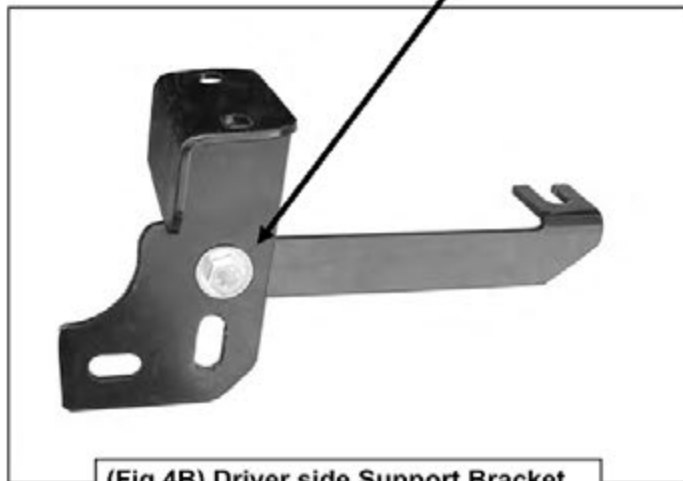

(Fig 4B) Driver side Support Bracket in "no tow hook-no bumper support" position as also pictured in Figure 10

Upper Frame Bracket
"no tow hook models,"
reuse factory hex nuts

- (2) 12mm Flat Washers
- (2) 12mm Lock Washers
- (2) 12mm Hex Nuts

IMPORTANT: On models without tow hooks, use only the supplied
12-1.5mm x 30mm Fine Thread Hex Bolt
12mm Flat Washer
12mm Lock Washer

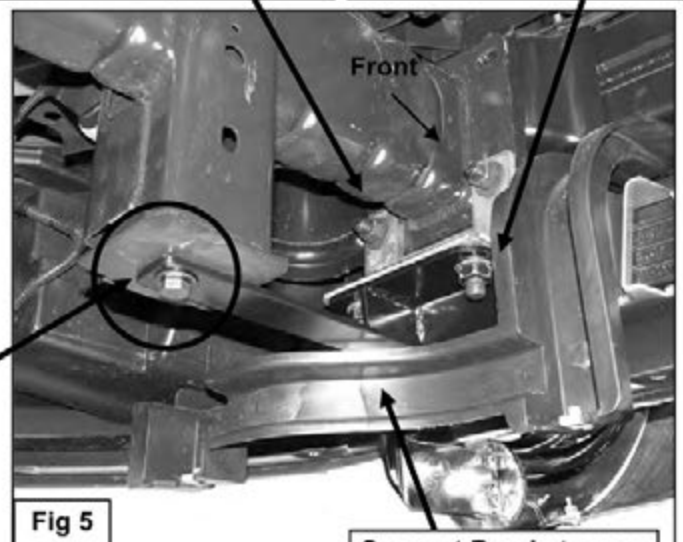
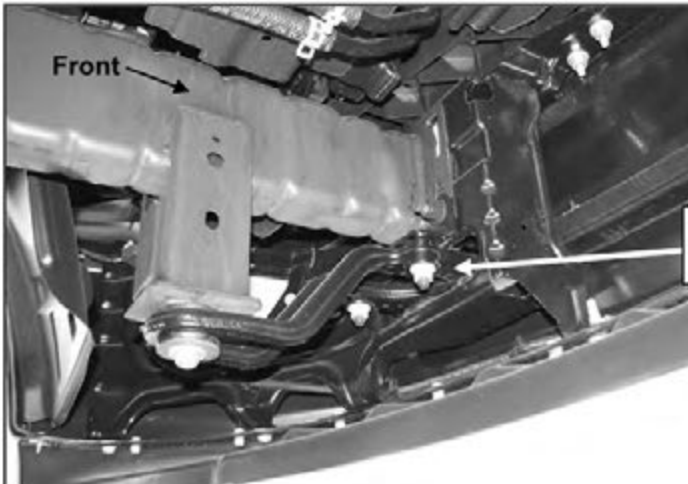

Fig 5

Support Bracket over bumper support

Driver Side Installation Pictured



(Fig 6) Driver side mounting location pictured from behind bumper on tow hook equipped model

Remove the (2) factory hex nuts

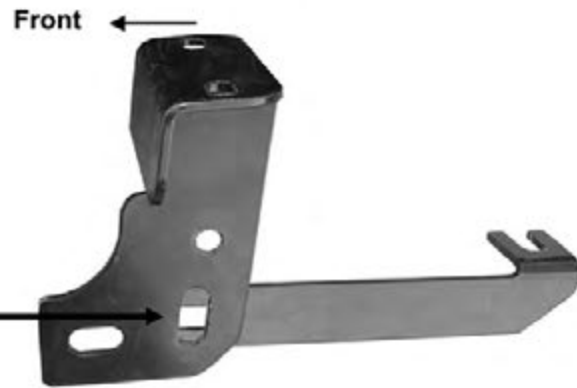

(Fig 7) Driver side Support Bracket in "with tow hook" position. Line up Bull Bar Bracket between Mounting Bracket and Support Bracket

12mm x 35mm Hex Bolt
 (2) 12mm Flat Washers
 12mm Lock Washer
 12mm Hex Nut
 (Also attaches the Bull Bar to the Mounting Bracket)

Installation pictured without the splash guard for illustration



(Fig 8) Bull Bar Tube Bracket

Attach each Tube Bracket to the end of the Bull Bar with:
 (2) 8mm x 35mm Hex Bolts
 (2) 8mm Lock Washers
 (2) 8mm Flat Washers

(1) 10mm x 35mm Hex Bolt
 (2) 10mm Flat Washers
 (1) 10mm Lock Washer
 (1) 10mm Hex Nut

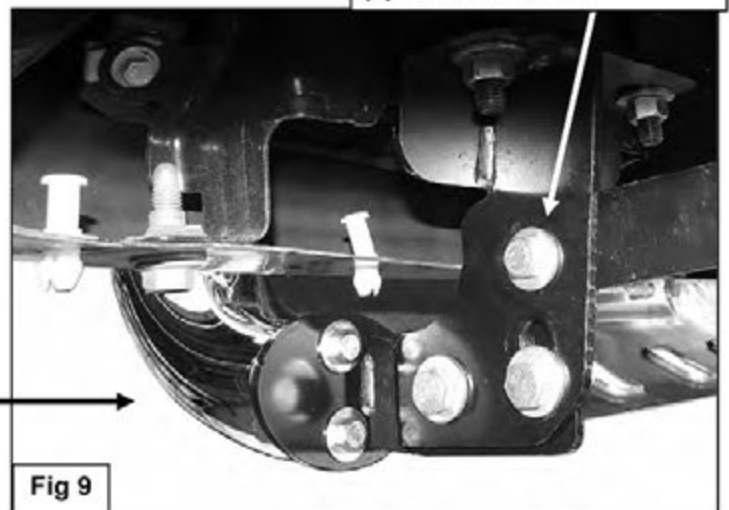
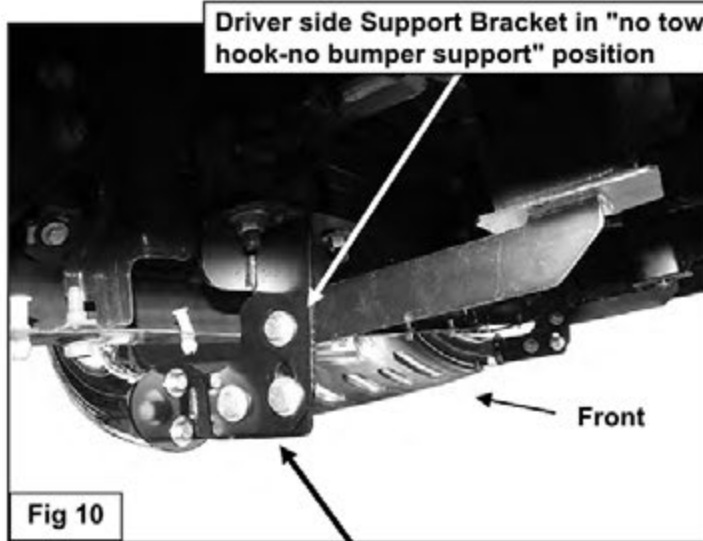

Fig 9

Driver Side Installation Pictured



- (2) 12mm x 35mm Hex Bolts
- (4) 12mm Flat Washers
- (2) 12mm Lock Washers
- (2) 12mm Hex Nuts

Hold the splash guard up to the bottom of the brackets and mark location for cutting to clear brackets. Cut only what is needed to insert bracket through the splash guard.

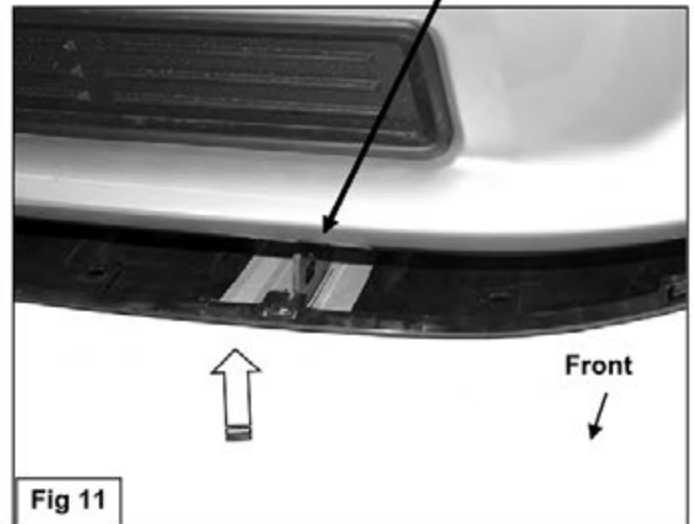

Installation pictured without the splash guard for illustration

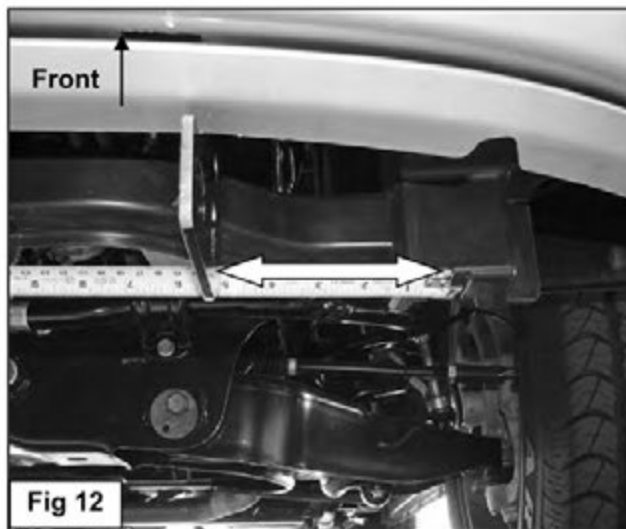

Measure the distance from the mounting point for the splash guard to the bracket on the driver and passenger side. Use this measurement as a reference point to check location before cutting the 1" wide x 4" long slot

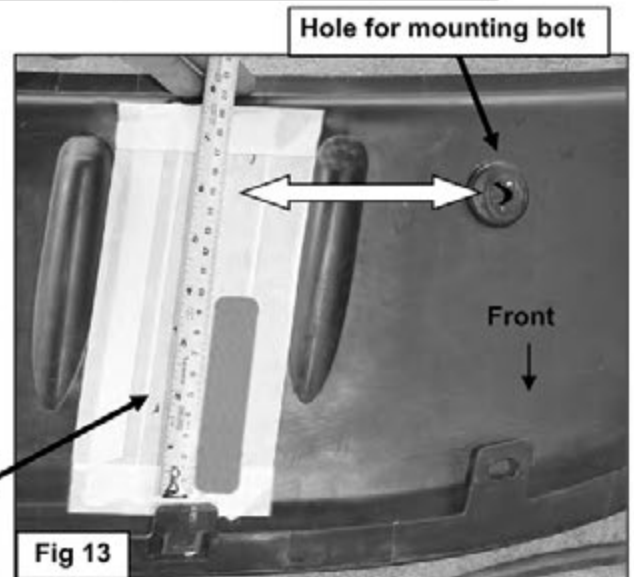

Cut only what is needed to insert bracket through the splash guard. Do not cut through the front edge of the splash guard

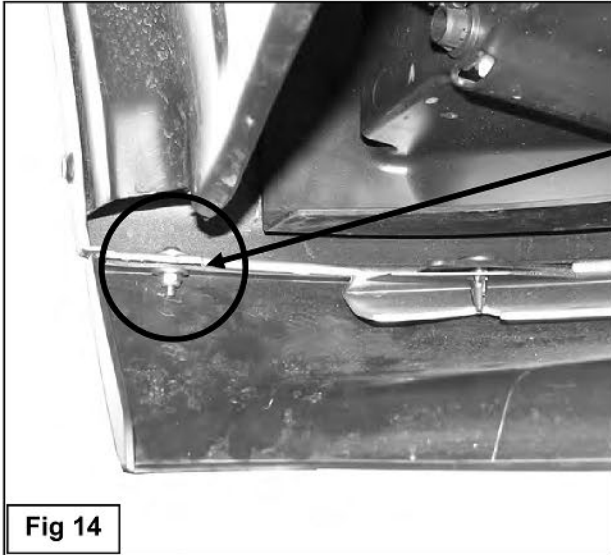

If required, replace the rivet at the corner of the splash guard with the supplied:
5mm x 15mm Button Head Allen Bolt
(2) 5mm Flat Washers
5mm Nylon Lock Nut

Fig 14



INSTALLATION COMPLETE

Learn more about grille guards and bull bars we have.