

FURUNO

FURUNO

MARINE ELECTRONICS CATALOG



MARINE
ELECTRONICS
CATALOG

FURUNO —

We sense more!

Offering the best possible solutions without compromise

For more than 70 years, FURUNO ELECTRIC CO., LTD. has been establishing a heritage of inventions and making electronic equipment on which more captains rely on day in and day out.

For the men and the women who make a living on the seas, to those who simply enjoy the boating lifestyle, FURUNO is the name that is synonymous with quality electronics you can definitely trust.

You will find that vast and varied range of equipment from FURUNO offers the ultimate performance while providing intuitive operation and making your navigation experience more enjoyable.

It is also reassuring to know that there is an unrivaled, worldwide sales/service network that provides assistance in every corner of the globe.

Every product includes two-year assurance program of factory parts, service work and equipment maintenance guaranteeing the high quality upkeep for all the devices. That is a priceless value that no other brand can have responded to as far as FURUNO.



Fish finder in the early years. (1948)



In 1950, FURUNO INDUSTRIES, LTD. was established. (1955)



Recording paper type fish finder, which is first export model for US market. (1965)



FURUNO won the Best Product Award in the fish finder category from NMEA. (1972)

1938 FURUNO ELECTRIC SHOKAI LTD. founded in Nagasaki, Japan

1948 Commercialized the world's first practical fish finder
Began manufacturing and selling fish finders

1955 Established FURUNO ELECTRIC CO., LTD.

1958 Started selling overseas (Argentina, Australia, China)

1959 Developed radar for vessels

1961 Developed the world's first net sonde

1965 Developed the world's first net recorder

1972 Received NMEA's fiscal 1971 Best Product Award

1973 Developed autopilot system, satellite positioning equipment and simple radio telephone

Contents

NavNet Series	3
Radar	23
GPS/Chart Plotter	33
Fish Finder	37
Sonar	43
Autopilot	47
Instrument	53
Monitors	55
Remote Display	57
Compass	58
Communications	61
TECHNICAL SPECIFICATIONS	67
FURUNO'S GLOBAL NETWORK	111
WORLDWIDE DISTRIBUTORS	113



World's first bird radar was developed. (1986)



World's first dual-frequency searchlight sonar. **CH-300** (2005)



Developed NavNet TZtouch2 Series. **NAVnet** (2015)

1980 Developed the world's first current indicator, VideoPlotter and compact facsimile receiver

1986 Developed the world's first bird radar

1987 Developed the world's first video LORAN

2001 Developed NavNet Series

2005 Developed the world's first dual-frequency searchlight sonar

2008 Developed NavNet 3D Series

2012 Developed NavNet TZtouch Series

2015 Developed NavNet TZtouch2 Series

2016 Developed solid state doppler radar DRS4D-NXT

NAVnet

TZ2 touch

Simply Refined, Simply Beautiful



12.1" Multi Function Display

Model **TZTL12F**

Resolution: WXGA (1280 x 800 pixels)
Brightness: 1300 cd/m² (typical)



15.6" Multi Function Display

Model **TZTL15F**

Resolution: FWXGA (1366 x 768 pixels)
Brightness: 1000 cd/m² (typical)



SD Card Unit (option)
Model **SDU001**



»»» Spec P68



- Edge-to-edge glass front
- Sunlight viewable multi touch display with impressive brightness, 1300 cd/m² for TZTL12F and 1000 cd/m² for TZTL15F
- Seamless, smooth chart operation with the TimeZero™ Technology
- Enhanced touch gestures like edge swiping for frequently used functions
- A graphical user interface that has been renewed and refined, focusing on usability and ease of operation
- Internal RezBoost™ Fish Finder
- Internal GPS Antenna
- Add Autopilot, Instruments, Radar, AIS, and a wide variety of other sensors to your NavNet TZtouch2 network

- An instrument display like nothing you have seen before. Totally customizable, totally simple
- Connect up to 6* NavNet TZtouch2/ TZtouch displays on one network
- With an internet connection, NavNet TZtouch2 can wirelessly access real-time weather data
- Tablet & Smart phone apps: NavNet Remote, NavNet Viewer and NavNet Controller for your iOS and Android™ devices
- With ActiveCaptain, you can find updated information on fuel prices, marinas and obstructions directly on your plotter screen
- Compatible with CZone Digital Switching
- Manual Fuel Management enabling visual evaluation of fuel amount



Remote Control Unit (option)
Model **MCU002**



Remote Control Unit (option)
Model **MCU004**

* Software version 5.01 or later, coming Spring 2017 - connect up to 4 displays with earlier software versions



NEW

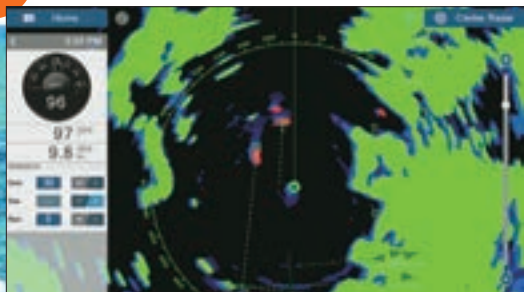

Target Analyzer with Echo Trail
 Revolutionary Target Analyzer function instantly identifies hazardous targets with Echo Trail.

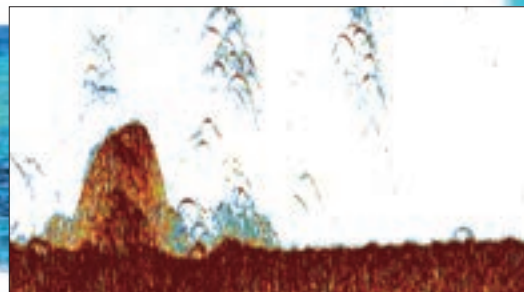

Built-in Fish Finder with RezBoost™
 RezBoost™ technology makes it easier to spot individual fish in tightly packed fish schools as well as discerning game fish from bait fish.

NEW

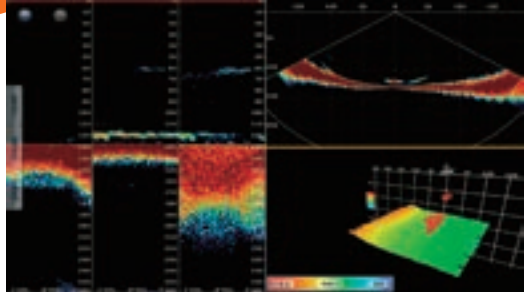

Advanced multi-beam technology with DFF3D*
 Deep and wide-range water column and seabed are displayed in real time. *Coming in spring 2017.



Instrument Display & Customization
 An instrument display like nothing you have seen before. Totally customizable, totally simple.

NEW



Digital Switching on Your Fingertips
 Monitoring and Controlling digital switching CZone system from your NavNet TZtouch2.



iOS & Android™ Apps
 View information from your NavNet TZtouch2 and control it on your iOS and Android™ devices.

New Features

Echo Trail/Echo Average

Echo Trail and Echo Average features have been added to the latest version of NavNet TZtouch2 series. Using these new functions, Bird mode will more accurately detect and track birds by providing a clear view of the target with a more powerful noise reduction. Echo Trail enhances and amplifies the Target Analyzer* and doppler technology to help prevent hazardous situation and gives an intuitive understanding of nearby vessel's movements.

* Target Analyzer available when connected to DRS4D-NXT.

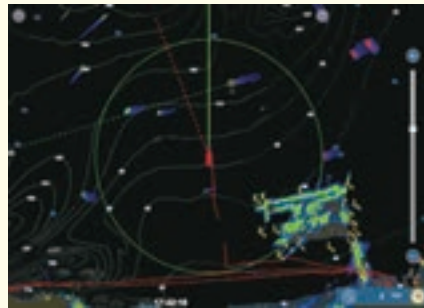

True Echo Trail

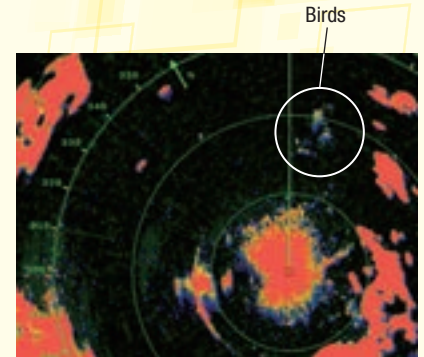

Bird mode with Echo Average

CZone Digital Switching



CZone digital switching by BEP simplifies the installation and operation of complex electrical systems. NavNet TZtouch2 is compatible with CZone controls, allowing you to operate many of your boat's electronic systems directly from your MFD.

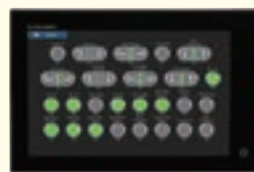

NMEA2000



CZone Control & Monitoring



CZone

NMEA2000

CZone, engine, navigation and various NMEA2000 data can be laid out in the same screen.

Manual Fuel Management*

NavNet TZtouch2 calculates and displays the remaining fuel based on the manually entered tank capacity, as well as fuel consumption information from an NMEA2000 network. The gauge allows the user to evaluate precisely the fuel level without equipping the ship with a fuel gauge. By configuring the settings, an alarm is available to inform you if the tank is running out of fuel.

- * 1) NMEA 2000 PGN127489 (Fuel Rate) input is required.
- 2) While the engine is running, at least one TZTL12F/TZTL15F in the network should be always turned on in order to keep calculating the fuel consumption.
- 3) The fuel indication may be inaccurate if the values entered are not correct, or the fuel rate sensor is not functioning correctly.

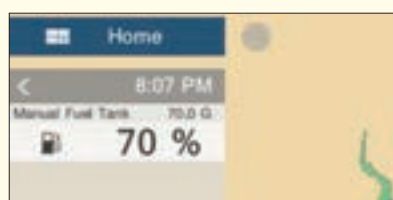

Data box

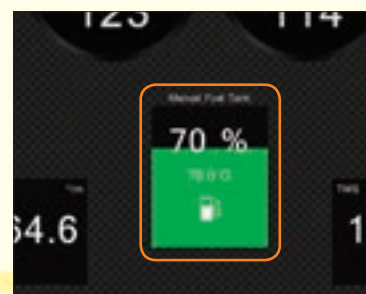

Manual Fuel Tank display in Instrument mode

All new functions require software v4.01 or later.

NEW GRAPHICAL INTERFACE

NavNet TZtouch2 features a graphical user interface that has been renewed and refined, focusing on usability and ease of operation. You'll have full control of each component connected to the network right at your fingertips.

Home Screen

The new home screen, with its bright and crisp graphics, is easy to understand and operate. The colors and icons have been carefully chosen to provide maximum visibility, allowing you to know instantly which screen is displayed, just by seeing the color and icon. Changing to different display screens is just a simple matter of dragging and dropping.



Quick Page

Swiping your finger down from the top edge of the screen displays the Quick Page. As the name implies, the Quick Page allows you to quickly change between the different screens from your current display. With bold colors, the previews are easy to differentiate and quickly choose from.

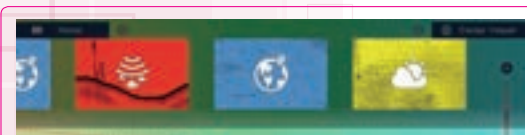

NavData

Swiping from the left edge of the screen reveals the NavData panel, where you can customize contents to simplify navigation and chart usage. You can set the autopilot, check tide information and much more.



Slide-Out Menu

The slide-out menu provides quick and easy access to often-used functions, and is available in every mode.

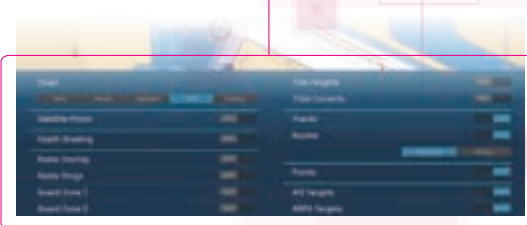

Layers

One of the new features is the layers menu, just swipe up from the bottom edge of the screen. The layers menu is a practical way of changing settings on the fly without having to venture into deeper menu systems. Since the screen is visible at all times, understanding and using the different settings becomes a breeze.

Instrument display set up



Instruments

The instrument page is impressive just on its own rights, but where it really shines is its customizability. No matter if it is for navigation, engine and tank monitoring, autopilot control, or a combination, data can be displayed according to your personal tastes and needs.



Fully Customizable

Instrument rearrangement is available at your fingertips. You are free to customize the display to precisely fit your unique needs. Also note that instruments can overlap each other, giving you even more space to work with.

WIRELESS

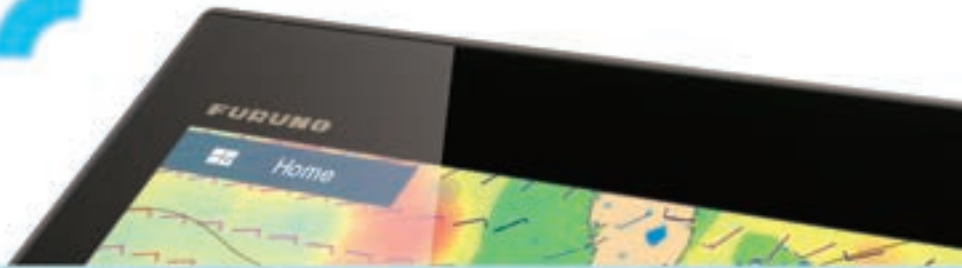

Marine Weather Forecast

The weather tool is completely free and easy to use, giving you unlimited access to weather forecasts, worldwide, 24 hours a day, provided by NavCenter. Select the coverage you want, what type of data it is you need and for what time period, then it is simply a matter of choosing how to download the data. NavNet TZtouch2 can display up to 16 days of downloaded weather forecasting.

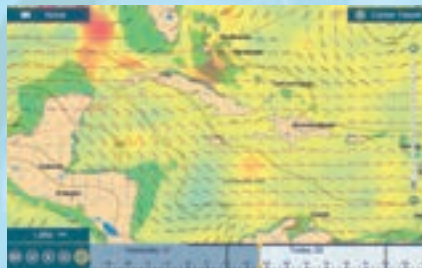

ActiveCaptain



ActiveCaptain*

NavNet TZtouch2, the world's first Multi Function Display with ActiveCaptain functionality. Share the experience together with other boaters around the world, browse and discover new points of interest. With a community of 250,000 users, reliable and updated information on fuel prices, marinas and obstructions are all available at the tip of your fingers. You can even rate and comment on points of interests, such as marinas and anchorages, straight from your NavNet TZtouch2. *Software version 3.01 or later is required.

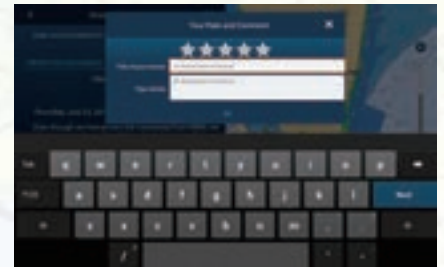

My TimeZero™ Cloud Data Service*

My TimeZero™ cloud data service allows you to back up your data on the cloud and synchronize it among your TimeZero™ devices. Connect your NavNet TZtouch2 to the internet and login on your My TimeZero™ account, and you are able to back up or restore points, routes, tracks and settings to/from the cloud server. Plan routes on your tablets at home and transfer them to your NavNet TZtouch2 onboard through cloud. You won't have to carry memory cards from device to device ever again.

*Coming soon.

BBWX3 – SiriusXM Satellite Weather Receiver*



Keeping track of weather is easier than ever with Furuno's BBWX3 Third-Generation SiriusXM Satellite Weather Receiver! The weather information is obtained from the weather industry's leading experts and is delivered via digital receiver through SiriusXM's Marine Weather services. You can receive high-quality and comprehensive weather information and forecasting for use while navigating. You can also enjoy the full package of SiriusXM's satellite radio channels straight from your NavNet device. With over 140 channels available, you can listen a wide variety of music, as well as news and other entertainment.

*Satellite weather receiver service is available for all NavNet TZtouch2, TZtouch and NavNet 3D models. Requires SiriusXM weather service subscription, sold separately. SiriusXM weather coverage is currently available only in U.S and Canada.



BUILT-IN FISH FINDER



RezBoost™

Rezboost™ is a revolutionary new technology utilizing FURUNO's advanced digital signal processing to provide fantastic resolution without having to change your transducer.

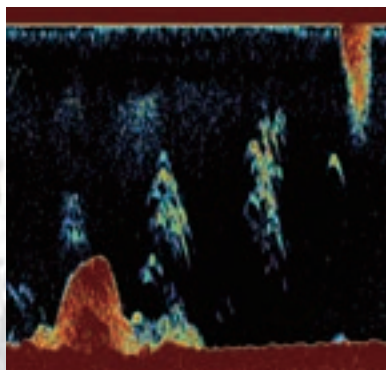

Conventional Signal Processing

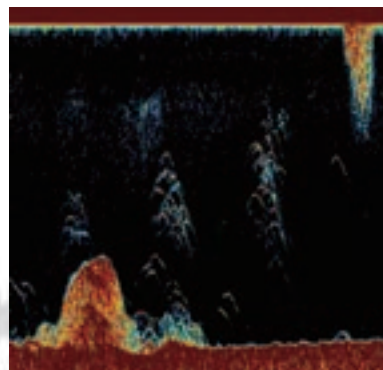

RezBoost™ Signal Processing

RezBoost™ improves target separation close to the seabed, as well as giving an unprecedented boost in resolution. With RezBoost™ technology, resolution and target separation previously limited to FURUNO commercial-grade Fish Finders can now be achieved. RezBoost™ technology makes it easier to spot individual fish in tightly packed fish schools, as well as discerning game fish from bait fish. Since RezBoost™ technology is software based, you can use transducers* already installed on your vessel.

* For compatible transducers see Spec P85. In-hull mounted transducers not compatible with RezBoost™ technology.

** RezBoost™ performance may vary depending on depth, range and signal frequency used.

Fully featured fish finder

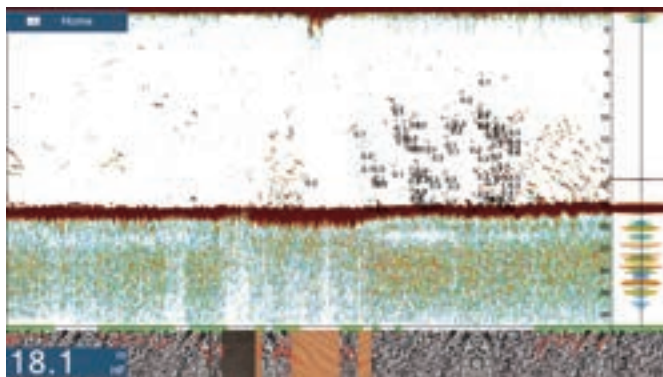

With RezBoost™, ACCU-FISH™ and Bottom Discrimination at your fingertips, finding and reeling in that catch has never been easier.

Scroll-back function

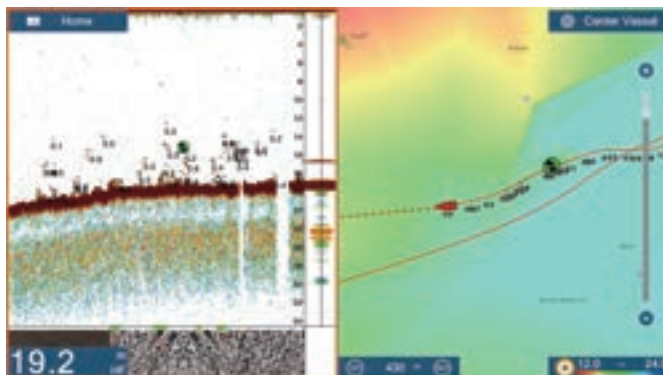

Found a fishing hot spot? Simply tap the screen and add a fish mark.

With the new scroll-back feature, you can look at past echoes simply by swiping the screen, and add new fish marks that will show the captured location on your plotter screen.



Total Control at your Fingertips

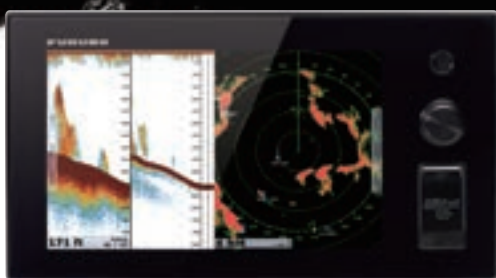

9" Multi Function Display

Model TZT9

Resolution: WVGA (800 x 480 pixels)

Brightness: 900 cd/m² (typical)

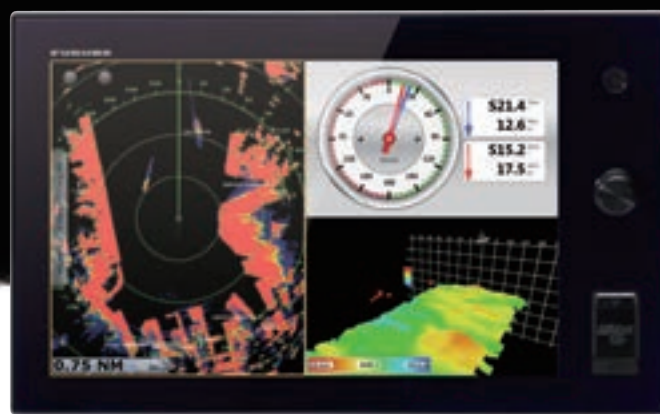

14.1" Multi Function Display

Model TZT14

Resolution: WXGA (1280 x 800 pixels)

Brightness: 900 cd/m² (typical)



2012/2013*
2014*

*TZT14

- Sunlight viewable multi touch display
- Luxury, piano black wide screen coated with glass panel
- Easy, intuitive and slick operation with touch screen and RotoKey™
- Seamless, instant chart/radar redraw with the TimeZero™ Technology
- Detailed 3D and 2D charts and high resolution satellite images
- Simple, flat display with a minimum of mechanical keys
- Add Radar, Network Fish Finder, AIS, and a variety of other sensors
- NMEA2000 network interface
- Connect up to 6 TZtouch/TZtouch2 displays
- Synchronize data with the NavNet TZtouch2 instantaneously
- Save up to 30,000 user points, 30,000 ship's track points and 200 planned routes with up to 500 waypoints per route
- Wireless LAN connectivity for weather information and automatic chart unlocking
- Tablet & Smartphone apps: NavNet Remote, NavNet Viewer and NavNet Controller for your iOS and Android™ devices
- Dual SD Card slots

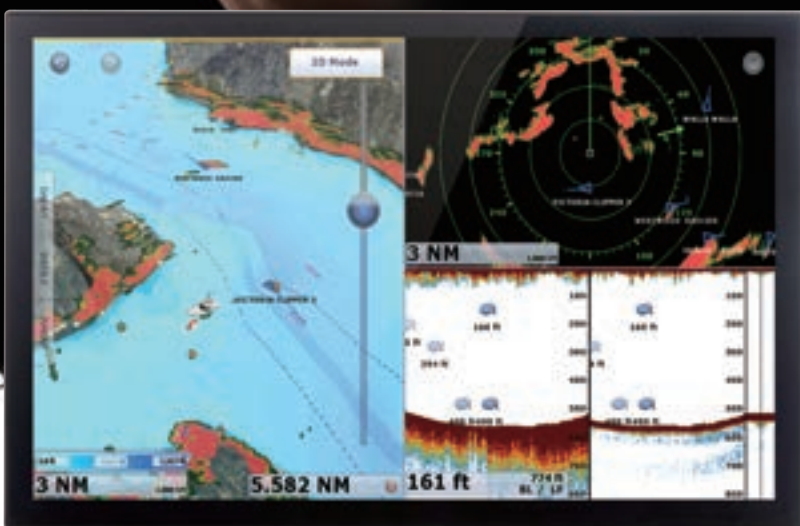

Multi-touch marine display* with TZTBB processor (model MPU-002)
* Local supply

Multi Function Display Black Box
Model TZTBB

Supports both wide and non-wide resolutions:
1280 x 720 (16:9), 1280 x 800 (16:10), 1280 x 960 (4:3),
1280 x 1024 (5:4)



Remote Control Unit (option)
Model MCU002

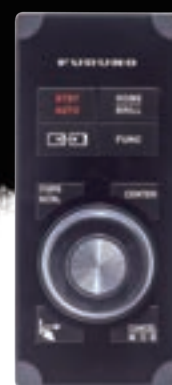

Remote Control Unit (option)
Model MCU004



* TZT14
2012/2013*
2014*

»»» Spec P69-70



Multi Touch Control

FURUNO elevated marine touch screen technology to an entirely new level with the industry's first multi touch MFD. The use of multi touch technology opens the door to a wide variety of gesture-based commands.



Touch... and Go Menu Selection

Be more hands-on with our easy-to-understand touch screen interface. You'll have full control of each component connected to the network right at your fingertips.

APPS

View information on your smart devices via wireless network

NavNet TZtouch and TZtouch2 open the door to cutting edge Wireless LAN features, such as iOS and Android™ apps, real-time weather data, software updates and much, much more.

NavNet Remote App

Take full control of your NavNet TZtouch/TZtouch2 in a whole new way. The NavNet Remote app allows you to remotely operate and view your system with your smart devices when connected to the Wireless LAN network.

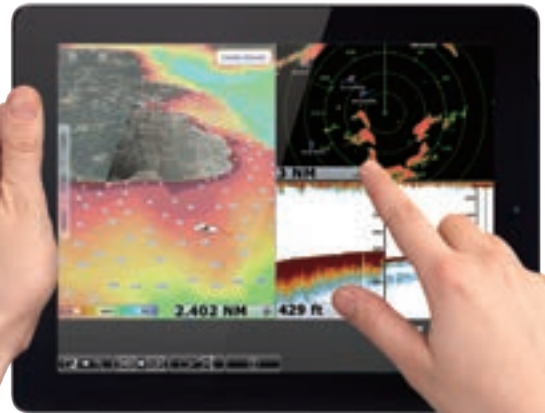

NavNet Viewer App

Conveniently view instruments as well as the fish finder of your NavNet TZtouch/TZtouch2 on your smart devices over the Wireless LAN network. Key navigational information such as Depth, Temp, Wind, COG as well as Engine information can all be accessed from the palm of your hand. Even if you change the display on your NavNet TZtouch2, you can still view the fish finder on your smart devices.

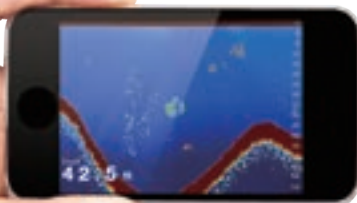
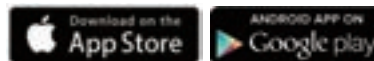

NavNet Controller App

Wirelessly control the NavNet TZtouch/TZtouch2 with touch controls just like the real thing. With a scroll pad, cursor pad and dedicated keys within the app, controlling the NavNet TZtouch/TZtouch2 is simple and straightforward.



	NavNet Remote	NavNet Viewer	NavNet Controller
Compatible NavNet products	NEW NavNet TZtouch2 (TZTL12F/TZTL15F) - software version 4.01 or later. NavNet TZtouch (TZT9/TZT14/TZTB)	NavNet TZtouch2 (TZTL12F/TZTL15F) NavNet TZtouch (TZT9/TZT14/TZTB)	NavNet TZtouch2 (TZTL12F/TZTL15F) NavNet TZtouch (TZT9/TZT14/TZTB)
Languages	English/Japanese	English/Japanese	English/Japanese

TimeZero™



Nothing Is Faster Than TimeZero™

NavNet TZtouch's TimeZero™ technology delivers chart processing like you've never seen before – seamless chart handling, zooming and panning without the screen disappearing. TimeZero™ technology redefines the meaning of stress-free operation by smoothing out your chart handling actions.

The Only Acceptable Wait Time is Zero: TimeZero™ Technology Changes Your Perspective on Chart Redraw

Equipped with powerful TimeZero™ technology, NavNet TZtouch2 and TZtouch will completely transform the way you navigate. You can scroll, pan, zoom in/out with a smooth, fast and seamless graphics engine. Navigating in a fully 3D environment offers you a true perspective and wider area of view around the ship, which allows you to better plan your route. TimeZero™ technology updates the information on your screen with virtually no redraw as you go.



CHART PLOTTER

Mapmedia Vector and Raster Chart Library

The NavNet series offers users the ability to freely choose the charts that fit their personal needs. Coming with the official NOAA raster and vector charts, Mapmedia brings an authentic vector and raster chart library to your NavNet Series devices. "C-MAP"™ as well as "Datacore by Navionics" vector cartography are both optional charts that can be downloaded to your NavNet Series device with ease.

Mapmedia cartography integrates cutting edge algorithms with high resolution image processing techniques to deliver a fusion of digital navigation charts and satellite photography. This knowledge ensures absolute clarity and detail when displaying charts on your NavNet Series devices.



Mapmedia Raster



Mapmedia Vector



Radar-Chart overlay



C-MAP 2D Vector



C-MAP 2D Vector + Satellite PhotoFusion™

Sattelite PhotoFusion™

Satellite photography is included in the Mapmedia Raster and Vector charts, simply called Satellite PhotoFusion™. Land areas (zero depth) are completely opaque, displayed as satellite photos on the chart. As the depth increases, the satellite image is merged with the chart data to provide you with added detail on seabed areas in shallow water, without losing vital chart information. In deeper water, where the satellite photos have no detail to offer, the chart is displayed without alteration.



Vector + Satellite PhotoFusion™



Raster + Satellite PhotoFusion™

Depth Shading

A depth color scale can be applied to both 2D and 3D vector and raster charts. Transparency levels can be adjusted so that the chart data is visible beneath the color shading. This unique feature allows you to view water depths at-a-glance with vibrant colors. No more searching for depth numbers, when you can simply set depths to your specified colors. Whether you want to see the depth for navigation or fishing purposes, this feature makes it easier than ever before.



DIGITAL RADAR



Radar Sensors



Ultra High Definition (UHD™) Digital Radar

FURUNO has taken its NMEA award-winning radar technology to the next level with Ultra High Definition Digital Radar. UHD™ offers crystal clear target presentation with automatic real-time digital signal processing. The antenna rotation speed (24/36/48 rpm) is automatically shifted according to the range needed for optimal performance*. Commercial-grade radar performance is now available in the ultimate MFD navigation suite.

*Not available on DRS4DL.

- Digital Signal Processing enhances short and long range target detection
- Enhanced auto gain anti-clutter controls and auto tuning
- Bird mode helps you identify birds, adjusting the gain and sea settings automatically for optimal visibility
- Fast Target Tracking™, takes a few seconds for a speed and course vector to be displayed
- Minimum detection range of just 20 m approx.**
- Advanced side lobe reduction technology
- Spot-on Radar-Chart Overlay on both 2D/3D chart presentations*
- AIS overlay “AIS-over-Radar” presentation for precise vessel tracking*
- Radar Guard Zone and Watchman features alert you to potential dangers
- Dual VRM (Variable Range Markers) and dual EBL (Electronic Bearing Lines) give distance and bearing indications
- No Power Supply Unit required

* Appropriate sensor required.
 ** Available on DRS X-Class radars.

NavNet TZtouch2/TZtouch Radar Sensor Options

	DRS4DL	DRS4D-NXT	DRS6A X-Class	NEW DRS12A X-Class	NEW DRS25A X-Class
Output Power	4 kW	Solid-state, 25 W	6 kW	12 kW	25 kW
Size	19 inch	24 inch	3.5 ft/4 ft/6 ft	4 ft/6 ft	4 ft/6 ft
Antenna Type	Radome	Radome	Open	Open	Open
Beam Width	Horizontal	3.9°	2.3°/1.9°/1.4°	1.9°/1.4°	1.9°/1.4°
	Vertical	25°	22°/22°/22°	22°/22°	22°/22°
Max. Range	36 NM	36 NM	96 NM	96 NM	96 NM
48 rpm Capability	—	•	•	•	•
Functions	Head-up, North-up*, True Echo Trail, AIS	Head-up, North-up*, True Echo Trail, Bird mode, TT, AIS	Head-up, North-up*, True Echo Trail, Bird mode, TT, AIS	Head-up, North-up*, True Echo Trail, Bird mode, TT, AIS	Head-up, North-up*, True Echo Trail, Bird mode, TT, AIS
	Target Analyzer	•	—	—	—
Dual Range Scanning	—	• (Range is limited to 12 nm)	•	•	•
Fast Target Tracking™	—	•	•	•	•
MFD version required	TZtouch2	2.03	3.01	4.01	4.01
	TZtouch	4.11	4.21	4.21	5.01

* Heading input required.
 The radar antenna complies with IEC62252 Ed. 1:2004 (Clauses 4.33, 5.33, Annex D) relevant to radio characteristic.
 Not available for NavNet 3D.

Chart Overlay/TT/AIS/Echo Trail

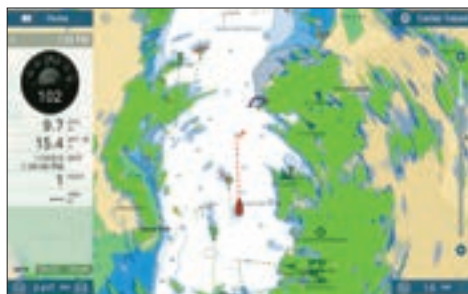

Target Analyzer

Target Analyzer function displays targets that are approaching your vessel automatically, changes color to help you identify when they are hazardous. Green echoes are targets that are moving towards your vessel.

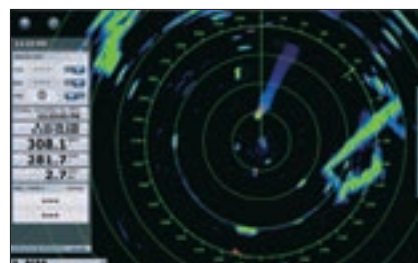

* Only available with DRS4D-NXT

Bird Mode

Bird mode works by adjusting the gain and sea settings automatically for optimal visibility.

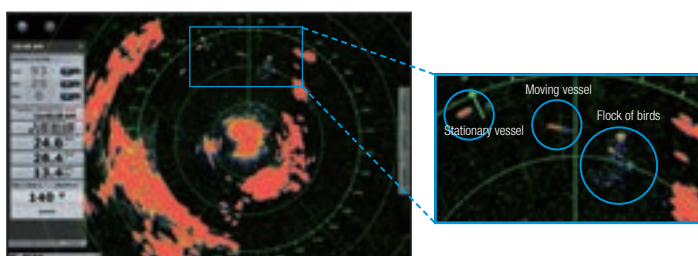

Dual Range Mode

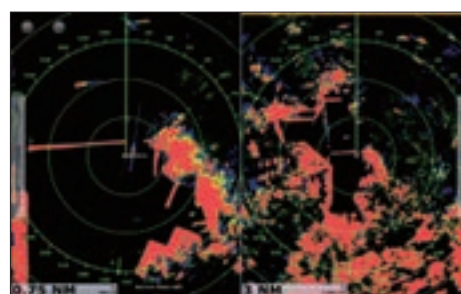

Fast Target Tracking™ (TT)

After selecting a target, it only takes a few seconds for a speed and course vector to be displayed. With accurate tracking information, estimation of other vessels course and speed is made easier.



Before selecting a target



Speed and course vector

AIS (Automatic Identification System)

AIS Target Tracking

When connecting a FURUNO FA30/50/170 AIS unit to your NavNet series devices, up to 100 AIS targets can be tracked and displayed on the Radar screen. The Automatic Identification System (AIS) improves safety during travel by sharing the status and position of your vessel with other AIS-equipped vessels nearby. You can easily read detailed information about AIS-equipped vessels nearby such as speed, heading.

AIS Display

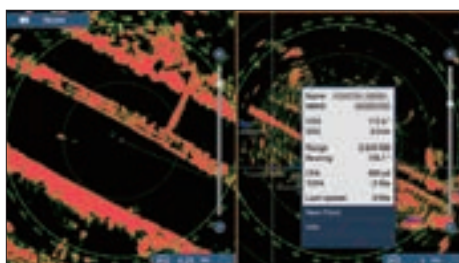

CPA graphic display

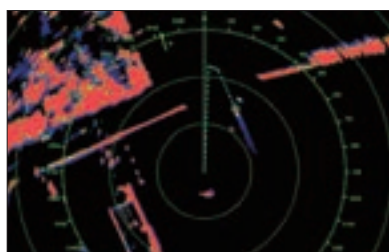

The Closest Point of Approach (CPA) graphic display shows the CPA between own vessel and the selected AIS (or TT) target with a line, called the "CPA line". You can use the line to monitor speed and heading changes of another vessel, which makes it useful as an anti-collision aid, especially in congested waters.

* Own ship and position data required.



Model FA170

»» Spec P105



Model FA30/50

»»» Spec P105

DIGITAL RADAR SENSORS

DRS4D-NXT, the NXT leap in Radar technology!

A solid-state Radar with pulse compression, Target Analyzer and Fast Target Tracking™ utilizing Doppler technology. Combined with FURUNO's exclusive RezBoost™ technology, the DRS4D-NXT packs the performance of an open array radar, in a compact 24" radome.



SOLID STATE DOPPLER RADAR
Model DRS4D-NXT



- NXT, Solid-State pulse compression Doppler Radar
- Revolutionary Target Analyzer function instantly identifies hazardous targets
- Fast Target Tracking™, up to 100 targets
- RezBoost™ beam sharpening, equivalent to 2 degree beam width open array
- Compact 24" radome with 25 W output power (equivalent to 4 kW magnetron)
- Bird Mode, track birds to find the best fishing grounds
- Simple installation, no need to open the radome, external PSU is not required
- New smart-connector cable for retro fitting existing DRS cable installations
- No warm-up time

▶▶▶ Spec P74



Target Analyzer function utilizing Doppler technology spots hazardous targets instantly!

The DRS4D-NXT is the first radar in the world to use the new FURUNO exclusive Target Analyzer function. Targets that are approaching your vessel automatically change color to help you identify when they are hazardous. Green echoes are targets that stay stationary, or are moving away from you, while red echoes are hazardous targets that are moving towards your vessel.

Hazardous targets are displayed in bright red

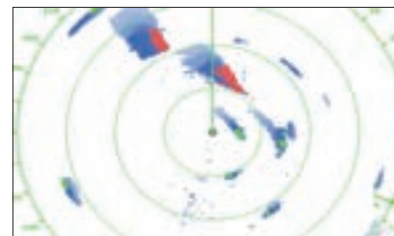

Echoes dynamically change colors as targets approach, or get farther away from your vessel. Target Analyzer improves situational awareness and can increase safety by showing you which targets to look out for.

Fast Target Tracking™ function!

It only takes a few seconds, from when a target is selected, to display a speed and course vector. With accurate tracking information, estimation of other vessel's course and speed is greatly simplified. With Doppler technology, any vessel approaching yours will automatically display a target vector as well as sound an alarm*. Up to 100 targets can be displayed simultaneously.

* CPA/TCPA setting is required.

Approaching vessel with target vector

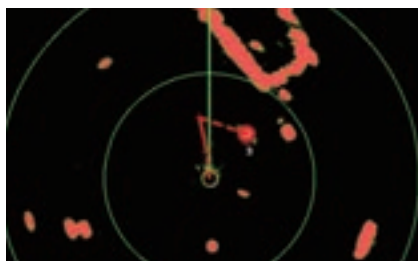

RezBoost™ beam sharpening



For the first time FURUNO exclusive RezBoost™ technology is used in one of our Radar units, with impressive performance. With RezBoost™, you'll see more detailed targets, with less clutter.

RezBoost™ standard

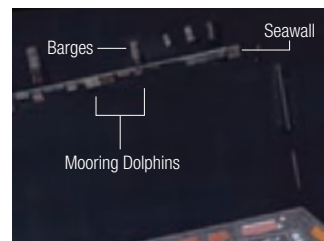
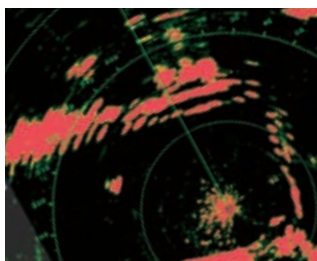

RezBoost™ Enhanced, MAX setting

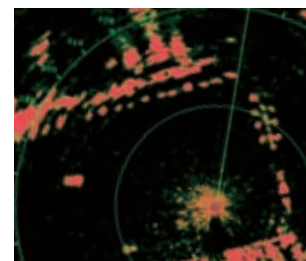

DRS X-Class Series, a whole new class of Radars!

Pushing the boundaries of what is possible with conventional Radar technology, DRS X-Class Series mark yet another leap forward for FURUNO. Improved in almost all aspects, DRS X-Class Radars feature improved short range detection as well as an impressive long range detection of up to 96 nautical miles.



- Enhanced target detection, both short and long range
- Minimum detection range of 20 m approx.
- Fast Target Tracking™
- Bird Mode, track birds to find the best fishing grounds
- New pedestal unit, 20 % lighter than previous DRS Series unit, updated low noise motor

RADAR SENSOR

Model **DRS6A X-Class**

Model **DRS12A X-Class**

Model **DRS25A X-Class**



»» Spec P75

Bird Mode

DRS4D-NXT and DRS X-Class Series feature a new bird mode that helps you identify birds congregating around schools of fish at the sea surface. Bird mode works by adjusting the gain and sea settings automatically for optimal visibility.

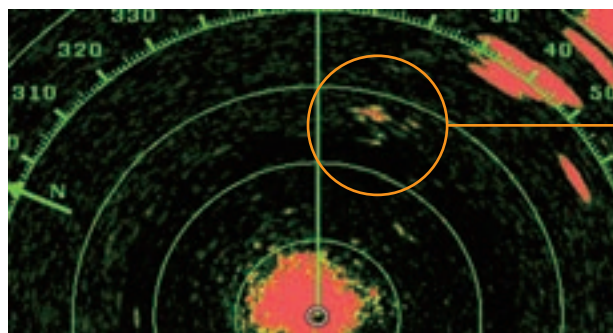

Bird echoes



Actual scene

Impressive performance at long range (24 NM)

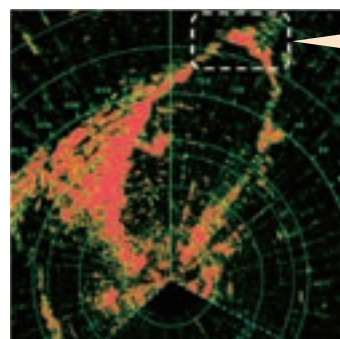

NavNet TZtouch

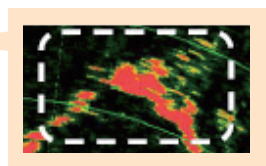

Conventional

Short range detection

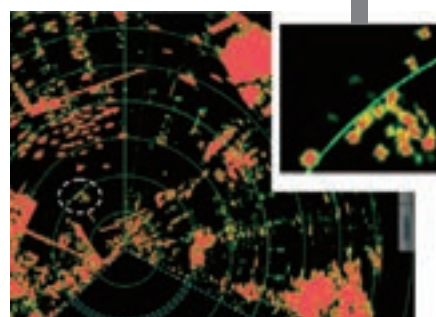

NavNet TZtouch



Sailing dinghies in highly detailed echoes at short range

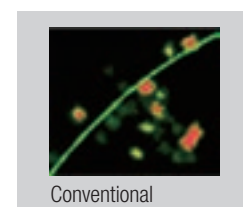

Conventional

MULTI-BEAM SONAR

Innovative tool for exploring wide range of water column and seabed

New Multi-Beam Sonar model DFF3D gives you real-time 120 port-starboard view of the water column and seabed up to 200m depth*. The DFF3D allows you to explore fishing spots and find fish in deep water by far faster than conventional single beam sounders. On the other hand, the main beam penetrate right under the boat at a depth of approximately 300 m*. Installation is made easy, thanks to a compact transducer design. The built-in motion sensor in the transducer stabilizes the display to give clear and stable images, even under rough sea conditions.

* Maximum depth depending on water, bottom type and other water conditions.

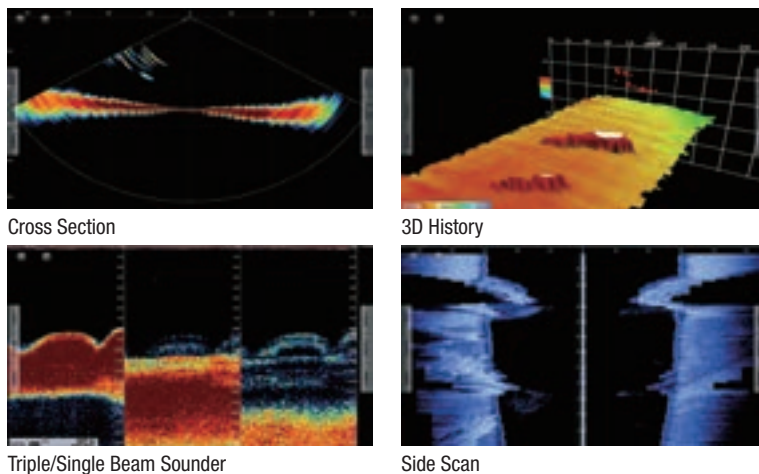

Triple/Single Beam Sounder

Side Scan

	DFF3D
Frequency	165 kHz
Range Scale	Up to 1,200 m
Detection Range	200 m* (Side beam best performance) 350 m* (Main beam directly under boat)
ACCU-FISH	N/A
Bottom Discrimination	N/A
Transducer	800 W

* Depending on bottom type and water conditions.

NEW



BLACK BOX NETWORK MULTI-BEAM SONAR Model DFF3D

Spec P73



* System version requirement for NavNet series:
NavNet TZtouch (TZ19/TZ114/TZ1BB) version 5.01 or later
NavNet TZtouch2 (TZ1L12F/TZ1L15F) version 5.01 or later

- Side Scan detection range is up to 200 m in a 120-degree swath port and starboard direction*
- Deep water, main beam penetration directly under the boat is approx. 300 m*
- The built-in motion sensor (standard supply) stabilizes the display to give clear and stable images even under rough sea conditions
- Compact thru-hull transducer allows easy installation
- Customize the display according to your needs
 - Depending on the situation and preference, a combination of screen modes can be displayed

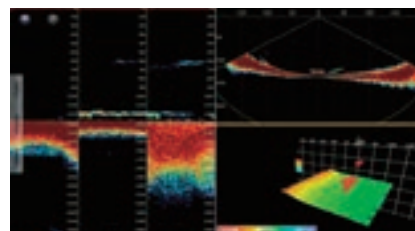

Combination display of Triple Beam Sounder/ Cross section/3D Sounder History on NavNet TZtouch

Transducer (with motion/temperature sensor)



B54

Scanning image of Multi-Beam Sonar

Coming in spring.

FDF™ DIGITAL FISH FINDER

Find More Fish With a TruEcho CHIRP™ Fish Finder

An advanced technology for both professional and enthusiast fishermen. Designed to operate across a wide range of frequencies utilizing a broadband transducer, the TruEcho CHIRP™ network fish finder delivers significant advantages in signal clarity and target definition. Due to the constant sweep of frequencies the TruEcho CHIRP™ network fish finder is capable of gathering more, higher quality data than a traditional single frequency fish finder. The clear presentation marks individual game fish and bait fish, even when tightly schooled together.

- Designed to operate over a broadband range of frequencies utilizing a broadband transducer
- Clear presentation separates bottom structure from bottom fish, and bait fish from game fish
- Network fish finder for NavNet Series devices*

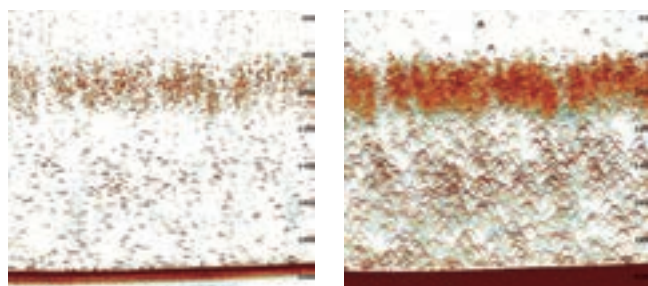

High Frequency CHIRP

Low Frequency CHIRP

	DFF1-UHD
Frequency	Dual frequency 50 ± 20 & 200 ± 25 kHz
Range Scale	Up to 1,200 m
Broadband	Available
ACCU-FISH	Available
Bottom Discrimination	Available
Transducer	1 kW



BLACK BOX NETWORK FISH FINDER
Model DFF1-UHD



»» Spec P72



Broadband Transducers*



CM265LH/CM275LH-W



B265LH/B275LH-W

* Local supply

ACCU-FISH™ (Fish Size Analyzer)



FURUNO's award winning network fish finders (DFF1-UHD/DFF1/DFF3/BBDS1) offer a unique fish size analyzer function, ACCU-FISH™.

The ACCU-FISH™ algorithm analyzes echo returns in order to compute individual fish size. The algorithm is capable of computing fish size ranging from 10 cm up to 199 cm long. Fish depth can also be displayed.

In some instances, fish size indicated on the NavNet may differ from its actual size. Please carefully read the operator's manual prior to utilizing this feature. ACCU-FISH™ is capable of detecting individual fish at the depth of 2 m to 100 m (DFF1/DFF3/BBDS1), 2 m to 200 m (DFF1-UHD) and computing the fish size of those ranging from 10 cm to 199 cm.

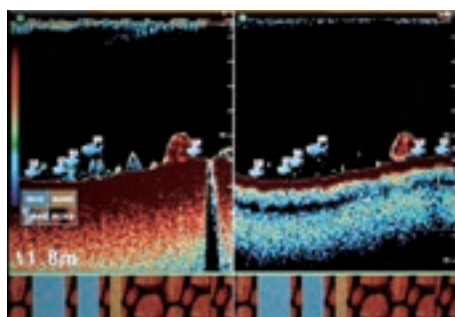

NavNet 3D

Bottom Discrimination Display

With the DFF1-UHD or BBDS1, NavNet Series devices can show bottom discrimination, displayed in four different categories. The bottom discrimination function provides you with valuable information to help you locate rich fishing grounds to boost the day's catch. There are two bottom discrimination display modes selectable:

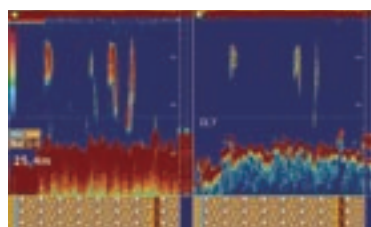

Rocks Gravel Sand Mud

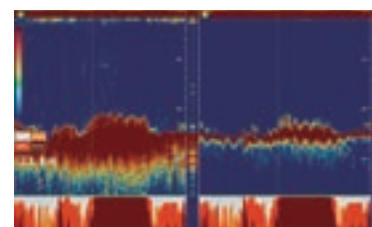

Rocks Gravel Sand Mud

Graphic mode

The standard graphic display mode shows the most probable bottom composition by graphic or four colors.

Probability mode

The probability display mode shows the most probable bottom composition in graph form.

Please keep the following in mind when using the Bottom Discrimination Sounder:

- 1) Use at a depth of 5 m - 200 m (DFF1-UHD), 5 m - 100 m (BBDS1).
- 2) Use transducer in transom mount or thru-hull mount.
- 3) To show a consistent display of the actual bottom, set the range display of the fish finder screen to "auto".
- 4) Enter the ship's draft value.
- 5) Use a ship speed of 10 kn or less.
- 6) In some instances, bottom component indicated on the display may carefully differ from its actual bottom structure.

FDF™ DIGITAL FISH FINDER

FURUNO Digital Filter (FDF™) Fish Finder



FURUNO's DFF1, DFF3, BBDS1 and DFF1-UHD feature FURUNO Digital Filter (FDF™) technology. These digital network fish finders can turn any NavNet display into a powerful, dual frequency digital fish finder.

The main difference between digital and conventional fish finders lies in the filtering capabilities and auto adjustments. Our award winning FDF™ technology helps to optimally adjust gain, STC (Clutter) and output power as well as suppress surface clutter. It also makes the picture clearer and easier to decipher.

However, even the best digital filter won't help unless you start with a solid basis, such as FURUNO's renowned fish finder technology, which has made FURUNO the best friend of professional fishermen for years.



**BLACK BOX
BOTTOM DISCRIMINATION SOUNDER**
Model **BBDS1**



**BLACK BOX
NETWORK FISH FINDER**
Model **DFF1**



**BLACK BOX
NETWORK FISH FINDER**
Model **DFF3**



»» Spec P72

- Enhanced detection of fish echoes by FURUNO Digital Filter (FDF™) Fish Finder technology
- Selectable display modes include High or Low Frequency, Dual Frequency, Zoom, Nav Data, A-Scope, Marker Zoom, Bottom Zoom or Bottom-Lock
- FURUNO Free Synthesizer transceiver to let you choose any two operating frequencies from 28 to 200 kHz (DFF3 only)
- Audio and visual alarms alert you whenever preset limits are met for water depth, water temperature and fish echoes
- Two selectable automatic gain control modes: Cruising and Fishing modes to match your boating purposes
- New Bottom Discrimination Display mode available (DFF1-UHD/BBDS1)
- IP address is automatically assigned for Plug and Play installation

	DFF1	BBDS1	DFF3
Frequency	Dual frequency 50 kHz and 200 kHz		The synthesized transducer works with dual frequencies between 28 and 200 kHz
Range Scale	Up to 1,200 m		Up to 3,000 m
ACCU-FISH	Available*		
Bottom Discrimination	N/A	Available	N/A
Transducer	600 W/1 kW		1/2/3 kW

* For DFF3, with 50/200-IT transducer only.

FURUNO Free Synthesizer (FFS) transceiver on the DFF3 allows you to choose any two frequencies from 28 to 200 kHz



FURUNO's Free Synthesizer (FFS), a feature developed for the professional fish finder FCV-1200L, is utilized for the DFF3 transceiver. FFS allows you to operate a fish finder in any of the two operating frequencies from 28 to 200 kHz without using a matching box. The FFS gives you the freedom to choose your operating frequencies for more productive fishing. Output power of the DFF3 can also be selected among 1, 2 and 3 kW to suit a variety of situations.

Adding a New Dimension to 3D

The world of onboard navigation systems has evolved. Never before has so much information been available to you to improve and enhance your boating experience. FURUNO is the world's first brand that delivered the most intuitive integrated navigation solution to you.



Shown in Extended Mode with Optional Marine Display Model MU190HD



MULTI FUNCTION DISPLAY BLACK BOX Model MFDBB

»» Spec P71

- TimeZero™ technology for seamless chart redraw, zooming and chart handling with no lag time
- Easy-to-use RotoKey™ interface
- Unlimited range scales for zooming
- Dedicated 3D key allows you to easily toggle between 2D & 3D
- More than 10,000 ship's track points and over 2,000 waypoints
- 200 planned routes, with up to 100 waypoints/route
- Provides Extended Mode operation across two displays with a single processor – perfect for either side-by-side or up-down (Pilothouse & Flybridge) installations

- True 3D chart architecture
- True color depth shading utilizing bathymetric data
- Preloaded tides & currents
- Alternating video & data boxes
- Engine Monitoring
- AIS target tracking when connected to an AIS receiver
- Optional 12 kW or 25 kW Digital Radar Sensors
- Optional Network Fish Finder Sensors
- Wide variety of other options such as Instruments, Autopilot, Weatherfax, etc.

DIGITAL RADAR

		DRS12A	DRS25A
Output Power		12 kW	25 kW
Size		4 ft/6 ft Open	4 ft/6 ft Open
Beam Width	Horizontal	1.9°/1.4°	1.9°/1.4°
	Vertical	22°/22°	22°/22°
Max. Range		120 NM	120 NM



Model DRS25A

Model DRS12A



Winner of the NMEA awards 2008/2009/2010/2011 2012/2013/2014

NavNet series NETWORK / PRODUCTS LINEUP



RADAR

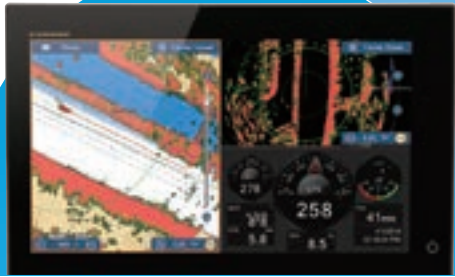

Radar Sensor



DRS4DL



DRS4D-NXT



DRS6A X-Class

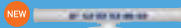

DRS12A X-Class



DRS25A X-Class

Ethernet

FISH FINDER



INTERNAL

External Fish Finders can also be connected to the TZtouch2. The internal and external Fish Finder cannot operate simultaneously. You can select which one to use from the settings menu.



NEW Multi-Beam Sonar
DFF3D

Ethernet

Network Fish Finder
DFF1-UHD/DFF1/DFF3

Ethernet

Bottom Discrimination Sounder
BBDS1

Ethernet

AIS



AIS Receiver
FA30

Ethernet



Class-B AIS Transponder
FA50

Ethernet



U-AIS Transponder
FA170

Ethernet NMEA0183

GPS



INTERNAL

External GPS antennas and navigators can also be connected to NavNet TZtouch2. You can select which one to use from the settings menu.



GPS/WAAS
Receiver Antenna
GP330B

CAN bus



GPS Navigator
GP33

CAN bus NMEA0183



Marine Radar
FAR21x7BB Series

Ethernet



Radar Sensor

DRS4DL

DRS4D-NXT

DRS6A X-Class

NEW DRS12A X-Class

NEW DRS25A X-Class

Ethernet



NEW Multi-Beam Sonar
DFF3D

Ethernet

Network Fish Finder
DFF1-UHD/DFF1/DFF3

Ethernet

Bottom Discrimination Sounder
BBDS1

Ethernet



Color LCD Sounder
FCV1150

Ethernet



AIS Receiver
FA30

Ethernet



Class-B AIS Transponder
FA50

Ethernet



U-AIS Transponder
FA170

Ethernet NMEA0183



GPS/WAAS Antenna
BBWGPS

NMEA0183



GPS/WAAS
Receiver Antenna
GP330B

CAN bus NMEA0183



GPS Navigator
GP33

CAN bus NMEA0183

INSTRUMENT

AUTOPILOT

COMPASS

WEATHER FAX
PC PLOTTER

SENSOR

OTHERS

 <p>FI 70 CAN bus</p>	 <p>NAVpilot 700 CAN bus NMEA0183</p>  <p>NAVpilot 711C CAN bus NMEA0183</p>	 <p>Integrated Heading Sensor PG700 CAN bus</p>  <p>Satellite Compass SC30 SC50 CAN bus NMEA0183</p>	 <p>Network Weather Facsimile Receiver FAX30 Ethernet</p> <p>PC</p>  <p>TIMEZERO Marine Software Ethernet</p>	 <p>Depth/Speed/Temp Sensor DST800 CAN bus</p>	 <p>Analog Camera Video</p>  <p>FUSION Marine Entertainment System MS750 Series, etc. Ethernet</p>  <p>Digital switching System CAN bus</p>
---	--	--	--	--	--

NMEA0183 to CAN bus converter available

The optional IF-NMEA2K2 converts NMEA0183 sentences to FURUNO CAN bus PGNs, enabling conventional NMEA0183 navigation devices to be incorporated into the NavNet TZtouch2/TZtouch network.

 <p>FI 70 CAN bus</p>	 <p>NAVpilot 700 CAN bus NMEA0183</p>  <p>NAVpilot 711C CAN bus NMEA0183</p>	 <p>Integrated Heading Sensor PG700 PG500R CAN bus NMEA0183</p>  <p>Satellite Compass SC30 SC50 CAN bus NMEA0183 NMEA0183</p>	 <p>Network Weather Facsimile Receiver FAX30 Ethernet</p> <p>PC</p>  <p>TIMEZERO Marine Software Ethernet</p>	 <p>Depth/Speed/Temp Sensor DST800 CAN bus</p>	 <p>Analog Camera IP Camera Video Ethernet</p>  <p>FUSION Marine Entertainment System MS750 Series, etc. Ethernet</p>
---	--	---	--	--	---

* NMEA0183 to CAN bus converter available

The optional IF-NMEA2K2 converts NMEA0183 sentences to FURUNO CAN bus PGNs, enabling conventional NMEA0183 navigation devices to be incorporated into the NavNet TZtouch2/TZtouch network.

** All CAN bus devices can be incorporated into the NMEA2000 network.



We have won the Best Radar award for 41 years
— FURUNO is the benchmark in Radar technology.

The name FURUNO is synonymous with Radar and when a FURUNO Radar is on your boat, everyone in the harbor knows that you demand only the best for your vessel.

Our comprehensive Radar product line accommodates any size and type of vessel: compact LCD Radar for a small sailing yacht, high-end LCD Radar for massive tankers and everything in between. Every FURUNO Radar is made with commercial grade components, so you can rest assured that your Radar will withstand anything that Mother Nature can dish out. With our superb target detection, you can bet that our Radar can see through anything she throws at it as well.

Radar

DRS4W

MODEL1623

MODEL1715

MODEL1815 NEW

MODEL1835/1935/1945

FR8065/8125/8255

FAR1513/1523BB

FAR1518/1528BB

FAR2117BB/2127BB/2137SBB

WIRELESS RADAR

1ST WATCH WIRELESS RADAR
Model **DRS4W**



- 4 kW Radar antenna, powerful yet compact in size
- Wireless LAN, first Radar in the world accessible from your iOS devices
- No extra wiring needed except the power source, making installation a breeze
- Easy and quick operation
- Simple touch interface with familiar gestures
- User selectable range scale from 0.125 to 24 NM

- Guard zone alarm available with updated Radar App ver. 2.0.0.
- Two iOS devices – simultaneous operation
- With image quality that matches that of a conventional 10" LCD wired Radar, the DRS4W will impress you
- With TIMEZERO Marine Navigator (TZ App), providing the overlay radar image across the App's navigational chart on your iPad in real-time*

* Radar Module (in-app purchase) required.

Guard Zone

Adjust the size and area of the guard zone by dragging the circles. Once the guard zone is activated, your iPad or iPhone will alert you whenever a target enters or leaves the guard zone.

* Radar App ver. 2.0.0 required.

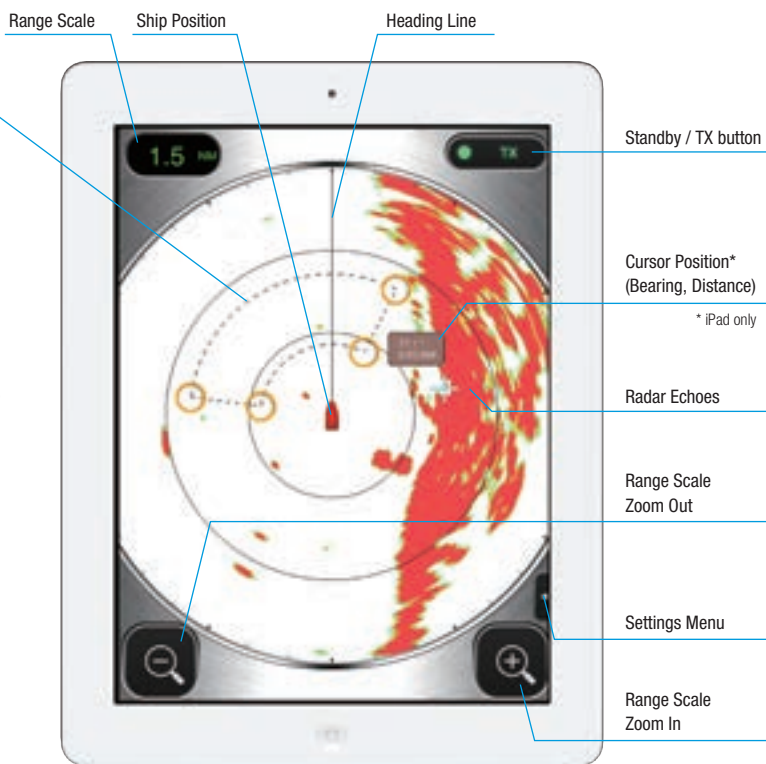

	Radar App	Simulator App*
App version	2.0.0	Simulator_2.0.2
Compatible iOS	Up to iOS9	
Language	English	



* Simulator App will help you learn how to use Marine Radar DRS4W in an off-line environment before you navigate with the DRS4W onboard.

>>> Spec P77

MARINE RADAR



7" SILVER LCD RADAR
MODEL1715



6" SILVER LCD RADAR
MODEL1623

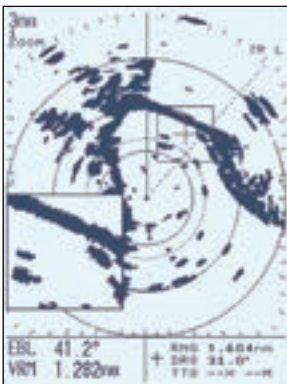

Zoom

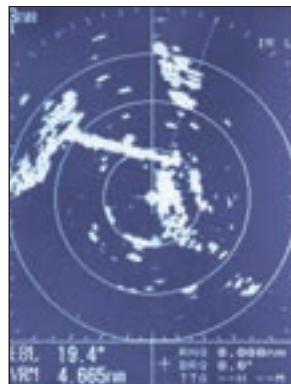

Reverse

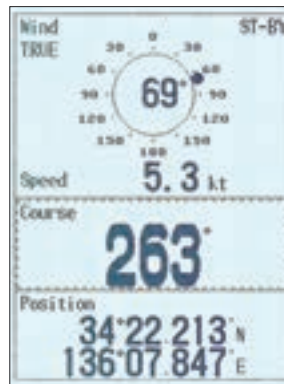

NAV Data

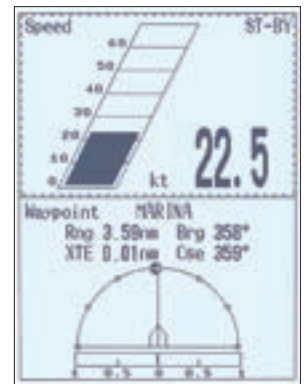

NAV Data

- Exceptional short range target detection achieved by narrow pulselength and dual IF bandwidth
- Automatic adjustment of antenna rotation speed according to selected range scale for optimum performance on all ranges
- Low power consumption in the Watchman mode — only 8 W
- Display a “lollipop” indication of selected waypoint position (optional input required)
- Excellent screen clarity - day or night
- Reverse video feature for quality nighttime visibility
- Zoom window for close observation of a specific area
- Intuitive operation with simple key layouts

Antenna Selections

Model	MODEL 1623	MODEL 1715
Output Power (kW)	2.2	2.2
Size	15" Radome	18" Radome
Range Scale (NM)	0.125-16	0.125-24
Rotation Speed	24/31/41 rpm	

NEW



8.4" COLOR LCD RADAR
MODEL1815

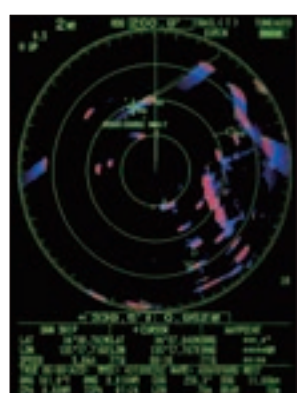
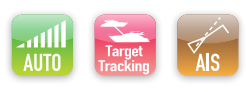

AIS/Fast Target Tracking™

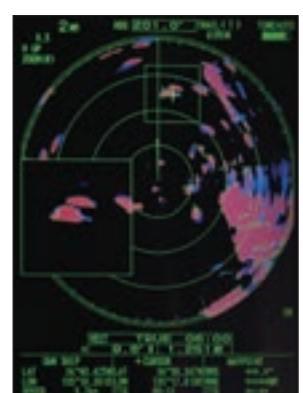

Zoom

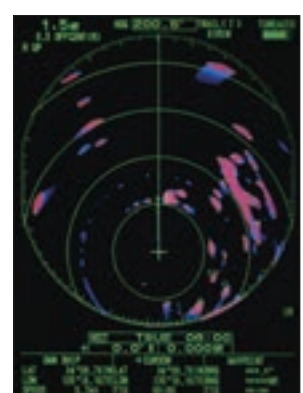

Off center

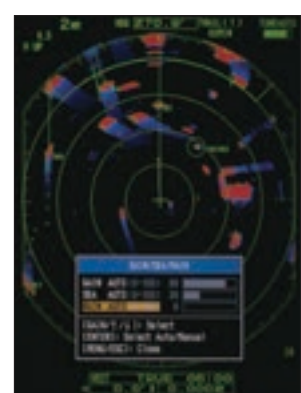

Gain/Sea/Rain setting menu

- Compact radome antenna with 4 kW transmitter output power
- Low power consumption of 38 W at the most
- Easy installation and intuitive operation
- Advanced auto-adjust settings for Gain/Sea clutter/Rain clutter
- Fast Target Tracking™(TT), a target's speed and course vector is displayed in just a few seconds after a TT target is acquired
- True trail mode, moving objects will show up on the main screen with a colorful trail
- True view mode based on the head-up mode reduces the discrepancy between an observed target and what is displayed on the radar
- Echoes in yellow, green, orange or multiple colors
- User-programmable function keys
- Swivel mounting bracket to adjust the angle of the display unit

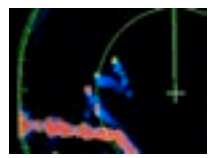

True trail

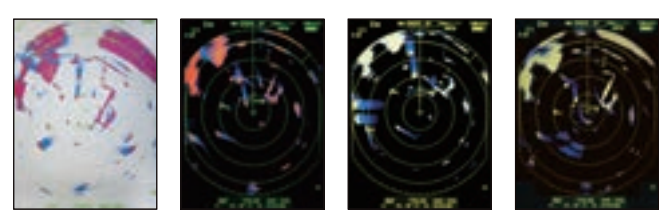

Adjustable display colors

Antenna

Model	MODEL 1815
Output Power (kW)	4
Size	19" Radome
Range Scale (NM)	0.0625-36
Rotation Speed	24 rpm

»»» Spec P78



10.4" LCD Radar
MODEL1835/1935/1945



- Easy-to-install 10.4" portrait color LCD (350 cd/m²) display
- Bonded LCD provides clear view in all weather conditions
- Stable AIS/TT* with zoom display function
- Full Screen Mode lets operators observe a wider range around the vessel
- Enhanced auto tuning/gain/anti-clutter controls
- Echoes in yellow, green, orange or multiple colors

* Optional supply required

AIS/TT Display*

Up to 100 AIS and 10 TT targets can be tracked and overlaid on the Radar screen to assist the operator in tracking vessel movements. Since AIS works by a VHF transceiver system, a variety of navigational information such as vessel name, speed, course, ROT, length and beam can be included in real time. Unlike TT targets, AIS targets are visible even if they are located behind large ships or islands.

* Optional sensors required

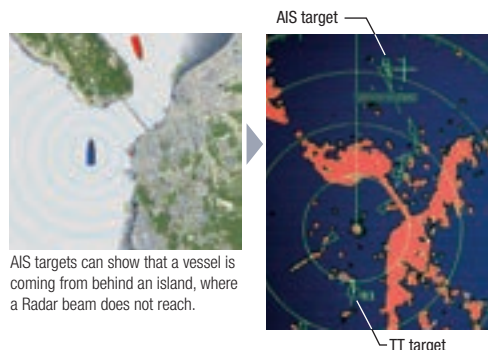

AIS targets can show that a vessel is coming from behind an island, where a Radar beam does not reach.

Off Center Mode

With a push of the "OFF CENTER" button, own ship position is shifted to a pre-registered point on the screen. This allows the operator to focus on a specific area ahead of or around the vessel without losing track of the position.

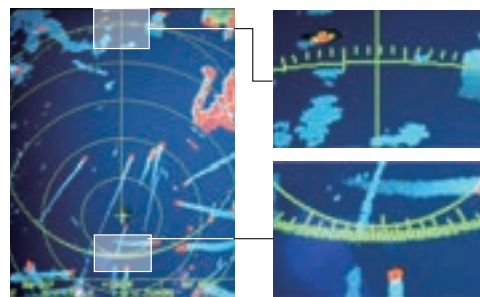

Clearance between markings of the bearing scale is changed according to the proximity between own ship and the bearing circle, as shown in the images on the left-hand side. It helps to grasp the bearing to the target echo without using an EBL.

Antenna Selections

Model	MODEL 1835	MODEL 1935	MODEL 1945
Output Power (kW)	4	4	6
Size	24" Radome	3.5' Open	4' Open
Range Scale (nm)	0.0625-36	0.0625-48	0.0625-64
Rotation Speed	24 rpm	24 rpm 48 rpm (option)	



12.1" LCD MARINE RADAR
Model FR8065/8125/8255



* FR8065

2015

The 12.1" color radar FR8005 series features state of the art signal processing, which makes it easier to identify targets in heavy rain and poor visibility. The FR8005 radar can discern between rain and surface reflections, providing the ability to find and track the movement of rain clouds as well as removing unnecessary echoes. For tracking the movement of other vessels at sea, "True Motion Trails" can be displayed as well as AIS/TT target-tracking with a zoom display function. When the vessel is in motion, the radar echoes move smoothly on the main display thanks to the "True View Mode".

- One-touch auto-adjust settings for Gain/Sea clutter/ Rain clutter
- 48 rpm high-speed antenna rotation. Displays information clearly in narrow passages and on high-speed vessels
- Wide viewing angle LCD for great visibility from any direction

Advanced Signal Processing

Even during rainfalls or severe weather conditions, radar echoes are clearly displayed, and unnecessary echoes can be removed instantly with ease. Compared with current radars (FR8002 series) the technology for removing sea, rain and snow clutter has been greatly enhanced utilizing FURUNO's state of the art knowledge in digital signal processing.

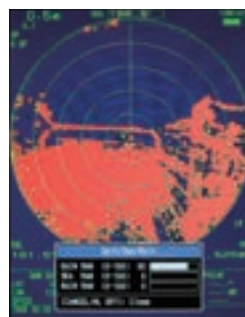

A/C Rain turned off, the marina is completely covered by the rain echo.



A/C Rain turned on, the marina appears clearly.

Target-Tracking Zoom Display Function

When using the Target mode, vessels close by and vessels on intersecting courses are automatically displayed zoomed in. These targets will remain displayed for as long as they pose any concern. Target Trails are also displayed, making it easy for the user to determine the movements of individual vessels.

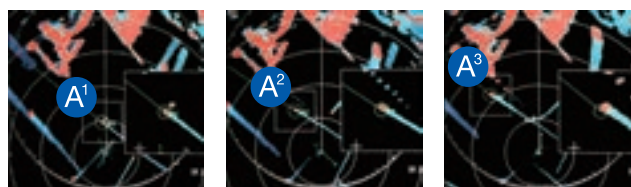

Time passes

* AIS transponder and ARP-11 are required to use the zoom display function



Photo: 15" Marine Display
MU-150HD (Optional supply)

BLACK BOX MARINE RADAR
Model **FAR1513/1523BB**



- FAR1513/1523BB Marine Radar features advanced functionality in a small and easy to use package
- Accurately track other vessels in order to avoid collisions with FURUNO's innovative new Fast Target Tracking™ functionality
- Target Analyzer, discern hazards simply by looking at the color of their echo
- Improved sea and rain clutter removal function.
 - Automatic Clutter Elimination (ACE) function provides clear echoes.
- Instant speed vector display for tracked targets
 - A speed vector will be displayed after clicking on a select target.
- AIS compatible out of the box
 - Targets are automatically acquired and information can be displayed on-screen easily.

Automatic Clutter Elimination (ACE) for unprecedented echo clarity

Quickly adjust the radar image with the push of a single button. With ACE activated, the system automatically adjusts clutter reduction filters and gain control according to sea and weather conditions selected by the user (calm/rough sea/hard rain).

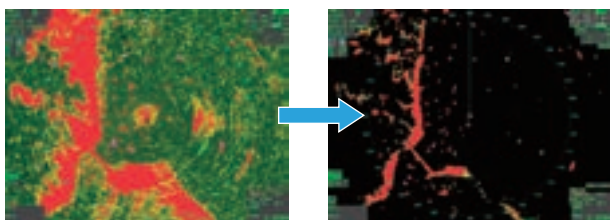

Automatic Clutter Elimination (ACE) OFF

Automatic Clutter Elimination (ACE) ON

Easy to operate control unit

Simple and efficient operation is made possible with individual knobs for setting gain/rain/sea clutter suppression, as well as a RotoKey and touchpad. The optional trackball unit, as well as a regular USB mouse, can also be used.



Control Unit



Optional Trackball Control Unit

Fast Target Tracking™ (TT)

After selecting a target, it only takes a few seconds for a speed and course vector to be displayed. With accurate tracking information, estimation of other vessels course and speed is made easier.

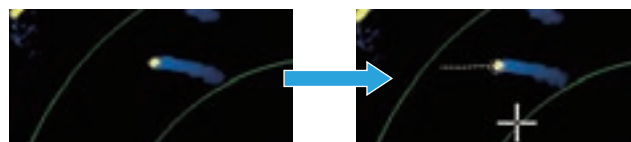

Before selecting a target

Speed and course vector

Target Analyzer function



Target Analyzer function displays moving target, stationary targets, rain, sea surface and targets closing in on your vessel in different colors. Spot hazardous targets directly, simply by the color they are displayed in. Target Analyzer can increase safety as well as improve situational awareness.



Antenna Selections

Model	FAR1513	FAR1523
Output Power (kW)	12	25
Size	4/6.5/8	
Range Scale (NM)	0.125-96	
Rotation Speed	24/48 rpm	

»»» Spec P81



- FAR1518/1528BB Marine meets the criteria for IMO certification of vessels below 500 GT
- Accurately track other vessels in order to avoid collisions with FURUNO's innovative new Fast Target Tracking™ (TT) functionality
- Improved sea and rain clutter removal function.
 - Automatic Clutter Elimination (ACE) function provides clear echoes
- Instant speed vector display for tracked targets
 - A speed vector will be displayed shortly after clicking on a select target.
- AIS compatible out of the box
 - Targets are automatically acquired and information can be displayed on-screen easily.
- Low noise, large dynamic range antenna unit
- FAR15x8 Series can be overlapping display radar echoes on external ECDIS and GPS plotter screen

Photo: 15" Marine Display MU150HD (Optional supply)

BLACK BOX MARINE RADAR
Model **FAR1518/1528BB**



Automatic Clutter Elimination (ACE) for unprecedented echo clarity

Quickly adjust the radar image with the push of a single button. With ACE activated, the system automatically adjusts clutter reduction filters and gain control according to sea and weather conditions selected by the user (calm/rough sea/hard rain).

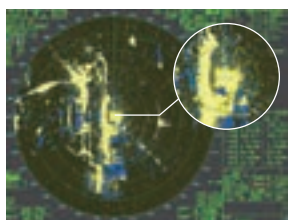

Automatic Clutter Elimination (ACE) OFF

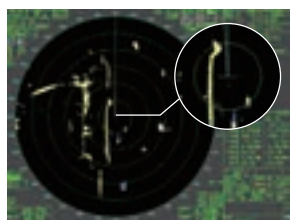

Automatic Clutter Elimination (ACE) ON

Easy to operate control unit

Simple and efficient operation is made possible with individual knobs for setting gain/rain/sea clutter suppression, as well as a RotoKey and touch panel. The optional trackball unit, as well as a regular USB mouse, can also be used.



Control Unit



Optional Trackball Control Unit

Fast Target Tracking™ (TT)

After selecting a target, it only takes a few seconds for a speed and course vector to be displayed. With accurate tracking information, estimation of other vessels' course and speed is made easier.

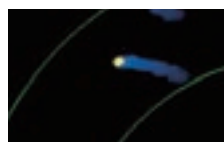

Before selecting a target



Speed and course vector

Scalable Ethernet Network System

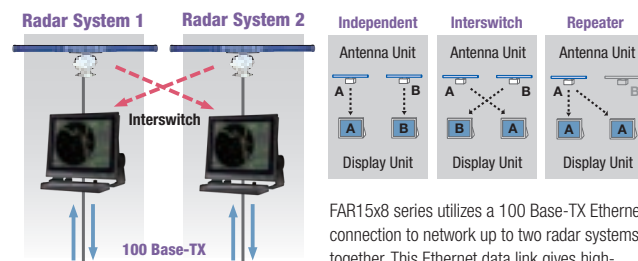

FAR15x8 series utilizes a 100 Base-TX Ethernet connection to network up to two radar systems together. This Ethernet data link gives high-speed and stable navigational data sharing for interswitching as well as sharing data between ECDIS and GPS plotters.

Antenna Selections

Model	FAR1518	FAR1528
Output Power (kW)	12	25
Size	4'/6.5'	6.5'/8'
Range Scale (NM)	0.125-96	
Rotation Speed	26/48 rpm	

»»» Spec P82



12 ft antenna for FAR2137SBB



8 ft antenna for FAR2117BB/2127BB

Photo: 19" Marine Display MU-190HD (Optional supply)

BLACK BOX MARINE RADAR*
Model FAR2117BB/2127BB/2137SBB



2016

*Any SXGA display is connectable

- Superb detection of small targets
- S-band to achieve stable detection under all weather conditions (FAR2137SBB)
- Advanced signal processing to present crystal clear images in rough sea
- Automatic target tracking of 100 manually or automatically acquired targets
- Handles up to 1,000 AIS targets (separate AIS receiver required)
- Straightforward operation by using a trackball and a wheel menu selector
- Up to four sets of radar can be interconnected in a network and share images, without the need of extra devices



Trackball Control Unit

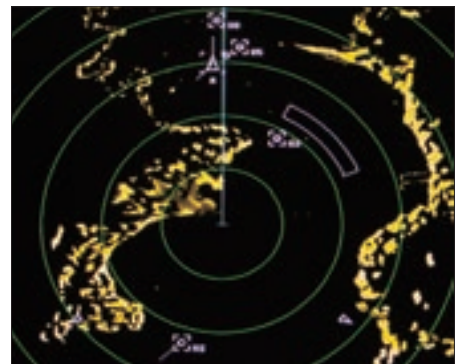

AIS/TT



Processor Unit

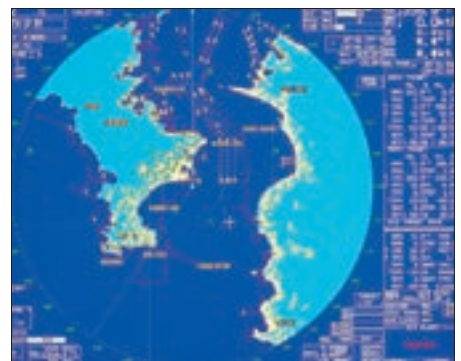

Chart Overlay

Antenna Selections

Open Array	X-band radar		S-band radar
	FAR2117BB	FAR2127BB	FAR2137SBB
Output Power (kW)	12	25	30
Size (ft)	4/6.5/8		10/12
Range Scale (NM)	0.125-96		



BLACK BOX CHART RADAR
Model **FAR3000**

- Available X-Band (12/25kW) or S-Band (30kW or Solid State 250W)
- 4', 6.5' or 8' Open Array (X-Band) or 12' Open Array (S-Band)
- "Deep Sea" Radar
- Newly designed, aerodynamic antennas with enhanced durability
- Less maintenance through DC brushless motor
- Ethernet link between scanner unit and BDU eliminates loss of signal between antenna and processor
- Advanced Furuno technology with new features, such as Automatic Clutter Elimination (ACE)
- Improved Target Tracking function requires only seconds and tracks even high-speed and rapidly maneuvering vessels
- Optional LAN Signal Converter enables users to extend the cable between antenna unit and processor unit or to utilize the existing cables when retrofitting
- Advanced Interference Reduction (IR) function
- Common sensor adaptor makes installation and maintenance simple
- Complies with EC62388 Ed. 2.0, IEC61174 Ed. 3.0, IEC62288, IEC61162-1 Ed. 4.0, IEC61162-2



Chart overlay on radar presentation

By overlaying radar presentation and chart map, you can easily recognize coastlines and buoys at a glance. Records of your vessel's track points and waypoints will help memorize fishing points. When the chart radar presentation and chart map are overlaid, North-Up, Course-Up, and Head-Up direction modes will be available.

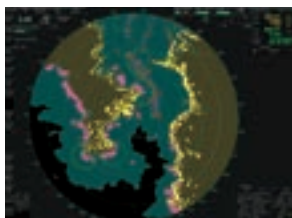

Target Analyzer function



Target Analyzer function displays moving target, stationary targets, rain, sea surface and targets closing in on your vessel in different colors. It can increase your safety as well as improve situational awareness.

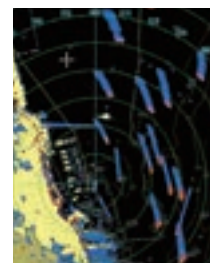

Automatic Clutter Elimination (ACE) for unprecedented echo clarity

Quickly adjust the radar image with the push of a single button. With ACE activated, the system automatically adjusts clutter reduction filters and gain control according to sea and weather conditions selected by the user (calm/rough sea/hard rain).

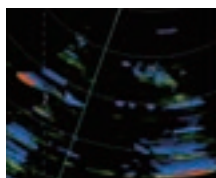

Automatic Clutter Elimination (ACE) OFF



Automatic Clutter Elimination (ACE) ON

Fast Target Tracking™ (TT)

After selecting a target, it only takes a few seconds for a speed and course vector to be displayed. With accurate tracking information, estimation of other vessels course and speed is made easier.

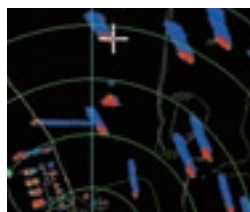

Before selecting a target



Speed and course vector



A new Solid State S-band transceiver generates clear echo images, even from weak targets and small craft.

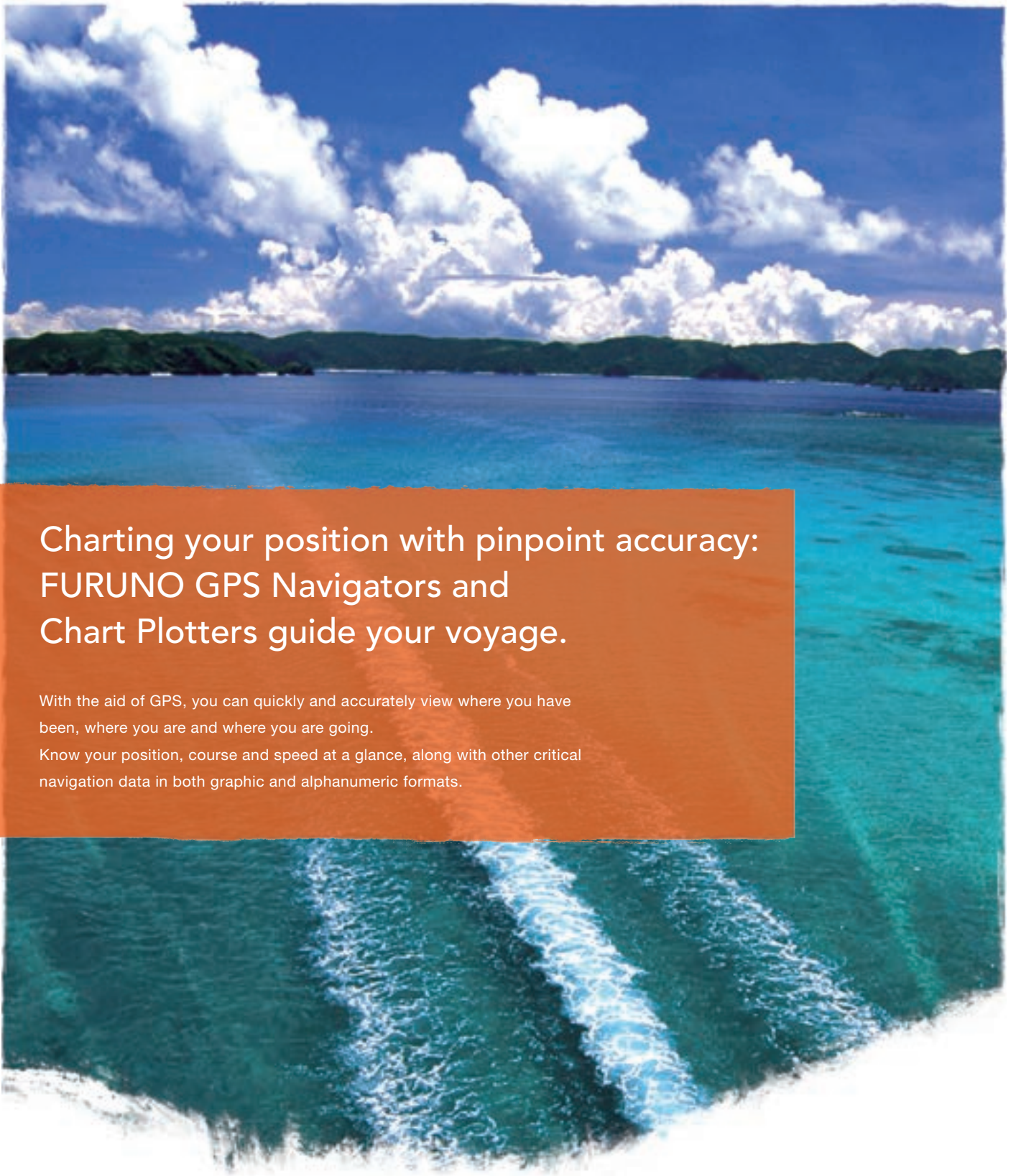

Charting your position with pinpoint accuracy: FURUNO GPS Navigators and Chart Plotters guide your voyage.

With the aid of GPS, you can quickly and accurately view where you have been, where you are and where you are going.

Know your position, course and speed at a glance, along with other critical navigation data in both graphic and alphanumeric formats.

GPS/Chart Plotter

GP33

GP39

NEW

GP170

GP1870F

GPS NAVIGATOR



4.3" GPS NAVIGATOR
Model GP33



- 4.3" "Sunlight Viewable" color LCD
- Maximum visibility under various ambient conditions both during night and under direct sunlight (brightness of the LCD is 700 cd/m²)
- Enhanced data legibility thanks to large characters and high resolution visual aid
- Stores up to 10,000 waypoints, 100 routes, and 3,000 track points
- 7 display modes available, including 2 user-customized modes
- Supports both NMEA0183 and CAN bus interface
- Contact closure capability available on the 10P connector
- SBAS capable for better measurement

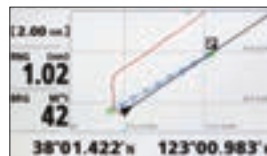

Plotter

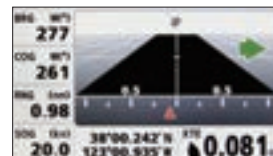

Highway



COG



Nav data



User Display

NEW



4.2" GPS NAVIGATOR
Model GP39

- Newly designed GPS core delivers enhanced position fixing accuracy
- Storage for 3,000 track points, 10,000 waypoints and 100 routes
- SBAS capable for better positioning calculations
- Share and display position information on networked equipment such as a fish finder, sonar, radar etc.

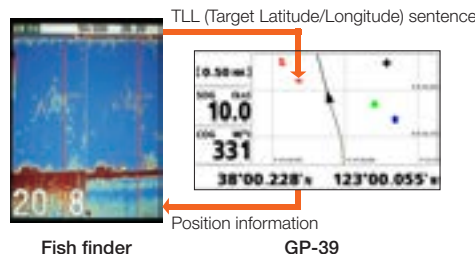

- Waypoint and route data can be exported/imported via a USB flash drive or signal converter

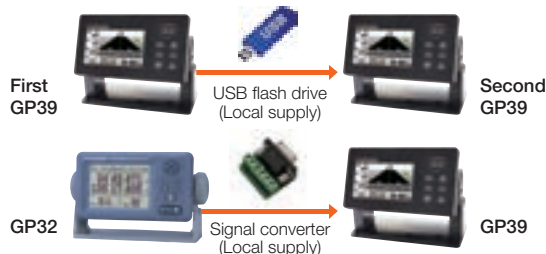

- Easy to mount on/off the bracket



GPS/DGPS NAVIGATOR



5.7" GPS/DGPS NAVIGATOR
Model GP170/GP170D



- Full compliance with IMO MSC. 112 (73) and IEC 61108-1: performance and testing standards for GPS receiver
- Newly designed GPS chip and antenna unit deliver enhanced stability and precision in position fixing
- Augmentation to enhance precision by utilizing SBAS (Satellite-Based Augmentation System) and DGPS (an optional DGPS radio beacon receiver as well as GPA021S antenna unit required)
- Simplified menu operation

»»» Spec P88

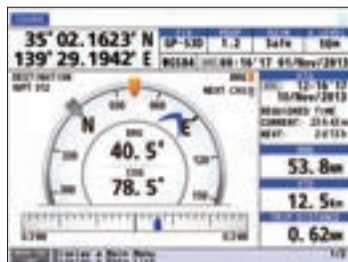

Course Display

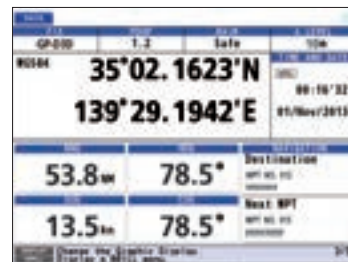

Data Display

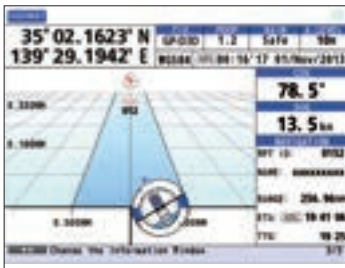

Highway Display



GPS Integrity Display

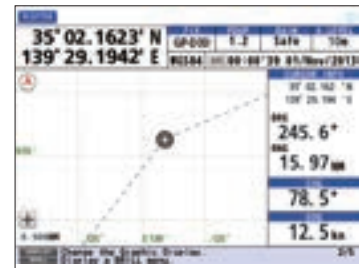

Plotter Display

GPS/WAAS CHART PLOTTER



7" WIDE GPS/WAAS COLOR
CHART PLOTTER with FISH FINDER
Model **GP1870F**

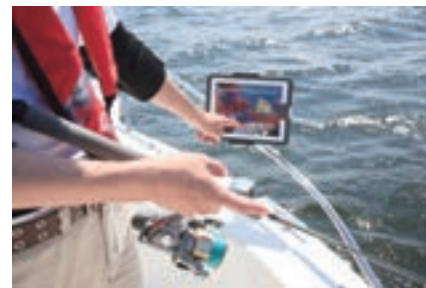

Wirelessly connect to your iOS devices

The GP1870F connects to your iOS devices using the app "C-MAP Plan2Nav" over a wireless ad-hoc connection. GP1870F software version 2.01, iOS version 4.3 or later required.



C-MAP Plan2Nav*



►►► *Spec P89*

GP1870F features

- Brightness 900 cd/m² LCD gives excellent readability even in direct sunlight
- The LCD and the AR glass are bonded together to ensure no fogging issues
- Internal GPS antenna for simple and easy installation
- Standard C-Map 4D chart* available on SD card
- RotoKey™ revolving menu and familiar point-and-click operation
- Internal memory: Waypoint/Track 30,000 points, Route 1,000 routes
- Easy-Routing function: Automatically create a route
- Built-in Wireless LAN, downloading up-to-minute weather service "C-Weather"**, via Internet.
- Clear visibility even when wearing polarized sunglasses
- Equipped with FURUNO's latest digital fish finder technology
 - Bottom Discrimination Function**
 - ACCU-FISH™ — A unique fish size analyzer
- Post-processing Gain Control applied to all echoes displayed on the screen
- White Line function — Discriminates fish lying near the bottom

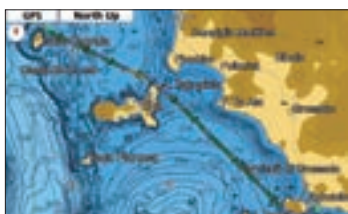

Easy-Routing function

The Easy-Routing Technology analyzes the high-quality C-MAP 4D data, works out the shortest route and then checks and displays hazards in each leg of the journey. Enter start and end points along with specific boat parameters and automatically receive waypoints of the shortest route. The technology highlights potential hazards and displays varying levels of alerts for each segment of the route and allows you to manually adjust the route.

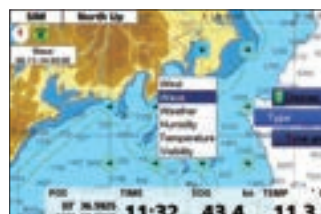

C-Weather information

Wind, Wave, Weather, Humidity, Temperature and Visibility (fog) information can be displayed on screen.

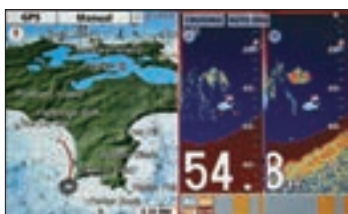

Plotter + Fish Finder
(ACCU-FISH and Bottom Discrimination)

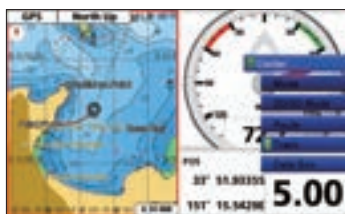

Plotter + SOG + Rotokey

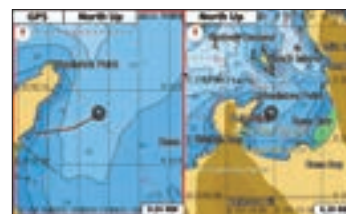

Dual range chart display

Find the fish that others have missed

Whether you are a recreational or serious sport fisherman, FURUNO fish finder technology has a model to ideally suit your needs. Our research and development team has spent extensive on-the-water hours coming up with the most innovative and useful features to ever be introduced. You will find rock-solid FURUNO technology that will help you find fish and save time. So don't be a follower, be a leader with a new FURUNO fish finder!

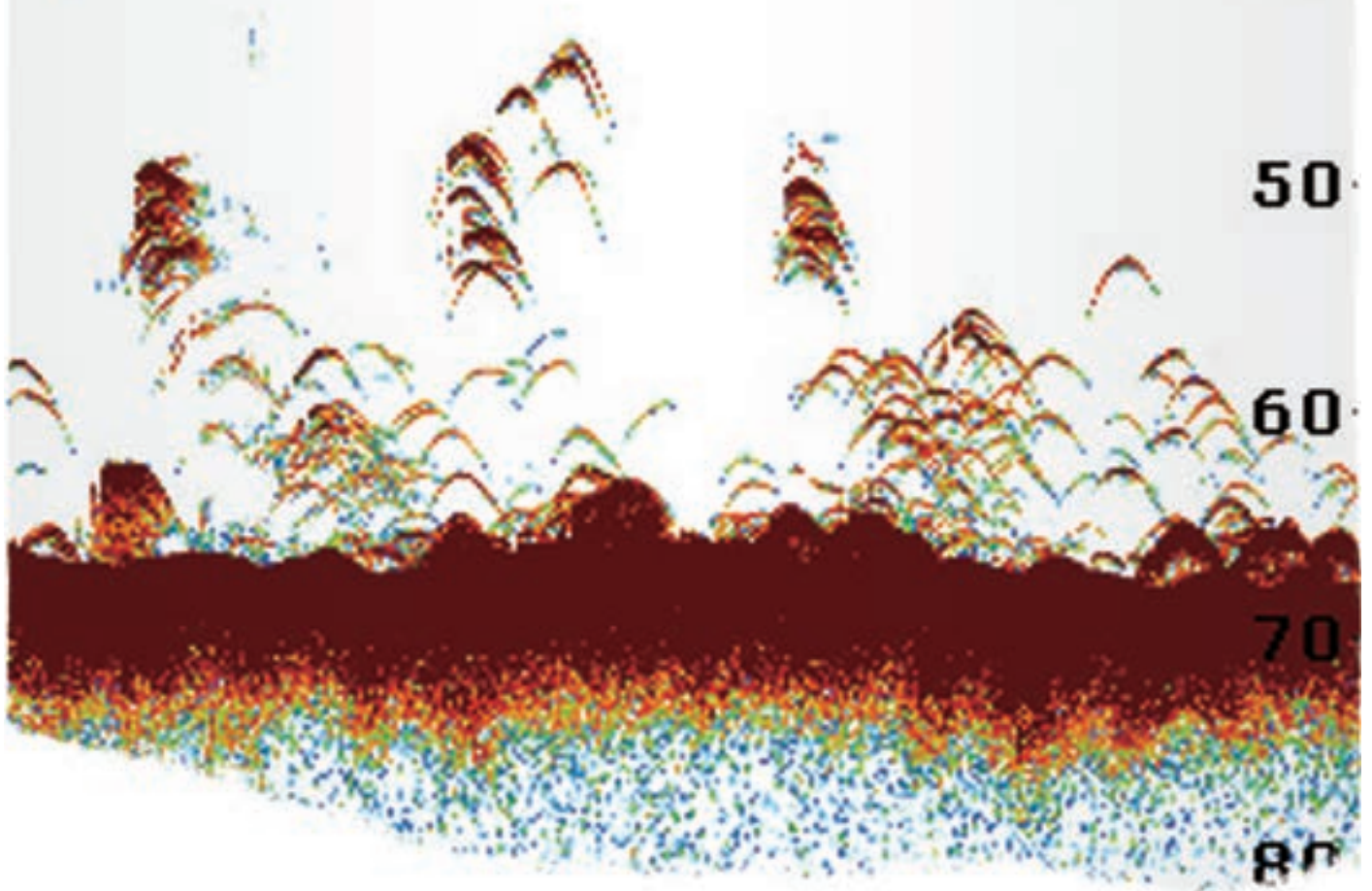

Fish Finder

FCV628
FCV588
FCV295
FCV1150

FCV1900
FCV1900B
FCV1900G

FISH FINDER

8.4" FISH FINDER
Model FCV588

5.7" FISH FINDER
Model FCV628



- Dual-frequency fish finder equipped with revolutionary RezBoost™ signal processing technology*
 - Improved clarity and resolution that was previously impossible with conventional narrowband transducers has been made possible thanks to the new RezBoost™ technology
- ACCU-FISH™ – A unique fish size analyzer based on the digital technology*
- Bottom Discrimination – Analyze bottom structure*
- White Line feature – Discriminate fish lying near the bottom

- Configurable Alarm function (depth, fish echoes, etc.)
 - Post-processing Gain Control applied to all echoes displayed on the screen
 - Share and display information on a connected chart plotter**
 - Fast transmission rate of 3,000 PRR (Pulse Repetition Rate) per minute (at 5 m depth range)
- * Thru-hull or transom transducer mount required
** Compatible chart plotter required

RezBoost™

RezBoost™ is a revolutionary new signal processing technology developed by FURUNO that improves resolution and target separation when using conventional narrowband transducers.

Spot individual game fish surrounding bait balls, as well as fish close to the seabed. With RezBoost™, not only can you expect higher resolution and crisper visuals, but also improvements in the ACCU-FISH™ function.

Compared to conventional signal processing techniques (FDF), a RezBoost fish finder produces an image that is up to 8 times¹ clearer. A TruEcho CHIRP fish finder (requires a special transducer) produces an image that is up to 10 times¹ clearer when compared with FDF. What can be done with a conventional narrowband transducer, just like the one you might have installed on your vessel, is truly impressive².

*1 RezBoost performance may vary depending on depth, range and signal frequency used.

*2 The Enhanced mode of RezBoost requires a RezBoost capable thru-hull or transom mount transducer.

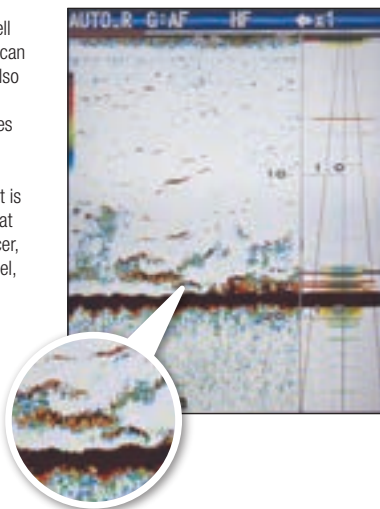

With RezBoost™ technology, the resolution is increased, leading to sharper and more defined echoes. Thanks to this increase in resolution, the accuracy of the ACCU-FISH™ function is also improved. ACCU-FISH™ is very useful when you need to determine fish size, but also has the added benefit of making fish echoes more visible when viewed from a distance. With ACCU-FISH™ you can spot individual fish echoes even from the deck of your vessel.

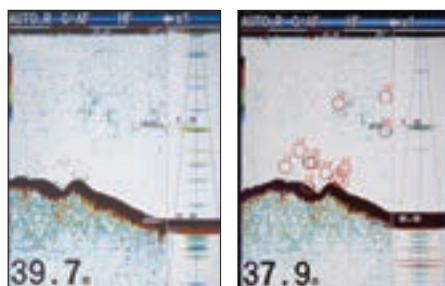

ACCU-FISH™ OFF

ACCU-FISH™ ON

ACCU-FISH™ identifies individual fish with size and fish mark function



Recognizes individual or multiple fish instantaneously

ACCU-FISH™ is a fish size assessment function of FCV628/588 that is unique to FURUNO. In order to assess individual fish size, echo returns are evaluated based on strength and turned into fish size display on screen. ACCU-FISH™ can detect fish size from 10 to 199 cm, in depths of 2 to 100 m.

In some instances, fish size indicated on FCV628 may differ from actual size. Please read the operator's manual carefully before using this feature.



Bottom Discrimination function



The Bottom Discrimination function enables the fish finder to indicate whether the bottom is composed mainly of rocks, gravel, sand or mud. This provides you with valuable information that helps you locate rich fishing ground, and boost your catch of the day.



Probability mode
The probability display mode shows the most probable bottom composition in graph form.

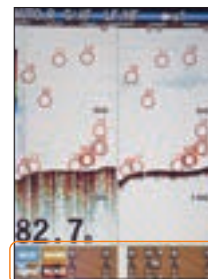

Graphic mode
The standard graphic display mode shows the most probable bottom composition by graphic or four colors.



10.4" COLOR LCD
SOUNDER
Model FCV295



12.1" COLOR LCD
SOUNDER
Model FCV1150



- Post-processing gain control applies changes to gain setting for all existing returns on the display
- White Edge feature for enhanced bottom discrimination
- FURUNO Digital Filter (FDF™) delivers crystal clear target presentation
- FURUNO Free Synthesizer (FFS) allows for adjustable operating frequency
- Available Heaving Compensation provides stable echo presentation even in rough seas (FCV1150 only)*
- Unique fish size analyzing function ACCU-FISH™ mode (available when FCV1150 connected with 50/200-1T transducer)

*Requires appropriate sensors

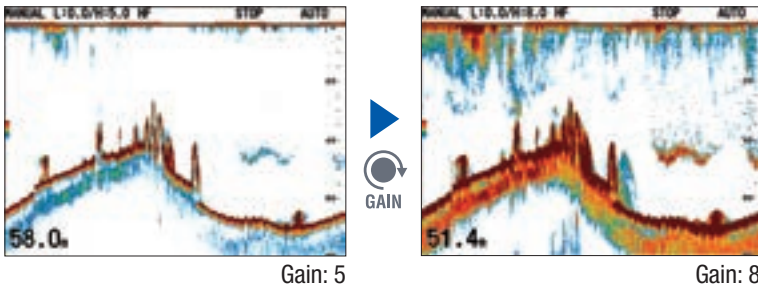

Quick Gain Control

With Quick Gain control, changes you make to the gain setting are applied not only to new echoes, but also to all past echoes on the screen. This lets you compare past and current echoes under the same gain setting. Because the changes are applied to both new and existing returns, you can quickly and easily determine the right Gain setting for your conditions.

White Edge

The top of the seabed is displayed in white to easily discern seabed structure from bottom fish returns. While conventional bottom discrimination function (i.e.: White Line) is applied to the strongest echoes, the White Edge function enhances the discrimination between bottom fish and the seabed.

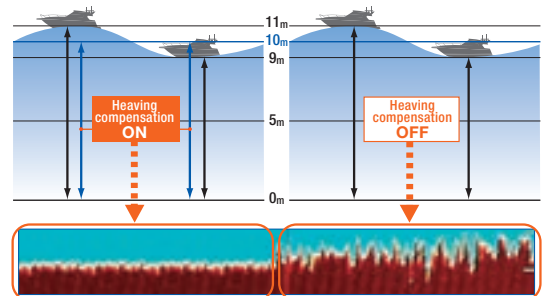

Heaving Compensation (FCV1150 only)

Even in rough sea conditions, the FCV1150 compensates for heaving, presenting a display without undulations caused by the sea conditions. FURUNO SC-30, SC-50 or SC-110 Satellite Compass required.

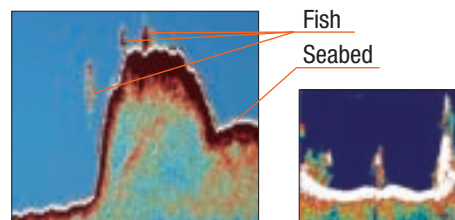

White Edge

White Line

»» Spec P91

FISH FINDER
Model **FCV1900**



Photo: 19" Marine Display
MU190HD (Optional supply)

- ACCU-FISH™ feature identifies individual fish with size or depth indication and fish symbol
- Bottom discrimination display provides estimate of bottom composition*
- Post-processing gain control applies changes to gain setting for all existing returns on the display

- Capture and review videos and screenshots
- FURUNO Free Synthesizer (FSS) transceiver design allows use of user-selectable operating frequencies

*Appropriate sensors required

Increased transmission rate for more details

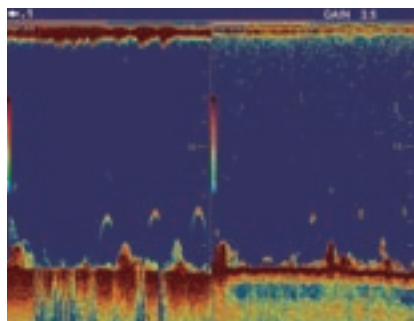

Individual fish

In low frequency, the fish is displayed in a distinct boomerang shape. In high frequency, you can clearly see the amount of detail displayed.

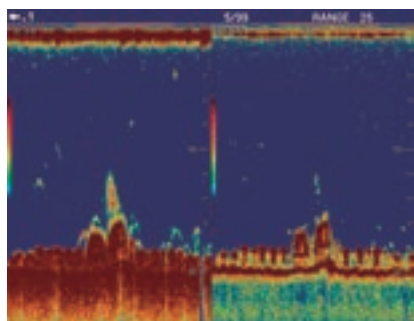

Fish reef

See fish reefs in greater detail.

Fish reef displayed in detail

Functions for improved efficiency

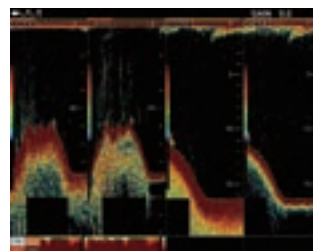

Display up to four different frequencies

Display up to four different frequencies together in a compact and easy way by connecting a required network fish finder. Since there is no need to install additional displays, this function is especially useful for small vessels.

Connect a BBDS1 network fish finder for bottom discrimination function

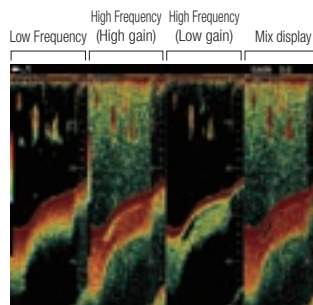

Simultaneous gain setting for increased visibility

Display two different gain settings simultaneously for increased visibility in changing water conditions and when changing vessel speed.

Upgrade to FCV1900B Hi-Res Fish Finder or FCV1900G Fish size indicator

You can upgrade your FCV1900 to a FCV1900B* or a FCV1900G*, both utilizing the latest TruEcho CHIRP™ technology by purchasing and installing a software license.

Feature	Model		
	FCV1900	FCV1900B	FCV1900G
Fish Size Histogram	NA	NA	✓
Transmission Mode**	TruEcho CHIRP™ mode	✓	✓
	Standard mode	✓	✓

* TrueEcho CHIRP™ compatible transducer required.

** The transmission mode is set by the installer.



Scroll back function

With the press of a button you can activate the scroll back function to instantly review past echoes. Up to two previous screens can be viewed.

►►Spec P92



HI-REZ TruEcho CHIRP™
FISH FINDER
Model FCV1900B



- High resolution echoes from shallow to deep waters made possible with TruEcho CHIRP™ technology

Photo: 19" Marine Display
MU190HD (Optional supply)

▶▶ Spec P92

Near the surface

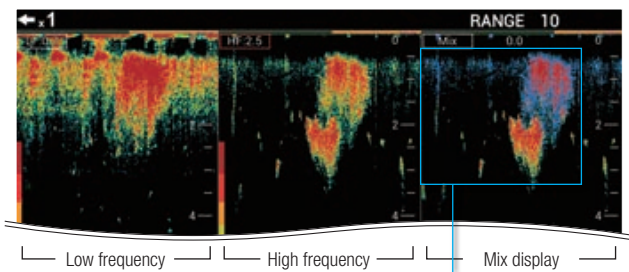

Fish are displayed clearly, even when they are close to the surface. In the mix display, bubbles are displayed in blue, and fish are displayed in bright red for easy target discrimination.
(Recommended transducer: CM275LHW)

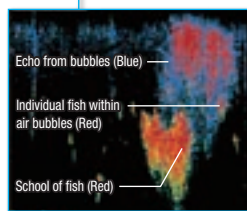

Middle layer

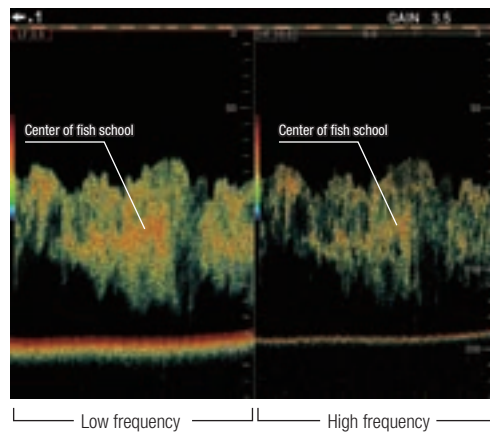

Spot the center of a school of fish simply by observing the color. Dense echoes are displayed in darker colors.

Individual fish

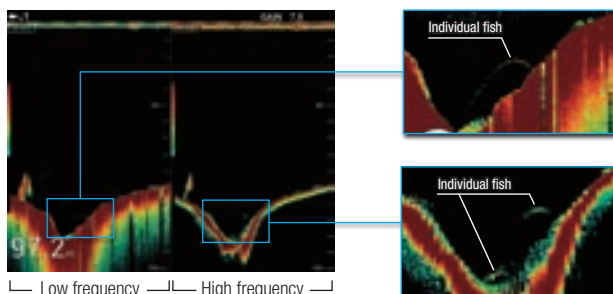

With improved depth resolution, individual fish can be observed even at depths of 100 m and deeper. Fish are displayed in a distinct boomerang shape.

Sea bottom

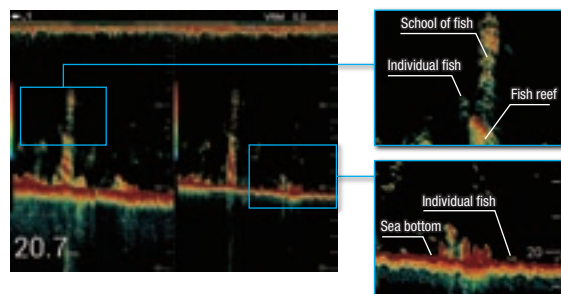

Individual fish can be discriminated within schools of fish, for easy identification of size and species.

You can easily spot individual fish close to the sea bottom

TruEcho CHIRP™ WITH UNIQUE FISH SIZE INDICATOR
Model FCV1900G



- High precision fish size feature provides approximate fish size in the dense school of fish in graph form
- TruEcho CHIRP™ technology delivers significant advancements in signal clarity and target definition
- Side Looking Mode, see targets and bottom structure below your vessel

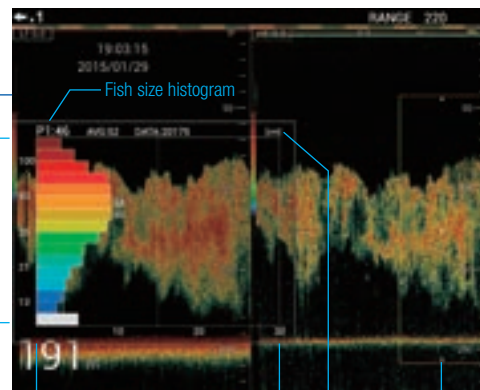
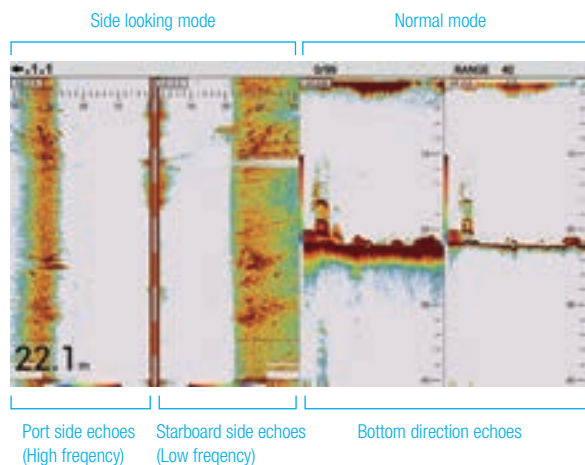

Photo: 19" Marine Display MU190HD (Optional supply)

»»» Spec P92

Identify size and distribution with the fish size graph for increased efficiency at sea

With a quick glance at the simple and efficient graph, you can get all the information you need to identify fish size and distribution. Once you know the fish size and its distribution, you can use this information to estimate the species and whether it's a viable target or not. Together with the TruEcho CHIRP™ technology, the FCV1900G allows you to choose the best position to throw your net. Also, based on the fish size graph, you can choose the right mesh size for efficient operation. (Recommended transducers: CM265LH or CM599LH)



Side Looking Mode

Side Looking Mode gives you the possibility to observe bottom structure and hardness in greater detail. Side Looking Mode also provides you with additional information on schools of fish and the position of your net when out at sea.

Accurately judge which target to go after

Experience incredibly accurate echoes, even in deep waters, thanks to our TruEcho CHIRP™ technology. The FCV1900G is well suited for trawlers, where accurate and reliable information about the sea bottom is necessary. Utilizing the fish graph gives you the ability to choose the right target, maximizing your time at sea and avoiding bycatches.

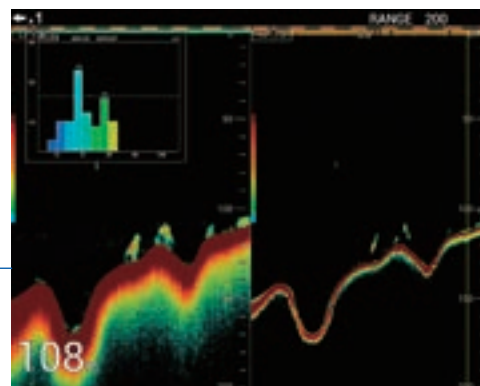

School of fish close to the sea bottom



Find fish all around your vessel,
not just underneath it!
FURUNO's Sonar technology delivers
a more productive fishing operation.

There is no doubt about it; these are a fisherman's dream machines! FURUNO's high-powered Sonars have the capability to find fish where other fish finders only wish they could. With the ability to search 360 degrees around the boat or trained to sweep a specific sector, FURUNO's Sonar will paint a vivid picture of the world below your boat.

Sonar

CH250
CH270
CH300

CSH5L MARK-2
CSH8L MARK-2
WMB-3230
WMB-5230

Searchlight Sonar gives you the ability to search both horizontally and vertically. With horizontal search, you can specify the tilt angle to area around your boat. With vertical search, you can obtain detailed underwater conditions at any bearing. Combine the two to make your cruising safer and your fishing operation more productive.

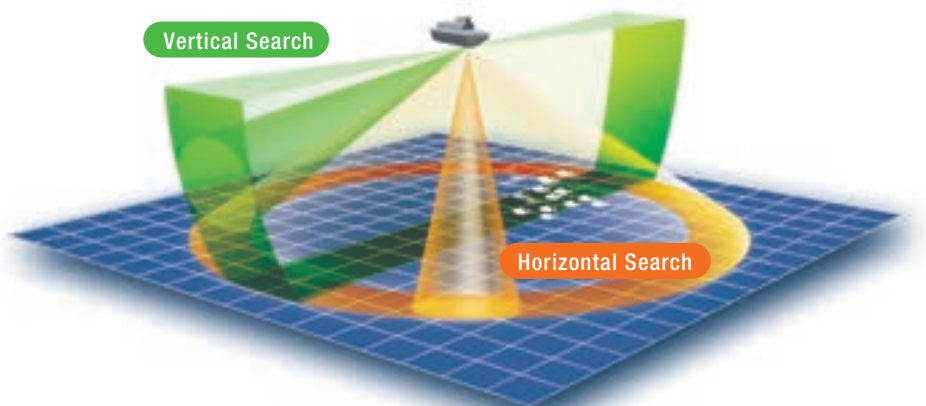

SEARCHLIGHT SONAR



10.4" SEARCHLIGHT SONAR
Model CH250/270



2000/2001/
2002/2003/
2004
* CH250

Frequency: 60, 88, 150, 180** kHz
** CH270

- Waterproof, high-resolution 10.4" Color LCD
- Echo presentation in 8 or 16 color gradation with selectable day or night background color
- Audio Target Detection makes continuous screen observation unnecessary (optional speaker required)
- Target Lock mode keeps track of targets
- L/L mode allows for continual search of particular area of interest
- Available in Black Box configurations, allowing the use of after-market displays

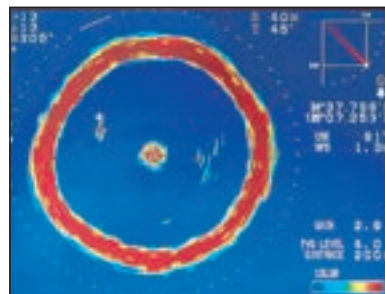

Full Circle Scan

Full Circle Scan allows for detection of schools of fish at any bearing.

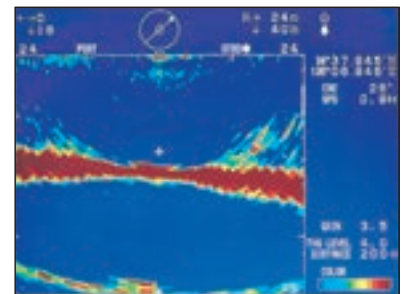

Vertical Scan

Vertical Scan shows the bottom profile at a user specified angle.



10.4" DUAL-FREQUENCY SEARCHLIGHT SONAR
Model CH300



Frequency: 60/153, 85/215 kHz

- Incorporates both high and low frequency (60/153 or 85/215 kHz) transducers in a single transducer
- CUSTOM MODE key provides one-touch setup or soft key function
- Display modes include Horizontal scan, Vertical scan, Mix mode and echo sounder
- Pulse length is automatically adjusted according to range, for optimized performance
- Target lock tracks selected school of fish or L/L position
- Available in Black Box configurations, allowing the use of after-market displays

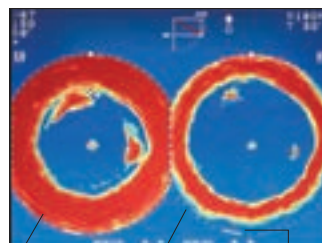

Low frequency High frequency
Sweep indicator (Shows train position)

Horizontal scan

The horizontal scan helps detect fish schools at any tilt, all around the vessel. In the dual-frequency mode, any two presentations from high/low frequency scan and the mix mode can be displayed. The gain of each mode can be adjusted separately.

Combination Full/Half Circle and Vertical scan

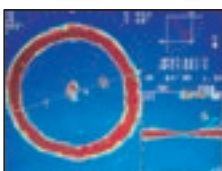

Horizontal with vertical scan

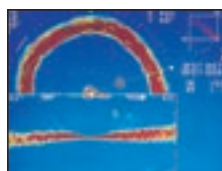

Half-circle horizontal with vertical scan

A unique feature of this sonar is a mode integrating the two images above. This sonar image can be switched between full and half circle with vertical scan.

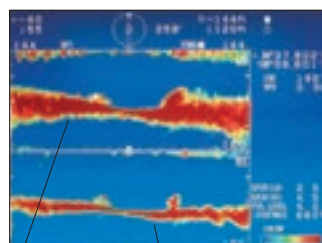

Low frequency High frequency

Vertical scan

Vertical Scan shows the bottom profile at a user specified angle. In dual frequency mode, the vertical scan can show both high and low frequency. The search angle and range are indicated on screen.

FULL-CIRCLE SCANNING SONAR

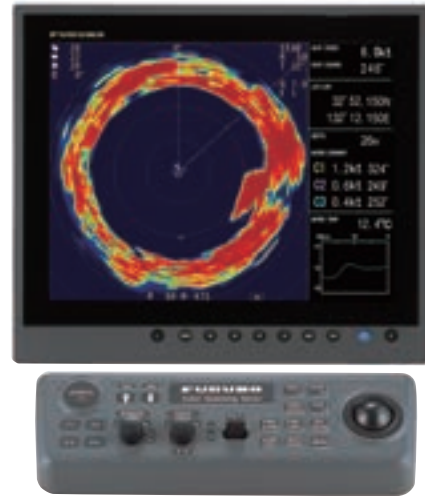

FULL-CIRCLE SCANNING SONAR
Model **CSH5L MARK-2**



FULL-CIRCLE SCANNING SONAR
Model **CSH8L MARK-2**



- Full-circle scanning sonar detects and instantaneously displays schools of fish and underwater conditions
 - The vivid 16-color display assists in recognition of seabed structure as well as concentration/distribution of fish schools
 - Various fishing and navigation data* keep the operator abreast of fishing and navigation conditions
- * Requires appropriate sensors

- Four user-programmable function keys for quick set up according to fishing conditions or specific functions
- High power transmitter ensures reliable operation under any conditions
- Transducer frequency;
 - CSH5L MARK-2: 55 kHz
 - CSH8L MARK-2: 85 kHz

Selectable User-Friendly Operating Modes

There are three basic operation modes:

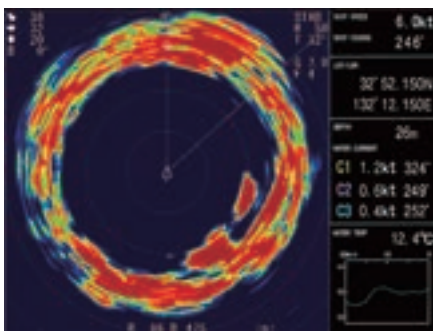

Sonar Display

Navigation data can be displayed in the text window, with connection of appropriate sensors. This mode is useful for detecting and tracking schools of fish.

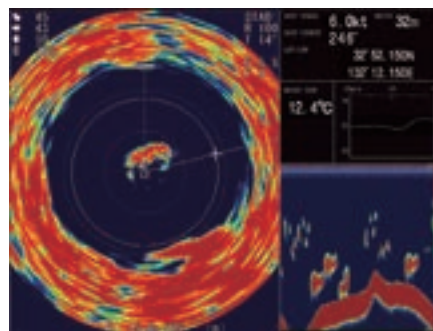

Sonar + Fish Finder*

The sonar picture appears on the left and the signal fed from the fish finder at the lower right side of the screen. This mode is suitable for judging fish school concentration.

* Interface with fish finder required.

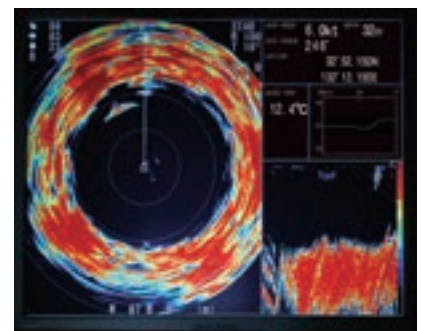

Sonar + Audio

Sonar picture appears on the left and the audio display at the lower right side of the screen. This mode is useful for analyzing echoes in a desired area.



The optional remote controller provides armchair control of tilt, range and gain.

MULTI BEAM SONAR

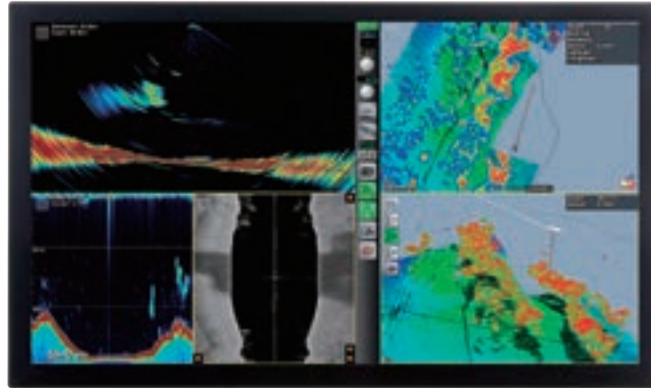

MULTI BEAM SONAR
Model **WMB-3230/5230**



WASSP is the first product to bring the benefits of multi beam technology to fishing.

Providing unparalleled views of the water column and the seafloor, WASSP lets you accurately locate schools of fish, profile the seabed and map bottom hardness, all in real time 3D.

- WASSP multi beam sonar has vastly superior accuracy, wide 120-degree port-starboard scanning area and high-resolution real-time 3D mapping
- 120-degree port-starboard scan yields 3:1 water depth mapping capability
- Continuous real-time 2D and 3D mapping of the water column and seabed
- Stabilized for pitch, heave and roll*
- Selectable from a range of displays depending on needs at the time
- Record and replay survey or fishing runs for analysis later
- The WASSP sonar transducer** is available in 2 frequencies
 - 160 kHz: 200 m depth capability
 - 80 kHz: 500 m depth capability
- WASSP multi beam sonar is uncomplicated, self-contained and comprised of just three modules:
 - Compact transducer (incorporating transmit and receive arrays)
 - Black box transceiver unit
 - Processor unit with keyboard and trackball
- Software updates as new features and functions are added
 - Compatible with TZ plot software

* Compatible sensor required.
** Optional supply

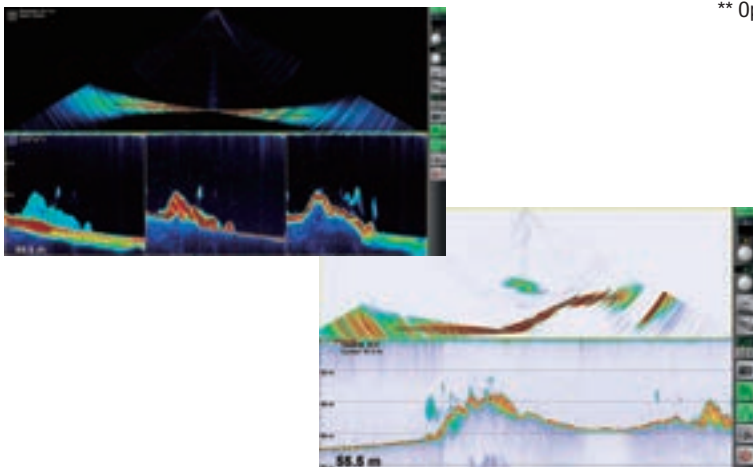

WASSP gives you wide-angle 120° port-starboard view of the seafloor and water column with 112 beams per ping. The viewing span is over 3 times sea depth, and WASSP can profile an area over 100 times faster than a single beam system.



»» Spec P96

FURUNO's NAVpilot is a revolutionary autopilot designed for a variety of vessels. It utilizes a self-learning and adaptive software algorithm, and plays the ultimate role in course keeping capability by dynamically adjusting essential parameters for navigation i.e., vessel speed, trim, draught, tide and wind effects, dead band, weather, etc. These parameters are stored in the system memory and continuously optimized.

Kick back, relax and let NAVpilot steer you to your destination!

Autopilot

NAVpilot 700
NAVpilot 711C



Model NAVpilot 700



Model NAVpilot 711C

NAVpilot



NAVpilot remarkable self-learning, adaptive software is developed by collaborative works between FURUNO and FLSI.

* NAVpilot 700

NAVpilot

- FURUNO Fantum Feedback™ - Streamlined installation and precise course control without the need for a physical rudder feedback unit
- Selectable "Economy" and "Precision" Navigation Modes combine adaptive technology providing fuel and power savings of up to 2.5% or more.*
- Volvo Penta IPS, YAMAHA Helm Master™, Yanmar VCS compatible
- "Precision" provides for tighter course keeping, within 0.01 nm of the set course
- Perfect for inboard or outboard power boats and sail boats
- Simple one-touch mode selection enables flexible steering and course control
- Autopilot control available from NavNet TZtouch2/TZtouch
- Optional revolutionary SAFE HELM and POWER ASSIST brings unrivaled steering control and comfort at the helm**

* Based on Furuno testing and "Scenarios for a Clean Energy Future 2000" - U.S. Department of Energy

** Required Options - HRP11 or HRP17 Pump and FPS8 Power Steering Module

Graphic displays for NAVpilot 711C

Several types of the graphic displays are available, allowing you to customize the data to suit your own preferences with either digital or analog graphics. The NAVpilot 711C features a color day/night graphic display, giving you much better sunlight visibility during the day, while not affecting your night vision when the sun goes down.



SABIKI

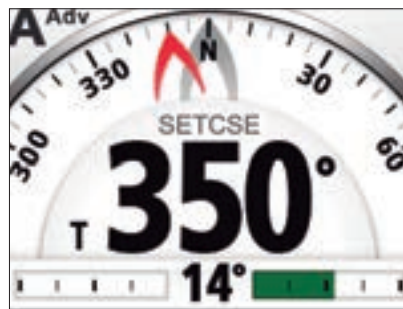

Compass



Highway

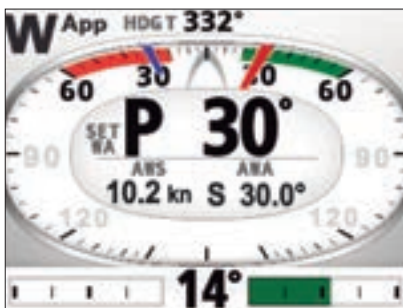

Wind



Rudder

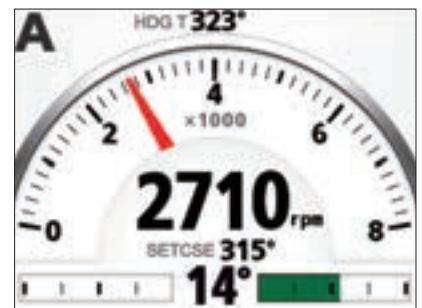

Engine Speed

Night Version



Auto



Highway

Display modes for NAVpilot 700

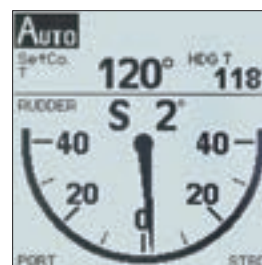

Rudder Angle

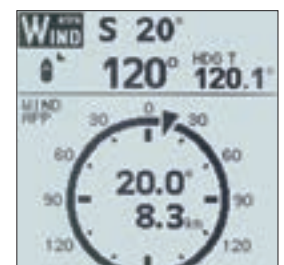

Wind

Introducing "SABIKI mode" for the NAVpilot 711C

With the brand new SABIKI mode your NAVpilot 711C has just become even more capable than before. And the best thing is, there is no need to install additional hardware or sensors. Just perform the software upgrade and the SABIKI mode will be added to your NAVpilot 711C. SABIKI mode is only available on vessels with outboard engines.



SABIKI mode

SABIKI mode lets the autopilot take control while you are drifting astern, so you can focus on fishing instead of steering. Moving astern at a slow pace the SABIKI mode is uniquely tailored for sabiki fishing, jigging and bottom fishing. Sabiki fishing requires a bit of technique and no matter if you just started or have considerable experience, the SABIKI mode will help you catch the bait fish needed for the big catch.



After performing the software upgrade, a SABIKI icon will appear in the turn menu. The SABIKI mode is only user selectable if the current speed is below 5 knots. Once SABIKI mode is selected, the course can be set with the Roto knob and the arrow keys.

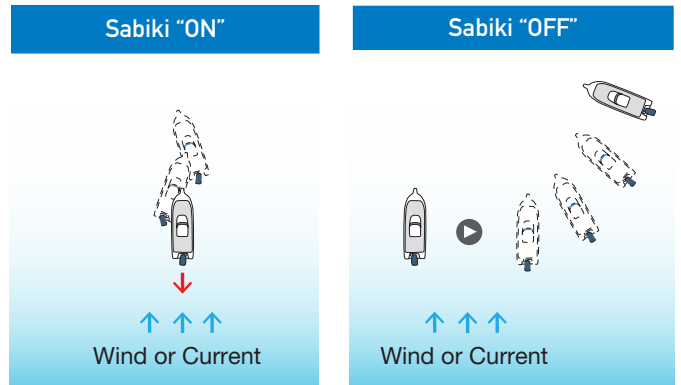

With the SABIKI mode turned on, the direction can be kept just by adjusting the throttle.

In order to keep the same direction it is not sufficient to just reverse the engine and move astern. The steering has to be constantly adjusted to keep direction.

NAVpilot 711C software version 1.02 and Processor unit FAP-7002 software version 1.20 required for SABIKI mode.

Autopilot control by NavNet TZtouch2/TZtouch

If you have your boat equipped with a NavNet TZtouch2 or TZtouch system you can take full advantage of the NAVpilot 700/711C from the NavNet TZtouch series display. You can activate the AUTO mode of the NAVpilot 700/711C and change the set course by tapping on arrow buttons, by adjusting a slider bar with your finger or the RotoKey™, or by dragging the course arrow with your finger.

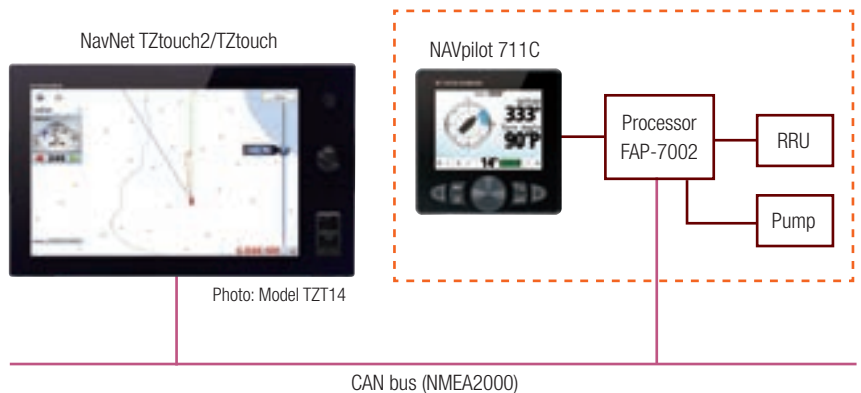

Self-learning and adaptive software

From the first dock-side setup through the last voyage you made, NAVpilot continues to learn your vessel's steering characteristics. This allows for dynamic adjustments to the boat's steering for vessel speed, trim, draft, tide and wind effects, weather, etc. These characteristics are stored in the processor's memory where they are continuously optimized to make the NAVpilot more versatile.

Advanced auto mode



NAVpilot consistently maintains the desired heading while compensating for the effects of tide and wind.

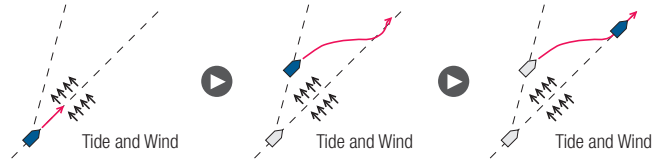

Auto mode



NAVpilot consistently maintains the desired heading, but the vessel may drift off course due to the effects of tide and wind.

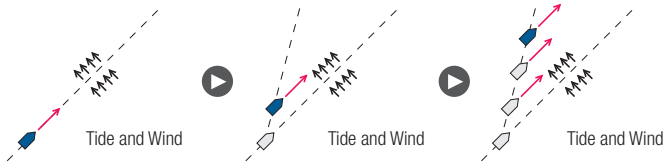

SABIKI mode



NAVpilot consistently maintains the desired heading astern while compensating for the effects of tide and wind. Speed is limited to 5 knots.

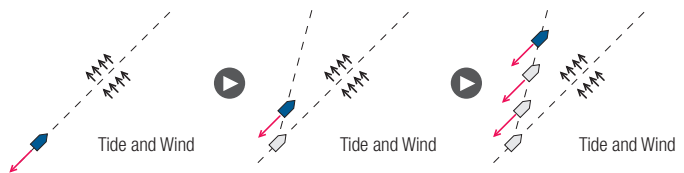

Nav mode/Route tracking



NAVpilot steers the vessel towards the current waypoint while compensating for the effects of tide and wind.

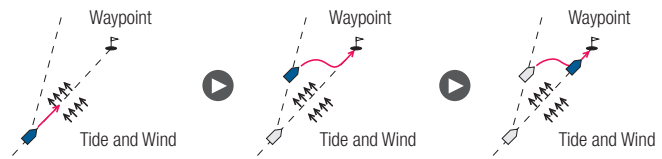

When connected to a GPS Navigator, NAVpilot steers the vessel to follow a series of waypoints in succession. Upon arriving at each waypoint or destination, audible and visual alerts are activated.

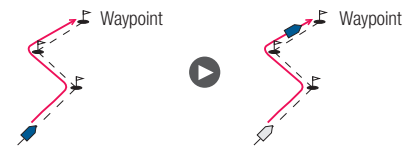

Wind mode*



NAVpilot consistently maintains the desired heading toward true or apparent wind direction while compensating for the effects of tide and wind.

* This mode is available for sailing craft only. Wind data input is required.

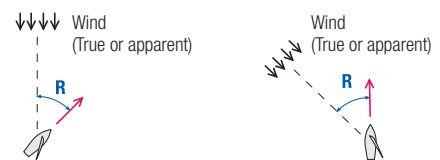

FishHunter™ mode

FishHunter™ is a unique feature of FURUNO's NAVpilot series. Find a fish target with your FURUNO sonar/sounder or bird target with your FURUNO radar and feed it to the NAVpilot. The NAVpilot will activate the FishHunter™ to perform square, zigzag, circle, orbit, spiral or figure eight maneuvers around the specified target at a user selected distance. This feature can also be used for Man Overboard (MOB).

Square

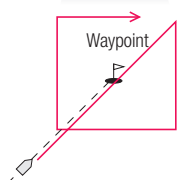

Zigzag

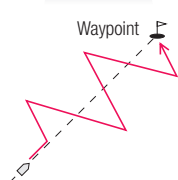

Orbit

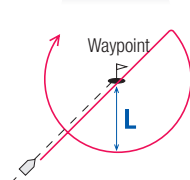
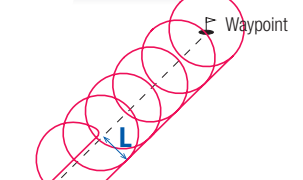

Figure 8



Spiral



Furuno Fantum Feedback™



FURUNO with Fantum Feedback™, NAVpilot outboard/sterndrive installations no longer require use of a physical rudder feedback unit.

Fantum Feedback™ NAVpilot software allows a simplified installation, while delivering enhanced speed.

This simplified installation, combined with Furuno's unique adaptive learning Autopilot technology, provides unmatched outboard Autopilot performance.

Fantum Feedback™ is a menu-selectable feature available in the latest NAVpilot 700 series software. This new software was developed and extensively tested on a wide variety of outboard vessels with hydraulic steering and reversing pump control.

Fantum Feedback™ achieves precise course control, from slow trolling speeds to high-speed cruising, utilizing a newly developed, time-based rudder gain process, rather than traditional rudder angle based control.



Compatible with EVC engines

The NAVpilot 711C works with a wide variety of boats and engines, including power and sail boats, with inboard or outboard engines. It even has the capability to work with Volvo Penta IPS, Yamaha Helm Master™ and Yanmar 8LV engine systems.



Volvo Penta IPS system
(Compatible with Volvo Penta IPS drive versions C, D or E type.)



Yanmar Joystick Control System
(Compatible with Yanmar 8LV and JC10)



Yamaha Helm Master™ system

FURUNO IF-700IPS (IPS Interface Unit) is an optional unit to integrate with the innovative propulsion system. The IPS Interface Unit relays commands from the NAVpilot 700 series to the engines in order to steer the vessel.

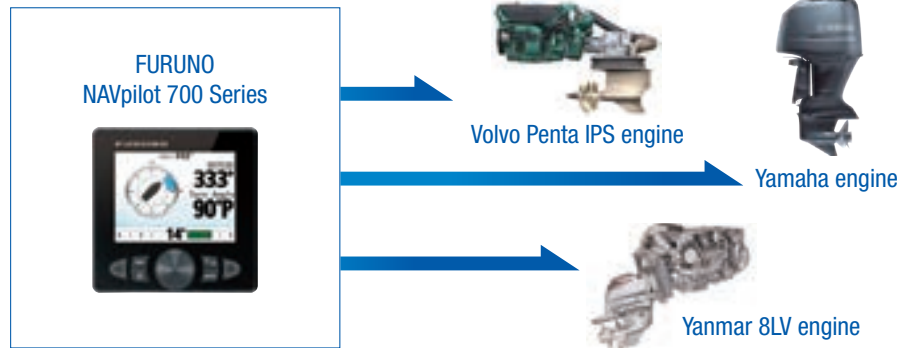

SAFE HELM and POWER ASSIST features provide Efficient and Effective Helm Steering Control



The optional SAFE HELM and POWER ASSIST features* provide a unique interface to the vessel's hydraulic hand steering system, providing unrivaled comfort and control of the vessel's steering directly from any manual helm on the vessel. These two modes greatly reduce steering effort and enhance the safety of your vessel's autopilot.

* Required Options - HRP11 or HRP17 Pump and FPS8 Power Steering Module

SAFE HELM

The SAFE HELM temporarily switches the NAVpilot to manual steering for a specified time interval, taking it out of an automatic steering mode (AUTO, NAV, etc.) After the time interval has elapsed, SAFE HELM is deactivated and the previous automatic steering mode is restored.

POWER ASSIST

The POWER ASSIST incorporates the SAFE HELM concept and provides speed-based, power assisted steering, which greatly reduces manual helm effort in maneuvering situations. POWER ASSIST is a unique, helm-activated, assisted steering feature that can augment, and possibly replace, steering systems on many vessels. POWER ASSIST reduces steering system complexity and costs while increasing economy.



SYSTEM CONFIGURATIONS

FURUNO FI70 Instrument and NAVpilot series are designed to match the NavNet TZtouch2/TZtouch/3D and other navigation equipment. The "Plug and Play" CAN bus interface allows for easy installation and exceptional interface ability.

The diagrams below show typical installations for power and sail boats.



Model NAVpilot 711C



Model TZTL15F



Model FI70

Power Boat

- NAVpilot cable
- CAN bus
- Others

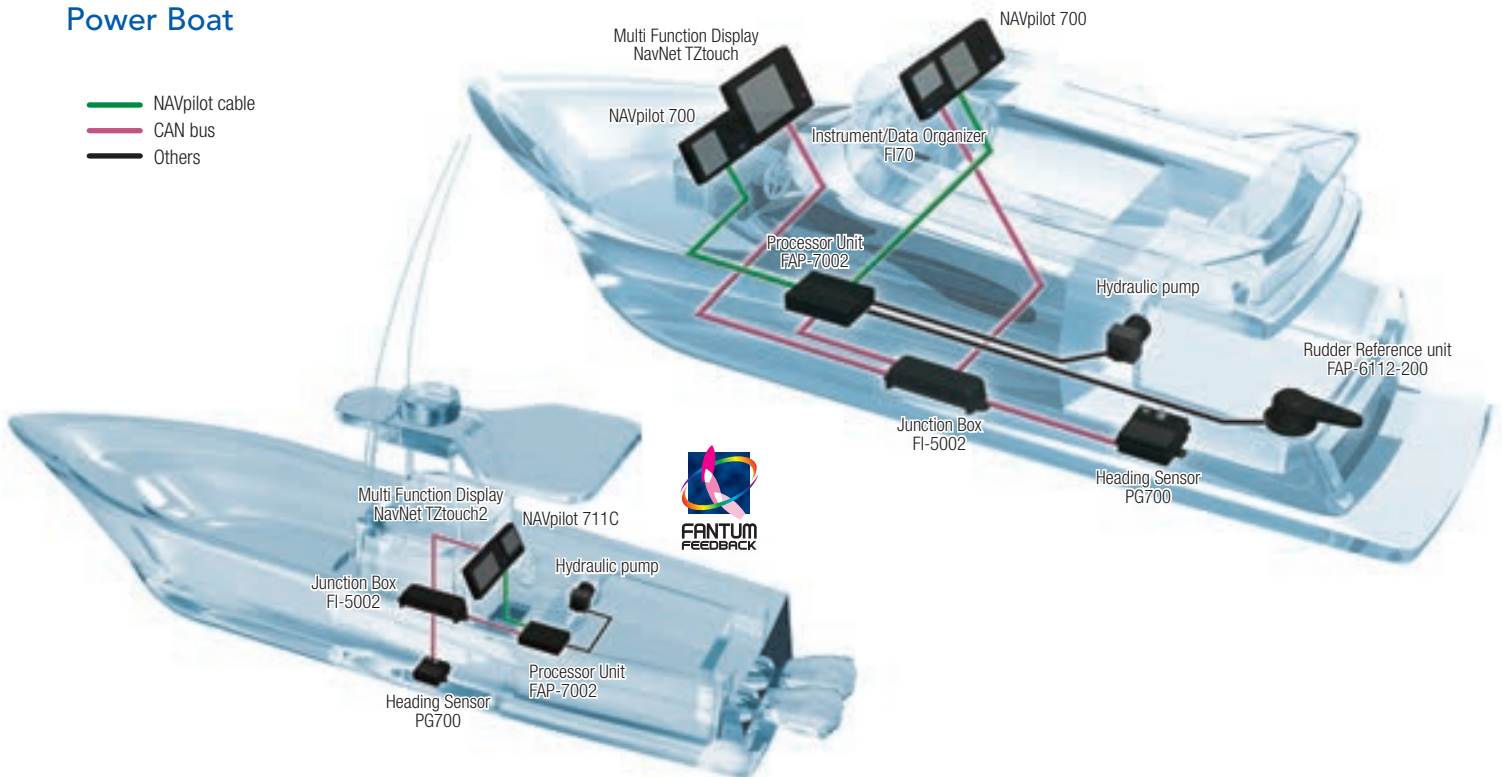

Sailboat

- NAVpilot cable
- CAN bus
- Others

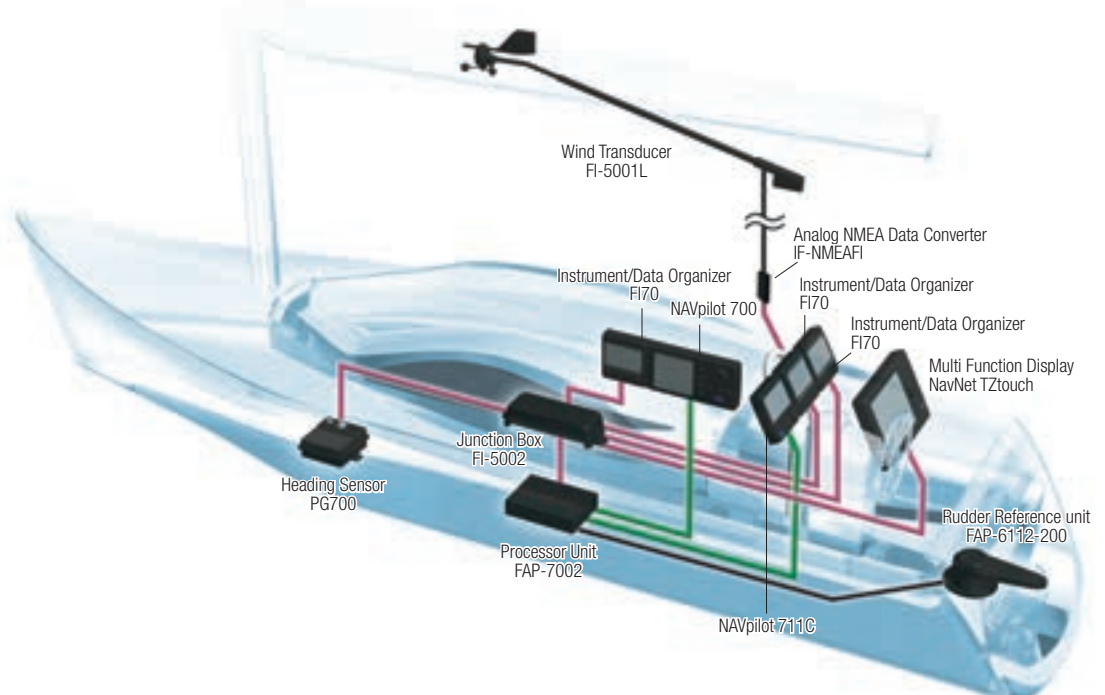

All your info...All in one, for powerboats and sailboats alike

The new FI70 INSTRUMENT/DATA ORGANIZER sports a vibrant 4.1" bonded color display that is visible even in the harshest sunlight conditions. Utilizing the CAN bus network, external sensors can easily be connected for simple and reliable operation. The FI70 features an easy to operate user interface. You can customize almost every display property, allowing you to choose the information you want to be displayed, in the way you want to see it!



Instrument/Data Organizer

FI70



Model **FI70**



- Designed to perfectly match the NavNet TZtouch/TZtouch2 and NAVpilot 711C on your helm
- Clear 4.1" screen that is viewable even under direct sunlight
- Simple and intuitive interface allows full customization
- Bonded color LCD ensuring condensation free operation as well as great visibility

- Use your existing wind sensors (FI-5001/FI-5001L) with the new analog IF-NMEA2000 converter
- Low power consumption (0.15 A max)
- Simple AIS display through connected CAN bus devices
- Share language and brilliance settings between FI70s when grouping them together

▶▶▶ Spec P98



Heading



Wind (CH AWA/AH TWA)



Engine RPM (Single)



Engine RPM (Triple)



AIS

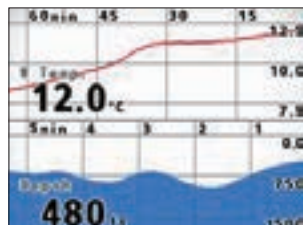

Graph



Timer



Highway

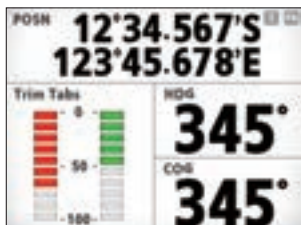

Data Box (Split)



Data box (Single)



Rudder



Roll & Pitch

Connection Diagram

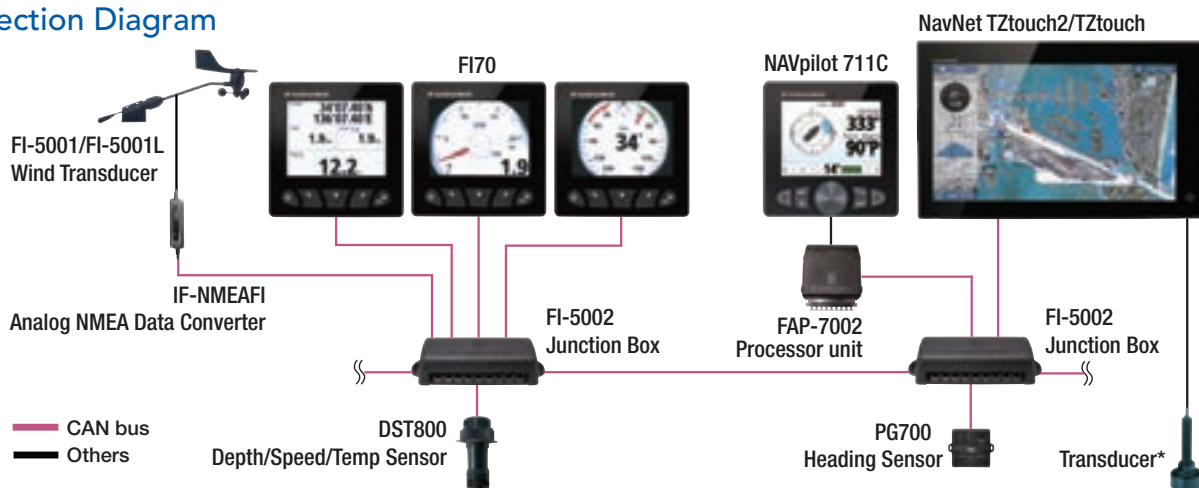

* Connecting directly is only available with TZtouch2

Sensors and Accessories (Option)



Wind Transducer comes with a snap-lock fitting that holds the shaft securely in order to prevent the sensor from being damaged from excessive vibration onboard the craft.

Wind Transducer
 Model **FI-5001/5001L**
 (Long Shaft)

Angle Accuracy: Better than $\pm 10^\circ$
 Speed Accuracy: Better than $\pm 5\%$ (20 kt)
 Power supply: 12 VDC, less than 40 mA
 Transducer cable (option): 30/50 m

Depth/Speed/Temp Sensor
 Model **DST800**

Frequency: 235 kHz
 Cable: 6 m

Junction Box
 Model **FI-5002**

CAN bus backbone x 2 ports
 CAN bus x 6 ports
 Power supply: 12 VDC, less than 2A

Analog NMEA Data Converter
 Model **IF-NMEAFI**

CAN bus: 1 port
 Power supply: 15 VDC, less than 200mA

»»» *Spec P99*

Monitors

- MU150HD
- MU190HD
- MU170T
- MU190T
- MU240T

FURUNO

15"

XGA (1024 x 768)



Model **MU150HD**



1000 cd/m²

19"

SXGA (1280 x 1024)

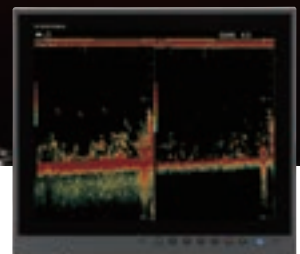

Model **MU190HD**



1000 cd/m²

Picture In Picture (PIP)

(MU150HD/190HD)

Composite video (NTSC/PAL) input is available for displaying video images from an onboard TV/DVD player. For MU150HD/190HD with more than two Composite Video Inputs, the images in the PIP window automatically switch alternately.



Waterproof

(MU150HD/190HD)

The MU150HD/190HD has a waterproof display and is built to stand up to tough marine conditions when mounted at fly bridge console. The display can be rinsed in water for easy, worry-free cleaning.

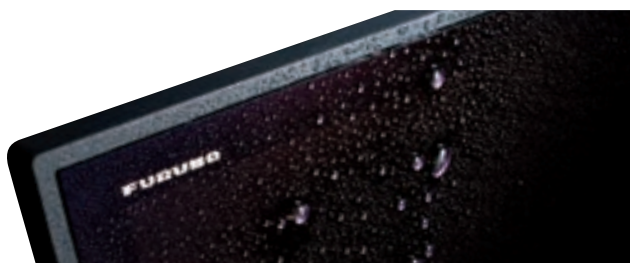

Slim, lightweight and compact

(MU150HD/190HD)

The MU Display series is slim in depth, light weight and is so compact that it fits right into virtually any console.

Its space-saving design makes optimum use of your dashboard.



photo: MU190HD/MU150HD

Low power consumption

(MU150HD/190HD)

Utilizing the latest LED backlight, the MUDisplay series delivers sharp, high quality images with bright colors and all at very low power consumption.

With the introduction of a variety of Black Box products, marine displays are becoming more of a necessity than a luxury

For crystal clear presentation for your Radar, Chart Plotter, NavNet or other electronics turn to the unmatched FURUNO quality and reliability that you have depend on.

17"

SXGA (1280 x 1024)

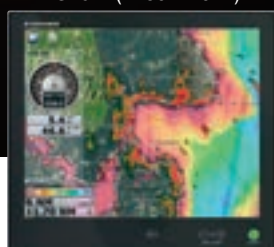

MU170T



1000 cd/m²

19"

SXGA (1280 x 1024)

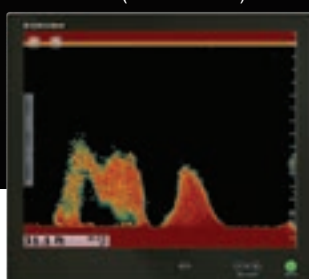

MU190T



800 cd/m²

24"

HD1080 (1920 x 1080)
16:9 Aspect Ratio



MU240T



1000 cd/m²

	MU 150HD	MU 190HD	MU 170T	MU 190T	MU 240T
Crystal clear marine grade monitors for use as main or remote display	✓	✓	✓	✓	✓
Bonded LCD provides clear view in any weather condition and avoids concerns such as dew condensation	✓	✓	✓	✓	✓
Available in table top or flush mount (Mounting bracket is optional)	✓	✓	✓	✓	✓
Automatic dimmer sensor adjusts the display brightness as lighting conditions change	✓	✓	✓	✓	✓
Customizable input names for easy on-the-fly identification and switching between onboard Radar, Sonar, Sounder, Camera, etc.	✓	✓	✓	✓	✓
Any of the composite inputs are PIP (Picture-In-Picture) capable, with adjustable size and screen location	✓	✓	✓	✓	✓
Power ON/OFF automatically by the DVI signal	✓	✓	✓	✓	✓
1,000 cd/m ² brightness provides superior visibility even in direct sunlight	✓	✓	✓	✓	✓
Built-in scaler allows accepting up to various resolutions	VGA to SXGA	VGA to SXGA	VGA to XGA	VGA to SXGA	VGA to SXGA
Selectable inputs including RGB analog, DVI (Digital Video Interface) and Composite	✓	✓	✓	✓	✓
Multi-Touch Control - compatible with NavNet TZtouch			✓	✓	✓

Flush mounting

For space-saving installation and additional security, flush mount installation is available for all the MUDisplay series. The display unit can be fixed from either front or rear with the flush mount kit for MU150HD/190HD.

Flush mounting, fixed from front

MU150HD/190HD

Drawing: MU150HD

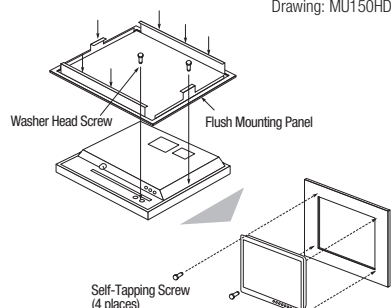

Flush mounting, fixed from rear*

MU150HD/190HD

Drawing: MU190

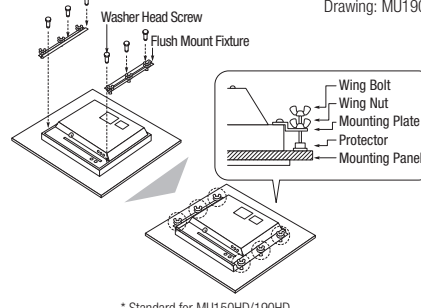

* Standard for MU150HD/190HD

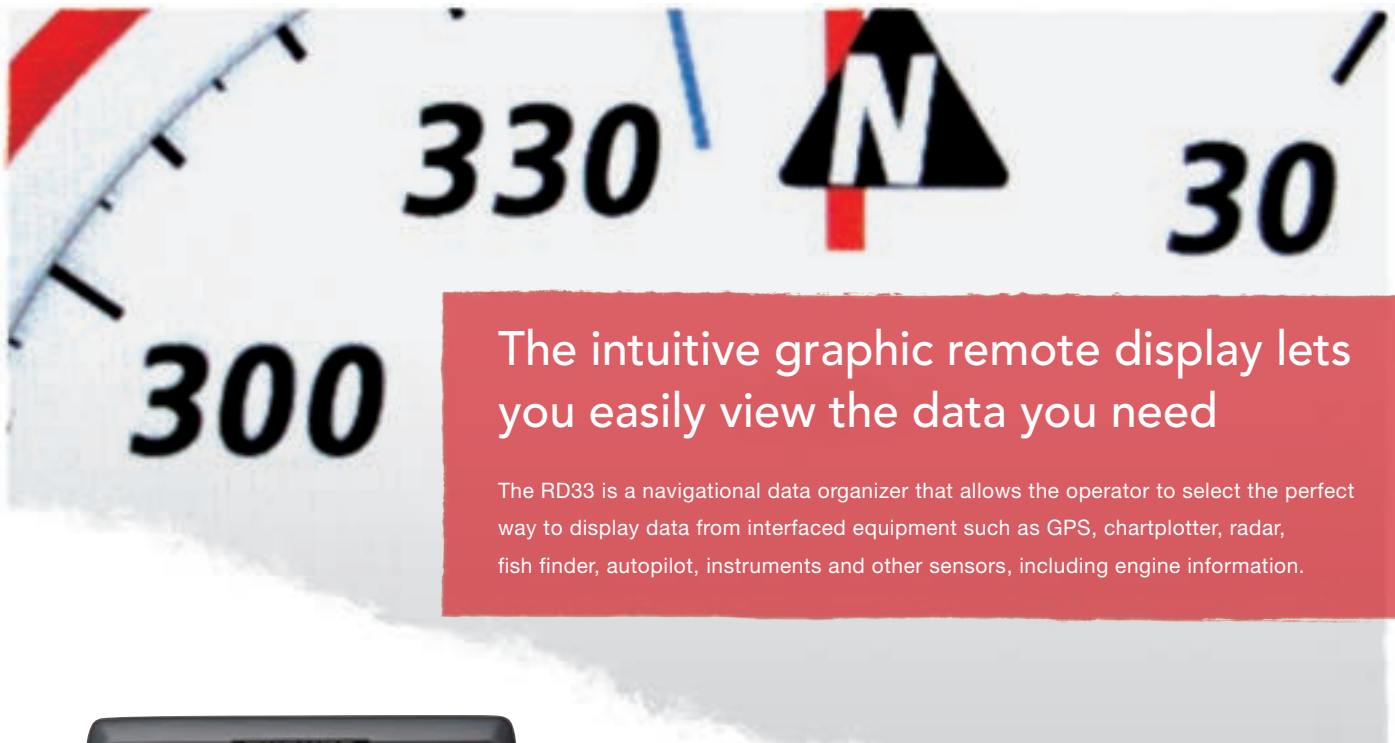

The intuitive graphic remote display lets you easily view the data you need

The RD33 is a navigational data organizer that allows the operator to select the perfect way to display data from interfaced equipment such as GPS, chartplotter, radar, fish finder, autopilot, instruments and other sensors, including engine information.



4.3" REMOTE DISPLAY
Model RD33



Remote Display

RD33

Two different styles of presentation available



SOG



Heading



Roll & Pitch

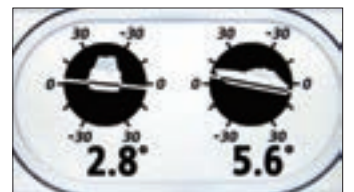

Wind

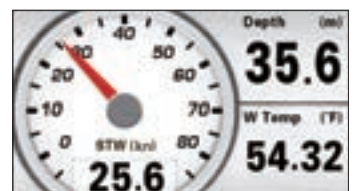

- 4.3" "Sunlight Viewable" color LCD
- Maximum visibility under various ambient conditions, both during night, and under direct sunlight (brightness of LCD is 700 cd/m²)
- Enhanced data legibility thanks to large characters and high resolution visual aid
- Full-screen single presentation down to six-way split screen presentation available
- Supports both CAN bus and NMEA0183 interface
- Two independent CAN bus input and output ports incorporated for daisy chain networking
- Internal NMEA0183/CAN bus conversion capability available
- Straightforward operation comparable to NavNet series

Revolutionary heading sensor with advanced GPS technology

Our SC30/50/110 Satellite Compasses use advanced GPS Kinematic technology to constantly update heading, heaving, and roll & pitch information. Unlike conventional magnetic and gyro compasses, accuracy is not affected by G-force or velocity. They are also free from routine maintenance, because there are no moving parts!



Compass

- SC30
- SC50/SC110
- PG700
- PG500R



Basic specifications of SC30

	SC30
Heading Accuracy	0.5° rms
GPS Fix	10m (95%)
DGPS Fix	N/A
WAAS Fix	3m (95%)
Follow-up Rate	45° per sec.
Setting Time	3 min
Antenna Unit	Radome

SATELLITE COMPASS
Model **SC30**



2009/2010/2011

- Combine with Radar for constant target tracking and stable echo trails
- Combine with Radar and Chart Plotter for spot-on Radar Overlay
- Combine with Sonar and Fish Finder for stable echo images and accurate ship's track information
- Combine with NAVpilot for precise autopilot control

RADAR

Models: NavNet TZtouch2/TZtouch/NavNet 3D/FR8005 series/etc

True Motion Echo Trail

True echo trails are available when the satellite compass is connected to your FURUNO radar. True echo trails are helpful for determining own ship's movement as well as the movement of other vessels. Heading accuracy and sensing speed ensures that trails are displayed in smooth lines.

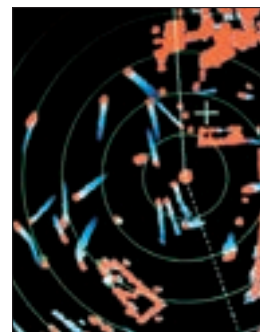

FISH FINDER

Models: NavNet TZtouch2/TZtouch/NavNet 3D/FCV1150/etc

Heaving Compensation

The satellite compass provides compensation data to your Fish Finder to present a display free from undulations due to heaving in rough seas.

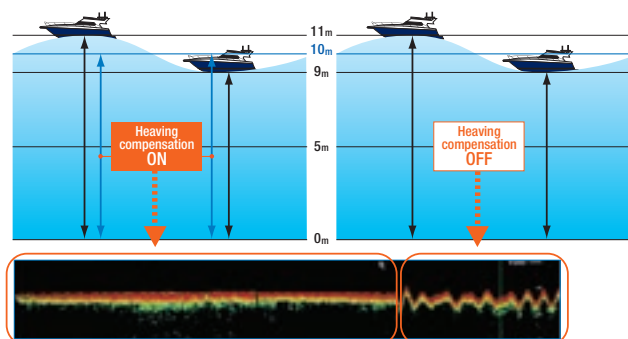

SONAR Models: CH300/CH270/CH250/etc

Pitch And Roll Compensation

Pitch and Roll Compensation data allows FURUNO sonar systems to display a steady image on the screen and facilitates stable detection, even in foul weather.

Beam Stabilizer ON

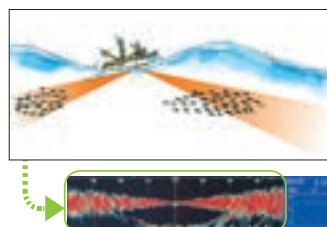

Beam Stabilizer OFF

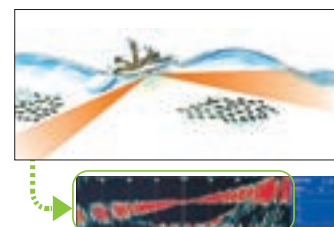

»» Spec P103

SATELLITE COMPASS™



SATELLITE COMPASS™
Model SC50/SC110



Radome Antenna
SC303 for the SC50



Open Antenna
SC1203F for the SC110

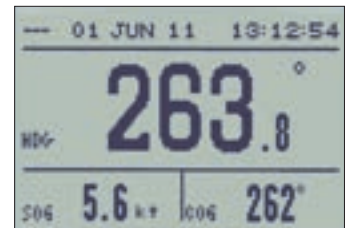

Heading

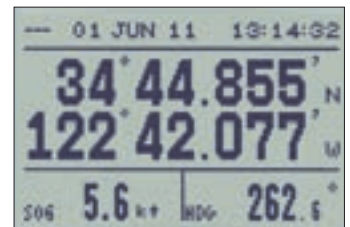

NAV Data

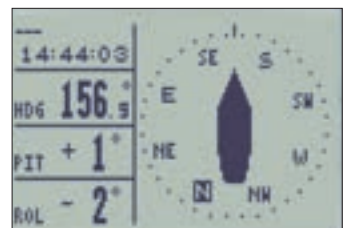

Compass Rose

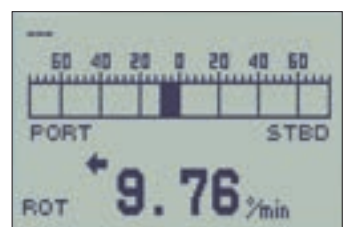

Rate of Turn

- Precise heading data for autopilot, radar, AIS, sonar and chart plotter
- Rapid follow-up rate (45°/s)
- Work as motion sensors with accurate pitch/roll data output
- 100% free from regular maintenance
- Tri-antenna system to improve the accuracy and reduce the effects of ship's motions
- Heading data output in IEC61162-2
- Pitch and roll output in both analog and digital formats allows compensation for ship's motion

Basic specifications of SC50/SC110

	SC50	SC110
Heading Accuracy	0.5° rms	0.3° rms
GPS Fix	10m (95%)	10m (95%)
DGPS Fix	5m (95%)	5m (95%)
WAAS Fix	3m (95%)	3m (95%)
Follow-up Rate	45° per sec.	45° per sec.
Setting Time	3 min	4 min
Antenna Unit	Radome/Open	Open

INTEGRATED HEADING SENSOR



INTEGRATED
HEADING SENSOR
Model **PG700**



- Provides heading data of high accuracy
- Black box type fluxgate magnetic sensor
- CAN bus interface incorporated
- Can be mounted on either the bulkhead or the floor, thanks to the L-bracket

Easy mounting with L-bracket

PG700 can be mounted on either a bulkhead or the deck with the L-bracket.*

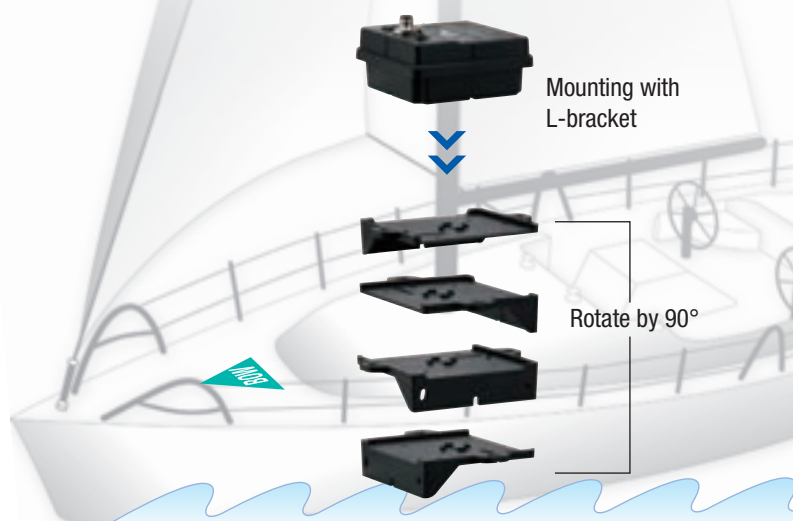

*Since the L-bracket can be rotated by 90 degrees, the PG700 on the L-bracket can face toward the bow of the craft.



INTEGRATED
HEADING SENSOR
Model **PG500R**



- Inexpensive heading sensor with the highest accuracy and stability in this class of equipment
- Automatic correction for local magnetic variation with an appropriate GPS navigator or manual correction with an optional remote display RD33
- High stability for a solid-state rate gyroscope
- Compact waterproof housing with visible status indicators for simple installation
- Three heading data output ports: two IEC/NMEA0183 ports, one AD-10 port incorporated

▶▶▶ Spec P104

Safety at sea means staying connected

Even though everything on your boat is well maintained and in good working order, you've got to be sure that you're safe, and that means receiving the correct navigational information as well as being able to send out a distress signal in case of emergency.

FURUNO offers a complete line of communications equipment to keep you connected to others, including AIS, single or multi-station radiotelephones, NAVTEX receivers, weather facsimile and Inmarsat mobile earth stations. Our broad range of communications equipment offers recreational boaters the same quality and reliability chosen by the commercial maritime community.

Communications

FA30
FA50
FA170 **NEW**
FM8900S
FS1575/FS2575

LH3000
NX300
FAX30
FAX408
FELCOM250/500*

AIS RECEIVER



AIS Receiver
Model **FA30**



- Enhances safe navigation by receiving critical navigation information from local AIS-equipped vessels.
- Network output to NavNet and PCs for added redundancy and installation flexibility
- Serial Output for integration with various radar and chart plotter systems

Information to be received

- | | |
|------------------------|--|
| Dynamic Data | <ul style="list-style-type: none"> • Ship's position • Course over ground (COG) • Speed over ground (SOG) • Rate of turn (ROT)* • Heading • Navigation status* |
| Static Data | <ul style="list-style-type: none"> • MMSI (Maritime Mobile Service Identity) • IMO number* • Ship's name • Type of ship • Call sign • Length and beam • Location of position-fixing antenna on the ship |
| Voyage Related Data | <ul style="list-style-type: none"> • Ship's draft* • Hazardous cargo • Destination and ETA* |
| Safety-related message | |

* Class-A AIS only

AIS TRANSPONDER



Class B
AIS Transponder
Model **FA50**



- Fully satisfies the technical standards for Class-B AIS, IEC 62287-1
- Receives both Class-A and Class-B AIS information
- Outputs data to NavNet TZtouch2/TZtouch, 3D through Ethernet
- Flexible integration with various AIS compatible radar and chart plotters



NEW

CLASS A AIS TRANSPONDER
Model **FA170**



- Complies with IMO MSC. 74(69) Annex 3, IMO MSC.302(87), A694, ITU-R M. 1371-5 and DSC ITU-R M.825. It also complies with, IEC 61993-2 (Type testing standard) and IEC 60945 Ed. 4 (EMC and environmental conditions).
- Display information about the AIS-equipped ships, as well as, coastal stations and Aids to Navigations within VHF coverage
- Outputs AIS data to NavNet TZtouch2/TZtouch/3D, radar and other navigational equipment for collision avoidance support

Plotter display



AIS symbols

- | | | | | | |
|--|-----------------|--|------------------------------|--|----------------------------|
| | Own ship symbol | | AIS base station | | AIS-SART/AIS MOB/EPIRB-AIS |
| | Target | | Aid to Navigation (physical) | | SAR aircraft |
| | Selected target | | Aid to Navigation (virtual) | | SAR vessel |

Displays symbols for AIS-equipped ships, base stations, AIS-SARTs, and so on. When you select a certain target, the information about the ship (MMSI (or name, when available), heading, SOG, COG, etc.) is displayed.

VHF RADIOTELEPHONE



VHF
RADIOTELEPHONE
Model **FM8900S**
(Simplex/Semi-duplex)



- Semi-duplex 25 W VHF radiotelephone with a built-in Class A DSC and CH70 watchkeeping receiver
- Fully meets GMDSS carriage requirements for SOLAS ships
- Meets the ITU recommendation on digital selective calling system for use in the Maritime Mobile Service, ITU-R M.493-13 or latest
- Easy to read, high-contrast 4.3" bright color LCD
- Improved noise reduction and speaker for superb voice quality
- Quick access to CH16
 - Press the CH16 key on the keypad to switch to radiotelephone display and select CH16 instantly
- Easy channel selection with rotary control or direct keypad input
- Automatic entry of own ship position and time through the interfaced GPS receiver
- ATIS signal transmission available for inland waterways
- Replay of the latest receiving voice, which is automatically recorded, for 120 seconds

►►► Spec P107

MF/HF RADIOTELEPHONE VHF RADIOTELEPHONE



MF/HF
RADIOTELEPHONE
Model **FS1575/FS2575**
(150 W) (250 W)



- MF/HF radiotelephone with DSC facility
- Fully meets GMDSS carriage requirements for SOLAS ships operating in A3 and A4 sea areas
- Meets the new ITU recommendation on digital selective calling system for use in the Maritime Mobile Service, ITU-R M.493-13
- High-contrast 4.3" bright color LCD (480x272 pixels)
- Capable of distress, safety and routine communication
- Instant selection of 256 user-specified channels with a rotary knob or direct keypad input
- Quick access to DSC message composition by dedicated keys on the control unit
- Quick access to dedicated functions in the menu operation using numeric keypad

►►► Spec P106

LOUD HAILER



LOUD HAILER
Model **LH3000**

- High-performance, 20 W output power loud hailer
- Built in, high-quality speaker
- Hail, Intercom and Alarm functions
- Eight automatic warning signals
- Up to four intercoms are connectable for two-way communication between master and one or all remote stations



Optional Intercom Speaker
Model **LH3010**

Low profile, solidly built intercom speakers can be installed on the deck or flybridge.

- Backlit keys for nighttime operation
- Audio input for CD, radio, etc.
- LED indicators keep you informed of equipment status
- Optional low-profile, quality speakers for installation on deck or fly bridge

▶▶▶ *Spec P108*

NAVTEX RECEIVER



NAVTEX RECEIVER
Model **NX300**

- Paper-free Navtex receiver
- Selectable frequency for both international and domestic/local Navtex messages
- Uninterrupted reception of Navtex messages
- Memory for up to 28,000 characters
- High contrast 4.5" Silver Bright LCD
- Nav data display when connected to external GPS
- Automatic selection of the Navtex station according to position when connected to external GPS
- Low power consumption
- Memory backup with long-life lithium battery

Message Category

- | | |
|--|--|
| A Navigation warning | I Reserved - presently not used |
| B Meteorological warning | J Differential omega message |
| C Ice report | K Other electronic navigational aid and system message |
| D Search and rescue information/piracy and armed robbery | L Navigational warning (additional) |
| E Meteorological forecast | M-Y Reserved - presently not used |
| F Pilot message | V Notice to Fishermen (US only) |
| G AIS service message | Z QRU (no message on hand) |
| H Loran-C message | |



Message List

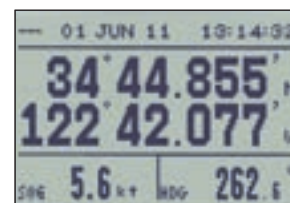

Nav Data

▶▶▶ *Spec P108*

WEATHER FACSIMILE RECEIVER



WEATHER FACSIMILE
RECEIVER
Model **FAX408**

- Provides weather charts and satellite images in nine gray levels on 8" thermal paper
- Electronic scanning with thermal head recording system provides high quality facsimile images
- 9-tone gradation recording provides clear and detailed weather images
- Automatic channel selection by judging the quality of signal reception
- All known facsimile channels in 2-25 MHz bands are pre-programmed: 150 channels
- Additional memory capacity of 164 user-programmable channels available
- Full automatic operation by a built-in schedule timer (16 programs can be set per week for automatic operation)
- Quiet thermal printing due to minimal mechanical components

▶▶▶ Spec P109

WEATHER FACSIMILE RECEIVER



BLACK BOX WEATHER
FACSIMILE RECEIVER
Model **FAX30**



*A PC is to be procured locally.

- Cost effective paperless weatherfax and Navtex receiver
- Connect directly to a NavNet display or through an Ethernet hub
- Connect to a PC equipped with Ethernet
- Selectable display colors: 8 gray tones, monochrome, blue shades, pink and black, red and blue
- User friendly softkey menu operation on NavNet display
- Web browser navigation on PC, no proprietary software required
- Print images and messages from PC and printer
- Store a maximum of 12 weather fax images (depending on file size)
- Navtex messages can be retrieved in a table listing of up to 130 stored files
- Stored images/messages can be shown at any time
- 320 user programmed channels
- Noise rejection for clear image
- Thumbnail view for easy selection of stored images

▶▶▶ Spec P109

INMARSAT FleetBroadband



- IP handsets and Incoming Indicators (option) can be integrated through Ethernet
 - Multiple IP handsets can be incorporated into the network by using the switching hub
 - Different ringtones can be set for each of the communication lines for easy recognition of the incoming calls
- IP-PBX incorporated
 - Comprehensive selection of telephone exchange functions available, i.e., internal communication lines, incoming call routing, etc.
 - Wide range of incoming call settings available, i.e., group call function, etc.
- Built-in NAT router facilitates smooth network integration to the Internet
- Wide variety of security settings available, i.e., firewall, IP filter, etc.
- No dedicated software required for configuration setup (web server function incorporated)
 - Configuration setup can be done by using a web browser
- Supports PPPoE to facilitate automatic dial-up connection/disconnection via applications

FleetBroadband System Configuration

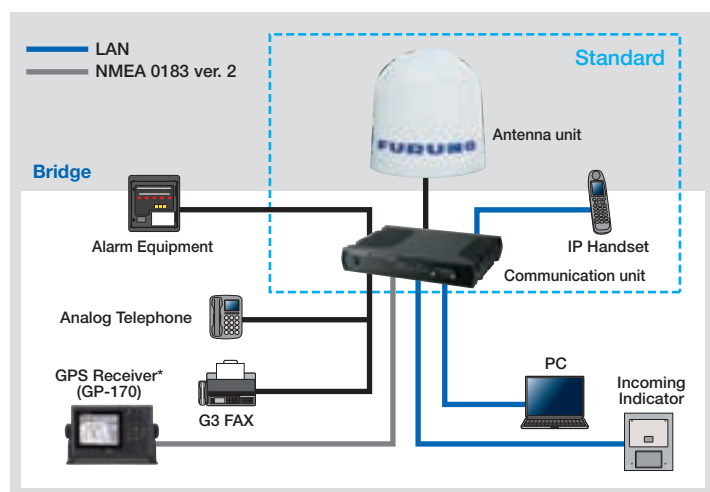

Equipment List

Model	FELCOM250	FELCOM500
Standard		
1. Antenna Unit	FB-1250	FB-1500
2. Communication Unit	FB-2000	
3. IP Handset	FB-8000	
Option		
Incoming Indicator	FB-3000	
Analog Telephone	GEMINI 9333B4	
G3 FAX	FAX2840JP/2840	
AC/DC Power Supply Unit	PR-240	



*A vessel needs to notify Inmarsat Satellite of which spot beam area the vessel is located in. This way, the Inmarsat Satellite can transmit the spot beam to the vessels location.



Technical Specifications

NavNet Series	68
Radar	77
GPS/Chart Plotter	87
Fish Finder	90
Sonar	94
Autopilot	97
Instrument	98
Monitors	100
Remote Display	102
Compass	103
Communications	105

NavNet TZtouch2

		MULTI FUNCTION DISPLAY	
		TZTL12F	TZTL15F
			
DISPLAY UNIT			
Type	Color TFT multi touch LCD		
Screen Size	12.1" Wide	15.6" Wide	
Screen Resolution	WXGA 1280 x 800	FWXGA 1366 x 768	
Screen Brightness	1300 cd/m ² (typical)	1000 cd/m ² (typical)	
Language	English (US & UK), French, Spanish, German, Italian, Portuguese, Swedish, Danish, Norwegian, Finnish, Greek, Chinese (simplified), Japanese		
GPS/WAAS			
Receiver Type	GPS: 56 channels, SBAS: 1 channel (C/A mode, WAAS)		
Receiving Frequency	L1 (1575.42 MHz)		
Time to First FIX	100 s (cold start)		
Tracking Velocity	999 kn		
SBAS	WAAS, EGNOS, MSAS		
ACCURACY			
Internal Antenna	GPS: 10 m Max, WAAS: 3 m Max, MSAS: 7 m Max		
CHART PLOTTER			
Cartography	MapMedia mm3d chart (C-MAP/Navionics/NOAA)		
Memory Capacity	30,000 user points, 30,000 points for ship's tracks, 200 planned routes (500 points per route)		
Alarms	Anchor Watch, XTE, Proximity, Depth, Temperature, Speed, etc.		
RADAR			
Display Modes	Head-up*, North-up *Heading input required.		
Echo Trail	Interval: 15 s, 30 s, 1 min, 3 mins, 6 mins, 15 mins, 30 mins and continuous		
Target Tracking	30 Targets* *Heading input required.		
FISH FINDER			
Transmit Frequency	50/200 kHz		
Transmission Power	600 W or 1 kW* *Matching box MB-1100 required for some FURUNO transducers.		
Display Range	2-1, 200 m, shift: 0-500 m		
Extension Mode	RezBoost, ACCU-FISH, Bottom Discrimination, A-Scope, Auto (Fishing/Cruising/Manual), Marker Zoom, Bottom Zoom, Bottom Lock		
Picture Advance	7 steps: x2, x1, 1/2, 1/4, 1/8, 1/16 stop		
INTERFACE			
CAN bus/NMEA2000	1 Port		
Interface (CAN bus/NMEA2000)	Input	059392, 059904, 060928, 061184, 065280, 126208, 126720, 126992, 126996, 127237, 127245, 127250, 127251, 127257, 127258, 127488, 127489, 127505, 128259, 128267, 129025, 129026, 129029, 129033, 129038, 129039, 129040, 129041, 129291, 129538, 129540, 129793, 129794, 129798, 129808, 129809, 129810, 130306, 130310, 130311, 130312, 130313, 130314, 130316, 130577, 130578, 130817, 130818, 130820, 130822, 130823, 130826, 130827, 130828, 130880	
	Output	059392, 059904, 060928, 061184, 126208, 126464, 126720, 126992, 126996, 127250, 127251, 127257, 127258, 128259, 128267, 129025, 129026, 129029, 129033, 129283, 129284, 129285, 130306, 130310, 130312, 130313, 130314, 130316, 130821, 130822, 130823, 130827	
NMEA0183	1 Integrated Output Port		
Interface (NMEA0183)	Output	AAM, APB, BOD, DPT, DBT, GGA, GLL, GNS, GSA, GSV, RMB, RMC, RTE, TTM, VTG, WPL, XTE, ZDA	
LAN	1 Port (100 BASE-TX)		
USB	1 Port (USB2.0)		
Video I/O	Input: 2 Ports (NTSC/PAL), Output: 1 Port (HDMI)		
AUX I/O	1 Port (External Event/MOB Input/Operator Fitness/Alarm Output)		
SD Card Slot	1 Slot (Micro SDXC, rear), 2 Slots Card Unit: Model SDU-001 (option)		
Wireless LAN	IEEE802.11b/g/n, Transmit frequency: 2.4 GHz band		
Transducer	1 Port		
ENVIRONMENT			
Temperature (IEC60945)	-15°C to +55°C		
Waterproofing	IP56		
POWER			
		12-24 VDC	
		3.0-1.5 A	3.6-1.8 A

Multi Function Display (Tabletop Mount) TZTL12F 3.8 kg 8.4 lb

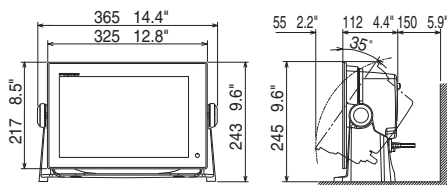

Multi Function Display (Flush Mount) TZTL12F

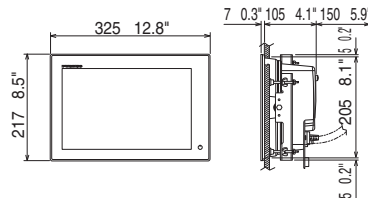

3.7 kg 8.2 lb

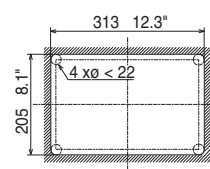

SD Card Unit SDU-001 (option)

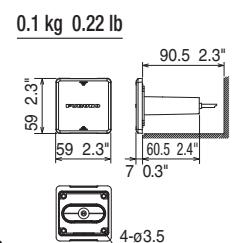

Multi Function Display (Tabletop Mount) TZTL15F 5.5 kg 12.1 lb

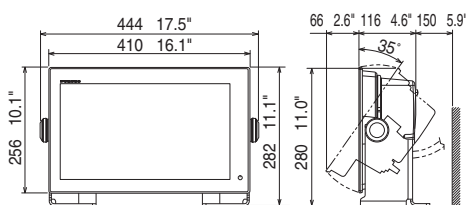

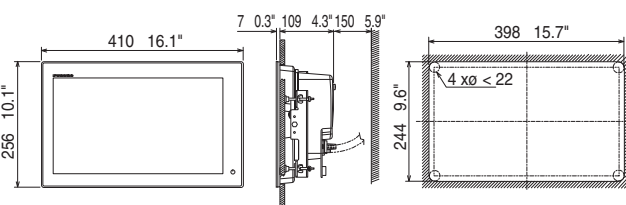

Multi Function Display (Flush Mount) TZTL15F



4.9 kg 10.8 lb

NavNet TZtouch

		MULTI FUNCTION DISPLAY	
		TZT9	TZT14
			
DISPLAY UNIT			
Type		Color TFT multi touch LCD	
Screen Size		9" wide	14.1" wide
Screen Resolution		WVGA 800 x 480	WXGA 1280 x 800
Screen Brightness		900 cd/m ² (typical)	
Language		English (US & UK), French, Spanish, German, Italian, Portuguese, Swedish, Danish, Norwegian, Finnish, Greek, Chinese (simplified Chinese characters), Japanese	
CHART PLOTTER			
Cartography		MapMedia mm3d chart (C-MAP/Navionics/NOAA)	
Memory Capacity		30,000 user points, 30,000 points for ship's tracks, 200 planned routes (500 points per route)	
Alarms		Anchor Watch, XTE, Proximity, Depth, Temperature, Speed, etc.	
RADAR			
Display Modes		Head-up, North-up* *Heading input required.	
Echo Trail		Interval: 15 s, 30 s, 1 min, 3 mins, 6 mins, 15 mins, 30 mins and continuous	
Target Tracking		30 Targets* *Heading input required.	
INTERFACE			
CAN bus		1 Port	
Interface (CAN bus)	Input	059392, 059904, 060928, 061184, 065280, 126208, 126720, 126992, 126996, 127237, 127245, 127250, 127251, 127257, 127488, 127489, 127505, 128259, 128267, 129025, 129026, 129029, 129033, 129038, 129039, 129040, 129041, 129044, 129538, 129540, 129793, 129794, 129798, 129808, 129809, 129810, 130306, 130310, 130311, 130312, 130313, 130314, 130577, 130578	
	Output	059392, 059904, 060928, 061184, 126208, 126464, 126720, 126992, 126996, 127250, 127251, 127257, 127258, 128259, 128267, 129025, 129026, 129029, 129033, 129283, 129284, 129285, 130306, 130310, 130312, 130313, 130314	
LAN		1 Port (100 BASE-TX)	3 Ports (100 BASE-TX)
USB		1 Port (USB2.0)	
Video Output		1 Port (DVI-D)	
Video Input		2 Ports (NTSC/PAL)	
Line Out		1 Port	
MIC In		1 Port	
SD Card Slot		2 Slots (SDXC card - supports upto 128 GB)	
ENVIRONMENT			
Temperature (IEC60945)		-15°C to +55°C	
Waterproofing		IP56 (with connector cover), IP22 (with connector boot)	
POWER			
Power Supply		12-24 VDC	
Power Consumption		42 W (3.5 - 1.8 A)	60 W (5.0 - 2.5 A)

Multi Function Display (Tabletop Mount) TZT9 4.7 kg 10.4 lb

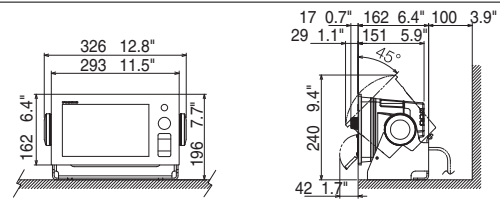

Multi Function Display (Flush Mount) TZT9 4.5 kg 9.9 lb

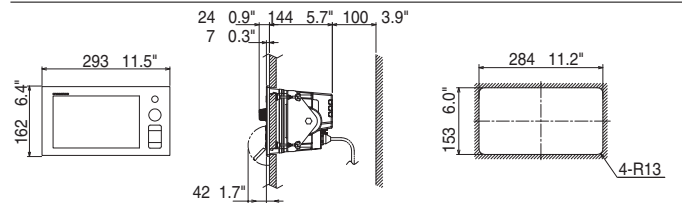

Multi Function Display (Tabletop Mount) TZT14 8.0 kg 17.6 lb

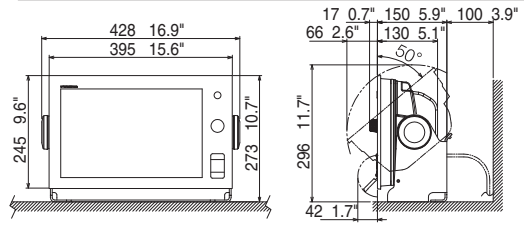

Multi Function Display (Flush Mount) TZT14 7.1 kg 15.6 lb

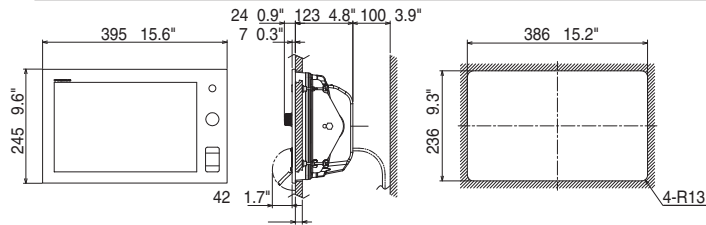

MULTI FUNCTION DISPLAY BLACK BOX		
TZTBB		
		
DISPLAY UNIT		
Type	Custom multi-touch panel monitor of your choice	
Screen Resolution	Supports both wide and non-wide resolutions: 1280 x 720 (16:9), 1280 x 800 (16:10), 1280 x 960 (4:3), 1280 x 1024 (5:4)	
Language	English (US & UK), French, Spanish, German, Italian, Portuguese, Swedish, Danish, Norwegian, Finnish, Greek, Chinese (simplified Chinese characters), Japanese	
CHART PLOTTER		
Cartography	MapMedia mm3d chart (C-MAP/Navionics/NOAA)	
Memory Capacity	30,000 user points, 30,000 points for ship's tracks, 200 planned routes (500 points per route)	
Alarms	Anchor Watch, XTE, Proximity, Depth, Temperature, Speed, etc.	
RADAR		
Display Modes	Head-up, North-up* * Heading input required.	
Echo Trail	Interval: 15 s, 30 s, 1 min, 3 mins, 6 mins, 15 mins, 30 mins and continuous	
Target Tracking	30 Targets* *Heading input required.	
INTERFACE		
CAN bus	1 Port	
Interface (CAN bus)	Input	059392, 059904, 060928, 061184, 065280, 126208, 126720, 126992, 126996, 127237, 127245, 127250, 127251, 127257, 127258, 127488, 127489, 127505, 128259, 128267, 129025, 129026, 129029, 129033, 129038, 129039, 129040, 129041, 129538, 129540, 129793, 129794, 129798, 129808, 129809, 129810, 130306, 130310, 130311, 130312, 130313, 130314, 130577, 130578
	Output	059392, 059904, 060928, 061184, 126208, 126464, 126720, 126992, 126996, 127250, 127251, 127257, 127258, 128259, 128267, 129025, 129026, 129029, 129033, 129283, 129284, 129285, 130306, 130310, 130312, 130313, 130314
LAN	3 Ports (100 BASE-TX)	
USB	6 Ports (USB2.0)	
Video Output	2 Ports (DVI-D)	
Video Input	2 Ports (NTSC/PAL)	
Line Out	1 Port	
SD Card Slot	2 Slots (SDXC card - supports upto 128 GB)	
ENVIRONMENT		
Temperature (IEC60945)	-15°C to +55°C	
Waterproofing	Processor unit: IP22 Switch box: IP56 (front panel)	
POWER		
	12-24 VDC	
	43.2 W, 3.6-1.8 A (includes switch box)	

Multi Function Display Black Box TZTBB MPU-002

8 kg 17.6 lb

Multi Function Display Black Box TZTBB Switch Box PSD-002

0.75 kg 1.7 lb

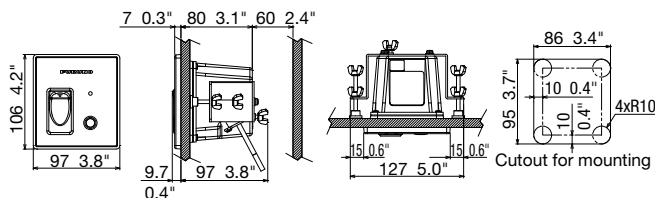
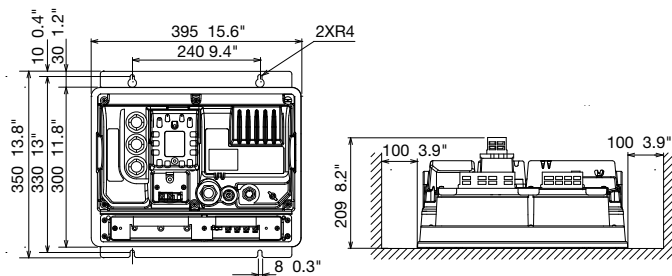

Remote Control Unit MCU-002 (option)

0.14 kg 0.3 lb

Remote Control Unit MCU-004 (option)

0.4 kg 0.9 lb

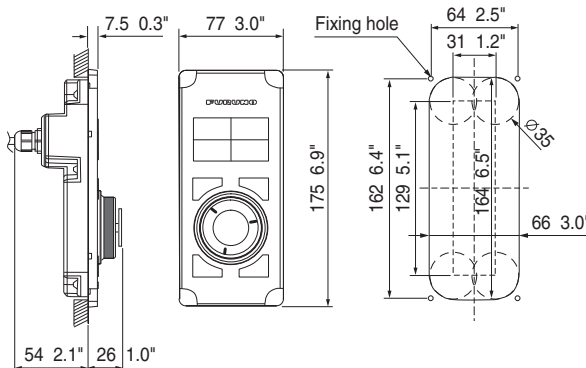
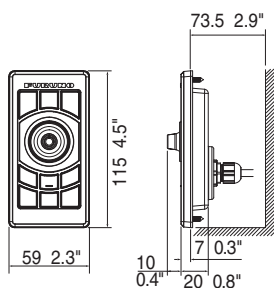

NavNet 3D

MULTI FUNCTION DISPLAY		
MFDBB		
		
DISPLAY UNIT		
Type	Custom monitor of your choice	
Screen Size	Please refer to the specifications of MU150HD/MU190HD	
Screen Resolution	SVGA 800 x 600 pixels, XGA 1024 x 768 pixels or SXGA 1280 x 1024 pixels	
Display Colors	Chart Plotter/Menu: 262,144 colors Fish Finder: 64 colors Radar: 256 colors	
Language	English (US & UK), French, Spanish, German, Italian, Portuguese, Swedish, Danish, Norwegian, Finnish, Dutch, Chinese (simplified Chinese characters), Japanese	
PLOTTER CHARACTERISTICS		
Memory Capacity	Up to 10,000 points for ship's tracks, 2000 user points, 200 planned routes (100 points per route)	
Display Modes	Course plot, NAV data, Navigational instrument display, Engine monitoring display	
Latitude Limit	Between 85°N and 85°S	
Alarms	Anchor Watch, XTE, Proximity, Depth, Temperature, Speed, Trip Log, Countdown, Timer, Alarm Clock	
RADAR CHARACTERISTICS		
Display Modes	Head-up, Course-up*, North-up*, Relative Motion, True Motion** (*Heading input required **Heading and speed inputs required)	
ARPA Target Tracking	30 targets	
AIS Target Tracking	up to 100 targets	
Echo Trail	Interval: 15 s, 30 s, 1 min, 3 mins, 6 mins, 15 mins, 30 mins and continuous	
INTERFACE		
Ethernet	4-Port Hub is included, 100 BASE-TX	
NMEA0183	3 Ports for Input/Output	
Interface (NMEA0183)	Input: DBK, DBS, DBT, DPT, DTM, GGA, GLL, GNS, HDG, HDM, HDT, MDA, MTW, MWV, RMA, RMC, ROT, VDM, VHW, VTG, VWR, VWT, ZDA, FURUNO Proprietary Sentences are used for pitch, roll and heave data input from FURUNO Satellite Compass SC series.	
	Output: AAM, APB, BOD, BWC, BWR, DBT, DPT, DTM, GGA, GLL, GNS, GTD, HDG, HDT, MTW, MWV, RMA, RMB, RMC, ROT, VHW, VTG, WPL, XTE, ZDA, ZTG, FURUNO Proprietary Sentence is used for true heading, pitch and roll data output.	
CAN bus/NMEA2000	1 Port	
Interface (CAN bus/NMEA2000)	Input: 059392, 059904, 060928, 126208, 126992, 126996, 127245, 127250, 127251, 127257, 127258, 127488, 127489, 128259, 128267, 129025, 129026, 129029, 129033, 129044, 129538, 129540, 130306, 130310, 130311, 130577	
	Output: 059392, 059904, 060928, 126208, 126464, 126992, 126996, 127245, 127250, 127251, 127257, 127258, 128275, 128259, 128267, 129025, 129026, 129029, 129033, 129283, 129284, 130306, 130310, 130311	
USB Port	2 Ports (USB 2.0)	
Video Output	2 Ports (DVI-D)	
Video Input	4 Ports (NTSC/PAL)	
Line Out	1 Port	
SD Card Slot	2 Slots	
Variable Line Level Stereo Output	1 Port	
ENVIRONMENT		
Temperature	Processor Unit	0°C to +45°C
	Control Unit	-15°C to +55°C
Waterproofing	Processor Unit	IP20
	Control Unit	IP56 (MCU-001 when flush mounted)
POWER SUPPLY		
12-24 VDC		
104 W/149 W (with DRS2D)/154 W (DRS4D)/195 W (with DRS4A)/		
207 W (with DRS6A)/222 W (with DRS12A)/249 W (with DRS25A)		
100/110/220/230 VAC with optional rectifier RU-1746B-2		

Multi Function Display MFDBB
Black Box Processor Unit MPU-001

15.0 kg 33.1 lb

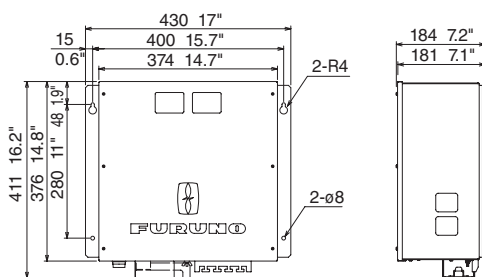



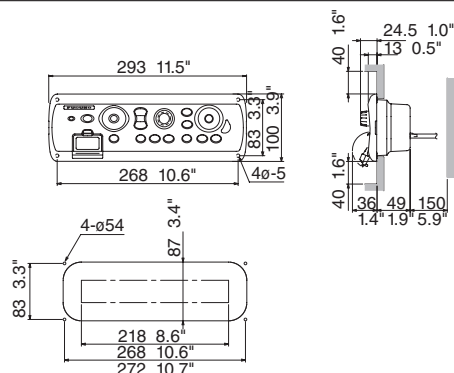

Black Box
Control Unit MCU-001

1.0 kg 2.2 lb



NavNet Series

NETWORK FISH FINDER/BOTTOM DISCRIMINATION SOUNDER		
	DFF1	BBDS1
		
TRANSCEIVER & DISPLAY		
Display Modes	Single (50 or 200 kHz), Dual (50 and 200 kHz), Bottom-lock, Bottom-Zoom, ACCU-FISH, Marker Zoom, A-scope	Single (50 or 200 kHz), Dual (50 and 200 kHz), Bottom-lock, Bottom-Zoom, ACCU-FISH, Bottom Discrimination, Marker Zoom, A-scope
Frequency	Dual frequency 50 kHz and 200 kHz	
Broadband	N/A	N/A
Range Scale	Max. 1,200 m	Max. 1,200 m
ENVIRONMENT		
Temperature	-15°C to +55°C	
Waterproofing	IP20	
POWER SUPPLY		
	12-24 VDC	
	12 W, 1.1-0.4 A	12 W, 1.1-0.4 A
TRANSDUCERS (Specify when ordering)		
	600 W 50/200 kHz: 520-5PSD (Plastic, thru-hull), 520-5MSD (Bronze, thru-hull), 520-5PWD (Plastic, transom), 525STID-MSD (Bronze, thru-hull with speed/temp sensor), 525STID-PWD (Plastic, transom, with speed/temp sensor) 1 kW (Optional Matching Box, MB-1100 may be required) 50 kHz: 50B-6, 50B-6B, 50B-9B 200 kHz: 200B-5S, 50/200 kHz: 50/200-1T, 50/200-12M	600 W 50/200 kHz: 520-5PSD (Plastic, thru-hull), 520-5MSD (Bronze, thru-hull), 520-5PWD (Plastic, transom), 525STID-MSD (Bronze, thru-hull with speed/temp sensor), 525STID-PWD (Plastic, transom with speed/temp sensor) 1 kW (Optional Matching Box, MB-1100 may be required) 50/200 kHz: 50/200-1T, 50/200-12M

NETWORK FISH FINDER		
	DFF1-UHD	DFF3
		
TRANSCEIVER & DISPLAY		
Display Modes	Single (High or Low frequency), Dual (Both High and Low frequencies), Bottom-lock, Bottom-Zoom, ACCU-FISH, Bottom Discrimination, Marker Zoom, A-Scope	Single (high or low), Dual (high and low), Bottom-lock, Bottom-Zoom, ACCU-FISH*, Marker Zoom, A-scope * with 50/200-1T only.
Frequency	Dual frequency 50 ±20 & 200 ±25 kHz	The synthesized transducer works with dual frequencies between 28 and 200 kHz
Broadband	Available	N/A
Range Scale	Max. 1,200 m	Max. 3,000 m
ENVIRONMENT		
Temperature	-15°C to +55°C	
Waterproofing	IP55	IP20
POWER SUPPLY		
	12-24 VDC	
	30 W, 2.8-1.4 A	30 W, 3.5 A
TRANSDUCERS		
	1 kW Broadband transducers by AIRMAR® 42-65 kHz (low), 130-210 kHz (high) CM265LH, B265LH (with temperature sensor)	(Specify when ordering) 1/2/3 kW 28 kHz: 28F-8, 28F-18, 28BL-6HR, 28F-24H, 28BL-12HR 38 kHz: 38BL-9HR, 38BL-15HR 50 kHz: 50B-6/6B, 50B-9B, 50B-12, 50BL-12HR, 50F-24H, 50BL-24HR 68 kHz: 68F-8H, 68F-30H 82 kHz: 82B-35R 88 kHz: 88B-8, 88B-10, 88F-126H 107 kHz: 100B-10R 150 kHz: 150B-12H 200 kHz: 200B-5S, 200B-8/8B, 200B-12H 50/200 kHz: 50/200-1ST, 50/200-1T, 50/200-12M

Network Fish Finder DFF1/Bottom Discrimination Sounder BBDS1 1.3 kg 2.9 lb

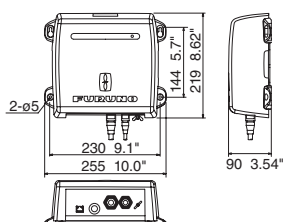

Network Fish Finder DFF1-UHD 3.1 kg 6.8 lb

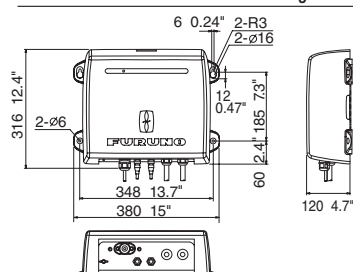

Network Fish Finder DFF3 3.8 kg 8.4 lb

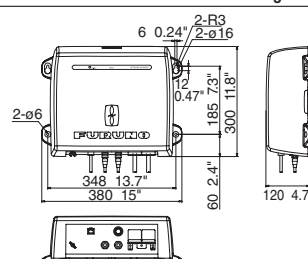

NavNet Series

TRANSDUCER LIST for NavNet TZtouch2 Built-in RezBoost™ Fish Finder								
	Frequency	Type	Matching Box required	Mount	Output Power	ACCU-FISH™ mode	Bottom Discrimination Display	RezBoost™
TRANSDUCER	50/200 kHz	520-5PSD		Thru-hull	600 W	●	●	●
		525-5PWD		Transom		●	●	●
		520-5MSD		Thru-hull		●	●	●
		520-PLD		Thru-hull		●	●	●
	50/200-1T	○	Thru-hull	1 kW	●	●	●	
	50 kHz	50B-6	○	Thru-hull	1 kW	—	—	—
		50B-6B	○	Thru-hull		—	—	—
200 kHz	200B-5S	○	Thru-hull		—	—	—	
TRIDUCER	50/200 kHz	525T-BSD		Thru-hull	600 W	●	●	●
		525T-PWD		Transom		●	●	●
		525T-LTD/12		Thru-hull		●	●	●
		525T-LTD/20		Thru-hull		●	●	●
		SS60-SLTD/12		Thru-hull		●	●	●
		SS60-SLTD/20		Thru-hull		●	●	●
		525STID-MSD		Thru-hull		●	●	●
		525STID-PWD		Transom		●	●	●
		526TID-HDD		Thru-hull		1 kW	●	●

NETWORK MULTI-BEAM SONAR	
DFF3D	
	
TRANSCEIVER & DISPLAY	
Display Mode	Cross Section, Triple/Single Beam Sounder, Side Scan, 3D Sounder History
Frequency	165 kHz
Beam Angle	120°
Detection Range	200 m* (Side beam best performance) 350 m* (Main beam directly under boat) * Depending on bottom type and water conditions.
Range	5-1200 m
INTERFACE	
LAN	1 port, Ethernet 10/100Base-TX
External KP	1 port (optional external KP kit required)
ENVIRONMENT	
Temperature	-15°C to +55°C
Waterproofing	IP55
POWER SUPPLY	
	12-24 VDC, 1.4-0.7 A
TRANSDUCER	
	800 W B54 (with motion/temperature sensor)

Network Multi-Beam Sonar DFF-3D

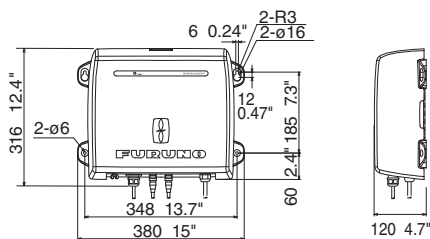

3.0 kg 6.6 lb

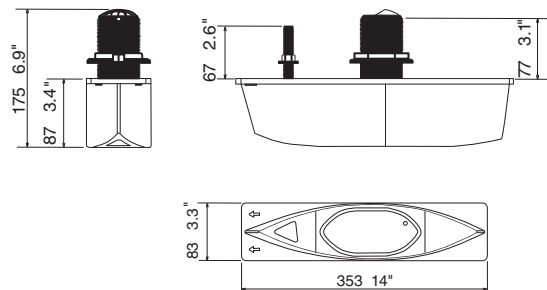

Transducer B54 with motion/temperature sensor

3.2 kg 7 lb



		NavNet Series RADAR SENSOR	NavNet Series SOLID STATE DOPPLER RADAR
		DRS4DL	DRS4D-NXT
			
ANTENNA			
Type		ø488 mm Radome (19")	ø610 mm Radome (24")
Beam Width	Horizontal	5.2°	3.9° typical (-3 dB) Adjustable between 2° and 3.9° (effective with RezBoost control)
	Vertical	25°	25°
Antenna Rotation Speed		24 rpm	24*/36/48 rpm * In dual range mode, speed is limited to 24 rpm
RF TRANSCEIVER			
Frequency		9410 ±30 MHz	CH1: 9380 MHz (P0N), 9400 MHz (Q0N) CH2: 9400 MHz (P0N), 9420 MHz (Q0N) CH3: 9420 MHz (P0N), 9440 MHz (Q0N)
Pulselength & PRR		S: 360 Hz (0.0625 to 0.5 NM) M: 360 Hz (0.75 to 2.0 NM) L: 360 Hz (3 to 36 NM)	P0N: 0.08 µs to 1.2 µs/1100 Hz Q0N: 5 µs to 18 µs/1100 Hz
Peak Output Power		4 kW	Solid-state, 25 W
Range Scales		0.0625 to 36 NM	0.0625 to 36* NM * In dual range mode, range is limited to 12 NM
ENVIRONMENT			
		Temperature: -25°C to +55°C, Waterproofing: IPX6	Temperature: -25°C to +55°C, Waterproofing: IP26
POWER SUPPLY			
		12-24 VDC, 2.1-1.0 A	12-24 VDC, 2.1-1.0 A

19' Radome Radar Sensor DRS4DL

6.5 kg 14.3 lb

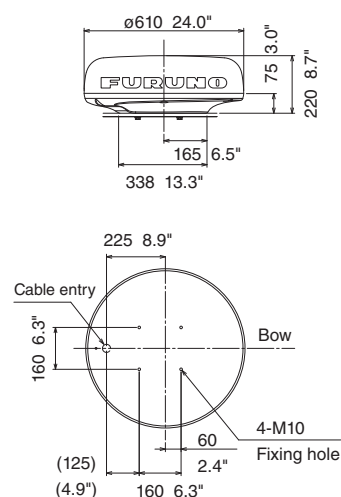
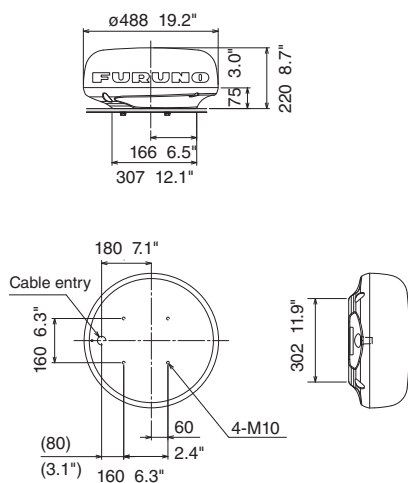

24' Radome Radar Sensor DRS4D-NXT

7.3 kg 16.1 lb





NavNet Series

NavNet Series RADAR SENSOR		
DRS6A X-Class		
		
ANTENNA		
Type	1036 mm Open (3.5')/1255 mm Open (4')/1795 mm Open (6')	
Beam Width	Horizontal	2.3°/1.9°/1.4°
	Vertical	22°/22°/22°
Antenna Rotation Speed	24/36/48 rpm range coupled or 24 rpm fixed	
RF TRANSCEIVER		
Frequency	9410 ±30 MHz	
Pulselength & PRR	0.08 µs/3000 Hz (0.0625 to 0.75 NM) 0.15 µs/3000 Hz (1 to 1.5 NM) 0.3 µs/1500 Hz (2 NM) 0.5 µs/1000 Hz (3 to 4 NM) 1.2 µs/600 Hz (12 to 64 NM) 1.2 µs/500 Hz (72 to 96 NM)	
Peak Output Power	6 kW	
Range Scales	0.0625 to 96 NM	
ENVIRONMENT		
Temperature: -25°C to +55°C, Waterproofing: IP56		
POWER SUPPLY		
24 VDC, 4 A		

NavNet Series RADAR SENSOR			
DRS12A X-Class	DRS25A X-Class		
 			
ANTENNA			
Type	1255 mm Open (4')/1795 mm Open (6')		
Beam Width	Horizontal		1.9°/1.4°
	Vertical		22°/22°
Antenna Rotation Speed	24/36/48 rpm range coupled or 24 rpm fixed		
RF TRANSCEIVER			
Frequency	9410 ±30 MHz		
Pulselength & PRR	0.08 µs/3000 Hz (0.0625 to 0.75 NM) 0.15 µs/3000 Hz (1 to 1.5 NM) 0.3 µs/1500 Hz (2 NM) 0.5 µs/1000 Hz (3 to 4 NM) 1.2 µs/600 Hz (12 to 64 NM) 1.2 µs/550 Hz (72 to 96 NM)		
Peak Output Power	12 kW	25 kW	
Range Scales	0.0625 to 96 NM		
ENVIRONMENT			
Temperature: -25°C to +55°C, Waterproofing: IP56			
POWER SUPPLY			
	24 VDC, 4.5 A	24 VDC, 5.6 A	

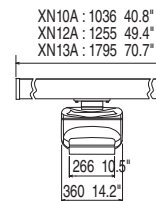
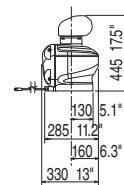
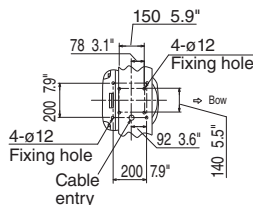
3.5' Open Radar Sensor DRS6A X-Class	20 kg 44.1 lb
4' Open Radar Sensor DRS6A X-Class	21 kg 46.3 lb
6' Open Radar Sensor DRS6A X-Class	23 kg 50.7 lb
4' Open Radar Sensor DRS12A X-Class	21 kg 46.3 lb
6' Open Radar Sensor DRS12A X-Class	23 kg 50.7 lb
4' Open Radar Sensor DRS25A X-Class	22 kg 48.5 lb
6' Open Radar Sensor DRS25A X-Class	24 kg 53 lb



GPS/WAAS RECEIVER ANTENNA		
	BBWGPS	GP330B
		
RECEIVER CHARACTERISTICS		
Receiver Type	Twelve discrete channels, C/A code, all-in-view, WAAS	
Receiving Frequency	L1 (1575.42 MHz)	
Time to First Fix	12 s (warm start) 90 s (cold start)	90 s (cold start)
Tracking Velocity	999 kn	999.9 kn
Geodetic Systems	WGS-84, NAD-27 and others	
Accuracy	10 m (GPS) 7 m (MSAS) 3 m (WAAS)	
ENVIRONMENT (IEC 60945 test method)		
Temperature	-25°C to +70°C	-25°C to +55°C
Waterproofing	IEC 60529 IPX6	IEC 60529 IP56
POWER SUPPLY		
	12-24 VDC	12 VDC
	1.3 W	1.4 W

GPS/WAAS Receiver Antenna BBWGPS
10 m cable attached

0.8 kg 1.8 lb

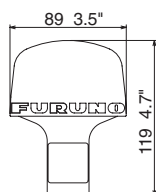

GPS/WAAS Receiver Antenna GP330B

0.22 kg 0.49 lb

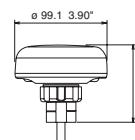





Radar

1ST WATCH WIRELESS RADAR		
DRS4W		
		
ANTENNA		
Peak Output Power	4 kW	
Type	ø488 mm Radome (19")	
Beam Width	Horizontal	7.2°
	Vertical	25°
Antenna Rotation Speed	24 rpm	
Frequency	9410 ±30 MHz	
Range Scales	0.125 to 24 NM	
Wind Load	Relative Wind 70 kn	
WIRELESS LAN		
The number of connectable iOS devices	2 units	
Transmit frequency	2.4 GHz band	
APPLICATION		
Name	"Marine Radar" from Apple App Store (Free of charge)	
Display (customer supply)	iPad/iPad mini/iPhone, iOS 6.1 or later	
Screen Orientation	Portrait/Landscape (iPad, iPad mini only)	
Language	English	
Mode	Full screen, Day/Night, Gain (auto), STC (auto), Rain, Auto Noise rejector, Guard Zone Off center, Cursor position* * iPad, iPad mini	
ENVIRONMENT		
Temperature: -25°C to +55°C, Waterproofing: IP26		
POWER SUPPLY UNIT		
12-24 VDC, 2.1-1.0 A (max)		

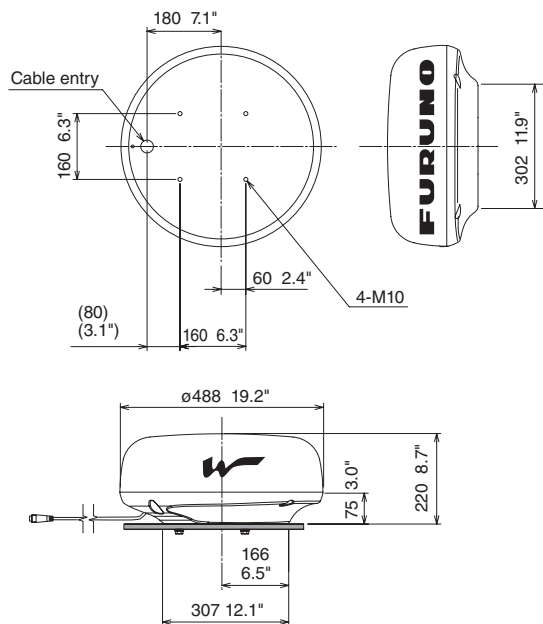
1st Watch Wireless Radar DRS4W

5.7 kg 12.5 lb



		6" SILVER LCD RADAR	7" SILVER LCD RADAR	8.4" COLOR LCD RADAR
		MODEL1623	MODEL1715	MODEL1815
				
ANTENNA				
Type		ø380 mm radome (15.0")	ø460 mm radome (18.1")	ø488 mm radome (19")
Beamwidth	Horizontal	6.2°		5.2°
	Vertical	25°		
Rotation speed		24/31/41 rpm (auto-select according to pulselength)		24 rpm
RF TRANSCEIVER				
Frequency		9410 ±30 MHz (X-band)		
Pulselength & PRR		0.125-0.75 NM: 0.08µs/3000 Hz	0.125-0.75 NM: 0.08µs/3000 Hz	0.0625-0.5 NM: 0.08 µs/360 Hz
		1-2 NM: 0.15µs/1200 Hz	1-2 NM: 0.3µs/1200 Hz	0.75-2 NM: 0.3 µs/360 Hz
		3-16 NM: 0.8µs/600 Hz	3-24 NM: 0.8µs/600 Hz	3-36 NM: 0.8 µs/360 Hz
Output power		2.2 kW		4 kW
IF frequency	IF	60 MHz		
	BW	15 MHz (0.125-0.75 NM) 5 MHz (1-16 NM)	15 MHz (0.125-0.75 NM) 5 MHz (1-24 NM)	20 MHz (0.0625-0.5 NM) 4.5 MHz (0.75-36 NM)
DISPLAY				
Display unit		6" monochrome LCD	7" monochrome LCD	8.4" color LCD
Effective display area		90 (W) x120 (H) mm	102 (W) x 138 (H) mm	128.2 (W) x 170.9 (H) mm
Resolution		240 x 320		640 x 480, VGA
Accuracy	Range	1.0% of range in use or 8 m, which is greater		1.0% of range in use or 0.01 NM, which is greater
	Bearing	EBL accuracy ±1°		
Range and range ring interval	Range	0.0625, 0.125, 0.25, 0.5, 0.75, 1, 1.5, 2, 3, 4, 6, 8, 12, 16, 24*, 36** NM		*MODEL1715/1815 ** MODEL1815 only
	Ring	0.03125, 0.0625, 0.125, 0.125, 0.25, 0.25, 0.5, 0.5, 1, 1, 2, 2, 3, 4, 6*, 12** NM		*MODEL1715/1815 ** MODEL1815 only
Echo trail		interval: 30 s, 1, 3, 6 min. or continuous		
Interface (IEC61162, NMEA0183)	Input	GGA, RMC, RMA, RMB, GLL, VTG, VBW, VHW, HDT, HDG, HDM, BWR, BWC, GLC, GTD, DPT, DBK, DBS, DBT, MTW, ZDA, MWV, XTE		ALR, BWC, BWR, DBT, DPT, GGA, GLL, GNS, GSA, GSV, HDG, HDT, HDM, MTW, MWV, RMB, RMC, THS, TTM, VDM, VHW, VTG, VWR, VWT, XTE, ZDA
	Output	TLL		ACK, RSD, TLL, TTM
ENVIRONMENT				
Temperature	Display unit	-15°C to +55°C		-15°C to +55°C
	Antenna unit	-25°C to +70°C		-25°C to +55°C
Waterproofing	Display unit	IPX5		IP56
	Antenna unit	IPX6		IPX6
POWER SUPPLY				
Display unit		12-24 VDC: 3.2-1.4 A		12-24 VDC: 3.0-1.5 A

MODEL1623 Display Unit 1.3 kg 2.9 lb

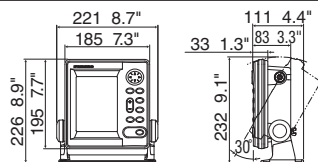

MODEL1715 Display Unit 1.5 kg 3.3 lb

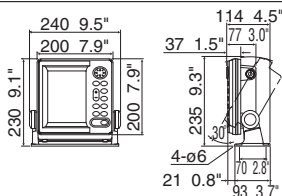

MODEL1815 Display Unit (Bracket Mount) 2.2 kg 4.9 lb

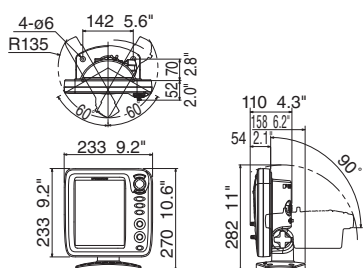

MODEL1815 Display Unit (Flush Mount) 1.6 kg 3.5 lb

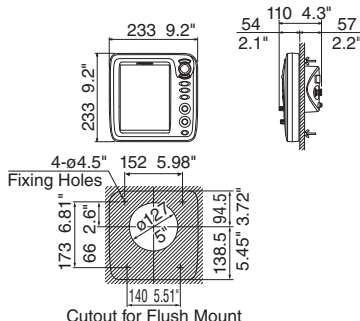

MODEL1623 Antenna 4.6 kg 10.1 lb

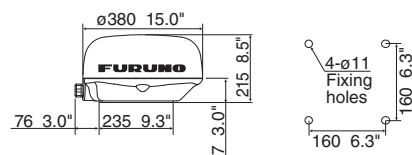

MODEL1715 Antenna 5.1 kg 11.2 lb

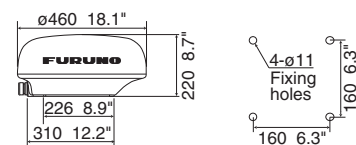

MODEL1815 Antenna 6.5 kg 14.3 lb

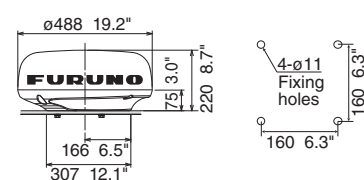

Radar

		10.4" COLOR LCD RADAR		
		MODEL1835	MODEL1935	MODEL1945
				
ANTENNA				
Type		ø602 mm Radome (24")	1000 mm Open (3.5')	1200 mm Open (4.0')
Beamwidth	Horizontal	4.0°	2.4°	1.9°
	Vertical	20°	22°	
Rotation speed		24 rpm	24 rpm	48 rpm (option)
RF TRANSCEIVER				
Frequency		9410±30 MHz (X-band)		
Pulse length & PRR		0.0625-1.6 nm : 0.08µs/2100 Hz 1.5-3.2 nm : 0.3µs/1200 Hz 3-64 nm : 0.8µs/600 Hz		
Output power		4 kW		6 kW
IF amplifier	IF	60 MHz		
	BW	25 MHz (0.08/0.3µs) 3 MHz (0.8µs)		
DISPLAY				
Display unit		10.4" color LCD		
Effective display area		158 (W) x 211 (H) mm		
Pixel number		640 x 480, VGA		
Accuracy	Range	1.0 % of range in use or 8 m, which is greater		
	Bearing	EBL accuracy ± 1°		
Range and range ring interval	Range	0.0625, 0.125, 0.25, 0.5, 0.75, 1, 1.5, 1.6, 2, 3, 3.2, 4, 6, 8, 12, 16, 24, 32, 36, 48*, 64* (*range max. MODEL 1935/1937: 48nm, MODEL 1945: 64nm)		
	Ring	0.03125, 0.0625, 0.125, 0.125, 0.25, 0.25, 0.5, 0.4, 0.5, 1, 0.8, 1, 2, 2, 3, 4, 6, 8, 12, 12*, 16* (*ring max. MODEL 1935/1937: 12nm, MODEL 1945: 16nm)		
Echo trail		Interval: 15 s, 30 s, 1 min, 3 min, 6 min, 15 min, 30 min, or continuous		
TT targets		Up to 10 (required optional board ARP-11)		
AIS targets		Up to 100 (Data input from AIS is required.)		
Interface	Input	GNS, GGA, RMC, GLL, VTG, VHW, BWR, BWC, RMB, HDT, HDG, HDM, XTE, DPT, DBT, MTW, MWV, VWT, VWR, ZDA		
	Output	TTM, RSD, TLL		
ENVIRONMENT				
Temperature	Display unit	-15°C to +55°C		
	Antenna unit	-25°C to +55°C		
Waterproofing	Display unit	IPX5		
	Antenna unit	IPX6		
POWER SUPPLY				
	Display unit	12-24 VDC: 4.1-2.0 A	12-24 VDC: 6.8-3.3 A (24 rpm) 8.2-3.8 A (48 rpm)	12-24 VDC: 7.3-3.5 A (24 rpm) 8.8-4.1 A (48 rpm)

MODEL1835/1935/1945 Display Unit

5.4 kg 11.9 lb

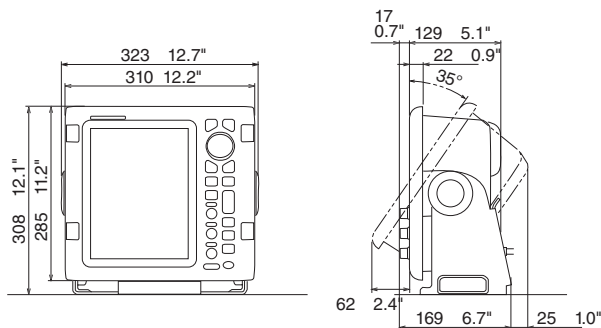

24" Radome Antenna

8 kg 17.6 lb

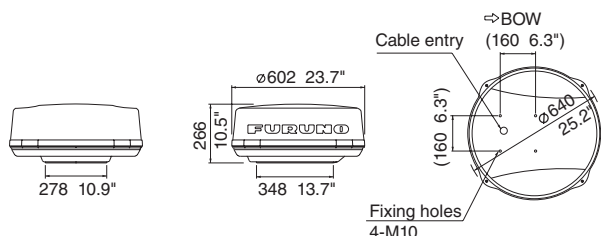

3.5 ft Open Antenna
4 ft Open Antenna

22 kg 48.5 lb
25 kg 55.1 lb

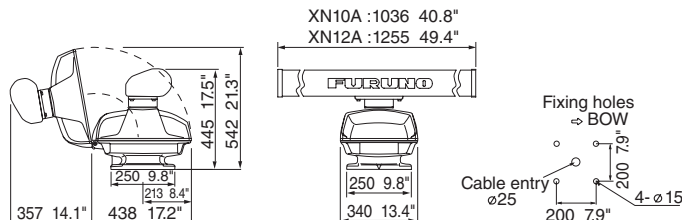

		12.1" LCD RADAR		
		FR8065	FR8125	FR8255
				
ANTENNA				
Type	1255 mm Open (4') or 1795 mm Open (6')			
Beamwidth	Horizontal	1.9°(4' Open: XN-12A) or 1.35° (6' Open: XN-13A)		
	Vertical	22°		
Rotation speed	24 rpm/48 rpm (option)			
RF TRANSCEIVER				
Frequency	9410 ±30 MHz (X-band)			
Pulselength & PRR	0.125-1.5 NM: 0.08µs/2100 Hz 1.5, 2, 3 NM: 0.3µs/1200 Hz 3-36 NM: 0.8µs/600 Hz 48, 64 NM: 0.8µs/550 Hz 72, 96* NM: 0.8µs/500 Hz * FR8255 only			
Output power	6 kW	12 kW	25 kW	
IF frequency	IF	60 MHz		
	BW	40 MHz (0.125-1.5 NM), 2.5 MHz (1.5-96 NM)		
DISPLAY				
Display unit	12.1" color LCD			
Effective display area	184 (H) x 246 (V) mm			
Pixel number	600 (H) x 800 (V)			
Accuracy	Range	0.9% of range in use or 8 m, which is greater		
	Bearing	EBL accuracy ±1°		
Range and range ring interval	Range	0.125, 0.25, 0.5, 0.75, 1, 1.5, 2, 3, 4, 6, 8, 12, 16, 24, 36, 48, 64, 72, 96* NM (range max. FR8065/8125: 72 NM, FR8255: 96 NM)		
	Ring	0.025, 0.05, 0.1, 0.25, 0.25, 0.25, 0.5, 0.5, 1, 1, 2, 2, 4, 4, 6, 8, 8, 12, 16* NM * FR8255 only		
Echo trail	interval: 15 s, 30 s, 1, 3, 6, 15, 30 min., or continuous			
TT targets	Up to 10 (Required optional board ARP-11)			
AIS targets	Up to 100 (Data input from AIS is required)			
Interface (IEC61162, NMEA0183)	Input	BWC, BWR, DBT, DPT, GGA, GLL, GNS, HDG, HDM, HDT, MTW, MWV, RMB, RMC, THS, TTM (for radiotelephone only), VHW, VTG, VWR, VWT, XTE, ZDA		
	Output	RSD, TLL, TTM (ARP-11 required)		
ENVIRONMENT				
Temperature	Display unit	-15°C to +55°C		
	Antenna unit	-25°C to +55°C		
Waterproofing	Display unit	IPX5 (front), IPX2 (rear)		
	Antenna unit	IPX6		
POWER SUPPLY				
	Display unit	24 VDC 24 rpm: 3.6 A 48 rpm: 3.9 A	24 VDC 24 rpm: 3.9 A 48 rpm: 4.5 A	24 VDC: 3.0 A
	Power supply unit	—	—	24 VDC 24 rpm: 2.3 A 48 rpm: 2.7 A

FR8065/8125/8255 Display Unit (Tabletop Mount)

5.8 kg 12.8 lb

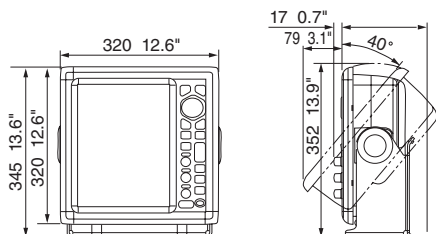

FR8065/8125/8255 Display Unit (Flush Mount)

5.3 kg 11.7 lb

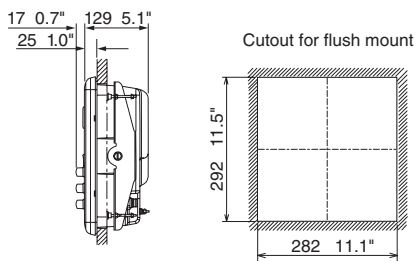

4 ft Open Antenna

25 kg 55.1 lb

6 ft Open Antenna

27 kg 59.5 lb

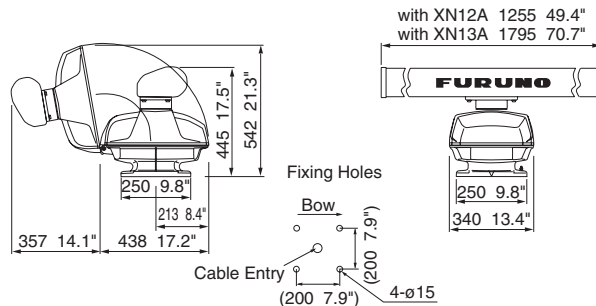

Radar

		MARINE RADAR	
		FAR1513	FAR1523
			
ANTENNA			
Type	1255 mm Open (4') or 1795 mm Open (6')		
Beamwidth	Horizontal	1.9° (XN12A), 1.35° (XN13A)	
	Vertical	20°	
Rotation speed	24 rpm or 48 rpm		
RF TRANSCEIVER			
Frequency	9410 MHz ±30 MHz, P0N		
Pulselength & PRR	S : 2100 Hz (0.125 to 1.5 NM) M: 1200 Hz (1.5 to 3 NM) L : 600 Hz (3 to 96 NM)		
Output power	12 kW	25 kW	
IF frequency	IF	60 MHz	
DISPLAY			
Accuracy	Range	1% of range in use or 10 m whichever is the greater	
	Bearing	±1°	
Range and range ring interval	Range	0.125, 0.25, 0.5, 0.75, 1, 1.5, 2, 3, 4, 6, 8, 12, 16, 24, 32, 48, 96 NM	
	Ring	0.025, 0.05, 0.1, 0.25, 0.25, 0.25, 0.5, 0.5, 1, 1, 2, 2, 4, 4, 8, 8, 16 NM	
Echo trail	Interval: 15 s, 30 s, 1-30min. (30 s steps) or continuous		
TT targets	Up to 50 in 0.2-32 NM Tracking: 5/10 pts on all target Time of vector: 0 to 60 minutes		
AIS targets	Up to 300 Tracking: 5/10 pts on all target Time of vector: 0 to 60 minutes		
Radar map	5,000 pts		
Interface (IEC61162, NMEA0183)	Input	ABK, ACK, ACN, ALR, BWC, BWR, CUR, DBK, DBS, DBT, DPT, DTM, GBS, GGA, GLL, GNS, HBT, HDG, HDM, HDT, MTW, MWV, RMB, RMC, RTE, THS, VBW, VDM, VDO, VDR, VHW, VTG, VWR, VWT, WPL, ZDA	
	Output	ABM, ACK, ALC, ALF, ALR, ARC, BBM, EVE, HBT, OSD, RSD, TLB, TLL, TTD, TTM, VSD	
INTERFACE (Processor unit)			
Heading	1 Port: AD-10 format or IEC61162-2		
Serial	IEC61162-2: 2 Ports (AIS/HDG), IEC61162-1: 4 Ports (GPS/LOG/AMS/ECDIS)		
Contact closure	Alert output: 4 ch, Remote ACK input, System fail, power fail		
Remote display	2 Ports (Signal: HD, BP, Trigger and Video)		
LAN	1 Port (100 BASE-TX)		
DVI-D	1 Port for main display		
RGB	1 Port for VDR or RGB monitor		
ENVIRONMENT			
Temperature	Processor unit	-15°C to +55°C	
	Antenna unit	-25°C to +55°C (storage: +70°C or less)	
Waterproofing	Processor unit	IP20 (IP22: option)	
	Antenna unit	IP26	
	Control unit	IP22	
POWER SUPPLY			
Processor unit	24 VDC: 5.0 A max. (24 rpm), 5.6 A max. (48 rpm)	24 VDC: 6.4 A max. (24 rpm), 7.0 A max. (48 rpm)	

FAR1513/1523 Processor Unit

DC: 6.2 kg 13.7 lb
AC: 6.8 kg 15 lb

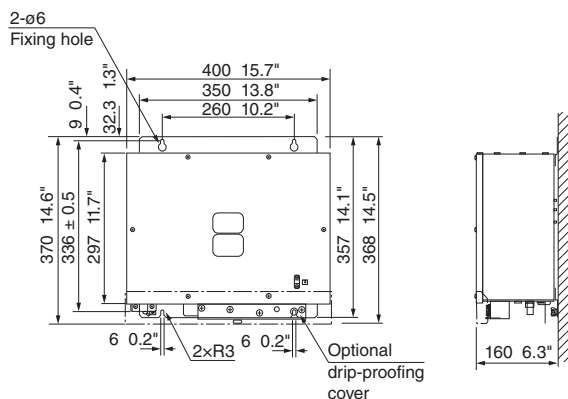

FAR1513/1523 Control Unit

1.2 kg 2.6 lb

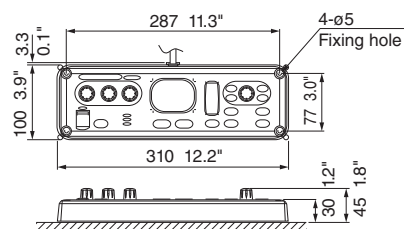

		MARINE RADAR	
		FAR1518	FAR1528
			
ANTENNA			
Type	1260 mm Open (4') or 2040 mm Open (6.5') or 2550 mm Open (8')		
Beamwidth	Horizontal	1.9° (XN12AF), 1.23° (XN20AF)	1.23° (XN20AF), 0.95° (XN24AF)
	Vertical	20°	
Rotation speed	26 rpm or 48 rpm		
RF TRANSCEIVER			
Frequency	9410 MHz ±30 MHz, P0N		
Pulselength & PRR	3000 Hz (0.125 to 3 NM), 0.08 µs 2760 Hz (0.125 to 6 NM), 0.12 µs 1500 Hz (0.75 to 24 NM), 0.22 µs 1000 Hz (0.75 to 24 NM), 0.38 µs 1000 Hz (3 to 24 NM), 0.68 µs 600 Hz (6 to 96* NM), 1.2 µs * 500 Hz on 96 NM range.		
Output power	12 kW	25 kW	
IF frequency	IF	60 MHz	
DISPLAY			
Accuracy	Range	1% of range in use or 10 m whichever is the greater	
	Bearing	±1°	
Range and range ring interval	Range	0.125, 0.25, 0.5, 0.75, 1.5, 3, 6, 12, 24, 48, 96 NM	
	Ring	0.025, 0.05, 0.1, 0.25, 0.25, 0.5, 1, 2, 4, 8, 16 NM	
Echo trail	Interval: 15 s, 30 s, 1-30min. (30 s steps) or continuous		
TT targets	Up to 50 in 0.2-32 NM Tracking: 5/10 pts on all target Time of vector: 0 to 60 minutes		
AIS targets	Up to 300 Tracking: 5/10 pts on all target Time of vector: 0 to 60 minutes		
Radar map	5,000 pts		
Interface (IEC61162, NMEA0183)	Input	ABK, ACK, ACN, ALR, BWC, BWR, CUR, DBK, DBS, DBT, DPT, DTM, GBS, GGA, GLL, GNS, HBT, HDG, HDM, HDT, MTW, MWV, RMB, RMC, RTE, THS, VBW, VDM, VDO, VDR, VHW, VTG, VWR, VWT, WPL, ZDA	
	Output	ABM, ACK, ALC, ALF, ALR, ARC, BBM, EVE, HBT, OSD, RSD, TLB,, TLL, TTD, TTM, VSD	
INTERFACE (Processor unit)			
Heading	1 Port: AD-10 format or IEC61162-2		
Serial	IEC61162-2: 2 Ports (AIS/HDG), IEC61162-1: 4 Ports (GPS/LOG/AMS/ECDIS)		
Contact closure	Alert output: 4 ch, Remote ACK input, System fail, power fail		
Remote display	2 Ports (Signal: HD, BP, Trigger and Video)		
LAN	1 Port (100 BASE-TX)		
DVI	1 Port for main display		
RGB	1 Port for VDR or RGB monitor		
ENVIRONMENT			
Temperature	Processor unit	-15°C to +55°C	
	Antenna unit	-25°C to +55°C (storage: +70°C or less)	
Waterproofing	Processor unit	IP20 (IP22: option)	
	Antenna unit	IP56	
	Control unit	IP22	
POWER SUPPLY			
Processor unit	AC type	100-115/220-230 VAC: 1.8/0.8 A (26 rpm), 2.2/1.0 A (48 rpm)	100-115/220-230 VAC: 2.3/1.0 A (26 rpm), 2.6/1.2 A (48 rpm)
	DC type	24 VDC: 6.1 A max. (26 rpm), 7.2 A max. (48 rpm)	24 VDC: 7.5 A max. (26 rpm), 8.6 A max. (48 rpm)

FAR1518/1528 Processor Unit

DC: 6.2 kg 13.7 lb
AC: 6.8 kg 15 lb

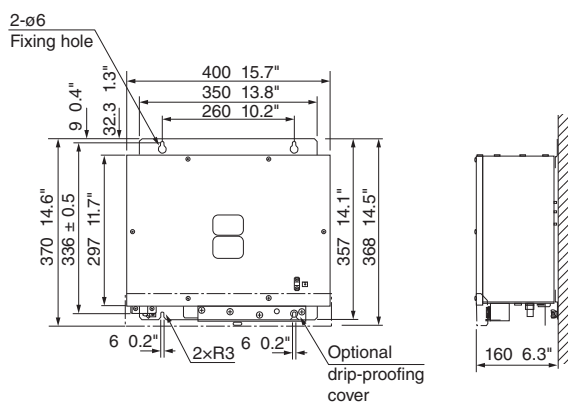

FAR1518/1528 Control Unit

1.2 kg 2.6 lb

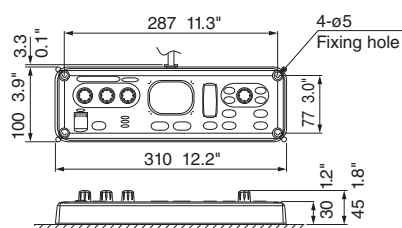

Radar

		BLACK BOX MARINE RADAR		
		FAR2117BB	FAR2127BB	FAR2137SBB
				
ANTENNA				
Type		1260 mm Open (4'), 2040 mm Open (6.5') or 2550 mm Open (8')		3090 mm S-band (10') or 3765 mm S-band (12')
Beamwidth	Horizontal	1.9° (4' Open: XN-12AF), 1.23° (6.5' Open: XN-20AF) or 0.95° (8' Open: XN-24AF)		2.3° (10' S-band: SN-30AF) or 1.8° (12' S-band: SN-36AF)
	Vertical	20°		25°
Rotation speed		24 rpm or 42 rpm		21/26 rpm or 45 rpm
RF TRANSCIEVER				
Frequency		9410 ±30 MHz (X-band)		3050 ±30 MHz (S-band)
Pulse length & PRR		0.125, 0.25 NM : 0.07 µs/3000 Hz 0.5 NM: 0.07, 0.15 µs/3000 Hz 0.75, 1.5 NM: 0.07, 0.15, 0.3 µs/3000, 1500 Hz 3 NM: 0.15, 0.3, 0.5, 0.7 µs/3000, 1500, 1000 Hz 6 NM: 0.3, 0.5, 0.7, 1.2 µs/1500, 1000, 600 Hz 12, 24 NM: 0.5, 0.7, 1.2 µs/1000, 600 Hz 48, 96 NM: 1.2 µs/600 Hz		
Output power		12 kW	25 kW	30 kW
IF frequency	IF	60 MHz		
	BW	40 MHz (Short pulse), 10 MHz (Middle pulse), 3 MHz (Long Pulse)		
DISPLAY				
Accuracy	Range	1% of the maximum range of the scale in use or 10 m, whichever is the greater		
	Bearing	±1°		
Range and range ring interval	Range	0.125, 0.25, 0.5, 0.75, 1, 1.5, 2, 3, 4, 6, 8, 12, 16, 24, 32, 48, 72, 96 NM		
	Ring	0.025, 0.05, 0.1, 0.25, 0.25, 0.25, 0.5, 0.5, 1, 1, 2, 2, 4, 4, 8, 8, 12, 16 NM		
Echo trail		interval: 15, 30 s, 1, 3, 6, 15, 30 m or continuous		
TT targets		Up to 100		
AIS targets		Up to 1000 (Data input from AIS is required)		
Interface (IEC61162, NMEA0183)	Input	BWC, BWR, DBS, DBT, DPT, DTM, GGA, GLL, HDT, MTW, MWV, RMA, RMB, RMC, RTE VBW, VDR, VHW, VTG, VWR, VWT, WPL, ZDA		
	Output	AAM, TLL, TTM, RSD, ESP		
ENVIRONMENT				
Temperature	Processor unit	-15°C to +55°C		
	Antenna unit	-25°C to +55°C		
Waterproofing	Processor unit	IPX0		
	Antenna unit	IPX6		
POWER SUPPLY				
	Processor unit	24 VDC: 7.6 A*1 / 8.5 A*2 100-115 VAC: 2.6 A*1 / 3.0 A*2 220-230 VAC: 1.6 A*1 / 1.7 A*2 *1 : 24 rpm, *2: 42 rpm	24 VDC: 8.8 A*1 / 9.7 A*2 100-115 VAC: 3.0 A*1 / 3.4 A*2 220-230 VAC: 1.8 A*1 / 1.9 A*2 *1 : 24 rpm, *2: 42 rpm	100-115 VAC: 3.0 A 220-230 VAC: 1.5 A
	Antenna unit	—	—	200/220 VAC: 3.0 A 380/440 VAC: 1.5 A 220 VAC: 3.5 A (for HSC) 440 VAC: 1.7 A (for HSC)

FAR2117BB/2127BB/2137SBB

Full-keyboard
Control Unit RCU-014

3.7 kg 8.2 lb

Trackball
Control Unit RCU-015

2.4 kg 5.3 lb

Remote
Control Unit RCU-016

2.4 kg 5.3 lb

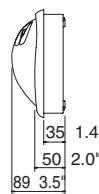
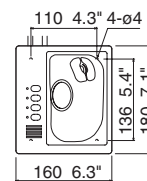
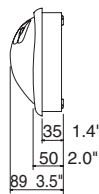
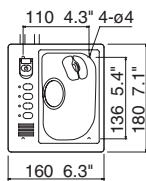
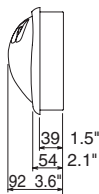
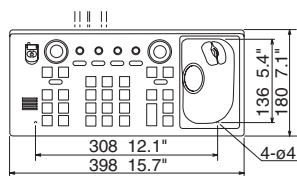

4 ft Open Antenna

33 kg 73 lb

6.5 ft Open Antenna
8 ft Open Antenna

39 kg 86 lb
42 kg 92.6 lb

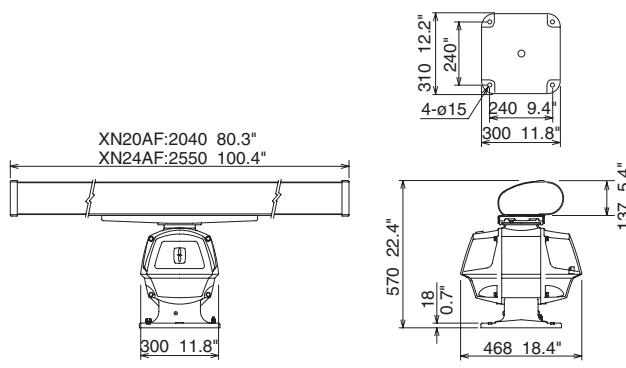
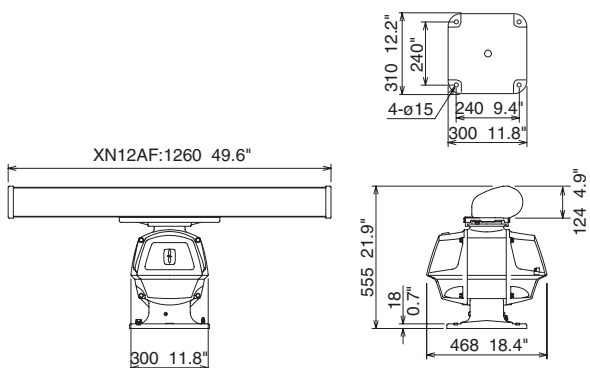

12 ft S-band Antenna SN30AF
14 ft S-band Antenna SN36AF

135 kg 297.6 lb
142 kg 313.1 lb

Processor Unit RPU-013

10 kg 22 lb

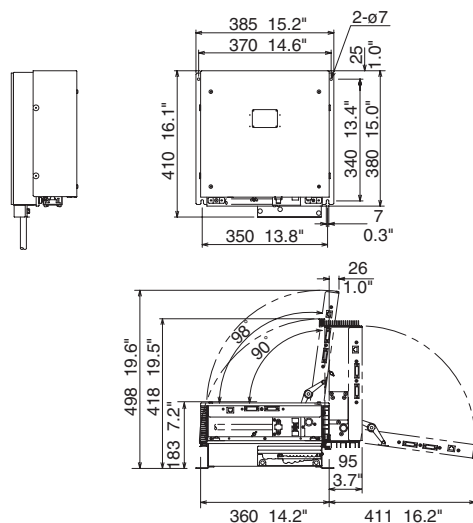
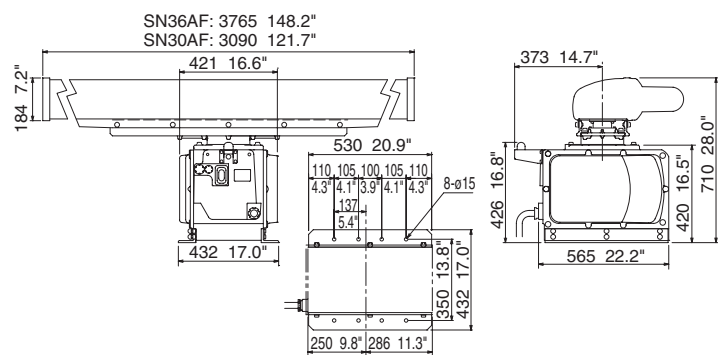
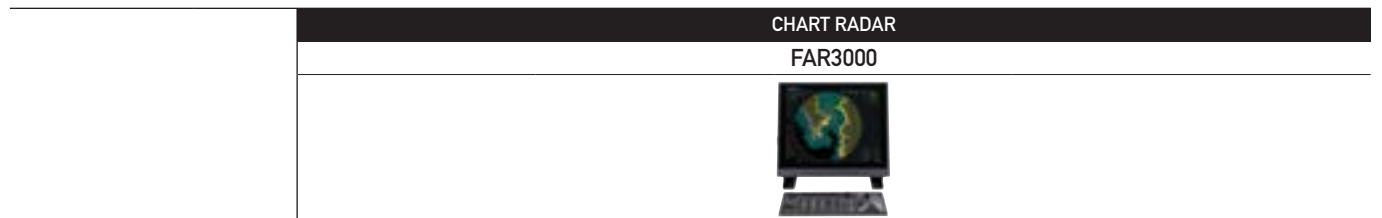

Chart Radar



MARINE RADAR

GENERAL

Range Scales and Ring Intervals

Range scales (NM)	0.125	0.25	0.5	0.75	1	1.5	2	3	4	6
Ring intervals (NM)	0.025	0.05	0.1	0.25	0.25	0.25	0.5	0.5	1	1
Number of Rings	5	5	5	3	4	6	4	6	4	6
Range scales (NM)	8	12	16	24	32	48	72	96	120	
Ring intervals (NM)	2	2	4	4	8	8	12	16	20	
Number of Rings	4	6	4	6	4	6	6	6	6	

1, 2, 4, 8, 16, 32, 72, 120 NM cannot be selected on IMO radar.

ANTENNA UNIT

Radiator Type Slotted waveguide array

Beamwidth and Sidelobe

Radiator Type	XN12CF	XN20CF	XN24CF	SN36CF
Length	4 ft	6.5 ft	8 ft	12 ft
Frequency	X band: 9410±30 MHz			S band: 3050±30 MHz
Beamwidth (H) (-3 dB)	1.9°	1.23°	0.95°	1.8°
Beamwidth (H) (-20 dB)	4.5°	2.9°	2.4°	4.5°
Beamwidth (V)	20°	20°	20°	25°
Sidelobe (within ±10°)	-24 dB	-28 dB	-28 dB	-24 dB
Sidelobe (outside ±10°)	-30 dB	-32 dB	-32 dB	-30 dB

TRANSCIEVER UNIT

Transceiver Unit	Magnetron					Solid State	
Frequency	RTR-105	RTR-106	RTR-108	RTR-107	RTR-109	RTR-111	
	X band: 9410±30 MHz			S band: 3050±30 MHz		①PON: 3043.75 MHz/QON: 3063.75±5 MHz ②PON: 3053.75 MHz/QON: 3073.75±5 MHz	
Output Power	12 kW	25 kW	30 kW	250 W			

Pulselength, Pulse Repetition Rate (PRR) and Range scale

Magnetron							
Pulselength (µs)	0.07	0.15	0.3	0.5	0.7	1.2	
PRR (Hz)	3000*	3000*	1500	1200	1000	600**	
Range scale (NM)	0.125/0.25/ 0.5/0.75/1/ 1.5/2	0.5/0.75/ 1/1.5/2/3/4	0.75/1/1.5/ 2/3/4/6/ 8/12	1.5/2/3/ 4/6/8/12/ 16/24	3/4/6/8/ 12/16/24	6/8/12/16/ 24/32/48/ 96/120	

Solid State

Pulselength (µs)	PON	0.07	0.18	0.3	0.5	0.7	1.2
	QON	5.0	7.5	12.5	17.5	18.3	18.3
PRR (Hz)		2400***	2000****	1500	1060	1000	600 (96 NM) 450 (120 NM)
Range scale (NM)		0.125/0.25/ 0.5/0.75/1/ 1.5/2	0.5/0.75/ 1/1.5/2/3/4	0.75/1/1.5/ 2/3/4/6/8	3/4/6/8/ 12/16/24	3/4/6/8/ 12/16/24	6/8/12/16/ 24/32/48/ 96/120

* 2200 Hz on TT range = 32 NM

** 500 Hz on 96/120 NM range

*** 1800 Hz on TT range = 32 NM

**** 1500 Hz on TT range = 32 NM

PROCESSOR UNIT

Chart Materials	IMO/IHO S57 edition-3 ENC vectorized material (IHO S-63 ENC data protection scheme), C-MAP and CM-93/3 vectorized materials
Data Presentation	
Own Ship	Own ship's mark and numeral position in lat/lon, speed and course
Target Data(TT: ARPA, AIS)	Range, bearing, speed, course, CPA/TCPA, BCR/BCT Target information from AIS (waypoint, ship's hull and status) Navigation by result from external position sensor
Position Calculation	Dead reckoning with gyro and log data from gyro, log, and position sensors to be fed to mathematical filter to generate highly accurate position and speed
Navigation Planning	Planning by rhumb line, great circle
Route Monitoring	Off-track display, waypoint arrival alarm, shallow depth alarm
User Chart	User chart creation and display
Notes Data	Create and display notes data
MOB (Man Overboard)	Position, and other data at time of man overboard are recorded MOB mark is displayed on the screen

DISPLAY UNIT

Display Unit	MU-190	MU-231
Display Type	19" color LCD	23.1" color LCD
Resolution	SXGA (1280x1024 pixels)	UXGA (1600x1200 pixels)

CHART RADAR

FAR3000



Processor Unit

DVI	2 ports, DVI-D (Video signal from DVI-1 and DVI-2 is identical) 1 port, DVI-I Ver. 1.1 (RGB for VDR)
LAN	2 ports, Ethernet 1000 Base-T (for Interswitch and Sensor Adapter) 1 port, 100 Base-TX (for Radar sensor)
USB	4 ports, USB 2.0 type-A
COM	2 ports, RS232C/RS-485 (for brilliance control)
Serial I/O	8 ports IEC61162-1/2 (2 ports), IEC61162-1 (6 ports)
Sentences Input	ABK, ACK, ACM, ALR, CUR, DBT, DPT, DTM, GGA, GLL, GNS, HBT, HDT, MTW, MWV, RMC, THS, VBW, VDM, VDO, VDR, VHW, VTG, ZDA
Output	ABM, ACK, ALC, ALF, ALR, ARC, BBM, EVE, HBT, OSD, RSD, TLB, TTD, TTM, VSD
Digital Input	1 port (for ACK signal input)
Contact Closure	6 ports 1 port for system fail, 1 port for power fail, 2 ports for normal close, and 2 ports for normal open

Sensor Adapter

Control and Serial Input	
LAN	1 port, Ethernet 100 Base-TX
Serial	8 ports IEC 61162-1/2 (4 ports), IEC 61162-1 (4 ports)
Analog Input	3 ports/per unit, -10 to +10 V/0 to 10 V, 4 to 20 mA selectable
Digital Input	8 ports/per unit, normal close or open, selectable
Digital Output	8 ports/per unit, normal close or open, selectable

POWER SUPPLY

Monitor unit	
MU-231	100-230 VAC; 1.0-0.6 A, 1 phase, 50/60Hz
MU-190	100-230 VAC; 0.7-0.4 A, 1 phase, 50/60Hz
Processor unit	100/230 VAC, 1 phase, 50/60 Hz

Power Supply Unit

	Input Voltage	Input Current
PSU-014	100-230 VAC	3.7 A
PSU-015		6.4 A
PSU-016	50/60 Hz	2.8 A
PSU-018		5.6 A

ENVIRONMENTAL CONDITIONS

Unit	Ambient Temperature	Relative Humidity	Degree of protection	Vibration
Antenna Unit	-25°C to +55°C (storage +70°C)	93 % or less at 40°C	IP56	IEC 60945 Ed. 4
Power Supply Unit			IP20	
Processor Unit	IP20			
Control Unit	IP22			
Sensor Adapter	IP22			
Monitor Unit	IP22			

EQUIPMENT LIST

Standard

Display Unit	MU-190/231	1 unit
Processor Unit	EC-3000	1 unit
Control Unit		1 unit
Radar Control Unit	RCU-025	1 unit (specify when ordering)
Trackball Control Unit	RCU-026	
Antenna Radiator	XN12CF/XN20CF/XN24CF/ SN36CF	1 unit
Transceiver	RTR-105/106/107/108/109/111	1 unit
Gear Box	RSB-128/129/130/131/133	1 unit
Performance Monitor	PM-32A/52A/52B	1 unit
Power Supply Unit	PSU-014/015/016/018	1 unit
Cable between Power Supply Unit and Antenna Unit		1 pc
LAN Cable between Processor Unit and Power Supply Unit		1 pc
Standard Spare Parts and Installation Materials		1 set

Option

Sensor Adapter	MC-3000S/3010A/ 3020D/3030D
Sub Display Radar Cable	RW-00136
Deicer	OP03-226/227
Junction Box (for foremast mounting)	RJB-001
Composite Cable between Junction Box and Antenna/	RW-9600
Power Supply Unit (for foremast mounting)	
LAN Signal Converter (for foremast mounting)	OP03-223
Switching Hub for sensor network	HUB-100
Intelligent Hub for interswitch network	HUB-3000

FAR3000 Chart Radar

Antenna Unit for FAR-3210/3310/3220/3320/3320W

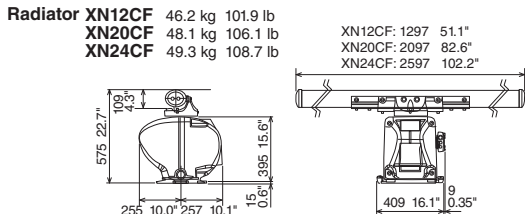

Antenna Unit for FAR-3230S/3330S/3330SW/3230S-SSD/3330S-SSD

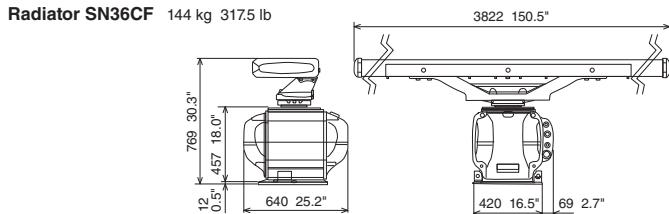

Monitor Unit

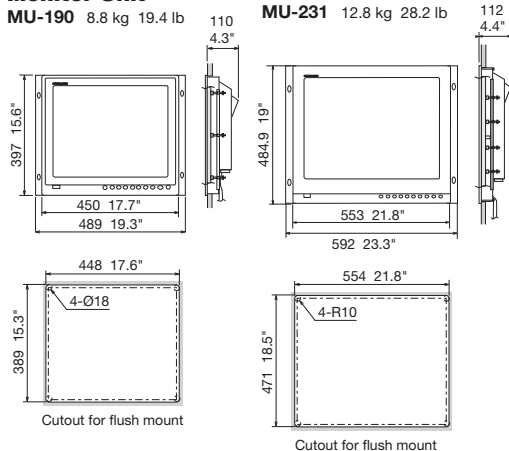

Transceiver Unit for FAR-3320W

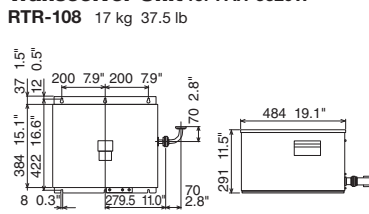

Transceiver Unit for FAR-3330S

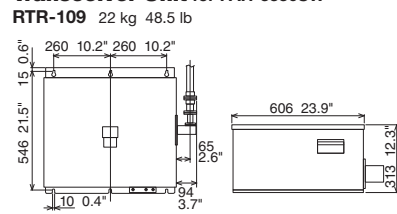

Power Supply Unit

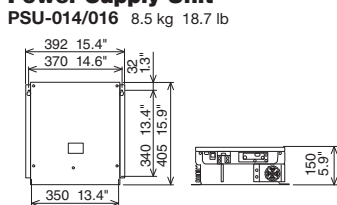

PSU-015/018 10 kg 22.0 lb

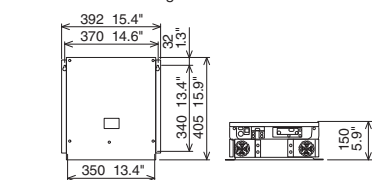

Control Unit

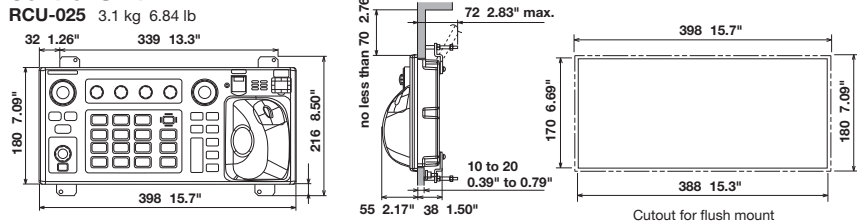

Trackball Control Unit

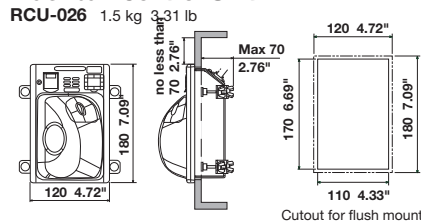

Processor Unit

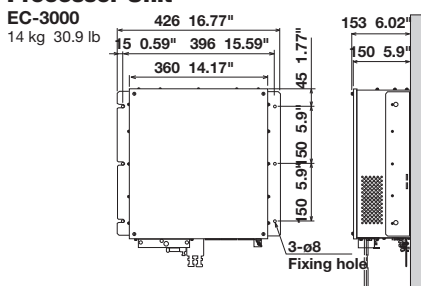

Switching Hub

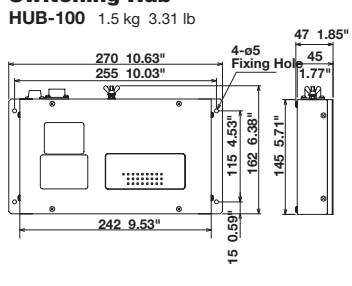

Intelligent Hub

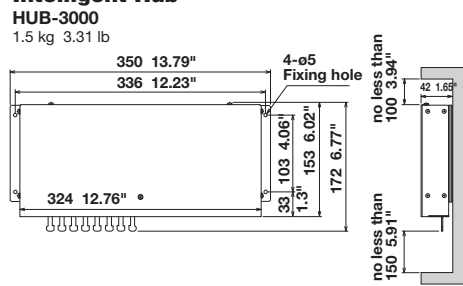

Sensor Adapter

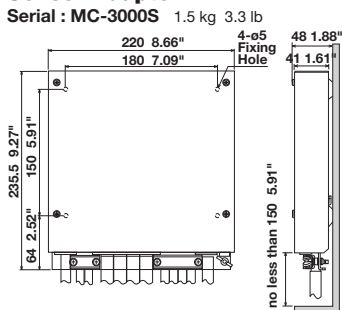

Analog : MC-3010A 0.8 kg 1.8 lb

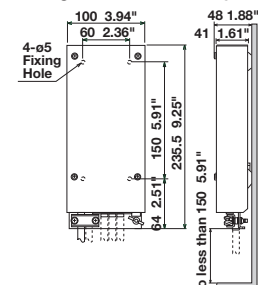

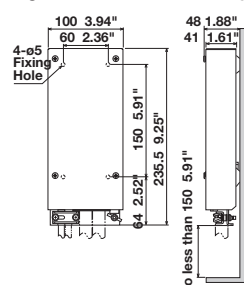

Digital In : MC-3020D 0.8 kg 1.76 lb

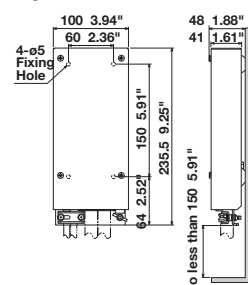

Digital Out : MC-3030D 0.8 kg 1.76 lb



GPS/Chart Plotter

		4.3" GPS NAVIGATOR	4.2" GPS NAVIGATOR
		GP33	GP39
			
GPS/WAAS			
Receive Type	GPS	Twelve discrete channels, C/A code, all-in-view	
	WAAS	Two channels	
	SBAS	Two channels	
Receive Frequency		L1 (1575.42 MHz)	
Time to First FIX		Within 90 s (cold start)	90 s approx. (cold start)
Tracking Velocity		999 kn	1,000 kn
Geodetic Systems		WGS-84 (and others)	
ACCURACY			
	GPS	10 m (2 drms)	
	MSAS	7 m (2 drms)	
	WAAS	3 m (2 drms)	
DISPLAY			
Display Unit		4.3" Color LCD	4.2" Color LCD
Effective display area		95.04 (W) x 53.85 (H) mm	92 (W) x 52 (H) mm
Pixel number		480 x 272	
Display Modes		Plotter, Steering, Highway, NAV data, User display1, User display2, Satellite monitor	Plotter, Steering, Highway, NAV data, User display, Satellite monitor (Digital, Speedometer, COG)
Memory Capacity		3,000 ship's track points 10,000 waypoints with comments 100 routes, 30 waypoints/route	
Alarms		Arrival, Anchor watch, XTE, Speed, WAAS, Time, Trip, Odometer	Arrival, Anchor watch, Cross track error, Speed, WAAS (SBAS), Time, Trip
INTERFACE			
Ports		NMEA0183: 1, CAN bus: 1	NMEA0183: 1, USB: 1
Interface	Output	(NMEA0183) AAM, APB, BOD, BWC, BWR, DTM, GGA, GLL, GSA, GSV, RMB, RMC, VTG, XTE, ZDA (CAN bus) 059392, 060928, 061184, 126208, 126464, 126720, 126992, 126996, 127258, 129026, 129029, 129033, 129044, 129283, 129284, 129285, 129538, 129539, 129540, 130822, 130823	(NMEA0183) AAM, APB, BOD, BWC, BWR, DTM, GGA, GLL, GSA, GSV, RMB, RMC, VTG, XTE, ZDA
	Input	(CAN bus) 059904, 065286, 060928, 061184, 126208, 126720	(NMEA0183) RTE, TLL
ENVIRONMENT			
Temperature	Display Unit	-15°C to +55°C	-15°C to +55°C
	Antenna Unit	-15°C to +55°C	-25°C to +70°C
Waterproofing	Display Unit	IP56	IP55
	Antenna Unit	IPX6	IP56
POWER SUPPLY			
	Non CAN bus	12-24 VDC: 0.24-0.12 A	12-24 VDC: 0.7-0.3 A
	CAN bus	15 VDC, LEN7	—

GP33 Display Unit (Bracket Mount)

0.72 kg 1.6 lb

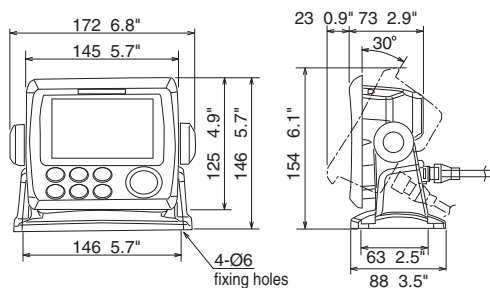

GP33 Display Unit (Flush Mount)

0.6 kg 1.3lb

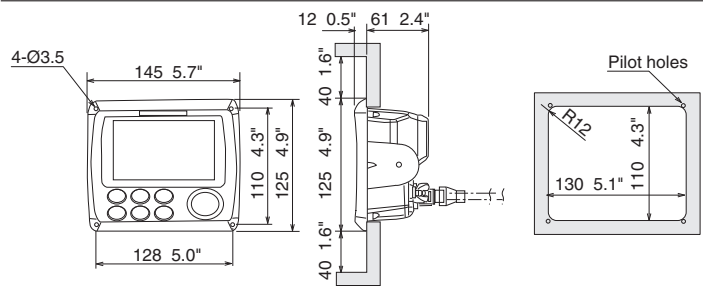

GP39 Display Unit (Bracket Mount)

0.39 kg 0.86 lb

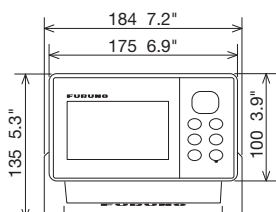

GP39 Display Unit (Flush Mount)

0.36 kg 0.79 lb

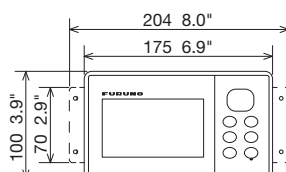

GPS Antenna GPA017

0.6 kg 1.3 lb

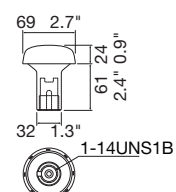

5.7" GPS DGPS NAVIGATOR		
GP170		
		
GPS/WAAS		
Receive Type	GPS	Twelve discrete channels, C/A code, all-in-view
	WAAS	Two channels
Receive Frequency		L1 (1575.42 MHz)
Time to First FIX		90 s approx. (cold start)
Tracking Velocity		1,000 kn
Geodetic Systems		WGS-84 (and others)
ACCURACY		
	GPS	10 m (2 drms)
	DGPS	5 m (2 drms)
	WAAS	3 m (2 drms)
	MSAS	7 m (2 drms)
DISPLAY		
Display Unit		5.7" color LCD
Effective display area		116.2 (W) x 87.1 (H) mm
Pixel number		640 x 480
Display Modes		Plotter, Highway, Course, Data, Integrity
Memory Capacity		Track: 1,000 points, Mark: 2,000 points Waypoints: 1,000 points with 20 characters comment each Route: 100 routes (containing 1,000 waypoints each)
Alarms		Notice: Arrival, Anchor watch, XTE, Speed, Trip
INTERFACE		
Serial (IEC 61162-1, -2)		4 ports (1 port: IEC 61162-2, In/Out, 1 port: IEC 61162-1, Out)
Data port 1, 2	Input	ACK, ACN, CRQ, DBT, DPT, HBT, HDG, HDM**, HDT**, MSK, MSS, MTW, THS, TLL, VBW, VHW ** not used for SOLAS ships
	Output	AAM, ALC, ALF, ALR, APB, ARC, BOD, BWC, BWR, BWW, DTM, GBS, GGA, GLL, GNS, GRS, GSA, GST, GSV, HBT, POS, RMB, RMC, RTE, VDR, VTG, WCV, WNC, WNR, WPL, XTE, ZDA
Data port 3	Input	MOB from external device (contact closure)
	Output	AAM, ALC, ALF, ALR, APA, APB, ARC, BOD, BWC, BWR, BWW, DTM, GBS, GGA, GLL, GNS, GRS, GSA, GST, GSV, HBT, MSK*, MSS**, POS, RMB, RMC, Rnn, RTE, VDR, VTG, WCV, WNC, WNR, WPL, XTE, ZDA, RTCM sc104 *when either internal/external beacon receiver is used ** when internal beacon receiver is used
Data port 4, IEC/NMEA Mode		Same as Data port 1, 2
Ethernet (IEC 61162-450)		1 port
	Input	ACK, ACN, DBT, DPT, HBT, HDG, HDM**, HDT**, MTW, THS, TLL, VBW, VHW ** not used for SOLAS ships
	Output	AAM, ALC, ALF, ALR, APB, ARC, BOD, BWC, BWR, BWW, DTM, GBS, GGA, GLL, GNS, GRS, GSA, GST, GSV, HBT, POS, RMB, RMC, RTE, VDR, VTG, WCV, WNC, WPL, XTE, ZDA *when either internal/external beacon receiver is used ** when internal beacon receiver is used
ENVIRONMENT		
Temperature	Display Unit	-15°C to +55°C
	Antenna Unit	-25°C to +70°C
Waterproofing	Display Unit	IP25
	Antenna Unit	IP56
POWER SUPPLY		
		12-24 VDC
		0.8 - 0.4 A (w/internal beacon receiver)

GP170 Display Unit (with an optional flush mount kit)
 GP170 Display Unit (with an optional flush mount kit)

2.2 kg 4.9 lb (without DGPS beacon receiver)
 2.4 kg 5.29 lb (with DGPS beacon receiver)

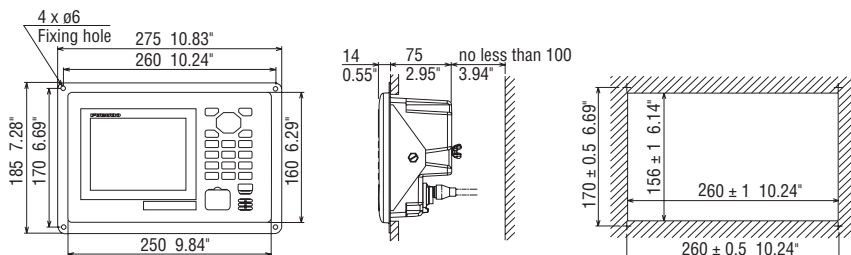



GPS/Chart Plotter

7" WIDE GPS/WAAS COLOR CHART PLOTTER/FISH FINDER		
GP1870F		
		
GPS/WAAS		
Receive Type	GPS WAAS	
Receiving Frequency	L1 (1575.42 MHz)	
Time to First FIX	80 s (cold start)	
Tracking Velocity	999 kt	
SBAS (Satellite-Based Augmentation System)	WAAS, EGNOS, MSAS	
Electronic Chart	C-MAP 4D	
ACCURACY		
Internal Antenna	GPS MSAS	
External Antenna GPA-017 (Option)	GPS MSAS	
DISPLAY		
Type	7" Wide Color TFT LCD	
Screen Size	152.4 x 91.4 mm	
Screen Resolution	WVGA 800 x 480 pixels	
Screen Brightness	900 cd/m ² (typical)	
Language	English (US & UK), French, Spanish, German, Italian, Portuguese, Danish, Swedish, Norwegian, Finnish, Greek, Japanese, Chinese, Russian, Thai, Vietnamese, Polish, Bahasa Malaysia, Bahasa Indonesia	
Display Modes	Course plot, Nav Data, Instruments, Engine monitor, Anemometer, Fuel level gauge, GPS status, Fish finder	
Memory Capacity	30,000 points for ship's track and waypoints 1,000 planned routes (Max. 50 points per route) 5,000 quickpoints	
INTERFACE		
CAN bus	1 Port	
Interface (CAN bus)	Input	059392, 059904, 060928, 061184, 126208, 126992, 126996, 127245, 127250, 127251, 127258, 127488, 127489, 127493, 127496, 127505, 128259, 128267, 129025, 129026, 129029, 129033, 129038, 129039, 129040, 129538, 129540, 129793, 129794, 129798, 129808, 129809, 129810, 130306, 130310, 130311, 130312, 130313, 130314, 130577
	Output	059392, 059904, 060928, 061184, 126208, 126464, 126992, 126996, 127258, 128259, 128267, 128275, 129025, 129026, 129029, 129033, 129283, 129284, 129285, 130310, 130312
USB*	1 Port (2.0)	
SD Cart Slot	1 Slot (Acceptable up to 32 GB)	
FISH FINDER		
Transmit Frequency	50/200 kHz	
Transmission	600 W or 1 kW*	
Display Range	5-1,200 m, shift: 0-500 m	
Extension Mode	ACCU-FISH, Auto (Fishing/Cruising/Manual), A-Scope, Marker Zoom, Bottom Zoom, Bottom Lock, Bottom Discrimination	
Picture Advance	7 steps: x2, x1, 1/2, 1/4, 1/8, 1/16, stop	
ENVIRONMENT		
Temperature	-15°C to +55°C	
Waterproofing	IP56	
POWER SUPPLY		
	12-24 VDC	
	1.05 - 0.53 A (Equip 520-5PD)	
	1.37 - 0.64 A (Equip 50/200-1T)	

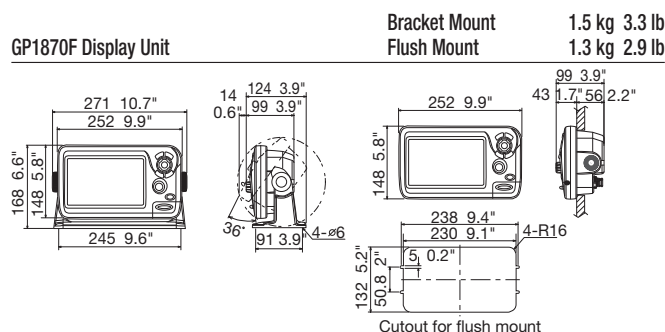
* The GP1870F can be connected with the transducers of 1 kW output power, when interfaced with the Matching Box MB-1100.



Fish Finder

	5.7" FISH FINDER	8.4" FISH FINDER
	FCV628	FCV588
		
General		
Frequency	50 and 200 kHz	
Transducer	600 W	600 W/1 kW*
DISPLAY		
Display unit	5.7" TFT color LCD	8.4" TFT color LCDF
Effective display area	87.1 (W) x 116.2 (H) mm	128.2 (W) x 170.9 (H) mm
Pixel number	VGA 480 x 640 pixels	
Display Mode	Single frequency (50 or 200 kHz), Dual-frequency, Zoom, Nav data, A-scope, Marker zoom, Bottom zoom, Bottom-lock, Bottom Discrimination, ACCU-FISH™, RezBoost™	
Basic Range <small>*m, ft, fa, p/b can be selectable in the menu</small>	2-1200 m	
Range phasing	up to 1200 m	
Expansion Range	Bottom-lock expansion	2-10 m
	Sectional expansion	2-1200 m
Picture advance speed	8 steps: stop, 1/16, 1/8, 1/4, 1/2, x1, x2, x4	
Pulselength & PRR	0.04-3.0 ms, Max 3,000 pulse/min	
Interface (IEC61162-1, NMEA 0183 Ver 1.0/2.0/3.0)	Input	BWC, GGA, GLL, GNS, HDG, HDT, MDA, MTW, MWV, RMA, RMB, RMC, VHW, VTG, XTE, ZDA
	Output	DBS, DBT, DPT, MTW*, RMB*, VHW*, TLL* by key operation * External data required.
ENVIRONMENT		
Temperature	-15°C to +55°C	
Waterproofing	IP56	
POWER SUPPLY		
	12-24 VDC: 1.1-0.5 A	12-24 VDC: 1.3-0.6 A

* The FCV588 can be connected with the transducers of 1 kW output power, when interfaced with the Matching Box MB-1100.

FCV628 (Bracket Mount)

1.3 kg 2.9 lb

FCV588 (Bracket Mount)

2.3 kg 5.1 lb

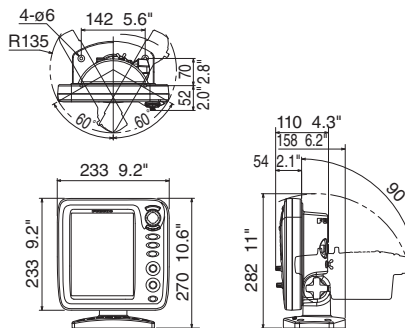
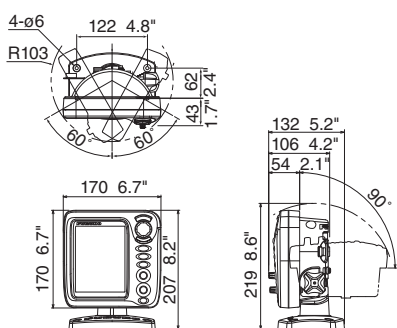

FCV628 (Flush Mount)



0.9 kg 2.0 lb

FCV588 (Flush Mount)

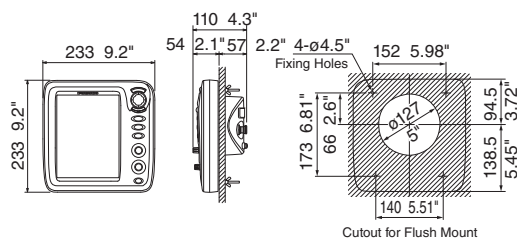
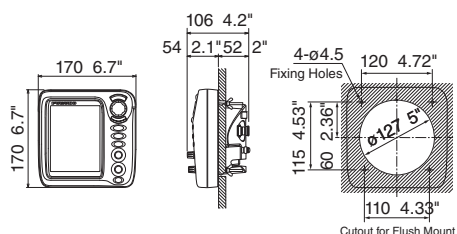
1.6 kg 3.5 lb



Fish Finder

	10.4" LCD SOUNDER		12.1" LCD SOUNDER		
	FCV295		FCV1150		
					
General					
Frequency	The synthesized transceiver works with dual frequencies in 28 to 200 kHz				
Transducer	1, 2 or 3 kW				
DISPLAY					
Display unit	10.4" TFT color LCD		12.1" TFT color LCD		
Pixel number	640 x 480		800 x 600		
Display Mode	Single mode (high/low frequency), Dual-frequency, Zoom, Mix, A-scope, Marker zoom, Bottom zoom, Bottom-lock expansion				
Basic Range	5-3000 m				
*m, ft, fa, p/b can be selectable in the menu					
Range phasing	0-2000 m				
Expansion Range	5-200 m				
Bottom-lock expansion					
Picture advance speed	6 steps: stop, 1/16, 1/8, 1/4, 1/2, x1, x2, x4				
Pulselength & PRR	0.1-5.0 ms, 20-3000 pulse/min				
Interface (IEC61162, NMEA0183)	Input	BWC, GGA, GLC, GLL, GNS, GTD, HDG, MDA, MTW, MWW, RMA, RMB, RMC, VHW, VTG, XTE		BWC, GGA, GLC, GLL, GNS, GTD, HDG, HDT, MDA, MTW, MWW, RMA, RMB, RMC, VHW, VTG, XTE, HVE, att, hve, req	
	Output	DBS, DBT, DPT, MTW*, TLL, SDmrk, VHW, RMB, dat *Optional sensor required			
	Output for external Monitor	—			
ENVIRONMENT					
Temperature	Display unit	-15°C to +55°C			
Waterproofing	Display unit	IP55 (When flush mounted)			
POWER SUPPLY					
	12-24 VDC: 2.6-1.3 A, 100/110/220/230 VAC, optional rectifier required		12-24 VDC: 3.3-1.7 A, 100/110/220/230 VAC, optional rectifier required		

FCV295

7.0 kg 15.4 lb

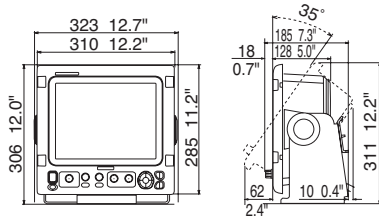

FCV1150 (Bracket Mount)

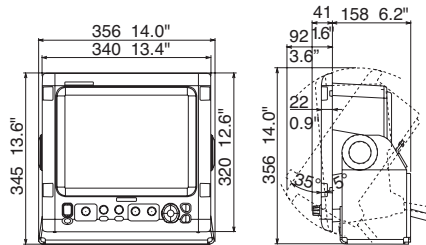

8.2 kg 18.1 lb

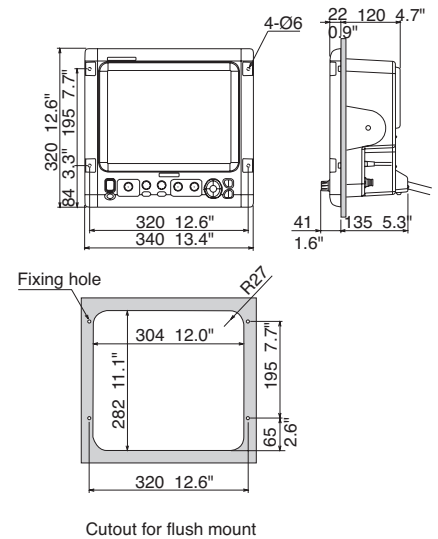

FCV1150 (Flush Mount)

6.8 kg 15.0 lb

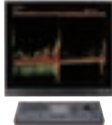

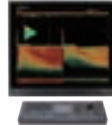
	FISH FINDER	HI-REZ TruEcho CHIRP FISH FINDER	TruEcho CHIRP WITH UNIQUE FISH SIZE INDICATOR
	FCV1900	FCV1900B	FCV1900G
			
General			
Frequency	15 to 200 kHz, Free-synthesize		
Transducer	1, 2 or 3 kW		
DISPLAY (Processor unit)			
Display mode	Single frequency high/low), Dual-frequency, Zoom, User 1/2 (available to use mixture, multi-gain, telesounder and external sounder display), Bottom-lock expansion, Bottom zoom, Marker zoom, Discrimination zoom		
Basic Range <small>*m, ft, fa, p/b can be selectable in the menu</small>	5 to 3000 m		
Range phasing	up to 2000 m		
Expansion Range	5 to 200 m		
Fish size histogram	—	—	2 m depth or more, specified transducer required
Picture advance speed	6 steps: stop, 1/4, 1/2, 1/1, 2/1, 4/1		
Data recording	Echo display and measured data can be recorded to internal memory		
Language	English, Danish, French, Spanish, Norwegian, Russian, Chinese, Korean, Japanese		
INTERFACE			
NMEA0183	3 Ports for Input/Output		
Interface <small>(NMEA 0183 Ver 1.5/2.0/3.0)</small>	Input	GGA, GLL, GNS, MTW, VHW, VTG, ZDA	
	Output	DBS, DBT, DPT, MTW, TLL	
LAN	1 port*	Ethernet 100Base-TX	*Hub required
CIF	1 port		
Net sonde	1 port (sonde marker/sonde KP)		
Video	1 port, HDMI type-D		
External KP	1 port		
Temperature sensor	1 port		
USB	1 port (USB2.0)		
ENVIRONMENT			
Temperature	-15°C to +55°C		
Waterproofing	IP22		
POWER SUPPLY			
	12-24 VDC: 8.3-3.9 A		

Processor Unit FCV1901

10.2 kg 22.5 lb

Contro Unit FCV1902

1.1 kg 2.4 lb

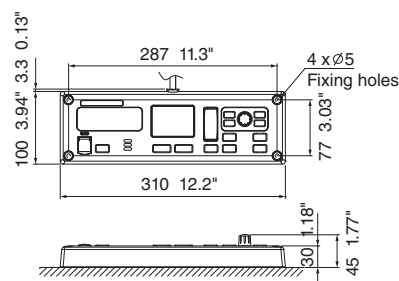
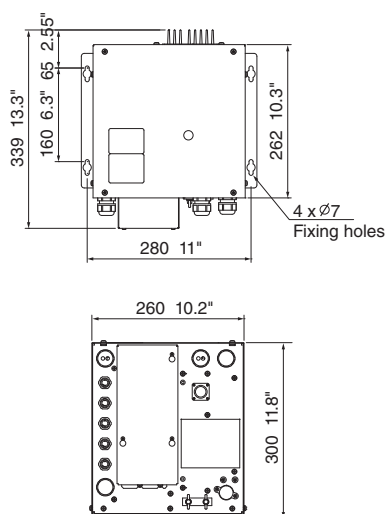

Fish Finder

TRANSDUCERS for FCV295/FCV1150/FCV1900/DFF3			
	1 kW	2 kW	3 kW
28	28F-8	28BL-6HR	28BL-12HR
38	—	38BL-9HR	38BL-15HR
50	50B-6/6B, 50B-9B	50B-12, 50BL-12HR	50BL-24H, 50BL-24HR
68	68F-8H	—	68F-30H
82	—	82B-35R	—
88	88B-8	88B-10	88F-126H
107	—	—	100B-10R
150	—	—	150B-12H
200	200B-5S	200B-8/8B	200B-12H
50/200	50/200-1T*, 50/200-1ST**	—	—

* ACCU-FISH™ compatible for FCV1900/DFF3

** Except for FCV1900

TRANSDUCERS for FCV1900B/1900G			
	1 kW	2 kW	3 kW
42 to 65 (low), 130 to 210 (high)	CM265LH *	—	—
42 to 65 (low), 85 to 135 (high)	CM265LM	—	—
42 to 65 (low), 150 to 250 (high)	CM275LH-W **	—	—
38 to 75 (low), 130 to 210 (high)	—	PM111LH *	—
38 to 75 (low), 80 to 130 (high)	—	PM111LM	—
28 to 60 (low), 130 to 210 (high)	—	—	CM599LH *
28 to 60 (low), 80 to 130 (high)	—	—	CM599LM

* ACCU-FISH™ and fish size histogram compatible.

** Wide beam type transducer with high frequency beam width of 25°

TRANSDUCERS for DFF1-UHD	
	1 kW
42 to 65 (low)/130 to 210 (high)	CM265LH, CM275LH-W, B265LH, B275LH-W (Airmar®)

TRANSDUCER for DFF-3D	
	800 W
165	B54

TRANSDUCER LIST						Stand Alone			Sensor				
						FCV628	FCV588	GP1870F	DFF1	BBDS1			
	Frequency	Type	Matching Box	Mount	Output Power								
TRANSDUCER	50/200 kHz	520-5PSD		Thru-hull	600 W	●	◎	●	◎	●	◎		
		525-5PWD		Transom		●	◎	●	◎	●	◎		
		520-5MSD		Thru-hull		●	◎	●	◎	●	◎		
		520-PLD(P319*)		Thru-hull		●	◎	—	—	—	—		
		50/200-1T	○	Thru-hull		—	—	●	◎	●	◎		
	50 kHz	50B-6	○	Thru-hull	1 kW	—	○	○	○	—	—		
		50B-6B	○	Thru-hull		—	○	○	○	—	—		
		50B-9B	○	Thru-hull		—	—	—	○	—	—		
	200 kHz	200B-5	○	Thru-hull	1 kW	—	—	—	○	—	—		
		200B-5S	○	Thru-hull		—	○	○	○	—	—		
TRIDUCER	50/200 kHz	525T-BSD(B45*)		Thru-hull	600 W	●	◎	—	—	●	◎		
		525T-PWD(B258*)		Transom		●	◎	—	—	—	●	◎	
		525T-LTD/12 (B60-12-*)		Thru-hull		●	◎	—	—	—	—	—	
		525T-LTD/20 (B60-20-*)		Thru-hull		●	◎	—	—	—	—	—	
		SS60-SLTD/12 (SS60-12*)		Thru-hull		●	◎	—	—	—	—	—	
		SS60-SLTD/20 (SS6-20*)		Thru-hull		●	◎	—	—	—	—	—	
		525ST(ID)-MSD		Thru-hull		●	◎	●	◎	●	◎	●	◎
		525ST(ID)-PWD(P66*)		Transom		●	◎	●	◎	●	◎	●	◎
526T(ID)-HDD(B260*)		Thru-hull	1 kW	—	—	●	◎	—	—	●	◎		

* Airmar® transducer

● ACCU-FISH mode available ◎ Bottom discrimination display mode available

Transducer 525-5PWD (Plastic, Transom)

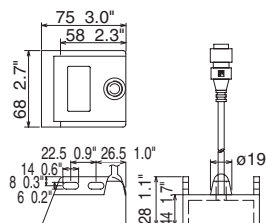

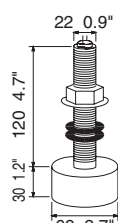

Transducer 520-5PSD (Plastic, Thru-hull)

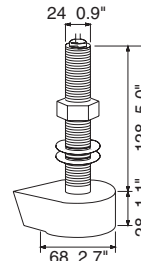

Transducer Bronze 520-5MSD (Metal, Thru-hull)



Sonar

		10.4" SEARCHLIGHT SONAR		10.4" SEARCHLIGHT DUAL FREQUENCY SONAR
		CH250	CH270	CH300
				
GENERAL				
Frequency		60, 88, 150, 180 or 240 kHz	180 kHz	60/153 or 85/215 kHz
Output Power		0.8-1.2 kW	0.8 kW	1 kW
DISPLAY				
Display unit		10.4" TFT color LCD, or locally supplied for Black Box configuration		
Effective display area		213 (W) x 160 (H) mm		
Pixel number		640 x 480		
Display Mode		Horizontal (Normal/Expanded), Vertical Scan, Echo Sounder, Vertical Search, Combination Display (Plotter, Vertical Scan, Strata, History)		
Basic Range <small>*m,ft,fa,p/b can be selected in the menu</small>	Horizontal mode	60 kHz: 10-1600 m 150 kHz: 10-1000 m	88 kHz: 10-1200 m 180 kHz: 10-800 m	20-1200 m
	Vertical mode	10-600 m		
Pulse length		CH250: 0.20-20.0 ms, CH270: 0.24-8.0 ms, CH300: 0.24-16.0 ms		
Audio Monitor	Output	2 W		
	Frequency	1.0 kHz (external speaker required)		
Target Lock (three functions, selected on menu)	Scanning Reverse	Scanning orientation changed by pressing key		
	Position Search	Auto-search for marker setting position		
	Echo Search	Auto-search for signal level in a search zone, or manual search		
Interface (IEC61162, NMEA0183)	Input	DBS, DBT, DPT, GGA, GLL, HDG, HDM, HDT, MDA, MTW, RMA, RMC, VDR, VHW, VTG		
	Output	TLL		
Video Signal Output	Method	RGB analog, separated synchronization, VGA (VESA) (Optional interface unit required)		
	Resolution	640 x 480, 60 Hz		
	Connector	D-sub15P-female		
HULL UNIT				
Transducer travel		400 mm or 250 mm	350 mm or 250 mm	400 mm or 250 mm
Raising/lowering Time		400 mm: 30 s	350 mm: 30 s, 250 mm: 4 s	400 mm: 30 s
Allowable Ship's Speed		20 kt or less (15 kt during raise/lower operation)		
Horizontal Mode Control	Scanning Angle	6° to 360°, 24° step		
	Elevation Angle	-5° to 90°, 1° step		
Transceiver Beam Width	Frequency	60 kHz: 12° / 15° (-3 dB)	180 kHz: 8° conical (-3 dB)	60 kHz: 14°/16° (-3 dB)
	Vertical/	88 kHz: 9.5°/11.5° (-3 dB)		153 kHz: 5° / 7° (-3 dB)
	Horizontal	150 kHz: 6.5°/6.5° (-3 dB)		85 kHz: 10°/11° (-3 dB) 215 kHz: 4° / 5° (-3 dB)
Stabilizer		Within 20° (optional motion sensor or clinometers required)		
ENVIRONMENT				
Temperature	Display unit	-15°C to +55°C		
	Control unit	-15°C to +55°C		
	Processor unit	-15°C to +55°C		
	Hull unit	-15°C to +55°C	0°C to +45°C	-15°C to +55°C
Waterproofing	Display unit	IPX5		
	Control unit	IPX5		
	Transceiver unit	IPX0	IPX0	IPX0
	Hull unit	IPX2		
POWER SUPPLY				
Display Unit/Control Unit/Transceiver Unit		12-32 VDC: 4.7-1.8 A	12-32 VDC: 4.7-1.8 A	12-24 VDC: 7.0-3.5 A
Hull Unit		12/24-32 VDC: 4.7/2.3-1.8 A Max. 16.7-8.4/6.3 A	12/24 VDC: 4.0/2.5 A Max. 10.0/6.0 A	12/24 VDC: 4.7/2.3 A Max. 16.7/8.2 A

CH250/270/300 Display Unit 5.7 kg 12.6 lb

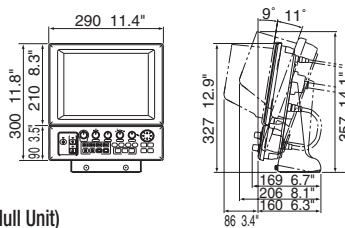

CH250/270 Transceiver Unit 3.5 kg 7.8 lb

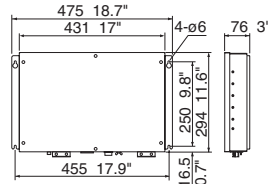

CH300 Transceiver Unit 3.5 kg 7.7 lb

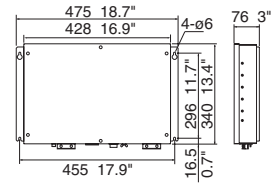

CH250 (Hull Unit)
CSH254 (Travel: 400 mm) 43 kg 94.8 lb
CSH255 (Travel: 250 mm) 42 kg 92.6 lb

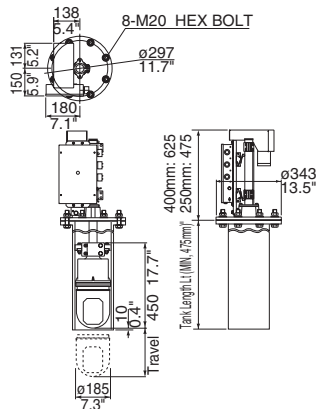

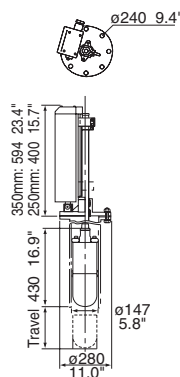

CH270 (Hull Unit)
CSH181 (Travel: 350 mm) 37 kg 81.6 lb
CSH184 (Travel: 250 mm) 35 kg 77.2 lb

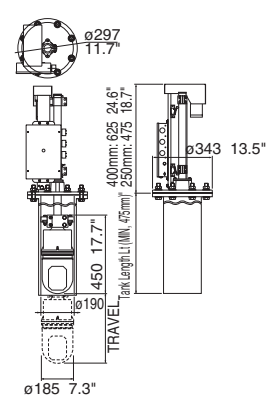

CH300 (Hull Unit)
CSH304 (Travel: 400 mm) 43 kg 94.8 lb
CSH305 (Travel: 250 mm) 42 kg 92.6 lb



Sonar

		FULL-CIRCLE SCANNING SONAR	
		CSH5L MARK-2	CSH8L MARK-2
			
GENERAL			
Frequency		55 kHz or 68 kHz	85 kHz or 107 kHz
DISPLAY			
Display Mode		Single scan, Fish finder combination* (single and fish finder), Audio combination (single and audio pictures) * Fish Finder or Echo sounder required	
Colors		Scan/Echo: 16 colors, Mark: 1 color	
Mark		Own ship's track, Heading line, Direction/distance, Fish school, Event, Target lock	
Range Scale		50, 85, 100, 150, 200, 250, 300, 350, 400, 450, 500, 600, 800, 1000, 1200, 1600 m	
Pulselength		0.5 to 20 ms (depending on range scales)	
Ship Speed		18 kn max (raise/lower operation up to 16 kn)	
Tilt		Manual control: 0° to 55° in 1° steps Automatic tilt scan: 4° to 52°	
Audio Search	Frequency	800 Hz	1 kHz
(By external loudspeaker)	Sector	20°, 40°, 80° and 120° selectable	
Language		English, Spanish, Danish, Dutch, French, Italian, Norwegian, Thai, Vietnamese, Burmese, Indonesian, Japanese	
INTERFACE			
NMEA0183 (Ver.1.5/2.0/2.2)		2 ports	
Interface	Input	CUR, DBS, DBT, DPT, GGA*, GLC, GLL*, GTD, HDG, HDM, HDT, MTW, RMA, RMC, VDR, VHW, VTG * disabled for NMEA0183 Ver.1.5	
	Output	TLL	
Log, E/S, KP		Speed log pulse (contact signal): 200/400 pulse/NM Sonde, E/S signal: VI-1100A applicable External KP: Current loop, 0 to 12 V	
Video Signal Output	Method	RGB analog, separated synchronization, XGA (VESA)	
	Resolution	1024 x 768 pixels, 65 MHz clock	
CIF data input		Location, Ship's speed, Bearing, Current data (1 layer), Water depth, Water temperature, Multiple layer current data	
HULL UNIT			
Transducer travel		400 mm or 600 mm	
Raising/lowering Time		400 mm: 14 s, 600 mm: 20 s	
Allowable Ship's Speed		18 kn max. (16 kn during raise/lower operation)	
Driving system		Remote electric control	
ENVIRONMENT			
Temperature		0°C to +55°C	
Waterproofing		IPX2 (w/o connector panel of processor unit)	
POWER SUPPLY			
Processor unit		100-240 VAC: 4.0-2.0 A, 1 phase, 50-60 Hz	100-240 VAC: 4.5-2.2 A, 1 phase, 50-60 Hz

CSH5130-A-5L Transceiver Unit 20 kg 44.1 lb

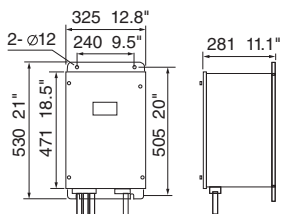

CSH8030-A-8L Transceiver Unit 37 kg 81.6 lb

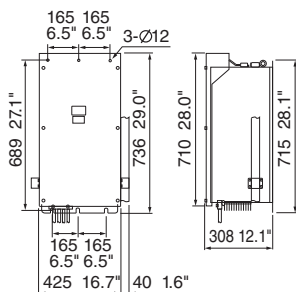

CSH5211-A Control Unit 3.5 kg 7.7 lb

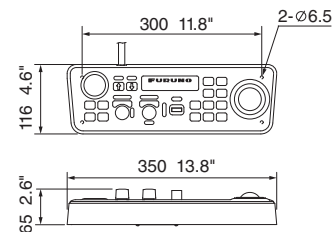

CSH5210-A Processor Unit 3.4 kg 7.5 lb

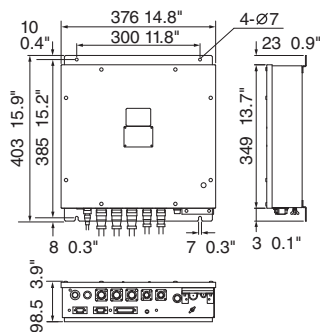

CSH5020-A Preampifier 6.5 kg 14.3 lb

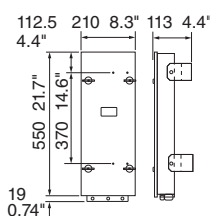

CSH5040-A (600 mm travel) Hull Unit 75 kg 165 lb
CSH5041-A (400 mm travel) Hull Unit 70 kg 154 lb

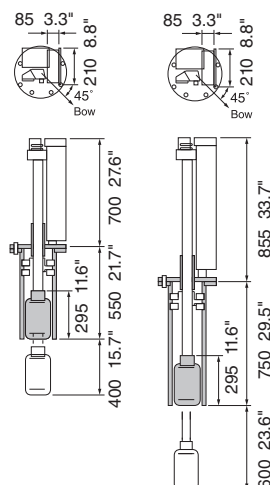

CSH8040-A (600 mm travel) Hull Unit 82 kg 180.8 lb
CSH8041-A (400 mm travel) Hull Unit 81 kg 178.6 lb

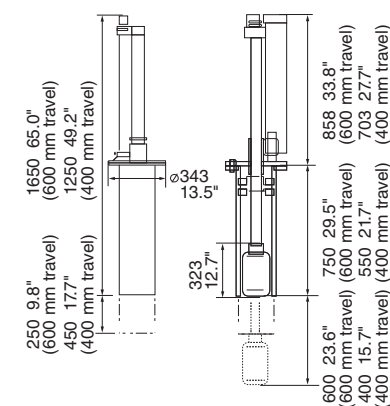

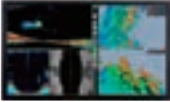
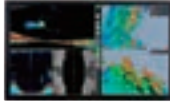
		MULTI BEAM SONAR	
		WMB3230	WMB5230
			
GENERAL			
Frequency		160 kHz	80 kHz
Output Power		14 settings from 40 W to 1 kW	14 settings from 150 W to 1.2 kW
Effective Beam Width (arhwartships x fore-aft)		120° x 4°	
Beam Spacing		Equi-Angular 120° @ 1.07° beams	
Beam Width		112 beams x 1.07° over 120°	
Maximum Depth		200 m	500 m
Max Resolution (height of smallest target detectable at nadir)		7.5 cm	15 cm
Correction		Pitch*, Roll, Heave*, Heading	*depth correction only
DISPLAY			
Display Mode		Sonar, Single/triple beam, Side scan, 2D and 3D mapping, Advanced mapping (Fish, Chart, Backscatter & Contour Overlay options)	
Display Windows		Acoustic & Charting with user-configured 1/2/3 way split panels per window, 6 panels max.	
Colors		Scan/Echo: 16 colors, Mark: 1 color	
Basic Range	Vertical	5-400 m, Shift: 5-200 m	10-800 m, Shift: 10-500 m
	Horizontal	20-3000 NM (2D) 10-1 km (3D)	
Picture advance speed		5 speeds	
Puselength		0.1, 0.2, 0.5, 1.0, 2.0 ms	0.2, 0.5, 1.0, 2.0, 3.0, 4.0, 6.0, 8.0, 10.0 ms
Mark		Vessel, Cursor, Ship, Color, Type, Name options	
Database Management		Record, Edit & Export capability	
INTERFACE			
Processor		CPU 3.4 GHz, 64 bit	
RAM Memory		4 GB of RAM	
HDD		500 GB	
Serial Port (RS-232C)		4 ports	
NMEA0183 (Input)		GGA, GGL, HDG, HDT, HVE, SHR, TSS/TS1, VTG, ZDA	
USB Port		8 ports	
ENVIRONMENT			
Temperature		0°C to +40°C	
Waterproofing		IPX2	
POWER SUPPLY			
Transceiver unit		24 VDC, 2.9 A	24 VDC, 6.3 A
Processor unit		24 VDC, 2.5 A	

WMB3230 160 kHz TRANSDUCER

15 kg 33.07 lb

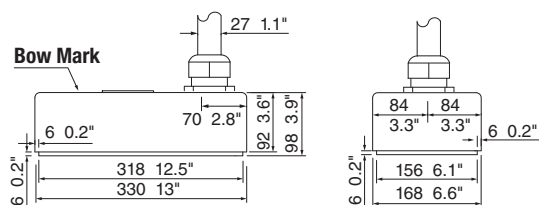

WMB5230 80 kHz TRANSDUCER

39 kg 85.98 lb

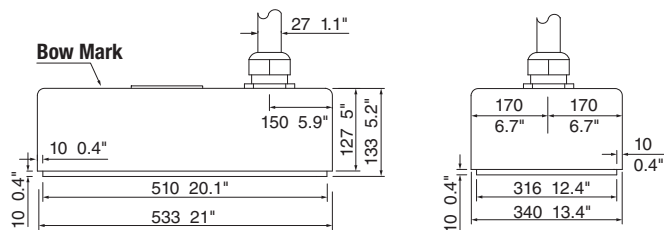

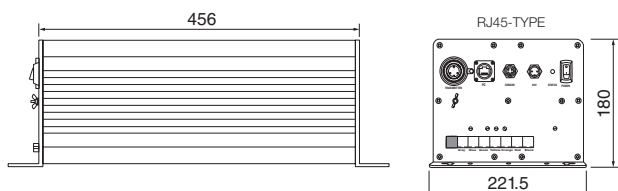

TRANSCIEVER

5 kg 11.02 lb



Autopilot

		AUTOPILOT	
		NAVipilot 700	NAVipilot 711C
			
CONTROL UNIT			
Type		Monochrome LCD	Color LCD
Screen Size		4.6"	4.1"
Effective Display Area		85.2 (W) x 85.2 (H) mm	82.6 (W) x 61.9 (H) mm
Screen Resolution		160 x 160 dots	320 x 240 dots
Screen Backlight		8 steps	
Screen Contrast		16 steps	—
PROCESSOR UNIT			
Steering mode		STBY, Auto, Dodge, Turn, Remote, Advanced auto*, Navigation*, Wind*, Fish Hunter™*, Sabiki** * external data required, ** 711C only	
Sea Condition Adjustment		AUTO/MANUAL-CALM/MODERATE/ROUGH	
Rudder Angle Settings		10 - 45 deg	
Alarm		Heading deviation, Cross-track error*, Ship's speed*, Depth*, Water temperature*, Wind*, Watch, Log trip* * external data required	
INTERFACE			
Ports		CAN bus (NMEA2000): 1, NMEA0183: 2	
Input		NMEA0183: AAM, APB, BOD, BWC, BWR, DBT, DPT, GGA, GLL, GNS, HDG, HDM, HDT, MTW, MWV, ROT, RMB, RMC, THS, TLL, VHW, VTG, VWR, VWT, XTE, ZDA CAN bus (NMEA2000): 059392/904, 060928, 061184, 126208/720/992/996, 127250/251/258/488/489, 128259/267, 129025/026/029/033/283/284/285, 130306/310/311/312/313/314/577/818/821/827/880	
Output		NMEA0183: DBT, DPT, GGA, GLL, GNS, HDG, HDM, HDT, MTW, MWV, RMB, RMC, ROT, RSA, VHW, VTG, VWR, VWT, ZDA CAN bus (NMEA2000): 059392/904, 060928, 061184, 126208/464/720/992/996, 127237/245/250/251/258, 128259/267, 129025/026/029/033/283/284/285, 130306/310/311/312/822/823/827	
ENVIRONMENT			
Temperature		-15°C to +55°C	
Waterproofing	Processor unit	IP20	
	Other unit	IP56	
POWER SUPPLY			
12-24 VDC: 4.0 - 2.0 A (excluding pump)			

NAVipilot 700 Control Unit (Bracket Mount)

0.9 kg 1.9 lb

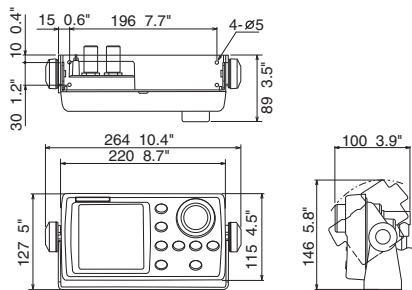

NAVipilot 711C Control Unit (Bracket Mount)

0.39 kg 0.9 lb

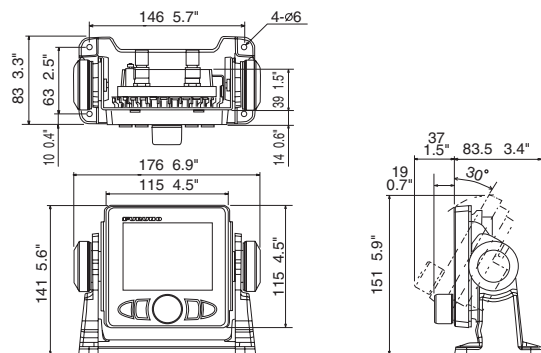

NAVipilot 700 Control Unit (Flush Mount)

0.64 kg 1.4 lb

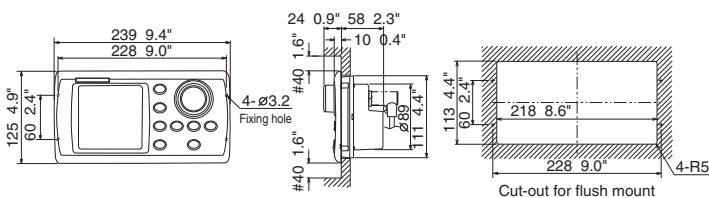

NAVipilot 711C Control Unit (Tabletop Mount)

0.39 kg 0.9 lb

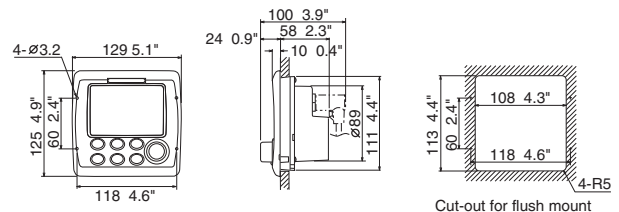

NAVipilot 700 Control Unit (Surface Mount)

0.62 kg 1.4 lb

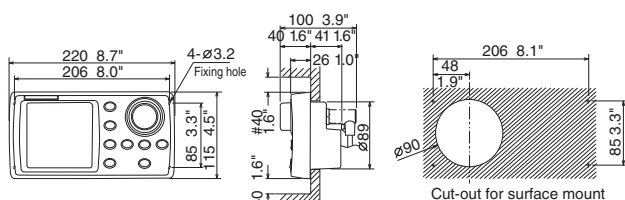

NAVipilot 711C Control Unit (Surface Mount)

0.33 kg 0.7 lb

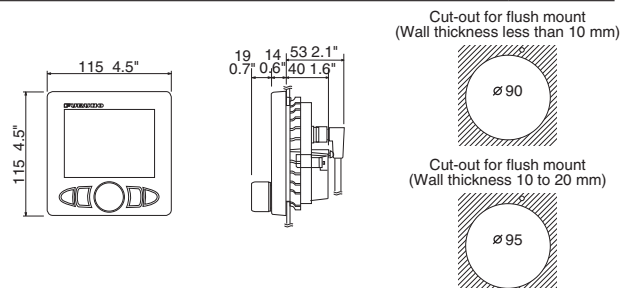

Instrument/Data Organizer

INSTRUMENT/DATA ORGANIZER	
FI70	
	
GENERAL	
Screen Size	4.1" Color LCD
Resolution	QVGA (320 x 240)
Brightness	Typical 700 cd/m ²
Display Mode	Analog meter, Graph, Highway, Race timer, Simple AIS, Data box
Language	English, French, Spanish, German, Italian, Portuguese, Swedish, Danish, Norwegian, Finnish
DISPLAY DATA	
Speed	STW, Max STW, Average STW, SOG, Max SOG, Average SOG, Velocity made good (VMG)
Wind	AWS, TWS, Max TWS, AWA, TWA, Beaufort wind GWD
Heading	HDG, Average HDG, Heading on next tack, ROT
Course	COG
Timer	Count down timer 1, Count down timer 2, Count up timer
Navigation	Bearing, RNG, WPT, XTE, Position, ETA time, ETA date, Trip, Odometer
Boat	Rudder angle, Trim tabs, Roll/Pitch
Engine	Engine RPM, Trip fuel used, Fuel rate, Engine trim/tilt, Boost pressure, Engine temperature, Engine hour, Oil pressure, Oil temperature, Coolant pressure, Engine load, Transmission oil temperature, Transmission oil pressure
Tank	Tank level 1-6
Depth	Depth
AIS	AIS
Voltage	Supply voltage
Environment	Date, Time, Water temperature, Air temperature, Atmospheric pressure, Humidity, Wind chill temperature, Dew point
INTERFACE	
CAN bus (NMEA2000)	1 port
Input	059904, 060928, 061184, 126208/720/992/996, 127237/245/250/251/257/258/488/489/493/497/505, 128259/267, 129025/026/029/033/038/039/040/283/284/285/794/809/810, 130306/310/311/312/313/314/316/576/577, 130816/821/822/825/880/841
Output	059392/904, 060928, 061184, 126208/464/720/993/996, 816/821/822/823/825/841
ENVIRONMENT	
Temperature	-15°C to +55°C
Waterproofing	IP56
POWER SUPPLY	
	15 VDC through CAN bus 0.15 A max, LEN3

Instrument FI70

0.22 kg 0.5 lb

Frontmount Installation (optional kit required)

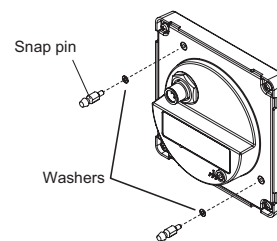
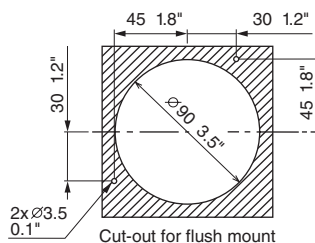
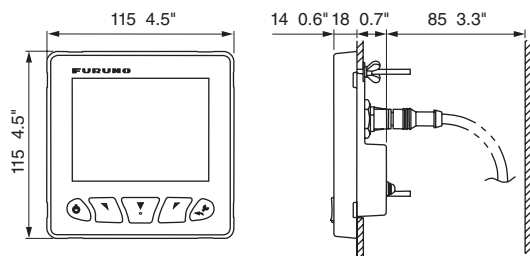



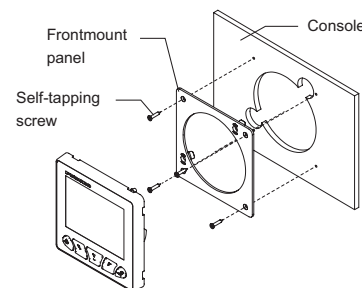
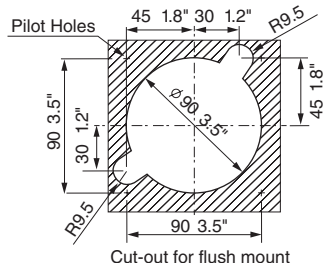
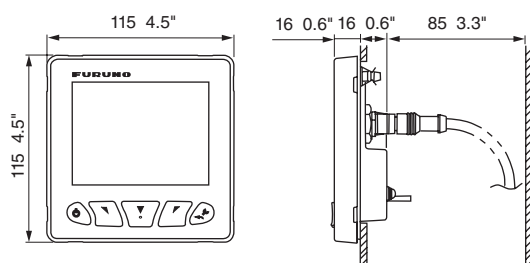

Instrument (Front Mount) FI70

0.24 kg 0.5 lb



Instrument/Data Organizer

ELECTRONIC NAVIGATION INSTRUMENTS					
	FI5001 Wind Transducer	FI5001L (Long Shaft) Wind Transducer	DST800 Depth/Speed/Temp sensor	FI5002 Junction Box	IF-NMEAFI Analog NMEA Data Converter
					
GENERAL	Power supply: 12 VDC, less than 40 mA Transducer cable: 30/50 m		Frequency: 235 kHz Cable: 6 m	CAN bus backbone x 2 ports CAN bus x 6 ports Power supply: 12 VDC, less than 2 A	CAN bus: 1 port External Sensor: Tank gauge wind transducer (FI5001 or FI5001L) Speed/Temperature sensor (ST-02PSB or ST-02MSB) Power supply: 15 VDC, less than 200 mA

Wind Transducer FI5001

0.3 kg 0.7 lb

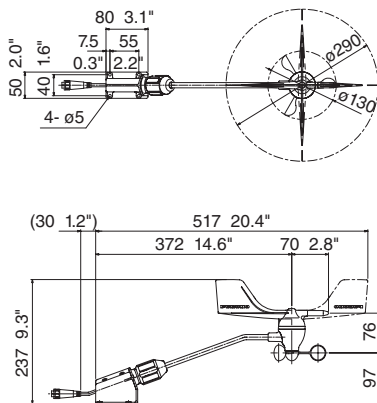

Wind Transducer FI5001L (Long Shaft)

0.4 kg 0.9 lb

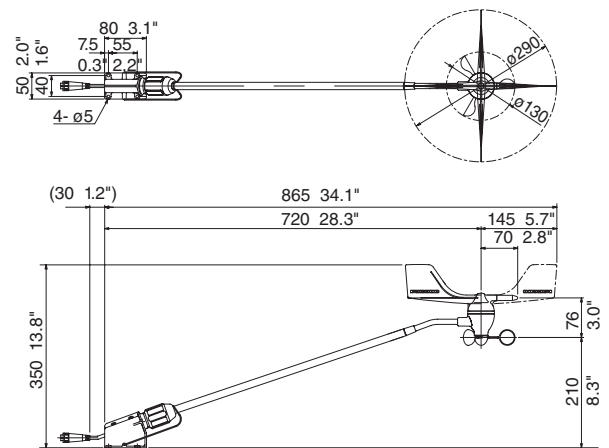

Depth/Speed/Temp Sensor DST-800 (Option)

0.9 kg 2.0 lb

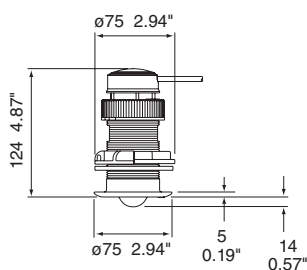

Junction Box FI5002 (Option)

0.3 kg 0.7 lb

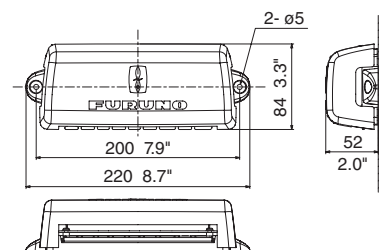

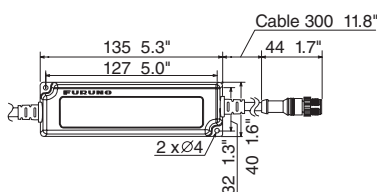

Analog NMEA Data Converter IF-NMEAFI (option)

0.35 kg 0.77 lb



Monitors

	15" MARINE DISPLAY	19" MARINE DISPLAY
	MU150HD	MU190HD
		
DISPLAY CHARACTERISTICS		
Screen Size	15 inches, landscape	19 inches, landscape
Resolution	XGA (1024 x 768)	SXGA (1280 x 1024)
Contrast Ratio (typical)	600 : 1	900 : 1
Viewing Angle (typical)	left/right and up/down: 80° or more	
Max Brightness (typical)	1000 cd/m ²	
Min Brightness (typical)	0.2 cd/m ² or less	
INTERFACE		
Analog RGB (D-SUB/15 pins)	1 port	1 port
DVI (DVI-D)	2 ports	2 ports
Composite Video (NTSC/PAL)	3 ports	3 ports
Built-in Scaler	VGA to SXGA	VGA to SXGA
POWER SUPPLY		
	12-24 VDC 4.5 - 2.2 A	12-24 VDC 8.4 - 3.9 A
ENVIRONMENT (IEC 60945 test method)		
Temperature	-15°C to +55°C	
Waterproofing	IP56 (CFR46, front panel), IP22 (rear panel)	
EQUIPMENT LIST		
	Standard 1. Display Unit 2. Installation Materials, Accessories and Spare Parts	Option 1. Cable Assembly 2. Bracket Assembly (w/knobs) 3. Hood Assembly 4. Flush Mount Kit (for fixing at front)

MU150HD Flush Mount

5.4 kg 11.9 lb

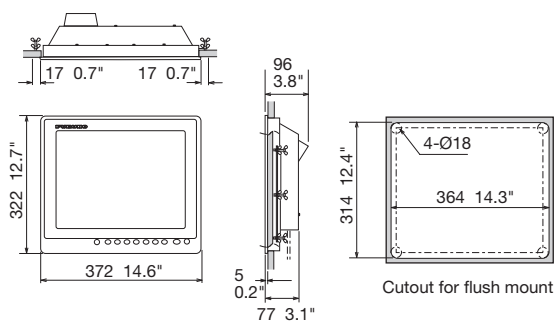

MU190HD Flush Mount

8.2 kg 18.1 lb

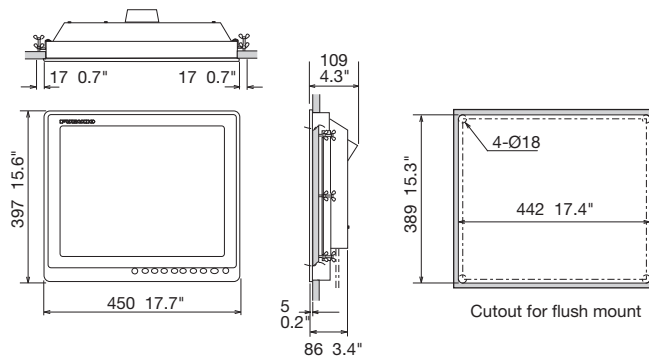

MU150HD Bracket Mount

7.4 kg 16.3 lb

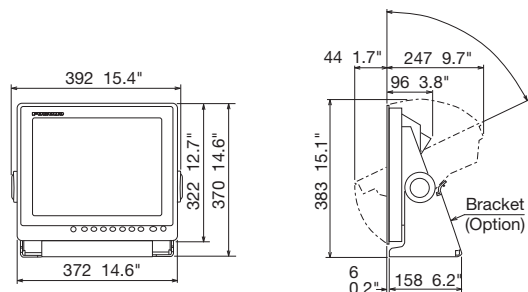

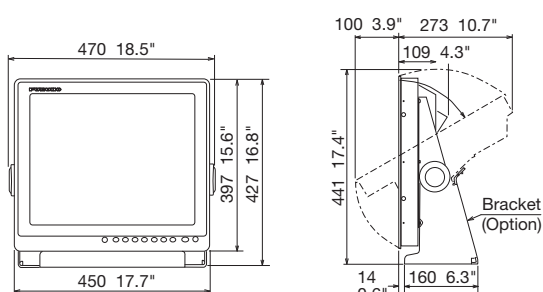

MU190HD Bracket Mount

11 kg 24.3 lb



Monitors

	17" Hi-Brite Multi Touch Monitor	19" Hi-Brite Multi Touch Monitor	24" Hi-Brite Multi Touch Monitor
	MU170T	MU190T	MU240T
			
DISPLAY CHARACTERISTICS			
Screen Size	17 inches, 5:4 Aspect Ratio	19 inches, 5:4 Aspect Ratio	24 inches, 16:9 Wide Aspect Ratio
Resolution	1280 x 1024	1280 x 1024	1920 x 1080
Contrast Ratio (typical)	1,000 : 1	1,000 : 1	3,000 : 1
Viewing Angle (typical)	+/- 80° (typical) (Up/Down/Left/Right)	+/- 89° (typical) (Up/Down/Left/Right)	
Max Brightness (typical)	1,000 NITS Hi- Brite	800 NITS Hi- Brite	1,000 NITS Hi- Brite
INTERFACE			
Analog RGB (D-SUB/15 pins)	2 ports		
DVI (DVI-D)	2 ports		
Composite Video (NTSC/PAL)	3 ports		
Supported Resolutions	VGA to SXGA	VGA to SXGA	VGA to WUXGA
POWER SUPPLY			
	115 & 230 VAC, 50/60Hz + 24 VDC		
	Note: You may connect either AC or DC power or both. When both sources are connected, power will be sourced from the AC input. If AC input is lost, there will be an uninterrupted switch-over to DC input.		
ENVIRONMENT (EN60529 test method)			
Temperature	-15°C to +55°C		
Waterproofing	IP66 (front panel), IP22 (rear panel)		

MU170T (Flush Mount)

13.6 lb

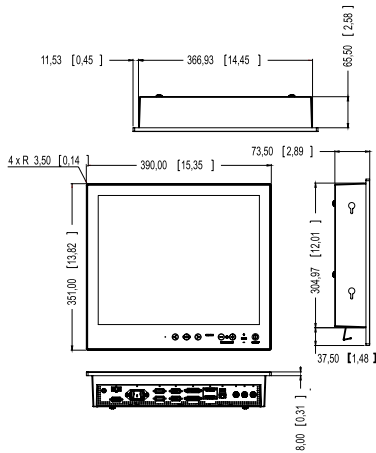

MU190T (Flush Mount)

18 lb

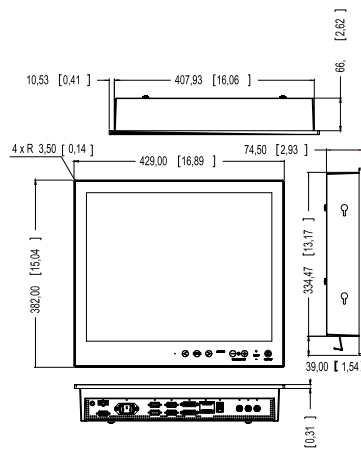

MU240T (Flush Mount)

24.2 lb

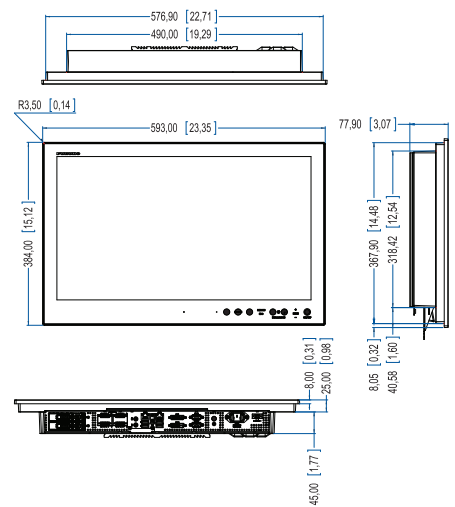

Remote Display

REMOTE DISPLAY	
RD33	
	
GENERAL	
Screen Size	4.3" color LCD
Effective display area	95.04 (W) x 53.85 (H) mm
Pixel number	480 x 272
Display style	1/2/3/4 data, Highway, Graph, Alphanumeric, 6-way split
Display mode	Nav data, Highway, Heading, Speed, Depth Graph, Graph, Layline, STW, SOG, RPM, Rudder, Wind angle, Airtemp, Humidity, Roll pitch, ROT, Battery, Engine temp, Oil pressure, Oil temperature, Coolant pressure, Trim, Watch
INTERFACE	
Ports	NMEA0183 (ver. 2.0, 3.0): 1, CAN bus: 2 (male/female)
Input	(NMEA0183) APB, BWR, BWC, CUR, DBT, DPT, DBS, DBK, GLL, GGA, GNS, GTD, GLC, HDT, HDG, HDM, MTW, MDA, MWV, RSA, RMA, RMB, RMC, ROT, VHW, VBW, VTG, VWT, VWR, VDR, XTE, ZTG, ZDA, PFEC, Gpatt (Pitch & Roll) (CAN bus) 059904, 060928, 126208, 126992, 127245, 127250, 127257, 127258, 127488, 127489, 127497, 128259, 128267, 128275, 129025, 129029, 129033, 130306, 130310, 130311, 130577
Output	(NMEA0183) DPT, VHW, RMC, MWV, HDT, HDG, XTE, MTW, RSA, VTG (CAN bus) 059392, 059904, 060928, 126208, 126464, 126996, 126992, 127245, 127250, 128259, 128267, 129026, 129029, 129283, 129284, 130306, 130311
ENVIRONMENT	
Temperature	-15°C to +55°C
Waterproofing	IP56
Power Supply	
	15 VDC: LEN6 (CAN bus)
	12-24 VDC: 0.2-0.1 A (Non CAN bus)

RD33 Display Unit (Bracket Mount)

0.7 kg 1.54 lb

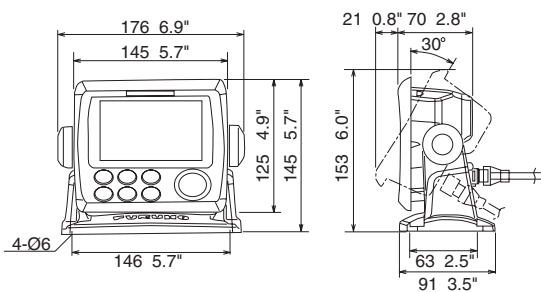

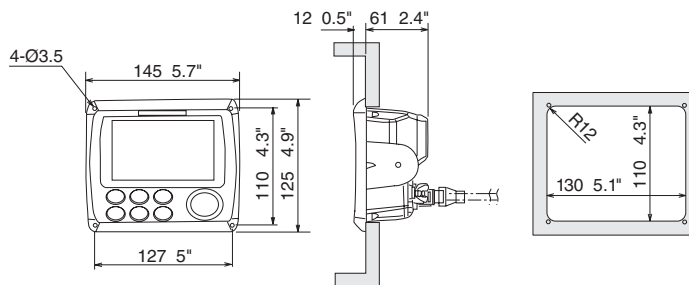

RD33 Display Unit (Flush Mount)

0.59 kg 1.3 lb



Compass

		SATELLITE COMPASS		
		SC30	SC50	SC110
				
GENERAL				
Heading Accuracy		0.5° rms	0.5° rms	0.3° rms
Heading Resolution		0.1°		
Follow-up		45°/s rate-of-turn		
Settling Time		3 mins		4 mins
Position Accuracy		10 m or 3 m (WAAS), 95% of the time	10 m, 5 m (DGPS), 3 m (WAAS)	
INTERFACE				
Heading/ Nav Data Output		1 port in CAN bus (NMEA2000)	10 ports* (5 ports in AD-10 or 10 ports in IEC61162-1/-2), 1 Port in AD-10 *can be utilized in menu selection	
Output sentence		2 ports in NMEA0183, 1 port in AD-10, 1 port in Analog *Optional Interface Unit IF-NMEASC is required	—	
PGN	127250, 127257, 065280, 126992, 129033, 129026, 129025, 129029, 127258, 129540, 130820	—		
	25,100,200 ms, 1,2 s data rate	HDT, HDG, HVE, HDM, ATT (Pitch and Roll) *Optional Interface Unit IF-NMEASC is required	HDT, HDM (Heading), ROT (Rate of turn), ATT (Pitch and Roll), HDG, THS	
	1,2 s data rate	VTG, GGA, ZDA (UTC), RMC *Optional Interface Unit IF-NMEASC is required	VHW* (Heading), VTG, VBW* (SOG), GGA, GLL, GNS (L/L), ZDA (UTC), VDR* (Set and Drift) *only when STW is input	
Log Output	1 port	—	200/400 p/NM (closure)	
Alarm Output	1 port	—	Alarm signal (closure signal)	
Heading Input	1 port	—	Backup Heading (AD-10/IEC 61162-1) HDT, HDG, HDM, VBW, VHW, VLW	
DGPS Input	1 port	—	RTCM SC104 format	
DISPLAY UNIT				
Display Type		—	4.5" monochrome LCD	
Effective display area		—	95 (W) x 60 (H) mm	
Pixel number		—	120 x 64	
Contrast		—	64 levels	
Display Mode		—	Heading, Nav data, Steering, Compass rose, Rate of turn and set and Drift modes	
ENVIRONMENT				
Temperature	Display/Processor Unit	—	-15°C to +55°C	
	Antenna Unit	—	-25°C to +70°C	
Waterproofing	Antenna Unit	IP56	IPX6	
	Display Unit	—	IPX5	
	Processor Unit	—	IPX0	
POWER SUPPLY				
		12-24 VDC: 0.4-0.23 A LEN8	12-24 VDC: 1.2-0.5 A	

SC30 Sensor Unit

2.5 kg 5.5 lb

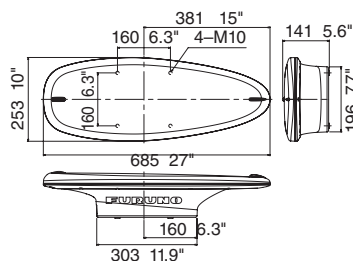

SC50/110 Display Unit

0.55 kg 1.2 lb

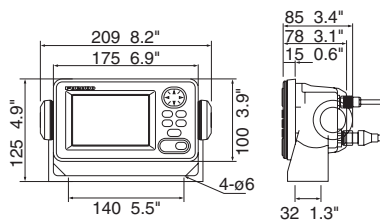

SC50/110 Processor Unit

4.2 kg 9.3 lb

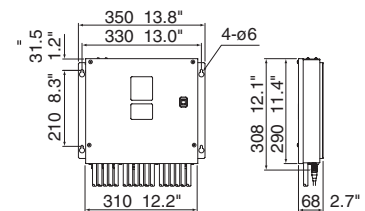

SC50 Antenna Unit (Open)

3.9 kg 8.6 lb

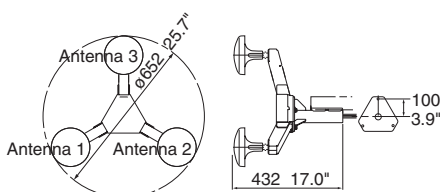

SC50 Antenna Unit (Radome)

4.2 kg 9.3 lb

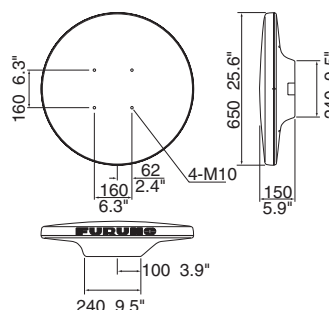

SC110 Antenna Unit

6.8 kg 15 lb

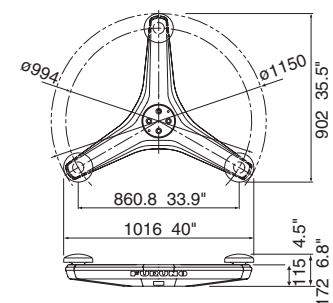

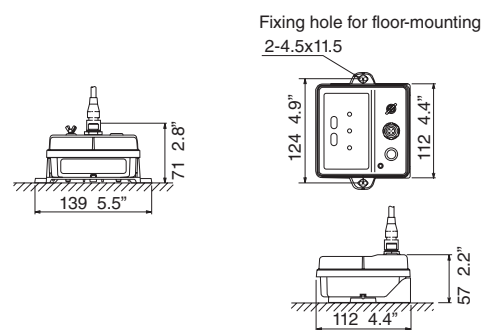

INTEGRATED HEADING SENSOR	
PG700	
	
GENERAL	
Heading Accuracy	±1.0° (horizontal)
Heading resolution	0.1°
Follow-up	45°/s rate-of-turn
Correction	Automatic by swinging the boat
Deviation	
INTERFACE	
Port	CAN bus: 1
Output	065284, 127250
Input	059904, 060928, 061184, 126720, 126208, 130818, 165283
ENVIRONMENT	
Temperature	-15°C to 55°C
Waterproofing	IP55
Power Supply	
	9-16 VDC (LEN=3)

PG700 (floor mounting) Main Unit 0.31 kg 0.7 lb

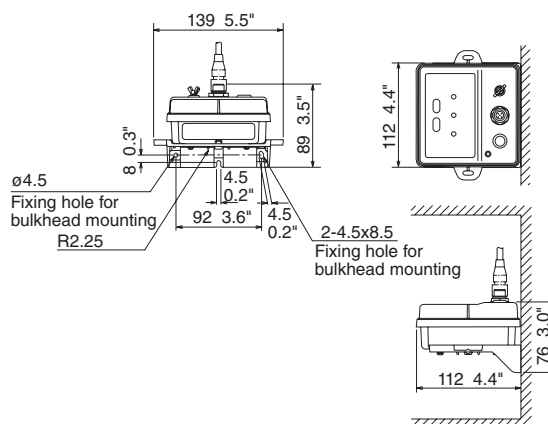

PG700 (bulkhead mounting) Main Unit 0.35 kg 0.77 lb



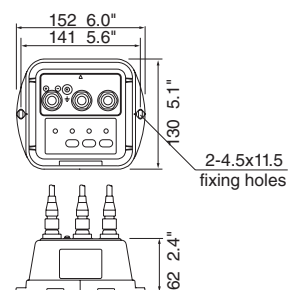

INTEGRATED HEADING SENSOR		
PG500R		
		
GENERAL		
Heading Accuracy	±1.0° (horizontal)	
Heading resolution	0.1°	
Follow-up	25°/s rate-of-turn	
Correction	Automatic by swinging the boat	
Deviation		
Variation	Automatic through GPS navigator or manual with RD-30.	
INTERFACE		
I/O Port	Input	1 port
	Output	2 ports (one port drives 3 outputs)
Output		FURUNO AD-10 format, IEC 61162-1 (NMEA0183 Ver2.0) HDG, HDT, HDM
Input		IEC 61162-1 (NMEA0183 Ver1.5/2.0) RMC, VTG
Data Update	AD-10 formatted	25 ms
	IEC 61162-1 (NMEA0183)	100 ms, 200 ms or 1 s selected
ENVIRONMENT		
Temperature		-15°C to 55°C
Waterproofing		IPX5 (IEC 60529), CFR46 (USCG standard)
Power Supply		
		12-24 VDC: 120-30 mA

PG500R 0.3 kg 0.7 lb



Communications

		AIS RECEIVER	Class-B AIS TRANSPONDER	U-AIS TRANSPONDER
		FA30	FA50	FA170
				
STANDARDS				
		IMO MSC.74 (69) ANNEX 3, ITU-R Rec. M.1371-2, IEC 60945 Ed.4, IMO Res. A.917 (22)	IMO MSC.140(76), ITU-R M.1371-2, DSC ITU R M.825-3, IEC 62287-1, IEC 60945 Ed.4	IMO MSC.74(69) ANNEX 3, IMO MSC.302(87), IMO A.694(17), IMO MSC.191(79), ITU-R M.1371-5, DSC ITU-R M.825-3, IEC61993-2 Ed. 2, IEC60945 Ed. 4 CORRIGENDUM 1, IEC 62288 Ed. 2, IEC 61162-1 Ed. 4, IEC 61162-2 Ed. 1, IEC61162-450 Ed. 1
TRANSPONDER UNIT*				
		*FA30: RECEIVER UNIT		
TX/RX Frequency (FA30: RX Frequency)		156.025 to 162.025 MHz		
Output Power		—	1 W/2 W	1 W/12.5 W
Channel Spacing		25 kHz/12.5 kHz	25 kHz	25 kHz
MONITOR UNIT				
Screen Size		—	—	4.3" Color LCD
Effective Viewing Area		—	—	95.04 (W) x 53.8 (H) mm
Pixel Number		—	—	480 x 272 dots
GPS RECEIVER				
Receiving Channels		—	12 channels parallel, 12 satellites tracking	12 channels parallel, 12 satellites tracking
Rx Frequency		—	1575.42 MHz	1575.42 MHz
Rx Code		—	C/A code	C/A code
Position Accuracy		—	10 m (HDOP ≤ 4)	GPS: less than 13 m (2 drms, HDOP < 4) DGPS: less than 5 m (2 drms, HDOP < 4)
INTERFACE				
COM	Input	ACK, ACA, AIQ, DTM, GBS, GGA, GLL, GNS, HDT, OSD, RMC, VBW, VTG, DSC, DSE, ZDA	ACK, BBM, DTM, GBS, GGA, GLL, GNS, HDT, OSD, RMC, THS, SSD, VBW, VSD, VTG, AIQ, DSC, DSE	ABM, ACA, ACK, ACM, ACN, AIQ, AIR, BBM, DTM, EPV, GBS, GGA, GLL, GNS, HBT, HDT, LRF, LRI, OSD, PIWVIVD, PIWVSPW, PIWVSSD, PIWVSD, RMC, ROT, SPW, SSD, THS, VBW, VSD, VTG
	Output	VDM, VDO, ACA, ACS, ALR, TXT	VDM, VDO, ABK, ACA, ACS, ALR, TXT	ABK, ACA, ACS, ALC, ALF, ALR, ARC, EPV, HBT, LR1, LR2, LR3, LRF, LRI, NAK, PIWVIVD, PIWVSPR, PIWVSSD, PIWVSD, SSD, TRL, TXT, VER, VDM, VDO, VSD
Ethernet		10/100BASE-T	10/100BASE-T	100Base-TX, RJ45 connector, Auto MDI/MDIX
ENVIRONMENT				
Temperature	Antenna Unit	—	-30°C to +70°C	-30°C to +70°C
	Other Units	-15°C to +55°C	-15°C to +55°C	-15°C to +55°C
Waterproofing	Antenna Unit	—	IPX6	IP56
	Other Units	IP20	IP20	Transponder unit: IP22 at bulkhead mount, IP20 at floor Monitor unit: IP22, IP35 with optional waterproofing kit Pilot plug unit (front panel)/Power supply unit: IP22
POWER SUPPLY				

Transponder Unit FA1701 3.0 kg 6.6 lb
 FA30 AIS RECEIVER 1.5 kg 3.3 lb
 GPS Antenna GPA-017S 0.15 kg 0.3 lb
 GPS/VHF Combined Antenna GVA-100-T 3.3 kg 7.3 lb
FA50 Class-B AIS Transponder 1.7 kg 3.7 lb

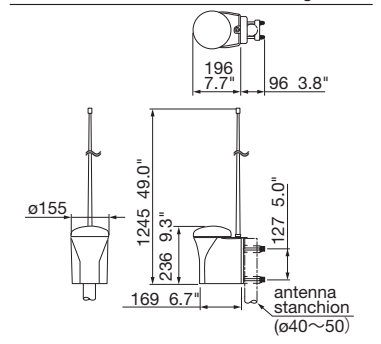
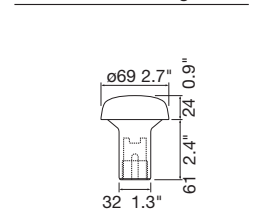
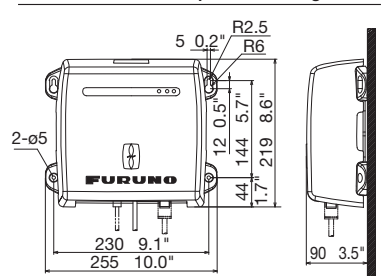
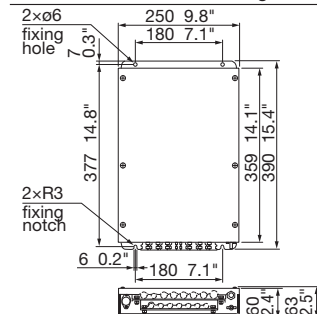

Monitor Unit (Flush Mount) FA1702

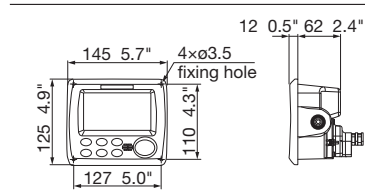

0.6 kg 1.3 lb

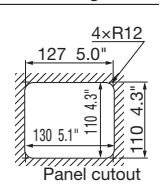

Monitor Unit (Hanger Mount) FA1702

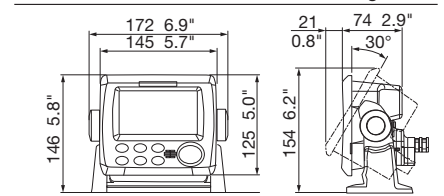

0.7 kg 1.5 lb

		MF/HF RADIOTELEPHONE	
		FS1575	FS2575
			
GENERAL			
Frequency Range	TX	1.6 to 27.5 MHz (100Hz Steps)	
	RX	0.1 to 29.9 MHz (10Hz Steps)	
Channels	256 user-specified channels plus ITU, SSB/TELEX channels		
Rules and Regulations	ITU-R M. 1082-1, ITU-R M. 1173, ITU-R M. 476-5, ITU-R M. 490, ITU-R M. 491-1, ITU-R M. 492-6, ITU-R M. 493-13, ITU-R M. 541-9, ITU-R M.625-3, ITU-R M.821-1, IMO Res. A. 694 (17), IMO Res. A. 806 (19), IMO Res. MSC36 (63), IMO Res. MSC68 (68), MSC/Circ. 862, IEC 61162-1 Ed. 4, IEC 60945 Ed. 4, ETS 300 067 ed. 1, EN 300 338-1 V1.3.1, EN 300 338-2 V1.3.1, EN 301 033 V1.3.1, EN 300 373-1 V1.3.1		
Communication System	Simplex/semi-duplex		
Class of Emission	J3E, H3E, A1A, J2B		
TRANSCIVER			
RF Output Power	150 W pep		250 W pep
Antenna	10-18 m whip or wire		
Tuning Speed	within 15 sec.		
Receiver Sensitivity	less than +7 dBµV (4.0-29.99999 MHz, J3E) / less than +13 dBµV (1.6-4 MHz, J3E)		
DSC			
Receiving	General	All DSC frequencies in MF/HF	
Frequency	Distress and safety	DSC distress/safety frequencies: 2187.5 kHz, 4207.5 kHz, 6312.0 kHz, 8414.5 kHz, 12577 kHz, 16804.5 kHz	
Message Storage	TX:	50 distress messages, plus 50 non-distress messages	
	RX:	50 messages, telephone no., frequencies, etc.	
POWER SUPPLY			
		24 VDC, 20 A (TX), 5.0 A (RX) 100/110/200/220/240 VAC Power Supply PR-300	24 VDC, 40 A (TX), 5.0 A (RX) 100/110/120/200/220/240 VAC with optional AC/DC Power Supply PR-850A

Transceiver Unit FS1575T 16 kg 35.2 lb

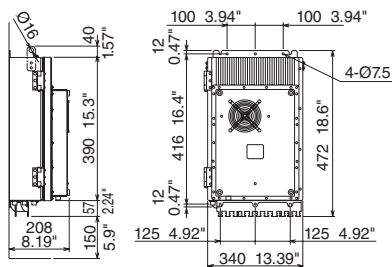

FS2575C 1.8 kg 4.0 lb

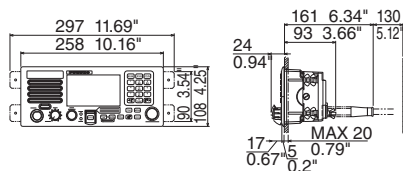

Antenna Coupler AT1575-SUS 8.8 kg 19.4 lb

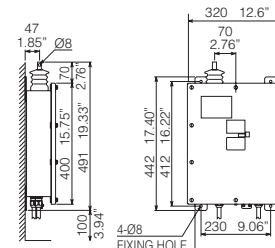

Transceiver Unit FS2575T 20 kg 44.1 lb

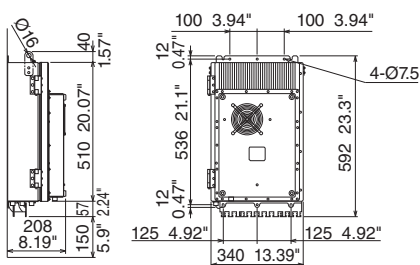

Antenna Coupler AT5075 9.2 kg 20.1 lb

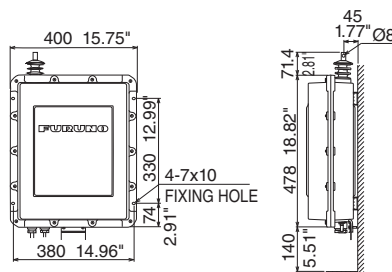

Antenna Coupler AT1575-AES 2.6 kg 5.7 lb

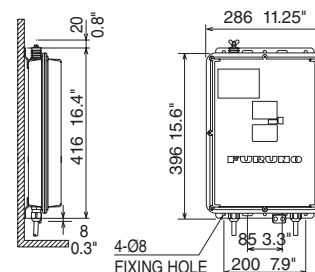

Handset HS2003 0.5 kg 1.2 lb

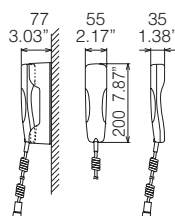

Communications

VHF RADIOTELEPHONE	
FM8900S	
	
GENERAL CHARACTERISTICS	
Class of Emission	G3E (Radiotelephone), G2B (DSC)
Communication System	Simplex/Semi-duplex
Channels	All VHF channels according to ITU-R Radio Regulations Appendix 18, All channels in FCC Part 80, Max 20 Private channels where permitted by Administrations (preset by the service agent), 10 weather channels (USA and Canada, receive only)
Rules and Regulations	VHF Radiotelephone: EN 301 925 V1.3.1 (2010.9) VHF ATIS: EN 300 698-1 V1.4.1 (2009.12) DSC: ITU-R M.493-13 (2009-10), ITU-R M.541-9 (2004.05), ITU-R M.689-2 (1994.09), EN 300 338-1/-2 V1.3.1 (2010.02)
Display	4.3 inches WQVGA (480 x 272 dots), color dot matrix LCD
TRANSMITTER	
Frequency Range	155.00 - 161.600 MHz
RF Output Power	High: Max 25 W, Low: Not exceed 1 W US version: Manual override for 25 W available on CH13, CH67 and CH77 (usually not exceed 1 W)
Frequency Stability	less than ±1.5 kHz
RECEIVER	
Frequency Range	Simplex: 155.000 - 161.600 MHz Semi-duplex: 159.600 - 164.200 MHz
Receiving System	Double-conversion super-heterodyne 1st IF : 51.1375 MHz, 2nd IF: 62.5 kHz
AF Output Power	3 W (4 Ω loud speaker), 2 mW (150 Ω handset)
Audio Response	De-emphasis of 6 dB/oct +1/-3 dB
Sensitivity	less than 6 dBμV at SINAD 20 dB
Adjacent Channel Selectivity	70 dB or more
DSC Section	
Message Log	Receive: 50 distress messages plus 50 non-distress messages Transmit: 50 messages
Interface	Nav data: IEC61162-1 Ed.4 Printer: Centronics-compatible
Alarm	Audible and visual on receipt of a DSC call
Receiver Characteristics	DSC frequency: 156.525 MHz (CH70) Calling sensitivity: Symbol error rate: less than 1% (at 0 dBμV)
ENVIRONMENT	
Temperature	-15°C to +55°C
Waterproofing	FM-8900S: IP20 (IP22 with option), HS-2003: IP24, RB-8900: IP22
POWER SUPPLY	
	24 VDC
RX	2.3 A (MAX), 1.3 A (standby)
TX	4.7 A (MAX)

Transceiver Unit (Flushmount) FM-8900S

4.2 kg 9.3 lb

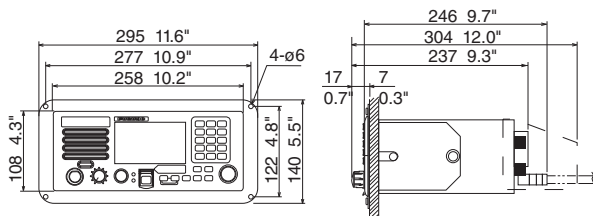

Remote Station RB-8900

0.7 kg 1.5 lb

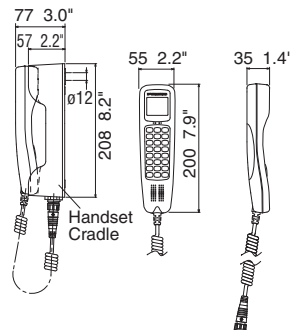

Handset HS-2003

0.2 kg 0.4 lb

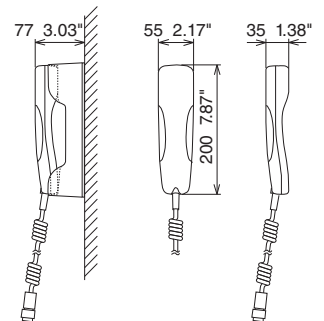

LOUD HAILER	
LH3000	
	
AUDIO OUTPUT	
Hail speaker	20 W, 8 Ω
Intercom speaker	4.0 W, 4 Ω
External speaker	4.0 W, 4 Ω
Internal speaker	2.2 W, 4 Ω
INPUT IMPEDANCE	
MIC impedance	600 Ω
Aux impedance	10 kΩ
INPUT SENSITIVITY	
MIC sensitivity	-73 dB ±3 dB (0 dB=1 V/μBar at 1 kHz)
Aux sensitivity	0 dBm ±3 dB (at 1 kHz)
DISTORTION FACTOR	
Hail mode	less than 10% (1 kHz 20 W)
Intercom mode	less than 10% (1 kHz 4.0 W)
ENVIRONMENT	
Ambient temperature	-15°C to +55°C
Waterproofing	IPX5 (Front panel), IPX0 (Other)
POWER SUPPLY	
12 VDC ±20%, less than 5 A, less than 280 mA (standby)	

LH3000

2.0 kg 4.4 lb

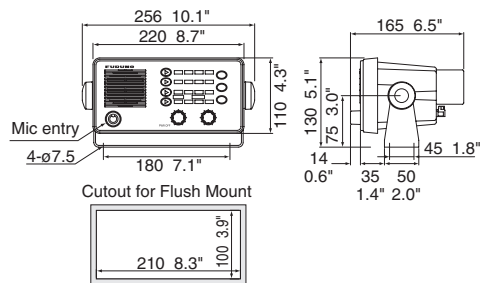

Microphone
DM2003

0.2 kg 0.44 lb

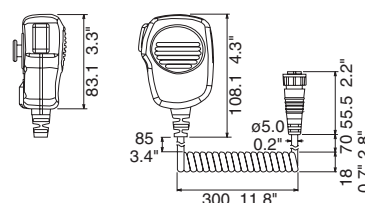

Intercom Speaker
LH3010

0.56 kg 3.3 lb

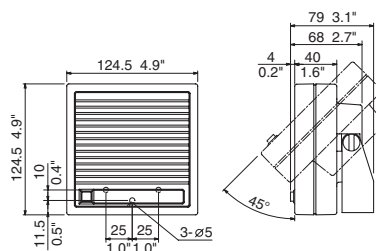

NX300 Display Unit

0.68 kg 1.5 lb

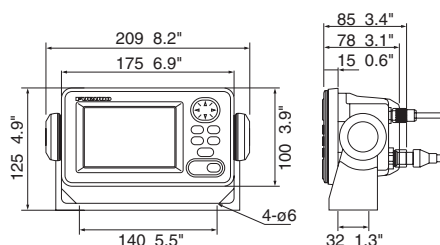

Antenna Unit
NX3H-D

0.9 kg 2.0 lb

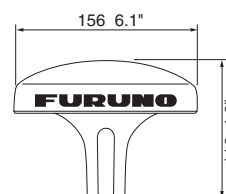

NAVTEX RECEIVER					
NX300					
					
NAVTEX RECEIVER					
Receiving Frequency	518 kHz or 490 kHz				
Mode of Reception	F1B				
Sensitivity	2μ V e.m.f. (50 ohms), 4% error rate				
Message Category	<ul style="list-style-type: none"> A: Navigational warning B: Meteorological warning C: Ice report D: Search and rescue information/piracy and armed robbery E: Meteorological forecast F: Pilot message G: AIS Service message H: Loran-C message I: Reserve-presently not used J: Differential omega message K: Other electronic navigational aid and system message L: Navigational warning (additional) M to Y: Reserve _ presently not used V: Notice to Fishermen (US only) Z: QRU (no message on hand) 				
DISPLAY					
Display	4.5" Monochrome LCD				
Effective display area	95 (W) X 60 (H) mm				
Pixel number	120 x 64				
Display Modes	Message Selection, NAV Data, Message Display				
Message Storage	28,000 Characters				
Languages	English, Spanish, German, French, Italian, Danish, Dutch, Portuguese				
INTERFACE					
Input	0183 Ver.1.5/2.0, RS-232C, 4800 bps GGA, GLL, RMB, ZDA, RMC				
Output	Message data for personal computer, RS-232C, 4800 bps				
ENVIRONMENT					
Temperature	<table border="1" style="width: 100%; border-collapse: collapse;"> <tr> <td style="width: 30%;">Antenna unit</td> <td style="text-align: center;">-25°C to +70°C</td> </tr> <tr> <td>Display unit</td> <td style="text-align: center;">-15°C to +55°C</td> </tr> </table>	Antenna unit	-25°C to +70°C	Display unit	-15°C to +55°C
Antenna unit	-25°C to +70°C				
Display unit	-15°C to +55°C				
Waterproofing	<table border="1" style="width: 100%; border-collapse: collapse;"> <tr> <td style="width: 30%;">Antenna unit</td> <td style="text-align: center;">IPX6</td> </tr> <tr> <td>Display unit</td> <td style="text-align: center;">IPX5</td> </tr> </table>	Antenna unit	IPX6	Display unit	IPX5
Antenna unit	IPX6				
Display unit	IPX5				
POWER SUPPLY					
12-24 VDC: 180-90 mA					

Communications

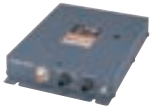
FACSIMILE RECEIVER		
FAX30		
		
GENERAL		
Frequency Range	80 kHz to 160 kHz, 2 MHz to 25 MHz, 490 kHz, 518 kHz (NAVTEX)	
Class of Emission	F3C, J3C, F1B (NAVTEX)	
Receiving System	Double superheterodyne	
Number of Channel	1000 channels	
Storage	Fax	12 pictures
	NAVTEX	130 messages
Scanning Speed	60, 90, 120, 180 or 240 rpm, automatic or manual selection	
I.O.C.	576 or 288, automatic or manual selection	
Display Color	Monochrome, 8 shades of gray, Blue shades,	
	Pink and black, Red and blue	
Networking Standard	Ethernet 10Base-T TCP/IP	
ENVIRONMENT		
Temperature	-15°C to +55°C	
Waterproofing	IPX2	
POWER SUPPLY		
	12-24 VDC: 1.0-0.5 A	
MINIMUM SYSTEM REQUIREMENTS FOR PC		
OS	Windows 98, 2000, ME, XP, Vista, 7, 8(32 bit/64 bit)	
CPU	600 MHz or faster	
RAM	128 MB or more	
Resolution	1024 x 768 pixels	
Browser	Internet Explorer Ver. 5.01 SP2/5.5 SP2/6.0 SP1/7.0, SP1/8.0 Netscape Communicator Ver. 4.78/6.2/7.0	

FAX30 Receiver Unit 2.0 kg 4.4 lb

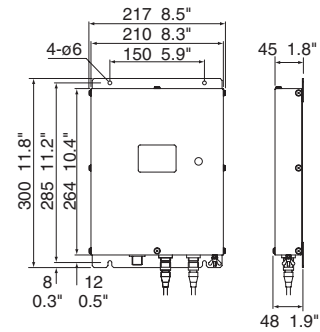

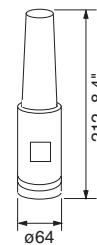

Preamp Unit FAX-5 1.3 kg 2.9 lb

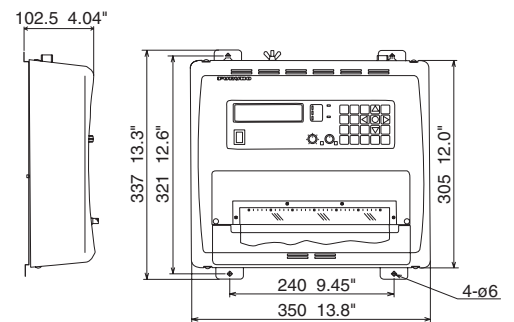

FACSIMILE RECEIVER		
FAX408		
		
RECEIVER CHARACTERISTICS		
Frequency Range	2 MHz to 25 MHz in 100 Hz steps	
Number of Channels	User programmed	164
	Pre-programmed	150
Receiving System	Synthesized double super heterodyne	
Mode of Reception	F3C	
Sensitivity	MF/HF: 2µV at 20 dB SINAD	
RECORDER CHARACTERISTICS		
Recording System	Thermal head printing	
Recording Paper	216 mm x 20 m with effective width of 212 mm	
Scanning Speed	60, 90, 120 rpm	
Gradation	9 levels	
Phase Control	Automatic or manual	
Operation	Automatic* or manual *By APSS signal Schedule Timer 16 programs/week	
ENVIRONMENT		
Temperature	-10°C to +50°C	
POWER SUPPLY		
	12-24 VDC, less than approx. 28 W	

FAX408 Receiver Unit 5.6 kg 12.3 lb



	INMARSAT FLEETBROADBAND	
	FELCOM250	FELCOM500
		

GENERAL		
Transmitting Frequency	1626.5 - 1660.5, 1668.0 - 1675.0 MHz	
Receiving Frequency	1518.0 - 1559.0 MHz	
INTERFACE		
Ethernet	RJ45	4 ports
2-wire analog telephone	RJ11	2 ports
	Phoenix 4 pin	2 ports
NMEA in/out	Phoenix 5 pin (NMEA0183 ver. 2)	1 port
Alarm output	Phoenix 3 pin Contact (Normal Close)	1 port
USIM/SIM	Plug in type	1 port
RS-232	9 pin D-Sub female connector (EIA574)	1 port
L-band output	BNC	1 port
COMMUNICATION SERVICES		
Voice	4 kbps circuit switched (AMBE+2 codec) ISDN 3.1 kHz Audio (Transparent)	
Data	ISDN UDI/RDI	—
	Standard IP(Best Effort Delivery)	Up to 284 kbps
	Streaming IP(Guaranteed Service Rate)	8, 16, 32, 64, 128 kbps
SMS (Short Message Service)	Up to 160 characters	
FAX	G3 Fax through 3.1 kHz audio	
ENVIRONMENT		
Temperature	Antenna Unit (operative temperature)	-25°C to +55°C
	Antenna Unit (storage temperature)	+70°C
	Below Deck Unit (operative temperature)	-25°C to +55°C
Waterproofing	Antenna: IP56, Below Deck Unit: IPX2, Handset: IPX2	
Ship's motion	Roll	± 30°/8 sec
	Pitch	± 10°/6 sec
	Yaw	± 8°/50 sec
	Rate of Turn	6°/1 sec
	Ship's Speed	30 knot
POWER SUPPLY		
Power Supply	10.8 - 31.2 VDC	
Fuse	12 A (TX) at 12 VDC, 6 A (TX) at 24 VDC	

FELCOM250 Antenna		FELCOM250 Antenna (with an attachment)		FELCOM500 Antenna		FELCOM500 Antenna (with an attachment)	
FB-1250-B	6.6 kg 14.5 lb	FB-1250-A	9.5 kg 20.9 lb	FB-1500-B	18 kg 40 lb	FB-1500-A	21 kg 46.3 lb
FB-1250-D	5.7 kg 12.6 lb	FB-1250-C	8.6 kg 19 lb	FB-1500-D	19 kg 41.9 lb	FB-1500-C	22 kg 48.5 lb

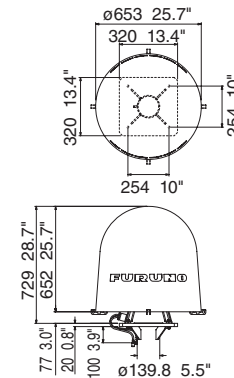
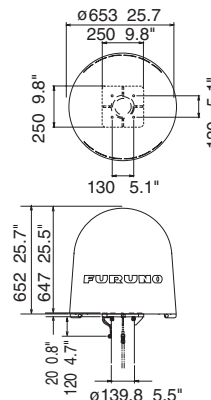
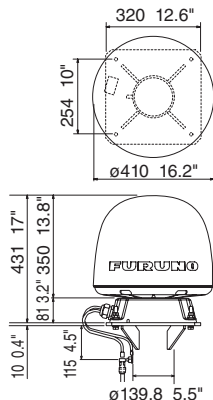
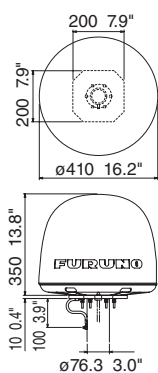

Communication Unit FB-2000	4.1 kg 9 lb	Handset FB-8000	0.38 kg 0.8 lb	Incoming Indicator FB-3000	0.37 kg 0.81 lb
-----------------------------------	--------------------	------------------------	-----------------------	-----------------------------------	------------------------

