

BLUE STREAK®

Application and Illustrated Parts Guide

Guide illustré de pièces et d'applications

Guía de piezas con aplicaciones e ilustraciones



*High performance race wires
Premium street performance wires*



SEMI-CUSTOM 9.0 MM WIRE KIT

CUSTOMIZE YOUR HIGH PERFORMANCE LS SERIES ENGINE

**Permits Routing Around Headers and
Relocation of Coil Packs**

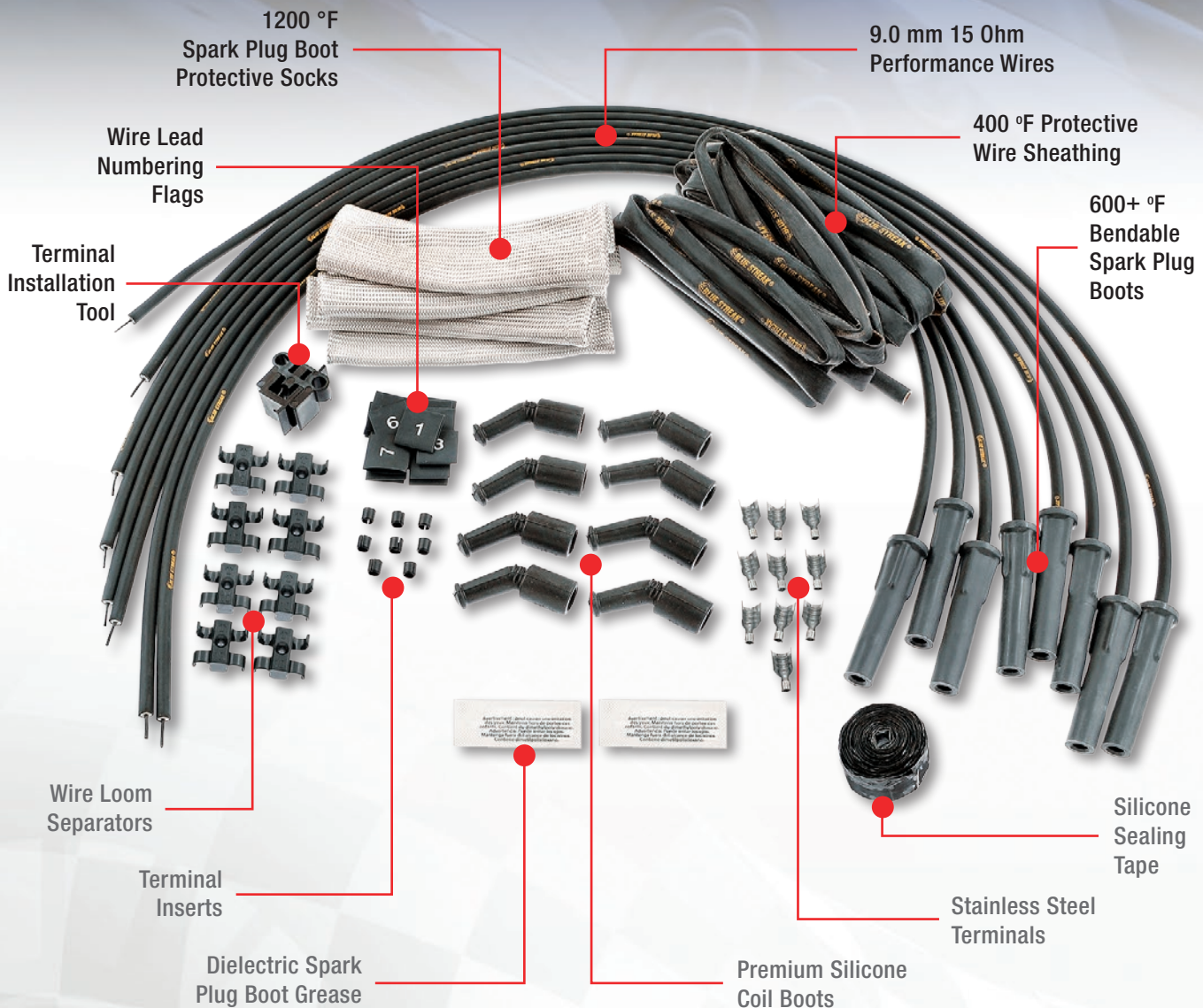

P/N: 10121

Kit includes everything shown and complete instructions for terminating and installation.
All materials are the same as those found in wire sets currently used by winning national race teams and engine builders.

BS10922

TABLE OF CONTENTS

Content	Page
Table of Contents	i
Application Guide	1-137
Illustrated Guide	139-147
Engine Identification Guide	B1-B9
Semi-Custom Wire Set Specifications	B10
Product Attribute Information	B11-B19

LISTE DE CONTENU

Le Contenu	Page
Liste de Contenu	i
Guide d'Application	1-137
Guide Illustré	139-147
Guide d'Identification du Moteur	B1-B9
Semi-Custom fil Set Specifications	B10
Informations d'Attributs de Produit	B11-B19

TABLA DE CONTENIDO

Contenido	Página
Table de Contenido	i
Guía de Aplicaciones	1-137
Guía Ilustrada	139-147
Guía de Identificación del Motor	B1-B9
Especificaciones de Cables Semi-Personalizados	B10
Información de los Atributos del Producto	B11-B19

Application Index
Indice de Demande
Indice de Aplicaciones

Make	Page	Make	Page
AM General	1	Isuzu	100-101
American Motors	1-3	Jeep	101-104
Buick	3-8	Lincoln	104-105
Cadillac	8-9	Mazda	105
Chevrolet	9-49	Mercury	105-112
Chrysler	49-50	Mitsubishi	112
De Tomaso	50	Oldsmobile	112-118
Dodge	51-64	Plymouth	118-124
Eagle	64	Pontiac	124-135
Ford	64-80	Saab	135
GMC	80-100	Studebaker	135-136
Honda	100	Toyota	136-137
Hummer	100		

Wire Sets

Year	Model/Engine	Part No.
AM General		
Wire Sets		
Spark Plug Wire Set		
Hummer		
1996-1995	8 Cyl. 5.7L; 9.0mm High Performance Wire	10038
1996-1995	8 Cyl. 5.7L; 8.5mm High Performance Wire	10018
1996-1995	8 Cyl. 5.7L; 8.5mm High Performance Wire; Equipped with Ceramic Spark Plug Boots	10046
American Motors		
Wire Sets		
Spark Plug Wire Set		
AMX		
1979-1978	8 Cyl. 5.0L; 8.5mm High Performance Wire; Equipped with Ceramic Spark Plug Boots	10114
1979-1978	8 Cyl. 5.0L; 8.5mm High Performance Wire; w/ Straight Non-Bendable Spark Plug Boot	10006
1979-1978	8 Cyl. 5.0L; 8.5mm High Performance Wire; w/ Straight Bendable Spark Plug Boot	10116
1974-1973	8 Cyl. 5.0L; 8.5mm High Performance Wire	10008
1974-1973	8 Cyl. 5.9L; 8.5mm High Performance Wire	10008
1974-1973	8 Cyl. 6.6L; 8.5mm High Performance Wire	10008
1974-1973	8 Cyl. 5.0L; 8.5mm High Performance Wire; Equipped with Ceramic Spark Plug Boots	10059
1974-1973	8 Cyl. 5.9L; 8.5mm High Performance Wire; Equipped with Ceramic Spark Plug Boots	10059
1974-1973	8 Cyl. 6.6L; 8.5mm High Performance Wire; Equipped with Ceramic Spark Plug Boots	10059
1972	8 Cyl. 5.0L; 8.5mm High Performance Wire; Equipped with Ceramic Spark Plug Boots	10114
1972	8 Cyl. 5.0L; 8.5mm High Performance Wire; w/ Straight Non-Bendable Spark Plug Boot	10006
1972	8 Cyl. 5.0L; 8.5mm High Performance Wire; w/ Straight Bendable Spark Plug Boot	10116
1972-1971	8 Cyl. 6.6L; 8.5mm High Performance Wire; w/ Straight Non-Bendable Spark Plug Boot	10006
1972-1971	8 Cyl. 6.6L; 8.5mm High Performance Wire; Equipped with Ceramic Spark Plug Boots	10114
1972-1971	8 Cyl. 6.6L; 8.5mm High Performance Wire; w/ Straight Bendable Spark Plug Boot	10116
1972-1970	8 Cyl. 5.9L; 8.5mm High Performance Wire; Equipped with Ceramic Spark Plug Boots	10114
1972-1970	8 Cyl. 5.9L; 8.5mm High Performance Wire; w/ Straight Non-Bendable Spark Plug Boot	10006
1972-1970	8 Cyl. 5.9L; 8.5mm High Performance Wire; w/ Straight Bendable Spark Plug Boot	10116
1970-1968	8 Cyl. 6.4L; 8.5mm High Performance Wire; w/ Straight Non-Bendable Spark Plug Boot	10006

Year	Model/Engine	Part No.
Spark Plug Wire Set		
AMX		
1970-1968	8 Cyl. 6.4L; 8.5mm High Performance Wire; Equipped with Ceramic Spark Plug Boots	10114
1970-1968	8 Cyl. 6.4L; 8.5mm High Performance Wire; w/ Straight Bendable Spark Plug Boot	10116
1969-1968	8 Cyl. 4.8L; 8.5mm High Performance Wire; Equipped with Ceramic Spark Plug Boots	10114
1969-1968	8 Cyl. 5.6L; 8.5mm High Performance Wire; Equipped with Ceramic Spark Plug Boots	10114
1969-1968	8 Cyl. 4.8L; 8.5mm High Performance Wire; w/ Straight Non-Bendable Spark Plug Boot	10006
1969-1968	8 Cyl. 5.6L; 8.5mm High Performance Wire; w/ Straight Non-Bendable Spark Plug Boot	10006
1969-1968	8 Cyl. 4.8L; 8.5mm High Performance Wire; w/ Straight Bendable Spark Plug Boot	10116
1969-1968	8 Cyl. 5.6L; 8.5mm High Performance Wire; w/ Straight Bendable Spark Plug Boot	10116
Gremlin		
1976-1975	8 Cyl. 5.0L; 8.5mm High Performance Wire; w/ Straight Non-Bendable Spark Plug Boot	10006
1976-1975	8 Cyl. 5.0L; 8.5mm High Performance Wire; Equipped with Ceramic Spark Plug Boots	10114
1976-1975	8 Cyl. 5.0L; 8.5mm High Performance Wire; w/ Straight Bendable Spark Plug Boot	10116
1974-1973	8 Cyl. 5.0L; 8.5mm High Performance Wire	10008
1974-1973	8 Cyl. 5.0L; 8.5mm High Performance Wire; Equipped with Ceramic Spark Plug Boots	10059
1972	8 Cyl. 5.0L; 8.5mm High Performance Wire; w/ Straight Non-Bendable Spark Plug Boot	10006
1972	8 Cyl. 5.0L; 8.5mm High Performance Wire; Equipped with Ceramic Spark Plug Boots	10114
1972	8 Cyl. 5.0L; 8.5mm High Performance Wire; w/ Straight Bendable Spark Plug Boot	10116
Hornet		
1977-1975	8 Cyl. 5.0L; 8.5mm High Performance Wire; Equipped with Ceramic Spark Plug Boots	10114
1977-1975	8 Cyl. 5.0L; 8.5mm High Performance Wire; w/ Straight Non-Bendable Spark Plug Boot	10006
1977-1975	8 Cyl. 5.0L; 8.5mm High Performance Wire; w/ Straight Bendable Spark Plug Boot	10116
1974-1973	8 Cyl. 5.0L; 8.5mm High Performance Wire	10008
1974-1973	8 Cyl. 5.9L; 8.5mm High Performance Wire	10008
1974-1973	8 Cyl. 5.9L; 8.5mm High Performance Wire; Equipped with Ceramic Spark Plug Boots	10059
1974-1973	8 Cyl. 5.0L; 8.5mm High Performance Wire; Equipped with Ceramic Spark Plug Boots	10059
1972-1971	8 Cyl. 5.9L; 8.5mm High Performance Wire; w/ Straight Non-Bendable Spark Plug Boot	10006

American Motors

Wire Sets

Year	Model/Engine	Part No.
Spark Plug Wire Set		
Hornet		
1972-1971	8 Cyl. 5.9L; 8.5mm High Performance Wire; Equipped with Ceramic Spark Plug Boots	10114
1972-1971	8 Cyl. 5.9L; 8.5mm High Performance Wire; w/ Straight Bendable Spark Plug Boot	10116
1972-1970	8 Cyl. 5.0L; 8.5mm High Performance Wire; Equipped with Ceramic Spark Plug Boots	10114
1972-1970	8 Cyl. 5.0L; 8.5mm High Performance Wire; w/ Straight Non-Bendable Spark Plug Boot	10006
1972-1970	8 Cyl. 5.0L; 8.5mm High Performance Wire; w/ Straight Bendable Spark Plug Boot	10116
Javelin		
1974-1973	8 Cyl. 6.6L; 8.5mm High Performance Wire	10008
1974-1973	8 Cyl. 5.9L; 8.5mm High Performance Wire	10008
1974-1973	8 Cyl. 5.9L; 8.5mm High Performance Wire; Equipped with Ceramic Spark Plug Boots	10059
1974-1973	8 Cyl. 5.0L; 8.5mm High Performance Wire	10008
1974-1973	8 Cyl. 5.0L; 8.5mm High Performance Wire; Equipped with Ceramic Spark Plug Boots	10059
1974-1973	8 Cyl. 6.6L; 8.5mm High Performance Wire; Equipped with Ceramic Spark Plug Boots	10059
1972-1971	8 Cyl. 6.6L; 8.5mm High Performance Wire; w/ Straight Non-Bendable Spark Plug Boot	10006
1972-1971	8 Cyl. 6.6L; 8.5mm High Performance Wire; Equipped with Ceramic Spark Plug Boots	10114
1972-1971	8 Cyl. 6.6L; 8.5mm High Performance Wire; w/ Straight Bendable Spark Plug Boot	10116
1972-1970	8 Cyl. 5.9L; 8.5mm High Performance Wire; w/ Straight Non-Bendable Spark Plug Boot	10006
1972-1970	8 Cyl. 5.9L; 8.5mm High Performance Wire; Equipped with Ceramic Spark Plug Boots	10114
1972-1970	8 Cyl. 5.0L; 8.5mm High Performance Wire; Equipped with Ceramic Spark Plug Boots	10114
1972-1970	8 Cyl. 5.0L; 8.5mm High Performance Wire; w/ Straight Non-Bendable Spark Plug Boot	10006
1972-1970	8 Cyl. 5.0L; 8.5mm High Performance Wire; w/ Straight Bendable Spark Plug Boot	10116
1972-1970	8 Cyl. 5.9L; 8.5mm High Performance Wire; w/ Straight Bendable Spark Plug Boot	10116
1970-1968	8 Cyl. 6.4L; 8.5mm High Performance Wire; Equipped with Ceramic Spark Plug Boots	10114
1970-1968	8 Cyl. 6.4L; 8.5mm High Performance Wire; w/ Straight Non-Bendable Spark Plug Boot	10006
1970-1968	8 Cyl. 6.4L; 8.5mm High Performance Wire; w/ Straight Bendable Spark Plug Boot	10116
1969-1968	8 Cyl. 5.6L; 8.5mm High Performance Wire; w/ Straight Non-Bendable Spark Plug Boot	10006

Year	Model/Engine	Part No.
Spark Plug Wire Set		
Javelin		
1969-1968	8 Cyl.; 290; 8.5mm High Performance Wire; w/ Straight Non-Bendable Spark Plug Boot	10006
1969-1968	8 Cyl.; 290; 8.5mm High Performance Wire; Equipped with Ceramic Spark Plug Boots	10114
1969-1968	8 Cyl. 5.6L; 8.5mm High Performance Wire; Equipped with Ceramic Spark Plug Boots	10114
1969-1968	8 Cyl.; 290; 8.5mm High Performance Wire; w/ Straight Bendable Spark Plug Boot	10116
1969-1968	8 Cyl. 5.6L; 8.5mm High Performance Wire; w/ Straight Bendable Spark Plug Boot	10116
Marlin		
1966-1965	8 Cyl.; 287; 8.5mm High Performance Wire	10008
1966-1965	8 Cyl.; 327; 8.5mm High Performance Wire	10008
1966-1965	8 Cyl.; 287; 8.5mm High Performance Wire; Equipped with Ceramic Spark Plug Boots	10059
1966-1965	8 Cyl.; 327; 8.5mm High Performance Wire; Equipped with Ceramic Spark Plug Boots	10059
Matador		
1978-1975	8 Cyl. 5.9L; 8.5mm High Performance Wire; w/ Straight Non-Bendable Spark Plug Boot	10006
1978-1975	8 Cyl. 5.9L; 8.5mm High Performance Wire; Equipped with Ceramic Spark Plug Boots	10114
1978-1975	8 Cyl. 5.9L; 8.5mm High Performance Wire; w/ Straight Bendable Spark Plug Boot	10116
1977-1975	8 Cyl. 5.0L; 8.5mm High Performance Wire; Equipped with Ceramic Spark Plug Boots	10114
1977-1975	8 Cyl. 5.0L; 8.5mm High Performance Wire; w/ Straight Non-Bendable Spark Plug Boot	10006
1977-1975	8 Cyl. 5.0L; 8.5mm High Performance Wire; w/ Straight Bendable Spark Plug Boot	10116
1976-1975	8 Cyl. 6.6L; 8.5mm High Performance Wire; Equipped with Ceramic Spark Plug Boots	10114
1976-1975	8 Cyl. 6.6L; 8.5mm High Performance Wire; w/ Straight Non-Bendable Spark Plug Boot	10006
1976-1975	8 Cyl. 6.6L; 8.5mm High Performance Wire; w/ Straight Bendable Spark Plug Boot	10116
1974-1973	8 Cyl. 6.6L; 8.5mm High Performance Wire	10008
1974-1973	8 Cyl. 5.9L; 8.5mm High Performance Wire; Equipped with Ceramic Spark Plug Boots	10059
1974-1973	8 Cyl. 5.9L; 8.5mm High Performance Wire	10008
1974-1973	8 Cyl. 5.0L; 8.5mm High Performance Wire	10008
1974-1973	8 Cyl. 5.0L; 8.5mm High Performance Wire; Equipped with Ceramic Spark Plug Boots	10059
1974-1973	8 Cyl. 6.6L; 8.5mm High Performance Wire; Equipped with Ceramic Spark Plug Boots	10059

Wire Sets

Year	Model/Engine	Part No.
Spark Plug Wire Set		
Matador		
1972-1971	8 Cyl. 5.0L; 8.5mm High Performance Wire; Equipped with Ceramic Spark Plug Boots	10114
1972-1971	8 Cyl. 5.9L; 8.5mm High Performance Wire; w/ Straight Non-Bendable Spark Plug Boot	10006
1972-1971	8 Cyl. 6.6L; 8.5mm High Performance Wire; Equipped with Ceramic Spark Plug Boots	10114
1972-1971	8 Cyl. 5.0L; 8.5mm High Performance Wire; w/ Straight Non-Bendable Spark Plug Boot	10006
1972-1971	8 Cyl. 5.9L; 8.5mm High Performance Wire; Equipped with Ceramic Spark Plug Boots	10114
1972-1971	8 Cyl. 6.6L; 8.5mm High Performance Wire; w/ Straight Non-Bendable Spark Plug Boot	10006
1972-1971	8 Cyl. 5.0L; 8.5mm High Performance Wire; w/ Straight Bendable Spark Plug Boot	10116
1972-1971	8 Cyl. 5.9L; 8.5mm High Performance Wire; w/ Straight Bendable Spark Plug Boot	10116
1972-1971	8 Cyl. 6.6L; 8.5mm High Performance Wire; w/ Straight Bendable Spark Plug Boot	10116
Rambler		
1969	8 Cyl.; 290; 8.5mm High Performance Wire; w/ Straight Non-Bendable Spark Plug Boot	10006
1969	8 Cyl. 6.4L; 8.5mm High Performance Wire; w/ Straight Non-Bendable Spark Plug Boot	10006
1969	8 Cyl. 6.4L; 8.5mm High Performance Wire; Equipped with Ceramic Spark Plug Boots	10114
1969	8 Cyl.; 290; 8.5mm High Performance Wire; Equipped with Ceramic Spark Plug Boots	10114
1969	8 Cyl.; 290; 8.5mm High Performance Wire; w/ Straight Bendable Spark Plug Boot	10116
1969	8 Cyl. 6.4L; 8.5mm High Performance Wire; w/ Straight Bendable Spark Plug Boot	10116
Rebel		
1970	8 Cyl. 5.9L; 8.5mm High Performance Wire; w/ Straight Non-Bendable Spark Plug Boot	10006
1970	8 Cyl. 5.0L; 8.5mm High Performance Wire; w/ Straight Non-Bendable Spark Plug Boot	10006
1970	8 Cyl. 5.9L; 8.5mm High Performance Wire; Equipped with Ceramic Spark Plug Boots	10114
1970	8 Cyl. 5.0L; 8.5mm High Performance Wire; Equipped with Ceramic Spark Plug Boots	10114
1970	8 Cyl. 5.0L; 8.5mm High Performance Wire; w/ Straight Bendable Spark Plug Boot	10116
1970	8 Cyl. 5.9L; 8.5mm High Performance Wire; w/ Straight Bendable Spark Plug Boot	10116
1970-1968	8 Cyl. 6.4L; 8.5mm High Performance Wire; w/ Straight Non-Bendable Spark Plug Boot	10006
1970-1968	8 Cyl. 6.4L; 8.5mm High Performance Wire; Equipped with Ceramic Spark Plug Boots	10114

Year	Model/Engine	Part No.
Spark Plug Wire Set		
Rebel		
1970-1968	8 Cyl. 6.4L; 8.5mm High Performance Wire; w/ Straight Bendable Spark Plug Boot	10116
1969	8 Cyl. 5.1L; 8.5mm High Performance Wire; Equipped with Ceramic Spark Plug Boots	10114
1969	8 Cyl. 5.1L; 8.5mm High Performance Wire; w/ Straight Non-Bendable Spark Plug Boot	10006
1969	8 Cyl. 4.8L; 8.5mm High Performance Wire; w/ Straight Non-Bendable Spark Plug Boot	10006
1969	8 Cyl. 4.8L; 8.5mm High Performance Wire; Equipped with Ceramic Spark Plug Boots	10114
1969	8 Cyl. 4.8L; 8.5mm High Performance Wire; w/ Straight Bendable Spark Plug Boot	10116
1969	8 Cyl. 5.1L; 8.5mm High Performance Wire; w/ Straight Bendable Spark Plug Boot	10116
1969-1968	8 Cyl. 5.6L; 8.5mm High Performance Wire; Equipped with Ceramic Spark Plug Boots	10114
1969-1968	8 Cyl. 5.6L; 8.5mm High Performance Wire; w/ Straight Non-Bendable Spark Plug Boot	10006
1969-1968	8 Cyl. 5.6L; 8.5mm High Performance Wire; w/ Straight Bendable Spark Plug Boot	10116
1968	8 Cyl.; 290; 8.5mm High Performance Wire; Equipped with Ceramic Spark Plug Boots	10114
1968	8 Cyl.; 290; 8.5mm High Performance Wire; w/ Straight Non-Bendable Spark Plug Boot	10006
1968	8 Cyl.; 290; 8.5mm High Performance Wire; w/ Straight Bendable Spark Plug Boot	10116
1961-1960	8 Cyl. 4.1L; 8.5mm High Performance Wire	10008
1961-1960	8 Cyl. 4.1L; 8.5mm High Performance Wire; Equipped with Ceramic Spark Plug Boots	10059
Buick		
Wire Sets		
Spark Plug Wire Set		
Allure		
2009	8 Cyl. 5.3L; 8.5mm High Performance Wire	10026
2009	8 Cyl. 5.3L; 9.0mm High Performance Wire	10039
2008	8 Cyl. 5.3L; 9.0mm High Performance Wire	10042
2008	8 Cyl. 5.3L; 8.5mm High Performance Wire	10041
Apollo		
1974-1973	8 Cyl. 5.7L; 8.5mm High Performance Wire; Equipped with Ceramic Spark Plug Boots; Exc. High Energy Ignition	10114
1974-1973	8 Cyl. 5.7L; 8.5mm High Performance Wire; Exc. High Energy Ignition; w/ Straight Non-Bendable Spark Plug Boot	10006
1974-1973	8 Cyl. 5.7L; 8.5mm High Performance Wire; Exc. High Energy Ignition; w/ Straight Bendable Spark Plug Boot	10116

Wire Sets

Year	Model/Engine	Part No.
Spark Plug Wire Set		
Century		
1986-1984	6 Cyl. 2.8L; 8.5mm High Performance Wire; Equipped with Ceramic Spark Plug Boots	10058
1986-1984	6 Cyl. 2.8L; 8.5mm High Performance Wire	10057
1981	8 Cyl. 4.4L; 8.5mm High Performance Wire; Equipped with Ceramic Spark Plug Boots	10056
1981	8 Cyl. 4.4L; 8.5mm High Performance Wire	10010
1981	8 Cyl. 4.4L; 9.0mm High Performance Wire	10037
1981-1979	8 Cyl. 5.0L; 8.5mm High Performance Wire	10010
1981-1979	8 Cyl. 5.0L; 9.0mm High Performance Wire	10037
1981-1979	8 Cyl. 5.0L; 8.5mm High Performance Wire; Equipped with Ceramic Spark Plug Boots	10056
1979	8 Cyl. 5.7L; 9.0mm High Performance Wire	10037
1979	8 Cyl. 5.7L; 8.5mm High Performance Wire	10010
1979	8 Cyl. 5.7L; 8.5mm High Performance Wire; Equipped with Ceramic Spark Plug Boots	10056
1978	8 Cyl. 5.0L; H; 8.5mm High Performance Wire	10010
1978	8 Cyl. 5.0L; H; 8.5mm High Performance Wire; Equipped with Ceramic Spark Plug Boots	10056
1978	8 Cyl. 5.0L; H; 9.0mm High Performance Wire	10037
1978	8 Cyl. 5.7L; L; 8.5mm High Performance Wire	10010
1978	8 Cyl. 5.7L; L; 8.5mm High Performance Wire; Equipped with Ceramic Spark Plug Boots	10056
1978	8 Cyl. 5.7L; L; 9.0mm High Performance Wire	10037
1978	8 Cyl. 5.0L; U; 8.5mm High Performance Wire; Equipped with Ceramic Spark Plug Boots	10056
1978	8 Cyl. 5.0L; U; 8.5mm High Performance Wire	10010
1978	8 Cyl. 5.0L; U; 9.0mm High Performance Wire	10037
1977	8 Cyl. 5.0L; 8.5mm High Performance Wire; Equipped with Ceramic Spark Plug Boots	10053
1977	8 Cyl. 5.0L; 9.0mm High Performance Wire	10034
1977	8 Cyl. 5.0L; 8.5mm High Performance Wire	10002
1977	8 Cyl. 5.7L; L; 8.5mm High Performance Wire	10002
1977	8 Cyl. 5.7L; L; 9.0mm High Performance Wire	10034
1977	8 Cyl. 5.7L; L; 8.5mm High Performance Wire; Equipped with Ceramic Spark Plug Boots	10053
1974-1973	8 Cyl. 5.7L; 8.5mm High Performance Wire; Equipped with Ceramic Spark Plug Boots; Exc. High Energy Ignition	10114
1974-1973	8 Cyl. 5.7L; 8.5mm High Performance Wire; Exc. High Energy Ignition; w/ Straight Non-Bendable Spark Plug Boot	10006
1974-1973	8 Cyl. 5.7L; 8.5mm High Performance Wire; Exc. High Energy Ignition; w/ Straight Bendable Spark Plug Boot	10116

Year	Model/Engine	Part No.
Spark Plug Wire Set		
Century		
1973	8 Cyl. 7.5L; 8.5mm High Performance Wire; w/ Straight Non-Bendable Spark Plug Boot	10006
1973	8 Cyl. 7.5L; 8.5mm High Performance Wire; Equipped with Ceramic Spark Plug Boots	10114
1973	8 Cyl. 7.5L; 8.5mm High Performance Wire; w/ Straight Bendable Spark Plug Boot	10116
1958-1957	8 Cyl. 6.0L; 8.5mm High Performance Wire; w/ Straight Non-Bendable Spark Plug Boot	10009
1958-1957	8 Cyl. 6.0L; 8.5mm High Performance Wire; Equipped with Ceramic Spark Plug Boots	10052
1958-1957	8 Cyl. 6.0L; 8.5mm High Performance Wire; w/ Straight Bendable Spark Plug Boot	10117
Estate Wagon		
1974-1973	8 Cyl. 7.5L; 8.5mm High Performance Wire; Exc. High Energy Ignition; w/ Straight Non-Bendable Spark Plug Boot	10006
1974-1973	8 Cyl. 7.5L; 8.5mm High Performance Wire; Equipped with Ceramic Spark Plug Boots; Exc. High Energy Ignition	10114
1974-1973	8 Cyl. 7.5L; 8.5mm High Performance Wire; Exc. High Energy Ignition; w/ Straight Bendable Spark Plug Boot	10116
1973	8 Cyl. 5.7L; 8.5mm High Performance Wire; Equipped with Ceramic Spark Plug Boots; Exc. High Energy Ignition	10114
1973	8 Cyl. 5.7L; 8.5mm High Performance Wire; Exc. High Energy Ignition; w/ Straight Non-Bendable Spark Plug Boot	10006
1973	8 Cyl. 5.7L; 8.5mm High Performance Wire; Exc. High Energy Ignition; w/ Straight Bendable Spark Plug Boot	10116
1972	8 Cyl. 5.7L; 8.5mm High Performance Wire; Equipped with Ceramic Spark Plug Boots	10114
1972	8 Cyl. 5.7L; 8.5mm High Performance Wire; w/ Straight Non-Bendable Spark Plug Boot	10006
1972	8 Cyl. 5.7L; 8.5mm High Performance Wire; w/ Straight Bendable Spark Plug Boot	10116
1972-1970	8 Cyl. 7.5L; 8.5mm High Performance Wire; Equipped with Ceramic Spark Plug Boots	10114
1972-1970	8 Cyl. 7.5L; 8.5mm High Performance Wire; w/ Straight Non-Bendable Spark Plug Boot	10006
1972-1970	8 Cyl. 7.5L; 8.5mm High Performance Wire; w/ Straight Bendable Spark Plug Boot	10116
1970	8 Cyl. 5.7L; 8.5mm High Performance Wire; Equipped with Ceramic Spark Plug Boots	10114
1970	8 Cyl. 5.7L; 8.5mm High Performance Wire; w/ Straight Non-Bendable Spark Plug Boot	10006
1970	8 Cyl. 5.7L; 8.5mm High Performance Wire; w/ Straight Bendable Spark Plug Boot	10116
Gran Sport		
1967	8 Cyl. 5.6L; 8.5mm High Performance Wire; Equipped with Ceramic Spark Plug Boots	10059
1967	8 Cyl. 6.6L; 8.5mm High Performance Wire; Equipped with Ceramic Spark Plug Boots	10114

Wire Sets

Year	Model/Engine	Part No.
Spark Plug Wire Set		
Gran Sport		
1967	8 Cyl. 5.6L; 8.5mm High Performance Wire	10008
1967	8 Cyl. 6.6L; 8.5mm High Performance Wire; w/ Straight Non-Bendable Spark Plug Boot	10006
1967	8 Cyl. 6.6L; 8.5mm High Performance Wire; w/ Straight Bendable Spark Plug Boot	10116
1966-1965	8 Cyl. 6.6L; 8.5mm High Performance Wire; w/ Straight Non-Bendable Spark Plug Boot	10009
1966-1965	8 Cyl. 6.6L; 8.5mm High Performance Wire; Equipped with Ceramic Spark Plug Boots	10052
1966-1965	8 Cyl. 6.6L; 8.5mm High Performance Wire; w/ Straight Bendable Spark Plug Boot	10117
GS		
1972-1970	8 Cyl. 5.7L; 8.5mm High Performance Wire; w/ Straight Non-Bendable Spark Plug Boot	10006
1972-1970	8 Cyl. 5.7L; 8.5mm High Performance Wire; Equipped with Ceramic Spark Plug Boots	10114
1972-1970	8 Cyl. 5.7L; 8.5mm High Performance Wire; w/ Straight Bendable Spark Plug Boot	10116
GS 350		
1969-1968	8 Cyl. 5.7L; 8.5mm High Performance Wire; w/ Straight Non-Bendable Spark Plug Boot	10006
1969-1968	8 Cyl. 5.7L; 8.5mm High Performance Wire; Equipped with Ceramic Spark Plug Boots	10114
1969-1968	8 Cyl. 5.7L; 8.5mm High Performance Wire; w/ Straight Bendable Spark Plug Boot	10116
GS 400		
1969-1968	8 Cyl. 6.6L; 8.5mm High Performance Wire; Equipped with Ceramic Spark Plug Boots	10114
1969-1968	8 Cyl. 6.6L; 8.5mm High Performance Wire; w/ Straight Non-Bendable Spark Plug Boot	10006
1969-1968	8 Cyl. 6.6L; 8.5mm High Performance Wire; w/ Straight Bendable Spark Plug Boot	10116
GS 455		
1972-1970	8 Cyl. 7.5L; 8.5mm High Performance Wire; Equipped with Ceramic Spark Plug Boots	10114
1972-1970	8 Cyl. 7.5L; 8.5mm High Performance Wire; w/ Straight Non-Bendable Spark Plug Boot	10006
1972-1970	8 Cyl. 7.5L; 8.5mm High Performance Wire; w/ Straight Bendable Spark Plug Boot	10116
Invicta		
1963-1959	8 Cyl. 6.6L; 8.5mm High Performance Wire; Equipped with Ceramic Spark Plug Boots	10052
1963-1959	8 Cyl. 6.6L; 8.5mm High Performance Wire; w/ Straight Non-Bendable Spark Plug Boot	10009
1963-1959	8 Cyl. 6.6L; 8.5mm High Performance Wire; w/ Straight Bendable Spark Plug Boot	10117
LaCrosse		
2009	8 Cyl. 5.3L; 8.5mm High Performance Wire	10026

Year	Model/Engine	Part No.
Spark Plug Wire Set		
LaCrosse		
2009	8 Cyl. 5.3L; 9.0mm High Performance Wire	10039
2008	8 Cyl. 5.3L; 9.0mm High Performance Wire	10042
2008	8 Cyl. 5.3L; 8.5mm High Performance Wire	10041
Limited		
1958	8 Cyl. 6.0L; 8.5mm High Performance Wire; w/ Straight Non-Bendable Spark Plug Boot	10009
1958	8 Cyl. 6.0L; 8.5mm High Performance Wire; Equipped with Ceramic Spark Plug Boots	10052
1958	8 Cyl. 6.0L; 8.5mm High Performance Wire; w/ Straight Bendable Spark Plug Boot	10117
Rainier		
2007-2004	8 Cyl. 5.3L; 9.0mm High Performance Wire	10042
2007-2004	8 Cyl. 5.3L; 8.5mm High Performance Wire	10041
Regal		
1987-1984	6 Cyl. 3.8L; Grand National; 8.5mm High Performance Wire	10023
1986	8 Cyl. 5.0L; 9.0mm High Performance Wire	10037
1986	8 Cyl. 5.0L; 8.5mm High Performance Wire	10010
1986	8 Cyl. 5.0L; 8.5mm High Performance Wire; Equipped with Ceramic Spark Plug Boots	10056
1985	8 Cyl. 5.0L; 9.0mm High Performance Wire; Canada; Export	10037
1985	8 Cyl. 5.0L; 8.5mm High Performance Wire; Canada; Equipped with Ceramic Spark Plug Boots; Export	10056
1985	8 Cyl. 5.0L; 8.5mm High Performance Wire; Canada; Export	10010
1984-1982	8 Cyl. 5.0L; 9.0mm High Performance Wire	10037
1984-1982	8 Cyl. 5.0L; 8.5mm High Performance Wire	10010
1984-1982	8 Cyl. 5.0L; 8.5mm High Performance Wire; Equipped with Ceramic Spark Plug Boots	10056
1982-1981	8 Cyl. 4.4L; 8.5mm High Performance Wire; Equipped with Ceramic Spark Plug Boots	10056
1982-1981	8 Cyl. 4.4L; 8.5mm High Performance Wire	10010
1982-1981	8 Cyl. 4.4L; 9.0mm High Performance Wire	10037
1980-1979	8 Cyl. 5.0L; 9.0mm High Performance Wire	10037
1980-1979	8 Cyl. 5.0L; 8.5mm High Performance Wire	10010
1980-1979	8 Cyl. 5.0L; 8.5mm High Performance Wire; Equipped with Ceramic Spark Plug Boots	10056
1978	8 Cyl. 5.0L; H; 9.0mm High Performance Wire	10037
1978	8 Cyl. 5.0L; H; 8.5mm High Performance Wire	10010
1978	8 Cyl. 5.0L; H; 8.5mm High Performance Wire; Equipped with Ceramic Spark Plug Boots	10056
1978	8 Cyl. 5.0L; U; 8.5mm High Performance Wire	10010

Wire Sets

Year	Model/Engine	Part No.
Spark Plug Wire Set		
Regal		
1978	8 Cyl. 5.0L; U; 8.5mm High Performance Wire; Equipped with Ceramic Spark Plug Boots	10056
1978	8 Cyl. 5.0L; U; 9.0mm High Performance Wire	10037
1977	8 Cyl. 5.0L; 9.0mm High Performance Wire	10034
1977	8 Cyl. 5.0L; 8.5mm High Performance Wire	10002
1977	8 Cyl. 5.0L; 8.5mm High Performance Wire; Equipped with Ceramic Spark Plug Boots	10053
1977	8 Cyl. 5.7L; L; 8.5mm High Performance Wire	10002
1977	8 Cyl. 5.7L; L; 8.5mm High Performance Wire; Equipped with Ceramic Spark Plug Boots	10053
1977	8 Cyl. 5.7L; L; 9.0mm High Performance Wire	10034
1974-1973	8 Cyl. 5.7L; 8.5mm High Performance Wire; Equipped with Ceramic Spark Plug Boots; Exc. High Energy Ignition	10114
1974-1973	8 Cyl. 5.7L; 8.5mm High Performance Wire; Exc. High Energy Ignition; w/ Straight Non-Bendable Spark Plug Boot	10006
1974-1973	8 Cyl. 5.7L; 8.5mm High Performance Wire; Exc. High Energy Ignition; w/ Straight Bendable Spark Plug Boot	10116
1973	8 Cyl. 7.5L; 8.5mm High Performance Wire; Equipped with Ceramic Spark Plug Boots	10114
1973	8 Cyl. 7.5L; 8.5mm High Performance Wire; w/ Straight Non-Bendable Spark Plug Boot	10006
1973	8 Cyl. 7.5L; 8.5mm High Performance Wire; w/ Straight Bendable Spark Plug Boot	10116
Riviera		
1974-1970	8 Cyl. 7.5L; 8.5mm High Performance Wire; w/ Straight Non-Bendable Spark Plug Boot	10006
1974-1970	8 Cyl. 7.5L; 8.5mm High Performance Wire; Equipped with Ceramic Spark Plug Boots	10114
1974-1970	8 Cyl. 7.5L; 8.5mm High Performance Wire; w/ Straight Bendable Spark Plug Boot	10116
1969-1968	8 Cyl. 7.0L; 8.5mm High Performance Wire; w/ Straight Non-Bendable Spark Plug Boot	10006
1969-1968	8 Cyl. 7.0L; 8.5mm High Performance Wire; Equipped with Ceramic Spark Plug Boots	10114
1969-1968	8 Cyl. 7.0L; 8.5mm High Performance Wire; w/ Straight Bendable Spark Plug Boot	10116
1967	8 Cyl. 7.0L; 8.5mm High Performance Wire; w/ Straight Non-Bendable Spark Plug Boot	10006
1967	8 Cyl. 7.0L; 8.5mm High Performance Wire; Equipped with Ceramic Spark Plug Boots	10114
1967	8 Cyl. 7.0L; 8.5mm High Performance Wire; w/ Straight Bendable Spark Plug Boot	10116
1966-1963	8 Cyl. 7.0L; 8.5mm High Performance Wire; Equipped with Ceramic Spark Plug Boots	10052
1966-1963	8 Cyl. 7.0L; 8.5mm High Performance Wire; w/ Straight Non-Bendable Spark Plug Boot	10009

Year	Model/Engine	Part No.
Spark Plug Wire Set		
Riviera		
1966-1963	8 Cyl. 7.0L; 8.5mm High Performance Wire; w/ Straight Bendable Spark Plug Boot	10117
1965-1963	8 Cyl. 6.6L; 8.5mm High Performance Wire; w/ Straight Non-Bendable Spark Plug Boot	10009
1965-1963	8 Cyl. 6.6L; 8.5mm High Performance Wire; Equipped with Ceramic Spark Plug Boots	10052
1965-1963	8 Cyl. 6.6L; 8.5mm High Performance Wire; w/ Straight Bendable Spark Plug Boot	10117
Roadmaster		
1996-1994	8 Cyl. 5.7L; 8.5mm High Performance Wire	10017
1958-1957	8 Cyl. 6.0L; 8.5mm High Performance Wire; w/ Straight Non-Bendable Spark Plug Boot	10009
1958-1957	8 Cyl. 6.0L; 8.5mm High Performance Wire; Equipped with Ceramic Spark Plug Boots	10052
1958-1957	8 Cyl. 6.0L; 8.5mm High Performance Wire; w/ Straight Bendable Spark Plug Boot	10117
Skylark		
1985-1984	6 Cyl. 2.8L; 8.5mm High Performance Wire; Equipped with Ceramic Spark Plug Boots	10058
1985-1984	6 Cyl. 2.8L; 8.5mm High Performance Wire	10057
1979-1978	8 Cyl. 5.7L; 9.0mm High Performance Wire	10034
1979-1978	8 Cyl. 5.7L; 8.5mm High Performance Wire	10002
1979-1978	8 Cyl. 5.7L; 8.5mm High Performance Wire; Equipped with Ceramic Spark Plug Boots	10053
1979-1977	8 Cyl. 5.0L; 8.5mm High Performance Wire; Equipped with Ceramic Spark Plug Boots	10053
1979-1977	8 Cyl. 5.0L; 8.5mm High Performance Wire	10002
1979-1977	8 Cyl. 5.0L; 9.0mm High Performance Wire	10034
1977	8 Cyl. 5.7L; L; 9.0mm High Performance Wire	10034
1977	8 Cyl. 5.7L; L; 8.5mm High Performance Wire	10002
1977	8 Cyl. 5.7L; L; 8.5mm High Performance Wire; Equipped with Ceramic Spark Plug Boots	10053
1972-1970	8 Cyl. 7.5L; 8.5mm High Performance Wire; Equipped with Ceramic Spark Plug Boots	10114
1972-1970	8 Cyl. 7.5L; 8.5mm High Performance Wire; w/ Straight Non-Bendable Spark Plug Boot	10006
1972-1970	8 Cyl. 7.5L; 8.5mm High Performance Wire; w/ Straight Bendable Spark Plug Boot	10116
1972-1968	8 Cyl. 5.7L; 8.5mm High Performance Wire; Equipped with Ceramic Spark Plug Boots	10114
1972-1968	8 Cyl. 5.7L; 8.5mm High Performance Wire; w/ Straight Non-Bendable Spark Plug Boot	10006
1972-1968	8 Cyl. 5.7L; 8.5mm High Performance Wire; w/ Straight Bendable Spark Plug Boot	10116

Wire Sets

Year	Model/Engine	Part No.
Spark Plug Wire Set		
Skylark		
1969-1968	8 Cyl. 6.6L; 8.5mm High Performance Wire; Equipped with Ceramic Spark Plug Boots	10114
1969-1968	8 Cyl. 6.6L; 8.5mm High Performance Wire; w/ Straight Non-Bendable Spark Plug Boot	10006
1969-1968	8 Cyl. 6.6L; 8.5mm High Performance Wire; w/ Straight Bendable Spark Plug Boot	10116
1967	8 Cyl. 4.9L; 8.5mm High Performance Wire; Equipped with Ceramic Spark Plug Boots	10059
1967	8 Cyl. 5.6L; 8.5mm High Performance Wire; Equipped with Ceramic Spark Plug Boots	10059
1967	8 Cyl. 6.6L; 8.5mm High Performance Wire; Equipped with Ceramic Spark Plug Boots	10114
1967	8 Cyl. 4.9L; 8.5mm High Performance Wire	10008
1967	8 Cyl. 6.6L; 8.5mm High Performance Wire; w/ Straight Non-Bendable Spark Plug Boot	10006
1967	8 Cyl. 5.6L; 8.5mm High Performance Wire	10008
1967	8 Cyl. 6.6L; 8.5mm High Performance Wire; w/ Straight Bendable Spark Plug Boot	10116
1966	8 Cyl. 4.9L; 8.5mm High Performance Wire; Equipped with Ceramic Spark Plug Boots; Exc. Air Injection Reactor System	10114
1966	8 Cyl. 4.9L; 8.5mm High Performance Wire; Exc. Air Injection Reactor System; w/ Straight Non-Bendable Spark Plug Boot	10006
1966	8 Cyl. 5.6L; 8.5mm High Performance Wire; Exc. Air Injection Reactor System; w/ Straight Non-Bendable Spark Plug Boot	10006
1966	8 Cyl. 5.6L; 8.5mm High Performance Wire; Equipped with Ceramic Spark Plug Boots; Exc. Air Injection Reactor System	10114
1966	8 Cyl. 4.9L; 8.5mm High Performance Wire; Exc. Air Injection Reactor System; w/ Straight Bendable Spark Plug Boot	10116
1966	8 Cyl. 5.6L; 8.5mm High Performance Wire; Exc. Air Injection Reactor System; w/ Straight Bendable Spark Plug Boot	10116
1966-1965	8 Cyl. 6.6L; 8.5mm High Performance Wire; Equipped with Ceramic Spark Plug Boots	10052
1966-1965	8 Cyl. 6.6L; 8.5mm High Performance Wire; w/ Straight Non-Bendable Spark Plug Boot	10009
1966-1965	8 Cyl. 6.6L; 8.5mm High Performance Wire; w/ Straight Bendable Spark Plug Boot	10117
1965	8 Cyl. 4.9L; 8.5mm High Performance Wire; Equipped with Ceramic Spark Plug Boots	10059
1965	8 Cyl. 4.9L; 8.5mm High Performance Wire	10008
1964	8 Cyl. 4.9L; 8.5mm High Performance Wire; w/ Straight Non-Bendable Spark Plug Boot	10009
1964	8 Cyl. 4.9L; 8.5mm High Performance Wire; Equipped with Ceramic Spark Plug Boots	10052
1964	8 Cyl. 4.9L; 8.5mm High Performance Wire; w/ Straight Bendable Spark Plug Boot	10117

Year	Model/Engine	Part No.
Spark Plug Wire Set		
Skylark		
1963-1961	8 Cyl. 3.5L; 8.5mm High Performance Wire	10008
1963-1961	8 Cyl. 3.5L; 8.5mm High Performance Wire; Equipped with Ceramic Spark Plug Boots	10059
Special		
1969-1968	8 Cyl. 5.7L; 8.5mm High Performance Wire; Equipped with Ceramic Spark Plug Boots	10114
1969-1968	8 Cyl. 5.7L; 8.5mm High Performance Wire; w/ Straight Non-Bendable Spark Plug Boot	10006
1969-1968	8 Cyl. 5.7L; 8.5mm High Performance Wire; w/ Straight Bendable Spark Plug Boot	10116
1967	8 Cyl. 4.9L; 8.5mm High Performance Wire; Equipped with Ceramic Spark Plug Boots	10059
1967	8 Cyl. 4.9L; 8.5mm High Performance Wire	10008
1966	8 Cyl. 4.9L; 8.5mm High Performance Wire; Equipped with Ceramic Spark Plug Boots; w/o Air Injection Reactor	10114
1966	8 Cyl. 4.9L; 8.5mm High Performance Wire; Exc. Air Injection Reactor System; w/ Straight Non-Bendable Spark Plug Boot	10006
1966	8 Cyl. 4.9L; 8.5mm High Performance Wire; Exc. Air Injection Reactor System; w/ Straight Bendable Spark Plug Boot	10116
1965	8 Cyl. 4.9L; 8.5mm High Performance Wire; Equipped with Ceramic Spark Plug Boots	10059
1965	8 Cyl. 4.9L; 8.5mm High Performance Wire	10008
1964	8 Cyl. 4.9L; 8.5mm High Performance Wire; Equipped with Ceramic Spark Plug Boots	10052
1964	8 Cyl. 4.9L; 8.5mm High Performance Wire; w/ Straight Non-Bendable Spark Plug Boot	10009
1964	8 Cyl. 4.9L; 8.5mm High Performance Wire; w/ Straight Bendable Spark Plug Boot	10117
1963-1961	8 Cyl. 3.5L; 8.5mm High Performance Wire	10008
1963-1961	8 Cyl. 3.5L; 8.5mm High Performance Wire; Equipped with Ceramic Spark Plug Boots	10059
1958-1957	8 Cyl. 6.0L; 8.5mm High Performance Wire; Equipped with Ceramic Spark Plug Boots	10052
1958-1957	8 Cyl. 6.0L; 8.5mm High Performance Wire; w/ Straight Non-Bendable Spark Plug Boot	10009
1958-1957	8 Cyl. 6.0L; 8.5mm High Performance Wire; w/ Straight Bendable Spark Plug Boot	10117
Sportwagon		
1972-1968	8 Cyl. 5.7L; 8.5mm High Performance Wire; w/ Straight Non-Bendable Spark Plug Boot	10006
1972-1968	8 Cyl. 5.7L; 8.5mm High Performance Wire; Equipped with Ceramic Spark Plug Boots	10114
1972-1968	8 Cyl. 5.7L; 8.5mm High Performance Wire; w/ Straight Bendable Spark Plug Boot	10116
1970	8 Cyl. 7.5L; 8.5mm High Performance Wire; Equipped with Ceramic Spark Plug Boots	10114

Wire Sets

Year	Model/Engine	Part No.
Spark Plug Wire Set		
Sportwagon		
1970	8 Cyl. 7.5L; 8.5mm High Performance Wire; w/ Straight Non-Bendable Spark Plug Boot	10006
1970	8 Cyl. 7.5L; 8.5mm High Performance Wire; w/ Straight Bendable Spark Plug Boot	10116
1968	8 Cyl. 6.6L; 8.5mm High Performance Wire; Equipped with Ceramic Spark Plug Boots	10114
1968	8 Cyl. 6.6L; 8.5mm High Performance Wire; w/ Straight Non-Bendable Spark Plug Boot	10006
1968	8 Cyl. 6.6L; 8.5mm High Performance Wire; w/ Straight Bendable Spark Plug Boot	10116
1967	8 Cyl. 5.6L; 8.5mm High Performance Wire; Equipped with Ceramic Spark Plug Boots	10059
1967	8 Cyl. 5.6L; 8.5mm High Performance Wire	10008
1966	8 Cyl. 5.6L; 8.5mm High Performance Wire; Equipped with Ceramic Spark Plug Boots; w/o Air Injection Reactor	10114
1966	8 Cyl. 5.6L; 8.5mm High Performance Wire; Exc. Air Injection Reactor System; w/ Straight Non-Bendable Spark Plug Boot	10006
1966	8 Cyl. 5.6L; 8.5mm High Performance Wire; Exc. Air Injection Reactor System; w/ Straight Bendable Spark Plug Boot	10116
1965	8 Cyl. 4.9L; 8.5mm High Performance Wire; Equipped with Ceramic Spark Plug Boots	10059
1965	8 Cyl. 4.9L; 8.5mm High Performance Wire	10008
1964	8 Cyl. 4.9L; 8.5mm High Performance Wire; Equipped with Ceramic Spark Plug Boots	10052
1964	8 Cyl. 4.9L; 8.5mm High Performance Wire; w/ Straight Non-Bendable Spark Plug Boot	10009
1964	8 Cyl. 4.9L; 8.5mm High Performance Wire; w/ Straight Bendable Spark Plug Boot	10117
Super		
1958-1957	8 Cyl. 6.0L; 8.5mm High Performance Wire; Equipped with Ceramic Spark Plug Boots	10052
1958-1957	8 Cyl. 6.0L; 8.5mm High Performance Wire; w/ Straight Non-Bendable Spark Plug Boot	10009
1958-1957	8 Cyl. 6.0L; 8.5mm High Performance Wire; w/ Straight Bendable Spark Plug Boot	10117
Wildcat		
1970	8 Cyl. 7.5L; 8.5mm High Performance Wire; Equipped with Ceramic Spark Plug Boots	10114
1970	8 Cyl. 7.5L; 8.5mm High Performance Wire; w/ Straight Non-Bendable Spark Plug Boot	10006
1970	8 Cyl. 7.5L; 8.5mm High Performance Wire; w/ Straight Bendable Spark Plug Boot	10116
1969-1968	8 Cyl. 7.0L; 8.5mm High Performance Wire; Equipped with Ceramic Spark Plug Boots	10114
1969-1968	8 Cyl. 7.0L; 8.5mm High Performance Wire; w/ Straight Non-Bendable Spark Plug Boot	10006

Year	Model/Engine	Part No.
Spark Plug Wire Set		
Wildcat		
1969-1968	8 Cyl. 7.0L; 8.5mm High Performance Wire; w/ Straight Bendable Spark Plug Boot	10116
1967	8 Cyl. 7.0L; 8.5mm High Performance Wire; w/ Straight Non-Bendable Spark Plug Boot	10006
1967	8 Cyl. 7.0L; 8.5mm High Performance Wire; Equipped with Ceramic Spark Plug Boots	10114
1967	8 Cyl. 7.0L; 8.5mm High Performance Wire; w/ Straight Bendable Spark Plug Boot	10116
1966-1964	8 Cyl. 7.0L; 8.5mm High Performance Wire; w/ Straight Non-Bendable Spark Plug Boot	10009
1966-1964	8 Cyl. 7.0L; 8.5mm High Performance Wire; Equipped with Ceramic Spark Plug Boots	10052
1966-1964	8 Cyl. 7.0L; 8.5mm High Performance Wire; w/ Straight Bendable Spark Plug Boot	10117
1966-1963	8 Cyl. 6.6L; 8.5mm High Performance Wire; w/ Straight Non-Bendable Spark Plug Boot	10009
1966-1963	8 Cyl. 6.6L; 8.5mm High Performance Wire; Equipped with Ceramic Spark Plug Boots	10052
1966-1963	8 Cyl. 6.6L; 8.5mm High Performance Wire; w/ Straight Bendable Spark Plug Boot	10117
Cadillac		
Wire Sets		
Spark Plug Wire Set		
Cimarron		
1986-1985	6 Cyl. 2.8L; 8.5mm High Performance Wire; Equipped with Ceramic Spark Plug Boots	10058
1986-1985	6 Cyl. 2.8L; 8.5mm High Performance Wire	10057
CTS		
2014	8 Cyl. 6.2L; 9.0mm High Performance Wire	10039
2014	8 Cyl. 6.2L; 8.5mm High Performance Wire	10026
2013	8 Cyl. 6.2L; 8.5mm High Performance Wire	10026
2013	8 Cyl. 6.2L; 9.0mm High Performance Wire	10039
2012-2009	8 Cyl. 6.2L; 9.0mm High Performance Wire	10039
2012-2009	8 Cyl. 6.2L; 8.5mm High Performance Wire	10026
2005-2004	8 Cyl. 5.7L; 8.5mm High Performance Wire	10026
2005-2004	8 Cyl. 5.7L; 9.0mm High Performance Wire	10039
Escalade		
2014-2009	8 Cyl. 6.2L; 8.5mm High Performance Wire	10026
2014-2009	8 Cyl. 6.2L; 9.0mm High Performance Wire	10039
2013-2009	8 Cyl. 6.0L; 8.5mm High Performance Wire	10026
2013-2009	8 Cyl. 6.0L; 9.0mm High Performance Wire	10039
2006-2002	8 Cyl. 6.0L; 9.0mm High Performance Wire; Round Coil	10039

Wire Sets

Year	Model/Engine	Part No.
Spark Plug Wire Set		
Escalade		
2006-2002	8 Cyl. 6.0L; 8.5mm High Performance Wire; Round Coil	10026
2006-2002	8 Cyl. 6.0L; 8.5mm High Performance Wire; Equipped with Ceramic Spark Plug Boots; Square Coil	10075
2006-2002	8 Cyl. 6.0L; 8.5mm High Performance Wire; Square Coil	10074
2005-2002	8 Cyl. 5.3L; 8.5mm High Performance Wire; Round Coil	10026
2005-2002	8 Cyl. 5.3L; 9.0mm High Performance Wire; Round Coil	10039
2005-2002	8 Cyl. 5.3L; 8.5mm High Performance Wire; Equipped with Ceramic Spark Plug Boots; Square Coil	10075
2005-2002	8 Cyl. 5.3L; 8.5mm High Performance Wire; Square Coil	10074
2000-1999	8 Cyl. 5.7L; 8.5mm High Performance Wire; Equipped with Ceramic Spark Plug Boots	10072
2000-1999	8 Cyl. 5.7L; 8.5mm High Performance Wire	10021
Escalade ESV		
2014-2009	8 Cyl. 6.2L; 8.5mm High Performance Wire	10026
2014-2009	8 Cyl. 6.2L; 9.0mm High Performance Wire	10039
2006-2003	8 Cyl. 6.0L; 8.5mm High Performance Wire; Round Coil	10026
2006-2003	8 Cyl. 6.0L; 8.5mm High Performance Wire; Equipped with Ceramic Spark Plug Boots; Square Coil	10075
2006-2003	8 Cyl. 6.0L; 9.0mm High Performance Wire; Round Coil	10039
2006-2003	8 Cyl. 6.0L; 8.5mm High Performance Wire; Square Coil	10074
Escalade EXT		
2013-2009	8 Cyl. 6.2L; 8.5mm High Performance Wire	10026
2013-2009	8 Cyl. 6.2L; 9.0mm High Performance Wire	10039
2006-2002	8 Cyl. 6.0L; 9.0mm High Performance Wire; Round Coil	10039
2006-2002	8 Cyl. 6.0L; 8.5mm High Performance Wire; Round Coil	10026
2006-2002	8 Cyl. 6.0L; 8.5mm High Performance Wire; Square Coil	10074
2006-2002	8 Cyl. 6.0L; 8.5mm High Performance Wire; Equipped with Ceramic Spark Plug Boots; Square Coil	10075
Chevrolet		
Wire Sets		
Spark Plug Wire Set		
Astro		
2005-1996	6 Cyl. 4.3L; 8.5mm High Performance Wire; Equipped with Ceramic Spark Plug Boots	10078
2005-1996	6 Cyl. 4.3L; 8.5mm High Performance Wire	10077
1995-1986	6 Cyl. 4.3L; 8.5mm High Performance Wire; Equipped with Ceramic Spark Plug Boots	10076
1995-1986	6 Cyl. 4.3L; 8.5mm High Performance Wire	10014
Avalanche		
2010-2009	8 Cyl. 5.3L; 9.0mm High Performance Wire	10039
2010-2009	8 Cyl. 5.3L; 8.5mm High Performance Wire	10026

Year	Model/Engine	Part No.
Spark Plug Wire Set		
Avalanche		
2009	8 Cyl. 6.0L; 9.0mm High Performance Wire	10039
2009	8 Cyl. 6.0L; 8.5mm High Performance Wire	10026
2008-2007	8 Cyl. 5.3L; 8.5mm High Performance Wire	10041
2008-2007	8 Cyl. 5.3L; 9.0mm High Performance Wire	10042
Avalanche 1500		
2006-2002	8 Cyl. 5.3L; 8.5mm High Performance Wire; Round Coil	10026
2006-2002	8 Cyl. 5.3L; 9.0mm High Performance Wire; Round Coil	10039
2006-2002	8 Cyl. 5.3L; 8.5mm High Performance Wire; Equipped with Ceramic Spark Plug Boots; Square Coil	10075
2006-2002	8 Cyl. 5.3L; 8.5mm High Performance Wire; Square Coil	10074
Bel Air		
1981	8 Cyl. 4.4L; 8.5mm High Performance Wire	10010
1981	8 Cyl. 5.0L; 9.0mm High Performance Wire; Canada; Export	10037
1981	8 Cyl. 5.0L; 8.5mm High Performance Wire; Canada; Equipped with Ceramic Spark Plug Boots; Export	10056
1981	8 Cyl. 4.4L; 8.5mm High Performance Wire; Equipped with Ceramic Spark Plug Boots	10056
1981	8 Cyl. 5.0L; 8.5mm High Performance Wire; Canada; Export	10010
1981	8 Cyl. 4.4L; 9.0mm High Performance Wire	10037
1975	8 Cyl. 6.6L; 9.0mm High Performance Wire	10034
1975	8 Cyl. 7.4L; 8.5mm High Performance Wire; Equipped with Ceramic Spark Plug Boots	10069
1975	8 Cyl. 5.7L; 9.0mm High Performance Wire	10034
1975	8 Cyl. 7.4L; 8.5mm High Performance Wire	10001
1975	8 Cyl. 6.6L; 8.5mm High Performance Wire	10002
1975	8 Cyl. 5.7L; 8.5mm High Performance Wire	10002
1975	8 Cyl. 5.7L; 8.5mm High Performance Wire; Equipped with Ceramic Spark Plug Boots	10053
1975	8 Cyl. 6.6L; 8.5mm High Performance Wire; Equipped with Ceramic Spark Plug Boots	10053
1974	8 Cyl. 5.7L; 8.5mm High Performance Wire; w/ High Energy Ignition	10002
1974	8 Cyl. 5.7L; 8.5mm High Performance Wire; Exc. High Energy Ignition; Routed Over Valve Cover	10007
1974	8 Cyl. 6.6L; 400; 8.5mm High Performance Wire; Equipped with Ceramic Spark Plug Boots; Exc. High Energy Ignition; Routed Over Valve Cover	10079
1974	8 Cyl. 6.6L; 400; 8.5mm High Performance Wire; Exc. High Energy Ignition; Routed Over Valve Cover	10007
1974	8 Cyl. 7.4L; 8.5mm High Performance Wire; Equipped with Ceramic Spark Plug Boots; w/ High Energy Ignition	10069

Wire Sets

Year	Model/Engine	Part No.
Spark Plug Wire Set		
Bel Air		
1974	8 Cyl. 5.7L; 8.5mm High Performance Wire; Equipped with Ceramic Spark Plug Boots; Exc. High Energy Ignition; Routed Over Valve Cover	10079
1974	8 Cyl. 6.6L; 8.5mm High Performance Wire; Equipped with Ceramic Spark Plug Boots; w/ High Energy Ignition	10053
1974	8 Cyl. 5.7L; 9.0mm High Performance Wire; w/ High Energy Ignition	10034
1974	8 Cyl. 6.6L; 9.0mm High Performance Wire; w/ High Energy Ignition	10034
1974	8 Cyl. 5.7L; 8.5mm High Performance Wire; Equipped with Ceramic Spark Plug Boots; w/ High Energy Ignition	10053
1974	8 Cyl. 7.4L; 8.5mm High Performance Wire; Exc. High Energy Ignition; w/ Straight Non-Bendable Spark Plug Boot	10006
1974	8 Cyl. 7.4L; 8.5mm High Performance Wire; w/ High Energy Ignition	10001
1974	8 Cyl. 6.6L; 8.5mm High Performance Wire; w/ High Energy Ignition	10002
1974	8 Cyl. 7.4L; 8.5mm High Performance Wire; Equipped with Ceramic Spark Plug Boots; Exc. High Energy Ignition	10114
1974	8 Cyl. 7.4L; 8.5mm High Performance Wire; Exc. High Energy Ignition; w/ Straight Bendable Spark Plug Boot	10116
1973	8 Cyl. 6.6L; 400; 8.5mm High Performance Wire; Equipped with Ceramic Spark Plug Boots; Routed Over Valve Cover	10079
1973	8 Cyl. 6.6L; 400; 8.5mm High Performance Wire; Routed Over Valve Cover	10007
1973-1970	8 Cyl. 7.4L; 8.5mm High Performance Wire; Equipped with Ceramic Spark Plug Boots	10114
1973-1970	8 Cyl. 7.4L; 8.5mm High Performance Wire; w/ Straight Non-Bendable Spark Plug Boot	10006
1973-1970	8 Cyl. 7.4L; 8.5mm High Performance Wire; w/ Straight Bendable Spark Plug Boot	10116
1973-1969	8 Cyl. 5.7L; 8.5mm High Performance Wire; Routed Over Valve Cover	10007
1973-1969	8 Cyl. 5.7L; 8.5mm High Performance Wire; Equipped with Ceramic Spark Plug Boots; Routed Over Valve Cover	10079
1972-1970	8 Cyl. 6.6L; 402; 8.5mm High Performance Wire; w/ Straight Non-Bendable Spark Plug Boot	10006
1972-1970	8 Cyl. 6.6L; 402; 8.5mm High Performance Wire; Equipped with Ceramic Spark Plug Boots	10114
1972-1970	8 Cyl. 6.6L; 402; 8.5mm High Performance Wire; w/ Straight Bendable Spark Plug Boot	10116
1969	8 Cyl. 5.4L; 8.5mm High Performance Wire; Routed Over Valve Cover	10007
1969	8 Cyl. 5.3L; 8.5mm High Performance Wire; Equipped with Ceramic Spark Plug Boots; Routed Under Exhaust Manifold	10080
1969-1968	8 Cyl. 6.5L; 8.5mm High Performance Wire; w/ Straight Non-Bendable Spark Plug Boot	10006
1969-1968	8 Cyl. 7.0L; 8.5mm High Performance Wire; w/ Straight Non-Bendable Spark Plug Boot	10006
1969-1968	8 Cyl. 7.0L; 8.5mm High Performance Wire; Equipped with Ceramic Spark Plug Boots	10114

Year	Model/Engine	Part No.
Spark Plug Wire Set		
Bel Air		
1969-1968	8 Cyl. 6.5L; 8.5mm High Performance Wire; Equipped with Ceramic Spark Plug Boots	10114
1969-1968	8 Cyl. 6.5L; 8.5mm High Performance Wire; w/ Straight Bendable Spark Plug Boot	10116
1969-1968	8 Cyl. 7.0L; 8.5mm High Performance Wire; w/ Straight Bendable Spark Plug Boot	10116
1968	8 Cyl. 5.0L; 8.5mm High Performance Wire; Equipped with Ceramic Spark Plug Boots; Routed Under Exhaust Manifold	10080
1968	8 Cyl. 5.0L; 8.5mm High Performance Wire; Routed Under Exhaust Manifold	10005
1968	8 Cyl.; 327; 8.5mm High Performance Wire; Equipped with Ceramic Spark Plug Boots; Routed Under Exhaust Manifold	10080
1968	8 Cyl.; 327; 8.5mm High Performance Wire; Routed Under Exhaust Manifold	10005
1967-1966	8 Cyl. 7.0L; 8.5mm High Performance Wire; Equipped with Ceramic Spark Plug Boots	10114
1967-1966	8 Cyl. 7.0L; 8.5mm High Performance Wire; w/ Straight Non-Bendable Spark Plug Boot	10006
1967-1966	8 Cyl. 7.0L; 8.5mm High Performance Wire; w/ Straight Bendable Spark Plug Boot	10116
1967-1965	8 Cyl. 6.5L; 8.5mm High Performance Wire; w/ Straight Non-Bendable Spark Plug Boot	10006
1967-1965	8 Cyl. 6.5L; 8.5mm High Performance Wire; Equipped with Ceramic Spark Plug Boots	10114
1967-1965	8 Cyl. 6.5L; 8.5mm High Performance Wire; w/ Straight Bendable Spark Plug Boot	10116
1967-1962	8 Cyl. 4.6L; 8.5mm High Performance Wire; Routed Under Exhaust Manifold	10005
1967-1962	8 Cyl. 5.3L; 8.5mm High Performance Wire; Routed Under Exhaust Manifold	10005
1967-1962	8 Cyl. 4.6L; 8.5mm High Performance Wire; Equipped with Ceramic Spark Plug Boots; Routed Under Exhaust Manifold	10080
1967-1962	8 Cyl. 5.3L; 8.5mm High Performance Wire; Equipped with Ceramic Spark Plug Boots; Routed Under Exhaust Manifold	10080
1965-1961	8 Cyl. 6.7L; 8.5mm High Performance Wire	10008
1965-1961	8 Cyl. 6.7L; 8.5mm High Performance Wire; Equipped with Ceramic Spark Plug Boots	10059
1963	8 Cyl. 7.0L; 8.5mm High Performance Wire; Equipped with Ceramic Spark Plug Boots	10114
1963	8 Cyl. 7.0L; 8.5mm High Performance Wire; w/ Straight Non-Bendable Spark Plug Boot	10006
1963	8 Cyl. 7.0L; 8.5mm High Performance Wire; w/ Straight Bendable Spark Plug Boot	10116
1961-1958	8 Cyl. 5.7L; 8.5mm High Performance Wire; Equipped with Ceramic Spark Plug Boots	10059
1961-1958	8 Cyl.; 283; 8.5mm High Performance Wire; Routed Under Exhaust Manifold	10005
1961-1958	8 Cyl.; 283; 8.5mm High Performance Wire; Equipped with Ceramic Spark Plug Boots; Routed Under Exhaust Manifold	10080
1961-1958	8 Cyl. 5.7L; 8.5mm High Performance Wire	10008

Wire Sets

Year	Model/Engine	Part No.
Spark Plug Wire Set		
Bel Air		
1957	8 Cyl. 4.6L; 8.5mm High Performance Wire; Routed Under Exhaust Manifold	10005
1957	8 Cyl. 4.6L; 8.5mm High Performance Wire; Equipped with Ceramic Spark Plug Boots; Routed Under Exhaust Manifold	10080
1957-1955	8 Cyl. 4.3L; 8.5mm High Performance Wire; Routed Under Exhaust Manifold	10005
1957-1955	8 Cyl. 4.3L; 8.5mm High Performance Wire; Equipped with Ceramic Spark Plug Boots; Routed Under Exhaust Manifold	10080
Biscayne		
1972-1971	8 Cyl. 6.6L; 400; 8.5mm High Performance Wire; Routed Over Valve Cover	10007
1972-1971	8 Cyl. 6.6L; 400; 8.5mm High Performance Wire; Equipped with Ceramic Spark Plug Boots; Routed Over Valve Cover	10079
1972-1970	8 Cyl. 6.6L; 402; 8.5mm High Performance Wire; Equipped with Ceramic Spark Plug Boots	10114
1972-1970	8 Cyl. 6.6L; 402; 8.5mm High Performance Wire; w/ Straight Non-Bendable Spark Plug Boot	10006
1972-1970	8 Cyl. 7.4L; 8.5mm High Performance Wire; Equipped with Ceramic Spark Plug Boots	10114
1972-1970	8 Cyl. 7.4L; 8.5mm High Performance Wire; w/ Straight Non-Bendable Spark Plug Boot	10006
1972-1970	8 Cyl. 6.6L; 402; 8.5mm High Performance Wire; w/ Straight Bendable Spark Plug Boot	10116
1972-1970	8 Cyl. 7.4L; 8.5mm High Performance Wire; w/ Straight Bendable Spark Plug Boot	10116
1972-1969	8 Cyl. 5.7L; 8.5mm High Performance Wire; Equipped with Ceramic Spark Plug Boots; Routed Over Valve Cover	10079
1972-1969	8 Cyl. 5.7L; 8.5mm High Performance Wire; Routed Over Valve Cover	10007
1969	8 Cyl. 5.4L; 8.5mm High Performance Wire; Routed Over Valve Cover	10007
1969	8 Cyl. 5.4L; 8.5mm High Performance Wire; Equipped with Ceramic Spark Plug Boots; Routed Over Valve Cover	10079
1969-1968	8 Cyl. 7.0L; 8.5mm High Performance Wire; w/ Straight Non-Bendable Spark Plug Boot	10006
1969-1968	8 Cyl. 6.5L; 8.5mm High Performance Wire; Equipped with Ceramic Spark Plug Boots	10114
1969-1968	8 Cyl. 6.5L; 8.5mm High Performance Wire; w/ Straight Non-Bendable Spark Plug Boot	10006
1969-1968	8 Cyl. 7.0L; 8.5mm High Performance Wire; Equipped with Ceramic Spark Plug Boots	10114
1969-1968	8 Cyl. 6.5L; 8.5mm High Performance Wire; w/ Straight Bendable Spark Plug Boot	10116
1969-1968	8 Cyl. 7.0L; 8.5mm High Performance Wire; w/ Straight Bendable Spark Plug Boot	10116
1968	8 Cyl. 5.0L; 8.5mm High Performance Wire; Equipped with Ceramic Spark Plug Boots; Routed Under Exhaust Manifold	10080
1968	8 Cyl.; 327; 8.5mm High Performance Wire; Routed Under Exhaust Manifold	10005

Year	Model/Engine	Part No.
Spark Plug Wire Set		
Biscayne		
1968	8 Cyl.; 327; 8.5mm High Performance Wire; Equipped with Ceramic Spark Plug Boots; Routed Under Exhaust Manifold	10080
1968	8 Cyl. 5.0L; 8.5mm High Performance Wire; Routed Under Exhaust Manifold	10005
1967-1966	8 Cyl. 7.0L; 8.5mm High Performance Wire; w/ Straight Non-Bendable Spark Plug Boot	10006
1967-1966	8 Cyl. 7.0L; 8.5mm High Performance Wire; Equipped with Ceramic Spark Plug Boots	10114
1967-1966	8 Cyl. 7.0L; 8.5mm High Performance Wire; w/ Straight Bendable Spark Plug Boot	10116
1967-1965	8 Cyl. 6.5L; 8.5mm High Performance Wire; Equipped with Ceramic Spark Plug Boots	10114
1967-1965	8 Cyl. 6.5L; 8.5mm High Performance Wire; w/ Straight Non-Bendable Spark Plug Boot	10006
1967-1965	8 Cyl. 6.5L; 8.5mm High Performance Wire; w/ Straight Bendable Spark Plug Boot	10116
1967-1963	8 Cyl. 5.3L; 8.5mm High Performance Wire; Routed Under Exhaust Manifold	10005
1967-1963	8 Cyl. 5.3L; 8.5mm High Performance Wire; Equipped with Ceramic Spark Plug Boots; Routed Under Exhaust Manifold	10080
1967-1959	8 Cyl. 4.6L; 8.5mm High Performance Wire; Equipped with Ceramic Spark Plug Boots; Routed Under Exhaust Manifold	10080
1967-1959	8 Cyl. 4.6L; 8.5mm High Performance Wire; Routed Under Exhaust Manifold	10005
1965-1961	8 Cyl. 6.7L; 8.5mm High Performance Wire; Equipped with Ceramic Spark Plug Boots	10059
1965-1961	8 Cyl. 6.7L; 8.5mm High Performance Wire	10008
1963	8 Cyl. 7.0L; 8.5mm High Performance Wire; w/ Straight Non-Bendable Spark Plug Boot	10006
1963	8 Cyl. 7.0L; 8.5mm High Performance Wire; Equipped with Ceramic Spark Plug Boots	10114
1963	8 Cyl. 7.0L; 8.5mm High Performance Wire; w/ Straight Bendable Spark Plug Boot	10116
1961-1958	8 Cyl. 5.7L; 8.5mm High Performance Wire; Equipped with Ceramic Spark Plug Boots	10059
1961-1958	8 Cyl. 5.7L; 8.5mm High Performance Wire	10008
1958	8 Cyl.; 283; 8.5mm High Performance Wire; Equipped with Ceramic Spark Plug Boots; Routed Under Exhaust Manifold	10080
1958	8 Cyl.; 283; 8.5mm High Performance Wire; Routed Under Exhaust Manifold	10005
Blazer		
2005-2003	6 Cyl. 4.3L; 8.5mm High Performance Wire	10077
2005-2003	6 Cyl. 4.3L; 8.5mm High Performance Wire; Equipped with Ceramic Spark Plug Boots	10078
2002-1996	6 Cyl. 4.3L; 8.5mm High Performance Wire	10077
2002-1996	6 Cyl. 4.3L; 8.5mm High Performance Wire; Equipped with Ceramic Spark Plug Boots	10078
1995	6 Cyl. 4.3L; 8.5mm High Performance Wire; Equipped with Ceramic Spark Plug Boots; Vertical Towers	10076

Chevrolet

Wire Sets

Year	Model/Engine	Part No.
Spark Plug Wire Set		
Blazer		
1995	6 Cyl. 4.3L; 8.5mm High Performance Wire; Vertical Towers	10014
1994-1987	8 Cyl. 5.7L; 9.0mm High Performance Wire	10038
1994-1987	8 Cyl. 5.7L; 8.5mm High Performance Wire; Equipped with Ceramic Spark Plug Boots	10046
1994-1987	8 Cyl. 5.7L; 8.5mm High Performance Wire	10018
1987	8 Cyl. 5.0L; 8.5mm High Performance Wire	10018
1987	8 Cyl. 5.0L; 8.5mm High Performance Wire; Equipped with Ceramic Spark Plug Boots	10046
1987	8 Cyl. 5.0L; 9.0mm High Performance Wire	10038
1974-1973	8 Cyl. 5.7L; 8.5mm High Performance Wire; Equipped with Ceramic Spark Plug Boots; Routed Over Valve Cover	10079
1974-1973	8 Cyl. 5.7L; 8.5mm High Performance Wire; Routed Over Valve Cover	10007
1973	8 Cyl. 5.0L; 8.5mm High Performance Wire; Routed Over Valve Cover	10007
1973	8 Cyl. 7.4L; 8.5mm High Performance Wire; w/ Straight Non-Bendable Spark Plug Boot	10006
1973	8 Cyl. 5.0L; 8.5mm High Performance Wire; Equipped with Ceramic Spark Plug Boots; Routed Over Valve Cover	10079
1973	8 Cyl. 7.4L; 8.5mm High Performance Wire; Equipped with Ceramic Spark Plug Boots	10114
1973	8 Cyl. 7.4L; 8.5mm High Performance Wire; w/ Straight Bendable Spark Plug Boot	10116
1972-1969	8 Cyl. 5.0L; 8.5mm High Performance Wire; Equipped with Ceramic Spark Plug Boots; Routed Under Exhaust Manifold	10080
1972-1969	8 Cyl. 5.7L; 8.5mm High Performance Wire; Routed Under Exhaust Manifold	10005
1972-1969	8 Cyl. 5.0L; 8.5mm High Performance Wire; Routed Under Exhaust Manifold	10005
1972-1969	8 Cyl. 5.7L; 8.5mm High Performance Wire; Equipped with Ceramic Spark Plug Boots; Routed Under Exhaust Manifold	10080
Brookwood		
1972	8 Cyl. 6.6L; 402; 8.5mm High Performance Wire; Equipped with Ceramic Spark Plug Boots	10114
1972	8 Cyl. 6.6L; 402; 8.5mm High Performance Wire; w/ Straight Non-Bendable Spark Plug Boot	10006
1972	8 Cyl. 6.6L; 402; 8.5mm High Performance Wire; w/ Straight Bendable Spark Plug Boot	10116
1972-1969	8 Cyl. 5.7L; 8.5mm High Performance Wire; Routed Over Valve Cover	10007
1972-1969	8 Cyl. 5.7L; 8.5mm High Performance Wire; Equipped with Ceramic Spark Plug Boots; Routed Over Valve Cover	10079
1970	8 Cyl. 6.6L; 402; 8.5mm High Performance Wire; Equipped with Ceramic Spark Plug Boots	10114
1970	8 Cyl. 6.6L; 402; 8.5mm High Performance Wire; w/ Straight Non-Bendable Spark Plug Boot	10006
1970	8 Cyl. 6.6L; 402; 8.5mm High Performance Wire; w/ Straight Bendable Spark Plug Boot	10116

Year	Model/Engine	Part No.
Spark Plug Wire Set		
Brookwood		
1961	8 Cyl. 6.7L; 8.5mm High Performance Wire	10008
1961	8 Cyl. 6.7L; 8.5mm High Performance Wire; Equipped with Ceramic Spark Plug Boots	10059
1961-1958	8 Cyl. 5.7L; 8.5mm High Performance Wire	10008
1961-1958	8 Cyl. 4.6L; 8.5mm High Performance Wire; Equipped with Ceramic Spark Plug Boots; Routed Under Exhaust Manifold	10080
1961-1958	8 Cyl. 5.7L; 8.5mm High Performance Wire; Equipped with Ceramic Spark Plug Boots	10059
1961-1958	8 Cyl. 4.6L; 8.5mm High Performance Wire; Routed Under Exhaust Manifold	10005
C10		
1986	8 Cyl. 5.7L; L; 8.5mm High Performance Wire; Equipped with Ceramic Spark Plug Boots	10056
1986	8 Cyl. 5.7L; L; 8.5mm High Performance Wire	10010
1986	8 Cyl. 5.7L; L; 9.0mm High Performance Wire	10037
1986	8 Cyl. 5.7L; M; 8.5mm High Performance Wire; Calif.	10010
1986	8 Cyl. 5.7L; M; 8.5mm High Performance Wire; Equipped with Ceramic Spark Plug Boots; Fed.	10053
1986	8 Cyl. 5.7L; M; 9.0mm High Performance Wire; Calif.	10037
1986	8 Cyl. 5.7L; M; 8.5mm High Performance Wire; Calif.; Equipped with Ceramic Spark Plug Boots	10056
1986	8 Cyl. 5.7L; M; 8.5mm High Performance Wire; Fed.	10002
1986	8 Cyl. 5.7L; M; 9.0mm High Performance Wire; Fed.	10034
1986-1981	8 Cyl. 5.0L; 8.5mm High Performance Wire; Equipped with Ceramic Spark Plug Boots	10056
1986-1981	8 Cyl. 5.0L; 9.0mm High Performance Wire	10037
1986-1981	8 Cyl. 5.0L; 8.5mm High Performance Wire	10010
1985-1983	8 Cyl. 5.7L; 9.0mm High Performance Wire	10037
1985-1983	8 Cyl. 5.7L; 8.5mm High Performance Wire; Equipped with Ceramic Spark Plug Boots	10056
1985-1983	8 Cyl. 5.7L; 8.5mm High Performance Wire	10010
1982	8 Cyl. 5.7L; L; 8.5mm High Performance Wire; Equipped with Ceramic Spark Plug Boots	10056
1982	8 Cyl. 5.7L; L; 8.5mm High Performance Wire	10010
1982	8 Cyl. 5.7L; L; 9.0mm High Performance Wire	10037
1982	8 Cyl. 5.7L; M; 9.0mm High Performance Wire	10034
1982	8 Cyl. 5.7L; M; 8.5mm High Performance Wire; Equipped with Ceramic Spark Plug Boots	10053
1982	8 Cyl. 5.7L; M; 8.5mm High Performance Wire	10002
1981	8 Cyl. 5.7L; L; 8.5mm High Performance Wire; w/ Both 90 Deg. and Straight Plug Boots	10010

Wire Sets

Year	Model/Engine	Part No.
Spark Plug Wire Set		
C10		
1981	8 Cyl. 5.7L; L; 8.5mm High Performance Wire; Equipped with Ceramic Spark Plug Boots; w/ Both 90 Deg. and Straight Plug Boots	10056
1981	8 Cyl. 5.7L; L; 9.0mm High Performance Wire	10034
1981	8 Cyl. 5.7L; L; 9.0mm High Performance Wire; Calif.	10037
1981	8 Cyl. 5.7L; L; 8.5mm High Performance Wire	10002
1981	8 Cyl. 5.7L; Z; 9.0mm High Performance Wire	10034
1981-1975	8 Cyl. 5.7L; 8.5mm High Performance Wire; Equipped with Ceramic Spark Plug Boots	10053
1980-1977	8 Cyl. 7.4L; 8.5mm High Performance Wire; Equipped with Ceramic Spark Plug Boots	10069
1980-1977	8 Cyl. 7.4L; 8.5mm High Performance Wire	10001
1980-1976	8 Cyl. 5.0L; 8.5mm High Performance Wire	10002
1980-1976	8 Cyl. 6.6L; 8.5mm High Performance Wire; Equipped with Ceramic Spark Plug Boots	10053
1980-1976	8 Cyl. 5.0L; 8.5mm High Performance Wire; Equipped with Ceramic Spark Plug Boots	10053
1980-1976	8 Cyl. 5.0L; 9.0mm High Performance Wire	10034
1980-1976	8 Cyl. 6.6L; 9.0mm High Performance Wire	10034
1980-1976	8 Cyl. 6.6L; 8.5mm High Performance Wire	10002
1980-1975	8 Cyl. 5.7L; 9.0mm High Performance Wire	10034
1980-1975	8 Cyl. 5.7L; 8.5mm High Performance Wire	10002
1976	8 Cyl. 7.4L; 8.5mm High Performance Wire; Equipped with Ceramic Spark Plug Boots; w/o AC	10069
1976	8 Cyl. 7.4L; 8.5mm High Performance Wire; w/o AC	10001
1975	8 Cyl. 7.4L; 8.5mm High Performance Wire; Equipped with Ceramic Spark Plug Boots	10069
1975	8 Cyl. 7.4L; 8.5mm High Performance Wire	10001
C10 Pickup		
1974	8 Cyl. 5.7L; 8.5mm High Performance Wire; Routed Over Valve Cover	10007
1974	8 Cyl. 5.7L; 8.5mm High Performance Wire; Equipped with Ceramic Spark Plug Boots; Routed Over Valve Cover	10079
1974-1973	8 Cyl. 7.4L; 8.5mm High Performance Wire; w/ Straight Non-Bendable Spark Plug Boot	10006
1974-1973	8 Cyl. 7.4L; 8.5mm High Performance Wire; Equipped with Ceramic Spark Plug Boots	10114
1974-1973	8 Cyl. 7.4L; 8.5mm High Performance Wire; w/ Straight Bendable Spark Plug Boot	10116
1973-1969	8 Cyl. 5.7L; 8.5mm High Performance Wire; Equipped with Ceramic Spark Plug Boots; Routed Under Exhaust Manifold	10080
1973-1969	8 Cyl. 5.7L; 8.5mm High Performance Wire; Routed Under Exhaust Manifold	10005
1973-1968	8 Cyl. 5.0L; 8.5mm High Performance Wire; Routed Under Exhaust Manifold	10005

Year	Model/Engine	Part No.
Spark Plug Wire Set		
C10 Pickup		
1973-1968	8 Cyl. 5.0L; 8.5mm High Performance Wire; Equipped with Ceramic Spark Plug Boots; Routed Under Exhaust Manifold	10080
1972-1970	8 Cyl. 6.6L; 8.5mm High Performance Wire; w/ Straight Non-Bendable Spark Plug Boot	10006
1972-1970	8 Cyl. 6.6L; 8.5mm High Performance Wire; Equipped with Ceramic Spark Plug Boots	10114
1972-1970	8 Cyl. 6.6L; 8.5mm High Performance Wire; w/ Straight Bendable Spark Plug Boot	10116
1969-1968	8 Cyl. 6.5L; 8.5mm High Performance Wire; Equipped with Ceramic Spark Plug Boots	10114
1969-1968	8 Cyl. 6.5L; 8.5mm High Performance Wire; w/ Straight Non-Bendable Spark Plug Boot	10006
1969-1968	8 Cyl. 6.5L; 8.5mm High Performance Wire; w/ Straight Bendable Spark Plug Boot	10116
1968	8 Cyl. 5.4L; 8.5mm High Performance Wire; Equipped with Ceramic Spark Plug Boots; Routed Under Exhaust Manifold	10080
1968	8 Cyl. 5.4L; 8.5mm High Performance Wire; Routed Under Exhaust Manifold	10005
1967-1966	8 Cyl. 5.3L; 8.5mm High Performance Wire; Routed Under Exhaust Manifold	10005
1967-1966	8 Cyl. 5.3L; 8.5mm High Performance Wire; Equipped with Ceramic Spark Plug Boots; Routed Under Exhaust Manifold	10080
1967-1961	8 Cyl. 4.6L; 8.5mm High Performance Wire; Equipped with Ceramic Spark Plug Boots; Routed Under Exhaust Manifold	10080
1967-1961	8 Cyl. 4.6L; 8.5mm High Performance Wire; Routed Under Exhaust Manifold	10005
C10 Suburban		
1986	8 Cyl. 5.7L; L; 8.5mm High Performance Wire; Equipped with Ceramic Spark Plug Boots	10056
1986	8 Cyl. 5.7L; L; 8.5mm High Performance Wire	10010
1986	8 Cyl. 5.7L; L; 9.0mm High Performance Wire	10037
1986	8 Cyl. 5.7L; M; 8.5mm High Performance Wire; Fed.	10002
1986	8 Cyl. 5.7L; M; 8.5mm High Performance Wire; Calif.; Equipped with Ceramic Spark Plug Boots	10056
1986	8 Cyl. 5.7L; M; 9.0mm High Performance Wire; Calif.	10037
1986	8 Cyl. 5.7L; M; 8.5mm High Performance Wire; Equipped with Ceramic Spark Plug Boots; Fed.	10053
1986	8 Cyl. 5.7L; M; 8.5mm High Performance Wire; Calif.	10010
1986	8 Cyl. 5.7L; M; 9.0mm High Performance Wire; Fed.	10034
1986-1981	8 Cyl. 5.0L; 9.0mm High Performance Wire	10037
1986-1981	8 Cyl. 5.0L; 8.5mm High Performance Wire	10010
1986-1981	8 Cyl. 5.0L; 8.5mm High Performance Wire; Equipped with Ceramic Spark Plug Boots	10056
1985-1983	8 Cyl. 5.7L; 8.5mm High Performance Wire; Equipped with Ceramic Spark Plug Boots	10056
1985-1983	8 Cyl. 5.7L; 8.5mm High Performance Wire	10010

Wire Sets

Year	Model/Engine	Part No.
Spark Plug Wire Set		
C10 Suburban		
1985-1983	8 Cyl. 5.7L; 9.0mm High Performance Wire	10037
1982-1981	8 Cyl. 5.7L; L; 8.5mm High Performance Wire; Equipped with Ceramic Spark Plug Boots	10056
1982-1981	8 Cyl. 5.7L; L; 8.5mm High Performance Wire	10010
1982-1981	8 Cyl. 5.7L; L; 9.0mm High Performance Wire	10037
1980-1977	8 Cyl. 7.4L; 8.5mm High Performance Wire; Equipped with Ceramic Spark Plug Boots	10069
1980-1977	8 Cyl. 7.4L; 8.5mm High Performance Wire	10001
1980-1976	8 Cyl. 5.0L; 8.5mm High Performance Wire; Equipped with Ceramic Spark Plug Boots	10053
1980-1976	8 Cyl. 5.0L; 8.5mm High Performance Wire	10002
1980-1976	8 Cyl. 5.0L; 9.0mm High Performance Wire	10034
1980-1975	8 Cyl. 5.7L; 9.0mm High Performance Wire	10034
1980-1975	8 Cyl. 5.7L; 8.5mm High Performance Wire	10002
1980-1975	8 Cyl. 5.7L; 8.5mm High Performance Wire; Equipped with Ceramic Spark Plug Boots	10053
1976	8 Cyl. 7.4L; 8.5mm High Performance Wire; Equipped with Ceramic Spark Plug Boots; w/o AC	10069
1976	8 Cyl. 7.4L; 8.5mm High Performance Wire; w/o AC	10001
1975	8 Cyl. 7.4L; 8.5mm High Performance Wire; Equipped with Ceramic Spark Plug Boots	10069
1975	8 Cyl. 7.4L; 8.5mm High Performance Wire	10001
1974	8 Cyl. 5.7L; 8.5mm High Performance Wire; Equipped with Ceramic Spark Plug Boots; Routed Over Valve Cover	10079
1974	8 Cyl. 5.7L; 8.5mm High Performance Wire; Routed Over Valve Cover	10007
1974-1973	8 Cyl. 7.4L; 8.5mm High Performance Wire; w/ Straight Non-Bendable Spark Plug Boot	10006
1974-1973	8 Cyl. 7.4L; 8.5mm High Performance Wire; Equipped with Ceramic Spark Plug Boots	10114
1974-1973	8 Cyl. 7.4L; 8.5mm High Performance Wire; w/ Straight Bendable Spark Plug Boot	10116
1973-1969	8 Cyl. 5.7L; 8.5mm High Performance Wire; Routed Under Exhaust Manifold	10005
1973-1969	8 Cyl. 5.7L; 8.5mm High Performance Wire; Equipped with Ceramic Spark Plug Boots; Routed Under Exhaust Manifold	10080
1973-1968	8 Cyl. 5.0L; 8.5mm High Performance Wire; Equipped with Ceramic Spark Plug Boots; Routed Under Exhaust Manifold	10080
1973-1968	8 Cyl. 5.0L; 8.5mm High Performance Wire; Routed Under Exhaust Manifold	10005
1972-1970	8 Cyl. 6.6L; 8.5mm High Performance Wire; Equipped with Ceramic Spark Plug Boots	10114
1972-1970	8 Cyl. 6.6L; 8.5mm High Performance Wire; w/ Straight Non-Bendable Spark Plug Boot	10006
1972-1970	8 Cyl. 6.6L; 8.5mm High Performance Wire; w/ Straight Bendable Spark Plug Boot	10116

Year	Model/Engine	Part No.
Spark Plug Wire Set		
C10 Suburban		
1969-1968	8 Cyl. 6.5L; 8.5mm High Performance Wire; w/ Straight Non-Bendable Spark Plug Boot	10006
1969-1968	8 Cyl. 6.5L; 8.5mm High Performance Wire; Equipped with Ceramic Spark Plug Boots	10114
1969-1968	8 Cyl. 6.5L; 8.5mm High Performance Wire; w/ Straight Bendable Spark Plug Boot	10116
1968	8 Cyl. 5.4L; 8.5mm High Performance Wire; Routed Under Exhaust Manifold	10005
1968	8 Cyl. 5.4L; 8.5mm High Performance Wire; Equipped with Ceramic Spark Plug Boots; Routed Under Exhaust Manifold	10080
1967-1966	8 Cyl. 5.3L; 8.5mm High Performance Wire; Equipped with Ceramic Spark Plug Boots; Routed Under Exhaust Manifold	10080
1967-1966	8 Cyl. 5.3L; 8.5mm High Performance Wire; Routed Under Exhaust Manifold	10005
1967-1961	8 Cyl. 4.6L; 8.5mm High Performance Wire; Equipped with Ceramic Spark Plug Boots; Routed Under Exhaust Manifold	10080
1967-1961	8 Cyl. 4.6L; 8.5mm High Performance Wire; Routed Under Exhaust Manifold	10005
1965	8 Cyl. 5.7L; 8.5mm High Performance Wire; Equipped with Ceramic Spark Plug Boots	10059
1965	8 Cyl. 6.7L; 8.5mm High Performance Wire	10008
1965	8 Cyl. 6.7L; 8.5mm High Performance Wire; Equipped with Ceramic Spark Plug Boots	10059
1965	8 Cyl. 5.7L; 8.5mm High Performance Wire	10008
1964	8 Cyl. 5.7L; 8.5mm High Performance Wire; Routed Under Exhaust Manifold	10005
1964	8 Cyl. 6.7L; 8.5mm High Performance Wire; Equipped with Ceramic Spark Plug Boots; Routed Under Exhaust Manifold	10080
1964	8 Cyl. 5.7L; 8.5mm High Performance Wire; Equipped with Ceramic Spark Plug Boots; Routed Under Exhaust Manifold	10080
1964	8 Cyl. 6.7L; 8.5mm High Performance Wire; Routed Under Exhaust Manifold	10005
1962	8 Cyl. 6.7L; 8.5mm High Performance Wire; Equipped with Ceramic Spark Plug Boots; Routed Under Exhaust Manifold	10080
1962	8 Cyl. 6.7L; 8.5mm High Performance Wire; Routed Under Exhaust Manifold	10005
1962-1961	8 Cyl. 5.7L; 8.5mm High Performance Wire; Routed Under Exhaust Manifold	10005
1962-1961	8 Cyl. 5.7L; 8.5mm High Performance Wire; Equipped with Ceramic Spark Plug Boots; Routed Under Exhaust Manifold	10080
C20		
1986	8 Cyl. 5.0L; 8.5mm High Performance Wire; Equipped with Ceramic Spark Plug Boots	10056
1986	8 Cyl. 7.4L; 8.5mm High Performance Wire; Fed.	10064
1986	8 Cyl. 7.4L; 8.5mm High Performance Wire; Equipped with Ceramic Spark Plug Boots; Fed.	10065
1986	8 Cyl. 5.0L; 8.5mm High Performance Wire	10010
1986	8 Cyl. 7.4L; 8.5mm High Performance Wire; Calif.	10001
1986	8 Cyl. 7.4L; 8.5mm High Performance Wire; Calif.; Equipped with Ceramic Spark Plug Boots	10069

Wire Sets

Year	Model/Engine	Part No.
Spark Plug Wire Set		
C20		
1986	8 Cyl. 5.7L; L; 8.5mm High Performance Wire; Equipped with Ceramic Spark Plug Boots	10056
1986	8 Cyl. 5.7L; L; 8.5mm High Performance Wire	10010
1986	8 Cyl. 5.7L; M; 8.5mm High Performance Wire; Calif.	10010
1986	8 Cyl. 5.7L; M; 9.0mm High Performance Wire; Fed.	10034
1986	8 Cyl. 5.7L; M; 8.5mm High Performance Wire; Equipped with Ceramic Spark Plug Boots; Fed.	10053
1986	8 Cyl. 5.7L; M; 8.5mm High Performance Wire; Calif.; Equipped with Ceramic Spark Plug Boots	10056
1986	8 Cyl. 5.7L; M; 8.5mm High Performance Wire; Fed.	10002
1986	8 Cyl. 5.7L; M; 9.0mm High Performance Wire; Calif.	10037
1986-1985	8 Cyl. 5.7L; L; 9.0mm High Performance Wire	10037
1986-1981	8 Cyl. 5.0L; 9.0mm High Performance Wire	10037
1985	8 Cyl. 7.4L; 8.5mm High Performance Wire; w/ Cast Iron Exhaust Manifold	10001
1985	8 Cyl. 7.4L; 8.5mm High Performance Wire; Equipped with Ceramic Spark Plug Boots; w/ Cast Iron Exhaust Manifold	10069
1985	8 Cyl. 5.0L; 8.5mm High Performance Wire; Equipped with Ceramic Spark Plug Boots; w/ Both 90 Deg. and Straight Plug Boots	10056
1985	8 Cyl. 5.0L; 8.5mm High Performance Wire; w/ Both 90 Deg. and Straight Plug Boots	10010
1985	8 Cyl. 7.4L; 8.5mm High Performance Wire; Equipped with Ceramic Spark Plug Boots; w/ Stainless Steel Exhaust Manifold	10065
1985	8 Cyl. 7.4L; 8.5mm High Performance Wire; w/ Stainless Steel Exhaust Manifold	10064
1985	8 Cyl. 5.7L; L; 8.5mm High Performance Wire; w/ Both 90 Deg. and Straight Plug Boots	10010
1985	8 Cyl. 5.7L; L; 8.5mm High Performance Wire; Equipped with Ceramic Spark Plug Boots; w/ Both 90 Deg. and Straight Plug Boots	10056
1985	8 Cyl. 5.7L; M; 9.0mm High Performance Wire	10034
1985	8 Cyl. 5.7L; M; 8.5mm High Performance Wire	10002
1985	8 Cyl. 5.7L; M; 8.5mm High Performance Wire; w/ Both 90 Deg. and Straight Plug Boots	10010
1985	8 Cyl. 5.7L; M; 8.5mm High Performance Wire; Equipped with Ceramic Spark Plug Boots	10053
1985	8 Cyl. 5.7L; M; 9.0mm High Performance Wire; w/ Cast Iron Exhaust Manifold	10037
1985	8 Cyl. 5.7L; M; 8.5mm High Performance Wire; Equipped with Ceramic Spark Plug Boots; w/ Both 90 Deg. and Straight Plug Boots	10056
1984-1983	8 Cyl. 5.7L; 9.0mm High Performance Wire	10037
1984-1983	8 Cyl. 5.7L; 8.5mm High Performance Wire; Equipped with Ceramic Spark Plug Boots	10056
1984-1983	8 Cyl. 5.7L; 8.5mm High Performance Wire	10010

Year	Model/Engine	Part No.
Spark Plug Wire Set		
C20		
1984-1982	8 Cyl. 5.0L; 8.5mm High Performance Wire; Equipped with Ceramic Spark Plug Boots	10056
1984-1981	8 Cyl. 5.0L; 8.5mm High Performance Wire	10010
1984-1977	8 Cyl. 7.4L; 8.5mm High Performance Wire	10001
1984-1977	8 Cyl. 7.4L; 8.5mm High Performance Wire; Equipped with Ceramic Spark Plug Boots	10069
1982-1981	8 Cyl. 5.7L; L; 9.0mm High Performance Wire	10037
1982-1981	8 Cyl. 5.7L; L; 8.5mm High Performance Wire; Equipped with Ceramic Spark Plug Boots	10056
1982-1981	8 Cyl. 5.7L; L; 8.5mm High Performance Wire	10010
1982-1981	8 Cyl. 5.7L; M; 9.0mm High Performance Wire	10034
1982-1981	8 Cyl. 5.7L; M; 8.5mm High Performance Wire	10002
1982-1981	8 Cyl. 5.7L; M; 8.5mm High Performance Wire; Equipped with Ceramic Spark Plug Boots	10053
1980-1977	8 Cyl. 5.0L; 8.5mm High Performance Wire	10002
1980-1977	8 Cyl. 5.0L; 8.5mm High Performance Wire; Equipped with Ceramic Spark Plug Boots	10053
1980-1977	8 Cyl. 5.0L; 9.0mm High Performance Wire	10034
1980-1976	8 Cyl. 6.6L; 9.0mm High Performance Wire	10034
1980-1976	8 Cyl. 6.6L; 8.5mm High Performance Wire	10002
1980-1976	8 Cyl. 6.6L; 8.5mm High Performance Wire; Equipped with Ceramic Spark Plug Boots	10053
1980-1975	8 Cyl. 5.7L; 8.5mm High Performance Wire; Equipped with Ceramic Spark Plug Boots	10053
1980-1975	8 Cyl. 5.7L; 8.5mm High Performance Wire	10002
1980-1975	8 Cyl. 5.7L; 9.0mm High Performance Wire	10034
1976	8 Cyl. 7.4L; 8.5mm High Performance Wire; w/o AC	10001
1976	8 Cyl. 7.4L; 8.5mm High Performance Wire; Equipped with Ceramic Spark Plug Boots; w/o AC	10069
1975	8 Cyl. 7.4L; 8.5mm High Performance Wire	10001
1975	8 Cyl. 7.4L; 8.5mm High Performance Wire; Equipped with Ceramic Spark Plug Boots	10069
C20 Pickup		
1974-1973	8 Cyl. 5.7L; 8.5mm High Performance Wire; Routed Over Valve Cover	10007
1974-1973	8 Cyl. 7.4L; 8.5mm High Performance Wire; w/ Straight Non-Bendable Spark Plug Boot	10006
1974-1973	8 Cyl. 7.4L; 8.5mm High Performance Wire; Equipped with Ceramic Spark Plug Boots	10114
1974-1973	8 Cyl. 5.7L; 8.5mm High Performance Wire; Equipped with Ceramic Spark Plug Boots; Routed Over Valve Cover	10079
1974-1973	8 Cyl. 7.4L; 8.5mm High Performance Wire; w/ Straight Bendable Spark Plug Boot	10116

Wire Sets

Year	Model/Engine	Part No.
Spark Plug Wire Set		
C20 Pickup		
1973	8 Cyl. 5.0L; 8.5mm High Performance Wire; Routed Over Valve Cover	10007
1973	8 Cyl. 5.0L; 8.5mm High Performance Wire; Equipped with Ceramic Spark Plug Boots; Routed Over Valve Cover	10079
1972-1970	8 Cyl. 6.6L; 8.5mm High Performance Wire; w/ Straight Non-Bendable Spark Plug Boot	10006
1972-1970	8 Cyl. 6.6L; 8.5mm High Performance Wire; Equipped with Ceramic Spark Plug Boots	10114
1972-1970	8 Cyl. 6.6L; 8.5mm High Performance Wire; w/ Straight Bendable Spark Plug Boot	10116
1972-1969	8 Cyl. 5.7L; 8.5mm High Performance Wire; Routed Under Exhaust Manifold	10005
1972-1969	8 Cyl. 5.7L; 8.5mm High Performance Wire; Equipped with Ceramic Spark Plug Boots; Routed Under Exhaust Manifold	10080
1972-1968	8 Cyl. 5.0L; 8.5mm High Performance Wire; Routed Under Exhaust Manifold	10005
1972-1968	8 Cyl. 5.0L; 8.5mm High Performance Wire; Equipped with Ceramic Spark Plug Boots; Routed Under Exhaust Manifold	10080
1969-1968	8 Cyl. 6.5L; 8.5mm High Performance Wire; w/ Straight Non-Bendable Spark Plug Boot	10006
1969-1968	8 Cyl. 6.5L; 8.5mm High Performance Wire; Equipped with Ceramic Spark Plug Boots	10114
1969-1968	8 Cyl. 6.5L; 8.5mm High Performance Wire; w/ Straight Bendable Spark Plug Boot	10116
1968	8 Cyl. 5.4L; 8.5mm High Performance Wire; Routed Under Exhaust Manifold	10005
1968	8 Cyl. 5.4L; 8.5mm High Performance Wire; Equipped with Ceramic Spark Plug Boots; Routed Under Exhaust Manifold	10080
1967-1966	8 Cyl. 5.3L; 8.5mm High Performance Wire; Equipped with Ceramic Spark Plug Boots; Routed Under Exhaust Manifold	10080
1967-1966	8 Cyl. 5.3L; 8.5mm High Performance Wire; Routed Under Exhaust Manifold	10005
1967-1961	8 Cyl. 4.6L; 8.5mm High Performance Wire; Routed Under Exhaust Manifold	10005
1967-1961	8 Cyl. 4.6L; 8.5mm High Performance Wire; Equipped with Ceramic Spark Plug Boots; Routed Under Exhaust Manifold	10080
1965	8 Cyl. 6.7L; 8.5mm High Performance Wire	10008
1965	8 Cyl. 6.7L; 8.5mm High Performance Wire; Equipped with Ceramic Spark Plug Boots	10059
1965	8 Cyl. 5.7L; 8.5mm High Performance Wire	10008
1965	8 Cyl. 5.7L; 8.5mm High Performance Wire; Equipped with Ceramic Spark Plug Boots	10059
1964	8 Cyl. 5.7L; 8.5mm High Performance Wire; Equipped with Ceramic Spark Plug Boots; Routed Under Exhaust Manifold	10080
1964	8 Cyl. 5.7L; 8.5mm High Performance Wire; Routed Under Exhaust Manifold	10005
1964	8 Cyl. 6.7L; 8.5mm High Performance Wire; Equipped with Ceramic Spark Plug Boots; Routed Under Exhaust Manifold	10080
1964	8 Cyl. 6.7L; 8.5mm High Performance Wire; Routed Under Exhaust Manifold	10005
1962	8 Cyl. 6.7L; 8.5mm High Performance Wire; Equipped with Ceramic Spark Plug Boots; Routed Under Exhaust Manifold	10080

Year	Model/Engine	Part No.
Spark Plug Wire Set		
C20 Pickup		
1962	8 Cyl. 6.7L; 8.5mm High Performance Wire; Routed Under Exhaust Manifold	10005
1962-1961	8 Cyl. 5.7L; 8.5mm High Performance Wire; Equipped with Ceramic Spark Plug Boots; Routed Under Exhaust Manifold	10080
1962-1961	8 Cyl. 5.7L; 8.5mm High Performance Wire; Routed Under Exhaust Manifold	10005
C20 Suburban		
1986	8 Cyl. 7.4L; 8.5mm High Performance Wire; Fed.	10064
1986	8 Cyl. 7.4L; 8.5mm High Performance Wire; Equipped with Ceramic Spark Plug Boots; Fed.	10065
1986	8 Cyl. 7.4L; 8.5mm High Performance Wire; Calif.; Equipped with Ceramic Spark Plug Boots	10069
1986	8 Cyl. 7.4L; 8.5mm High Performance Wire; Calif.	10001
1986	8 Cyl. 5.7L; L; 9.0mm High Performance Wire	10037
1986	8 Cyl. 5.7L; L; 8.5mm High Performance Wire	10010
1986	8 Cyl. 5.7L; L; 8.5mm High Performance Wire; Equipped with Ceramic Spark Plug Boots	10056
1986	8 Cyl. 5.7L; M; 9.0mm High Performance Wire; Fed.	10034
1986	8 Cyl. 5.7L; M; 9.0mm High Performance Wire; Calif.	10037
1986	8 Cyl. 5.7L; M; 8.5mm High Performance Wire; Equipped with Ceramic Spark Plug Boots; Fed.	10053
1986	8 Cyl. 5.7L; M; 8.5mm High Performance Wire; Fed.	10002
1986	8 Cyl. 5.7L; M; 8.5mm High Performance Wire; Calif.; Equipped with Ceramic Spark Plug Boots	10056
1986	8 Cyl. 5.7L; M; 8.5mm High Performance Wire; Calif.	10010
1986-1981	8 Cyl. 5.0L; 9.0mm High Performance Wire	10037
1986-1981	8 Cyl. 5.0L; 8.5mm High Performance Wire	10010
1986-1981	8 Cyl. 5.0L; 8.5mm High Performance Wire; Equipped with Ceramic Spark Plug Boots	10056
1985	8 Cyl. 7.4L; 8.5mm High Performance Wire; w/ Cast Iron Exhaust Manifold	10001
1985	8 Cyl. 7.4L; 8.5mm High Performance Wire; Equipped with Ceramic Spark Plug Boots; w/ Stainless Steel Exhaust Manifold	10065
1985	8 Cyl. 7.4L; 8.5mm High Performance Wire; w/ Stainless Steel Exhaust Manifold	10064
1985	8 Cyl. 7.4L; 8.5mm High Performance Wire; Equipped with Ceramic Spark Plug Boots; w/ Cast Iron Exhaust Manifold	10069
1985-1983	8 Cyl. 5.7L; 9.0mm High Performance Wire	10037
1985-1983	8 Cyl. 5.7L; 8.5mm High Performance Wire	10010
1985-1983	8 Cyl. 5.7L; 8.5mm High Performance Wire; Equipped with Ceramic Spark Plug Boots	10056
1984-1977	8 Cyl. 7.4L; 8.5mm High Performance Wire	10001
1984-1977	8 Cyl. 7.4L; 8.5mm High Performance Wire; Equipped with Ceramic Spark Plug Boots	10069

Wire Sets

Year	Model/Engine	Part No.
Spark Plug Wire Set		
C20 Suburban		
1982-1981	8 Cyl. 5.7L; L; 9.0mm High Performance Wire	10037
1982-1981	8 Cyl. 5.7L; L; 8.5mm High Performance Wire	10010
1982-1981	8 Cyl. 5.7L; L; 8.5mm High Performance Wire; Equipped with Ceramic Spark Plug Boots	10056
1982-1981	8 Cyl. 5.7L; M; 8.5mm High Performance Wire	10002
1982-1981	8 Cyl. 5.7L; M; 8.5mm High Performance Wire; Equipped with Ceramic Spark Plug Boots	10053
1982-1981	8 Cyl. 5.7L; M; 9.0mm High Performance Wire	10034
1980-1976	8 Cyl. 6.6L; 8.5mm High Performance Wire	10002
1980-1976	8 Cyl. 6.6L; 9.0mm High Performance Wire	10034
1980-1976	8 Cyl. 5.0L; 9.0mm High Performance Wire	10034
1980-1976	8 Cyl. 5.0L; 8.5mm High Performance Wire; Equipped with Ceramic Spark Plug Boots	10053
1980-1976	8 Cyl. 5.0L; 8.5mm High Performance Wire	10002
1980-1976	8 Cyl. 6.6L; 8.5mm High Performance Wire; Equipped with Ceramic Spark Plug Boots	10053
1980-1975	8 Cyl. 5.7L; 9.0mm High Performance Wire	10034
1980-1975	8 Cyl. 5.7L; 8.5mm High Performance Wire; Equipped with Ceramic Spark Plug Boots	10053
1980-1975	8 Cyl. 5.7L; 8.5mm High Performance Wire	10002
1976	8 Cyl. 7.4L; 8.5mm High Performance Wire; Equipped with Ceramic Spark Plug Boots; w/o AC	10069
1976	8 Cyl. 7.4L; 8.5mm High Performance Wire; w/o AC	10001
1975	8 Cyl. 7.4L; 8.5mm High Performance Wire	10001
1975	8 Cyl. 7.4L; 8.5mm High Performance Wire; Equipped with Ceramic Spark Plug Boots	10069
1974	8 Cyl. 5.7L; 8.5mm High Performance Wire; Routed Over Valve Cover	10007
1974	8 Cyl. 5.7L; 8.5mm High Performance Wire; Equipped with Ceramic Spark Plug Boots; Routed Over Valve Cover	10079
1974-1973	8 Cyl. 7.4L; 8.5mm High Performance Wire; Equipped with Ceramic Spark Plug Boots	10114
1974-1973	8 Cyl. 7.4L; 8.5mm High Performance Wire; w/ Straight Non-Bendable Spark Plug Boot	10006
1974-1973	8 Cyl. 7.4L; 8.5mm High Performance Wire; w/ Straight Bendable Spark Plug Boot	10116
1973-1969	8 Cyl. 5.7L; 8.5mm High Performance Wire; Routed Under Exhaust Manifold	10005
1973-1969	8 Cyl. 5.7L; 8.5mm High Performance Wire; Equipped with Ceramic Spark Plug Boots; Routed Under Exhaust Manifold	10080
1973-1968	8 Cyl. 5.0L; 8.5mm High Performance Wire; Routed Under Exhaust Manifold	10005
1973-1968	8 Cyl. 5.0L; 8.5mm High Performance Wire; Equipped with Ceramic Spark Plug Boots; Routed Under Exhaust Manifold	10080

Year	Model/Engine	Part No.
Spark Plug Wire Set		
C20 Suburban		
1972-1970	8 Cyl. 6.6L; 402; 8.5mm High Performance Wire; Equipped with Ceramic Spark Plug Boots	10114
1972-1970	8 Cyl. 6.6L; 8.5mm High Performance Wire; w/ Straight Non-Bendable Spark Plug Boot	10006
1972-1970	8 Cyl. 6.6L; 8.5mm High Performance Wire; w/ Straight Bendable Spark Plug Boot	10116
1969-1968	8 Cyl. 6.5L; 8.5mm High Performance Wire; Equipped with Ceramic Spark Plug Boots	10114
1969-1968	8 Cyl. 6.5L; 8.5mm High Performance Wire; w/ Straight Non-Bendable Spark Plug Boot	10006
1969-1968	8 Cyl. 6.5L; 8.5mm High Performance Wire; w/ Straight Bendable Spark Plug Boot	10116
1968	8 Cyl. 5.4L; 8.5mm High Performance Wire; Routed Under Exhaust Manifold	10005
1968	8 Cyl. 5.4L; 8.5mm High Performance Wire; Equipped with Ceramic Spark Plug Boots; Routed Under Exhaust Manifold	10080
1967-1966	8 Cyl. 5.3L; 8.5mm High Performance Wire; Routed Under Exhaust Manifold	10005
1967-1966	8 Cyl. 5.3L; 8.5mm High Performance Wire; Equipped with Ceramic Spark Plug Boots; Routed Under Exhaust Manifold	10080
1967-1961	8 Cyl. 4.6L; 8.5mm High Performance Wire; Equipped with Ceramic Spark Plug Boots; Routed Under Exhaust Manifold	10080
1967-1961	8 Cyl. 4.6L; 8.5mm High Performance Wire; Routed Under Exhaust Manifold	10005
1965	8 Cyl. 6.7L; 8.5mm High Performance Wire	10008
1965	8 Cyl. 6.7L; 8.5mm High Performance Wire; Equipped with Ceramic Spark Plug Boots	10059
1965	8 Cyl. 5.7L; 8.5mm High Performance Wire	10008
1965	8 Cyl. 5.7L; 8.5mm High Performance Wire; Equipped with Ceramic Spark Plug Boots	10059
1964	8 Cyl. 5.7L; 8.5mm High Performance Wire; Routed Under Exhaust Manifold	10005
1964	8 Cyl. 6.7L; 8.5mm High Performance Wire; Routed Under Exhaust Manifold	10005
1964	8 Cyl. 6.7L; 8.5mm High Performance Wire; Equipped with Ceramic Spark Plug Boots; Routed Under Exhaust Manifold	10080
1964	8 Cyl. 5.7L; 8.5mm High Performance Wire; Equipped with Ceramic Spark Plug Boots; Routed Under Exhaust Manifold	10080
1962	8 Cyl. 6.7L; 8.5mm High Performance Wire; Routed Under Exhaust Manifold	10005
1962	8 Cyl. 6.7L; 8.5mm High Performance Wire; Equipped with Ceramic Spark Plug Boots; Routed Under Exhaust Manifold	10080
1962-1961	8 Cyl. 5.7L; 8.5mm High Performance Wire; Routed Under Exhaust Manifold	10005
1962-1961	8 Cyl. 5.7L; 8.5mm High Performance Wire; Equipped with Ceramic Spark Plug Boots; Routed Under Exhaust Manifold	10080
C30		
1986	8 Cyl. 5.7L; 9.0mm High Performance Wire; Calif.	10037
1986	8 Cyl. 5.0L; 8.5mm High Performance Wire	10010
1986	8 Cyl. 7.4L; 8.5mm High Performance Wire; Calif.	10001

Chevrolet

Wire Sets

Year	Model/Engine	Part No.
Spark Plug Wire Set		
C30		
1986	8 Cyl. 5.7L; 8.5mm High Performance Wire; Calif.; Equipped with Ceramic Spark Plug Boots	10056
1986	8 Cyl. 5.7L; 8.5mm High Performance Wire; Calif.	10010
1986	8 Cyl. 7.4L; 8.5mm High Performance Wire; Fed.	10064
1986	8 Cyl. 7.4L; 8.5mm High Performance Wire; Equipped with Ceramic Spark Plug Boots; Fed.	10065
1986	8 Cyl. 5.0L; 9.0mm High Performance Wire	10037
1986	8 Cyl. 5.7L; 9.0mm High Performance Wire; Fed.	10034
1986	8 Cyl. 5.7L; 8.5mm High Performance Wire; Fed.	10002
1986	8 Cyl. 5.7L; 8.5mm High Performance Wire; Equipped with Ceramic Spark Plug Boots; Fed.	10053
1986	8 Cyl. 5.0L; 8.5mm High Performance Wire; Equipped with Ceramic Spark Plug Boots	10056
1986	8 Cyl. 7.4L; 8.5mm High Performance Wire; Calif.; Equipped with Ceramic Spark Plug Boots	10069
1985	8 Cyl. 7.4L; 8.5mm High Performance Wire; Equipped with Ceramic Spark Plug Boots; w/ Stainless Steel Exhaust Manifold	10065
1985	8 Cyl. 7.4L; 8.5mm High Performance Wire; w/ Stainless Steel Exhaust Manifold	10064
1985	8 Cyl. 5.7L; M; 8.5mm High Performance Wire	10002
1985	8 Cyl. 5.7L; M; 9.0mm High Performance Wire	10034
1985	8 Cyl. 5.7L; M; 8.5mm High Performance Wire; Equipped with Ceramic Spark Plug Boots; w/ Cast Iron Exhaust Manifold	10056
1985	8 Cyl. 5.7L; M; 8.5mm High Performance Wire; Equipped with Ceramic Spark Plug Boots	10053
1985	8 Cyl. 5.7L; M; 8.5mm High Performance Wire; w/ Cast Iron Exhaust Manifold	10010
1985	8 Cyl. 5.7L; M; 9.0mm High Performance Wire; w/ Cast Iron Exhaust Manifold	10037
1985-1977	8 Cyl. 7.4L; 8.5mm High Performance Wire	10001
1985-1977	8 Cyl. 7.4L; 8.5mm High Performance Wire; Equipped with Ceramic Spark Plug Boots	10069
1984-1983	8 Cyl. 5.7L; 9.0mm High Performance Wire	10037
1984-1983	8 Cyl. 5.7L; 8.5mm High Performance Wire	10010
1984-1983	8 Cyl. 5.7L; 8.5mm High Performance Wire; Equipped with Ceramic Spark Plug Boots	10056
1982	8 Cyl. 5.7L; M; 8.5mm High Performance Wire	10002
1982	8 Cyl. 5.7L; M; 9.0mm High Performance Wire	10034
1982	8 Cyl. 5.7L; M; 8.5mm High Performance Wire; Equipped with Ceramic Spark Plug Boots	10053
1981-1975	8 Cyl. 5.7L; 9.0mm High Performance Wire	10034
1981-1975	8 Cyl. 5.7L; 8.5mm High Performance Wire	10002

Year	Model/Engine	Part No.
Spark Plug Wire Set		
C30		
1981-1975	8 Cyl. 5.7L; 8.5mm High Performance Wire; Equipped with Ceramic Spark Plug Boots	10053
1979-1978	8 Cyl. 5.0L; 9.0mm High Performance Wire	10034
1979-1978	8 Cyl. 5.0L; 8.5mm High Performance Wire	10002
1979-1978	8 Cyl. 5.0L; 8.5mm High Performance Wire; Equipped with Ceramic Spark Plug Boots	10053
1979-1976	8 Cyl. 6.6L; 8.5mm High Performance Wire; Equipped with Ceramic Spark Plug Boots	10053
1979-1976	8 Cyl. 6.6L; 8.5mm High Performance Wire	10002
1979-1976	8 Cyl. 6.6L; 9.0mm High Performance Wire	10034
1976	8 Cyl. 7.4L; 8.5mm High Performance Wire; w/o AC	10001
1976	8 Cyl. 7.4L; 8.5mm High Performance Wire; Equipped with Ceramic Spark Plug Boots; w/o AC	10069
1975	8 Cyl. 7.4L; 8.5mm High Performance Wire	10001
1975	8 Cyl. 7.4L; 8.5mm High Performance Wire; Equipped with Ceramic Spark Plug Boots	10069
C30 Pickup		
1974	8 Cyl. 5.7L; 8.5mm High Performance Wire; Equipped with Ceramic Spark Plug Boots; Routed Over Valve Cover	10079
1974	8 Cyl. 5.7L; 8.5mm High Performance Wire; Routed Over Valve Cover	10007
1974-1973	8 Cyl. 7.4L; 8.5mm High Performance Wire; w/ Straight Non-Bendable Spark Plug Boot	10006
1974-1973	8 Cyl. 7.4L; 8.5mm High Performance Wire; Equipped with Ceramic Spark Plug Boots	10114
1974-1973	8 Cyl. 7.4L; 8.5mm High Performance Wire; w/ Straight Bendable Spark Plug Boot	10116
1973-1969	8 Cyl. 5.7L; 8.5mm High Performance Wire; Routed Under Exhaust Manifold	10005
1973-1969	8 Cyl. 5.7L; 8.5mm High Performance Wire; Equipped with Ceramic Spark Plug Boots; Routed Under Exhaust Manifold	10080
1973-1968	8 Cyl. 5.0L; 8.5mm High Performance Wire; Routed Under Exhaust Manifold	10005
1973-1968	8 Cyl. 5.0L; 8.5mm High Performance Wire; Equipped with Ceramic Spark Plug Boots; Routed Under Exhaust Manifold	10080
1972-1970	8 Cyl. 6.6L; 8.5mm High Performance Wire; w/ Straight Non-Bendable Spark Plug Boot	10006
1972-1970	8 Cyl. 6.6L; 8.5mm High Performance Wire; Equipped with Ceramic Spark Plug Boots	10114
1972-1970	8 Cyl. 6.6L; 8.5mm High Performance Wire; w/ Straight Bendable Spark Plug Boot	10116
1969-1968	8 Cyl. 6.5L; 8.5mm High Performance Wire; Equipped with Ceramic Spark Plug Boots	10114
1969-1968	8 Cyl. 6.5L; 8.5mm High Performance Wire; w/ Straight Non-Bendable Spark Plug Boot	10006
1969-1968	8 Cyl. 6.5L; 8.5mm High Performance Wire; w/ Straight Bendable Spark Plug Boot	10116

Wire Sets

Year	Model/Engine	Part No.
Spark Plug Wire Set		
C30 Pickup		
1968	8 Cyl. 5.4L; 8.5mm High Performance Wire; Routed Under Exhaust Manifold	10005
1968	8 Cyl. 5.4L; 8.5mm High Performance Wire; Equipped with Ceramic Spark Plug Boots; Routed Under Exhaust Manifold	10080
1967-1966	8 Cyl. 5.3L; 8.5mm High Performance Wire; Routed Under Exhaust Manifold	10005
1967-1966	8 Cyl. 5.3L; 8.5mm High Performance Wire; Equipped with Ceramic Spark Plug Boots; Routed Under Exhaust Manifold	10080
1967-1961	8 Cyl. 4.6L; 8.5mm High Performance Wire; Equipped with Ceramic Spark Plug Boots; Routed Under Exhaust Manifold	10080
1967-1961	8 Cyl. 4.6L; 8.5mm High Performance Wire; Routed Under Exhaust Manifold	10005
1965	8 Cyl. 6.7L; 8.5mm High Performance Wire	10008
1965	8 Cyl. 6.7L; 8.5mm High Performance Wire; Equipped with Ceramic Spark Plug Boots	10059
1965	8 Cyl. 5.7L; 8.5mm High Performance Wire	10008
1965	8 Cyl. 5.7L; 8.5mm High Performance Wire; Equipped with Ceramic Spark Plug Boots	10059
1964	8 Cyl. 5.7L; 8.5mm High Performance Wire; Equipped with Ceramic Spark Plug Boots; Routed Under Exhaust Manifold	10080
1964	8 Cyl. 5.7L; 8.5mm High Performance Wire; Routed Under Exhaust Manifold	10005
1964	8 Cyl. 6.7L; 8.5mm High Performance Wire; Routed Under Exhaust Manifold	10005
1964	8 Cyl. 6.7L; 8.5mm High Performance Wire; Equipped with Ceramic Spark Plug Boots; Routed Under Exhaust Manifold	10080
1962	8 Cyl. 6.7L; 8.5mm High Performance Wire; Routed Under Exhaust Manifold	10005
1962	8 Cyl. 6.7L; 8.5mm High Performance Wire; Equipped with Ceramic Spark Plug Boots; Routed Under Exhaust Manifold	10080
1962-1961	8 Cyl. 5.7L; 8.5mm High Performance Wire; Equipped with Ceramic Spark Plug Boots; Routed Under Exhaust Manifold	10080
1962-1961	8 Cyl. 5.7L; 8.5mm High Performance Wire; Routed Under Exhaust Manifold	10005
C35		
2000-1996	8 Cyl. 5.7L; 8.5mm High Performance Wire	10021
2000-1996	8 Cyl. 5.7L; 8.5mm High Performance Wire; Equipped with Ceramic Spark Plug Boots	10072
1995	8 Cyl. 5.7L; 9.0mm High Performance Wire	10038
1995	8 Cyl. 5.7L; 8.5mm High Performance Wire	10018
1995	8 Cyl. 5.7L; 8.5mm High Performance Wire; Equipped with Ceramic Spark Plug Boots	10046
C50		
1990	8 Cyl. 6.0L; 8.5mm High Performance Wire; Carb.; Equipped with Ceramic Spark Plug Boots	10065
1990	8 Cyl. 6.0L; 8.5mm High Performance Wire; Carb.	10064
1989-1986	8 Cyl. 6.0L; 8.5mm High Performance Wire; Equipped with Ceramic Spark Plug Boots	10065
1989-1986	8 Cyl. 6.0L; 8.5mm High Performance Wire	10064

Year	Model/Engine	Part No.
Spark Plug Wire Set		
C50		
1988-1986	8 Cyl. 7.0L; 8.5mm High Performance Wire; Equipped with Ceramic Spark Plug Boots	10065
1988-1986	8 Cyl. 7.0L; 8.5mm High Performance Wire	10064
C60		
1990	8 Cyl. 6.0L; 8.5mm High Performance Wire	10064
1990	8 Cyl. 6.0L; 8.5mm High Performance Wire; Equipped with Ceramic Spark Plug Boots	10065
1990-1986	8 Cyl. 7.0L; 8.5mm High Performance Wire; Equipped with Ceramic Spark Plug Boots	10065
1990-1986	8 Cyl. 7.0L; 8.5mm High Performance Wire	10064
1989	8 Cyl. 6.0L; 8.5mm High Performance Wire; Carb.; Equipped with Ceramic Spark Plug Boots	10065
1989	8 Cyl. 6.0L; 8.5mm High Performance Wire; Carb.	10064
1988-1986	8 Cyl. 6.0L; 8.5mm High Performance Wire	10064
1988-1986	8 Cyl. 6.0L; 8.5mm High Performance Wire; Equipped with Ceramic Spark Plug Boots	10065
1985-1980	8 Cyl. 6.0L; 8.5mm High Performance Wire; Equipped with Ceramic Spark Plug Boots	10069
1985-1980	8 Cyl. 6.0L; 8.5mm High Performance Wire	10001
C60 Kodiak		
1996-1990	8 Cyl. 6.0L; 8.5mm High Performance Wire	10064
1996-1990	8 Cyl. 7.0L; 8.5mm High Performance Wire; Equipped with Ceramic Spark Plug Boots	10065
1996-1990	8 Cyl. 7.0L; 8.5mm High Performance Wire	10064
1996-1990	8 Cyl. 6.0L; 8.5mm High Performance Wire; Equipped with Ceramic Spark Plug Boots	10065
C70		
1990-1989	8 Cyl. 6.0L; 8.5mm High Performance Wire; Carb.; Equipped with Ceramic Spark Plug Boots	10065
1990-1989	8 Cyl. 6.0L; 8.5mm High Performance Wire; Carb.	10064
1989-1986	8 Cyl. 7.0L; 8.5mm High Performance Wire	10064
1989-1986	8 Cyl. 7.0L; 8.5mm High Performance Wire; Equipped with Ceramic Spark Plug Boots	10065
1988-1986	8 Cyl. 6.0L; 8.5mm High Performance Wire; Equipped with Ceramic Spark Plug Boots	10065
1988-1986	8 Cyl. 6.0L; 8.5mm High Performance Wire	10064
1985-1980	8 Cyl. 6.0L; 8.5mm High Performance Wire; Equipped with Ceramic Spark Plug Boots	10069
1985-1980	8 Cyl. 7.0L; 8.5mm High Performance Wire	10001
1985-1980	8 Cyl. 7.0L; 8.5mm High Performance Wire; Equipped with Ceramic Spark Plug Boots	10069
1985-1980	8 Cyl. 6.0L; 8.5mm High Performance Wire	10001
1980	8 Cyl. 7.4L; 8.5mm High Performance Wire	10001

Chevrolet

Wire Sets

Year	Model/Engine	Part No.
Spark Plug Wire Set		
C70		
1980	8 Cyl. 7.4L; 8.5mm High Performance Wire; Equipped with Ceramic Spark Plug Boots	10069
C70 Kodiak		
1990	8 Cyl. 6.0L; 8.5mm High Performance Wire; Carb.; Equipped with Ceramic Spark Plug Boots	10065
1990	8 Cyl. 6.0L; 8.5mm High Performance Wire; Carb.	10064
C1500		
1999	8 Cyl. 5.7L; 8.5mm High Performance Wire	10021
1999	8 Cyl. 5.7L; 8.5mm High Performance Wire; Equipped with Ceramic Spark Plug Boots	10072
1999-1996	8 Cyl. 5.0L; 8.5mm High Performance Wire; Equipped with Ceramic Spark Plug Boots	10072
1999-1996	8 Cyl. 5.0L; 8.5mm High Performance Wire	10021
1998	8 Cyl. 5.7L; 8.5mm High Performance Wire	10021
1998	8 Cyl. 5.7L; 8.5mm High Performance Wire; Equipped with Ceramic Spark Plug Boots	10072
1998-1997	6 Cyl. 4.3L; 8.5mm High Performance Wire; Equipped with Ceramic Spark Plug Boots	10078
1998-1997	6 Cyl. 4.3L; 8.5mm High Performance Wire	10077
1997	8 Cyl. 5.7L; 8.5mm High Performance Wire	10021
1997	8 Cyl. 5.7L; 8.5mm High Performance Wire; Equipped with Ceramic Spark Plug Boots	10072
1996	8 Cyl. 5.7L; 8.5mm High Performance Wire	10021
1996	8 Cyl. 5.7L; 8.5mm High Performance Wire; Equipped with Ceramic Spark Plug Boots	10072
1996	6 Cyl. 4.3L; 8.5mm High Performance Wire	10077
1996	6 Cyl. 4.3L; 8.5mm High Performance Wire; Equipped with Ceramic Spark Plug Boots	10078
1995	8 Cyl. 5.0L; 9.0mm High Performance Wire	10038
1995	8 Cyl. 5.7L; 8.5mm High Performance Wire; Equipped with Ceramic Spark Plug Boots	10046
1995	8 Cyl. 5.7L; 9.0mm High Performance Wire	10038
1995	8 Cyl. 5.0L; 8.5mm High Performance Wire	10018
1995	8 Cyl. 5.0L; 8.5mm High Performance Wire; Equipped with Ceramic Spark Plug Boots	10046
1995	6 Cyl. 4.3L; 8.5mm High Performance Wire; Equipped with Ceramic Spark Plug Boots	10076
1995	8 Cyl. 5.7L; 8.5mm High Performance Wire	10018
1995	6 Cyl. 4.3L; 8.5mm High Performance Wire	10014
1994	8 Cyl. 5.0L; 8.5mm High Performance Wire	10018
1994	8 Cyl. 5.0L; 8.5mm High Performance Wire; Equipped with Ceramic Spark Plug Boots	10046

Year	Model/Engine	Part No.
Spark Plug Wire Set		
C1500		
1994	8 Cyl. 5.0L; 9.0mm High Performance Wire	10038
1994-1993	8 Cyl. 5.7L; 9.0mm High Performance Wire	10038
1994-1993	8 Cyl. 5.7L; 8.5mm High Performance Wire; Equipped with Ceramic Spark Plug Boots	10046
1994-1993	6 Cyl. 4.3L; 8.5mm High Performance Wire	10014
1994-1993	8 Cyl. 5.7L; 8.5mm High Performance Wire	10018
1994-1993	6 Cyl. 4.3L; 8.5mm High Performance Wire; Equipped with Ceramic Spark Plug Boots	10076
1993	8 Cyl. 7.4L; 8.5mm High Performance Wire	10050
1993	8 Cyl. 7.4L; 8.5mm High Performance Wire; Equipped with Ceramic Spark Plug Boots	10051
1993-1988	8 Cyl. 5.0L; 9.0mm High Performance Wire	10038
1993-1988	8 Cyl. 5.0L; 8.5mm High Performance Wire	10018
1993-1988	8 Cyl. 5.0L; 8.5mm High Performance Wire; Equipped with Ceramic Spark Plug Boots	10046
1992-1991	8 Cyl. 5.7L; 8.5mm High Performance Wire; Equipped with Ceramic Spark Plug Boots	10046
1992-1991	8 Cyl. 5.7L; 9.0mm High Performance Wire	10038
1992-1991	8 Cyl. 5.7L; 8.5mm High Performance Wire	10018
1992-1990	8 Cyl. 7.4L; 8.5mm High Performance Wire; Equipped with Ceramic Spark Plug Boots	10051
1992-1990	8 Cyl. 7.4L; 8.5mm High Performance Wire	10050
1992-1989	6 Cyl. 4.3L; 8.5mm High Performance Wire; Equipped with Ceramic Spark Plug Boots	10076
1992-1989	6 Cyl. 4.3L; 8.5mm High Performance Wire	10014
1990-1988	8 Cyl. 5.7L; 9.0mm High Performance Wire	10038
1990-1988	8 Cyl. 5.7L; 8.5mm High Performance Wire; Equipped with Ceramic Spark Plug Boots	10046
1990-1988	8 Cyl. 5.7L; 8.5mm High Performance Wire	10018
1988	6 Cyl. 4.3L; 8.5mm High Performance Wire	10014
1988	6 Cyl. 4.3L; 8.5mm High Performance Wire; Equipped with Ceramic Spark Plug Boots	10076
C1500 Suburban		
1999-1996	8 Cyl. 5.7L; 8.5mm High Performance Wire	10021
1999-1996	8 Cyl. 5.7L; 8.5mm High Performance Wire; Equipped with Ceramic Spark Plug Boots	10072
1995-1992	8 Cyl. 5.7L; 9.0mm High Performance Wire	10038
1995-1992	8 Cyl. 5.7L; 8.5mm High Performance Wire	10018
1995-1992	8 Cyl. 5.7L; 8.5mm High Performance Wire; Equipped with Ceramic Spark Plug Boots	10046

Wire Sets

Year	Model/Engine	Part No.
Spark Plug Wire Set		
C2500		
2000	8 Cyl. 7.4L; 8.5mm High Performance Wire; Equipped with Ceramic Spark Plug Boots	10071
2000	8 Cyl. 5.7L; 8.5mm High Performance Wire; Equipped with Ceramic Spark Plug Boots	10072
2000	8 Cyl. 5.7L; 8.5mm High Performance Wire	10021
2000	8 Cyl. 7.4L; 8.5mm High Performance Wire	10070
1999	8 Cyl. 7.4L; 8.5mm High Performance Wire	10070
1999	8 Cyl. 5.7L; 8.5mm High Performance Wire; Equipped with Ceramic Spark Plug Boots	10072
1999	8 Cyl. 5.7L; 8.5mm High Performance Wire	10021
1999	8 Cyl. 7.4L; 8.5mm High Performance Wire; Equipped with Ceramic Spark Plug Boots	10071
1998	8 Cyl. 5.7L; 8.5mm High Performance Wire; Equipped with Ceramic Spark Plug Boots	10072
1998	8 Cyl. 5.7L; 8.5mm High Performance Wire	10021
1998	8 Cyl. 5.0L; 8.5mm High Performance Wire	10021
1998	8 Cyl. 5.0L; 8.5mm High Performance Wire; Equipped with Ceramic Spark Plug Boots	10072
1998-1997	8 Cyl. 7.4L; 8.5mm High Performance Wire; Equipped with Ceramic Spark Plug Boots	10071
1998-1997	8 Cyl. 7.4L; 8.5mm High Performance Wire	10070
1997-1996	8 Cyl. 5.7L; 8.5mm High Performance Wire; Equipped with Ceramic Spark Plug Boots	10072
1997-1996	8 Cyl. 5.0L; 8.5mm High Performance Wire; Equipped with Ceramic Spark Plug Boots	10072
1997-1996	8 Cyl. 5.7L; 8.5mm High Performance Wire	10021
1997-1996	8 Cyl. 5.0L; 8.5mm High Performance Wire	10021
1996	8 Cyl. 7.4L; 8.5mm High Performance Wire	10070
1996	8 Cyl. 7.4L; 8.5mm High Performance Wire; Equipped with Ceramic Spark Plug Boots	10071
1995	8 Cyl. 5.7L; 9.0mm High Performance Wire	10038
1995	8 Cyl. 7.4L; 8.5mm High Performance Wire	10050
1995	8 Cyl. 5.7L; 8.5mm High Performance Wire; Equipped with Ceramic Spark Plug Boots	10046
1995	8 Cyl. 5.7L; 8.5mm High Performance Wire	10018
1995	8 Cyl. 7.4L; 8.5mm High Performance Wire; Equipped with Ceramic Spark Plug Boots	10051
1995-1994	6 Cyl. 4.3L; 8.5mm High Performance Wire	10014
1995-1994	8 Cyl. 5.0L; 8.5mm High Performance Wire; Equipped with Ceramic Spark Plug Boots	10046
1995-1994	8 Cyl. 5.0L; 8.5mm High Performance Wire	10018

Year	Model/Engine	Part No.
Spark Plug Wire Set		
C2500		
1995-1994	6 Cyl. 4.3L; 8.5mm High Performance Wire; Equipped with Ceramic Spark Plug Boots	10076
1995-1994	8 Cyl. 5.0L; 9.0mm High Performance Wire	10038
1994	8 Cyl. 5.7L; 9.0mm High Performance Wire	10038
1994	8 Cyl. 5.7L; 8.5mm High Performance Wire; Equipped with Ceramic Spark Plug Boots	10046
1994	8 Cyl. 5.7L; 8.5mm High Performance Wire	10018
1994-1993	8 Cyl. 7.4L; 8.5mm High Performance Wire; Equipped with Ceramic Spark Plug Boots	10051
1994-1993	8 Cyl. 7.4L; 8.5mm High Performance Wire	10050
1993	6 Cyl. 4.3L; 8.5mm High Performance Wire	10014
1993	8 Cyl. 5.7L; 9.0mm High Performance Wire	10038
1993	6 Cyl. 4.3L; 8.5mm High Performance Wire; Equipped with Ceramic Spark Plug Boots	10076
1993	8 Cyl. 5.0L; 8.5mm High Performance Wire	10018
1993	8 Cyl. 5.0L; 8.5mm High Performance Wire; Equipped with Ceramic Spark Plug Boots	10046
1993	8 Cyl. 5.7L; 8.5mm High Performance Wire; Equipped with Ceramic Spark Plug Boots	10046
1993	8 Cyl. 5.7L; 8.5mm High Performance Wire	10018
1993	8 Cyl. 5.0L; 9.0mm High Performance Wire	10038
1992	6 Cyl. 4.3L; 8.5mm High Performance Wire	10014
1992	8 Cyl. 5.7L; 9.0mm High Performance Wire	10038
1992	8 Cyl. 5.7L; 8.5mm High Performance Wire; Equipped with Ceramic Spark Plug Boots	10046
1992	6 Cyl. 4.3L; 8.5mm High Performance Wire; Equipped with Ceramic Spark Plug Boots	10076
1992	8 Cyl. 5.7L; 8.5mm High Performance Wire	10018
1992-1991	8 Cyl. 7.4L; 8.5mm High Performance Wire	10050
1992-1991	8 Cyl. 7.4L; 8.5mm High Performance Wire; Equipped with Ceramic Spark Plug Boots	10051
1992-1990	8 Cyl. 5.0L; 8.5mm High Performance Wire; Equipped with Ceramic Spark Plug Boots	10046
1992-1990	8 Cyl. 5.0L; 8.5mm High Performance Wire	10018
1992-1990	8 Cyl. 5.0L; 9.0mm High Performance Wire	10038
1991	8 Cyl. 5.7L; 9.0mm High Performance Wire	10038
1991	8 Cyl. 5.7L; 8.5mm High Performance Wire; Equipped with Ceramic Spark Plug Boots	10046
1991	8 Cyl. 5.7L; 8.5mm High Performance Wire	10018
1991-1989	6 Cyl. 4.3L; 8.5mm High Performance Wire	10014

Chevrolet

Wire Sets

Year	Model/Engine	Part No.
Spark Plug Wire Set		
C2500		
1991-1989	6 Cyl. 4.3L; 8.5mm High Performance Wire; Equipped with Ceramic Spark Plug Boots	10076
1990-1989	8 Cyl. 5.7L; 9.0mm High Performance Wire	10038
1990-1989	8 Cyl. 5.7L; 8.5mm High Performance Wire; Equipped with Ceramic Spark Plug Boots	10046
1990-1989	8 Cyl. 5.7L; 8.5mm High Performance Wire	10018
1989-1988	8 Cyl. 5.0L; 8.5mm High Performance Wire	10018
1989-1988	8 Cyl. 5.0L; 8.5mm High Performance Wire; Equipped with Ceramic Spark Plug Boots	10046
1989-1988	8 Cyl. 5.0L; 9.0mm High Performance Wire	10038
1988	6 Cyl. 4.3L; 8.5mm High Performance Wire	10014
1988	8 Cyl. 5.7L; 9.0mm High Performance Wire	10038
1988	6 Cyl. 4.3L; 8.5mm High Performance Wire; Equipped with Ceramic Spark Plug Boots	10076
1988	8 Cyl. 5.7L; 8.5mm High Performance Wire; Equipped with Ceramic Spark Plug Boots	10046
1988	8 Cyl. 5.7L; 8.5mm High Performance Wire	10018
C2500 Suburban		
1999-1996	8 Cyl. 5.7L; 8.5mm High Performance Wire; Equipped with Ceramic Spark Plug Boots	10072
1999-1996	8 Cyl. 5.7L; 8.5mm High Performance Wire	10021
1999-1995	8 Cyl. 7.4L; 8.5mm High Performance Wire	10070
1999-1995	8 Cyl. 7.4L; 8.5mm High Performance Wire; Equipped with Ceramic Spark Plug Boots	10071
1995-1992	8 Cyl. 7.4L; 8.5mm High Performance Wire	10050
1995-1992	8 Cyl. 5.7L; 8.5mm High Performance Wire	10018
1995-1992	8 Cyl. 5.7L; 8.5mm High Performance Wire; Equipped with Ceramic Spark Plug Boots	10046
1995-1992	8 Cyl. 5.7L; 9.0mm High Performance Wire	10038
1995-1992	8 Cyl. 7.4L; 8.5mm High Performance Wire; Equipped with Ceramic Spark Plug Boots	10051
C3500		
2000-1996	8 Cyl. 5.7L; 8.5mm High Performance Wire; Equipped with Ceramic Spark Plug Boots	10072
2000-1996	8 Cyl. 7.4L; 8.5mm High Performance Wire	10070
2000-1996	8 Cyl. 7.4L; 8.5mm High Performance Wire; Equipped with Ceramic Spark Plug Boots	10071
2000-1996	8 Cyl. 5.7L; 8.5mm High Performance Wire	10021
1995-1991	8 Cyl. 7.4L; 8.5mm High Performance Wire; Equipped with Ceramic Spark Plug Boots	10051
1995-1991	8 Cyl. 7.4L; 8.5mm High Performance Wire	10050
1995-1988	8 Cyl. 5.7L; 8.5mm High Performance Wire	10018

Year	Model/Engine	Part No.
Spark Plug Wire Set		
C3500		
1995-1988	8 Cyl. 5.7L; 9.0mm High Performance Wire	10038
1995-1988	8 Cyl. 5.7L; 8.5mm High Performance Wire; Equipped with Ceramic Spark Plug Boots	10046
1990	8 Cyl. 7.4L; 8.5mm High Performance Wire	10048
1990	8 Cyl. 7.4L; 8.5mm High Performance Wire; Equipped with Ceramic Spark Plug Boots	10049
1989-1988	8 Cyl. 7.4L; 8.5mm High Performance Wire; Equipped with Ceramic Spark Plug Boots	10051
1989-1988	8 Cyl. 7.4L; 8.5mm High Performance Wire	10050
C3500HD		
2000-1996	8 Cyl. 7.4L; 8.5mm High Performance Wire	10070
2000-1996	8 Cyl. 7.4L; 8.5mm High Performance Wire; Equipped with Ceramic Spark Plug Boots	10071
1995-1991	8 Cyl. 5.7L; 8.5mm High Performance Wire	10018
1995-1991	8 Cyl. 5.7L; 9.0mm High Performance Wire	10038
1995-1991	8 Cyl. 7.4L; 8.5mm High Performance Wire; Equipped with Ceramic Spark Plug Boots	10051
1995-1991	8 Cyl. 7.4L; 8.5mm High Performance Wire	10050
1995-1991	8 Cyl. 5.7L; 8.5mm High Performance Wire; Equipped with Ceramic Spark Plug Boots	10046
C5500 Kodiak		
1990	8 Cyl. 6.0L; 8.5mm High Performance Wire; Carb.; Equipped with Ceramic Spark Plug Boots	10065
1990	8 Cyl. 6.0L; 8.5mm High Performance Wire; Carb.	10064
C6500 Kodiak		
2000-1999	8 Cyl. 7.4L; 8.5mm High Performance Wire; Equipped with Ceramic Spark Plug Boots	10075
2000-1999	8 Cyl. 7.4L; 8.5mm High Performance Wire	10074
1998-1997	8 Cyl. 7.0L; 8.5mm High Performance Wire; Equipped with Ceramic Spark Plug Boots	10065
1998-1997	8 Cyl. 6.0L; 8.5mm High Performance Wire; Equipped with Ceramic Spark Plug Boots	10065
1998-1997	8 Cyl. 6.0L; 8.5mm High Performance Wire	10064
1998-1997	8 Cyl. 7.0L; 8.5mm High Performance Wire	10064
C7500 Kodiak		
2000-1999	8 Cyl. 7.4L; 8.5mm High Performance Wire	10074
2000-1999	8 Cyl. 7.4L; 8.5mm High Performance Wire; Equipped with Ceramic Spark Plug Boots	10075
Camaro		
2012-2010	8 Cyl. 6.2L; 8.5mm High Performance Wire	10026
2012-2010	8 Cyl. 6.2L; 9.0mm High Performance Wire	10039
2002-2000	6 Cyl. 3.8L; 8.5mm High Performance Wire	10023

Wire Sets

Year	Model/Engine	Part No.
Spark Plug Wire Set		
Camaro		
2002-1998	8 Cyl. 5.7L; 8.5mm High Performance Wire	10026
2002-1998	8 Cyl. 5.7L; 9.0mm High Performance Wire	10039
1999-1995	6 Cyl. 3.8L; 8.5mm High Performance Wire	10022
1997-1995	8 Cyl. 5.7L; 8.5mm High Performance Wire	10033
1994-1993	8 Cyl. 5.7L; 8.5mm High Performance Wire	10033
1989-1982	6 Cyl. 2.8L; 8.5mm High Performance Wire	10057
1989-1982	6 Cyl. 2.8L; 8.5mm High Performance Wire; Equipped with Ceramic Spark Plug Boots	10058
1986-1985	8 Cyl. 5.0L; 8.5mm High Performance Wire; Carb.; Equipped with Ceramic Spark Plug Boots	10056
1986-1985	8 Cyl. 5.0L; 9.0mm High Performance Wire; Carb.	10037
1986-1985	8 Cyl. 5.0L; 8.5mm High Performance Wire; Carb.	10010
1984-1982	8 Cyl. 5.0L; 8.5mm High Performance Wire; Equipped with Ceramic Spark Plug Boots	10056
1984-1982	8 Cyl. 5.0L; 9.0mm High Performance Wire	10037
1984-1982	8 Cyl. 5.0L; 8.5mm High Performance Wire	10010
1981	8 Cyl. 4.4L; 9.0mm High Performance Wire; U.S. Models	10034
1981	8 Cyl. 4.4L; 8.5mm High Performance Wire; U.S. Models	10002
1981	8 Cyl. 5.0L; 9.0mm High Performance Wire; Canada	10034
1981	8 Cyl. 4.4L; 9.0mm High Performance Wire; Canada	10034
1981	8 Cyl. 5.0L; 8.5mm High Performance Wire; U.S. Models	10002
1981	8 Cyl. 4.4L; 8.5mm High Performance Wire; Canada	10002
1981	8 Cyl. 5.0L; 8.5mm High Performance Wire; Canada	10002
1981	8 Cyl. 5.0L; 9.0mm High Performance Wire; U.S. Models	10034
1981-1980	8 Cyl. 4.4L; 8.5mm High Performance Wire; Equipped with Ceramic Spark Plug Boots	10053
1981-1976	8 Cyl. 5.0L; 8.5mm High Performance Wire; Equipped with Ceramic Spark Plug Boots	10053
1981-1975	8 Cyl. 5.7L; 8.5mm High Performance Wire	10002
1981-1975	8 Cyl. 5.7L; 8.5mm High Performance Wire; Equipped with Ceramic Spark Plug Boots	10053
1981-1975	8 Cyl. 5.7L; 9.0mm High Performance Wire	10034
1980	8 Cyl. 5.0L; 9.0mm High Performance Wire; Calif.	10034
1980	8 Cyl. 5.0L; 8.5mm High Performance Wire; Calif.	10002
1980	8 Cyl. 5.0L; 8.5mm High Performance Wire; Fed.	10002
1980	8 Cyl. 4.4L; 8.5mm High Performance Wire	10002
1980	8 Cyl. 4.4L; 9.0mm High Performance Wire	10034
1980	8 Cyl. 5.0L; 9.0mm High Performance Wire; Fed.	10034

Year	Model/Engine	Part No.
Spark Plug Wire Set		
Camaro		
1979-1976	8 Cyl. 5.0L; 8.5mm High Performance Wire	10002
1979-1976	8 Cyl. 5.0L; 9.0mm High Performance Wire	10034
1974	8 Cyl. 5.7L; 8.5mm High Performance Wire; Exc. High Energy Ignition; Routed Over Valve Cover	10007
1974	8 Cyl. 5.7L; 9.0mm High Performance Wire; w/ High Energy Ignition	10034
1974	8 Cyl. 5.7L; 8.5mm High Performance Wire; Equipped with Ceramic Spark Plug Boots; High Energy Ignition	10053
1974	8 Cyl. 5.7L; 8.5mm High Performance Wire; Equipped with Ceramic Spark Plug Boots; Exc. High Energy Ignition; Routed Over Valve Cover	10079
1974	8 Cyl. 5.7L; 8.5mm High Performance Wire; w/ High Energy Ignition	10002
1973-1971	8 Cyl. 5.7L; 8.5mm High Performance Wire; Equipped with Ceramic Spark Plug Boots; Routed Over Valve Cover	10079
1973-1971	8 Cyl. 5.7L; 8.5mm High Performance Wire; Routed Over Valve Cover	10007
1973-1968	8 Cyl. 5.0L; 8.5mm High Performance Wire; Equipped with Ceramic Spark Plug Boots; Routed Over Valve Cover	10079
1973-1968	8 Cyl. 5.0L; 8.5mm High Performance Wire; Routed Over Valve Cover	10007
1972-1970	8 Cyl. 6.6L; 402; 8.5mm High Performance Wire; Equipped with Ceramic Spark Plug Boots	10114
1972-1970	8 Cyl. 6.6L; 402; 8.5mm High Performance Wire; w/ Straight Non-Bendable Spark Plug Boot	10006
1972-1970	8 Cyl. 6.6L; 402; 8.5mm High Performance Wire; w/ Straight Bendable Spark Plug Boot	10116
1970	8 Cyl. 5.7L; 8.5mm High Performance Wire; Equipped with Ceramic Spark Plug Boots; Routed Under Exhaust Manifold	10080
1970	8 Cyl. 5.7L; 8.5mm High Performance Wire; Routed Under Exhaust Manifold	10005
1970-1968	8 Cyl. 6.5L; 8.5mm High Performance Wire; Equipped with Ceramic Spark Plug Boots	10114
1970-1968	8 Cyl. 6.5L; 8.5mm High Performance Wire; w/ Straight Non-Bendable Spark Plug Boot	10006
1970-1968	8 Cyl. 6.5L; 8.5mm High Performance Wire; w/ Straight Bendable Spark Plug Boot	10116
1969	8 Cyl. 7.0L; 8.5mm High Performance Wire; Equipped with Ceramic Spark Plug Boots	10114
1969	8 Cyl. 7.0L; 8.5mm High Performance Wire; w/ Straight Non-Bendable Spark Plug Boot	10006
1969	8 Cyl. 7.0L; 8.5mm High Performance Wire; w/ Straight Bendable Spark Plug Boot	10116
1969-1968	8 Cyl. 5.7L; 8.5mm High Performance Wire; Equipped with Ceramic Spark Plug Boots; Routed Over Valve Cover	10079
1969-1968	8 Cyl. 5.4L; 8.5mm High Performance Wire; Routed Over Valve Cover	10007
1969-1968	8 Cyl. 5.4L; 8.5mm High Performance Wire; Equipped with Ceramic Spark Plug Boots; Routed Over Valve Cover	10079
1969-1968	8 Cyl. 5.7L; 8.5mm High Performance Wire; Routed Over Valve Cover	10007

Chevrolet

Wire Sets

Year	Model/Engine	Part No.
Spark Plug Wire Set		
Camaro		
1969-1968	8 Cyl. 4.9L; 8.5mm High Performance Wire; Equipped with Ceramic Spark Plug Boots; Routed Over Valve Cover	10079
1969-1968	8 Cyl. 4.9L; 8.5mm High Performance Wire; Routed Over Valve Cover	10007
1967	8 Cyl. 6.5L; 8.5mm High Performance Wire; w/ Straight Non-Bendable Spark Plug Boot	10006
1967	8 Cyl. 5.3L; 8.5mm High Performance Wire; Equipped with Ceramic Spark Plug Boots; Routed Under Exhaust Manifold	10080
1967	8 Cyl. 5.7L; 8.5mm High Performance Wire; Routed Over Valve Cover	10007
1967	8 Cyl. 5.7L; 8.5mm High Performance Wire; Equipped with Ceramic Spark Plug Boots; Routed Over Valve Cover	10079
1967	8 Cyl. 6.5L; 8.5mm High Performance Wire; Equipped with Ceramic Spark Plug Boots	10114
1967	8 Cyl. 5.3L; 8.5mm High Performance Wire; Routed Under Exhaust Manifold	10005
1967	8 Cyl. 6.5L; 8.5mm High Performance Wire; w/ Straight Bendable Spark Plug Boot	10116
1967	8 Cyl. 4.9L; 8.5mm High Performance Wire; Equipped with Ceramic Spark Plug Boots; Routed Over Valve Cover	10079
1967	8 Cyl. 4.9L; 8.5mm High Performance Wire; Routed Over Valve Cover	10007
Caprice		
1996-1994	8 Cyl. 5.7L; 8.5mm High Performance Wire	10017
1996-1994	8 Cyl. 4.3L; 8.5mm High Performance Wire	10017
1993-1992	6 Cyl. 4.3L; 8.5mm High Performance Wire	10014
1993-1992	6 Cyl. 4.3L; 8.5mm High Performance Wire; Equipped with Ceramic Spark Plug Boots	10076
1986-1985	8 Cyl. 5.7L; 9.0mm High Performance Wire	10037
1986-1985	8 Cyl. 5.7L; 8.5mm High Performance Wire; Equipped with Ceramic Spark Plug Boots	10056
1986-1985	8 Cyl. 5.7L; 8.5mm High Performance Wire	10010
1986-1982	8 Cyl. 5.0L; 8.5mm High Performance Wire	10010
1986-1982	8 Cyl. 5.0L; 9.0mm High Performance Wire	10037
1986-1982	8 Cyl. 5.0L; 8.5mm High Performance Wire; Equipped with Ceramic Spark Plug Boots	10056
1982	8 Cyl. 4.4L; 8.5mm High Performance Wire; Equipped with Ceramic Spark Plug Boots	10056
1982	8 Cyl. 4.4L; 9.0mm High Performance Wire	10037
1982	8 Cyl. 4.4L; 8.5mm High Performance Wire	10010
1981	8 Cyl. 4.4L; 8.5mm High Performance Wire; U.S. Models	10010
1981	8 Cyl. 5.0L; 8.5mm High Performance Wire; Equipped with Ceramic Spark Plug Boots; U.S. Models	10056
1981	8 Cyl. 4.4L; 8.5mm High Performance Wire; Canada	10002
1981	8 Cyl. 5.0L; 9.0mm High Performance Wire; U.S. Models	10037

Year	Model/Engine	Part No.
Spark Plug Wire Set		
Caprice		
1981	8 Cyl. 5.0L; 8.5mm High Performance Wire; U.S. Models	10010
1981	8 Cyl. 4.4L; 8.5mm High Performance Wire; Equipped with Ceramic Spark Plug Boots; U.S. Models	10056
1981	8 Cyl. 4.4L; 9.0mm High Performance Wire; U.S. Models	10037
1981	8 Cyl. 5.0L; 9.0mm High Performance Wire; Canada	10034
1981	8 Cyl. 4.4L; 9.0mm High Performance Wire; Canada	10034
1981	8 Cyl. 5.0L; 8.5mm High Performance Wire; Canada; Equipped with Ceramic Spark Plug Boots	10053
1981	8 Cyl. 5.0L; 8.5mm High Performance Wire; Canada	10002
1981	8 Cyl. 4.4L; 8.5mm High Performance Wire; Canada; Equipped with Ceramic Spark Plug Boots	10053
1981-1980	8 Cyl. 5.7L; 9.0mm High Performance Wire	10037
1981-1980	8 Cyl. 5.7L; 8.5mm High Performance Wire; Equipped with Ceramic Spark Plug Boots	10056
1981-1980	8 Cyl. 5.7L; 8.5mm High Performance Wire	10010
1980	8 Cyl. 5.0L; 8.5mm High Performance Wire	10010
1980	8 Cyl. 4.4L; 8.5mm High Performance Wire; Equipped with Ceramic Spark Plug Boots	10056
1980	8 Cyl. 5.0L; 9.0mm High Performance Wire	10037
1980	8 Cyl. 5.0L; 8.5mm High Performance Wire; Equipped with Ceramic Spark Plug Boots	10056
1980	8 Cyl. 4.4L; 9.0mm High Performance Wire	10037
1980	8 Cyl. 4.4L; 8.5mm High Performance Wire	10010
1979-1977	8 Cyl. 5.0L; 8.5mm High Performance Wire; Equipped with Ceramic Spark Plug Boots	10053
1979-1977	8 Cyl. 5.0L; 9.0mm High Performance Wire	10034
1979-1977	8 Cyl. 5.0L; 8.5mm High Performance Wire	10002
1979-1975	8 Cyl. 5.7L; 8.5mm High Performance Wire; Equipped with Ceramic Spark Plug Boots	10053
1979-1975	8 Cyl. 5.7L; 9.0mm High Performance Wire	10034
1979-1975	8 Cyl. 5.7L; 8.5mm High Performance Wire	10002
1976-1975	8 Cyl. 6.6L; 9.0mm High Performance Wire	10034
1976-1975	8 Cyl. 6.6L; 8.5mm High Performance Wire; Equipped with Ceramic Spark Plug Boots	10053
1976-1975	8 Cyl. 7.4L; 8.5mm High Performance Wire	10001
1976-1975	8 Cyl. 7.4L; 8.5mm High Performance Wire; Equipped with Ceramic Spark Plug Boots	10069
1976-1975	8 Cyl. 6.6L; 8.5mm High Performance Wire	10002
1974	8 Cyl. 6.6L; 9.0mm High Performance Wire; w/ High Energy Ignition	10034

Wire Sets

Year	Model/Engine	Part No.
Spark Plug Wire Set		
Caprice		
1974	8 Cyl. 5.7L; 8.5mm High Performance Wire; Equipped with Ceramic Spark Plug Boots; Exc. High Energy Ignition; Routed Over Valve Cover	10079
1974	8 Cyl. 6.6L; 8.5mm High Performance Wire; Equipped with Ceramic Spark Plug Boots; High Energy Ignition	10053
1974	8 Cyl. 5.7L; 8.5mm High Performance Wire; Equipped with Ceramic Spark Plug Boots; High Energy Ignition	10053
1974	8 Cyl. 7.4L; 8.5mm High Performance Wire; Equipped with Ceramic Spark Plug Boots; w/ High Energy Ignition	10069
1974	8 Cyl. 6.6L; 8.5mm High Performance Wire; w/ High Energy Ignition	10002
1974	8 Cyl. 6.6L; 400; 8.5mm High Performance Wire; Equipped with Ceramic Spark Plug Boots; Exc. High Energy Ignition; Routed Over Valve Cover	10079
1974	8 Cyl. 5.7L; 9.0mm High Performance Wire; w/ High Energy Ignition	10034
1974	8 Cyl. 5.7L; 8.5mm High Performance Wire; Exc. High Energy Ignition; Routed Over Valve Cover	10007
1974	8 Cyl. 6.6L; 400; 8.5mm High Performance Wire; Exc. High Energy Ignition; Routed Over Valve Cover	10007
1974	8 Cyl. 5.7L; 8.5mm High Performance Wire; w/ High Energy Ignition	10002
1974	8 Cyl. 7.4L; 8.5mm High Performance Wire; Exc. High Energy Ignition; w/ Straight Non-Bendable Spark Plug Boot	10006
1974	8 Cyl. 7.4L; 8.5mm High Performance Wire; Equipped with Ceramic Spark Plug Boots; Exc. High Energy Ignition	10114
1974	8 Cyl. 7.4L; 8.5mm High Performance Wire; w/ High Energy Ignition	10001
1974	8 Cyl. 7.4L; 8.5mm High Performance Wire; Exc. High Energy Ignition; w/ Straight Bendable Spark Plug Boot	10116
1973-1971	8 Cyl. 5.7L; 8.5mm High Performance Wire; Routed Over Valve Cover	10007
1973-1971	8 Cyl. 5.7L; 8.5mm High Performance Wire; Equipped with Ceramic Spark Plug Boots; Routed Over Valve Cover	10079
1973-1971	8 Cyl. 6.6L; 400; 8.5mm High Performance Wire; Routed Over Valve Cover	10007
1973-1971	8 Cyl. 6.6L; 400; 8.5mm High Performance Wire; Equipped with Ceramic Spark Plug Boots; Routed Over Valve Cover	10079
1973-1970	8 Cyl. 7.4L; 8.5mm High Performance Wire; w/ Straight Non-Bendable Spark Plug Boot	10006
1973-1970	8 Cyl. 7.4L; 8.5mm High Performance Wire; Equipped with Ceramic Spark Plug Boots	10114
1973-1970	8 Cyl. 7.4L; 8.5mm High Performance Wire; w/ Straight Bendable Spark Plug Boot	10116
1971-1970	8 Cyl. 6.6L; 402; 8.5mm High Performance Wire; Equipped with Ceramic Spark Plug Boots	10114
1971-1970	8 Cyl. 6.6L; 402; 8.5mm High Performance Wire; w/ Straight Non-Bendable Spark Plug Boot	10006
1971-1970	8 Cyl. 6.6L; 402; 8.5mm High Performance Wire; w/ Straight Bendable Spark Plug Boot	10116

Year	Model/Engine	Part No.
Spark Plug Wire Set		
Caprice		
1970	8 Cyl. 5.7L; 8.5mm High Performance Wire; Routed Under Exhaust Manifold	10005
1970	8 Cyl. 5.7L; 8.5mm High Performance Wire; Equipped with Ceramic Spark Plug Boots; Routed Under Exhaust Manifold	10080
1969	8 Cyl. 5.7L; 8.5mm High Performance Wire; Routed Over Valve Cover	10007
1969	8 Cyl. 5.7L; 8.5mm High Performance Wire; Equipped with Ceramic Spark Plug Boots; Routed Over Valve Cover	10079
1969	8 Cyl. 5.4L; 8.5mm High Performance Wire; Routed Over Valve Cover	10007
1969	8 Cyl. 5.4L; 8.5mm High Performance Wire; Equipped with Ceramic Spark Plug Boots; Routed Over Valve Cover	10079
1969-1968	8 Cyl. 6.5L; 8.5mm High Performance Wire; Equipped with Ceramic Spark Plug Boots	10114
1969-1968	8 Cyl. 7.0L; 8.5mm High Performance Wire; w/ Straight Non-Bendable Spark Plug Boot	10006
1969-1968	8 Cyl. 6.5L; 8.5mm High Performance Wire; w/ Straight Non-Bendable Spark Plug Boot	10006
1969-1968	8 Cyl. 7.0L; 8.5mm High Performance Wire; Equipped with Ceramic Spark Plug Boots	10114
1969-1968	8 Cyl. 6.5L; 8.5mm High Performance Wire; w/ Straight Bendable Spark Plug Boot	10116
1969-1968	8 Cyl. 7.0L; 8.5mm High Performance Wire; w/ Straight Bendable Spark Plug Boot	10116
1968	8 Cyl. 5.4L; 8.5mm High Performance Wire; Routed Under Exhaust Manifold	10005
1968	8 Cyl. 5.4L; 8.5mm High Performance Wire; Equipped with Ceramic Spark Plug Boots; Routed Under Exhaust Manifold	10080
1968	8 Cyl. 5.0L; 8.5mm High Performance Wire; Routed Under Exhaust Manifold	10005
1968	8 Cyl. 5.0L; 8.5mm High Performance Wire; Equipped with Ceramic Spark Plug Boots; Routed Under Exhaust Manifold	10080
1967-1966	8 Cyl. 4.6L; 8.5mm High Performance Wire; Equipped with Ceramic Spark Plug Boots; Routed Under Exhaust Manifold	10080
1967-1966	8 Cyl. 5.3L; 8.5mm High Performance Wire; Equipped with Ceramic Spark Plug Boots; Routed Under Exhaust Manifold	10080
1967-1966	8 Cyl. 5.3L; 8.5mm High Performance Wire; Routed Under Exhaust Manifold	10005
1967-1966	8 Cyl. 6.5L; 8.5mm High Performance Wire; w/ Straight Non-Bendable Spark Plug Boot	10006
1967-1966	8 Cyl. 6.5L; 8.5mm High Performance Wire; Equipped with Ceramic Spark Plug Boots	10114
1967-1966	8 Cyl. 4.6L; 8.5mm High Performance Wire; Routed Under Exhaust Manifold	10005
1967-1966	8 Cyl. 7.0L; 8.5mm High Performance Wire; w/ Straight Non-Bendable Spark Plug Boot	10006
1967-1966	8 Cyl. 7.0L; 8.5mm High Performance Wire; Equipped with Ceramic Spark Plug Boots	10114
1967-1966	8 Cyl. 6.5L; 8.5mm High Performance Wire; w/ Straight Bendable Spark Plug Boot	10116
1967-1966	8 Cyl. 7.0L; 8.5mm High Performance Wire; w/ Straight Bendable Spark Plug Boot	10116

Chevrolet

Wire Sets

Year	Model/Engine	Part No.
Spark Plug Wire Set		
Cavalier		
1986-1985	6 Cyl. 2.8L; 8.5mm High Performance Wire; Equipped with Ceramic Spark Plug Boots	10058
1986-1985	6 Cyl. 2.8L; 8.5mm High Performance Wire	10057
Celebrity		
1986-1983	6 Cyl. 2.8L; 8.5mm High Performance Wire; Equipped with Ceramic Spark Plug Boots	10058
1986-1983	6 Cyl. 2.8L; 8.5mm High Performance Wire	10057
Chevelle		
1973-1970	8 Cyl. 7.4L; 8.5mm High Performance Wire; Equipped with Ceramic Spark Plug Boots	10114
1973-1970	8 Cyl. 7.4L; 8.5mm High Performance Wire; w/ Straight Non-Bendable Spark Plug Boot	10006
1973-1970	8 Cyl. 7.4L; 8.5mm High Performance Wire; w/ Straight Bendable Spark Plug Boot	10116
1973-1969	8 Cyl. 5.7L; 8.5mm High Performance Wire; Routed Over Valve Cover	10007
1973-1969	8 Cyl. 5.7L; 8.5mm High Performance Wire; Equipped with Ceramic Spark Plug Boots; Routed Over Valve Cover	10079
1973-1968	8 Cyl. 5.0L; 8.5mm High Performance Wire; Routed Over Valve Cover	10007
1973-1968	8 Cyl. 5.0L; 8.5mm High Performance Wire; Equipped with Ceramic Spark Plug Boots; Routed Over Valve Cover	10079
1972	8 Cyl. 6.6L; 402; 8.5mm High Performance Wire; Equipped with Ceramic Spark Plug Boots	10114
1972	8 Cyl. 6.6L; 402; 8.5mm High Performance Wire; w/ Straight Non-Bendable Spark Plug Boot	10006
1972	8 Cyl. 6.6L; 402; 8.5mm High Performance Wire; w/ Straight Bendable Spark Plug Boot	10116
1971	8 Cyl. 6.6L; 400; 8.5mm High Performance Wire; Equipped with Ceramic Spark Plug Boots; Routed Over Valve Cover	10079
1971	8 Cyl. 6.6L; 400; 8.5mm High Performance Wire; Routed Over Valve Cover	10007
1970	8 Cyl. 6.6L; 402; 8.5mm High Performance Wire; Equipped with Ceramic Spark Plug Boots	10114
1970	8 Cyl. 6.6L; 402; 8.5mm High Performance Wire; w/ Straight Non-Bendable Spark Plug Boot	10006
1970	8 Cyl. 6.6L; 402; 8.5mm High Performance Wire; w/ Straight Bendable Spark Plug Boot	10116
1970-1968	8 Cyl. 6.5L; 8.5mm High Performance Wire; w/ Straight Non-Bendable Spark Plug Boot	10006
1970-1968	8 Cyl. 6.5L; 8.5mm High Performance Wire; Equipped with Ceramic Spark Plug Boots	10114
1970-1968	8 Cyl. 6.5L; 8.5mm High Performance Wire; w/ Straight Bendable Spark Plug Boot	10116
1968	8 Cyl. 5.4L; 8.5mm High Performance Wire; Routed Over Valve Cover	10007
1968	8 Cyl. 5.4L; 8.5mm High Performance Wire; Equipped with Ceramic Spark Plug Boots; Routed Over Valve Cover	10079

Year	Model/Engine	Part No.
Spark Plug Wire Set		
Chevelle		
1967	8 Cyl. 6.5L; 8.5mm High Performance Wire; Equipped with Ceramic Spark Plug Boots	10114
1967	8 Cyl. 5.4L; 8.5mm High Performance Wire; Routed Under Exhaust Manifold	10005
1967	8 Cyl. 6.5L; 8.5mm High Performance Wire; w/ Straight Non-Bendable Spark Plug Boot	10006
1967	8 Cyl. 4.6L; 8.5mm High Performance Wire; Routed Over Valve Cover	10007
1967	8 Cyl. 4.6L; 8.5mm High Performance Wire; Equipped with Ceramic Spark Plug Boots; Routed Over Valve Cover	10079
1967	8 Cyl. 5.4L; 8.5mm High Performance Wire; Equipped with Ceramic Spark Plug Boots; Routed Under Exhaust Manifold	10080
1967	8 Cyl. 6.5L; 8.5mm High Performance Wire; w/ Straight Bendable Spark Plug Boot	10116
1966	8 Cyl. 6.5L; 8.5mm High Performance Wire; w/ Straight Non-Bendable Spark Plug Boot	10006
1966	8 Cyl. 6.5L; 8.5mm High Performance Wire; Equipped with Ceramic Spark Plug Boots	10114
1966	8 Cyl.; 283; 8.5mm High Performance Wire; Equipped with Ceramic Spark Plug Boots; Routed Over Valve Cover	10079
1966	8 Cyl.; 327; 8.5mm High Performance Wire; Equipped with Ceramic Spark Plug Boots; Routed Under Exhaust Manifold	10080
1966	8 Cyl.; 283; 8.5mm High Performance Wire; Routed Over Valve Cover	10007
1966	8 Cyl.; 327; 8.5mm High Performance Wire; Routed Under Exhaust Manifold	10005
1966	8 Cyl. 6.5L; 8.5mm High Performance Wire; w/ Straight Bendable Spark Plug Boot	10116
1965	8 Cyl. 6.5L; 8.5mm High Performance Wire; Equipped with Ceramic Spark Plug Boots	10114
1965	8 Cyl. 6.5L; 8.5mm High Performance Wire; w/ Straight Non-Bendable Spark Plug Boot	10006
1965	8 Cyl. 6.5L; 8.5mm High Performance Wire; w/ Straight Bendable Spark Plug Boot	10116
1965-1964	8 Cyl.; 283; 8.5mm High Performance Wire; Equipped with Ceramic Spark Plug Boots; Routed Over Valve Cover	10079
1965-1964	8 Cyl.; 327; 8.5mm High Performance Wire; Equipped with Ceramic Spark Plug Boots; Routed Under Exhaust Manifold	10080
1965-1964	8 Cyl.; 327; 8.5mm High Performance Wire; Routed Under Exhaust Manifold	10005
1965-1964	8 Cyl.; 283; 8.5mm High Performance Wire; Routed Over Valve Cover	10007
Chevy II		
1968	8 Cyl. 5.7L; 8.5mm High Performance Wire; Equipped with Ceramic Spark Plug Boots; Routed Over Valve Cover	10079
1968	8 Cyl. 6.5L; 8.5mm High Performance Wire; w/ Straight Non-Bendable Spark Plug Boot	10006
1968	8 Cyl. 5.4L; 8.5mm High Performance Wire; Routed Over Valve Cover	10007
1968	8 Cyl. 5.7L; 8.5mm High Performance Wire; Routed Over Valve Cover	10007
1968	8 Cyl. 5.0L; 8.5mm High Performance Wire; Routed Over Valve Cover	10007

Wire Sets

Year	Model/Engine	Part No.
Spark Plug Wire Set		
Chevy II		
1968	8 Cyl. 5.0L; 8.5mm High Performance Wire; Equipped with Ceramic Spark Plug Boots; Routed Over Valve Cover	10079
1968	8 Cyl. 5.4L; 8.5mm High Performance Wire; Equipped with Ceramic Spark Plug Boots; Routed Over Valve Cover	10079
1968	8 Cyl. 6.5L; 8.5mm High Performance Wire; Equipped with Ceramic Spark Plug Boots	10114
1968	8 Cyl. 6.5L; 8.5mm High Performance Wire; w/ Straight Bendable Spark Plug Boot	10116
1967	8 Cyl. 5.3L; 8.5mm High Performance Wire; Routed Under Exhaust Manifold	10005
1967	8 Cyl. 5.3L; 8.5mm High Performance Wire; Equipped with Ceramic Spark Plug Boots; Routed Under Exhaust Manifold	10080
1967-1965	8 Cyl. 5.3L; 8.5mm High Performance Wire; Equipped with Ceramic Spark Plug Boots; Routed Over Valve Cover	10079
1967-1965	8 Cyl. 5.3L; 8.5mm High Performance Wire; Routed Over Valve Cover	10007
1967-1962	8 Cyl. 4.6L; 8.5mm High Performance Wire; Routed Under Exhaust Manifold	10005
1967-1962	8 Cyl. 4.6L; 8.5mm High Performance Wire; Equipped with Ceramic Spark Plug Boots; Routed Under Exhaust Manifold	10080
Citation II		
1985-1984	6 Cyl. 2.8L; 8.5mm High Performance Wire; Equipped with Ceramic Spark Plug Boots	10058
1985-1984	6 Cyl. 2.8L; 8.5mm High Performance Wire	10057
Colorado		
2010-2009	8 Cyl. 5.3L; 9.0mm High Performance Wire	10039
2010-2009	8 Cyl. 5.3L; 8.5mm High Performance Wire	10026
Corvette		
2013-2009	8 Cyl. 6.2L; 9.0mm High Performance Wire	10039
2013-2009	8 Cyl. 6.2L; 8.5mm High Performance Wire	10026
2011-2009	8 Cyl. 7.0L; 8.5mm High Performance Wire	10026
2011-2009	8 Cyl. 7.0L; 9.0mm High Performance Wire	10039
2008	8 Cyl. 6.2L; 8.5mm High Performance Wire	10041
2008	8 Cyl. 6.2L; 9.0mm High Performance Wire	10042
2008-2006	8 Cyl. 7.0L; 9.0mm High Performance Wire	10042
2008-2006	8 Cyl. 7.0L; 8.5mm High Performance Wire	10041
2007-2005	8 Cyl. 6.0L; 9.0mm High Performance Wire	10042
2007-2005	8 Cyl. 6.0L; 8.5mm High Performance Wire	10041
2004-1997	8 Cyl. 5.7L; 8.5mm High Performance Wire	10026
2004-1997	8 Cyl. 5.7L; 9.0mm High Performance Wire	10039
1974-1970	8 Cyl. 7.4L; 8.5mm High Performance Wire; Equipped with Ceramic Spark Plug Boots	10114
1974-1970	8 Cyl. 7.4L; 8.5mm High Performance Wire; w/ Straight Non-Bendable Spark Plug Boot	10006

Year	Model/Engine	Part No.
Spark Plug Wire Set		
Corvette		
1974-1970	8 Cyl. 7.4L; 8.5mm High Performance Wire; w/ Straight Bendable Spark Plug Boot	10116
1974-1969	8 Cyl. 5.7L; 8.5mm High Performance Wire; Routed Under Exhaust Manifold	10005
1974-1969	8 Cyl. 5.7L; 8.5mm High Performance Wire; Equipped with Ceramic Spark Plug Boots; Routed Under Exhaust Manifold	10080
1969-1968	8 Cyl. 7.0L; 8.5mm High Performance Wire; w/ Straight Non-Bendable Spark Plug Boot	10006
1969-1968	8 Cyl. 7.0L; 8.5mm High Performance Wire; Equipped with Ceramic Spark Plug Boots	10114
1969-1968	8 Cyl. 7.0L; 8.5mm High Performance Wire; w/ Straight Bendable Spark Plug Boot	10116
1968	8 Cyl. 5.4L; 8.5mm High Performance Wire; Routed Under Exhaust Manifold	10005
1968	8 Cyl. 5.4L; 8.5mm High Performance Wire; Equipped with Ceramic Spark Plug Boots; Routed Under Exhaust Manifold	10080
1967-1966	8 Cyl. 7.0L; 8.5mm High Performance Wire; w/ Straight Non-Bendable Spark Plug Boot	10006
1967-1966	8 Cyl. 7.0L; 8.5mm High Performance Wire; Equipped with Ceramic Spark Plug Boots	10114
1967-1966	8 Cyl. 7.0L; 8.5mm High Performance Wire; w/ Straight Bendable Spark Plug Boot	10116
1967-1962	8 Cyl. 5.3L; 8.5mm High Performance Wire; Routed Under Exhaust Manifold	10005
1967-1962	8 Cyl. 5.3L; 8.5mm High Performance Wire; Equipped with Ceramic Spark Plug Boots; Routed Under Exhaust Manifold	10080
1965	8 Cyl. 6.5L; 8.5mm High Performance Wire; w/ Straight Non-Bendable Spark Plug Boot	10006
1965	8 Cyl. 6.5L; 8.5mm High Performance Wire; Equipped with Ceramic Spark Plug Boots	10114
1965	8 Cyl. 6.5L; 8.5mm High Performance Wire; w/ Straight Bendable Spark Plug Boot	10116
1961-1957	8 Cyl. 4.6L; 8.5mm High Performance Wire; Equipped with Ceramic Spark Plug Boots; Routed Under Exhaust Manifold	10080
1961-1957	8 Cyl. 4.6L; 8.5mm High Performance Wire; Routed Under Exhaust Manifold	10005
1956-1955	8 Cyl. 4.3L; 8.5mm High Performance Wire; Equipped with Ceramic Spark Plug Boots; Routed Under Exhaust Manifold	10080
1956-1955	8 Cyl. 4.3L; 8.5mm High Performance Wire; Routed Under Exhaust Manifold	10005
Del Ray		
1958	8 Cyl. 5.7L; 8.5mm High Performance Wire	10008
1958	8 Cyl. 4.6L; 8.5mm High Performance Wire; Routed Under Exhaust Manifold	10005
1958	8 Cyl. 5.7L; 8.5mm High Performance Wire; Equipped with Ceramic Spark Plug Boots	10059
1958	8 Cyl. 4.6L; 8.5mm High Performance Wire; Equipped with Ceramic Spark Plug Boots; Routed Under Exhaust Manifold	10080
El Camino		
1986-1978	8 Cyl. 5.0L; 8.5mm High Performance Wire; Equipped with Ceramic Spark Plug Boots	10056

Wire Sets

Year	Model/Engine	Part No.
Spark Plug Wire Set		
El Camino		
1986-1978	8 Cyl. 5.0L; 9.0mm High Performance Wire	10037
1986-1978	8 Cyl. 5.0L; 8.5mm High Performance Wire	10010
1982-1979	8 Cyl. 4.4L; 9.0mm High Performance Wire	10037
1982-1979	8 Cyl. 4.4L; 8.5mm High Performance Wire	10010
1982-1979	8 Cyl. 4.4L; 8.5mm High Performance Wire; Equipped with Ceramic Spark Plug Boots	10056
1979-1978	8 Cyl. 5.7L; 8.5mm High Performance Wire	10010
1979-1978	8 Cyl. 5.7L; 9.0mm High Performance Wire	10037
1979-1978	8 Cyl. 5.7L; 8.5mm High Performance Wire; Equipped with Ceramic Spark Plug Boots	10056
1977-1976	8 Cyl. 5.0L; 8.5mm High Performance Wire	10002
1977-1976	8 Cyl. 5.0L; 8.5mm High Performance Wire; Equipped with Ceramic Spark Plug Boots	10053
1977-1976	8 Cyl. 5.0L; 9.0mm High Performance Wire	10034
1977-1975	8 Cyl. 5.7L; 8.5mm High Performance Wire; Equipped with Ceramic Spark Plug Boots	10053
1977-1975	8 Cyl. 5.7L; 8.5mm High Performance Wire	10002
1977-1975	8 Cyl. 5.7L; 9.0mm High Performance Wire	10034
1976-1975	8 Cyl. 6.6L; 8.5mm High Performance Wire; Equipped with Ceramic Spark Plug Boots	10053
1976-1975	8 Cyl. 6.6L; 9.0mm High Performance Wire	10034
1976-1975	8 Cyl. 6.6L; 8.5mm High Performance Wire	10002
1975	8 Cyl. 7.4L; 8.5mm High Performance Wire; Equipped with Ceramic Spark Plug Boots	10069
1975	8 Cyl. 7.4L; 8.5mm High Performance Wire	10001
1974	8 Cyl. 6.6L; 8.5mm High Performance Wire; Equipped with Ceramic Spark Plug Boots; High Energy Ignition	10053
1974	8 Cyl. 7.4L; 8.5mm High Performance Wire; Exc. High Energy Ignition; w/ Straight Non-Bendable Spark Plug Boot	10006
1974	8 Cyl. 5.7L; 9.0mm High Performance Wire; w/ High Energy Ignition	10034
1974	8 Cyl. 5.7L; 8.5mm High Performance Wire; Equipped with Ceramic Spark Plug Boots; Exc. High Energy Ignition; Routed Over Valve Cover	10079
1974	8 Cyl. 5.7L; 8.5mm High Performance Wire; Equipped with Ceramic Spark Plug Boots; High Energy Ignition	10053
1974	8 Cyl. 6.6L; 400; 8.5mm High Performance Wire; Equipped with Ceramic Spark Plug Boots; Exc. High Energy Ignition; Routed Over Valve Cover	10079
1974	8 Cyl. 7.4L; 8.5mm High Performance Wire; w/ High Energy Ignition	10001
1974	8 Cyl. 5.7L; 8.5mm High Performance Wire; w/ High Energy Ignition	10002
1974	8 Cyl. 6.6L; 9.0mm High Performance Wire; w/ High Energy Ignition	10034

Year	Model/Engine	Part No.
Spark Plug Wire Set		
El Camino		
1974	8 Cyl. 7.4L; 8.5mm High Performance Wire; Equipped with Ceramic Spark Plug Boots; Exc. High Energy Ignition	10114
1974	8 Cyl. 6.6L; 400; 8.5mm High Performance Wire; Exc. High Energy Ignition; Routed Over Valve Cover	10007
1974	8 Cyl. 7.4L; 8.5mm High Performance Wire; Equipped with Ceramic Spark Plug Boots; w/ High Energy Ignition	10069
1974	8 Cyl. 6.6L; 8.5mm High Performance Wire; w/ High Energy Ignition	10002
1974	8 Cyl. 5.7L; 8.5mm High Performance Wire; Exc. High Energy Ignition; Routed Over Valve Cover	10007
1974	8 Cyl. 7.4L; 8.5mm High Performance Wire; Exc. High Energy Ignition; w/ Straight Bendable Spark Plug Boot	10116
1973-1971	8 Cyl. 5.0L; 8.5mm High Performance Wire; Equipped with Ceramic Spark Plug Boots; Routed Over Valve Cover	10079
1973-1971	8 Cyl. 5.7L; 8.5mm High Performance Wire; Equipped with Ceramic Spark Plug Boots; Routed Over Valve Cover	10079
1973-1971	8 Cyl. 5.7L; 8.5mm High Performance Wire; Routed Over Valve Cover	10007
1973-1971	8 Cyl. 5.0L; 8.5mm High Performance Wire; Routed Over Valve Cover	10007
1973-1970	8 Cyl. 7.4L; 8.5mm High Performance Wire; Equipped with Ceramic Spark Plug Boots	10114
1973-1970	8 Cyl. 7.4L; 8.5mm High Performance Wire; w/ Straight Non-Bendable Spark Plug Boot	10006
1973-1970	8 Cyl. 7.4L; 8.5mm High Performance Wire; w/ Straight Bendable Spark Plug Boot	10116
1972-1971	8 Cyl. 6.6L; 402; 8.5mm High Performance Wire; w/ Straight Non-Bendable Spark Plug Boot	10006
1972-1971	8 Cyl. 6.6L; 402; 8.5mm High Performance Wire; Equipped with Ceramic Spark Plug Boots	10114
1972-1971	8 Cyl. 6.6L; 402; 8.5mm High Performance Wire; w/ Straight Bendable Spark Plug Boot	10116
1970	8 Cyl. 5.7L; 8.5mm High Performance Wire; Routed Under Exhaust Manifold	10005
1970	8 Cyl. 5.0L; 8.5mm High Performance Wire; Equipped with Ceramic Spark Plug Boots; Routed Under Exhaust Manifold	10080
1970	8 Cyl. 5.0L; 8.5mm High Performance Wire; Routed Under Exhaust Manifold	10005
1970	8 Cyl. 5.7L; 8.5mm High Performance Wire; Equipped with Ceramic Spark Plug Boots; Routed Under Exhaust Manifold	10080
1970	8 Cyl. 6.6L; 8.5mm High Performance Wire; Equipped with Ceramic Spark Plug Boots	10114
1970	8 Cyl. 6.6L; 8.5mm High Performance Wire; w/ Straight Non-Bendable Spark Plug Boot	10006
1970	8 Cyl. 6.6L; 8.5mm High Performance Wire; w/ Straight Bendable Spark Plug Boot	10116
1970-1968	8 Cyl. 6.5L; 8.5mm High Performance Wire; Equipped with Ceramic Spark Plug Boots	10114
1970-1968	8 Cyl. 6.5L; 8.5mm High Performance Wire; w/ Straight Non-Bendable Spark Plug Boot	10006

Wire Sets

Year	Model/Engine	Part No.
Spark Plug Wire Set		
El Camino		
1970-1968	8 Cyl. 6.5L; 8.5mm High Performance Wire; w/ Straight Bendable Spark Plug Boot	10116
1969	8 Cyl. 5.7L; 8.5mm High Performance Wire; Equipped with Ceramic Spark Plug Boots; Routed Over Valve Cover	10079
1969	8 Cyl. 5.7L; 8.5mm High Performance Wire; Routed Over Valve Cover	10007
1969-1968	8 Cyl. 5.0L; 8.5mm High Performance Wire; Equipped with Ceramic Spark Plug Boots; Routed Over Valve Cover	10079
1969-1968	8 Cyl. 5.0L; 8.5mm High Performance Wire; Routed Over Valve Cover	10007
1968	8 Cyl.; 327; 8.5mm High Performance Wire; Equipped with Ceramic Spark Plug Boots; Routed Over Valve Cover	10079
1968	8 Cyl.; 327; 8.5mm High Performance Wire; Routed Over Valve Cover	10007
1967-1966	8 Cyl. 6.5L; 8.5mm High Performance Wire; Equipped with Ceramic Spark Plug Boots	10114
1967-1966	8 Cyl. 6.5L; 8.5mm High Performance Wire; w/ Straight Non-Bendable Spark Plug Boot	10006
1967-1966	8 Cyl. 6.5L; 8.5mm High Performance Wire; w/ Straight Bendable Spark Plug Boot	10116
1967-1964	8 Cyl. 5.3L; 8.5mm High Performance Wire; Equipped with Ceramic Spark Plug Boots; Routed Under Exhaust Manifold	10080
1967-1964	8 Cyl. 4.6L; 8.5mm High Performance Wire; Routed Over Valve Cover	10007
1967-1964	8 Cyl. 5.3L; 8.5mm High Performance Wire; Routed Under Exhaust Manifold	10005
1967-1964	8 Cyl. 4.6L; 8.5mm High Performance Wire; Equipped with Ceramic Spark Plug Boots; Routed Over Valve Cover	10079
1960-1959	8 Cyl. 5.7L; 8.5mm High Performance Wire	10008
1960-1959	8 Cyl. 4.6L; 8.5mm High Performance Wire; Equipped with Ceramic Spark Plug Boots; Routed Under Exhaust Manifold	10080
1960-1959	8 Cyl. 4.6L; 8.5mm High Performance Wire; Routed Under Exhaust Manifold	10005
1960-1959	8 Cyl. 5.7L; 8.5mm High Performance Wire; Equipped with Ceramic Spark Plug Boots	10059
Express 1500		
2008-2003	8 Cyl. 5.3L; 9.0mm High Performance Wire	10042
2008-2003	8 Cyl. 5.3L; 8.5mm High Performance Wire	10041
2007-1998	6 Cyl. 4.3L; 8.5mm High Performance Wire; Equipped with Ceramic Spark Plug Boots	10078
2007-1998	6 Cyl. 4.3L; 8.5mm High Performance Wire	10077
1997-1996	6 Cyl. 4.3L; 8.5mm High Performance Wire	10077
1997-1996	6 Cyl. 4.3L; 8.5mm High Performance Wire; Equipped with Ceramic Spark Plug Boots	10078
Express 2500		
2005-2003	8 Cyl. 5.3L; 8.5mm High Performance Wire	10041
2005-2003	8 Cyl. 5.3L; 9.0mm High Performance Wire	10042
2005-2000	6 Cyl. 4.3L; 8.5mm High Performance Wire; Equipped with Ceramic Spark Plug Boots	10078

Year	Model/Engine	Part No.
Spark Plug Wire Set		
Express 2500		
2005-2000	6 Cyl. 4.3L; 8.5mm High Performance Wire	10077
1999	6 Cyl. 4.3L; 8.5mm High Performance Wire	10077
1999	6 Cyl. 4.3L; 8.5mm High Performance Wire; Equipped with Ceramic Spark Plug Boots	10078
1998-1996	6 Cyl. 4.3L; 8.5mm High Performance Wire; Equipped with Ceramic Spark Plug Boots	10078
1998-1996	6 Cyl. 4.3L; 8.5mm High Performance Wire	10077
Express 3500		
2008-2003	8 Cyl. 5.3L; 8.5mm High Performance Wire	10041
2008-2003	8 Cyl. 5.3L; 9.0mm High Performance Wire	10042
2000-1998	8 Cyl. 7.4L; 8.5mm High Performance Wire; Equipped with Ceramic Spark Plug Boots	10071
2000-1998	8 Cyl. 7.4L; 8.5mm High Performance Wire	10070
1997-1996	8 Cyl. 7.4L; 8.5mm High Performance Wire	10070
1997-1996	8 Cyl. 7.4L; 8.5mm High Performance Wire; Equipped with Ceramic Spark Plug Boots	10071
G10		
1995-1987	8 Cyl. 5.0L; 8.5mm High Performance Wire	10018
1995-1987	8 Cyl. 5.0L; 8.5mm High Performance Wire; Equipped with Ceramic Spark Plug Boots	10046
1993-1987	8 Cyl. 5.7L; 8.5mm High Performance Wire	10018
1993-1987	8 Cyl. 5.7L; 8.5mm High Performance Wire; Equipped with Ceramic Spark Plug Boots	10046
G10 Van		
1974	8 Cyl. 5.7L; 8.5mm High Performance Wire; Routed Over Valve Cover	10007
1974	8 Cyl. 5.7L; 8.5mm High Performance Wire; Equipped with Ceramic Spark Plug Boots; Routed Over Valve Cover	10079
G20		
1995	8 Cyl. 5.7L; 8.5mm High Performance Wire; Equipped with Ceramic Spark Plug Boots	10046
1995	8 Cyl. 5.0L; 8.5mm High Performance Wire; Equipped with Ceramic Spark Plug Boots	10046
1995	8 Cyl. 5.7L; 8.5mm High Performance Wire	10018
1995	8 Cyl. 5.0L; 8.5mm High Performance Wire	10018
1994-1987	8 Cyl. 5.0L; 8.5mm High Performance Wire	10018
1994-1987	8 Cyl. 5.7L; 8.5mm High Performance Wire; Equipped with Ceramic Spark Plug Boots	10046
1994-1987	8 Cyl. 5.7L; 8.5mm High Performance Wire	10018
1994-1987	8 Cyl. 5.0L; 8.5mm High Performance Wire; Equipped with Ceramic Spark Plug Boots	10046
G20 Van		
1974	8 Cyl. 5.7L; 8.5mm High Performance Wire; Routed Over Valve Cover	10007

Chevrolet

Wire Sets

Year	Model/Engine	Part No.
Spark Plug Wire Set		
G20 Van		
1974	8 Cyl. 5.7L; 8.5mm High Performance Wire; Equipped with Ceramic Spark Plug Boots; Routed Over Valve Cover	10079
G30		
1996	8 Cyl. 7.4L; 8.5mm High Performance Wire; EFI; Equipped with Ceramic Spark Plug Boots	10051
1996	8 Cyl. 5.7L; 8.5mm High Performance Wire; TBI	10018
1996	8 Cyl. 5.7L; 8.5mm High Performance Wire; Equipped with Ceramic Spark Plug Boots; TBI	10046
1996	8 Cyl. 7.4L; 8.5mm High Performance Wire; EFI	10050
1995-1989	8 Cyl. 5.7L; 8.5mm High Performance Wire	10018
1995-1989	8 Cyl. 5.7L; 8.5mm High Performance Wire; Equipped with Ceramic Spark Plug Boots	10046
1995-1988	8 Cyl. 7.4L; 8.5mm High Performance Wire; Equipped with Ceramic Spark Plug Boots	10051
1995-1988	8 Cyl. 7.4L; 8.5mm High Performance Wire	10050
1988-1987	8 Cyl. 5.7L; 8.5mm High Performance Wire; TBI	10018
1988-1987	8 Cyl. 5.7L; 8.5mm High Performance Wire; Equipped with Ceramic Spark Plug Boots; TBI	10046
G30 Van		
1974	8 Cyl. 5.7L; 8.5mm High Performance Wire; Routed Over Valve Cover	10007
1974	8 Cyl. 5.7L; 8.5mm High Performance Wire; Equipped with Ceramic Spark Plug Boots; Routed Over Valve Cover	10079
Impala		
2009	8 Cyl. 5.3L; 8.5mm High Performance Wire	10026
2009	8 Cyl. 5.3L; 9.0mm High Performance Wire	10039
2008-2006	8 Cyl. 5.3L; 8.5mm High Performance Wire	10041
2008-2006	8 Cyl. 5.3L; 9.0mm High Performance Wire	10042
1996-1994	8 Cyl. 5.7L; 8.5mm High Performance Wire	10017
1985-1980	8 Cyl. 5.7L; 8.5mm High Performance Wire	10010
1985-1980	8 Cyl. 5.0L; 8.5mm High Performance Wire	10010
1985-1980	8 Cyl. 5.7L; 8.5mm High Performance Wire; Equipped with Ceramic Spark Plug Boots	10056
1985-1980	8 Cyl. 5.7L; 9.0mm High Performance Wire	10037
1985-1980	8 Cyl. 5.0L; 8.5mm High Performance Wire; Equipped with Ceramic Spark Plug Boots	10056
1985-1980	8 Cyl. 5.0L; 9.0mm High Performance Wire	10037
1982-1980	8 Cyl. 4.4L; 8.5mm High Performance Wire; Equipped with Ceramic Spark Plug Boots	10056
1982-1980	8 Cyl. 4.4L; 9.0mm High Performance Wire	10037
1982-1980	8 Cyl. 4.4L; 8.5mm High Performance Wire	10010
1979-1977	8 Cyl. 5.0L; 9.0mm High Performance Wire	10034

Year	Model/Engine	Part No.
Spark Plug Wire Set		
Impala		
1979-1977	8 Cyl. 5.0L; 8.5mm High Performance Wire; Equipped with Ceramic Spark Plug Boots	10053
1979-1977	8 Cyl. 5.0L; 8.5mm High Performance Wire	10002
1979-1975	8 Cyl. 5.7L; 9.0mm High Performance Wire	10034
1979-1975	8 Cyl. 5.7L; 8.5mm High Performance Wire	10002
1979-1975	8 Cyl. 5.7L; 8.5mm High Performance Wire; Equipped with Ceramic Spark Plug Boots	10053
1976-1975	8 Cyl. 6.6L; 8.5mm High Performance Wire	10002
1976-1975	8 Cyl. 7.4L; 8.5mm High Performance Wire; Equipped with Ceramic Spark Plug Boots	10069
1976-1975	8 Cyl. 7.4L; 8.5mm High Performance Wire	10001
1976-1975	8 Cyl. 6.6L; 8.5mm High Performance Wire; Equipped with Ceramic Spark Plug Boots	10053
1976-1975	8 Cyl. 6.6L; 9.0mm High Performance Wire	10034
1974	8 Cyl. 5.7L; 8.5mm High Performance Wire; Exc. High Energy Ignition; Routed Over Valve Cover	10007
1974	8 Cyl. 7.4L; 8.5mm High Performance Wire; w/ High Energy Ignition	10001
1974	8 Cyl. 6.6L; 400; 8.5mm High Performance Wire; Exc. High Energy Ignition; Routed Over Valve Cover	10007
1974	8 Cyl. 5.7L; 8.5mm High Performance Wire; Equipped with Ceramic Spark Plug Boots; High Energy Ignition	10053
1974	8 Cyl. 6.6L; 400; 8.5mm High Performance Wire; Equipped with Ceramic Spark Plug Boots; Exc. High Energy Ignition; Routed Over Valve Cover	10079
1974	8 Cyl. 6.6L; 8.5mm High Performance Wire; Equipped with Ceramic Spark Plug Boots; High Energy Ignition	10053
1974	8 Cyl. 7.4L; 8.5mm High Performance Wire; Equipped with Ceramic Spark Plug Boots; w/ High Energy Ignition	10069
1974	8 Cyl. 6.6L; 9.0mm High Performance Wire; w/ High Energy Ignition	10034
1974	8 Cyl. 5.7L; 8.5mm High Performance Wire; w/ High Energy Ignition	10002
1974	8 Cyl. 7.4L; 8.5mm High Performance Wire; Equipped with Ceramic Spark Plug Boots; Exc. High Energy Ignition	10114
1974	8 Cyl. 7.4L; 8.5mm High Performance Wire; Exc. High Energy Ignition; w/ Straight Non-Bendable Spark Plug Boot	10006
1974	8 Cyl. 6.6L; 8.5mm High Performance Wire; w/ High Energy Ignition	10002
1974	8 Cyl. 5.7L; 8.5mm High Performance Wire; Equipped with Ceramic Spark Plug Boots; Exc. High Energy Ignition; Routed Over Valve Cover	10079
1974	8 Cyl. 5.7L; 9.0mm High Performance Wire; w/ High Energy Ignition	10034
1974	8 Cyl. 7.4L; 8.5mm High Performance Wire; Exc. High Energy Ignition; w/ Straight Bendable Spark Plug Boot	10116
1973-1971	8 Cyl. 6.6L; 400; 8.5mm High Performance Wire; Routed Over Valve Cover	10007

Wire Sets

Year	Model/Engine	Part No.
Spark Plug Wire Set		
Impala		
1973-1971	8 Cyl. 6.6L; 400; 8.5mm High Performance Wire; Equipped with Ceramic Spark Plug Boots; Routed Over Valve Cover	10079
1973-1970	8 Cyl. 7.4L; 8.5mm High Performance Wire; Equipped with Ceramic Spark Plug Boots	10114
1973-1970	8 Cyl. 7.4L; 8.5mm High Performance Wire; w/ Straight Non-Bendable Spark Plug Boot	10006
1973-1970	8 Cyl. 7.4L; 8.5mm High Performance Wire; w/ Straight Bendable Spark Plug Boot	10116
1973-1969	8 Cyl. 5.7L; 8.5mm High Performance Wire; Routed Over Valve Cover	10007
1973-1969	8 Cyl. 5.7L; 8.5mm High Performance Wire; Equipped with Ceramic Spark Plug Boots; Routed Over Valve Cover	10079
1972-1970	8 Cyl. 6.6L; 402; 8.5mm High Performance Wire; w/ Straight Non-Bendable Spark Plug Boot	10006
1972-1970	8 Cyl. 6.6L; 402; 8.5mm High Performance Wire; Equipped with Ceramic Spark Plug Boots	10114
1972-1970	8 Cyl. 6.6L; 402; 8.5mm High Performance Wire; w/ Straight Bendable Spark Plug Boot	10116
1969	8 Cyl. 5.4L; 8.5mm High Performance Wire; Equipped with Ceramic Spark Plug Boots; Routed Over Valve Cover	10079
1969	8 Cyl. 5.4L; 8.5mm High Performance Wire; Routed Over Valve Cover	10007
1969-1968	8 Cyl. 7.0L; 8.5mm High Performance Wire; w/ Straight Non-Bendable Spark Plug Boot	10006
1969-1968	8 Cyl. 6.5L; 8.5mm High Performance Wire; Equipped with Ceramic Spark Plug Boots	10114
1969-1968	8 Cyl. 6.5L; 8.5mm High Performance Wire; w/ Straight Non-Bendable Spark Plug Boot	10006
1969-1968	8 Cyl. 7.0L; 8.5mm High Performance Wire; Equipped with Ceramic Spark Plug Boots	10114
1969-1968	8 Cyl. 6.5L; 8.5mm High Performance Wire; w/ Straight Bendable Spark Plug Boot	10116
1969-1968	8 Cyl. 7.0L; 8.5mm High Performance Wire; w/ Straight Bendable Spark Plug Boot	10116
1968	8 Cyl. 5.0L; 8.5mm High Performance Wire; Equipped with Ceramic Spark Plug Boots; Routed Under Exhaust Manifold	10080
1968	8 Cyl. 5.0L; 8.5mm High Performance Wire; Routed Under Exhaust Manifold	10005
1968	8 Cyl.; 327; 8.5mm High Performance Wire; Routed Under Exhaust Manifold	10005
1968	8 Cyl.; 327; 8.5mm High Performance Wire; Equipped with Ceramic Spark Plug Boots; Routed Under Exhaust Manifold	10080
1967-1966	8 Cyl. 7.0L; 8.5mm High Performance Wire; Equipped with Ceramic Spark Plug Boots	10114
1967-1966	8 Cyl. 7.0L; 8.5mm High Performance Wire; w/ Straight Non-Bendable Spark Plug Boot	10006
1967-1966	8 Cyl. 7.0L; 8.5mm High Performance Wire; w/ Straight Bendable Spark Plug Boot	10116

Year	Model/Engine	Part No.
Spark Plug Wire Set		
Impala		
1967-1965	8 Cyl. 6.5L; 8.5mm High Performance Wire; Equipped with Ceramic Spark Plug Boots	10114
1967-1965	8 Cyl. 6.5L; 8.5mm High Performance Wire; w/ Straight Non-Bendable Spark Plug Boot	10006
1967-1965	8 Cyl. 6.5L; 8.5mm High Performance Wire; w/ Straight Bendable Spark Plug Boot	10116
1967-1964	8 Cyl. 5.4L; 8.5mm High Performance Wire; Equipped with Ceramic Spark Plug Boots; Routed Under Exhaust Manifold	10080
1967-1964	8 Cyl. 5.4L; 8.5mm High Performance Wire; Routed Under Exhaust Manifold	10005
1967-1962	8 Cyl. 4.6L; 8.5mm High Performance Wire; Equipped with Ceramic Spark Plug Boots; Routed Under Exhaust Manifold	10080
1967-1962	8 Cyl. 4.6L; 8.5mm High Performance Wire; Routed Under Exhaust Manifold	10005
1965-1961	8 Cyl. 6.7L; 8.5mm High Performance Wire	10008
1965-1961	8 Cyl. 6.7L; 8.5mm High Performance Wire; Equipped with Ceramic Spark Plug Boots	10059
1963	8 Cyl. 7.0L; 8.5mm High Performance Wire; Equipped with Ceramic Spark Plug Boots	10114
1963	8 Cyl. 7.0L; 8.5mm High Performance Wire; w/ Straight Non-Bendable Spark Plug Boot	10006
1963	8 Cyl. 7.0L; 8.5mm High Performance Wire; w/ Straight Bendable Spark Plug Boot	10116
1963-1962	8 Cyl. 5.3L; 8.5mm High Performance Wire; Routed Under Exhaust Manifold	10005
1963-1962	8 Cyl. 5.3L; 8.5mm High Performance Wire; Equipped with Ceramic Spark Plug Boots; Routed Under Exhaust Manifold	10080
1961-1959	8 Cyl.; 283; 8.5mm High Performance Wire; Equipped with Ceramic Spark Plug Boots; Routed Under Exhaust Manifold	10080
1961-1959	8 Cyl.; 283; 8.5mm High Performance Wire; Routed Under Exhaust Manifold	10005
1961-1959	8 Cyl. 5.7L; 8.5mm High Performance Wire	10008
1961-1959	8 Cyl. 5.7L; 8.5mm High Performance Wire; Equipped with Ceramic Spark Plug Boots	10059
K5 Blazer		
1986	8 Cyl. 5.7L; 9.0mm High Performance Wire; Calif.	10037
1986	8 Cyl. 5.7L; 8.5mm High Performance Wire; Equipped with Ceramic Spark Plug Boots; Fed.	10053
1986	8 Cyl. 5.7L; 8.5mm High Performance Wire; Calif.	10010
1986	8 Cyl. 5.7L; 9.0mm High Performance Wire; Fed.	10034
1986	8 Cyl. 5.7L; 8.5mm High Performance Wire; Fed.	10002
1986	8 Cyl. 5.7L; 8.5mm High Performance Wire; Calif.; Equipped with Ceramic Spark Plug Boots	10056
1986-1981	8 Cyl. 5.0L; 8.5mm High Performance Wire	10010
1986-1981	8 Cyl. 5.0L; 9.0mm High Performance Wire	10037
1986-1981	8 Cyl. 5.0L; 8.5mm High Performance Wire; Equipped with Ceramic Spark Plug Boots	10056

Chevrolet

Wire Sets

Year	Model/Engine	Part No.
Spark Plug Wire Set		
K5 Blazer		
1985-1981	8 Cyl. 5.7L; 8.5mm High Performance Wire	10010
1985-1981	8 Cyl. 5.7L; 8.5mm High Performance Wire; Equipped with Ceramic Spark Plug Boots	10056
1985-1981	8 Cyl. 5.7L; 9.0mm High Performance Wire	10037
1980-1977	8 Cyl. 5.0L; 9.0mm High Performance Wire	10034
1980-1977	8 Cyl. 5.0L; 8.5mm High Performance Wire; Equipped with Ceramic Spark Plug Boots	10053
1980-1977	8 Cyl. 5.0L; 8.5mm High Performance Wire	10002
1980-1975	8 Cyl. 5.7L; 8.5mm High Performance Wire; Equipped with Ceramic Spark Plug Boots	10053
1980-1975	8 Cyl. 5.7L; 9.0mm High Performance Wire	10034
1980-1975	8 Cyl. 5.7L; 8.5mm High Performance Wire	10002
1979-1975	8 Cyl. 6.6L; 8.5mm High Performance Wire; Equipped with Ceramic Spark Plug Boots	10053
1979-1975	8 Cyl. 6.6L; 8.5mm High Performance Wire	10002
1979-1975	8 Cyl. 6.6L; 9.0mm High Performance Wire	10034
1978-1977	8 Cyl. 7.4L; 8.5mm High Performance Wire; Equipped with Ceramic Spark Plug Boots	10069
1978-1977	8 Cyl. 7.4L; 8.5mm High Performance Wire	10001
1976	8 Cyl. 7.4L; 8.5mm High Performance Wire; Equipped with Ceramic Spark Plug Boots; w/o AC	10069
1976	8 Cyl. 7.4L; 8.5mm High Performance Wire; w/o AC	10001
K10		
1986	8 Cyl. 5.7L; L; 8.5mm High Performance Wire	10010
1986	8 Cyl. 5.7L; L; 9.0mm High Performance Wire	10037
1986	8 Cyl. 5.7L; L; 8.5mm High Performance Wire; Equipped with Ceramic Spark Plug Boots	10056
1986	8 Cyl. 5.7L; M; 8.5mm High Performance Wire; Calif.; Equipped with Ceramic Spark Plug Boots	10056
1986	8 Cyl. 5.7L; M; 8.5mm High Performance Wire; Fed.	10002
1986	8 Cyl. 5.7L; M; 9.0mm High Performance Wire; Calif.	10037
1986	8 Cyl. 5.7L; M; 8.5mm High Performance Wire; Calif.	10010
1986	8 Cyl. 5.7L; M; 8.5mm High Performance Wire; Equipped with Ceramic Spark Plug Boots; Fed.	10053
1986	8 Cyl. 5.7L; M; 9.0mm High Performance Wire; Fed.	10034
1986-1981	8 Cyl. 5.0L; 9.0mm High Performance Wire	10037
1986-1981	8 Cyl. 5.0L; 8.5mm High Performance Wire	10010
1986-1981	8 Cyl. 5.0L; 8.5mm High Performance Wire; Equipped with Ceramic Spark Plug Boots	10056
1985-1983	8 Cyl. 5.7L; 8.5mm High Performance Wire	10010

Year	Model/Engine	Part No.
Spark Plug Wire Set		
K10		
1985-1983	8 Cyl. 5.7L; 8.5mm High Performance Wire; Equipped with Ceramic Spark Plug Boots	10056
1985-1983	8 Cyl. 5.7L; 9.0mm High Performance Wire	10037
1982	8 Cyl. 5.7L; L; 8.5mm High Performance Wire	10010
1982	8 Cyl. 5.7L; L; 8.5mm High Performance Wire; Equipped with Ceramic Spark Plug Boots	10056
1982	8 Cyl. 5.7L; M; 9.0mm High Performance Wire	10034
1982	8 Cyl. 5.7L; M; 8.5mm High Performance Wire; Equipped with Ceramic Spark Plug Boots	10053
1982	8 Cyl. 5.7L; M; 8.5mm High Performance Wire	10002
1982-1981	8 Cyl. 5.7L; L; 9.0mm High Performance Wire	10037
1981	8 Cyl. 5.7L; L; 8.5mm High Performance Wire; Equipped with Ceramic Spark Plug Boots	10053
1981	8 Cyl. 5.7L; L; 8.5mm High Performance Wire; w/ Both 90 Deg. and Straight Plug Boots	10010
1981	8 Cyl. 5.7L; L; 9.0mm High Performance Wire; Fed.	10034
1981	8 Cyl. 5.7L; L; 8.5mm High Performance Wire	10002
1981	8 Cyl. 5.7L; L; 8.5mm High Performance Wire; Equipped with Ceramic Spark Plug Boots; w/ Both 90 Deg. and Straight Plug Boots	10056
1980-1979	8 Cyl. 7.4L; 8.5mm High Performance Wire	10001
1980-1979	8 Cyl. 7.4L; 8.5mm High Performance Wire; Equipped with Ceramic Spark Plug Boots	10069
1980-1975	8 Cyl. 6.6L; 8.5mm High Performance Wire; Equipped with Ceramic Spark Plug Boots	10053
1980-1975	8 Cyl. 5.7L; 8.5mm High Performance Wire	10002
1980-1975	8 Cyl. 5.7L; 8.5mm High Performance Wire; Equipped with Ceramic Spark Plug Boots	10053
1980-1975	8 Cyl. 5.7L; 9.0mm High Performance Wire	10034
1980-1975	8 Cyl. 6.6L; 9.0mm High Performance Wire	10034
1980-1975	8 Cyl. 6.6L; 8.5mm High Performance Wire	10002
1979-1977	8 Cyl. 5.0L; 8.5mm High Performance Wire; Equipped with Ceramic Spark Plug Boots	10053
1979-1977	8 Cyl. 5.0L; 8.5mm High Performance Wire	10002
1979-1977	8 Cyl. 5.0L; 9.0mm High Performance Wire	10034
1976	8 Cyl. 7.4L; 8.5mm High Performance Wire; w/o AC	10001
1976	8 Cyl. 7.4L; 8.5mm High Performance Wire; Equipped with Ceramic Spark Plug Boots; w/o AC	10069
K10 Pickup		
1974	8 Cyl. 5.7L; 8.5mm High Performance Wire; Routed Over Valve Cover	10007
1974	8 Cyl. 5.7L; 8.5mm High Performance Wire; Equipped with Ceramic Spark Plug Boots; Routed Over Valve Cover	10079

Wire Sets

Year	Model/Engine	Part No.
Spark Plug Wire Set		
K10 Pickup		
1974-1973	8 Cyl. 7.4L; 8.5mm High Performance Wire; Equipped with Ceramic Spark Plug Boots	10114
1974-1973	8 Cyl. 7.4L; 8.5mm High Performance Wire; w/ Straight Non-Bendable Spark Plug Boot	10006
1974-1973	8 Cyl. 7.4L; 8.5mm High Performance Wire; w/ Straight Bendable Spark Plug Boot	10116
1973-1969	8 Cyl. 5.7L; 8.5mm High Performance Wire; Routed Under Exhaust Manifold	10005
1973-1969	8 Cyl. 5.7L; 8.5mm High Performance Wire; Equipped with Ceramic Spark Plug Boots; Routed Under Exhaust Manifold	10080
1973-1968	8 Cyl. 5.0L; 8.5mm High Performance Wire; Routed Under Exhaust Manifold	10005
1973-1968	8 Cyl. 5.0L; 8.5mm High Performance Wire; Equipped with Ceramic Spark Plug Boots; Routed Under Exhaust Manifold	10080
1972-1970	8 Cyl. 6.6L; 8.5mm High Performance Wire; Equipped with Ceramic Spark Plug Boots	10114
1972-1970	8 Cyl. 6.6L; 8.5mm High Performance Wire; w/ Straight Non-Bendable Spark Plug Boot	10006
1972-1970	8 Cyl. 6.6L; 8.5mm High Performance Wire; w/ Straight Bendable Spark Plug Boot	10116
1969-1968	8 Cyl. 6.5L; 8.5mm High Performance Wire; Equipped with Ceramic Spark Plug Boots	10114
1969-1968	8 Cyl. 6.5L; 8.5mm High Performance Wire; w/ Straight Non-Bendable Spark Plug Boot	10006
1969-1968	8 Cyl. 6.5L; 8.5mm High Performance Wire; w/ Straight Bendable Spark Plug Boot	10116
1968	8 Cyl. 5.4L; 8.5mm High Performance Wire; Routed Under Exhaust Manifold	10005
1968	8 Cyl. 5.4L; 8.5mm High Performance Wire; Equipped with Ceramic Spark Plug Boots; Routed Under Exhaust Manifold	10080
1967-1966	8 Cyl. 5.3L; 8.5mm High Performance Wire; Routed Under Exhaust Manifold	10005
1967-1966	8 Cyl. 5.3L; 8.5mm High Performance Wire; Equipped with Ceramic Spark Plug Boots; Routed Under Exhaust Manifold	10080
1967-1961	8 Cyl. 4.6L; 8.5mm High Performance Wire; Equipped with Ceramic Spark Plug Boots; Routed Under Exhaust Manifold	10080
1967-1961	8 Cyl. 4.6L; 8.5mm High Performance Wire; Routed Under Exhaust Manifold	10005
K10 Suburban		
1986	8 Cyl. 5.7L; L; 8.5mm High Performance Wire; Equipped with Ceramic Spark Plug Boots	10056
1986	8 Cyl. 5.7L; L; 9.0mm High Performance Wire	10037
1986	8 Cyl. 5.7L; L; 8.5mm High Performance Wire	10010
1986	8 Cyl. 5.7L; M; 8.5mm High Performance Wire; Calif.; Equipped with Ceramic Spark Plug Boots	10056
1986	8 Cyl. 5.7L; M; 9.0mm High Performance Wire; Calif.	10037
1986	8 Cyl. 5.7L; M; 8.5mm High Performance Wire; Calif.	10010
1986	8 Cyl. 5.7L; M; 9.0mm High Performance Wire; Fed.	10034

Year	Model/Engine	Part No.
Spark Plug Wire Set		
K10 Suburban		
1986	8 Cyl. 5.7L; M; 8.5mm High Performance Wire; Equipped with Ceramic Spark Plug Boots; Fed.	10053
1986	8 Cyl. 5.7L; M; 8.5mm High Performance Wire; Fed.	10002
1986-1981	8 Cyl. 5.0L; 8.5mm High Performance Wire; Equipped with Ceramic Spark Plug Boots	10056
1986-1981	8 Cyl. 5.0L; 9.0mm High Performance Wire	10037
1986-1981	8 Cyl. 5.0L; 8.5mm High Performance Wire	10010
1985-1983	8 Cyl. 5.7L; 8.5mm High Performance Wire	10010
1985-1983	8 Cyl. 5.7L; 9.0mm High Performance Wire	10037
1985-1983	8 Cyl. 5.7L; 8.5mm High Performance Wire; Equipped with Ceramic Spark Plug Boots	10056
1982-1981	8 Cyl. 5.7L; L; 8.5mm High Performance Wire; Equipped with Ceramic Spark Plug Boots	10056
1982-1981	8 Cyl. 5.7L; L; 9.0mm High Performance Wire	10037
1982-1981	8 Cyl. 5.7L; L; 8.5mm High Performance Wire	10010
1980-1976	8 Cyl. 5.0L; 8.5mm High Performance Wire	10002
1980-1976	8 Cyl. 5.0L; 9.0mm High Performance Wire	10034
1980-1976	8 Cyl. 5.0L; 8.5mm High Performance Wire; Equipped with Ceramic Spark Plug Boots	10053
1980-1975	8 Cyl. 5.7L; 8.5mm High Performance Wire; Equipped with Ceramic Spark Plug Boots	10053
1980-1975	8 Cyl. 5.7L; 9.0mm High Performance Wire	10034
1980-1975	8 Cyl. 5.7L; 8.5mm High Performance Wire	10002
1979-1975	8 Cyl. 6.6L; 9.0mm High Performance Wire	10034
1979-1975	8 Cyl. 6.6L; 8.5mm High Performance Wire; Equipped with Ceramic Spark Plug Boots	10053
1979-1975	8 Cyl. 6.6L; 8.5mm High Performance Wire	10002
1974	8 Cyl. 5.7L; 8.5mm High Performance Wire; Equipped with Ceramic Spark Plug Boots; Routed Over Valve Cover	10079
1974	8 Cyl. 5.7L; 8.5mm High Performance Wire; Routed Over Valve Cover	10007
1974-1973	8 Cyl. 7.4L; 8.5mm High Performance Wire; Equipped with Ceramic Spark Plug Boots	10114
1974-1973	8 Cyl. 7.4L; 8.5mm High Performance Wire; w/ Straight Non-Bendable Spark Plug Boot	10006
1974-1973	8 Cyl. 7.4L; 8.5mm High Performance Wire; w/ Straight Bendable Spark Plug Boot	10116
1973-1969	8 Cyl. 5.7L; 8.5mm High Performance Wire; Routed Under Exhaust Manifold	10005
1973-1969	8 Cyl. 5.7L; 8.5mm High Performance Wire; Equipped with Ceramic Spark Plug Boots; Routed Under Exhaust Manifold	10080
1973-1968	8 Cyl. 5.0L; 8.5mm High Performance Wire; Routed Under Exhaust Manifold	10005

Wire Sets

Year	Model/Engine	Part No.
Spark Plug Wire Set		
K10 Suburban		
1973-1968	8 Cyl. 5.0L; 8.5mm High Performance Wire; Equipped with Ceramic Spark Plug Boots; Routed Under Exhaust Manifold	10080
1972-1970	8 Cyl. 6.6L; 8.5mm High Performance Wire; w/ Straight Non-Bendable Spark Plug Boot	10006
1972-1970	8 Cyl. 6.6L; 8.5mm High Performance Wire; Equipped with Ceramic Spark Plug Boots	10114
1972-1970	8 Cyl. 6.6L; 8.5mm High Performance Wire; w/ Straight Bendable Spark Plug Boot	10116
1969-1968	8 Cyl. 6.5L; 8.5mm High Performance Wire; w/ Straight Non-Bendable Spark Plug Boot	10006
1969-1968	8 Cyl. 6.5L; 8.5mm High Performance Wire; Equipped with Ceramic Spark Plug Boots	10114
1969-1968	8 Cyl. 6.5L; 8.5mm High Performance Wire; w/ Straight Bendable Spark Plug Boot	10116
1968	8 Cyl. 5.4L; 8.5mm High Performance Wire; Equipped with Ceramic Spark Plug Boots; Routed Under Exhaust Manifold	10080
1968	8 Cyl. 5.4L; 8.5mm High Performance Wire; Routed Under Exhaust Manifold	10005
1967-1966	8 Cyl. 5.3L; 8.5mm High Performance Wire; Equipped with Ceramic Spark Plug Boots; Routed Under Exhaust Manifold	10080
1967-1966	8 Cyl. 5.3L; 8.5mm High Performance Wire; Routed Under Exhaust Manifold	10005
1967-1961	8 Cyl. 4.6L; 8.5mm High Performance Wire; Routed Under Exhaust Manifold	10005
1967-1961	8 Cyl. 4.6L; 8.5mm High Performance Wire; Equipped with Ceramic Spark Plug Boots; Routed Under Exhaust Manifold	10080
1965	8 Cyl. 6.7L; 8.5mm High Performance Wire; Equipped with Ceramic Spark Plug Boots	10059
1965	8 Cyl. 5.7L; 8.5mm High Performance Wire; Equipped with Ceramic Spark Plug Boots	10059
1965	8 Cyl. 6.7L; 8.5mm High Performance Wire	10008
1965	8 Cyl. 5.7L; 8.5mm High Performance Wire	10008
1964	8 Cyl. 5.7L; 8.5mm High Performance Wire; Equipped with Ceramic Spark Plug Boots; Routed Under Exhaust Manifold	10080
1964	8 Cyl. 5.7L; 8.5mm High Performance Wire; Routed Under Exhaust Manifold	10005
1964	8 Cyl. 6.7L; 8.5mm High Performance Wire; Routed Under Exhaust Manifold	10005
1964	8 Cyl. 6.7L; 8.5mm High Performance Wire; Equipped with Ceramic Spark Plug Boots; Routed Under Exhaust Manifold	10080
1962	8 Cyl. 6.7L; 8.5mm High Performance Wire; Routed Under Exhaust Manifold	10005
1962	8 Cyl. 6.7L; 8.5mm High Performance Wire; Equipped with Ceramic Spark Plug Boots; Routed Under Exhaust Manifold	10080
1962-1961	8 Cyl. 5.7L; 8.5mm High Performance Wire; Equipped with Ceramic Spark Plug Boots; Routed Under Exhaust Manifold	10080
1962-1961	8 Cyl. 5.7L; 8.5mm High Performance Wire; Routed Under Exhaust Manifold	10005
K20		
1986	8 Cyl. 5.7L; M; 8.5mm High Performance Wire; Fed.	10002

Year	Model/Engine	Part No.
Spark Plug Wire Set		
K20		
1986	8 Cyl. 5.7L; M; 9.0mm High Performance Wire; Calif.	10037
1986	8 Cyl. 5.7L; M; 8.5mm High Performance Wire; Calif.	10010
1986	8 Cyl. 5.7L; M; 8.5mm High Performance Wire; Equipped with Ceramic Spark Plug Boots; Fed.	10053
1986	8 Cyl. 5.7L; M; 9.0mm High Performance Wire; Fed.	10034
1986	8 Cyl. 5.7L; M; 8.5mm High Performance Wire; Calif.; Equipped with Ceramic Spark Plug Boots	10056
1986-1985	8 Cyl. 5.7L; L; 8.5mm High Performance Wire; Equipped with Ceramic Spark Plug Boots	10056
1986-1985	8 Cyl. 5.7L; L; 8.5mm High Performance Wire	10010
1986-1985	8 Cyl. 5.7L; L; 9.0mm High Performance Wire	10037
1985	8 Cyl. 5.0L; 8.5mm High Performance Wire; Equipped with Ceramic Spark Plug Boots	10056
1985	8 Cyl. 5.0L; 8.5mm High Performance Wire	10010
1985	8 Cyl. 5.0L; 9.0mm High Performance Wire	10037
1985	8 Cyl. 5.7L; M; 9.0mm High Performance Wire	10034
1985	8 Cyl. 5.7L; M; 9.0mm High Performance Wire; w/ Cast Iron Exhaust Manifold	10037
1985	8 Cyl. 5.7L; M; 8.5mm High Performance Wire; w/ Both 90 Deg. and Straight Plug Boots	10010
1985	8 Cyl. 5.7L; M; 8.5mm High Performance Wire; Equipped with Ceramic Spark Plug Boots; w/ Both 90 Deg. and Straight Plug Boots	10056
1985	8 Cyl. 5.7L; M; 8.5mm High Performance Wire; Equipped with Ceramic Spark Plug Boots; w/ 90 Deg. Plug Boot	10053
1985	8 Cyl. 5.7L; M; 8.5mm High Performance Wire; w/ 90 Deg. Plug Boot	10002
1984-1983	8 Cyl. 5.7L; 8.5mm High Performance Wire; Equipped with Ceramic Spark Plug Boots	10056
1984-1983	8 Cyl. 5.7L; 8.5mm High Performance Wire	10010
1984-1983	8 Cyl. 5.7L; 9.0mm High Performance Wire	10037
1982-1981	8 Cyl. 5.7L; L; 8.5mm High Performance Wire; Equipped with Ceramic Spark Plug Boots	10056
1982-1981	8 Cyl. 5.7L; L; 8.5mm High Performance Wire	10010
1982-1981	8 Cyl. 5.7L; L; 9.0mm High Performance Wire	10037
1982-1981	8 Cyl. 5.7L; M; 9.0mm High Performance Wire	10034
1982-1981	8 Cyl. 5.7L; M; 8.5mm High Performance Wire	10002
1982-1981	8 Cyl. 5.7L; M; 8.5mm High Performance Wire; Equipped with Ceramic Spark Plug Boots	10053
1980	8 Cyl. 5.0L; 9.0mm High Performance Wire	10034
1980	8 Cyl. 5.0L; 8.5mm High Performance Wire	10002
1980	8 Cyl. 7.4L; 8.5mm High Performance Wire	10001

Wire Sets

Year	Model/Engine	Part No.
Spark Plug Wire Set		
K20		
1980	8 Cyl. 7.4L; 8.5mm High Performance Wire; Equipped with Ceramic Spark Plug Boots	10069
1980	8 Cyl. 5.0L; 8.5mm High Performance Wire; Equipped with Ceramic Spark Plug Boots	10053
1980-1975	8 Cyl. 6.6L; 8.5mm High Performance Wire	10002
1980-1975	8 Cyl. 6.6L; 8.5mm High Performance Wire; Equipped with Ceramic Spark Plug Boots	10053
1980-1975	8 Cyl. 5.7L; 8.5mm High Performance Wire	10002
1980-1975	8 Cyl. 6.6L; 9.0mm High Performance Wire	10034
1980-1975	8 Cyl. 5.7L; 8.5mm High Performance Wire; Equipped with Ceramic Spark Plug Boots	10053
1980-1975	8 Cyl. 5.7L; 9.0mm High Performance Wire	10034
1978	8 Cyl. 5.0L; 8.5mm High Performance Wire; Equipped with Ceramic Spark Plug Boots	10053
1978-1977	8 Cyl. 5.0L; 9.0mm High Performance Wire	10034
1978-1977	8 Cyl. 5.0L; 8.5mm High Performance Wire	10002
1978-1977	8 Cyl. 7.4L; 8.5mm High Performance Wire	10001
1978-1977	8 Cyl. 7.4L; 8.5mm High Performance Wire; Equipped with Ceramic Spark Plug Boots	10069
1976	8 Cyl. 7.4L; 8.5mm High Performance Wire; w/o AC	10001
1976	8 Cyl. 7.4L; 8.5mm High Performance Wire; Equipped with Ceramic Spark Plug Boots; w/o AC	10069
K20 Pickup		
1974-1973	8 Cyl. 5.7L; 8.5mm High Performance Wire; Routed Over Valve Cover	10007
1974-1973	8 Cyl. 7.4L; 8.5mm High Performance Wire; w/ Straight Non-Bendable Spark Plug Boot	10006
1974-1973	8 Cyl. 5.7L; 8.5mm High Performance Wire; Equipped with Ceramic Spark Plug Boots; Routed Over Valve Cover	10079
1974-1973	8 Cyl. 7.4L; 8.5mm High Performance Wire; Equipped with Ceramic Spark Plug Boots	10114
1974-1973	8 Cyl. 7.4L; 8.5mm High Performance Wire; w/ Straight Bendable Spark Plug Boot	10116
1973	8 Cyl. 5.0L; 8.5mm High Performance Wire; Routed Over Valve Cover	10007
1973	8 Cyl. 5.0L; 8.5mm High Performance Wire; Equipped with Ceramic Spark Plug Boots; Routed Over Valve Cover	10079
1972-1970	8 Cyl. 6.6L; 8.5mm High Performance Wire; Equipped with Ceramic Spark Plug Boots	10114
1972-1970	8 Cyl. 6.6L; 8.5mm High Performance Wire; w/ Straight Non-Bendable Spark Plug Boot	10006
1972-1970	8 Cyl. 6.6L; 8.5mm High Performance Wire; w/ Straight Bendable Spark Plug Boot	10116
1972-1969	8 Cyl. 5.7L; 8.5mm High Performance Wire; Routed Under Exhaust Manifold	10005

Year	Model/Engine	Part No.
Spark Plug Wire Set		
K20 Pickup		
1972-1969	8 Cyl. 5.7L; 8.5mm High Performance Wire; Equipped with Ceramic Spark Plug Boots; Routed Under Exhaust Manifold	10080
1972-1968	8 Cyl. 5.0L; 8.5mm High Performance Wire; Equipped with Ceramic Spark Plug Boots; Routed Under Exhaust Manifold	10080
1972-1968	8 Cyl. 5.0L; 8.5mm High Performance Wire; Routed Under Exhaust Manifold	10005
1969-1968	8 Cyl. 6.5L; 8.5mm High Performance Wire; w/ Straight Non-Bendable Spark Plug Boot	10006
1969-1968	8 Cyl. 6.5L; 8.5mm High Performance Wire; Equipped with Ceramic Spark Plug Boots	10114
1969-1968	8 Cyl. 6.5L; 8.5mm High Performance Wire; w/ Straight Bendable Spark Plug Boot	10116
1968	8 Cyl. 5.4L; 8.5mm High Performance Wire; Equipped with Ceramic Spark Plug Boots; Routed Under Exhaust Manifold	10080
1968	8 Cyl. 5.4L; 8.5mm High Performance Wire; Routed Under Exhaust Manifold	10005
1967-1966	8 Cyl. 5.3L; 8.5mm High Performance Wire; Equipped with Ceramic Spark Plug Boots; Routed Under Exhaust Manifold	10080
1967-1966	8 Cyl. 5.3L; 8.5mm High Performance Wire; Routed Under Exhaust Manifold	10005
1967-1961	8 Cyl. 4.6L; 8.5mm High Performance Wire; Routed Under Exhaust Manifold	10005
1967-1961	8 Cyl. 4.6L; 8.5mm High Performance Wire; Equipped with Ceramic Spark Plug Boots; Routed Under Exhaust Manifold	10080
1965	8 Cyl. 5.7L; 8.5mm High Performance Wire	10008
1965	8 Cyl. 5.7L; 8.5mm High Performance Wire; Equipped with Ceramic Spark Plug Boots	10059
1965	8 Cyl. 6.7L; 8.5mm High Performance Wire	10008
1965	8 Cyl. 6.7L; 8.5mm High Performance Wire; Equipped with Ceramic Spark Plug Boots	10059
1964	8 Cyl. 6.7L; 8.5mm High Performance Wire; Equipped with Ceramic Spark Plug Boots; Routed Under Exhaust Manifold	10080
1964	8 Cyl. 5.7L; 8.5mm High Performance Wire; Equipped with Ceramic Spark Plug Boots; Routed Under Exhaust Manifold	10080
1964	8 Cyl. 5.7L; 8.5mm High Performance Wire; Routed Under Exhaust Manifold	10005
1964	8 Cyl. 6.7L; 8.5mm High Performance Wire; Routed Under Exhaust Manifold	10005
1962	8 Cyl. 6.7L; 8.5mm High Performance Wire; Equipped with Ceramic Spark Plug Boots; Routed Under Exhaust Manifold	10080
1962	8 Cyl. 6.7L; 8.5mm High Performance Wire; Routed Under Exhaust Manifold	10005
1962-1961	8 Cyl. 5.7L; 8.5mm High Performance Wire; Equipped with Ceramic Spark Plug Boots; Routed Under Exhaust Manifold	10080
1962-1961	8 Cyl. 5.7L; 8.5mm High Performance Wire; Routed Under Exhaust Manifold	10005
K20 Suburban		
1986	8 Cyl. 5.7L; L; 9.0mm High Performance Wire	10037
1986	8 Cyl. 5.7L; L; 8.5mm High Performance Wire	10010
1986	8 Cyl. 5.7L; L; 8.5mm High Performance Wire; Equipped with Ceramic Spark Plug Boots	10056

Chevrolet

Wire Sets

Year	Model/Engine	Part No.
Spark Plug Wire Set		
K20 Suburban		
1986	8 Cyl. 5.7L; M; 9.0mm High Performance Wire; Calif.	10037
1986	8 Cyl. 5.7L; M; 8.5mm High Performance Wire; Equipped with Ceramic Spark Plug Boots; Fed.	10053
1986	8 Cyl. 5.7L; M; 8.5mm High Performance Wire; Calif.; Equipped with Ceramic Spark Plug Boots	10056
1986	8 Cyl. 5.7L; M; 8.5mm High Performance Wire; Calif.	10010
1986	8 Cyl. 5.7L; M; 9.0mm High Performance Wire; Fed.	10034
1986	8 Cyl. 5.7L; M; 8.5mm High Performance Wire; Fed.	10002
1986-1985	8 Cyl. 5.0L; 8.5mm High Performance Wire	10010
1986-1985	8 Cyl. 5.0L; 8.5mm High Performance Wire; Equipped with Ceramic Spark Plug Boots	10056
1986-1985	8 Cyl. 5.0L; 9.0mm High Performance Wire	10037
1985	8 Cyl. 7.4L; 8.5mm High Performance Wire; w/ Stainless Steel Exhaust Manifold	10064
1985	8 Cyl. 7.4L; 8.5mm High Performance Wire; Equipped with Ceramic Spark Plug Boots; w/ Stainless Steel Exhaust Manifold	10065
1985	8 Cyl. 7.4L; 8.5mm High Performance Wire; Equipped with Ceramic Spark Plug Boots; w/ Cast Iron Exhaust Manifold	10069
1985	8 Cyl. 7.4L; 8.5mm High Performance Wire; w/ Cast Iron Exhaust Manifold	10001
1985-1983	8 Cyl. 5.7L; 8.5mm High Performance Wire	10010
1985-1983	8 Cyl. 5.7L; 9.0mm High Performance Wire	10037
1985-1983	8 Cyl. 5.7L; 8.5mm High Performance Wire; Equipped with Ceramic Spark Plug Boots	10056
1982	8 Cyl. 5.7L; 9.0mm High Performance Wire	10034
1982	8 Cyl. 5.7L; 8.5mm High Performance Wire	10002
1982	8 Cyl. 5.7L; 8.5mm High Performance Wire; Equipped with Ceramic Spark Plug Boots	10053
1981	8 Cyl. 5.7L; L; 9.0mm High Performance Wire	10037
1981	8 Cyl. 5.7L; L; 8.5mm High Performance Wire	10010
1981	8 Cyl. 5.7L; L; 8.5mm High Performance Wire; Equipped with Ceramic Spark Plug Boots	10056
1981	8 Cyl. 5.7L; M; 8.5mm High Performance Wire	10002
1981	8 Cyl. 5.7L; M; 8.5mm High Performance Wire; Equipped with Ceramic Spark Plug Boots	10053
1981	8 Cyl. 5.7L; M; 9.0mm High Performance Wire	10034
1980-1975	8 Cyl. 6.6L; 8.5mm High Performance Wire; Equipped with Ceramic Spark Plug Boots	10053
1980-1975	8 Cyl. 6.6L; 9.0mm High Performance Wire	10034
1980-1975	8 Cyl. 5.7L; 9.0mm High Performance Wire	10034
1980-1975	8 Cyl. 5.7L; 8.5mm High Performance Wire	10002

Year	Model/Engine	Part No.
Spark Plug Wire Set		
K20 Suburban		
1980-1975	8 Cyl. 6.6L; 8.5mm High Performance Wire	10002
1980-1975	8 Cyl. 5.7L; 8.5mm High Performance Wire; Equipped with Ceramic Spark Plug Boots	10053
1978-1977	8 Cyl. 5.0L; 8.5mm High Performance Wire	10002
1978-1977	8 Cyl. 5.0L; 9.0mm High Performance Wire	10034
1978-1977	8 Cyl. 5.0L; 8.5mm High Performance Wire; Equipped with Ceramic Spark Plug Boots	10053
1974	8 Cyl. 5.7L; 8.5mm High Performance Wire; Routed Over Valve Cover	10007
1974	8 Cyl. 5.7L; 8.5mm High Performance Wire; Equipped with Ceramic Spark Plug Boots; Routed Over Valve Cover	10079
1974-1973	8 Cyl. 7.4L; 8.5mm High Performance Wire; Equipped with Ceramic Spark Plug Boots	10114
1974-1973	8 Cyl. 7.4L; 8.5mm High Performance Wire; w/ Straight Non-Bendable Spark Plug Boot	10006
1974-1973	8 Cyl. 7.4L; 8.5mm High Performance Wire; w/ Straight Bendable Spark Plug Boot	10116
1973-1969	8 Cyl. 5.7L; 8.5mm High Performance Wire; Routed Under Exhaust Manifold	10005
1973-1969	8 Cyl. 5.7L; 8.5mm High Performance Wire; Equipped with Ceramic Spark Plug Boots; Routed Under Exhaust Manifold	10080
1973-1968	8 Cyl. 5.0L; 8.5mm High Performance Wire; Routed Under Exhaust Manifold	10005
1973-1968	8 Cyl. 5.0L; 8.5mm High Performance Wire; Equipped with Ceramic Spark Plug Boots; Routed Under Exhaust Manifold	10080
1972-1970	8 Cyl. 6.6L; 8.5mm High Performance Wire; w/ Straight Non-Bendable Spark Plug Boot	10006
1972-1970	8 Cyl. 6.6L; 8.5mm High Performance Wire; Equipped with Ceramic Spark Plug Boots	10114
1972-1970	8 Cyl. 6.6L; 8.5mm High Performance Wire; w/ Straight Bendable Spark Plug Boot	10116
1969-1968	8 Cyl. 6.5L; 8.5mm High Performance Wire; Equipped with Ceramic Spark Plug Boots	10114
1969-1968	8 Cyl. 6.5L; 8.5mm High Performance Wire; w/ Straight Non-Bendable Spark Plug Boot	10006
1969-1968	8 Cyl. 6.5L; 8.5mm High Performance Wire; w/ Straight Bendable Spark Plug Boot	10116
1968	8 Cyl. 5.4L; 8.5mm High Performance Wire; Routed Under Exhaust Manifold	10005
1968	8 Cyl. 5.4L; 8.5mm High Performance Wire; Equipped with Ceramic Spark Plug Boots; Routed Under Exhaust Manifold	10080
1967-1961	8 Cyl. 4.6L; 8.5mm High Performance Wire; Routed Under Exhaust Manifold	10005
1967-1961	8 Cyl. 4.6L; 8.5mm High Performance Wire; Equipped with Ceramic Spark Plug Boots; Routed Under Exhaust Manifold	10080
1966	8 Cyl. 5.3L; 8.5mm High Performance Wire; Equipped with Ceramic Spark Plug Boots; Routed Under Exhaust Manifold	10080
1966	8 Cyl. 5.3L; 8.5mm High Performance Wire; Routed Under Exhaust Manifold	10005
1965	8 Cyl. 5.7L; 8.5mm High Performance Wire	10008

Wire Sets

Year	Model/Engine	Part No.
Spark Plug Wire Set		
K20 Suburban		
1965	8 Cyl. 6.7L; 8.5mm High Performance Wire	10008
1965	8 Cyl. 5.7L; 8.5mm High Performance Wire; Equipped with Ceramic Spark Plug Boots	10059
1965	8 Cyl. 6.7L; 8.5mm High Performance Wire; Equipped with Ceramic Spark Plug Boots	10059
1964	8 Cyl. 6.7L; 8.5mm High Performance Wire; Routed Under Exhaust Manifold	10005
1964	8 Cyl. 5.7L; 8.5mm High Performance Wire; Equipped with Ceramic Spark Plug Boots; Routed Under Exhaust Manifold	10080
1964	8 Cyl. 5.7L; 8.5mm High Performance Wire; Routed Under Exhaust Manifold	10005
1964	8 Cyl. 6.7L; 8.5mm High Performance Wire; Equipped with Ceramic Spark Plug Boots; Routed Under Exhaust Manifold	10080
1962	8 Cyl. 6.7L; 8.5mm High Performance Wire; Routed Under Exhaust Manifold	10005
1962	8 Cyl. 6.7L; 8.5mm High Performance Wire; Equipped with Ceramic Spark Plug Boots; Routed Under Exhaust Manifold	10080
1962-1961	8 Cyl. 5.7L; 8.5mm High Performance Wire; Equipped with Ceramic Spark Plug Boots; Routed Under Exhaust Manifold	10080
1962-1961	8 Cyl. 5.7L; 8.5mm High Performance Wire; Routed Under Exhaust Manifold	10005
K30		
1986	8 Cyl. 5.7L; 9.0mm High Performance Wire; Calif.	10037
1986	8 Cyl. 7.4L; 8.5mm High Performance Wire; Calif.; Equipped with Ceramic Spark Plug Boots	10069
1986	8 Cyl. 5.7L; 8.5mm High Performance Wire; Calif.; Equipped with Ceramic Spark Plug Boots	10056
1986	8 Cyl. 7.4L; 8.5mm High Performance Wire; Calif.	10001
1986	8 Cyl. 5.7L; 8.5mm High Performance Wire; Equipped with Ceramic Spark Plug Boots; Fed.	10053
1986	8 Cyl. 7.4L; 8.5mm High Performance Wire; Fed.	10064
1986	8 Cyl. 5.7L; 8.5mm High Performance Wire; Fed.	10002
1986	8 Cyl. 5.7L; 8.5mm High Performance Wire; Calif.	10010
1986	8 Cyl. 5.7L; 9.0mm High Performance Wire; Fed.	10034
1986	8 Cyl. 7.4L; 8.5mm High Performance Wire; Equipped with Ceramic Spark Plug Boots; Fed.	10065
1985	8 Cyl. 7.4L; 8.5mm High Performance Wire; w/ Cast Iron Exhaust Manifold	10001
1985	8 Cyl. 7.4L; 8.5mm High Performance Wire; Equipped with Ceramic Spark Plug Boots; w/ Cast Iron Exhaust Manifold	10069
1985	8 Cyl. 7.4L; 8.5mm High Performance Wire; Equipped with Ceramic Spark Plug Boots; w/ Stainless Steel Exhaust Manifold	10065
1985	8 Cyl. 7.4L; 8.5mm High Performance Wire; w/ Stainless Steel Exhaust Manifold	10064
1985	8 Cyl. 5.7L; L; 8.5mm High Performance Wire	10010
1985	8 Cyl. 5.7L; L; 9.0mm High Performance Wire	10037

Year	Model/Engine	Part No.
Spark Plug Wire Set		
K30		
1985	8 Cyl. 5.7L; L; 8.5mm High Performance Wire; Equipped with Ceramic Spark Plug Boots	10056
1985	8 Cyl. 5.7L; M; 8.5mm High Performance Wire; Equipped with Ceramic Spark Plug Boots; w/ Both 90 Deg. and Straight Plug Boots	10056
1985	8 Cyl. 5.7L; M; 8.5mm High Performance Wire; w/ Both 90 Deg. and Straight Plug Boots	10010
1985	8 Cyl. 5.7L; M; 9.0mm High Performance Wire	10034
1985	8 Cyl. 5.7L; M; 9.0mm High Performance Wire; w/ Cast Iron Exhaust Manifold	10037
1985	8 Cyl. 5.7L; M; 8.5mm High Performance Wire; w/ 90 Deg. Plug Boot	10002
1985	8 Cyl. 5.7L; M; 8.5mm High Performance Wire; Equipped with Ceramic Spark Plug Boots; w/ 90 Degree Plug Wire Boot	10053
1984-1983	8 Cyl. 5.7L; 8.5mm High Performance Wire; Equipped with Ceramic Spark Plug Boots	10056
1984-1983	8 Cyl. 5.7L; 8.5mm High Performance Wire	10010
1984-1983	8 Cyl. 5.7L; 9.0mm High Performance Wire	10037
1984-1980	8 Cyl. 7.4L; 8.5mm High Performance Wire; Equipped with Ceramic Spark Plug Boots	10069
1984-1980	8 Cyl. 7.4L; 8.5mm High Performance Wire	10001
1982	8 Cyl. 5.7L; L; 8.5mm High Performance Wire	10010
1982	8 Cyl. 5.7L; L; 9.0mm High Performance Wire	10037
1982	8 Cyl. 5.7L; L; 8.5mm High Performance Wire; Equipped with Ceramic Spark Plug Boots	10056
1982	8 Cyl. 5.7L; M; 8.5mm High Performance Wire	10002
1982	8 Cyl. 5.7L; M; 9.0mm High Performance Wire	10034
1982	8 Cyl. 5.7L; M; 8.5mm High Performance Wire; Equipped with Ceramic Spark Plug Boots	10053
1981-1977	8 Cyl. 5.7L; 8.5mm High Performance Wire	10002
1981-1977	8 Cyl. 5.7L; 8.5mm High Performance Wire; Equipped with Ceramic Spark Plug Boots	10053
1981-1977	8 Cyl. 5.7L; 9.0mm High Performance Wire	10034
1980-1977	8 Cyl. 6.6L; 9.0mm High Performance Wire	10034
1980-1977	8 Cyl. 6.6L; 8.5mm High Performance Wire; Equipped with Ceramic Spark Plug Boots	10053
1980-1977	8 Cyl. 6.6L; 8.5mm High Performance Wire	10002
1977	8 Cyl. 7.4L; 8.5mm High Performance Wire; Equipped with Ceramic Spark Plug Boots	10069
1977	8 Cyl. 7.4L; 8.5mm High Performance Wire	10001
K30 Pickup		
1974	8 Cyl. 5.7L; 8.5mm High Performance Wire; Routed Over Valve Cover	10007
1974	8 Cyl. 5.7L; 8.5mm High Performance Wire; Equipped with Ceramic Spark Plug Boots; Routed Over Valve Cover	10079

Wire Sets

Year	Model/Engine	Part No.
Spark Plug Wire Set		
K30 Pickup		
1974-1973	8 Cyl. 7.4L; 8.5mm High Performance Wire; Equipped with Ceramic Spark Plug Boots	10114
1974-1973	8 Cyl. 7.4L; 8.5mm High Performance Wire; w/ Straight Non-Bendable Spark Plug Boot	10006
1974-1973	8 Cyl. 7.4L; 8.5mm High Performance Wire; w/ Straight Bendable Spark Plug Boot	10116
1973-1969	8 Cyl. 5.7L; 8.5mm High Performance Wire; Equipped with Ceramic Spark Plug Boots; Routed Under Exhaust Manifold	10080
1973-1969	8 Cyl. 5.7L; 8.5mm High Performance Wire; Routed Under Exhaust Manifold	10005
1973-1968	8 Cyl. 5.0L; 8.5mm High Performance Wire; Routed Under Exhaust Manifold	10005
1973-1968	8 Cyl. 5.0L; 8.5mm High Performance Wire; Equipped with Ceramic Spark Plug Boots; Routed Under Exhaust Manifold	10080
1972-1970	8 Cyl. 6.6L; 8.5mm High Performance Wire; w/ Straight Non-Bendable Spark Plug Boot	10006
1972-1970	8 Cyl. 6.6L; 8.5mm High Performance Wire; Equipped with Ceramic Spark Plug Boots	10114
1972-1970	8 Cyl. 6.6L; 8.5mm High Performance Wire; w/ Straight Bendable Spark Plug Boot	10116
1969-1968	8 Cyl. 6.5L; 8.5mm High Performance Wire; w/ Straight Non-Bendable Spark Plug Boot	10006
1969-1968	8 Cyl. 6.5L; 8.5mm High Performance Wire; Equipped with Ceramic Spark Plug Boots	10114
1969-1968	8 Cyl. 6.5L; 8.5mm High Performance Wire; w/ Straight Bendable Spark Plug Boot	10116
1968	8 Cyl. 5.4L; 8.5mm High Performance Wire; Equipped with Ceramic Spark Plug Boots; Routed Under Exhaust Manifold	10080
1968	8 Cyl. 5.4L; 8.5mm High Performance Wire; Routed Under Exhaust Manifold	10005
K1500		
1999-1996	8 Cyl. 5.0L; 8.5mm High Performance Wire	10021
1999-1996	8 Cyl. 5.7L; 8.5mm High Performance Wire; Equipped with Ceramic Spark Plug Boots	10072
1999-1996	8 Cyl. 5.7L; 8.5mm High Performance Wire	10021
1999-1996	8 Cyl. 5.0L; 8.5mm High Performance Wire; Equipped with Ceramic Spark Plug Boots	10072
1998-1996	6 Cyl. 4.3L; 8.5mm High Performance Wire; Equipped with Ceramic Spark Plug Boots	10078
1998-1996	6 Cyl. 4.3L; 8.5mm High Performance Wire	10077
1995-1988	8 Cyl. 5.7L; 8.5mm High Performance Wire	10018
1995-1988	8 Cyl. 5.0L; 8.5mm High Performance Wire	10018
1995-1988	8 Cyl. 5.7L; 8.5mm High Performance Wire; Equipped with Ceramic Spark Plug Boots	10046
1995-1988	6 Cyl. 4.3L; 8.5mm High Performance Wire; Equipped with Ceramic Spark Plug Boots	10076
1995-1988	8 Cyl. 5.0L; 8.5mm High Performance Wire; Equipped with Ceramic Spark Plug Boots	10046

Year	Model/Engine	Part No.
Spark Plug Wire Set		
K1500		
1995-1988	6 Cyl. 4.3L; 8.5mm High Performance Wire	10014
1995-1988	8 Cyl. 5.7L; 9.0mm High Performance Wire	10038
1995-1988	8 Cyl. 5.0L; 9.0mm High Performance Wire	10038
K1500 Suburban		
1999-1996	8 Cyl. 5.7L; 8.5mm High Performance Wire; Equipped with Ceramic Spark Plug Boots	10072
1999-1996	8 Cyl. 5.7L; 8.5mm High Performance Wire	10021
1995-1992	8 Cyl. 5.7L; 9.0mm High Performance Wire	10038
1995-1992	8 Cyl. 5.7L; 8.5mm High Performance Wire	10018
1995-1992	8 Cyl. 5.7L; 8.5mm High Performance Wire; Equipped with Ceramic Spark Plug Boots	10046
K2500		
2000-1996	8 Cyl. 5.7L; 8.5mm High Performance Wire; Equipped with Ceramic Spark Plug Boots	10072
2000-1996	8 Cyl. 7.4L; 8.5mm High Performance Wire; Equipped with Ceramic Spark Plug Boots	10071
2000-1996	8 Cyl. 7.4L; 8.5mm High Performance Wire	10070
2000-1996	8 Cyl. 5.7L; 8.5mm High Performance Wire	10021
1998-1997	8 Cyl. 5.0L; 8.5mm High Performance Wire	10021
1998-1997	8 Cyl. 5.0L; 8.5mm High Performance Wire; Equipped with Ceramic Spark Plug Boots	10072
1995-1991	8 Cyl. 7.4L; 8.5mm High Performance Wire; Equipped with Ceramic Spark Plug Boots	10051
1995-1991	8 Cyl. 7.4L; 8.5mm High Performance Wire	10050
1995-1988	6 Cyl. 4.3L; 8.5mm High Performance Wire; Equipped with Ceramic Spark Plug Boots	10076
1995-1988	8 Cyl. 5.7L; 8.5mm High Performance Wire	10018
1995-1988	8 Cyl. 5.0L; 9.0mm High Performance Wire	10038
1995-1988	6 Cyl. 4.3L; 8.5mm High Performance Wire	10014
1995-1988	8 Cyl. 5.0L; 8.5mm High Performance Wire	10018
1995-1988	8 Cyl. 5.7L; 9.0mm High Performance Wire	10038
1995-1988	8 Cyl. 5.7L; 8.5mm High Performance Wire; Equipped with Ceramic Spark Plug Boots	10046
1995-1988	8 Cyl. 5.0L; 8.5mm High Performance Wire; Equipped with Ceramic Spark Plug Boots	10046
K2500 Suburban		
1999-1996	8 Cyl. 5.7L; 8.5mm High Performance Wire; Equipped with Ceramic Spark Plug Boots	10072
1999-1996	8 Cyl. 7.4L; 8.5mm High Performance Wire	10070
1999-1996	8 Cyl. 5.7L; 8.5mm High Performance Wire	10021
1999-1996	8 Cyl. 7.4L; 8.5mm High Performance Wire; Equipped with Ceramic Spark Plug Boots	10071

Wire Sets

Year	Model/Engine	Part No.
Spark Plug Wire Set		
K2500 Suburban		
1995-1992	8 Cyl. 7.4L; 8.5mm High Performance Wire; Equipped with Ceramic Spark Plug Boots	10051
1995-1992	8 Cyl. 7.4L; 8.5mm High Performance Wire	10050
1995-1992	8 Cyl. 5.7L; 8.5mm High Performance Wire; Equipped with Ceramic Spark Plug Boots	10046
1995-1992	8 Cyl. 5.7L; 8.5mm High Performance Wire	10018
1995-1992	8 Cyl. 5.7L; 9.0mm High Performance Wire	10038
K3500		
2000-1996	8 Cyl. 5.7L; 8.5mm High Performance Wire	10021
2000-1996	8 Cyl. 7.4L; 8.5mm High Performance Wire	10070
2000-1996	8 Cyl. 5.7L; 8.5mm High Performance Wire; Equipped with Ceramic Spark Plug Boots	10072
2000-1996	8 Cyl. 7.4L; 8.5mm High Performance Wire; Equipped with Ceramic Spark Plug Boots	10071
1995-1991	8 Cyl. 7.4L; 8.5mm High Performance Wire	10050
1995-1991	8 Cyl. 7.4L; 8.5mm High Performance Wire; Equipped with Ceramic Spark Plug Boots	10051
1995-1988	8 Cyl. 5.7L; 8.5mm High Performance Wire; Equipped with Ceramic Spark Plug Boots	10046
1995-1988	8 Cyl. 5.7L; 8.5mm High Performance Wire	10018
1995-1988	8 Cyl. 5.7L; 9.0mm High Performance Wire	10038
1990	8 Cyl. 7.4L; 8.5mm High Performance Wire; Equipped with Ceramic Spark Plug Boots	10049
1990	8 Cyl. 7.4L; 8.5mm High Performance Wire	10048
1989-1988	8 Cyl. 7.4L; 8.5mm High Performance Wire	10050
1989-1988	8 Cyl. 7.4L; 8.5mm High Performance Wire; Equipped with Ceramic Spark Plug Boots	10051
Kingswood		
1972	8 Cyl. 7.4L; 8.5mm High Performance Wire; Equipped with Ceramic Spark Plug Boots	10114
1972	8 Cyl. 7.4L; 8.5mm High Performance Wire; w/ Straight Non-Bendable Spark Plug Boot	10006
1972	8 Cyl. 7.4L; 8.5mm High Performance Wire; w/ Straight Bendable Spark Plug Boot	10116
1972-1970	8 Cyl. 6.6L; 402; 8.5mm High Performance Wire; Equipped with Ceramic Spark Plug Boots	10114
1972-1970	8 Cyl. 6.6L; 402; 8.5mm High Performance Wire; w/ Straight Non-Bendable Spark Plug Boot	10006
1972-1970	8 Cyl. 6.6L; 402; 8.5mm High Performance Wire; w/ Straight Bendable Spark Plug Boot	10116
1972-1969	8 Cyl. 5.7L; 8.5mm High Performance Wire; Routed Over Valve Cover	10007
1972-1969	8 Cyl. 5.7L; 8.5mm High Performance Wire; Equipped with Ceramic Spark Plug Boots; Routed Over Valve Cover	10079

Year	Model/Engine	Part No.
Spark Plug Wire Set		
Kingswood		
1970	8 Cyl. 7.4L; 8.5mm High Performance Wire; Equipped with Ceramic Spark Plug Boots	10114
1970	8 Cyl. 7.4L; 8.5mm High Performance Wire; w/ Straight Non-Bendable Spark Plug Boot	10006
1970	8 Cyl. 7.4L; 8.5mm High Performance Wire; w/ Straight Bendable Spark Plug Boot	10116
Laguna		
1976	8 Cyl. 5.0L; 9.0mm High Performance Wire	10034
1976	8 Cyl. 5.0L; 8.5mm High Performance Wire; Equipped with Ceramic Spark Plug Boots	10053
1976	8 Cyl. 5.0L; 8.5mm High Performance Wire	10002
1976-1975	8 Cyl. 6.6L; 8.5mm High Performance Wire	10002
1976-1975	8 Cyl. 5.7L; 9.0mm High Performance Wire	10034
1976-1975	8 Cyl. 6.6L; 9.0mm High Performance Wire	10034
1976-1975	8 Cyl. 5.7L; 8.5mm High Performance Wire	10002
1976-1975	8 Cyl. 6.6L; 8.5mm High Performance Wire; Equipped with Ceramic Spark Plug Boots	10053
1976-1975	8 Cyl. 5.7L; 8.5mm High Performance Wire; Equipped with Ceramic Spark Plug Boots	10053
1975	8 Cyl. 7.4L; 8.5mm High Performance Wire; Equipped with Ceramic Spark Plug Boots	10069
1975	8 Cyl. 7.4L; 8.5mm High Performance Wire	10001
1974	8 Cyl. 6.6L; 400; 8.5mm High Performance Wire; Exc. High Energy Ignition; Routed Over Valve Cover	10007
1974	8 Cyl. 6.6L; 9.0mm High Performance Wire; w/ High Energy Ignition	10034
1974	8 Cyl. 5.7L; 8.5mm High Performance Wire; Exc. High Energy Ignition; Routed Over Valve Cover	10007
1974	8 Cyl. 5.7L; 8.5mm High Performance Wire; Equipped with Ceramic Spark Plug Boots; High Energy Ignition	10053
1974	8 Cyl. 6.6L; 400; 8.5mm High Performance Wire; Equipped with Ceramic Spark Plug Boots; Exc. High Energy Ignition; Routed Over Valve Cover	10079
1974	8 Cyl. 6.6L; 8.5mm High Performance Wire; w/ High Energy Ignition	10002
1974	8 Cyl. 6.6L; 8.5mm High Performance Wire; Equipped with Ceramic Spark Plug Boots; High Energy Ignition	10053
1974	8 Cyl. 7.4L; 8.5mm High Performance Wire; Equipped with Ceramic Spark Plug Boots; Exc. High Energy Ignition	10114
1974	8 Cyl. 5.7L; 8.5mm High Performance Wire; w/ High Energy Ignition	10002
1974	8 Cyl. 5.7L; 9.0mm High Performance Wire; w/ High Energy Ignition	10034
1974	8 Cyl. 7.4L; 8.5mm High Performance Wire; w/ High Energy Ignition	10001
1974	8 Cyl. 7.4L; 8.5mm High Performance Wire; Equipped with Ceramic Spark Plug Boots; w/ High Energy Ignition	10069

Chevrolet

Wire Sets

Year	Model/Engine	Part No.
Spark Plug Wire Set		
Laguna		
1974	8 Cyl. 7.4L; 8.5mm High Performance Wire; Exc. High Energy Ignition; w/ Straight Non-Bendable Spark Plug Boot	10006
1974	8 Cyl. 5.7L; 8.5mm High Performance Wire; Equipped with Ceramic Spark Plug Boots; Exc. High Energy Ignition; Routed Over Valve Cover	10079
1974	8 Cyl. 7.4L; 8.5mm High Performance Wire; Exc. High Energy Ignition; w/ Straight Bendable Spark Plug Boot	10116
1973	8 Cyl. 7.4L; 8.5mm High Performance Wire; w/ Straight Non-Bendable Spark Plug Boot	10006
1973	8 Cyl. 5.7L; 8.5mm High Performance Wire; Routed Over Valve Cover	10007
1973	8 Cyl. 5.7L; 8.5mm High Performance Wire; Equipped with Ceramic Spark Plug Boots; Routed Over Valve Cover	10079
1973	8 Cyl. 7.4L; 8.5mm High Performance Wire; Equipped with Ceramic Spark Plug Boots	10114
1973	8 Cyl. 7.4L; 8.5mm High Performance Wire; w/ Straight Bendable Spark Plug Boot	10116
Malibu		
1983-1978	8 Cyl. 5.0L; 9.0mm High Performance Wire	10037
1983-1978	8 Cyl. 5.0L; 8.5mm High Performance Wire; Equipped with Ceramic Spark Plug Boots	10056
1983-1978	8 Cyl. 5.0L; 8.5mm High Performance Wire	10010
1982-1979	8 Cyl. 4.4L; 8.5mm High Performance Wire	10010
1982-1979	8 Cyl. 4.4L; 8.5mm High Performance Wire; Equipped with Ceramic Spark Plug Boots	10056
1982-1979	8 Cyl. 4.4L; 9.0mm High Performance Wire	10037
1981-1978	8 Cyl. 5.7L; 8.5mm High Performance Wire; Equipped with Ceramic Spark Plug Boots	10056
1981-1978	8 Cyl. 5.7L; 9.0mm High Performance Wire	10037
1981-1978	8 Cyl. 5.7L; 8.5mm High Performance Wire	10010
1977-1976	8 Cyl. 5.0L; 8.5mm High Performance Wire	10002
1977-1976	8 Cyl. 5.0L; 8.5mm High Performance Wire; Equipped with Ceramic Spark Plug Boots	10053
1977-1976	8 Cyl. 5.0L; 9.0mm High Performance Wire	10034
1977-1975	8 Cyl. 5.7L; 8.5mm High Performance Wire; Equipped with Ceramic Spark Plug Boots	10053
1977-1975	8 Cyl. 5.7L; 9.0mm High Performance Wire	10034
1977-1975	8 Cyl. 5.7L; 8.5mm High Performance Wire	10002
1976-1975	8 Cyl. 6.6L; 8.5mm High Performance Wire	10002
1976-1975	8 Cyl. 6.6L; 9.0mm High Performance Wire	10034
1976-1975	8 Cyl. 6.6L; 8.5mm High Performance Wire; Equipped with Ceramic Spark Plug Boots	10053
1975	8 Cyl. 7.4L; 8.5mm High Performance Wire	10001

Year	Model/Engine	Part No.
Spark Plug Wire Set		
Malibu		
1975	8 Cyl. 7.4L; 8.5mm High Performance Wire; Equipped with Ceramic Spark Plug Boots	10069
1974	8 Cyl. 6.6L; 9.0mm High Performance Wire; w/ High Energy Ignition	10034
1974	8 Cyl. 7.4L; 8.5mm High Performance Wire; Exc. High Energy Ignition; w/ Straight Non-Bendable Spark Plug Boot	10006
1974	8 Cyl. 6.6L; 8.5mm High Performance Wire; w/ High Energy Ignition	10002
1974	8 Cyl. 6.6L; 400; 8.5mm High Performance Wire; Equipped with Ceramic Spark Plug Boots; Exc. High Energy Ignition; Routed Over Valve Cover	10079
1974	8 Cyl. 5.7L; 8.5mm High Performance Wire; Equipped with Ceramic Spark Plug Boots; Exc. High Energy Ignition; Routed Over Valve Cover	10079
1974	8 Cyl. 7.4L; 8.5mm High Performance Wire; Equipped with Ceramic Spark Plug Boots; Exc. High Energy Ignition	10114
1974	8 Cyl. 6.6L; 400; 8.5mm High Performance Wire; Exc. High Energy Ignition; Routed Over Valve Cover	10007
1974	8 Cyl. 7.4L; 8.5mm High Performance Wire; Equipped with Ceramic Spark Plug Boots; w/ High Energy Ignition	10069
1974	8 Cyl. 5.7L; 8.5mm High Performance Wire; Equipped with Ceramic Spark Plug Boots; High Energy Ignition	10053
1974	8 Cyl. 6.6L; 8.5mm High Performance Wire; Equipped with Ceramic Spark Plug Boots; High Energy Ignition	10053
1974	8 Cyl. 7.4L; 8.5mm High Performance Wire; w/ High Energy Ignition	10001
1974	8 Cyl. 5.7L; 8.5mm High Performance Wire; w/ High Energy Ignition	10002
1974	8 Cyl. 5.7L; 8.5mm High Performance Wire; Exc. High Energy Ignition; Routed Over Valve Cover	10007
1974	8 Cyl. 5.7L; 9.0mm High Performance Wire; w/ High Energy Ignition	10034
1974	8 Cyl. 7.4L; 8.5mm High Performance Wire; Exc. High Energy Ignition; w/ Straight Bendable Spark Plug Boot	10116
1973	8 Cyl. 7.4L; 8.5mm High Performance Wire; w/ Straight Non-Bendable Spark Plug Boot	10006
1973	8 Cyl. 5.7L; 8.5mm High Performance Wire; Routed Over Valve Cover	10007
1973	8 Cyl. 5.7L; 8.5mm High Performance Wire; Equipped with Ceramic Spark Plug Boots; Routed Over Valve Cover	10079
1973	8 Cyl. 5.0L; 8.5mm High Performance Wire; Equipped with Ceramic Spark Plug Boots; Routed Over Valve Cover	10079
1973	8 Cyl. 7.4L; 8.5mm High Performance Wire; Equipped with Ceramic Spark Plug Boots	10114
1973	8 Cyl. 5.0L; 8.5mm High Performance Wire; Routed Over Valve Cover	10007
1973	8 Cyl. 7.4L; 8.5mm High Performance Wire; w/ Straight Bendable Spark Plug Boot	10116
1967-1966	8 Cyl. 6.5L; 8.5mm High Performance Wire; Equipped with Ceramic Spark Plug Boots	10114
1967-1966	8 Cyl. 6.5L; 8.5mm High Performance Wire; w/ Straight Non-Bendable Spark Plug Boot	10006

Wire Sets

Year	Model/Engine	Part No.
Spark Plug Wire Set		
Malibu		
1967-1964	8 Cyl. 4.6L; 8.5mm High Performance Wire; Routed Over Valve Cover	10007
1967-1964	8 Cyl. 4.6L; 8.5mm High Performance Wire; Equipped with Ceramic Spark Plug Boots; Routed Over Valve Cover	10079
1967-1964	8 Cyl. 5.3L; 8.5mm High Performance Wire; Equipped with Ceramic Spark Plug Boots; Routed Under Exhaust Manifold	10080
1967-1964	8 Cyl. 5.3L; 8.5mm High Performance Wire; Routed Under Exhaust Manifold	10005
1966-1965	8 Cyl. 6.5L; 8.5mm High Performance Wire; w/ Straight Bendable Spark Plug Boot	10116
Monte Carlo		
2007-2006	8 Cyl. 5.3L; 9.0mm High Performance Wire	10042
2007-2006	8 Cyl. 5.3L; 8.5mm High Performance Wire	10041
1986-1984	8 Cyl. 5.0L; 9.0mm High Performance Wire	10037
1986-1984	8 Cyl. 5.0L; 8.5mm High Performance Wire; Equipped with Ceramic Spark Plug Boots	10056
1986-1984	8 Cyl. 5.0L; 8.5mm High Performance Wire	10010
1983	8 Cyl. 5.0L; 8.5mm High Performance Wire	10010
1983	8 Cyl. 5.0L; 8.5mm High Performance Wire; Equipped with Ceramic Spark Plug Boots	10056
1983	8 Cyl. 5.0L; 9.0mm High Performance Wire	10037
1982	8 Cyl. 5.0L; 9.0mm High Performance Wire	10037
1982	8 Cyl. 5.0L; 8.5mm High Performance Wire; Equipped with Ceramic Spark Plug Boots	10056
1982	8 Cyl. 5.0L; 8.5mm High Performance Wire	10010
1982-1979	8 Cyl. 4.4L; 8.5mm High Performance Wire	10010
1982-1979	8 Cyl. 4.4L; 9.0mm High Performance Wire	10037
1982-1979	8 Cyl. 4.4L; 8.5mm High Performance Wire; Equipped with Ceramic Spark Plug Boots	10056
1981-1978	8 Cyl. 5.0L; 8.5mm High Performance Wire	10010
1981-1978	8 Cyl. 5.0L; 8.5mm High Performance Wire; Equipped with Ceramic Spark Plug Boots	10056
1981-1978	8 Cyl. 5.0L; 9.0mm High Performance Wire	10037
1977-1976	8 Cyl. 5.0L; 8.5mm High Performance Wire	10002
1977-1976	8 Cyl. 5.0L; 8.5mm High Performance Wire; Equipped with Ceramic Spark Plug Boots	10053
1977-1976	8 Cyl. 5.0L; 9.0mm High Performance Wire	10034
1977-1975	8 Cyl. 5.7L; 8.5mm High Performance Wire; Equipped with Ceramic Spark Plug Boots	10053
1977-1975	8 Cyl. 5.7L; 8.5mm High Performance Wire	10002
1977-1975	8 Cyl. 5.7L; 9.0mm High Performance Wire	10034
1976-1975	8 Cyl. 6.6L; 8.5mm High Performance Wire	10002

Year	Model/Engine	Part No.
Spark Plug Wire Set		
Monte Carlo		
1976-1975	8 Cyl. 6.6L; 9.0mm High Performance Wire	10034
1976-1974	8 Cyl. 6.6L; 8.5mm High Performance Wire; Equipped with Ceramic Spark Plug Boots	10053
1975	8 Cyl. 7.4L; 8.5mm High Performance Wire	10001
1975	8 Cyl. 7.4L; 8.5mm High Performance Wire; Equipped with Ceramic Spark Plug Boots	10069
1974	8 Cyl. 6.6L; 9.0mm High Performance Wire; w/ High Energy Ignition	10034
1974	8 Cyl. 7.4L; 8.5mm High Performance Wire; Equipped with Ceramic Spark Plug Boots; Exc. High Energy Ignition	10114
1974	8 Cyl. 5.7L; 8.5mm High Performance Wire; w/ High Energy Ignition	10002
1974	8 Cyl. 6.6L; 400; 8.5mm High Performance Wire; Exc. High Energy Ignition; Routed Over Valve Cover	10007
1974	8 Cyl. 7.4L; 8.5mm High Performance Wire; w/ High Energy Ignition	10001
1974	8 Cyl. 7.4L; 8.5mm High Performance Wire; Equipped with Ceramic Spark Plug Boots; w/ High Energy Ignition	10069
1974	8 Cyl. 7.4L; 8.5mm High Performance Wire; Exc. High Energy Ignition; w/ Straight Non-Bendable Spark Plug Boot	10006
1974	8 Cyl. 5.7L; 9.0mm High Performance Wire; w/ High Energy Ignition	10034
1974	8 Cyl. 5.7L; 8.5mm High Performance Wire; Equipped with Ceramic Spark Plug Boots; Exc. High Energy Ignition; Routed Over Valve Cover	10079
1974	8 Cyl. 5.7L; 8.5mm High Performance Wire; Equipped with Ceramic Spark Plug Boots; High Energy Ignition	10053
1974	8 Cyl. 5.7L; 8.5mm High Performance Wire; Exc. High Energy Ignition; Routed Over Valve Cover	10007
1974	8 Cyl. 6.6L; 8.5mm High Performance Wire; w/ High Energy Ignition	10002
1974	8 Cyl. 6.6L; 400; 8.5mm High Performance Wire; Equipped with Ceramic Spark Plug Boots; Exc. High Energy Ignition; Routed Over Valve Cover	10079
1974	8 Cyl. 7.4L; 8.5mm High Performance Wire; Exc. High Energy Ignition; w/ Straight Bendable Spark Plug Boot	10116
1973-1971	8 Cyl. 5.7L; 8.5mm High Performance Wire; Equipped with Ceramic Spark Plug Boots; Routed Over Valve Cover	10079
1973-1970	8 Cyl. 5.7L; 8.5mm High Performance Wire; Routed Over Valve Cover	10007
1973-1970	8 Cyl. 6.6L; 400; 8.5mm High Performance Wire; Routed Over Valve Cover	10007
1973-1970	8 Cyl. 6.6L; 400; 8.5mm High Performance Wire; Equipped with Ceramic Spark Plug Boots; Routed Over Valve Cover	10079
1973-1970	8 Cyl. 7.4L; 8.5mm High Performance Wire; w/ Straight Non-Bendable Spark Plug Boot	10006
1973-1970	8 Cyl. 7.4L; 8.5mm High Performance Wire; Equipped with Ceramic Spark Plug Boots	10114
1973-1970	8 Cyl. 7.4L; 8.5mm High Performance Wire; w/ Straight Bendable Spark Plug Boot	10116

Wire Sets

Year	Model/Engine	Part No.
Spark Plug Wire Set		
Monte Carlo		
1972-1970	8 Cyl. 6.6L; 402; 8.5mm High Performance Wire; Equipped with Ceramic Spark Plug Boots	10114
1972-1970	8 Cyl. 6.6L; 402; 8.5mm High Performance Wire; w/ Straight Non-Bendable Spark Plug Boot	10006
1972-1970	8 Cyl. 6.6L; 402; 8.5mm High Performance Wire; w/ Straight Bendable Spark Plug Boot	10116
Monza		
1979-1976	8 Cyl. 5.0L; 8.5mm High Performance Wire	10002
1979-1976	8 Cyl. 5.0L; 9.0mm High Performance Wire	10034
1979-1976	8 Cyl. 5.0L; 8.5mm High Performance Wire; Equipped with Ceramic Spark Plug Boots	10053
1976-1975	8 Cyl. 4.3L; 8.5mm High Performance Wire	10002
1976-1975	8 Cyl. 4.3L; 9.0mm High Performance Wire	10034
1976-1975	8 Cyl. 4.3L; 8.5mm High Performance Wire; Equipped with Ceramic Spark Plug Boots	10053
1975	8 Cyl. 5.7L; 8.5mm High Performance Wire	10002
1975	8 Cyl. 5.7L; 8.5mm High Performance Wire; Equipped with Ceramic Spark Plug Boots	10053
1975	8 Cyl. 5.7L; 9.0mm High Performance Wire	10034
Nova		
1979-1976	8 Cyl. 5.0L; 8.5mm High Performance Wire; Equipped with Ceramic Spark Plug Boots	10053
1979-1976	8 Cyl. 5.0L; 8.5mm High Performance Wire	10002
1979-1976	8 Cyl. 5.0L; 9.0mm High Performance Wire	10034
1979-1975	8 Cyl. 5.7L; 9.0mm High Performance Wire	10034
1979-1975	8 Cyl. 5.7L; 8.5mm High Performance Wire	10002
1979-1975	8 Cyl. 5.7L; 8.5mm High Performance Wire; Equipped with Ceramic Spark Plug Boots	10053
1975	8 Cyl. 4.3L; 9.0mm High Performance Wire	10034
1975	8 Cyl. 4.3L; 8.5mm High Performance Wire; Equipped with Ceramic Spark Plug Boots	10053
1975	8 Cyl. 4.3L; 8.5mm High Performance Wire	10002
1974	8 Cyl. 5.7L; 8.5mm High Performance Wire; Equipped with Ceramic Spark Plug Boots; High Energy Ignition	10053
1974	8 Cyl. 5.7L; 8.5mm High Performance Wire; w/ High Energy Ignition	10002
1974	8 Cyl. 5.7L; 8.5mm High Performance Wire; Equipped with Ceramic Spark Plug Boots; Exc. High Energy Ignition; Routed Over Valve Cover	10079
1974	8 Cyl. 5.7L; 9.0mm High Performance Wire; w/ High Energy Ignition	10034
1974	8 Cyl. 5.7L; 8.5mm High Performance Wire; Exc. High Energy Ignition; Routed Over Valve Cover	10007
1973-1969	8 Cyl. 5.7L; 8.5mm High Performance Wire; Equipped with Ceramic Spark Plug Boots; Routed Over Valve Cover	10079

Year	Model/Engine	Part No.
Spark Plug Wire Set		
Nova		
1973-1969	8 Cyl. 5.7L; 8.5mm High Performance Wire; Routed Over Valve Cover	10007
1973-1969	8 Cyl. 5.0L; 8.5mm High Performance Wire; Equipped with Ceramic Spark Plug Boots; Routed Over Valve Cover	10079
1973-1969	8 Cyl. 5.0L; 8.5mm High Performance Wire; Routed Over Valve Cover	10007
1970	8 Cyl. 6.6L; 8.5mm High Performance Wire; Equipped with Ceramic Spark Plug Boots	10114
1970	8 Cyl. 6.6L; 8.5mm High Performance Wire; w/ Straight Non-Bendable Spark Plug Boot	10006
1970	8 Cyl. 6.6L; 8.5mm High Performance Wire; w/ Straight Bendable Spark Plug Boot	10116
1970-1969	8 Cyl. 6.5L; 8.5mm High Performance Wire; Equipped with Ceramic Spark Plug Boots	10114
1970-1969	8 Cyl. 6.5L; 8.5mm High Performance Wire; w/ Straight Non-Bendable Spark Plug Boot	10006
1970-1969	8 Cyl. 6.5L; 8.5mm High Performance Wire; w/ Straight Bendable Spark Plug Boot	10116
One-Fifty Series		
1957	8 Cyl. 4.6L; 8.5mm High Performance Wire; Routed Under Exhaust Manifold	10005
1957	8 Cyl. 4.6L; 8.5mm High Performance Wire; Equipped with Ceramic Spark Plug Boots; Routed Under Exhaust Manifold	10080
1957-1955	8 Cyl. 4.3L; 8.5mm High Performance Wire; Equipped with Ceramic Spark Plug Boots; Routed Under Exhaust Manifold	10080
1957-1955	8 Cyl. 4.3L; 8.5mm High Performance Wire; Routed Under Exhaust Manifold	10005
P20		
1989-1988	8 Cyl. 5.7L; 8.5mm High Performance Wire	10018
1989-1988	8 Cyl. 5.7L; 8.5mm High Performance Wire; Equipped with Ceramic Spark Plug Boots	10046
1987	8 Cyl. 5.7L; 8.5mm High Performance Wire; TBI	10018
1987	8 Cyl. 5.7L; 8.5mm High Performance Wire; Equipped with Ceramic Spark Plug Boots; TBI	10046
P20 Van		
1974	8 Cyl. 5.7L; 8.5mm High Performance Wire; Equipped with Ceramic Spark Plug Boots; Routed Over Valve Cover	10079
1974	8 Cyl. 5.7L; 8.5mm High Performance Wire; Routed Over Valve Cover	10007
P30		
1999	6 Cyl. 4.3L; 8.5mm High Performance Wire	10077
1999	6 Cyl. 4.3L; 8.5mm High Performance Wire; Equipped with Ceramic Spark Plug Boots	10078
1999	8 Cyl. 7.4L; B; 8.5mm High Performance Wire; Equipped with Ceramic Spark Plug Boots	10075
1999	8 Cyl. 7.4L; B; 8.5mm High Performance Wire	10074
1999	8 Cyl. 7.4L; J; 8.5mm High Performance Wire	10070
1999	8 Cyl. 7.4L; J; 8.5mm High Performance Wire; Equipped with Ceramic Spark Plug Boots	10071

Wire Sets

Year	Model/Engine	Part No.
Spark Plug Wire Set		
P30		
1998	8 Cyl. 7.4L; B; 8.5mm High Performance Wire	10074
1998	8 Cyl. 7.4L; B; 8.5mm High Performance Wire; Equipped with Ceramic Spark Plug Boots	10075
1998	8 Cyl. 7.4L; J; 8.5mm High Performance Wire	10070
1998	8 Cyl. 7.4L; J; 8.5mm High Performance Wire; Equipped with Ceramic Spark Plug Boots	10071
1998-1996	6 Cyl. 4.3L; 8.5mm High Performance Wire	10077
1998-1996	6 Cyl. 4.3L; 8.5mm High Performance Wire; Equipped with Ceramic Spark Plug Boots	10078
1997-1996	8 Cyl. 7.4L; 8.5mm High Performance Wire; Equipped with Ceramic Spark Plug Boots; MFI	10071
1997-1996	8 Cyl. 7.4L; 8.5mm High Performance Wire; EFI; Equipped with Ceramic Spark Plug Boots	10051
1997-1996	8 Cyl. 7.4L; 8.5mm High Performance Wire; MFI	10070
1997-1996	8 Cyl. 7.4L; 8.5mm High Performance Wire; EFI	10050
1996	8 Cyl. 5.7L; 8.5mm High Performance Wire; TBI	10018
1996	8 Cyl. 5.7L; 8.5mm High Performance Wire; Equipped with Ceramic Spark Plug Boots; TBI	10046
1995	8 Cyl. 7.4L; 8.5mm High Performance Wire	10050
1995	8 Cyl. 5.7L; 8.5mm High Performance Wire; Equipped with Ceramic Spark Plug Boots	10046
1995	8 Cyl. 7.4L; 8.5mm High Performance Wire; Equipped with Ceramic Spark Plug Boots	10051
1995	8 Cyl. 5.7L; 8.5mm High Performance Wire	10018
1994-1991	8 Cyl. 7.4L; 8.5mm High Performance Wire	10050
1994-1991	8 Cyl. 7.4L; 8.5mm High Performance Wire; Equipped with Ceramic Spark Plug Boots	10051
1994-1989	8 Cyl. 5.7L; 8.5mm High Performance Wire	10018
1994-1989	8 Cyl. 5.7L; 8.5mm High Performance Wire; Equipped with Ceramic Spark Plug Boots	10046
1990	8 Cyl. 7.4L; 8.5mm High Performance Wire; Calif.	10050
1990	8 Cyl. 7.4L; 8.5mm High Performance Wire; Calif.; Equipped with Ceramic Spark Plug Boots	10051
1989-1988	8 Cyl. 7.4L; 8.5mm High Performance Wire; Equipped with Ceramic Spark Plug Boots	10065
1989-1988	8 Cyl. 7.4L; 8.5mm High Performance Wire	10064
1988-1987	8 Cyl. 5.7L; 8.5mm High Performance Wire; TBI	10018
1988-1987	8 Cyl. 5.7L; 8.5mm High Performance Wire; Equipped with Ceramic Spark Plug Boots; TBI	10046
1987-1986	8 Cyl. 7.4L; 8.5mm High Performance Wire; Equipped with Ceramic Spark Plug Boots; Fed.	10065
1987-1986	8 Cyl. 7.4L; 8.5mm High Performance Wire; Fed.	10064

Year	Model/Engine	Part No.
Spark Plug Wire Set		
P30 Van		
1974	8 Cyl. 5.7L; 8.5mm High Performance Wire; Routed Over Valve Cover	10007
1974	8 Cyl. 5.7L; 8.5mm High Performance Wire; Equipped with Ceramic Spark Plug Boots; Routed Over Valve Cover	10079
R10		
1987	8 Cyl. 5.0L; 8.5mm High Performance Wire; Equipped with Ceramic Spark Plug Boots	10046
1987	8 Cyl. 5.7L; 9.0mm High Performance Wire	10038
1987	6 Cyl. 4.3L; 8.5mm High Performance Wire; Equipped with Ceramic Spark Plug Boots	10076
1987	8 Cyl. 5.0L; 8.5mm High Performance Wire	10018
1987	6 Cyl. 4.3L; 8.5mm High Performance Wire	10014
1987	8 Cyl. 5.7L; 8.5mm High Performance Wire	10018
1987	8 Cyl. 5.7L; 8.5mm High Performance Wire; Equipped with Ceramic Spark Plug Boots	10046
1987	8 Cyl. 5.0L; 9.0mm High Performance Wire	10038
R10 Suburban		
1988-1987	8 Cyl. 5.7L; 9.0mm High Performance Wire	10038
1988-1987	8 Cyl. 5.7L; 8.5mm High Performance Wire; Equipped with Ceramic Spark Plug Boots	10046
1988-1987	8 Cyl. 5.7L; 8.5mm High Performance Wire	10018
1987	8 Cyl. 5.0L; 9.0mm High Performance Wire	10038
R20		
1988-1987	8 Cyl. 5.7L; 8.5mm High Performance Wire	10018
1988-1987	8 Cyl. 7.4L; 8.5mm High Performance Wire; Equipped with Ceramic Spark Plug Boots	10051
1988-1987	8 Cyl. 5.7L; 8.5mm High Performance Wire; Equipped with Ceramic Spark Plug Boots	10046
1988-1987	8 Cyl. 5.7L; 9.0mm High Performance Wire	10038
1988-1987	8 Cyl. 7.4L; 8.5mm High Performance Wire	10050
1987	8 Cyl. 5.0L; 8.5mm High Performance Wire; Equipped with Ceramic Spark Plug Boots	10046
1987	8 Cyl. 5.0L; 8.5mm High Performance Wire	10018
1987	6 Cyl. 4.3L; 8.5mm High Performance Wire	10014
1987	6 Cyl. 4.3L; 8.5mm High Performance Wire; Equipped with Ceramic Spark Plug Boots	10076
1987	8 Cyl. 5.0L; 9.0mm High Performance Wire	10038
R20 Suburban		
1988-1987	8 Cyl. 5.7L; 8.5mm High Performance Wire; Equipped with Ceramic Spark Plug Boots	10046
1988-1987	8 Cyl. 5.7L; 8.5mm High Performance Wire	10018
1988-1987	8 Cyl. 5.7L; 9.0mm High Performance Wire	10038

Wire Sets

Year	Model/Engine	Part No.
Spark Plug Wire Set		
R20 Suburban		
1988-1987	8 Cyl. 7.4L; 8.5mm High Performance Wire	10050
1988-1987	8 Cyl. 7.4L; 8.5mm High Performance Wire; Equipped with Ceramic Spark Plug Boots	10051
R30		
1988-1987	8 Cyl. 7.4L; 8.5mm High Performance Wire; EFI; Equipped with Ceramic Spark Plug Boots	10051
1988-1987	8 Cyl. 5.7L; 8.5mm High Performance Wire; TBI	10018
1988-1987	8 Cyl. 5.7L; 8.5mm High Performance Wire; Equipped with Ceramic Spark Plug Boots; TBI	10046
1988-1987	8 Cyl. 7.4L; 8.5mm High Performance Wire; EFI	10050
1988-1987	8 Cyl. 5.7L; 4 Bbl. Carb.; 9.0mm High Performance Wire	10034
1988-1987	8 Cyl. 7.4L; 8.5mm High Performance Wire; Carb.	10064
1988-1987	8 Cyl. 7.4L; 8.5mm High Performance Wire; Carb.; Equipped with Ceramic Spark Plug Boots	10065
1988-1987	8 Cyl. 5.7L; 4 Bbl. Carb.; 8.5mm High Performance Wire	10002
1988-1987	8 Cyl. 5.7L; 4 Bbl. Carb.; 8.5mm High Performance Wire; Equipped with Ceramic Spark Plug Boots	10053
1988-1987	8 Cyl. 5.7L; 9.0mm High Performance Wire; TBI	10038
R1500 Suburban		
1991-1989	8 Cyl. 5.7L; 8.5mm High Performance Wire	10018
1991-1989	8 Cyl. 5.7L; 9.0mm High Performance Wire	10038
1991-1989	8 Cyl. 5.7L; 8.5mm High Performance Wire; Equipped with Ceramic Spark Plug Boots	10046
R2500		
1989	8 Cyl. 7.4L; 8.5mm High Performance Wire; Equipped with Ceramic Spark Plug Boots	10051
1989	8 Cyl. 7.4L; 8.5mm High Performance Wire	10050
R2500 Suburban		
1991-1990	8 Cyl. 7.4L; 8.5mm High Performance Wire	10048
1991-1990	8 Cyl. 7.4L; 8.5mm High Performance Wire; Equipped with Ceramic Spark Plug Boots	10049
1991-1989	8 Cyl. 5.7L; 8.5mm High Performance Wire; Equipped with Ceramic Spark Plug Boots	10046
1991-1989	8 Cyl. 5.7L; 8.5mm High Performance Wire	10018
1991-1989	8 Cyl. 5.7L; 9.0mm High Performance Wire	10038
1989	8 Cyl. 7.4L; 8.5mm High Performance Wire	10050
1989	8 Cyl. 7.4L; 8.5mm High Performance Wire; Equipped with Ceramic Spark Plug Boots	10051
R3500		
1991-1990	8 Cyl. 7.4L; 8.5mm High Performance Wire; Equipped with Ceramic Spark Plug Boots	10049
1991-1990	8 Cyl. 7.4L; 8.5mm High Performance Wire	10048

Year	Model/Engine	Part No.
Spark Plug Wire Set		
R3500		
1991-1989	8 Cyl. 5.7L; 9.0mm High Performance Wire	10038
1991-1989	8 Cyl. 5.7L; 8.5mm High Performance Wire	10018
1991-1989	8 Cyl. 5.7L; 8.5mm High Performance Wire; Equipped with Ceramic Spark Plug Boots	10046
1989	8 Cyl. 7.4L; 8.5mm High Performance Wire; EFI; Equipped with Ceramic Spark Plug Boots	10051
1989	8 Cyl. 7.4L; 8.5mm High Performance Wire; EFI	10050
S10		
2004	6 Cyl. 4.3L; 8.5mm High Performance Wire	10077
2004	6 Cyl. 4.3L; 8.5mm High Performance Wire; Equipped with Ceramic Spark Plug Boots	10078
2003-1996	6 Cyl. 4.3L; 8.5mm High Performance Wire	10077
2003-1996	6 Cyl. 4.3L; 8.5mm High Performance Wire; Equipped with Ceramic Spark Plug Boots	10078
1995	6 Cyl. 4.3L; 8.5mm High Performance Wire; Vertical Towers	10014
1995	6 Cyl. 4.3L; 8.5mm High Performance Wire; Equipped with Ceramic Spark Plug Boots; Vertical Towers	10076
1994	6 Cyl.; 8.5mm High Performance Wire; Equipped with Ceramic Spark Plug Boots	10076
1994	6 Cyl.; 8.5mm High Performance Wire	10014
1993-1988	6 Cyl. 4.3L; 8.5mm High Performance Wire	10014
1993-1988	6 Cyl. 4.3L; 8.5mm High Performance Wire; Equipped with Ceramic Spark Plug Boots	10076
1993-1982	6 Cyl. 2.8L; 8.5mm High Performance Wire	10057
1993-1982	6 Cyl. 2.8L; 8.5mm High Performance Wire; Equipped with Ceramic Spark Plug Boots	10058
S10 Blazer		
1994-1988	6 Cyl. 4.3L; 8.5mm High Performance Wire	10014
1994-1988	6 Cyl. 4.3L; 8.5mm High Performance Wire; Equipped with Ceramic Spark Plug Boots	10076
1989-1983	6 Cyl. 2.8L; 8.5mm High Performance Wire; Equipped with Ceramic Spark Plug Boots	10058
1989-1983	6 Cyl. 2.8L; 8.5mm High Performance Wire	10057
Silverado 1500		
2010	8 Cyl. 6.0L; 9.0mm High Performance Wire	10039
2010	8 Cyl. 4.8L; 9.0mm High Performance Wire	10039
2010	8 Cyl. 5.3L; 8.5mm High Performance Wire	10026
2010	8 Cyl. 6.2L; 8.5mm High Performance Wire	10026
2010	8 Cyl. 4.8L; 8.5mm High Performance Wire	10026
2010	8 Cyl. 5.3L; 9.0mm High Performance Wire	10039
2010	8 Cyl. 6.2L; 9.0mm High Performance Wire	10039
2010	8 Cyl. 6.0L; 8.5mm High Performance Wire	10026

Wire Sets

Year	Model/Engine	Part No.
Spark Plug Wire Set		
Silverado 1500		
2009	8 Cyl. 5.3L; 9.0mm High Performance Wire	10039
2009	8 Cyl. 6.0L; 9.0mm High Performance Wire	10039
2009	8 Cyl. 4.8L; 9.0mm High Performance Wire	10039
2009	8 Cyl. 6.2L; 9.0mm High Performance Wire	10039
2009	8 Cyl. 6.2L; 8.5mm High Performance Wire	10026
2009	8 Cyl. 4.8L; 8.5mm High Performance Wire	10026
2009	8 Cyl. 6.0L; 8.5mm High Performance Wire	10026
2009	8 Cyl. 5.3L; 8.5mm High Performance Wire	10026
2008	8 Cyl. 5.3L; 9.0mm High Performance Wire	10042
2008	8 Cyl. 5.3L; 8.5mm High Performance Wire	10041
2007	8 Cyl. 5.3L; 9.0mm High Performance Wire; New Body Style	10042
2007	8 Cyl. 5.3L; 8.5mm High Performance Wire; Old Body Style; Round Coil	10026
2007	8 Cyl. 5.3L; 8.5mm High Performance Wire; Old Body Style; Square Coil	10074
2007	8 Cyl. 6.0L; 8.5mm High Performance Wire; Old Body Style; Square Coil	10074
2007	8 Cyl. 4.8L; 8.5mm High Performance Wire; Old Body Style; Round Coil	10026
2007	8 Cyl. 6.0L; 8.5mm High Performance Wire; Equipped with Ceramic Spark Plug Boots; Old Body Style; Square Coil	10075
2007	8 Cyl. 4.8L; 8.5mm High Performance Wire; Old Body Style; Square Coil	10074
2007	8 Cyl. 5.3L; 8.5mm High Performance Wire; Equipped with Ceramic Spark Plug Boots; Old Body Style; Square Coil	10075
2007	8 Cyl. 6.0L; 8.5mm High Performance Wire; Old Body Style; Round Coil	10026
2007	8 Cyl. 6.0L; 9.0mm High Performance Wire; Old Body Style; Round Coil	10039
2007	8 Cyl. 4.8L; 9.0mm High Performance Wire; Old Body Style; Round Coil	10039
2007	8 Cyl. 4.8L; 8.5mm High Performance Wire; Equipped with Ceramic Spark Plug Boots; Old Body Style; Square Coil	10075
2007	8 Cyl. 5.3L; 9.0mm High Performance Wire; Old Body Style; Round Coil	10039
2007	8 Cyl. 5.3L; 8.5mm High Performance Wire; New Body Style	10041
2006-2003	8 Cyl. 6.0L; 8.5mm High Performance Wire; Round Coil	10026
2006-2003	8 Cyl. 6.0L; 9.0mm High Performance Wire; Round Coil	10039
2006-2002	8 Cyl. 5.3L; 8.5mm High Performance Wire; Equipped with Ceramic Spark Plug Boots; Square Coil	10075
2006-2002	8 Cyl. 4.8L; 8.5mm High Performance Wire; Square Coil	10074
2006-2002	8 Cyl. 4.8L; 8.5mm High Performance Wire; Round Coil	10026
2006-2002	8 Cyl. 4.8L; 9.0mm High Performance Wire; Round Coil	10039
2006-2002	8 Cyl. 5.3L; 8.5mm High Performance Wire; Round Coil	10026
2006-2002	8 Cyl. 4.8L; 8.5mm High Performance Wire; Equipped with Ceramic Spark Plug Boots; Square Coil	10075

Year	Model/Engine	Part No.
Spark Plug Wire Set		
Silverado 1500		
2006-2002	8 Cyl. 6.0L; 8.5mm High Performance Wire; Equipped with Ceramic Spark Plug Boots; Square Coil	10075
2006-2002	8 Cyl. 5.3L; 8.5mm High Performance Wire; Square Coil	10074
2006-2002	8 Cyl. 6.0L; 8.5mm High Performance Wire; Square Coil	10074
2006-2002	8 Cyl. 5.3L; 9.0mm High Performance Wire; Round Coil	10039
2001-1999	8 Cyl. 4.8L; 8.5mm High Performance Wire; Square Coil	10074
2001-1999	8 Cyl. 4.8L; 9.0mm High Performance Wire; Round Coil	10039
2001-1999	8 Cyl. 5.3L; 8.5mm High Performance Wire; Square Coil	10074
2001-1999	8 Cyl. 5.3L; 8.5mm High Performance Wire; Round Coil	10026
2001-1999	8 Cyl. 5.3L; 8.5mm High Performance Wire; Equipped with Ceramic Spark Plug Boots; Square Coil	10075
2001-1999	8 Cyl. 4.8L; 8.5mm High Performance Wire; Round Coil	10026
2001-1999	8 Cyl. 4.8L; 8.5mm High Performance Wire; Equipped with Ceramic Spark Plug Boots; Square Coil	10075
2001-1999	8 Cyl. 5.3L; 9.0mm High Performance Wire; Round Coil	10039
Silverado 1500 HD		
2007	8 Cyl. 6.0L; 8.5mm High Performance Wire; Old Body Style; Round Coil	10026
2007	8 Cyl. 6.0L; 8.5mm High Performance Wire; Equipped with Ceramic Spark Plug Boots; Old Body Style; Square Coil	10075
2007	8 Cyl. 6.0L; 9.0mm High Performance Wire; Old Body Style; Round Coil	10039
2007	8 Cyl. 6.0L; 8.5mm High Performance Wire; Old Body Style; Square Coil	10074
2006-2005	8 Cyl. 6.0L; 8.5mm High Performance Wire; Round Coil	10026
2006-2005	8 Cyl. 6.0L; 9.0mm High Performance Wire; Round Coil	10039
2006-2005	8 Cyl. 6.0L; 8.5mm High Performance Wire; Equipped with Ceramic Spark Plug Boots; Square Coil	10075
2006-2005	8 Cyl. 6.0L; 8.5mm High Performance Wire; Square Coil	10074
2003-2001	8 Cyl. 6.0L; 8.5mm High Performance Wire; Round Coil	10026
2003-2001	8 Cyl. 6.0L; 9.0mm High Performance Wire; Round Coil	10039
2003-2001	8 Cyl. 6.0L; 8.5mm High Performance Wire; Equipped with Ceramic Spark Plug Boots; Square Coil	10075
2003-2001	8 Cyl. 6.0L; 8.5mm High Performance Wire; Square Coil	10074
Silverado 2500		
2009	8 Cyl. 5.3L; 9.0mm High Performance Wire	10039
2009	8 Cyl. 5.3L; 8.5mm High Performance Wire	10026
2008	8 Cyl. 5.3L; 8.5mm High Performance Wire	10041
2008	8 Cyl. 5.3L; 9.0mm High Performance Wire	10042
2007	8 Cyl. 5.3L; 9.0mm High Performance Wire; Old Body Style; Round Coil	10039
2007	8 Cyl. 5.3L; 8.5mm High Performance Wire; Old Body Style; Round Coil	10026

Wire Sets

Year	Model/Engine	Part No.
Spark Plug Wire Set		
Silverado 2500		
2007	8 Cyl. 5.3L; 8.5mm High Performance Wire; New Body Style	10041
2007	8 Cyl. 5.3L; 9.0mm High Performance Wire; New Body Style	10042
2006-2005	8 Cyl. 5.3L; 8.5mm High Performance Wire; Round Coil	10026
2006-2005	8 Cyl. 5.3L; 9.0mm High Performance Wire; Round Coil	10039
2004-2001	8 Cyl. 5.3L; 8.5mm High Performance Wire; Round Coil	10026
2004-2001	8 Cyl. 5.3L; 9.0mm High Performance Wire; Round Coil	10039
2004-2001	8 Cyl. 6.0L; 8.5mm High Performance Wire; Round Coil	10026
2004-2001	8 Cyl. 6.0L; 8.5mm High Performance Wire; Equipped with Ceramic Spark Plug Boots; Square Coil	10075
2004-2001	8 Cyl. 6.0L; 9.0mm High Performance Wire; Round Coil	10039
2004-2001	8 Cyl. 6.0L; 8.5mm High Performance Wire; Square Coil	10074
2000-1999	8 Cyl. 6.0L; 8.5mm High Performance Wire; Equipped with Ceramic Spark Plug Boots; Square Coil	10075
2000-1999	8 Cyl. 6.0L; 9.0mm High Performance Wire; Round Coil	10039
2000-1999	8 Cyl. 5.3L; 8.5mm High Performance Wire; Square Coil	10074
2000-1999	8 Cyl. 5.3L; 9.0mm High Performance Wire; Round Coil	10039
2000-1999	8 Cyl. 6.0L; 8.5mm High Performance Wire; Square Coil	10074
2000-1999	8 Cyl. 6.0L; 8.5mm High Performance Wire; Round Coil	10026
2000-1999	8 Cyl. 5.3L; 8.5mm High Performance Wire; Equipped with Ceramic Spark Plug Boots; Square Coil	10075
2000-1999	8 Cyl. 5.3L; 8.5mm High Performance Wire; Round Coil	10026
Silverado 2500 HD		
2010-2009	8 Cyl. 6.0L; 9.0mm High Performance Wire	10039
2010-2009	8 Cyl. 6.0L; 8.5mm High Performance Wire	10026
2007	8 Cyl. 6.0L; 8.5mm High Performance Wire; Old Body Style; Round Coil	10026
2007	8 Cyl. 6.0L; 9.0mm High Performance Wire; Old Body Style; Round Coil	10039
2007	8 Cyl. 6.0L; 8.5mm High Performance Wire; Old Body Style; Square Coil	10074
2007	8 Cyl. 6.0L; 8.5mm High Performance Wire; Equipped with Ceramic Spark Plug Boots; Old Body Style; Square Coil	10075
2006-2001	8 Cyl. 6.0L; 8.5mm High Performance Wire; Round Coil	10026
2006-2001	8 Cyl. 6.0L; 8.5mm High Performance Wire; Equipped with Ceramic Spark Plug Boots; Square Coil	10075
2006-2001	8 Cyl. 6.0L; 8.5mm High Performance Wire; Square Coil	10074
2006-2001	8 Cyl. 6.0L; 9.0mm High Performance Wire; Round Coil	10039
Silverado 3500		
2009	8 Cyl. 5.3L; 9.0mm High Performance Wire	10039
2009	8 Cyl. 5.3L; 8.5mm High Performance Wire	10026
2008	8 Cyl. 5.3L; 8.5mm High Performance Wire	10041

Year	Model/Engine	Part No.
Spark Plug Wire Set		
Silverado 3500		
2008	8 Cyl. 5.3L; 9.0mm High Performance Wire	10042
2007	8 Cyl. 6.0L; 8.5mm High Performance Wire; Old Body Style; Round Coil	10026
2007	8 Cyl. 6.0L; 8.5mm High Performance Wire; Old Body Style; Square Coil	10074
2007	8 Cyl. 6.0L; 8.5mm High Performance Wire; Equipped with Ceramic Spark Plug Boots; Old Body Style; Square Coil	10075
2007	8 Cyl. 6.0L; 9.0mm High Performance Wire; Old Body Style; Round Coil	10039
2006-2004	8 Cyl. 6.0L; 8.5mm High Performance Wire; Equipped with Ceramic Spark Plug Boots; Square Coil	10075
2006-2004	8 Cyl. 5.3L; 8.5mm High Performance Wire; Round Coil	10026
2006-2004	8 Cyl. 6.0L; 8.5mm High Performance Wire; Round Coil	10026
2006-2004	8 Cyl. 6.0L; 8.5mm High Performance Wire; Square Coil	10074
2006-2004	8 Cyl. 5.3L; 9.0mm High Performance Wire; Round Coil	10039
2006-2004	8 Cyl. 6.0L; 9.0mm High Performance Wire; Round Coil	10039
2003-2001	8 Cyl. 6.0L; 8.5mm High Performance Wire; Equipped with Ceramic Spark Plug Boots; Square Coil	10075
2003-2001	8 Cyl. 6.0L; 9.0mm High Performance Wire; Round Coil	10039
2003-2001	8 Cyl. 6.0L; 8.5mm High Performance Wire; Round Coil	10026
2003-2001	8 Cyl. 6.0L; 8.5mm High Performance Wire; Square Coil	10074
Silverado 3500 HD		
2010-2009	8 Cyl. 6.0L; 8.5mm High Performance Wire	10026
2010-2009	8 Cyl. 6.0L; 9.0mm High Performance Wire	10039
2007	8 Cyl. 6.0L; 8.5mm High Performance Wire; Equipped with Ceramic Spark Plug Boots; Old Body Style; Square Coil	10075
2007	8 Cyl. 6.0L; 8.5mm High Performance Wire; Old Body Style; Square Coil	10074
2007	8 Cyl. 6.0L; 9.0mm High Performance Wire; Old Body Style; Round Coil	10039
2007	8 Cyl. 6.0L; 8.5mm High Performance Wire; Old Body Style; Round Coil	10026
SSR		
2004-2003	8 Cyl. 5.3L; 9.0mm High Performance Wire	10042
2004-2003	8 Cyl. 5.3L; 8.5mm High Performance Wire	10041
Suburban		
1967-1961	8 Cyl. 4.6L; 8.5mm High Performance Wire; Equipped with Ceramic Spark Plug Boots; Routed Under Exhaust Manifold	10080
1967-1961	8 Cyl. 4.6L; 8.5mm High Performance Wire; Routed Under Exhaust Manifold	10005
1966	8 Cyl. 6.0L; 8.5mm High Performance Wire; Equipped with Ceramic Spark Plug Boots	10114
1965	8 Cyl. 6.7L; 8.5mm High Performance Wire	10008
1965	8 Cyl. 6.7L; 8.5mm High Performance Wire; Equipped with Ceramic Spark Plug Boots	10059
1965	8 Cyl. 5.7L; 8.5mm High Performance Wire; Equipped with Ceramic Spark Plug Boots	10059

Wire Sets

Year	Model/Engine	Part No.
Spark Plug Wire Set		
Suburban		
1965	8 Cyl. 5.7L; 8.5mm High Performance Wire	10008
1964	8 Cyl. 5.7L; 8.5mm High Performance Wire; Equipped with Ceramic Spark Plug Boots; Routed Under Exhaust Manifold	10080
1964	8 Cyl. 6.7L; 8.5mm High Performance Wire; Equipped with Ceramic Spark Plug Boots; Routed Under Exhaust Manifold	10080
1964	8 Cyl. 6.7L; 8.5mm High Performance Wire; Routed Under Exhaust Manifold	10005
1964	8 Cyl. 5.7L; 8.5mm High Performance Wire; Routed Under Exhaust Manifold	10005
1962	8 Cyl. 6.7L; 8.5mm High Performance Wire; Equipped with Ceramic Spark Plug Boots; Routed Under Exhaust Manifold	10080
1962	8 Cyl. 6.7L; 8.5mm High Performance Wire; Routed Under Exhaust Manifold	10005
1962-1961	8 Cyl. 5.7L; 8.5mm High Performance Wire; Equipped with Ceramic Spark Plug Boots; Routed Under Exhaust Manifold	10080
1962-1961	8 Cyl. 5.7L; 8.5mm High Performance Wire; Routed Under Exhaust Manifold	10005
Suburban 1500		
2010-2009	8 Cyl. 5.3L; 9.0mm High Performance Wire	10039
2010-2009	8 Cyl. 5.3L; 8.5mm High Performance Wire	10026
2009	8 Cyl. 6.0L; 9.0mm High Performance Wire	10039
2009	8 Cyl. 6.0L; 8.5mm High Performance Wire	10026
2008-2007	8 Cyl. 5.3L; 8.5mm High Performance Wire	10041
2008-2007	8 Cyl. 5.3L; 9.0mm High Performance Wire	10042
2006	8 Cyl. 6.0L; 8.5mm High Performance Wire; Square Coil	10074
2006	8 Cyl. 6.0L; 9.0mm High Performance Wire; Round Coil	10039
2006	8 Cyl. 6.0L; 8.5mm High Performance Wire; Round Coil	10026
2006	8 Cyl. 6.0L; 8.5mm High Performance Wire; Equipped with Ceramic Spark Plug Boots; Square Coil	10075
2006-2000	8 Cyl. 5.3L; 9.0mm High Performance Wire; Round Coil	10039
2006-2000	8 Cyl. 5.3L; 8.5mm High Performance Wire; Round Coil	10026
2006-2000	8 Cyl. 5.3L; 8.5mm High Performance Wire; Square Coil	10074
2006-2000	8 Cyl. 5.3L; 8.5mm High Performance Wire; Equipped with Ceramic Spark Plug Boots; Square Coil	10075
1999-1996	8 Cyl. 5.7L; 8.5mm High Performance Wire	10021
1999-1996	8 Cyl. 5.7L; 8.5mm High Performance Wire; Equipped with Ceramic Spark Plug Boots	10072
1995	8 Cyl. 5.7L; 8.5mm High Performance Wire; Equipped with Ceramic Spark Plug Boots	10046
1995	8 Cyl. 5.7L; 9.0mm High Performance Wire	10038
1995	8 Cyl. 5.7L; 8.5mm High Performance Wire	10018
Suburban 2500		
2010	8 Cyl. 6.0L; 9.0mm High Performance Wire	10039
2010	8 Cyl. 6.0L; 8.5mm High Performance Wire	10026

Year	Model/Engine	Part No.
Spark Plug Wire Set		
Suburban 2500		
2009	8 Cyl. 6.0L; 9.0mm High Performance Wire	10039
2009	8 Cyl. 6.0L; 8.5mm High Performance Wire	10026
2006-2000	8 Cyl. 6.0L; 8.5mm High Performance Wire; Equipped with Ceramic Spark Plug Boots; Square Coil	10075
2006-2000	8 Cyl. 6.0L; 9.0mm High Performance Wire; Round Coil	10039
2006-2000	8 Cyl. 6.0L; 8.5mm High Performance Wire; Round Coil	10026
2006-2000	8 Cyl. 6.0L; 8.5mm High Performance Wire; Square Coil	10074
Tahoe		
2010-2009	8 Cyl. 5.3L; 8.5mm High Performance Wire	10026
2010-2009	8 Cyl. 6.0L; 9.0mm High Performance Wire	10039
2010-2009	8 Cyl. 5.3L; 9.0mm High Performance Wire	10039
2010-2009	8 Cyl. 6.0L; 8.5mm High Performance Wire	10026
2009	8 Cyl. 6.2L; 8.5mm High Performance Wire	10026
2009	8 Cyl. 4.8L; 9.0mm High Performance Wire	10039
2009	8 Cyl. 4.8L; 8.5mm High Performance Wire	10026
2009	8 Cyl. 6.2L; 9.0mm High Performance Wire	10039
2008-2007	8 Cyl. 5.3L; 9.0mm High Performance Wire	10042
2008-2007	8 Cyl. 5.3L; 8.5mm High Performance Wire	10041
2006-2000	8 Cyl. 5.3L; 9.0mm High Performance Wire; Round Coil	10039
2006-2000	8 Cyl. 5.3L; 8.5mm High Performance Wire; Square Coil	10074
2006-2000	8 Cyl. 5.3L; 8.5mm High Performance Wire; Equipped with Ceramic Spark Plug Boots; Square Coil	10075
2006-2000	8 Cyl. 4.8L; 8.5mm High Performance Wire; Square Coil	10074
2006-2000	8 Cyl. 4.8L; 8.5mm High Performance Wire; Equipped with Ceramic Spark Plug Boots; Square Coil	10075
2006-2000	8 Cyl. 5.3L; 8.5mm High Performance Wire; Round Coil	10026
2006-2000	8 Cyl. 4.8L; 8.5mm High Performance Wire; Round Coil	10026
2006-2000	8 Cyl. 4.8L; 9.0mm High Performance Wire; Round Coil	10039
2000-1996	8 Cyl. 5.7L; 8.5mm High Performance Wire; Equipped with Ceramic Spark Plug Boots	10072
2000-1996	8 Cyl. 5.7L; 8.5mm High Performance Wire	10021
1995	8 Cyl. 5.7L; 9.0mm High Performance Wire	10038
1995	8 Cyl. 5.7L; 8.5mm High Performance Wire; Equipped with Ceramic Spark Plug Boots	10046
1995	8 Cyl. 5.7L; 8.5mm High Performance Wire	10018
Townsmen		
1972	8 Cyl. 7.4L; 8.5mm High Performance Wire; w/ Straight Non-Bendable Spark Plug Boot	10006

Wire Sets

Year	Model/Engine	Part No.
Spark Plug Wire Set		
Townsmen		
1972	8 Cyl. 7.4L; 8.5mm High Performance Wire; Equipped with Ceramic Spark Plug Boots	10114
1972	8 Cyl. 7.4L; 8.5mm High Performance Wire; w/ Straight Bendable Spark Plug Boot	10116
1972-1970	8 Cyl. 6.6L; 400; 8.5mm High Performance Wire; Equipped with Ceramic Spark Plug Boots; Routed Over Valve Cover	10079
1972-1970	8 Cyl. 6.6L; 400; 8.5mm High Performance Wire; Routed Over Valve Cover	10007
1972-1969	8 Cyl. 5.7L; 8.5mm High Performance Wire; Routed Over Valve Cover	10007
1972-1969	8 Cyl. 5.7L; 8.5mm High Performance Wire; Equipped with Ceramic Spark Plug Boots; Routed Over Valve Cover	10079
1970	8 Cyl. 7.4L; 8.5mm High Performance Wire; w/ Straight Non-Bendable Spark Plug Boot	10006
1970	8 Cyl. 7.4L; 8.5mm High Performance Wire; Equipped with Ceramic Spark Plug Boots	10114
1970	8 Cyl. 7.4L; 8.5mm High Performance Wire; w/ Straight Bendable Spark Plug Boot	10116
Trailblazer		
2009	8 Cyl. 6.0L; 9.0mm High Performance Wire	10039
2009	8 Cyl. 6.0L; 8.5mm High Performance Wire	10026
2008	8 Cyl. 5.3L; 9.0mm High Performance Wire	10042
2008	8 Cyl. 5.3L; 8.5mm High Performance Wire	10041
2007-2003	8 Cyl. 5.3L; 9.0mm High Performance Wire	10042
2007-2003	8 Cyl. 5.3L; 8.5mm High Performance Wire	10041
Trailblazer EXT		
2006-2003	8 Cyl. 5.3L; 9.0mm High Performance Wire	10042
2006-2003	8 Cyl. 5.3L; 8.5mm High Performance Wire	10041
Truck		
1960	8 Cyl. 4.6L; 8.5mm High Performance Wire; Routed Under Exhaust Manifold	10005
1960	8 Cyl. 5.7L; 8.5mm High Performance Wire; Routed Under Exhaust Manifold	10005
1960	8 Cyl. 4.6L; 8.5mm High Performance Wire; Equipped with Ceramic Spark Plug Boots; Routed Under Exhaust Manifold	10080
1960	8 Cyl. 5.7L; 8.5mm High Performance Wire; Equipped with Ceramic Spark Plug Boots; Routed Under Exhaust Manifold	10080
1958	8 Cyl. 5.7L; 8.5mm High Performance Wire; Routed Under Exhaust Manifold	10005
1958	8 Cyl. 5.7L; 8.5mm High Performance Wire; Equipped with Ceramic Spark Plug Boots; Routed Under Exhaust Manifold	10080
1958-1957	8 Cyl. 4.6L; 8.5mm High Performance Wire; Routed Under Exhaust Manifold	10005
1958-1957	8 Cyl. 4.6L; 8.5mm High Performance Wire; Equipped with Ceramic Spark Plug Boots; Routed Under Exhaust Manifold	10080
1958-1956	8 Cyl. 5.3L; 8.5mm High Performance Wire; Equipped with Ceramic Spark Plug Boots; Routed Under Exhaust Manifold	10080

Year	Model/Engine	Part No.
Spark Plug Wire Set		
Truck		
1958-1956	8 Cyl. 5.3L; 8.5mm High Performance Wire; Routed Under Exhaust Manifold	10005
1957-1955	8 Cyl. 4.3L; 8.5mm High Performance Wire; Equipped with Ceramic Spark Plug Boots; Routed Under Exhaust Manifold	10080
1957-1955	8 Cyl. 4.3L; 8.5mm High Performance Wire; Routed Under Exhaust Manifold	10005
Two-Ten Series		
1957	8 Cyl. 4.6L; 8.5mm High Performance Wire; Routed Under Exhaust Manifold	10005
1957	8 Cyl. 4.6L; 8.5mm High Performance Wire; Equipped with Ceramic Spark Plug Boots; Routed Under Exhaust Manifold	10080
1957-1955	8 Cyl. 4.3L; 8.5mm High Performance Wire; Routed Under Exhaust Manifold	10005
1957-1955	8 Cyl. 4.3L; 8.5mm High Performance Wire; Equipped with Ceramic Spark Plug Boots; Routed Under Exhaust Manifold	10080
V10		
1987	6 Cyl. 4.3L; 8.5mm High Performance Wire	10014
1987	8 Cyl. 5.7L; 9.0mm High Performance Wire	10038
1987	8 Cyl. 5.0L; 8.5mm High Performance Wire	10018
1987	8 Cyl. 5.0L; 8.5mm High Performance Wire; Equipped with Ceramic Spark Plug Boots	10046
1987	8 Cyl. 5.7L; 8.5mm High Performance Wire	10018
1987	8 Cyl. 5.0L; 9.0mm High Performance Wire	10038
1987	8 Cyl. 5.7L; 8.5mm High Performance Wire; Equipped with Ceramic Spark Plug Boots	10046
1987	6 Cyl. 4.3L; 8.5mm High Performance Wire; Equipped with Ceramic Spark Plug Boots	10076
V10 Suburban		
1988-1987	8 Cyl. 5.7L; 8.5mm High Performance Wire	10018
1988-1987	8 Cyl. 5.7L; 9.0mm High Performance Wire	10038
1988-1987	8 Cyl. 5.7L; 8.5mm High Performance Wire; Equipped with Ceramic Spark Plug Boots	10046
V20		
1987	8 Cyl. 5.7L; 8.5mm High Performance Wire; Equipped with Ceramic Spark Plug Boots	10046
1987	8 Cyl. 5.7L; 9.0mm High Performance Wire	10038
1987	8 Cyl. 5.7L; 8.5mm High Performance Wire	10018
V20 Suburban		
1988-1987	8 Cyl. 5.7L; 8.5mm High Performance Wire	10018
1988-1987	8 Cyl. 7.4L; 8.5mm High Performance Wire; Equipped with Ceramic Spark Plug Boots	10051
1988-1987	8 Cyl. 5.7L; 8.5mm High Performance Wire; Equipped with Ceramic Spark Plug Boots	10046
1988-1987	8 Cyl. 5.7L; 9.0mm High Performance Wire	10038
1988-1987	8 Cyl. 7.4L; 8.5mm High Performance Wire	10050

Wire Sets

Year	Model/Engine	Part No.
Spark Plug Wire Set		
V30		
1988-1987	8 Cyl. 7.4L; 8.5mm High Performance Wire; EFI; Equipped with Ceramic Spark Plug Boots	10051
1988-1987	8 Cyl. 5.7L; 8.5mm High Performance Wire; TBI	10018
1988-1987	8 Cyl. 5.7L; 8.5mm High Performance Wire; Equipped with Ceramic Spark Plug Boots; TBI	10046
1988-1987	8 Cyl. 7.4L; 8.5mm High Performance Wire; EFI	10050
1988-1987	8 Cyl. 5.7L; 4 Bbl. Carb.; 9.0mm High Performance Wire	10034
1988-1987	8 Cyl. 5.7L; 9.0mm High Performance Wire; TBI	10038
1988-1987	8 Cyl. 5.7L; 4 Bbl. Carb.; 8.5mm High Performance Wire	10002
1988-1987	8 Cyl. 7.4L; 8.5mm High Performance Wire; Carb.	10064
1988-1987	8 Cyl. 5.7L; 4 Bbl. Carb.; 8.5mm High Performance Wire; Equipped with Ceramic Spark Plug Boots	10053
1988-1987	8 Cyl. 7.4L; 8.5mm High Performance Wire; Carb.; Equipped with Ceramic Spark Plug Boots	10065
V1500 Suburban		
1991-1989	8 Cyl. 5.7L; 9.0mm High Performance Wire	10038
1991-1989	8 Cyl. 5.7L; 8.5mm High Performance Wire; Equipped with Ceramic Spark Plug Boots	10046
1991-1989	8 Cyl. 5.7L; 8.5mm High Performance Wire	10018
V2500 Suburban		
1991-1989	8 Cyl. 5.7L; 9.0mm High Performance Wire	10038
1991-1989	8 Cyl. 5.7L; 8.5mm High Performance Wire	10018
1991-1989	8 Cyl. 5.7L; 8.5mm High Performance Wire; Equipped with Ceramic Spark Plug Boots	10046
1990	8 Cyl. 7.4L; 8.5mm High Performance Wire; Equipped with Ceramic Spark Plug Boots	10049
1990	8 Cyl. 7.4L; 8.5mm High Performance Wire	10048
V3500		
1991-1990	8 Cyl. 7.4L; 8.5mm High Performance Wire; Equipped with Ceramic Spark Plug Boots	10049
1991-1990	8 Cyl. 7.4L; 8.5mm High Performance Wire	10048
1991-1989	8 Cyl. 5.7L; 9.0mm High Performance Wire	10038
1991-1989	8 Cyl. 5.7L; 8.5mm High Performance Wire	10018
1991-1989	8 Cyl. 5.7L; 8.5mm High Performance Wire; Equipped with Ceramic Spark Plug Boots	10046
1989	8 Cyl. 7.4L; 8.5mm High Performance Wire; EFI	10050
1989	8 Cyl. 7.4L; 8.5mm High Performance Wire; EFI; Equipped with Ceramic Spark Plug Boots	10051
1989	8 Cyl. 7.4L; 8.5mm High Performance Wire; Carb.; Equipped with Ceramic Spark Plug Boots	10065
1989	8 Cyl. 7.4L; 8.5mm High Performance Wire; Carb.	10064

Year	Model/Engine	Part No.
Chrysler		
Wire Sets		
Spark Plug Wire Set		
300		
1971-1970	8 Cyl. 7.2L; 8.5mm High Performance Wire	10043
1969	8 Cyl. 7.2L; 8.5mm High Performance Wire	10043
1968	8 Cyl. 7.2L; 4 Bbl. Carb.; 8.5mm High Performance Wire	10043
1967	8 Cyl. 7.2L; 8.5mm High Performance Wire; w/ High Performance Engine	10043
Cirrus		
2000	4 Cyl. 2.4L; 8.5mm High Performance Wire	10024
1997-1996	4 Cyl. 2.4L; 8.5mm High Performance Wire	10024
1995	4 Cyl. 2.4L; 8.5mm High Performance Wire	10024
Cordoba		
1983-1979	8 Cyl. 5.2L; 8.5mm High Performance Wire; w/ Straight Non-Bendable Spark Plug Boot	10009
1983-1979	8 Cyl. 5.2L; 8.5mm High Performance Wire; Equipped with Ceramic Spark Plug Boots	10052
1983-1979	8 Cyl. 5.2L; 8.5mm High Performance Wire; w/ Straight Bendable Spark Plug Boot	10117
1980-1979	8 Cyl. 5.9L; 8.5mm High Performance Wire; Equipped with Ceramic Spark Plug Boots	10052
1980-1979	8 Cyl. 5.9L; 8.5mm High Performance Wire; w/ Straight Non-Bendable Spark Plug Boot	10009
1980-1979	8 Cyl. 5.9L; 8.5mm High Performance Wire; w/ Straight Bendable Spark Plug Boot	10117
Fifth Avenue		
1989-1983	8 Cyl. 5.2L; 8.5mm High Performance Wire; w/ Straight Non-Bendable Spark Plug Boot	10009
1989-1983	8 Cyl. 5.2L; 8.5mm High Performance Wire; Equipped with Ceramic Spark Plug Boots	10052
1989-1983	8 Cyl. 5.2L; 8.5mm High Performance Wire; w/ Straight Bendable Spark Plug Boot	10117
Imperial		
1983-1981	8 Cyl. 5.2L; 8.5mm High Performance Wire; w/ Straight Non-Bendable Spark Plug Boot	10009
1983-1981	8 Cyl. 5.2L; 8.5mm High Performance Wire; Equipped with Ceramic Spark Plug Boots	10052
1983-1981	8 Cyl. 5.2L; 8.5mm High Performance Wire; w/ Straight Bendable Spark Plug Boot	10117
1972	8 Cyl. 7.2L; 8.5mm High Performance Wire; Exc. Electronic Ignition	10043
1971-1969	8 Cyl. 7.2L; 8.5mm High Performance Wire	10043
1968	8 Cyl. 7.2L; 4 Bbl. Carb.; 8.5mm High Performance Wire	10043
1967	8 Cyl. 7.2L; 8.5mm High Performance Wire; w/ High Performance Engine	10043
LeBaron		
1981-1979	8 Cyl. 5.2L; 8.5mm High Performance Wire; Equipped with Ceramic Spark Plug Boots	10052

Wire Sets

Year	Model/Engine	Part No.
Spark Plug Wire Set		
LeBaron		
1981-1979	8 Cyl. 5.2L; 8.5mm High Performance Wire; w/ Straight Non-Bendable Spark Plug Boot	10009
1981-1979	8 Cyl. 5.2L; 8.5mm High Performance Wire; w/ Straight Bendable Spark Plug Boot	10117
1979	8 Cyl. 5.9L; 8.5mm High Performance Wire; Equipped with Ceramic Spark Plug Boots	10052
1979	8 Cyl. 5.9L; 8.5mm High Performance Wire; w/ Straight Non-Bendable Spark Plug Boot	10009
1979	8 Cyl. 5.9L; 8.5mm High Performance Wire; w/ Straight Bendable Spark Plug Boot	10117
New Yorker		
1982-1979	8 Cyl. 5.2L; 8.5mm High Performance Wire; w/ Straight Non-Bendable Spark Plug Boot	10009
1982-1979	8 Cyl. 5.2L; 8.5mm High Performance Wire; Equipped with Ceramic Spark Plug Boots	10052
1982-1979	8 Cyl. 5.2L; 8.5mm High Performance Wire; w/ Straight Bendable Spark Plug Boot	10117
1980-1979	8 Cyl. 5.9L; 8.5mm High Performance Wire; w/ Straight Non-Bendable Spark Plug Boot	10009
1980-1979	8 Cyl. 5.9L; 8.5mm High Performance Wire; Equipped with Ceramic Spark Plug Boots	10052
1980-1979	8 Cyl. 5.9L; 8.5mm High Performance Wire; w/ Straight Bendable Spark Plug Boot	10117
1972	8 Cyl. 7.2L; 8.5mm High Performance Wire; Exc. Electronic Ignition	10043
1972	8 Cyl. 6.6L; 8.5mm High Performance Wire; Exc. Electronic Ignition	10043
1971-1969	8 Cyl. 7.2L; 8.5mm High Performance Wire	10043
1968	8 Cyl. 7.2L; 4 Bbl. Carb.; 8.5mm High Performance Wire	10043
1967	8 Cyl. 7.2L; 8.5mm High Performance Wire; w/ High Performance Engine	10043
Newport		
1981-1979	8 Cyl. 5.2L; 8.5mm High Performance Wire; Equipped with Ceramic Spark Plug Boots	10052
1981-1979	8 Cyl. 5.2L; 8.5mm High Performance Wire; w/ Straight Non-Bendable Spark Plug Boot	10009
1981-1979	8 Cyl. 5.2L; 8.5mm High Performance Wire; w/ Straight Bendable Spark Plug Boot	10117
1980-1979	8 Cyl. 5.9L; 8.5mm High Performance Wire; w/ Straight Non-Bendable Spark Plug Boot	10009
1980-1979	8 Cyl. 5.9L; 8.5mm High Performance Wire; Equipped with Ceramic Spark Plug Boots	10052
1980-1979	8 Cyl. 5.9L; 8.5mm High Performance Wire; w/ Straight Bendable Spark Plug Boot	10117
1972	8 Cyl. 7.2L; 8.5mm High Performance Wire; Exc. Electronic Ignition	10043
1972	8 Cyl. 6.6L; 8.5mm High Performance Wire; Exc. Electronic Ignition	10043
1971-1969	8 Cyl. 7.2L; 8.5mm High Performance Wire	10043

Year	Model/Engine	Part No.
Spark Plug Wire Set		
Newport		
1971-1969	8 Cyl. 6.3L; 8.5mm High Performance Wire	10043
1968	8 Cyl. 6.3L; 4 Bbl. Carb.; 8.5mm High Performance Wire	10043
1968	8 Cyl. 7.2L; 4 Bbl. Carb.; 8.5mm High Performance Wire	10043
1967	8 Cyl. 7.2L; 8.5mm High Performance Wire; w/ High Performance Engine	10043
1967	8 Cyl. 6.3L; 8.5mm High Performance Wire; w/ High Performance Engine	10043
Sebring		
1999-1997	4 Cyl. 2.0L; 8.5mm High Performance Wire	10024
1996	4 Cyl. 2.0L; 8.5mm High Performance Wire	10024
1996	4 Cyl. 2.4L; 8.5mm High Performance Wire	10024
1995	4 Cyl. 2.0L; 8.5mm High Performance Wire	10024
Town & Country		
1981-1979	8 Cyl. 5.2L; 8.5mm High Performance Wire; Equipped with Ceramic Spark Plug Boots	10052
1981-1979	8 Cyl. 5.2L; 8.5mm High Performance Wire; w/ Straight Non-Bendable Spark Plug Boot	10009
1981-1979	8 Cyl. 5.2L; 8.5mm High Performance Wire; w/ Straight Bendable Spark Plug Boot	10117
1979	8 Cyl. 5.9L; 8.5mm High Performance Wire; Equipped with Ceramic Spark Plug Boots	10052
1979	8 Cyl. 5.9L; 8.5mm High Performance Wire; w/ Straight Non-Bendable Spark Plug Boot	10009
1979	8 Cyl. 5.9L; 8.5mm High Performance Wire; w/ Straight Bendable Spark Plug Boot	10117
1972	8 Cyl. 7.2L; 8.5mm High Performance Wire; Exc. Electronic Ignition	10043
1972	8 Cyl. 6.6L; 8.5mm High Performance Wire; Exc. Electronic Ignition	10043
1971-1969	8 Cyl. 6.3L; 8.5mm High Performance Wire	10043
1971-1969	8 Cyl. 7.2L; 8.5mm High Performance Wire	10043
1968	8 Cyl. 6.3L; 4 Bbl. Carb.; 8.5mm High Performance Wire	10043
1968	8 Cyl. 7.2L; 4 Bbl. Carb.; 8.5mm High Performance Wire	10043
1967	8 Cyl. 6.3L; 8.5mm High Performance Wire; w/ High Performance Engine	10043
DeTomaso		
Wire Sets		
Spark Plug Wire Set		
Pantera		
1974-1971	8 Cyl. 5.8L; 8.5mm High Performance Wire	10008
1974-1971	8 Cyl. 5.8L; 8.5mm High Performance Wire; Equipped with Ceramic Spark Plug Boots	10059

Wire Sets

Year	Model/Engine	Part No.
Dodge		
Wire Sets		
Spark Plug Wire Set		
330		
1964	8 Cyl. 4.5L; 8.5mm High Performance Wire; Equipped with Ceramic Spark Plug Boots	10052
1964	8 Cyl. 4.5L; 8.5mm High Performance Wire; w/ Straight Non-Bendable Spark Plug Boot	10009
1964	8 Cyl. 4.5L; 8.5mm High Performance Wire; w/ Straight Bendable Spark Plug Boot	10117
1964-1963	8 Cyl. 5.2L; 8.5mm High Performance Wire; Equipped with Ceramic Spark Plug Boots	10052
1964-1963	8 Cyl. 5.2L; 8.5mm High Performance Wire; w/ Straight Non-Bendable Spark Plug Boot	10009
1964-1963	8 Cyl. 5.2L; 8.5mm High Performance Wire; w/ Straight Bendable Spark Plug Boot	10117
1963	8 Cyl. 6.7L; 8.5mm High Performance Wire; Equipped with Ceramic Spark Plug Boots	10052
1963	8 Cyl. 6.7L; 8.5mm High Performance Wire; w/ Straight Non-Bendable Spark Plug Boot	10009
1963	8 Cyl. 6.7L; 8.5mm High Performance Wire; w/ Straight Bendable Spark Plug Boot	10117
440		
1964	8 Cyl. 4.5L; 8.5mm High Performance Wire; w/ Straight Non-Bendable Spark Plug Boot	10009
1964	8 Cyl. 4.5L; 8.5mm High Performance Wire; Equipped with Ceramic Spark Plug Boots	10052
1964	8 Cyl. 4.5L; 8.5mm High Performance Wire; w/ Straight Bendable Spark Plug Boot	10117
1964-1963	8 Cyl. 5.2L; 8.5mm High Performance Wire; Equipped with Ceramic Spark Plug Boots	10052
1964-1963	8 Cyl. 5.2L; 8.5mm High Performance Wire; w/ Straight Non-Bendable Spark Plug Boot	10009
1964-1963	8 Cyl. 5.2L; 8.5mm High Performance Wire; w/ Straight Bendable Spark Plug Boot	10117
1963	8 Cyl. 6.7L; 8.5mm High Performance Wire; Equipped with Ceramic Spark Plug Boots	10052
1963	8 Cyl. 6.7L; 8.5mm High Performance Wire; w/ Straight Non-Bendable Spark Plug Boot	10009
1963	8 Cyl. 6.7L; 8.5mm High Performance Wire; w/ Straight Bendable Spark Plug Boot	10117
A100		
1970	8 Cyl. 5.2L; 8.5mm High Performance Wire; Equipped with Ceramic Spark Plug Boots	10052
1970	8 Cyl. 5.2L; 8.5mm High Performance Wire; w/ Straight Non-Bendable Spark Plug Boot	10009
1970	8 Cyl. 5.2L; 8.5mm High Performance Wire; w/ Straight Bendable Spark Plug Boot	10117
1966-1964	8 Cyl. 4.5L; 8.5mm High Performance Wire; Equipped with Ceramic Spark Plug Boots	10052

Year	Model/Engine	Part No.
Spark Plug Wire Set		
A100		
1966-1964	8 Cyl. 4.5L; 8.5mm High Performance Wire; w/ Straight Non-Bendable Spark Plug Boot	10009
1966-1964	8 Cyl. 4.5L; 8.5mm High Performance Wire; w/ Straight Bendable Spark Plug Boot	10117
A100 Truck		
1970-1968	8 Cyl. 5.2L; 8.5mm High Performance Wire; Equipped with Ceramic Spark Plug Boots	10052
1970-1968	8 Cyl. 5.2L; 8.5mm High Performance Wire; w/ Straight Non-Bendable Spark Plug Boot	10009
1970-1968	8 Cyl. 5.2L; 8.5mm High Performance Wire; w/ Straight Bendable Spark Plug Boot	10117
1967	8 Cyl. 5.2L; 8.5mm High Performance Wire; w/ Straight Non-Bendable Spark Plug Boot	10009
1967	8 Cyl. 5.2L; 8.5mm High Performance Wire; Equipped with Ceramic Spark Plug Boots	10052
1967	8 Cyl. 5.2L; 8.5mm High Performance Wire; w/ Straight Bendable Spark Plug Boot	10117
1967-1964	8 Cyl. 4.5L; 8.5mm High Performance Wire; Equipped with Ceramic Spark Plug Boots	10052
1967-1964	8 Cyl. 4.5L; 8.5mm High Performance Wire; w/ Straight Non-Bendable Spark Plug Boot	10009
1967-1964	8 Cyl. 4.5L; 8.5mm High Performance Wire; w/ Straight Bendable Spark Plug Boot	10117
Aspen		
1980-1979	8 Cyl. 5.9L; 8.5mm High Performance Wire; Equipped with Ceramic Spark Plug Boots	10052
1980-1979	8 Cyl. 5.2L; 8.5mm High Performance Wire; Equipped with Ceramic Spark Plug Boots	10052
1980-1979	8 Cyl. 5.2L; 8.5mm High Performance Wire; w/ Straight Non-Bendable Spark Plug Boot	10009
1980-1979	8 Cyl. 5.9L; 8.5mm High Performance Wire; w/ Straight Non-Bendable Spark Plug Boot	10009
1980-1979	8 Cyl. 5.2L; 8.5mm High Performance Wire; w/ Straight Bendable Spark Plug Boot	10117
1980-1979	8 Cyl. 5.9L; 8.5mm High Performance Wire; w/ Straight Bendable Spark Plug Boot	10117
Avenger		
1999-1995	4 Cyl. 2.0L; 8.5mm High Performance Wire	10024
B100		
1980-1975	8 Cyl. 5.2L; 8.5mm High Performance Wire; Equipped with Ceramic Spark Plug Boots	10052
1980-1975	8 Cyl. 5.2L; 8.5mm High Performance Wire; w/ Straight Non-Bendable Spark Plug Boot	10009
1980-1975	8 Cyl. 5.2L; 8.5mm High Performance Wire; w/ Straight Bendable Spark Plug Boot	10117
1978-1976	8 Cyl. 5.9L; 8.5mm High Performance Wire; Equipped with Ceramic Spark Plug Boots	10052

Wire Sets

Year	Model/Engine	Part No.
Spark Plug Wire Set		
B1500		
1998-1995	6 Cyl. 3.9L; 8.5mm High Performance Wire; Equipped with Ceramic Spark Plug Boots	10063
B2500		
1997	6 Cyl. 3.9L; 8.5mm High Performance Wire	10062
1997	6 Cyl. 3.9L; 8.5mm High Performance Wire; Equipped with Ceramic Spark Plug Boots	10063
1996	6 Cyl. 3.9L; 8.5mm High Performance Wire	10062
1996	6 Cyl. 3.9L; 8.5mm High Performance Wire; Equipped with Ceramic Spark Plug Boots	10063
1995	6 Cyl. 3.9L; 8.5mm High Performance Wire	10062
1995	6 Cyl. 3.9L; 8.5mm High Performance Wire; Equipped with Ceramic Spark Plug Boots	10063
CB300		
1980-1974	8 Cyl. 5.2L; 8.5mm High Performance Wire; Equipped with Ceramic Spark Plug Boots	10052
1980-1974	8 Cyl. 5.2L; 8.5mm High Performance Wire; w/ Straight Non-Bendable Spark Plug Boot	10009
1980-1974	8 Cyl. 5.9L; 8.5mm High Performance Wire; Equipped with Ceramic Spark Plug Boots	10052
1980-1974	8 Cyl. 5.9L; 8.5mm High Performance Wire; w/ Straight Non-Bendable Spark Plug Boot	10009
1980-1974	8 Cyl. 5.2L; 8.5mm High Performance Wire; w/ Straight Bendable Spark Plug Boot	10117
1980-1974	8 Cyl. 5.9L; 8.5mm High Performance Wire; w/ Straight Bendable Spark Plug Boot	10117
Challenger		
1974	8 Cyl. 5.9L; 8.5mm High Performance Wire; Equipped with Ceramic Spark Plug Boots	10052
1974	8 Cyl. 5.9L; 8.5mm High Performance Wire; w/ Straight Non-Bendable Spark Plug Boot	10009
1974	8 Cyl. 5.9L; 8.5mm High Performance Wire; w/ Straight Bendable Spark Plug Boot	10117
1974-1970	8 Cyl. 5.2L; 8.5mm High Performance Wire; w/ Straight Non-Bendable Spark Plug Boot	10009
1974-1970	8 Cyl. 5.2L; 8.5mm High Performance Wire; Equipped with Ceramic Spark Plug Boots	10052
1974-1970	8 Cyl. 5.2L; 8.5mm High Performance Wire; w/ Straight Bendable Spark Plug Boot	10117
1973-1970	8 Cyl. 5.6L; 8.5mm High Performance Wire; Equipped with Ceramic Spark Plug Boots	10052
1973-1970	8 Cyl. 5.6L; 8.5mm High Performance Wire; w/ Straight Non-Bendable Spark Plug Boot	10009
1973-1970	8 Cyl. 5.6L; 8.5mm High Performance Wire; w/ Straight Bendable Spark Plug Boot	10117
1971-1970	8 Cyl. 6.3L; 8.5mm High Performance Wire	10043
1971-1970	8 Cyl. 7.2L; 8.5mm High Performance Wire	10043

Year	Model/Engine	Part No.
Spark Plug Wire Set		
Charger		
1978-1974	8 Cyl. 5.9L; 8.5mm High Performance Wire; w/ Straight Non-Bendable Spark Plug Boot	10009
1978-1974	8 Cyl. 5.9L; 8.5mm High Performance Wire; Equipped with Ceramic Spark Plug Boots	10052
1978-1974	8 Cyl. 5.9L; 8.5mm High Performance Wire; w/ Straight Bendable Spark Plug Boot	10117
1978-1967	8 Cyl. 5.2L; 8.5mm High Performance Wire; w/ Straight Non-Bendable Spark Plug Boot	10009
1978-1967	8 Cyl. 5.2L; 8.5mm High Performance Wire; Equipped with Ceramic Spark Plug Boots	10052
1978-1967	8 Cyl. 5.2L; 8.5mm High Performance Wire; w/ Straight Bendable Spark Plug Boot	10117
1973-1971	8 Cyl. 5.6L; 8.5mm High Performance Wire; w/ Straight Non-Bendable Spark Plug Boot	10009
1973-1971	8 Cyl. 5.6L; 8.5mm High Performance Wire; Equipped with Ceramic Spark Plug Boots	10052
1973-1971	8 Cyl. 5.6L; 8.5mm High Performance Wire; w/ Straight Bendable Spark Plug Boot	10117
1972	8 Cyl. 6.6L; 8.5mm High Performance Wire; Exc. Electronic Ignition	10043
1972	8 Cyl. 7.2L; 8.5mm High Performance Wire; Exc. Electronic Ignition	10043
1971-1969	8 Cyl. 7.2L; 8.5mm High Performance Wire	10043
1971-1969	8 Cyl. 6.3L; 8.5mm High Performance Wire	10043
1966	8 Cyl. 4.5L; 8.5mm High Performance Wire; w/ Straight Non-Bendable Spark Plug Boot	10009
1966	8 Cyl. 5.2L; 8.5mm High Performance Wire; Equipped with Ceramic Spark Plug Boots	10052
1966	8 Cyl. 4.5L; 8.5mm High Performance Wire; Equipped with Ceramic Spark Plug Boots	10052
1966	8 Cyl. 5.2L; 8.5mm High Performance Wire; w/ Straight Non-Bendable Spark Plug Boot	10009
1966	8 Cyl. 4.5L; 8.5mm High Performance Wire; w/ Straight Bendable Spark Plug Boot	10117
1966	8 Cyl. 5.2L; 8.5mm High Performance Wire; w/ Straight Bendable Spark Plug Boot	10117
Coronet		
1976-1973	8 Cyl. 5.9L; 8.5mm High Performance Wire; Equipped with Ceramic Spark Plug Boots	10052
1976-1973	8 Cyl. 5.9L; 8.5mm High Performance Wire; w/ Straight Non-Bendable Spark Plug Boot	10009
1976-1973	8 Cyl. 5.9L; 8.5mm High Performance Wire; w/ Straight Bendable Spark Plug Boot	10117
1976-1965	8 Cyl. 5.2L; 8.5mm High Performance Wire; Equipped with Ceramic Spark Plug Boots	10052
1976-1965	8 Cyl. 5.2L; 8.5mm High Performance Wire; w/ Straight Non-Bendable Spark Plug Boot	10009

Wire Sets

Year	Model/Engine	Part No.
Spark Plug Wire Set		
Coronet		
1976-1965	8 Cyl. 5.2L; 8.5mm High Performance Wire; w/ Straight Bendable Spark Plug Boot	10117
1973-1972	8 Cyl. 5.6L; 8.5mm High Performance Wire; Equipped with Ceramic Spark Plug Boots	10052
1973-1972	8 Cyl. 5.6L; 8.5mm High Performance Wire; w/ Straight Non-Bendable Spark Plug Boot	10009
1973-1972	8 Cyl. 5.6L; 8.5mm High Performance Wire; w/ Straight Bendable Spark Plug Boot	10117
1972	8 Cyl. 7.2L; 8.5mm High Performance Wire; Exc. Electronic Ignition	10043
1972	8 Cyl. 6.6L; 8.5mm High Performance Wire; Exc. Electronic Ignition	10043
1971-1969	8 Cyl. 6.3L; 8.5mm High Performance Wire	10043
1970-1969	8 Cyl. 7.2L; 8.5mm High Performance Wire	10043
1968-1965	8 Cyl. 4.5L; 8.5mm High Performance Wire; Equipped with Ceramic Spark Plug Boots	10052
1968-1965	8 Cyl. 4.5L; 8.5mm High Performance Wire; w/ Straight Non-Bendable Spark Plug Boot	10009
1968-1965	8 Cyl. 4.5L; 8.5mm High Performance Wire; w/ Straight Bendable Spark Plug Boot	10117
1959	8 Cyl. 6.3L; 8.5mm High Performance Wire; Equipped with Ceramic Spark Plug Boots	10059
1959	8 Cyl. 6.3L; 8.5mm High Performance Wire	10008
1959-1958	8 Cyl. 5.9L; 8.5mm High Performance Wire	10008
1959-1958	8 Cyl. 5.9L; 8.5mm High Performance Wire; Equipped with Ceramic Spark Plug Boots	10059
1959-1957	8 Cyl. 5.3L; 8.5mm High Performance Wire	10008
1959-1957	8 Cyl. 5.3L; 8.5mm High Performance Wire; Equipped with Ceramic Spark Plug Boots	10059
1958	8 Cyl. 5.7L; 8.5mm High Performance Wire; Equipped with Ceramic Spark Plug Boots	10059
1958	8 Cyl. 5.7L; 8.5mm High Performance Wire	10008
1957	8 Cyl. 5.8L; 8.5mm High Performance Wire; Equipped with Ceramic Spark Plug Boots	10059
1957	8 Cyl. 5.8L; 8.5mm High Performance Wire	10008
1956	8 Cyl. 5.1L; 8.5mm High Performance Wire	10008
1956	8 Cyl. 5.1L; 8.5mm High Performance Wire; Equipped with Ceramic Spark Plug Boots	10059
1956-1955	8 Cyl. 4.4L; 8.5mm High Performance Wire; Equipped with Ceramic Spark Plug Boots	10059
1956-1955	8 Cyl. 4.4L; 8.5mm High Performance Wire	10008
1954-1953	8 Cyl. 3.9L; 8.5mm High Performance Wire	10008
1954-1953	8 Cyl. 3.9L; 8.5mm High Performance Wire; Equipped with Ceramic Spark Plug Boots	10059

Year	Model/Engine	Part No.
Spark Plug Wire Set		
Custom		
1965-1964	8 Cyl. 4.5L; 8.5mm High Performance Wire; w/ Straight Non-Bendable Spark Plug Boot	10009
1965-1964	8 Cyl. 4.5L; 8.5mm High Performance Wire; Equipped with Ceramic Spark Plug Boots	10052
1965-1964	8 Cyl. 4.5L; 8.5mm High Performance Wire; w/ Straight Bendable Spark Plug Boot	10117
1965-1962	8 Cyl. 5.2L; 8.5mm High Performance Wire; Equipped with Ceramic Spark Plug Boots	10052
1965-1962	8 Cyl. 5.2L; 8.5mm High Performance Wire; w/ Straight Non-Bendable Spark Plug Boot	10009
1965-1962	8 Cyl. 5.2L; 8.5mm High Performance Wire; w/ Straight Bendable Spark Plug Boot	10117
1963	8 Cyl.; 413; 8.5mm High Performance Wire; w/ Straight Non-Bendable Spark Plug Boot	10009
1963	8 Cyl.; 413; 8.5mm High Performance Wire; Equipped with Ceramic Spark Plug Boots	10052
1963	8 Cyl.; 413; 8.5mm High Performance Wire; w/ Straight Bendable Spark Plug Boot	10117
1961-1960	8 Cyl. 5.9L; 8.5mm High Performance Wire; Equipped with Ceramic Spark Plug Boots	10052
1961-1960	8 Cyl. 5.9L; 8.5mm High Performance Wire; w/ Straight Non-Bendable Spark Plug Boot	10009
1961-1960	8 Cyl. 5.9L; 8.5mm High Performance Wire; w/ Straight Bendable Spark Plug Boot	10117
1959	8 Cyl. 6.3L; 8.5mm High Performance Wire	10008
1959	8 Cyl. 6.3L; 8.5mm High Performance Wire; Equipped with Ceramic Spark Plug Boots	10059
1959-1958	8 Cyl. 5.9L; 8.5mm High Performance Wire; Equipped with Ceramic Spark Plug Boots	10059
1959-1958	8 Cyl. 5.9L; 8.5mm High Performance Wire	10008
1959-1957	8 Cyl. 5.3L; 8.5mm High Performance Wire	10008
1959-1957	8 Cyl. 5.3L; 8.5mm High Performance Wire; Equipped with Ceramic Spark Plug Boots	10059
1958	8 Cyl. 5.7L; 8.5mm High Performance Wire; Equipped with Ceramic Spark Plug Boots	10059
1958	8 Cyl. 5.7L; 8.5mm High Performance Wire	10008
1957	8 Cyl. 5.8L; 8.5mm High Performance Wire	10008
1957	8 Cyl. 5.8L; 8.5mm High Performance Wire; Equipped with Ceramic Spark Plug Boots	10059
1956	8 Cyl. 5.1L; 8.5mm High Performance Wire	10008
1956-1955	8 Cyl. 4.4L; 8.5mm High Performance Wire; Equipped with Ceramic Spark Plug Boots	10059
1956-1955	8 Cyl. 4.4L; 8.5mm High Performance Wire	10008

Wire Sets

Year	Model/Engine	Part No.
Spark Plug Wire Set		
Custom		
1954	8 Cyl. 4.0L; 8.5mm High Performance Wire	10008
D100		
1989-1986	8 Cyl. 5.2L; 8.5mm High Performance Wire; Equipped with Ceramic Spark Plug Boots	10052
1989-1986	8 Cyl. 5.2L; 8.5mm High Performance Wire; w/ Straight Non-Bendable Spark Plug Boot	10009
1989-1986	8 Cyl. 5.2L; 8.5mm High Performance Wire; w/ Straight Bendable Spark Plug Boot	10117
1988-1986	8 Cyl. 5.9L; 8.5mm High Performance Wire; Equipped with Ceramic Spark Plug Boots	10052
1988-1986	8 Cyl. 5.9L; 8.5mm High Performance Wire; w/ Straight Non-Bendable Spark Plug Boot	10009
1988-1986	8 Cyl. 5.9L; 8.5mm High Performance Wire; w/ Straight Bendable Spark Plug Boot	10117
1979-1975	8 Cyl. 5.2L; 8.5mm High Performance Wire; Equipped with Ceramic Spark Plug Boots	10052
1979-1975	8 Cyl. 5.9L; 8.5mm High Performance Wire; Equipped with Ceramic Spark Plug Boots	10052
1979-1975	8 Cyl. 5.9L; 8.5mm High Performance Wire; w/ Straight Non-Bendable Spark Plug Boot	10009
1979-1975	8 Cyl. 5.2L; 8.5mm High Performance Wire; w/ Straight Non-Bendable Spark Plug Boot	10009
1979-1975	8 Cyl. 5.2L; 8.5mm High Performance Wire; w/ Straight Bendable Spark Plug Boot	10117
1979-1975	8 Cyl. 5.9L; 8.5mm High Performance Wire; w/ Straight Bendable Spark Plug Boot	10117
D100 Pickup		
1974-1971	8 Cyl. 5.9L; 8.5mm High Performance Wire; Equipped with Ceramic Spark Plug Boots	10052
1974-1971	8 Cyl. 5.9L; 8.5mm High Performance Wire; w/ Straight Non-Bendable Spark Plug Boot	10009
1974-1971	8 Cyl. 5.9L; 8.5mm High Performance Wire; w/ Straight Bendable Spark Plug Boot	10117
1974-1968	8 Cyl. 5.2L; 8.5mm High Performance Wire; Equipped with Ceramic Spark Plug Boots	10052
1974-1968	8 Cyl. 5.2L; 8.5mm High Performance Wire; w/ Straight Non-Bendable Spark Plug Boot	10009
1974-1968	8 Cyl. 5.2L; 8.5mm High Performance Wire; w/ Straight Bendable Spark Plug Boot	10117
D100 Series		
1967-1960	8 Cyl. 5.2L; 8.5mm High Performance Wire; Equipped with Ceramic Spark Plug Boots	10052
1967-1960	8 Cyl. 5.2L; 8.5mm High Performance Wire; w/ Straight Non-Bendable Spark Plug Boot	10009
1967-1960	8 Cyl. 5.2L; 8.5mm High Performance Wire; w/ Straight Bendable Spark Plug Boot	10117

Year	Model/Engine	Part No.
Spark Plug Wire Set		
D150		
1993	8 Cyl. 5.9L; 8.5mm High Performance Wire; Equipped with Ceramic Spark Plug Boots	10073
1993	8 Cyl. 5.2L; 8.5mm High Performance Wire; Equipped with Ceramic Spark Plug Boots	10073
1993	8 Cyl. 5.2L; 8.5mm High Performance Wire	10016 ¹
1993	8 Cyl. 5.9L; 8.5mm High Performance Wire	10016 ¹
1993-1992	6 Cyl. 3.9L; 8.5mm High Performance Wire; Equipped with Ceramic Spark Plug Boots	10063
1993-1992	6 Cyl. 3.9L; 8.5mm High Performance Wire	10062
1992	8 Cyl. 5.2L; 8.5mm High Performance Wire; Equipped with Ceramic Spark Plug Boots; MFI	10073
1992	8 Cyl. 5.2L; 8.5mm High Performance Wire; MFI	10016 ¹
1992	8 Cyl. 5.9L; 8.5mm High Performance Wire; Equipped with Ceramic Spark Plug Boots	10052
1992	8 Cyl. 5.9L; 8.5mm High Performance Wire; w/ Straight Bendable Spark Plug Boot	10117
1992	8 Cyl. 5.9L; 8.5mm High Performance Wire; w/ Straight Non-Bendable Spark Plug Boot	10009
1992-1989	8 Cyl. 5.2L; 8.5mm High Performance Wire; Equipped with Ceramic Spark Plug Boots	10052
1992-1989	8 Cyl. 5.2L; 8.5mm High Performance Wire; w/ Straight Bendable Spark Plug Boot	10117
1992-1989	8 Cyl. 5.2L; 8.5mm High Performance Wire; w/ Straight Non-Bendable Spark Plug Boot	10009
1991-1977	8 Cyl. 5.9L; 8.5mm High Performance Wire; Equipped with Ceramic Spark Plug Boots	10052
1991-1977	8 Cyl. 5.9L; 8.5mm High Performance Wire; w/ Straight Non-Bendable Spark Plug Boot	10009
1991-1977	8 Cyl. 5.9L; 8.5mm High Performance Wire; w/ Straight Bendable Spark Plug Boot	10117
1988-1977	8 Cyl. 5.2L; 8.5mm High Performance Wire; Equipped with Ceramic Spark Plug Boots	10052
1988-1977	8 Cyl. 5.2L; 8.5mm High Performance Wire; w/ Straight Non-Bendable Spark Plug Boot	10009
1988-1977	8 Cyl. 5.2L; 8.5mm High Performance Wire; w/ Straight Bendable Spark Plug Boot	10117
D200		
1980-1975	8 Cyl. 5.9L; 8.5mm High Performance Wire; Equipped with Ceramic Spark Plug Boots	10052
1980-1975	8 Cyl. 5.2L; 8.5mm High Performance Wire; Equipped with Ceramic Spark Plug Boots	10052
1980-1975	8 Cyl. 5.9L; 8.5mm High Performance Wire; w/ Straight Non-Bendable Spark Plug Boot	10009
1980-1975	8 Cyl. 5.2L; 8.5mm High Performance Wire; w/ Straight Non-Bendable Spark Plug Boot	10009

¹ Wire Set With 2.90 Inch Spark Plug Boots

Wire Sets

Year	Model/Engine	Part No.
Spark Plug Wire Set		
D200		
1980-1975	8 Cyl. 5.2L; 8.5mm High Performance Wire; w/ Straight Bendable Spark Plug Boot	10117
1980-1975	8 Cyl. 5.9L; 8.5mm High Performance Wire; w/ Straight Bendable Spark Plug Boot	10117
D200 Pickup		
1974-1971	8 Cyl. 5.9L; 8.5mm High Performance Wire; w/ Straight Non-Bendable Spark Plug Boot	10009
1974-1971	8 Cyl. 5.9L; 8.5mm High Performance Wire; Equipped with Ceramic Spark Plug Boots	10052
1974-1971	8 Cyl. 5.9L; 8.5mm High Performance Wire; w/ Straight Bendable Spark Plug Boot	10117
1974-1970	8 Cyl. 5.2L; 8.5mm High Performance Wire; w/ Straight Non-Bendable Spark Plug Boot	10009
1974-1970	8 Cyl. 5.2L; 8.5mm High Performance Wire; w/ Straight Bendable Spark Plug Boot	10117
1974-1968	8 Cyl. 5.2L; 8.5mm High Performance Wire; Equipped with Ceramic Spark Plug Boots	10052
1968	8 Cyl. 5.2L; 8.5mm High Performance Wire; w/ Straight Non-Bendable Spark Plug Boot	10009
1968	8 Cyl. 5.2L; 8.5mm High Performance Wire; w/ Straight Bendable Spark Plug Boot	10117
D200 Series		
1967-1960	8 Cyl. 5.2L; 8.5mm High Performance Wire; w/ Straight Non-Bendable Spark Plug Boot	10009
1967-1960	8 Cyl. 5.2L; 8.5mm High Performance Wire; Equipped with Ceramic Spark Plug Boots	10052
1967-1960	8 Cyl. 5.2L; 8.5mm High Performance Wire; w/ Straight Bendable Spark Plug Boot	10117
D250		
1993	8 Cyl. 5.2L; 8.5mm High Performance Wire; Equipped with Ceramic Spark Plug Boots	10073
1993	8 Cyl. 5.2L; 8.5mm High Performance Wire	10016 ¹
1993-1992	8 Cyl. 5.9L; 8.5mm High Performance Wire; Equipped with Ceramic Spark Plug Boots	10073
1993-1992	6 Cyl. 3.9L; 8.5mm High Performance Wire	10062
1993-1992	8 Cyl. 5.9L; 8.5mm High Performance Wire	10016 ¹
1993-1992	6 Cyl. 3.9L; 8.5mm High Performance Wire; Equipped with Ceramic Spark Plug Boots	10063
1992	8 Cyl. 5.9L; 8.5mm High Performance Wire; Equipped with Ceramic Spark Plug Boots	10052
1992	8 Cyl. 5.9L; 8.5mm High Performance Wire; w/ Straight Non-Bendable Spark Plug Boot	10009
1992	8 Cyl. 5.2L; 8.5mm High Performance Wire; Equipped with Ceramic Spark Plug Boots	10052
1992	8 Cyl. 5.2L; 8.5mm High Performance Wire; w/ Straight Non-Bendable Spark Plug Boot	10009

Year	Model/Engine	Part No.
Spark Plug Wire Set		
D250		
1992	8 Cyl. 5.2L; 8.5mm High Performance Wire; MFI	10016 ¹
1992	8 Cyl. 5.2L; 8.5mm High Performance Wire; Equipped with Ceramic Spark Plug Boots; MFI	10073
1992	8 Cyl. 5.2L; 8.5mm High Performance Wire; w/ Straight Bendable Spark Plug Boot	10117
1992	8 Cyl. 5.9L; 8.5mm High Performance Wire; w/ Straight Bendable Spark Plug Boot	10117
1991	8 Cyl. 5.2L; 8.5mm High Performance Wire; Equipped with Ceramic Spark Plug Boots	10052
1991	8 Cyl. 5.2L; 8.5mm High Performance Wire; w/ Straight Bendable Spark Plug Boot	10117
1991-1989	8 Cyl. 5.9L; 8.5mm High Performance Wire; Equipped with Ceramic Spark Plug Boots	10052
1991-1989	8 Cyl. 5.9L; 8.5mm High Performance Wire; w/ Straight Non-Bendable Spark Plug Boot	10009
1990-1981	8 Cyl. 5.2L; 8.5mm High Performance Wire; Equipped with Ceramic Spark Plug Boots	10052
1990-1981	8 Cyl. 5.2L; 8.5mm High Performance Wire; w/ Straight Non-Bendable Spark Plug Boot	10009
1990-1981	8 Cyl. 5.2L; 8.5mm High Performance Wire; w/ Straight Bendable Spark Plug Boot	10117
1988-1981	8 Cyl. 5.9L; 8.5mm High Performance Wire; Equipped with Ceramic Spark Plug Boots	10052
1988-1981	8 Cyl. 5.9L; 8.5mm High Performance Wire; w/ Straight Non-Bendable Spark Plug Boot	10009
1988-1981	8 Cyl. 5.9L; 8.5mm High Performance Wire; w/ Straight Bendable Spark Plug Boot	10117
D300		
1980-1975	8 Cyl. 5.9L; 8.5mm High Performance Wire; w/ Straight Non-Bendable Spark Plug Boot	10009
1980-1975	8 Cyl. 5.9L; 8.5mm High Performance Wire; Equipped with Ceramic Spark Plug Boots	10052
1980-1975	8 Cyl. 5.2L; 8.5mm High Performance Wire; w/ Straight Non-Bendable Spark Plug Boot	10009
1980-1975	8 Cyl. 5.2L; 8.5mm High Performance Wire; Equipped with Ceramic Spark Plug Boots	10052
1980-1975	8 Cyl. 5.2L; 8.5mm High Performance Wire; w/ Straight Bendable Spark Plug Boot	10117
1980-1975	8 Cyl. 5.9L; 8.5mm High Performance Wire; w/ Straight Bendable Spark Plug Boot	10117
D300 Pickup		
1974-1971	8 Cyl. 5.9L; 8.5mm High Performance Wire; Equipped with Ceramic Spark Plug Boots	10052
1974-1971	8 Cyl. 5.9L; 8.5mm High Performance Wire; w/ Straight Non-Bendable Spark Plug Boot	10009
1974-1971	8 Cyl. 5.9L; 8.5mm High Performance Wire; w/ Straight Bendable Spark Plug Boot	10117

Wire Sets

Year	Model/Engine	Part No.
Spark Plug Wire Set		
D300 Pickup		
1974-1970	8 Cyl. 5.2L; 8.5mm High Performance Wire; Equipped with Ceramic Spark Plug Boots	10052
1974-1970	8 Cyl. 5.2L; 8.5mm High Performance Wire; w/ Straight Non-Bendable Spark Plug Boot	10009
1974-1968	8 Cyl. 5.2L; 8.5mm High Performance Wire; w/ Straight Bendable Spark Plug Boot	10117
1968	8 Cyl. 5.2L; 8.5mm High Performance Wire; Equipped with Ceramic Spark Plug Boots	10052
1968	8 Cyl. 5.2L; 8.5mm High Performance Wire; w/ Straight Non-Bendable Spark Plug Boot	10009
D300 Series		
1967-1960	8 Cyl. 5.2L; 8.5mm High Performance Wire; w/ Straight Non-Bendable Spark Plug Boot	10009
1967-1960	8 Cyl. 5.2L; 8.5mm High Performance Wire; Equipped with Ceramic Spark Plug Boots	10052
1967-1960	8 Cyl. 5.2L; 8.5mm High Performance Wire; w/ Straight Bendable Spark Plug Boot	10117
D350		
1993	8 Cyl. 5.9L; 8.5mm High Performance Wire	10016 ¹
1993	8 Cyl. 5.9L; 8.5mm High Performance Wire; Equipped with Ceramic Spark Plug Boots	10073
1992	8 Cyl. 5.9L; 8.5mm High Performance Wire; Equipped with Ceramic Spark Plug Boots	10073
1992	8 Cyl. 5.9L; 8.5mm High Performance Wire	10016 ¹
1992-1989	8 Cyl.; 8.5mm High Performance Wire; w/ Straight Non-Bendable Spark Plug Boot	10009
1992-1989	8 Cyl.; 8.5mm High Performance Wire; Equipped with Ceramic Spark Plug Boots	10052
1992-1989	8 Cyl.; 8.5mm High Performance Wire; w/ Straight Bendable Spark Plug Boot	10117
1988-1981	8 Cyl.; 8.5mm High Performance Wire; w/ Straight Non-Bendable Spark Plug Boot	10009
1988-1981	8 Cyl.; 8.5mm High Performance Wire; w/ Straight Bendable Spark Plug Boot	10117
1988-1981	8 Cyl.; 8.5mm High Performance Wire; Equipped with Ceramic Spark Plug Boots	10052
D400		
1981-1978	8 Cyl. 5.9L; 8.5mm High Performance Wire; w/ Straight Non-Bendable Spark Plug Boot	10009
1981-1978	8 Cyl. 5.9L; 8.5mm High Performance Wire; Equipped with Ceramic Spark Plug Boots	10052
1981-1978	8 Cyl. 5.9L; 8.5mm High Performance Wire; w/ Straight Bendable Spark Plug Boot	10117
D450		
1981-1978	8 Cyl. 5.9L; 8.5mm High Performance Wire; w/ Straight Non-Bendable Spark Plug Boot	10009
1981-1978	8 Cyl. 5.9L; 8.5mm High Performance Wire; Equipped with Ceramic Spark Plug Boots	10052
1981-1978	8 Cyl. 5.9L; 8.5mm High Performance Wire; w/ Straight Bendable Spark Plug Boot	10117

Year	Model/Engine	Part No.
Spark Plug Wire Set		
Dakota		
2003-1998	8 Cyl. 5.9L; 8.5mm High Performance Wire	10016 ¹
2003-1998	8 Cyl. 5.9L; 8.5mm High Performance Wire; Equipped with Ceramic Spark Plug Boots	10073
2003-1997	6 Cyl. 3.9L; 8.5mm High Performance Wire	10062
2003-1997	6 Cyl. 3.9L; 8.5mm High Performance Wire; Equipped with Ceramic Spark Plug Boots	10063
1999-1997	8 Cyl. 5.2L; 8.5mm High Performance Wire; Equipped with Ceramic Spark Plug Boots	10073
1999-1997	8 Cyl. 5.2L; 8.5mm High Performance Wire	10016 ¹
1996	6 Cyl. 3.9L; 8.5mm High Performance Wire; Equipped with Ceramic Spark Plug Boots	10063
1996	8 Cyl. 5.2L; 8.5mm High Performance Wire; Equipped with Ceramic Spark Plug Boots	10073
1996	6 Cyl. 3.9L; 8.5mm High Performance Wire	10062
1996	8 Cyl. 5.2L; 8.5mm High Performance Wire	10016 ¹
1995-1993	8 Cyl. 5.2L; 8.5mm High Performance Wire; Equipped with Ceramic Spark Plug Boots	10073
1995-1993	8 Cyl. 5.2L; 8.5mm High Performance Wire	10016 ¹
1995-1992	6 Cyl. 3.9L; 8.5mm High Performance Wire	10062
1995-1992	6 Cyl. 3.9L; 8.5mm High Performance Wire; Equipped with Ceramic Spark Plug Boots	10063
1992	8 Cyl. 5.2L; 8.5mm High Performance Wire; MFI	10016 ¹
1992	8 Cyl. 5.2L; 8.5mm High Performance Wire; Equipped with Ceramic Spark Plug Boots; MFI	10073
1992-1989	8 Cyl. 5.2L; 8.5mm High Performance Wire; w/ Straight Non-Bendable Spark Plug Boot	10009
1992-1989	8 Cyl. 5.2L; 8.5mm High Performance Wire; Equipped with Ceramic Spark Plug Boots	10052
1992-1989	8 Cyl. 5.2L; 8.5mm High Performance Wire; w/ Straight Bendable Spark Plug Boot	10117
Dart		
1976-1974	8 Cyl. 5.9L; 8.5mm High Performance Wire; Equipped with Ceramic Spark Plug Boots	10052
1976-1974	8 Cyl. 5.9L; 8.5mm High Performance Wire; w/ Straight Non-Bendable Spark Plug Boot	10009
1976-1974	8 Cyl. 5.9L; 8.5mm High Performance Wire; w/ Straight Bendable Spark Plug Boot	10117
1976-1968	8 Cyl. 5.2L; 8.5mm High Performance Wire; Equipped with Ceramic Spark Plug Boots	10052
1976-1968	8 Cyl. 5.2L; 8.5mm High Performance Wire; w/ Straight Non-Bendable Spark Plug Boot	10009
1976-1968	8 Cyl. 5.2L; 8.5mm High Performance Wire; w/ Straight Bendable Spark Plug Boot	10117
1973-1968	8 Cyl. 5.6L; 8.5mm High Performance Wire; w/ Straight Non-Bendable Spark Plug Boot	10009

¹ Wire Set With 2.90 Inch Spark Plug Boots

Wire Sets

Year	Model/Engine	Part No.
Spark Plug Wire Set		
Dart		
1973-1968	8 Cyl. 5.6L; 8.5mm High Performance Wire; Equipped with Ceramic Spark Plug Boots	10052
1973-1968	8 Cyl. 5.6L; 8.5mm High Performance Wire; w/ Straight Bendable Spark Plug Boot	10117
1969-1968	8 Cyl. 6.3L; 8.5mm High Performance Wire	10043
1969-1968	8 Cyl. 4.5L; 8.5mm High Performance Wire; w/ Straight Non-Bendable Spark Plug Boot	10009
1969-1968	8 Cyl. 4.5L; 8.5mm High Performance Wire; Equipped with Ceramic Spark Plug Boots	10052
1969-1968	8 Cyl. 4.5L; 8.5mm High Performance Wire; w/ Straight Bendable Spark Plug Boot	10117
1967	8 Cyl. 6.3L; 8.5mm High Performance Wire	10043
1967	8 Cyl. 5.2L; 8.5mm High Performance Wire; Equipped with Ceramic Spark Plug Boots	10052
1967	8 Cyl. 5.2L; 8.5mm High Performance Wire; w/ Straight Non-Bendable Spark Plug Boot	10009
1967	8 Cyl. 5.2L; 8.5mm High Performance Wire; w/ Straight Bendable Spark Plug Boot	10117
1967-1964	8 Cyl. 4.5L; 8.5mm High Performance Wire; Equipped with Ceramic Spark Plug Boots	10052
1967-1964	8 Cyl. 4.5L; 8.5mm High Performance Wire; w/ Straight Non-Bendable Spark Plug Boot	10009
1967-1964	8 Cyl. 4.5L; 8.5mm High Performance Wire; w/ Straight Bendable Spark Plug Boot	10117
1964	8 Cyl. 6.3L; 8.5mm High Performance Wire; w/ Straight Non-Bendable Spark Plug Boot	10009
1964-1960	8 Cyl. 6.3L; 8.5mm High Performance Wire; Equipped with Ceramic Spark Plug Boots	10052
1964-1960	8 Cyl. 6.3L; 8.5mm High Performance Wire; w/ Straight Bendable Spark Plug Boot	10117
1963	8 Cyl. 6.7L; 8.5mm High Performance Wire; Equipped with Ceramic Spark Plug Boots	10052
1963	8 Cyl. 6.7L; 8.5mm High Performance Wire; w/ Straight Non-Bendable Spark Plug Boot	10009
1963	8 Cyl. 6.7L; 8.5mm High Performance Wire; w/ Straight Bendable Spark Plug Boot	10117
1963-1960	8 Cyl. 5.2L; 8.5mm High Performance Wire; Equipped with Ceramic Spark Plug Boots	10052
1963-1960	8 Cyl. 5.2L; 8.5mm High Performance Wire; w/ Straight Non-Bendable Spark Plug Boot	10009
1963-1960	8 Cyl. 5.2L; 8.5mm High Performance Wire; w/ Straight Bendable Spark Plug Boot	10117
1962-1961	8 Cyl. 6.8L; 8.5mm High Performance Wire; Equipped with Ceramic Spark Plug Boots	10052
1962-1961	8 Cyl. 6.8L; 8.5mm High Performance Wire; w/ Straight Non-Bendable Spark Plug Boot	10009

Year	Model/Engine	Part No.
Spark Plug Wire Set		
Dart		
1962-1961	8 Cyl. 6.8L; 8.5mm High Performance Wire; w/ Straight Bendable Spark Plug Boot	10117
1962-1960	8 Cyl. 6.3L; 8.5mm High Performance Wire; w/ Straight Non-Bendable Spark Plug Boot	10009
1961-1960	8 Cyl. 5.9L; 8.5mm High Performance Wire; w/ Straight Non-Bendable Spark Plug Boot	10009
1961-1960	8 Cyl. 5.9L; 8.5mm High Performance Wire; Equipped with Ceramic Spark Plug Boots	10052
1961-1960	8 Cyl. 5.9L; 8.5mm High Performance Wire; w/ Straight Bendable Spark Plug Boot	10117
Diplomat		
1989-1977	8 Cyl. 5.2L; 8.5mm High Performance Wire; Equipped with Ceramic Spark Plug Boots	10052
1989-1977	8 Cyl. 5.2L; 8.5mm High Performance Wire; w/ Straight Non-Bendable Spark Plug Boot	10009
1989-1977	8 Cyl. 5.2L; 8.5mm High Performance Wire; w/ Straight Bendable Spark Plug Boot	10117
1979-1977	8 Cyl. 5.9L; 8.5mm High Performance Wire; w/ Straight Non-Bendable Spark Plug Boot	10009
1979-1977	8 Cyl. 5.9L; 8.5mm High Performance Wire; Equipped with Ceramic Spark Plug Boots	10052
1979-1977	8 Cyl. 5.9L; 8.5mm High Performance Wire; w/ Straight Bendable Spark Plug Boot	10117
Durango		
2005-2004	8 Cyl. 5.7L; 8.5mm High Performance Wire	10030 ²
2003-1998	8 Cyl. 5.9L; 8.5mm High Performance Wire	10016 ¹
2003-1998	8 Cyl. 5.9L; 8.5mm High Performance Wire; Equipped with Ceramic Spark Plug Boots	10073
2000-1998	8 Cyl. 5.2L; 8.5mm High Performance Wire; Equipped with Ceramic Spark Plug Boots	10073
2000-1998	8 Cyl. 5.2L; 8.5mm High Performance Wire	10016 ¹
1999-1998	6 Cyl. 3.9L; 8.5mm High Performance Wire	10062
1999-1998	6 Cyl. 3.9L; 8.5mm High Performance Wire; Equipped with Ceramic Spark Plug Boots	10063
Lancer		
1962-1961	8 Cyl.; 413; 8.5mm High Performance Wire; w/ Straight Non-Bendable Spark Plug Boot	10009
1962-1961	8 Cyl.; 413; 8.5mm High Performance Wire; Equipped with Ceramic Spark Plug Boots	10052
1962-1961	8 Cyl.; 413; 8.5mm High Performance Wire; w/ Straight Bendable Spark Plug Boot	10117
Magnum		
1979-1978	8 Cyl. 5.9L; 8.5mm High Performance Wire; w/ Straight Non-Bendable Spark Plug Boot	10009
1979-1978	8 Cyl. 5.9L; 8.5mm High Performance Wire; Equipped with Ceramic Spark Plug Boots	10052

Wire Sets

Year	Model/Engine	Part No.
Spark Plug Wire Set		
Magnum		
1979-1978	8 Cyl. 5.2L; 8.5mm High Performance Wire; w/ Straight Non-Bendable Spark Plug Boot	10009
1979-1978	8 Cyl. 5.2L; 8.5mm High Performance Wire; Equipped with Ceramic Spark Plug Boots	10052
1979-1978	8 Cyl. 5.2L; 8.5mm High Performance Wire; w/ Straight Bendable Spark Plug Boot	10117
1979-1978	8 Cyl. 5.9L; 8.5mm High Performance Wire; w/ Straight Bendable Spark Plug Boot	10117
Meadowbrook		
1954-1953	8 Cyl. 3.9L; 8.5mm High Performance Wire	10008
1954-1953	8 Cyl. 3.9L; 8.5mm High Performance Wire; Equipped with Ceramic Spark Plug Boots	10059
Mirada		
1983-1980	8 Cyl. 5.2L; 8.5mm High Performance Wire; Equipped with Ceramic Spark Plug Boots	10052
1983-1980	8 Cyl. 5.2L; 8.5mm High Performance Wire; w/ Straight Non-Bendable Spark Plug Boot	10009
1983-1980	8 Cyl. 5.2L; 8.5mm High Performance Wire; w/ Straight Bendable Spark Plug Boot	10117
1980	8 Cyl. 5.9L; 8.5mm High Performance Wire; Equipped with Ceramic Spark Plug Boots	10052
1980	8 Cyl. 5.9L; 8.5mm High Performance Wire; w/ Straight Non-Bendable Spark Plug Boot	10009
1980	8 Cyl. 5.9L; 8.5mm High Performance Wire; w/ Straight Bendable Spark Plug Boot	10117
Monaco		
1978-1975	8 Cyl. 5.2L; 8.5mm High Performance Wire; w/ Straight Non-Bendable Spark Plug Boot	10009
1978-1975	8 Cyl. 5.2L; 8.5mm High Performance Wire; Equipped with Ceramic Spark Plug Boots	10052
1978-1975	8 Cyl. 5.2L; 8.5mm High Performance Wire; w/ Straight Bendable Spark Plug Boot	10117
1978-1971	8 Cyl. 5.9L; 8.5mm High Performance Wire; Equipped with Ceramic Spark Plug Boots	10052
1978-1971	8 Cyl. 5.9L; 8.5mm High Performance Wire; w/ Straight Non-Bendable Spark Plug Boot	10009
1978-1971	8 Cyl. 5.9L; 8.5mm High Performance Wire; w/ Straight Bendable Spark Plug Boot	10117
1972	8 Cyl. 7.2L; 8.5mm High Performance Wire; Exc. Electronic Ignition	10043
1972	8 Cyl. 6.6L; 8.5mm High Performance Wire; Exc. Electronic Ignition	10043
1971-1969	8 Cyl. 6.3L; 8.5mm High Performance Wire	10043
1971-1969	8 Cyl. 7.2L; 8.5mm High Performance Wire	10043
1970-1968	8 Cyl. 5.2L; 8.5mm High Performance Wire; w/ Straight Non-Bendable Spark Plug Boot	10009
1970-1968	8 Cyl. 5.2L; 8.5mm High Performance Wire; Equipped with Ceramic Spark Plug Boots	10052

Year	Model/Engine	Part No.
Spark Plug Wire Set		
Monaco		
1970-1968	8 Cyl. 5.2L; 8.5mm High Performance Wire; w/ Straight Bendable Spark Plug Boot	10117
1968	8 Cyl. 6.3L; 8.5mm High Performance Wire; w/ High Performance Engine	10043
1968	8 Cyl. 7.2L; 8.5mm High Performance Wire; w/ High Performance Engine	10043
Neon		
1999-1998	4 Cyl. 2.0L; 8.5mm High Performance Wire	10024
1997-1995	4 Cyl. 2.0L; 8.5mm High Performance Wire	10024
P200		
1972	8 Cyl. 5.9L; 8.5mm High Performance Wire; Equipped with Ceramic Spark Plug Boots	10052
1972	8 Cyl. 5.9L; 8.5mm High Performance Wire; w/ Straight Non-Bendable Spark Plug Boot	10009
1972	8 Cyl. 5.9L; 8.5mm High Performance Wire; w/ Straight Bendable Spark Plug Boot	10117
P300		
1972	8 Cyl. 5.9L; 8.5mm High Performance Wire; w/ Straight Non-Bendable Spark Plug Boot	10009
1972	8 Cyl. 5.9L; 8.5mm High Performance Wire; Equipped with Ceramic Spark Plug Boots	10052
1972	8 Cyl. 5.9L; 8.5mm High Performance Wire; w/ Straight Bendable Spark Plug Boot	10117
Polara		
1973-1971	8 Cyl. 5.9L; 8.5mm High Performance Wire; w/ Straight Non-Bendable Spark Plug Boot	10009
1973-1971	8 Cyl. 5.9L; 8.5mm High Performance Wire; Equipped with Ceramic Spark Plug Boots	10052
1973-1971	8 Cyl. 5.9L; 8.5mm High Performance Wire; w/ Straight Bendable Spark Plug Boot	10117
1973-1968	8 Cyl. 5.2L; 8.5mm High Performance Wire; w/ Straight Non-Bendable Spark Plug Boot	10009
1973-1968	8 Cyl. 5.2L; 8.5mm High Performance Wire; Equipped with Ceramic Spark Plug Boots	10052
1973-1968	8 Cyl. 5.2L; 8.5mm High Performance Wire; w/ Straight Bendable Spark Plug Boot	10117
1972	8 Cyl. 7.2L; 8.5mm High Performance Wire; Exc. Electronic Ignition	10043
1972	8 Cyl. 6.6L; 8.5mm High Performance Wire; Exc. Electronic Ignition	10043
1971-1969	8 Cyl. 6.3L; 8.5mm High Performance Wire	10043
1971-1969	8 Cyl. 7.2L; 8.5mm High Performance Wire	10043
1968	8 Cyl. 7.2L; 8.5mm High Performance Wire; w/ High Performance Engine	10043
1968	8 Cyl. 6.3L; 8.5mm High Performance Wire; w/ High Performance Engine	10043
1967-1964	8 Cyl. 4.5L; 8.5mm High Performance Wire; Equipped with Ceramic Spark Plug Boots	10052
1967-1964	8 Cyl. 4.5L; 8.5mm High Performance Wire; w/ Straight Non-Bendable Spark Plug Boot	10009

Wire Sets

Year	Model/Engine	Part No.
Spark Plug Wire Set		
Polara		
1967-1964	8 Cyl. 4.5L; 8.5mm High Performance Wire; w/ Straight Bendable Spark Plug Boot	10117
1967-1960	8 Cyl. 5.2L; 8.5mm High Performance Wire; Equipped with Ceramic Spark Plug Boots	10052
1967-1960	8 Cyl. 5.2L; 8.5mm High Performance Wire; w/ Straight Non-Bendable Spark Plug Boot	10009
1967-1960	8 Cyl. 5.2L; 8.5mm High Performance Wire; w/ Straight Bendable Spark Plug Boot	10117
1963	8 Cyl. 6.8L; 8.5mm High Performance Wire; Equipped with Ceramic Spark Plug Boots	10052
1963	8 Cyl. 6.8L; 8.5mm High Performance Wire; w/ Straight Non-Bendable Spark Plug Boot	10009
1963	8 Cyl. 6.8L; 8.5mm High Performance Wire; w/ Straight Bendable Spark Plug Boot	10117
1962-1961	8 Cyl. 6.7L; 8.5mm High Performance Wire; w/ Straight Non-Bendable Spark Plug Boot	10009
1962-1961	8 Cyl. 6.7L; 8.5mm High Performance Wire; Equipped with Ceramic Spark Plug Boots	10052
1962-1961	8 Cyl. 6.7L; 8.5mm High Performance Wire; w/ Straight Bendable Spark Plug Boot	10117
1962-1960	8 Cyl. 6.3L; 8.5mm High Performance Wire; w/ Straight Non-Bendable Spark Plug Boot	10009
1962-1960	8 Cyl. 6.3L; 8.5mm High Performance Wire; Equipped with Ceramic Spark Plug Boots	10052
1962-1960	8 Cyl. 6.3L; 8.5mm High Performance Wire; w/ Straight Bendable Spark Plug Boot	10117
1961-1960	8 Cyl. 5.9L; 8.5mm High Performance Wire; Equipped with Ceramic Spark Plug Boots	10052
1961-1960	8 Cyl. 5.9L; 8.5mm High Performance Wire; w/ Straight Non-Bendable Spark Plug Boot	10009
1961-1960	8 Cyl. 5.9L; 8.5mm High Performance Wire; w/ Straight Bendable Spark Plug Boot	10117
Ram 1500		
2005-2003	8 Cyl. 5.7L; 8.5mm High Performance Wire	10030 ²
2003-2002	8 Cyl. 5.9L; 8.5mm High Performance Wire	10016 ¹
2003-2002	8 Cyl. 5.9L; 8.5mm High Performance Wire; Equipped with Ceramic Spark Plug Boots	10073
2001-1997	8 Cyl. 5.2L; 8.5mm High Performance Wire	10016 ¹
2001-1997	6 Cyl. 3.9L; 8.5mm High Performance Wire	10062
2001-1997	6 Cyl. 3.9L; 8.5mm High Performance Wire; Equipped with Ceramic Spark Plug Boots	10063
2001-1997	8 Cyl. 5.2L; 8.5mm High Performance Wire; Equipped with Ceramic Spark Plug Boots	10073
2001-1997	8 Cyl. 5.9L; 8.5mm High Performance Wire; Equipped with Ceramic Spark Plug Boots	10073
2001-1997	8 Cyl. 5.9L; 8.5mm High Performance Wire	10016 ¹

Year	Model/Engine	Part No.
Spark Plug Wire Set		
Ram 1500		
1996-1995	8 Cyl. 5.9L; 8.5mm High Performance Wire	10016 ¹
1996-1995	8 Cyl. 5.9L; 8.5mm High Performance Wire; Equipped with Ceramic Spark Plug Boots	10073
1996-1995	8 Cyl. 5.2L; 8.5mm High Performance Wire; Equipped with Ceramic Spark Plug Boots	10073
1996-1995	8 Cyl. 5.2L; 8.5mm High Performance Wire	10016 ¹
1996-1995	6 Cyl. 3.9L; 8.5mm High Performance Wire; Equipped with Ceramic Spark Plug Boots	10063
1996-1995	6 Cyl. 3.9L; 8.5mm High Performance Wire	10062
1994	8 Cyl. 5.2L; 8.5mm High Performance Wire	10016 ¹
1994	8 Cyl. 5.9L; 8.5mm High Performance Wire	10016 ¹
1994	6 Cyl. 3.9L; 8.5mm High Performance Wire; Equipped with Ceramic Spark Plug Boots	10063
1994	6 Cyl. 3.9L; 8.5mm High Performance Wire	10062
1994	8 Cyl. 5.9L; 8.5mm High Performance Wire; Equipped with Ceramic Spark Plug Boots	10073
1994	8 Cyl. 5.2L; 8.5mm High Performance Wire; Equipped with Ceramic Spark Plug Boots	10073
Ram 1500 Van		
2003-1999	8 Cyl. 5.2L; 8.5mm High Performance Wire	10016 ¹
2003-1999	8 Cyl. 5.9L; 8.5mm High Performance Wire	10016 ¹
2003-1999	8 Cyl. 5.2L; 8.5mm High Performance Wire; Equipped with Ceramic Spark Plug Boots	10073
2003-1999	8 Cyl. 5.9L; 8.5mm High Performance Wire; Equipped with Ceramic Spark Plug Boots	10073
2003-1999	6 Cyl. 3.9L; 8.5mm High Performance Wire	10062
2003-1999	6 Cyl. 3.9L; 8.5mm High Performance Wire; Equipped with Ceramic Spark Plug Boots	10063
Ram 2500		
2005-2003	8 Cyl. 5.7L; 8.5mm High Performance Wire	10030 ²
2002-1995	8 Cyl. 5.9L; 8.5mm High Performance Wire	10016 ¹
2002-1995	8 Cyl. 5.9L; 8.5mm High Performance Wire; Equipped with Ceramic Spark Plug Boots	10073
1996-1995	8 Cyl. 5.2L; 8.5mm High Performance Wire	10016 ¹
1996-1995	8 Cyl. 5.2L; 8.5mm High Performance Wire; Equipped with Ceramic Spark Plug Boots	10073
1994	8 Cyl. 5.9L; 8.5mm High Performance Wire	10016 ¹
1994	8 Cyl. 5.9L; 8.5mm High Performance Wire; Equipped with Ceramic Spark Plug Boots	10073
1994	8 Cyl. 5.2L; 8.5mm High Performance Wire	10016 ¹
1994	8 Cyl. 5.2L; 8.5mm High Performance Wire; Equipped with Ceramic Spark Plug Boots	10073

Wire Sets

Year	Model/Engine	Part No.
Spark Plug Wire Set		
Ram 2500 Van		
2003-2000	8 Cyl. 5.2L; 8.5mm High Performance Wire; Equipped with Ceramic Spark Plug Boots	10073
2003-2000	8 Cyl. 5.9L; 8.5mm High Performance Wire	10016 ¹
2003-2000	8 Cyl. 5.2L; 8.5mm High Performance Wire	10016 ¹
2003-2000	8 Cyl. 5.9L; 8.5mm High Performance Wire; Equipped with Ceramic Spark Plug Boots	10073
2001	6 Cyl. 3.9L; 8.5mm High Performance Wire	10062
2001	6 Cyl. 3.9L; 8.5mm High Performance Wire; Equipped with Ceramic Spark Plug Boots	10063
1999	8 Cyl. 5.2L; 8.5mm High Performance Wire; Equipped with Ceramic Spark Plug Boots	10073
1999	8 Cyl. 5.2L; 8.5mm High Performance Wire	10016 ¹
1999	8 Cyl. 5.9L; 8.5mm High Performance Wire	10016 ¹
1999	8 Cyl. 5.9L; 8.5mm High Performance Wire; Equipped with Ceramic Spark Plug Boots	10073
Ram 3500		
2005-2003	8 Cyl. 5.7L; 8.5mm High Performance Wire	10030 ²
2002-1995	8 Cyl. 5.9L; 8.5mm High Performance Wire	10016 ¹
2002-1995	8 Cyl. 5.9L; 8.5mm High Performance Wire; Equipped with Ceramic Spark Plug Boots	10073
1994	8 Cyl. 5.9L; 8.5mm High Performance Wire; Equipped with Ceramic Spark Plug Boots	10073
1994	8 Cyl. 5.9L; 8.5mm High Performance Wire	10016 ¹
Ram 3500 Van		
2003-2001	8 Cyl. 5.2L; 8.5mm High Performance Wire; Equipped with Ceramic Spark Plug Boots	10073
2003-2001	8 Cyl. 5.2L; 8.5mm High Performance Wire	10016 ¹
2003-2000	8 Cyl. 5.9L; 8.5mm High Performance Wire; Equipped with Ceramic Spark Plug Boots	10073
2003-2000	8 Cyl. 5.9L; 8.5mm High Performance Wire	10016 ¹
1999	8 Cyl. 5.2L; 8.5mm High Performance Wire	10016 ¹
1999	8 Cyl. 5.9L; 8.5mm High Performance Wire; Equipped with Ceramic Spark Plug Boots	10073
1999	8 Cyl. 5.9L; 8.5mm High Performance Wire	10016 ¹
1999	8 Cyl. 5.2L; 8.5mm High Performance Wire; Equipped with Ceramic Spark Plug Boots	10073
Ramcharger		
1993	8 Cyl. 5.2L; 8.5mm High Performance Wire; Equipped with Ceramic Spark Plug Boots	10073
1993	8 Cyl. 5.2L; 8.5mm High Performance Wire	10016 ¹
1993-1992	8 Cyl. 5.9L; 8.5mm High Performance Wire	10016 ¹
1993-1992	8 Cyl. 5.9L; 8.5mm High Performance Wire; Equipped with Ceramic Spark Plug Boots	10073

Year	Model/Engine	Part No.
Spark Plug Wire Set		
Ramcharger		
1992	8 Cyl. 5.2L; 8.5mm High Performance Wire; Equipped with Ceramic Spark Plug Boots; MFI	10073
1992	8 Cyl. 5.2L; 8.5mm High Performance Wire; MFI	10016 ¹
1992-1984	8 Cyl. 5.9L; 8.5mm High Performance Wire; Equipped with Ceramic Spark Plug Boots	10052
1992-1974	8 Cyl. 5.9L; 8.5mm High Performance Wire; w/ Straight Non-Bendable Spark Plug Boot	10009
1992-1974	8 Cyl. 5.2L; 8.5mm High Performance Wire; w/ Straight Non-Bendable Spark Plug Boot	10009
1992-1974	8 Cyl. 5.2L; 8.5mm High Performance Wire; Equipped with Ceramic Spark Plug Boots	10052
1992-1974	8 Cyl. 5.2L; 8.5mm High Performance Wire; w/ Straight Bendable Spark Plug Boot	10117
1992-1974	8 Cyl. 5.9L; 8.5mm High Performance Wire; w/ Straight Bendable Spark Plug Boot	10117
1981-1974	8 Cyl. 5.9L; 8.5mm High Performance Wire; Equipped with Ceramic Spark Plug Boots	10052
RD200		
1980	8 Cyl.; 8.5mm High Performance Wire; Equipped with Ceramic Spark Plug Boots	10052
1980	8 Cyl.; 8.5mm High Performance Wire; w/ Straight Non-Bendable Spark Plug Boot	10009
1980	8 Cyl.; 8.5mm High Performance Wire; w/ Straight Bendable Spark Plug Boot	10117
1979	8 Cyl.; 8.5mm High Performance Wire; Equipped with Ceramic Spark Plug Boots	10052
1979	8 Cyl.; 8.5mm High Performance Wire; w/ Straight Non-Bendable Spark Plug Boot	10009
1979	8 Cyl.; 8.5mm High Performance Wire; w/ Straight Bendable Spark Plug Boot	10117
1978	8 Cyl.; 8.5mm High Performance Wire; Equipped with Ceramic Spark Plug Boots	10052
1978	8 Cyl.; 8.5mm High Performance Wire; w/ Straight Non-Bendable Spark Plug Boot	10009
1978	8 Cyl.; 8.5mm High Performance Wire; w/ Straight Bendable Spark Plug Boot	10117
Royal		
1959	8 Cyl. 6.3L; 8.5mm High Performance Wire; Equipped with Ceramic Spark Plug Boots	10059
1959	8 Cyl. 6.3L; 8.5mm High Performance Wire	10008
1959-1958	8 Cyl. 5.9L; 8.5mm High Performance Wire	10008
1959-1958	8 Cyl. 5.9L; 8.5mm High Performance Wire; Equipped with Ceramic Spark Plug Boots	10059
1958	8 Cyl. 5.7L; 8.5mm High Performance Wire	10008
1958	8 Cyl. 5.7L; 8.5mm High Performance Wire; Equipped with Ceramic Spark Plug Boots	10059
1958-1957	8 Cyl. 5.3L; 8.5mm High Performance Wire; Equipped with Ceramic Spark Plug Boots	10059
1958-1957	8 Cyl. 5.3L; 8.5mm High Performance Wire	10008
1956	8 Cyl. 5.1L; 8.5mm High Performance Wire	10008

¹ Wire Set With 2.90 Inch Spark Plug Boots ² Wire Set Contains 8 Plug Leads

Wire Sets

Year	Model/Engine	Part No.
Spark Plug Wire Set		
Royal		
1956	8 Cyl. 5.1L; 8.5mm High Performance Wire; Equipped with Ceramic Spark Plug Boots	10059
1955	8 Cyl. 4.4L; 8.5mm High Performance Wire; Equipped with Ceramic Spark Plug Boots	10059
1955	8 Cyl. 4.4L; 8.5mm High Performance Wire	10008
1954	8 Cyl. 4.0L; 8.5mm High Performance Wire	10008
Royal Monaco		
1977	8 Cyl. 5.2L; 8.5mm High Performance Wire; w/ Straight Non-Bendable Spark Plug Boot	10009
1977	8 Cyl. 5.2L; 8.5mm High Performance Wire; Equipped with Ceramic Spark Plug Boots	10052
1977	8 Cyl. 5.2L; 8.5mm High Performance Wire; w/ Straight Bendable Spark Plug Boot	10117
1977-1975	8 Cyl. 5.9L; 8.5mm High Performance Wire; w/ Straight Non-Bendable Spark Plug Boot	10009
1977-1975	8 Cyl. 5.9L; 8.5mm High Performance Wire; Equipped with Ceramic Spark Plug Boots	10052
1977-1975	8 Cyl. 5.9L; 8.5mm High Performance Wire; w/ Straight Bendable Spark Plug Boot	10117
1975	8 Cyl. 5.2L; 8.5mm High Performance Wire; w/ Straight Non-Bendable Spark Plug Boot	10009
1975	8 Cyl. 5.2L; 8.5mm High Performance Wire; Equipped with Ceramic Spark Plug Boots	10052
1975	8 Cyl. 5.2L; 8.5mm High Performance Wire; w/ Straight Bendable Spark Plug Boot	10117
Sierra		
1959	8 Cyl. 6.3L; 8.5mm High Performance Wire; Equipped with Ceramic Spark Plug Boots	10059
1959	8 Cyl. 6.3L; 8.5mm High Performance Wire	10008
1959-1958	8 Cyl. 5.9L; 8.5mm High Performance Wire	10008
1959-1958	8 Cyl. 5.9L; 8.5mm High Performance Wire; Equipped with Ceramic Spark Plug Boots	10059
1959-1957	8 Cyl. 5.3L; 8.5mm High Performance Wire	10008
1959-1957	8 Cyl. 5.3L; 8.5mm High Performance Wire; Equipped with Ceramic Spark Plug Boots	10059
1958	8 Cyl. 5.7L; 8.5mm High Performance Wire; Equipped with Ceramic Spark Plug Boots	10059
1958	8 Cyl. 5.7L; 8.5mm High Performance Wire	10008
St. Regis		
1981-1979	8 Cyl. 5.2L; 8.5mm High Performance Wire; w/ Straight Non-Bendable Spark Plug Boot	10009
1981-1979	8 Cyl. 5.2L; 8.5mm High Performance Wire; Equipped with Ceramic Spark Plug Boots	10052
1981-1979	8 Cyl. 5.2L; 8.5mm High Performance Wire; w/ Straight Bendable Spark Plug Boot	10117

Year	Model/Engine	Part No.
Spark Plug Wire Set		
St. Regis		
1980-1979	8 Cyl. 5.9L; 8.5mm High Performance Wire; Equipped with Ceramic Spark Plug Boots	10052
1980-1979	8 Cyl. 5.9L; 8.5mm High Performance Wire; w/ Straight Non-Bendable Spark Plug Boot	10009
1980-1979	8 Cyl. 5.9L; 8.5mm High Performance Wire; w/ Straight Bendable Spark Plug Boot	10117
Stratus		
2000-1998	4 Cyl. 2.4L; 8.5mm High Performance Wire	10024
1997-1995	4 Cyl. 2.4L; 8.5mm High Performance Wire	10024
Suburban		
1958-1957	8 Cyl. 5.3L; 8.5mm High Performance Wire; Equipped with Ceramic Spark Plug Boots	10059
1958-1957	8 Cyl. 5.3L; 8.5mm High Performance Wire	10008
W100		
1989-1986	8 Cyl. 5.2L; 8.5mm High Performance Wire; w/ Straight Non-Bendable Spark Plug Boot	10009
1989-1986	8 Cyl. 5.9L; 8.5mm High Performance Wire; Equipped with Ceramic Spark Plug Boots	10052
1989-1986	8 Cyl. 5.2L; 8.5mm High Performance Wire; Equipped with Ceramic Spark Plug Boots	10052
1989-1986	8 Cyl. 5.9L; 8.5mm High Performance Wire; w/ Straight Non-Bendable Spark Plug Boot	10009
1989-1986	8 Cyl. 5.2L; 8.5mm High Performance Wire; w/ Straight Bendable Spark Plug Boot	10117
1989-1986	8 Cyl. 5.9L; 8.5mm High Performance Wire; w/ Straight Bendable Spark Plug Boot	10117
1977-1975	8 Cyl. 5.2L; 8.5mm High Performance Wire; w/ Straight Non-Bendable Spark Plug Boot	10009
1977-1975	8 Cyl. 5.9L; 8.5mm High Performance Wire; Equipped with Ceramic Spark Plug Boots	10052
1977-1975	8 Cyl. 5.2L; 8.5mm High Performance Wire; Equipped with Ceramic Spark Plug Boots	10052
1977-1975	8 Cyl. 5.9L; 8.5mm High Performance Wire; w/ Straight Non-Bendable Spark Plug Boot	10009
1977-1975	8 Cyl. 5.2L; 8.5mm High Performance Wire; w/ Straight Bendable Spark Plug Boot	10117
1977-1975	8 Cyl. 5.9L; 8.5mm High Performance Wire; w/ Straight Bendable Spark Plug Boot	10117
W100 Pickup		
1974-1972	8 Cyl. 5.9L; 8.5mm High Performance Wire; w/ Straight Non-Bendable Spark Plug Boot	10009
1974-1972	8 Cyl. 5.9L; 8.5mm High Performance Wire; Equipped with Ceramic Spark Plug Boots	10052
1974-1972	8 Cyl. 5.9L; 8.5mm High Performance Wire; w/ Straight Bendable Spark Plug Boot	10117
1974-1968	8 Cyl. 5.2L; 8.5mm High Performance Wire; w/ Straight Non-Bendable Spark Plug Boot	10009

Wire Sets

Year	Model/Engine	Part No.
Spark Plug Wire Set		
W100 Pickup		
1974-1968	8 Cyl. 5.2L; 8.5mm High Performance Wire; Equipped with Ceramic Spark Plug Boots	10052
1974-1968	8 Cyl. 5.2L; 8.5mm High Performance Wire; w/ Straight Bendable Spark Plug Boot	10117
W100 Series		
1967-1960	8 Cyl. 5.2L; 8.5mm High Performance Wire; Equipped with Ceramic Spark Plug Boots	10052
1967-1960	8 Cyl. 5.2L; 8.5mm High Performance Wire; w/ Straight Non-Bendable Spark Plug Boot	10009
1967-1960	8 Cyl. 5.2L; 8.5mm High Performance Wire; w/ Straight Bendable Spark Plug Boot	10117
W150		
1993	8 Cyl. 5.9L; 8.5mm High Performance Wire	10016 ¹
1993	8 Cyl. 5.9L; 8.5mm High Performance Wire; Equipped with Ceramic Spark Plug Boots	10073
1993	8 Cyl. 5.2L; 8.5mm High Performance Wire; Equipped with Ceramic Spark Plug Boots	10073
1993	8 Cyl. 5.2L; 8.5mm High Performance Wire	10016 ¹
1993-1992	6 Cyl. 3.9L; 8.5mm High Performance Wire; Equipped with Ceramic Spark Plug Boots	10063
1993-1992	6 Cyl. 3.9L; 8.5mm High Performance Wire	10062
1992	8 Cyl. 5.2L; 8.5mm High Performance Wire; MFI	10016 ¹
1992	8 Cyl. 5.2L; 8.5mm High Performance Wire; Equipped with Ceramic Spark Plug Boots; MFI	10073
1992-1977	8 Cyl. 5.2L; 8.5mm High Performance Wire; Equipped with Ceramic Spark Plug Boots	10052
1992-1977	8 Cyl. 5.2L; 8.5mm High Performance Wire; w/ Straight Non-Bendable Spark Plug Boot	10009
1992-1977	8 Cyl. 5.2L; 8.5mm High Performance Wire; w/ Straight Bendable Spark Plug Boot	10117
1991-1984	8 Cyl. 5.9L; 8.5mm High Performance Wire; Equipped with Ceramic Spark Plug Boots	10052
1991-1977	8 Cyl. 5.9L; 8.5mm High Performance Wire; w/ Straight Non-Bendable Spark Plug Boot	10009
1991-1977	8 Cyl. 5.9L; 8.5mm High Performance Wire; w/ Straight Bendable Spark Plug Boot	10117
1981-1977	8 Cyl. 5.9L; 8.5mm High Performance Wire; Equipped with Ceramic Spark Plug Boots	10052
W200		
1980-1975	8 Cyl. 5.9L; 8.5mm High Performance Wire; w/ Straight Non-Bendable Spark Plug Boot	10009
1980-1975	8 Cyl. 5.2L; 8.5mm High Performance Wire; Equipped with Ceramic Spark Plug Boots	10052
1980-1975	8 Cyl. 5.2L; 8.5mm High Performance Wire; w/ Straight Non-Bendable Spark Plug Boot	10009

Year	Model/Engine	Part No.
Spark Plug Wire Set		
W200		
1980-1975	8 Cyl. 5.9L; 8.5mm High Performance Wire; Equipped with Ceramic Spark Plug Boots	10052
1980-1975	8 Cyl. 5.2L; 8.5mm High Performance Wire; w/ Straight Bendable Spark Plug Boot	10117
1980-1975	8 Cyl. 5.9L; 8.5mm High Performance Wire; w/ Straight Bendable Spark Plug Boot	10117
W200 Pickup		
1974-1971	8 Cyl. 5.9L; 8.5mm High Performance Wire; w/ Straight Non-Bendable Spark Plug Boot	10009
1974-1971	8 Cyl. 5.9L; 8.5mm High Performance Wire; Equipped with Ceramic Spark Plug Boots	10052
1974-1971	8 Cyl. 5.9L; 8.5mm High Performance Wire; w/ Straight Bendable Spark Plug Boot	10117
1974-1970	8 Cyl. 5.2L; 8.5mm High Performance Wire; w/ Straight Non-Bendable Spark Plug Boot	10009
1974-1970	8 Cyl. 5.2L; 8.5mm High Performance Wire; w/ Straight Bendable Spark Plug Boot	10117
1974-1968	8 Cyl. 5.2L; 8.5mm High Performance Wire; Equipped with Ceramic Spark Plug Boots	10052
1968	8 Cyl. 5.2L; 8.5mm High Performance Wire; w/ Straight Non-Bendable Spark Plug Boot	10009
1968	8 Cyl. 5.2L; 8.5mm High Performance Wire; w/ Straight Bendable Spark Plug Boot	10117
W200 Series		
1967-1960	8 Cyl. 5.2L; 8.5mm High Performance Wire; w/ Straight Non-Bendable Spark Plug Boot	10009
1967-1960	8 Cyl. 5.2L; 8.5mm High Performance Wire; Equipped with Ceramic Spark Plug Boots	10052
1967-1960	8 Cyl. 5.2L; 8.5mm High Performance Wire; w/ Straight Bendable Spark Plug Boot	10117
W250		
1993	8 Cyl. 5.2L; 8.5mm High Performance Wire; Equipped with Ceramic Spark Plug Boots	10073
1993	8 Cyl. 5.2L; 8.5mm High Performance Wire	10016 ¹
1993-1992	8 Cyl. 5.9L; 8.5mm High Performance Wire	10016 ¹
1993-1992	8 Cyl. 5.9L; 8.5mm High Performance Wire; Equipped with Ceramic Spark Plug Boots	10073
1992	8 Cyl. 5.2L; 8.5mm High Performance Wire; Equipped with Ceramic Spark Plug Boots; MFI	10073
1992	8 Cyl. 5.2L; 8.5mm High Performance Wire; MFI	10016 ¹
1992-1989	8 Cyl.; 8.5mm High Performance Wire; w/ Straight Non-Bendable Spark Plug Boot	10009
1992-1989	8 Cyl.; 8.5mm High Performance Wire; Equipped with Ceramic Spark Plug Boots	10052
1992-1989	8 Cyl.; 8.5mm High Performance Wire; w/ Straight Bendable Spark Plug Boot	10117
1988-1981	8 Cyl.; 8.5mm High Performance Wire; Equipped with Ceramic Spark Plug Boots	10052
1988-1981	8 Cyl.; 8.5mm High Performance Wire; w/ Straight Non-Bendable Spark Plug Boot	10009

¹ Wire Set With 2.90 Inch Spark Plug Boots

Wire Sets

Year	Model/Engine	Part No.
Spark Plug Wire Set		
W250		
1988-1981	8 Cyl.; 8.5mm High Performance Wire; w/ Straight Bendable Spark Plug Boot	10117
W300		
1980	8 Cyl. 5.2L; 8.5mm High Performance Wire; Equipped with Ceramic Spark Plug Boots	10052
1980	8 Cyl. 5.2L; 8.5mm High Performance Wire; w/ Straight Non-Bendable Spark Plug Boot	10009
1980-1975	8 Cyl. 5.9L; 8.5mm High Performance Wire; Equipped with Ceramic Spark Plug Boots	10052
1980-1975	8 Cyl. 5.9L; 8.5mm High Performance Wire; w/ Straight Non-Bendable Spark Plug Boot	10009
1980-1975	8 Cyl. 5.2L; 8.5mm High Performance Wire; w/ Straight Bendable Spark Plug Boot	10117
1980-1975	8 Cyl. 5.9L; 8.5mm High Performance Wire; w/ Straight Bendable Spark Plug Boot	10117
1978-1975	8 Cyl. 5.2L; 8.5mm High Performance Wire; Equipped with Ceramic Spark Plug Boots	10052
1978-1975	8 Cyl. 5.2L; 8.5mm High Performance Wire; w/ Straight Non-Bendable Spark Plug Boot	10009
W300 Pickup		
1974-1971	8 Cyl. 5.9L; 8.5mm High Performance Wire; Equipped with Ceramic Spark Plug Boots	10052
1974-1971	8 Cyl. 5.9L; 8.5mm High Performance Wire; w/ Straight Non-Bendable Spark Plug Boot	10009
1974-1971	8 Cyl. 5.9L; 8.5mm High Performance Wire; w/ Straight Bendable Spark Plug Boot	10117
1974-1970	8 Cyl. 5.2L; 8.5mm High Performance Wire; Equipped with Ceramic Spark Plug Boots	10052
1974-1970	8 Cyl. 5.2L; 8.5mm High Performance Wire; w/ Straight Non-Bendable Spark Plug Boot	10009
1974-1970	8 Cyl. 5.2L; 8.5mm High Performance Wire; w/ Straight Bendable Spark Plug Boot	10117
1968	8 Cyl. 5.2L; 8.5mm High Performance Wire; Equipped with Ceramic Spark Plug Boots	10052
1968	8 Cyl. 5.2L; 8.5mm High Performance Wire; w/ Straight Non-Bendable Spark Plug Boot	10009
1968	8 Cyl. 5.2L; 8.5mm High Performance Wire; w/ Straight Bendable Spark Plug Boot	10117
W300 Series		
1967	8 Cyl. 5.2L; 8.5mm High Performance Wire; w/ Straight Non-Bendable Spark Plug Boot	10009
1967	8 Cyl. 5.2L; 8.5mm High Performance Wire; Equipped with Ceramic Spark Plug Boots	10052
1967	8 Cyl. 5.2L; 8.5mm High Performance Wire; w/ Straight Bendable Spark Plug Boot	10117
1966-1960	8 Cyl. 5.2L; 8.5mm High Performance Wire; Equipped with Ceramic Spark Plug Boots	10052
1966-1960	8 Cyl. 5.2L; 8.5mm High Performance Wire; w/ Straight Non-Bendable Spark Plug Boot	10009

Year	Model/Engine	Part No.
Spark Plug Wire Set		
W300 Series		
1966-1960	8 Cyl. 5.2L; 8.5mm High Performance Wire; w/ Straight Bendable Spark Plug Boot	10117
W350		
1993-1992	8 Cyl. 5.9L; 8.5mm High Performance Wire	10016 ¹
1993-1992	8 Cyl. 5.9L; 8.5mm High Performance Wire; Equipped with Ceramic Spark Plug Boots	10073
1992-1981	8 Cyl.; 8.5mm High Performance Wire; w/ Straight Non-Bendable Spark Plug Boot	10009
1992-1981	8 Cyl.; 8.5mm High Performance Wire; Equipped with Ceramic Spark Plug Boots	10052
1992-1981	8 Cyl.; 8.5mm High Performance Wire; w/ Straight Bendable Spark Plug Boot	10117
Wm300 Power Wagon		
1962-1960	8 Cyl. 5.2L; 8.5mm High Performance Wire; w/ Straight Non-Bendable Spark Plug Boot	10009
1962-1960	8 Cyl. 5.2L; 8.5mm High Performance Wire; Equipped with Ceramic Spark Plug Boots	10052
1962-1960	8 Cyl. 5.2L; 8.5mm High Performance Wire; w/ Straight Bendable Spark Plug Boot	10117
Eagle		
Wire Sets		
Spark Plug Wire Set		
Talon		
1998-1995	4 Cyl. 2.0L; 8.5mm High Performance Wire; Naturally Aspirated	10024
Ford		
Wire Sets		
Spark Plug Wire Set		
300		
1963	8 Cyl. 6.4L; 8.5mm High Performance Wire	10008
1963	8 Cyl. 6.4L; 8.5mm High Performance Wire; Equipped with Ceramic Spark Plug Boots	10059
1963	8 Cyl. 7.0L; 8.5mm High Performance Wire; Equipped with Ceramic Spark Plug Boots	10059
1963	8 Cyl. 7.0L; 8.5mm High Performance Wire	10008
Aerostar		
1997-1996	6 Cyl. 4.0L; 8.5mm High Performance Wire	10084
1997-1996	6 Cyl. 4.0L; 8.5mm High Performance Wire; Equipped with Ceramic Spark Plug Boots	10085
1995	6 Cyl. 3.0L; 8.5mm High Performance Wire; Equipped with Ceramic Spark Plug Boots; w/ Distributor	10082
1995	6 Cyl. 4.0L; 8.5mm High Performance Wire; Equipped with Ceramic Spark Plug Boots	10085
1995	6 Cyl. 3.0L; 8.5mm High Performance Wire; w/ Distributor	10081
1995	6 Cyl. 4.0L; 8.5mm High Performance Wire	10084
1994-1991	6 Cyl. 3.0L; 8.5mm High Performance Wire; Equipped with Ceramic Spark Plug Boots	10082
1994-1991	6 Cyl. 3.0L; 8.5mm High Performance Wire	10081

Wire Sets

Year	Model/Engine	Part No.
Spark Plug Wire Set		
Aerostar		
1994-1990	6 Cyl. 4.0L; 8.5mm High Performance Wire	10084
1994-1990	6 Cyl. 4.0L; 8.5mm High Performance Wire; Equipped with Ceramic Spark Plug Boots	10085
Bronco		
1996-1983	8 Cyl. 5.8L; 8.5mm High Performance Wire	10019
1996-1983	8 Cyl. 5.8L; 8.5mm High Performance Wire; Equipped with Ceramic Spark Plug Boots	10083
1996-1983	8 Cyl. 5.8L; 9.0mm High Performance Wire	10123
1993-1988	8 Cyl. 5.0L; 8.5mm High Performance Wire; Equipped with Ceramic Spark Plug Boots	10083
1993-1988	8 Cyl. 5.0L; 8.5mm High Performance Wire	10019
1993-1988	8 Cyl. 5.0L; 9.0mm High Performance Wire	10123
1992-1980	6 Cyl. 4.9L; 8.5mm High Performance Wire; Equipped with Ceramic Spark Plug Boots	10045
1992-1980	6 Cyl. 4.9L; 8.5mm High Performance Wire	10044
1987-1981	8 Cyl. 5.0L; 8.5mm High Performance Wire; Equipped with Ceramic Spark Plug Boots	10047
1987-1981	8 Cyl. 5.0L; 8.5mm High Performance Wire	10011
1976-1968	8 Cyl. 5.0L; 8.5mm High Performance Wire	10008
1976-1968	8 Cyl. 5.0L; 8.5mm High Performance Wire; Equipped with Ceramic Spark Plug Boots	10059
1968-1967	8 Cyl. 4.7L; 8.5mm High Performance Wire; Equipped with Ceramic Spark Plug Boots	10059
1968-1967	8 Cyl. 4.7L; 8.5mm High Performance Wire	10008
1966	8 Cyl. 4.7L; 8.5mm High Performance Wire	10008
1966	8 Cyl. 4.7L; 8.5mm High Performance Wire; Equipped with Ceramic Spark Plug Boots	10059
Bronco II		
1990-1986	6 Cyl. 2.9L; 8.5mm High Performance Wire	10081
1990-1986	6 Cyl. 2.9L; 8.5mm High Performance Wire; Equipped with Ceramic Spark Plug Boots	10082
1985-1984	6 Cyl. 2.8L; 8.5mm High Performance Wire; Equipped with Ceramic Spark Plug Boots	10082
1985-1984	6 Cyl. 2.8L; 8.5mm High Performance Wire	10081
Club		
1959-1958	8 Cyl. 5.8L; 8.5mm High Performance Wire; Equipped with Ceramic Spark Plug Boots	10059
1959-1958	8 Cyl. 5.8L; 8.5mm High Performance Wire	10008
1959-1958	8 Cyl. 4.8L; 8.5mm High Performance Wire	10008
1959-1958	8 Cyl. 4.8L; 8.5mm High Performance Wire; Equipped with Ceramic Spark Plug Boots	10059
1957	8 Cyl. 4.4L; 8.5mm High Performance Wire	10008

Year	Model/Engine	Part No.
Spark Plug Wire Set		
Club		
1957	8 Cyl. 4.4L; 8.5mm High Performance Wire; Equipped with Ceramic Spark Plug Boots	10059
Contour		
2000	4 Cyl. 2.0L; 8.5mm High Performance Wire; DOHC	10029
1999	4 Cyl. 2.0L; 8.5mm High Performance Wire; DOHC; From 5/3/99	10029
Country Sedan		
1974-1972	8 Cyl. 7.5L; 8.5mm High Performance Wire	10008
1974-1972	8 Cyl. 7.5L; 8.5mm High Performance Wire; Equipped with Ceramic Spark Plug Boots	10059
1974-1971	8 Cyl. 6.6L; 8.5mm High Performance Wire; Equipped with Ceramic Spark Plug Boots	10059
1974-1971	8 Cyl. 6.6L; 8.5mm High Performance Wire	10008
1973-1970	8 Cyl. 5.8L; 8.5mm High Performance Wire; Equipped with Ceramic Spark Plug Boots	10059
1973-1970	8 Cyl. 5.8L; 8.5mm High Performance Wire	10008
1973-1968	8 Cyl. 7.0L; 8.5mm High Performance Wire; Equipped with Ceramic Spark Plug Boots	10059
1973-1968	8 Cyl. 7.0L; 8.5mm High Performance Wire	10008
1972-1971	8 Cyl. 5.0L; 8.5mm High Performance Wire; Equipped with Ceramic Spark Plug Boots	10059
1972-1971	8 Cyl. 5.0L; 8.5mm High Performance Wire	10008
1971-1968	8 Cyl. 6.4L; 8.5mm High Performance Wire; Equipped with Ceramic Spark Plug Boots	10059
1971-1968	8 Cyl. 6.4L; 8.5mm High Performance Wire	10008
1969	8 Cyl. 5.0L; 8.5mm High Performance Wire; Equipped with Ceramic Spark Plug Boots	10059
1969	8 Cyl. 5.0L; 8.5mm High Performance Wire	10008
1968	8 Cyl. 5.0L; 8.5mm High Performance Wire; w/ Improved Combustion Emission	10008
1968	8 Cyl. 5.0L; 8.5mm High Performance Wire; Equipped with Ceramic Spark Plug Boots; w/ Improved Combustion Emission	10059
1967-1963	8 Cyl. 4.7L; 8.5mm High Performance Wire	10008
1967-1963	8 Cyl. 4.7L; 8.5mm High Performance Wire; Equipped with Ceramic Spark Plug Boots	10059
1967-1962	8 Cyl. 6.4L; 8.5mm High Performance Wire; Equipped with Ceramic Spark Plug Boots	10059
1967-1962	8 Cyl. 6.4L; 8.5mm High Performance Wire	10008
1967-1958	8 Cyl. 5.8L; 8.5mm High Performance Wire	10008
1967-1958	8 Cyl. 5.8L; 8.5mm High Performance Wire; Equipped with Ceramic Spark Plug Boots	10059
1966-1964	8 Cyl. 7.0L; 8.5mm High Performance Wire; Equipped with Ceramic Spark Plug Boots	10059
1966-1964	8 Cyl. 7.0L; 8.5mm High Performance Wire	10008

Ford

Wire Sets

Year	Model/Engine	Part No.
Spark Plug Wire Set		
Country Sedan		
1964-1963	8 Cyl. 4.3L; 8.5mm High Performance Wire	10008
1964-1963	8 Cyl. 4.3L; 8.5mm High Performance Wire; Equipped with Ceramic Spark Plug Boots	10059
1962-1958	8 Cyl. 4.8L; 8.5mm High Performance Wire; Equipped with Ceramic Spark Plug Boots	10059
1962-1958	8 Cyl. 4.8L; 8.5mm High Performance Wire	10008
1959-1958	8 Cyl. 5.4L; 8.5mm High Performance Wire; Equipped with Ceramic Spark Plug Boots	10059
1959-1958	8 Cyl. 5.4L; 8.5mm High Performance Wire	10008
1957	8 Cyl. 4.4L; 8.5mm High Performance Wire	10008
1957	8 Cyl. 4.4L; 8.5mm High Performance Wire; Equipped with Ceramic Spark Plug Boots	10059
Country Squire		
1991-1987	8 Cyl. 5.0L; 8.5mm High Performance Wire; Equipped with Ceramic Spark Plug Boots	10047
1991-1987	8 Cyl. 5.0L; 8.5mm High Performance Wire	10011
1974-1972	8 Cyl. 7.5L; 8.5mm High Performance Wire	10008
1974-1972	8 Cyl. 7.5L; 8.5mm High Performance Wire; Equipped with Ceramic Spark Plug Boots	10059
1974-1971	8 Cyl. 6.6L; 8.5mm High Performance Wire	10008
1974-1971	8 Cyl. 6.6L; 8.5mm High Performance Wire; Equipped with Ceramic Spark Plug Boots	10059
1973-1971	8 Cyl. 7.0L; 8.5mm High Performance Wire	10008
1973-1971	8 Cyl. 7.0L; 8.5mm High Performance Wire; Equipped with Ceramic Spark Plug Boots	10059
1973-1970	8 Cyl. 5.8L; 8.5mm High Performance Wire; Equipped with Ceramic Spark Plug Boots	10059
1973-1970	8 Cyl. 5.8L; 8.5mm High Performance Wire	10008
1972-1969	8 Cyl. 5.0L; 8.5mm High Performance Wire	10008
1972-1969	8 Cyl. 5.0L; 8.5mm High Performance Wire; Equipped with Ceramic Spark Plug Boots	10059
1971-1968	8 Cyl. 6.4L; 8.5mm High Performance Wire	10008
1971-1968	8 Cyl. 6.4L; 8.5mm High Performance Wire; Equipped with Ceramic Spark Plug Boots	10059
1969-1968	8 Cyl. 7.0L; 8.5mm High Performance Wire	10008
1969-1968	8 Cyl. 7.0L; 8.5mm High Performance Wire; Equipped with Ceramic Spark Plug Boots	10059
1968	8 Cyl. 5.0L; 8.5mm High Performance Wire; Equipped with Ceramic Spark Plug Boots; w/ Improved Combustion Emission	10059
1968	8 Cyl. 5.0L; 8.5mm High Performance Wire; w/ Improved Combustion Emission	10008
1967	8 Cyl. 6.4L; 8.5mm High Performance Wire; Equipped with Ceramic Spark Plug Boots	10059

Year	Model/Engine	Part No.
Spark Plug Wire Set		
Country Squire		
1967	8 Cyl. 6.4L; 8.5mm High Performance Wire	10008
1967-1966	8 Cyl. 7.0L; 8.5mm High Performance Wire	10008
1967-1966	8 Cyl. 7.0L; 8.5mm High Performance Wire; Equipped with Ceramic Spark Plug Boots	10059
1967-1963	8 Cyl. 4.7L; 8.5mm High Performance Wire	10008
1967-1963	8 Cyl. 4.7L; 8.5mm High Performance Wire; Equipped with Ceramic Spark Plug Boots	10059
1967-1958	8 Cyl. 5.8L; 8.5mm High Performance Wire	10008
1967-1958	8 Cyl. 5.8L; 8.5mm High Performance Wire; Equipped with Ceramic Spark Plug Boots	10059
1964	8 Cyl. 7.0L; 8.5mm High Performance Wire	10008
1964	8 Cyl. 7.0L; 8.5mm High Performance Wire; Equipped with Ceramic Spark Plug Boots	10059
1964-1963	8 Cyl. 4.3L; 8.5mm High Performance Wire	10008
1964-1963	8 Cyl. 4.3L; 8.5mm High Performance Wire; Equipped with Ceramic Spark Plug Boots	10059
1964-1962	8 Cyl. 6.4L; 8.5mm High Performance Wire; Equipped with Ceramic Spark Plug Boots	10059
1964-1962	8 Cyl. 6.4L; 8.5mm High Performance Wire	10008
1962-1958	8 Cyl. 4.8L; 8.5mm High Performance Wire	10008
1962-1958	8 Cyl. 4.8L; 8.5mm High Performance Wire; Equipped with Ceramic Spark Plug Boots	10059
1959-1958	8 Cyl. 5.4L; 8.5mm High Performance Wire	10008
1959-1958	8 Cyl. 5.4L; 8.5mm High Performance Wire; Equipped with Ceramic Spark Plug Boots	10059
1957	8 Cyl. 4.4L; 8.5mm High Performance Wire; Equipped with Ceramic Spark Plug Boots	10059
1957	8 Cyl. 4.4L; 8.5mm High Performance Wire	10008
Courier Sedan Delivery		
1958-1957	8 Cyl. 5.8L; 8.5mm High Performance Wire; Equipped with Ceramic Spark Plug Boots	10059
1958-1957	8 Cyl. 5.8L; 8.5mm High Performance Wire	10008
1958-1957	8 Cyl. 4.8L; 8.5mm High Performance Wire	10008
1958-1957	8 Cyl. 4.8L; 8.5mm High Performance Wire; Equipped with Ceramic Spark Plug Boots	10059
1957	8 Cyl. 4.4L; 8.5mm High Performance Wire; Equipped with Ceramic Spark Plug Boots	10059
1957	8 Cyl. 4.4L; 8.5mm High Performance Wire	10008
Custom		
1972-1971	8 Cyl. 6.6L; 8.5mm High Performance Wire	10008
1972-1971	8 Cyl. 7.0L; 8.5mm High Performance Wire; Equipped with Ceramic Spark Plug Boots	10059

Wire Sets

Year	Model/Engine	Part No.
Spark Plug Wire Set		
Custom		
1972-1971	8 Cyl. 6.6L; 8.5mm High Performance Wire; Equipped with Ceramic Spark Plug Boots	10059
1972-1971	8 Cyl. 7.0L; 8.5mm High Performance Wire	10008
1972-1970	8 Cyl. 5.8L; 8.5mm High Performance Wire; Equipped with Ceramic Spark Plug Boots	10059
1972-1970	8 Cyl. 5.8L; 8.5mm High Performance Wire	10008
1972-1969	8 Cyl. 5.0L; 8.5mm High Performance Wire; Equipped with Ceramic Spark Plug Boots	10059
1972-1969	8 Cyl. 5.0L; 8.5mm High Performance Wire	10008
1971-1968	8 Cyl. 6.4L; 8.5mm High Performance Wire	10008
1971-1968	8 Cyl. 6.4L; 8.5mm High Performance Wire; Equipped with Ceramic Spark Plug Boots	10059
1969-1968	8 Cyl. 7.0L; 8.5mm High Performance Wire; Equipped with Ceramic Spark Plug Boots	10059
1969-1968	8 Cyl. 7.0L; 8.5mm High Performance Wire	10008
1968	8 Cyl. 4.7L; 8.5mm High Performance Wire; Equipped with Ceramic Spark Plug Boots	10059
1968	8 Cyl. 5.0L; 8.5mm High Performance Wire; Equipped with Ceramic Spark Plug Boots; w/ Improved Combustion Emission	10059
1968	8 Cyl. 4.7L; 8.5mm High Performance Wire	10008
1968	8 Cyl. 5.0L; 8.5mm High Performance Wire; w/ Improved Combustion Emission	10008
1967-1965	8 Cyl. 7.0L; 8.5mm High Performance Wire; Equipped with Ceramic Spark Plug Boots	10059
1967-1965	8 Cyl. 7.0L; 8.5mm High Performance Wire	10008
1967-1964	8 Cyl. 6.4L; 8.5mm High Performance Wire; Equipped with Ceramic Spark Plug Boots	10059
1967-1964	8 Cyl. 6.4L; 8.5mm High Performance Wire	10008
1967-1964	8 Cyl. 4.7L; 8.5mm High Performance Wire; Equipped with Ceramic Spark Plug Boots	10059
1967-1964	8 Cyl. 4.7L; 8.5mm High Performance Wire	10008
1966-1964	8 Cyl. 5.8L; 8.5mm High Performance Wire	10008
1966-1964	8 Cyl. 5.8L; 8.5mm High Performance Wire; Equipped with Ceramic Spark Plug Boots	10059
1964	8 Cyl. 4.3L; 8.5mm High Performance Wire; Equipped with Ceramic Spark Plug Boots	10059
1964	8 Cyl. 4.3L; 8.5mm High Performance Wire	10008
1957	8 Cyl. 4.8L; 8.5mm High Performance Wire	10008
1957	8 Cyl. 4.8L; 8.5mm High Performance Wire; Equipped with Ceramic Spark Plug Boots	10059
1957	8 Cyl. 4.4L; 8.5mm High Performance Wire	10008
1957	8 Cyl. 4.4L; 8.5mm High Performance Wire; Equipped with Ceramic Spark Plug Boots	10059

Year	Model/Engine	Part No.
Spark Plug Wire Set		
Custom 300		
1960-1958	8 Cyl. 5.8L; 8.5mm High Performance Wire; Equipped with Ceramic Spark Plug Boots	10059
1960-1958	8 Cyl. 5.8L; 8.5mm High Performance Wire	10008
1959-1958	8 Cyl. 5.4L; 8.5mm High Performance Wire	10008
1959-1958	8 Cyl. 5.4L; 8.5mm High Performance Wire; Equipped with Ceramic Spark Plug Boots	10059
1959-1957	8 Cyl. 4.8L; 8.5mm High Performance Wire; Equipped with Ceramic Spark Plug Boots	10059
1959-1957	8 Cyl. 4.8L; 8.5mm High Performance Wire	10008
1957	8 Cyl. 4.4L; 8.5mm High Performance Wire; Equipped with Ceramic Spark Plug Boots	10059
1957	8 Cyl. 4.4L; 8.5mm High Performance Wire	10008
Custom 500		
1976	8 Cyl. 5.8L; 8.5mm High Performance Wire; Equipped with Ceramic Spark Plug Boots	10059
1976	8 Cyl. 5.8L; 8.5mm High Performance Wire	10008
1976-1973	8 Cyl. 7.5L; 8.5mm High Performance Wire	10008
1976-1973	8 Cyl. 7.5L; 8.5mm High Performance Wire; Equipped with Ceramic Spark Plug Boots	10059
1976-1971	8 Cyl. 6.6L; 8.5mm High Performance Wire; Equipped with Ceramic Spark Plug Boots	10059
1976-1971	8 Cyl. 6.6L; 8.5mm High Performance Wire	10008
1975	8 Cyl. 5.8L; Windsor Eng.; 8.5mm High Performance Wire	10008
1975	8 Cyl. 5.8L; Windsor Eng.; 8.5mm High Performance Wire; Equipped with Ceramic Spark Plug Boots	10059
1975	8 Cyl. 5.8L; Modified Eng.; 8.5mm High Performance Wire	10008
1975	8 Cyl. 5.8L; Modified Eng.; 8.5mm High Performance Wire; Equipped with Ceramic Spark Plug Boots	10059
1973-1971	8 Cyl. 7.0L; 8.5mm High Performance Wire; Equipped with Ceramic Spark Plug Boots	10059
1973-1971	8 Cyl. 7.0L; 8.5mm High Performance Wire	10008
1973-1970	8 Cyl. 5.8L; 8.5mm High Performance Wire; Equipped with Ceramic Spark Plug Boots	10059
1973-1970	8 Cyl. 5.8L; 8.5mm High Performance Wire	10008
1972-1969	8 Cyl. 5.0L; 8.5mm High Performance Wire	10008
1972-1969	8 Cyl. 5.0L; 8.5mm High Performance Wire; Equipped with Ceramic Spark Plug Boots	10059
1971-1968	8 Cyl. 6.4L; 8.5mm High Performance Wire	10008
1971-1968	8 Cyl. 6.4L; 8.5mm High Performance Wire; Equipped with Ceramic Spark Plug Boots	10059
1969-1968	8 Cyl. 7.0L; 8.5mm High Performance Wire; Equipped with Ceramic Spark Plug Boots	10059

Wire Sets

Year	Model/Engine	Part No.
Spark Plug Wire Set		
Custom 500		
1969-1968	8 Cyl. 7.0L; 8.5mm High Performance Wire	10008
1968	8 Cyl. 5.0L; 8.5mm High Performance Wire; w/ Improved Combustion Emission	10008
1968	8 Cyl. 4.7L; 8.5mm High Performance Wire; Equipped with Ceramic Spark Plug Boots	10059
1968	8 Cyl. 5.0L; 8.5mm High Performance Wire; Equipped with Ceramic Spark Plug Boots; w/ Improved Combustion Emission	10059
1968	8 Cyl. 4.7L; 8.5mm High Performance Wire	10008
1967-1966	8 Cyl. 6.4L; 8.5mm High Performance Wire; Equipped with Ceramic Spark Plug Boots	10059
1967-1966	8 Cyl. 6.4L; 8.5mm High Performance Wire	10008
1967-1965	8 Cyl. 7.0L; 8.5mm High Performance Wire; Equipped with Ceramic Spark Plug Boots	10059
1967-1965	8 Cyl. 7.0L; 8.5mm High Performance Wire	10008
1967-1964	8 Cyl. 4.7L; 8.5mm High Performance Wire; Equipped with Ceramic Spark Plug Boots	10059
1967-1964	8 Cyl. 4.7L; 8.5mm High Performance Wire	10008
1966-1964	8 Cyl. 5.8L; 8.5mm High Performance Wire	10008
1966-1964	8 Cyl. 5.8L; 8.5mm High Performance Wire; Equipped with Ceramic Spark Plug Boots	10059
1964	8 Cyl. 6.4L; 8.5mm High Performance Wire; Equipped with Ceramic Spark Plug Boots	10059
1964	8 Cyl. 6.4L; 8.5mm High Performance Wire	10008
1964	8 Cyl. 4.3L; 8.5mm High Performance Wire	10008
1964	8 Cyl. 4.3L; 8.5mm High Performance Wire; Equipped with Ceramic Spark Plug Boots	10059
Del Rio Wagon		
1958	8 Cyl. 5.4L; 8.5mm High Performance Wire	10008
1958	8 Cyl. 5.4L; 8.5mm High Performance Wire; Equipped with Ceramic Spark Plug Boots	10059
1958	8 Cyl. 5.8L; 8.5mm High Performance Wire	10008
1958	8 Cyl. 5.8L; 8.5mm High Performance Wire; Equipped with Ceramic Spark Plug Boots	10059
1958-1957	8 Cyl. 4.8L; 8.5mm High Performance Wire; Equipped with Ceramic Spark Plug Boots	10059
1958-1957	8 Cyl. 4.8L; 8.5mm High Performance Wire	10008
1957	8 Cyl. 5.1L; 8.5mm High Performance Wire; Equipped with Ceramic Spark Plug Boots	10059
1957	8 Cyl. 5.1L; 8.5mm High Performance Wire	10008
1957	8 Cyl. 4.4L; 8.5mm High Performance Wire	10008
1957	8 Cyl. 4.4L; 8.5mm High Performance Wire; Equipped with Ceramic Spark Plug Boots	10059

Year	Model/Engine	Part No.
Spark Plug Wire Set		
E-100 Econoline		
1983-1977	6 Cyl. 4.9L; 8.5mm High Performance Wire; Equipped with Ceramic Spark Plug Boots	10045
1983-1977	6 Cyl. 4.9L; 8.5mm High Performance Wire	10044
E-100 Econoline Club Wagon		
1983-1977	6 Cyl. 4.9L; 8.5mm High Performance Wire	10044
1983-1977	6 Cyl. 4.9L; 8.5mm High Performance Wire; Equipped with Ceramic Spark Plug Boots	10045
E-150 Econoline		
1996-1977	6 Cyl. 4.9L; 8.5mm High Performance Wire; Equipped with Ceramic Spark Plug Boots	10045
1996-1977	6 Cyl. 4.9L; 8.5mm High Performance Wire	10044
E-150 Econoline Club Wagon		
1996-1977	6 Cyl. 4.9L; 8.5mm High Performance Wire; Equipped with Ceramic Spark Plug Boots	10045
1996-1977	6 Cyl. 4.9L; 8.5mm High Performance Wire	10044
E-250 Econoline		
1996-1977	6 Cyl. 4.9L; 8.5mm High Performance Wire	10044
1996-1977	6 Cyl. 4.9L; 8.5mm High Performance Wire; Equipped with Ceramic Spark Plug Boots	10045
E-250 Econoline Club Wagon		
1991-1983	6 Cyl. 4.9L; 8.5mm High Performance Wire	10044
1991-1977	6 Cyl. 4.9L; 8.5mm High Performance Wire; Equipped with Ceramic Spark Plug Boots	10045
1980-1977	6 Cyl. 4.9L; 8.5mm High Performance Wire	10044
E-350 Econoline		
1996-1977	6 Cyl. 4.9L; 8.5mm High Performance Wire; Equipped with Ceramic Spark Plug Boots	10045
1996-1977	6 Cyl. 4.9L; 8.5mm High Performance Wire	10044
E-350 Econoline Club Wagon		
1996-1977	6 Cyl. 4.9L; 8.5mm High Performance Wire; Equipped with Ceramic Spark Plug Boots	10045
1996-1977	6 Cyl. 4.9L; 8.5mm High Performance Wire	10044
Elite		
1976-1975	8 Cyl. 6.6L; 8.5mm High Performance Wire	10008
1976-1975	8 Cyl. 5.8L; Modified Eng.; 8.5mm High Performance Wire	10008
1976-1975	8 Cyl. 5.8L; Windsor Eng.; 8.5mm High Performance Wire	10008
1976-1975	8 Cyl. 6.6L; 8.5mm High Performance Wire; Equipped with Ceramic Spark Plug Boots	10059
1976-1975	8 Cyl. 7.5L; 8.5mm High Performance Wire; Equipped with Ceramic Spark Plug Boots	10059
1976-1975	8 Cyl. 7.5L; 8.5mm High Performance Wire	10008
1976-1975	8 Cyl. 5.8L; Modified Eng.; 8.5mm High Performance Wire; Equipped with Ceramic Spark Plug Boots	10059

Wire Sets

Year	Model/Engine	Part No.
Spark Plug Wire Set		
Elite		
1976-1975	8 Cyl. 5.8L; Windsor Eng.; 8.5mm High Performance Wire; Equipped with Ceramic Spark Plug Boots	10059
Escape		
2004-2001	4 Cyl. 2.0L; 8.5mm High Performance Wire; DOHC	10029
Explorer		
2001	6 Cyl. 4.0L; K; 8.5mm High Performance Wire; Equipped with Ceramic Spark Plug Boots	10085
2001	6 Cyl. 4.0L; K; 8.5mm High Performance Wire	10084
2000-1997	6 Cyl. 4.0L; X; 8.5mm High Performance Wire	10084
2000-1997	6 Cyl. 4.0L; X; 8.5mm High Performance Wire; Equipped with Ceramic Spark Plug Boots	10085
1996-1995	6 Cyl. 4.0L; 8.5mm High Performance Wire	10084
1996-1995	6 Cyl. 4.0L; 8.5mm High Performance Wire; Equipped with Ceramic Spark Plug Boots	10085
1994-1991	6 Cyl. 4.0L; 8.5mm High Performance Wire	10084
1994-1991	6 Cyl. 4.0L; 8.5mm High Performance Wire; Equipped with Ceramic Spark Plug Boots	10085
F-100		
1983-1981	8 Cyl. 5.0L; 8.5mm High Performance Wire; Equipped with Ceramic Spark Plug Boots	10047
1983-1981	8 Cyl. 5.0L; 8.5mm High Performance Wire	10011
1983-1977	6 Cyl. 4.9L; 8.5mm High Performance Wire	10044
1983-1977	6 Cyl. 4.9L; 8.5mm High Performance Wire; Equipped with Ceramic Spark Plug Boots	10045
1981	8 Cyl. 5.8L; Windsor Eng.; 8.5mm High Performance Wire; Equipped with Ceramic Spark Plug Boots	10083
1981	8 Cyl. 5.8L; Windsor Eng.; 8.5mm High Performance Wire	10019
1981	8 Cyl. 5.8L; Windsor Eng.; 9.0mm High Performance Wire	10123
1976-1975	8 Cyl. 6.4L; 8.5mm High Performance Wire; Equipped with Ceramic Spark Plug Boots	10059
1976-1975	8 Cyl. 5.9L; 8.5mm High Performance Wire	10008
1976-1975	8 Cyl. 5.0L; 8.5mm High Performance Wire	10008
1976-1975	8 Cyl. 5.0L; 8.5mm High Performance Wire; Equipped with Ceramic Spark Plug Boots	10059
1976-1975	8 Cyl. 7.5L; 8.5mm High Performance Wire; Equipped with Ceramic Spark Plug Boots	10059
1976-1975	8 Cyl. 5.9L; 8.5mm High Performance Wire; Equipped with Ceramic Spark Plug Boots	10059
1976-1975	8 Cyl. 7.5L; 8.5mm High Performance Wire	10008
1976-1975	8 Cyl. 6.4L; 8.5mm High Performance Wire	10008
F-100 Pickup		
1974-1973	8 Cyl. 7.5L; 8.5mm High Performance Wire	10008

Year	Model/Engine	Part No.
Spark Plug Wire Set		
F-100 Pickup		
1974-1973	8 Cyl. 7.5L; 8.5mm High Performance Wire; Equipped with Ceramic Spark Plug Boots	10059
1974-1968	8 Cyl. 5.9L; 8.5mm High Performance Wire	10008
1974-1968	8 Cyl. 6.4L; 8.5mm High Performance Wire; Equipped with Ceramic Spark Plug Boots	10059
1974-1968	8 Cyl. 5.9L; 8.5mm High Performance Wire; Equipped with Ceramic Spark Plug Boots	10059
1974-1968	8 Cyl. 6.4L; 8.5mm High Performance Wire	10008
1973-1969	8 Cyl. 5.0L; 8.5mm High Performance Wire	10008
1973-1969	8 Cyl. 5.0L; 8.5mm High Performance Wire; Equipped with Ceramic Spark Plug Boots	10059
1967-1965	8 Cyl. 5.8L; 8.5mm High Performance Wire	10008
1967-1965	8 Cyl. 5.8L; 8.5mm High Performance Wire; Equipped with Ceramic Spark Plug Boots	10059
1960	8 Cyl. 5.4L; 8.5mm High Performance Wire; Equipped with Ceramic Spark Plug Boots	10059
1960	8 Cyl. 5.4L; 8.5mm High Performance Wire	10008
1960	8 Cyl. 4.8L; 8.5mm High Performance Wire; Equipped with Ceramic Spark Plug Boots	10059
1960	8 Cyl. 4.8L; 8.5mm High Performance Wire	10008
1958	8 Cyl. 5.8L; 8.5mm High Performance Wire	10008
1958	8 Cyl. 5.8L; 8.5mm High Performance Wire; Equipped with Ceramic Spark Plug Boots	10059
1958	8 Cyl. 4.8L; 8.5mm High Performance Wire; Equipped with Ceramic Spark Plug Boots	10059
1958	8 Cyl. 4.8L; 8.5mm High Performance Wire	10008
1955	8 Cyl. 3.9L; 8.5mm High Performance Wire; Equipped with Ceramic Spark Plug Boots	10059
1955	8 Cyl. 3.9L; 8.5mm High Performance Wire	10008
F-150		
1996	8 Cyl. 5.8L; 8.5mm High Performance Wire; Equipped with Ceramic Spark Plug Boots	10083
1996	8 Cyl. 5.8L; 8.5mm High Performance Wire	10019
1996-1995	6 Cyl. 4.9L; 8.5mm High Performance Wire; Equipped with Ceramic Spark Plug Boots	10045
1996-1995	6 Cyl. 4.9L; 8.5mm High Performance Wire	10044
1996-1995	8 Cyl. 5.8L; 9.0mm High Performance Wire	10123
1995	8 Cyl. 5.8L; Eddie Bauer; 8.5mm High Performance Wire; Equipped with Ceramic Spark Plug Boots	10083
1995	8 Cyl. 5.8L; XL; 8.5mm High Performance Wire; Equipped with Ceramic Spark Plug Boots	10083
1995	8 Cyl. 5.8L; XL; 8.5mm High Performance Wire	10019

Wire Sets

Year	Model/Engine	Part No.
Spark Plug Wire Set		
F-150		
1995	8 Cyl. 5.8L; XLT; 8.5mm High Performance Wire; Equipped with Ceramic Spark Plug Boots	10083
1995	8 Cyl. 5.8L; XLT; 8.5mm High Performance Wire	10019
1995	8 Cyl. 5.8L; Special; 8.5mm High Performance Wire; Equipped with Ceramic Spark Plug Boots	10083
1995	8 Cyl. 5.8L; Special; 8.5mm High Performance Wire	10019
1995	8 Cyl. 5.8L; Eddie Bauer; 8.5mm High Performance Wire	10019
1994-1993	8 Cyl. 5.8L; XL; 8.5mm High Performance Wire; Equipped with Ceramic Spark Plug Boots	10083
1994-1993	8 Cyl. 5.8L; XL; 8.5mm High Performance Wire	10019
1994-1993	8 Cyl. 5.8L; XLT; 8.5mm High Performance Wire; Equipped with Ceramic Spark Plug Boots	10083
1994-1993	8 Cyl. 5.8L; XLT; 8.5mm High Performance Wire	10019
1994-1982	8 Cyl. 5.8L; 9.0mm High Performance Wire	10123
1994-1977	6 Cyl. 4.9L; 8.5mm High Performance Wire	10044
1994-1977	6 Cyl. 4.9L; 8.5mm High Performance Wire; Equipped with Ceramic Spark Plug Boots	10045
1993	8 Cyl. 5.0L; 8.5mm High Performance Wire; Equipped with Ceramic Spark Plug Boots	10083
1993	8 Cyl. 5.0L; 8.5mm High Performance Wire	10019
1993	8 Cyl. 5.0L; 9.0mm High Performance Wire	10123
1992-1988	8 Cyl. 5.0L; 8.5mm High Performance Wire; w/o EEC IV	10011
1992-1988	8 Cyl. 5.0L; 8.5mm High Performance Wire; Equipped with Ceramic Spark Plug Boots; w/ EEC IV	10083
1992-1988	8 Cyl. 5.0L; 8.5mm High Performance Wire; Equipped with Ceramic Spark Plug Boots; w/o EEC IV	10047
1992-1988	8 Cyl. 5.0L; 8.5mm High Performance Wire; w/ EEC IV	10019
1992-1988	8 Cyl. 5.0L; 9.0mm High Performance Wire; w/ EEC IV	10123
1992-1983	8 Cyl. 5.8L; 8.5mm High Performance Wire; Equipped with Ceramic Spark Plug Boots	10083
1992-1983	8 Cyl. 5.8L; 8.5mm High Performance Wire	10019
1987-1981	8 Cyl. 5.0L; 8.5mm High Performance Wire; Equipped with Ceramic Spark Plug Boots	10047
1987-1981	8 Cyl. 5.0L; 8.5mm High Performance Wire	10011
1982	8 Cyl. 5.8L; Windsor Eng.; 8.5mm High Performance Wire	10011
1982	8 Cyl. 5.8L; Windsor Eng.; 8.5mm High Performance Wire; Equipped with Ceramic Spark Plug Boots	10047
1981-1980	8 Cyl. 5.8L; Windsor Eng.; 8.5mm High Performance Wire	10019
1981-1980	8 Cyl. 5.8L; Windsor Eng.; 8.5mm High Performance Wire; Equipped with Ceramic Spark Plug Boots	10083
1981-1980	8 Cyl. 5.8L; Windsor Eng.; 9.0mm High Performance Wire	10123

Year	Model/Engine	Part No.
Spark Plug Wire Set		
F-150		
1976-1975	8 Cyl. 5.0L; 8.5mm High Performance Wire; Equipped with Ceramic Spark Plug Boots	10059
1976-1975	8 Cyl. 6.4L; 8.5mm High Performance Wire; Equipped with Ceramic Spark Plug Boots	10059
1976-1975	8 Cyl. 7.5L; 8.5mm High Performance Wire	10008
1976-1975	8 Cyl. 7.5L; 8.5mm High Performance Wire; Equipped with Ceramic Spark Plug Boots	10059
1976-1975	8 Cyl. 5.9L; 8.5mm High Performance Wire	10008
1976-1975	8 Cyl. 5.9L; 8.5mm High Performance Wire; Equipped with Ceramic Spark Plug Boots	10059
1976-1975	8 Cyl. 6.4L; 8.5mm High Performance Wire	10008
1976-1975	8 Cyl. 5.0L; 8.5mm High Performance Wire	10008
F-250		
1997-1995	8 Cyl. 7.5L; 8.5mm High Performance Wire; Equipped with Ceramic Spark Plug Boots	10083
1997-1995	8 Cyl. 7.5L; 8.5mm High Performance Wire	10019
1997-1995	8 Cyl. 5.8L; 8.5mm High Performance Wire	10019
1997-1995	8 Cyl. 5.8L; 8.5mm High Performance Wire; Equipped with Ceramic Spark Plug Boots	10083
1997-1995	8 Cyl. 5.8L; 9.0mm High Performance Wire	10123
1997-1995	8 Cyl. 7.5L; 9.0mm High Performance Wire	10123
1996-1995	6 Cyl. 4.9L; 8.5mm High Performance Wire; Equipped with Ceramic Spark Plug Boots	10045
1996-1995	6 Cyl. 4.9L; 8.5mm High Performance Wire	10044
1994-1989	8 Cyl. 7.5L; 8.5mm High Performance Wire	10019
1994-1989	8 Cyl. 7.5L; 8.5mm High Performance Wire; Equipped with Ceramic Spark Plug Boots	10083
1994-1989	8 Cyl. 7.5L; 9.0mm High Performance Wire	10123
1994-1983	8 Cyl. 5.8L; 8.5mm High Performance Wire	10019
1994-1983	8 Cyl. 5.8L; 8.5mm High Performance Wire; Equipped with Ceramic Spark Plug Boots	10083
1994-1982	8 Cyl. 5.8L; 9.0mm High Performance Wire	10123
1994-1977	6 Cyl. 4.9L; 8.5mm High Performance Wire	10044
1994-1977	6 Cyl. 4.9L; 8.5mm High Performance Wire; Equipped with Ceramic Spark Plug Boots	10045
1993	8 Cyl. 5.0L; 8.5mm High Performance Wire	10019
1993	8 Cyl. 5.0L; 8.5mm High Performance Wire; Equipped with Ceramic Spark Plug Boots	10083
1993	8 Cyl. 5.0L; 9.0mm High Performance Wire	10123
1992-1988	8 Cyl. 5.0L; 8.5mm High Performance Wire; w/o EEC IV	10011

Wire Sets

Year	Model/Engine	Part No.
Spark Plug Wire Set		
F-250		
1992-1988	8 Cyl. 5.0L; 8.5mm High Performance Wire; Equipped with Ceramic Spark Plug Boots; w/o EEC IV	10047
1992-1988	8 Cyl. 5.0L; 8.5mm High Performance Wire; Equipped with Ceramic Spark Plug Boots; w/ EEC IV	10083
1992-1988	8 Cyl. 5.0L; 8.5mm High Performance Wire; w/ EEC IV	10019
1992-1988	8 Cyl. 5.0L; 9.0mm High Performance Wire; w/ EEC IV	10123
1987-1981	8 Cyl. 5.0L; 8.5mm High Performance Wire	10011
1987-1981	8 Cyl. 5.0L; 8.5mm High Performance Wire; Equipped with Ceramic Spark Plug Boots	10047
1982	8 Cyl. 5.8L; Windsor Eng.; 8.5mm High Performance Wire	10011
1982	8 Cyl. 5.8L; Windsor Eng.; 8.5mm High Performance Wire; Equipped with Ceramic Spark Plug Boots	10047
1981-1980	8 Cyl. 5.8L; Windsor Eng.; 8.5mm High Performance Wire	10019
1981-1980	8 Cyl. 5.8L; Windsor Eng.; 8.5mm High Performance Wire; Equipped with Ceramic Spark Plug Boots	10083
1981-1980	8 Cyl. 5.8L; Windsor Eng.; 9.0mm High Performance Wire	10123
1976-1975	8 Cyl. 5.0L; 8.5mm High Performance Wire; Equipped with Ceramic Spark Plug Boots	10059
1976-1975	8 Cyl. 5.0L; 8.5mm High Performance Wire	10008
1976-1975	8 Cyl. 5.9L; 8.5mm High Performance Wire	10008
1976-1975	8 Cyl. 5.9L; 8.5mm High Performance Wire; Equipped with Ceramic Spark Plug Boots	10059
1976-1975	8 Cyl. 7.5L; 8.5mm High Performance Wire; Equipped with Ceramic Spark Plug Boots	10059
1976-1975	8 Cyl. 6.4L; 8.5mm High Performance Wire	10008
1976-1975	8 Cyl. 6.4L; 8.5mm High Performance Wire; Equipped with Ceramic Spark Plug Boots	10059
1976-1975	8 Cyl. 7.5L; 8.5mm High Performance Wire	10008
F-250 Pickup		
1974-1973	8 Cyl. 7.5L; 8.5mm High Performance Wire; Equipped with Ceramic Spark Plug Boots	10059
1974-1973	8 Cyl. 7.5L; 8.5mm High Performance Wire	10008
1974-1968	8 Cyl. 6.4L; 8.5mm High Performance Wire	10008
1974-1968	8 Cyl. 5.9L; 8.5mm High Performance Wire; Equipped with Ceramic Spark Plug Boots	10059
1974-1968	8 Cyl. 6.4L; 8.5mm High Performance Wire; Equipped with Ceramic Spark Plug Boots	10059
1974-1968	8 Cyl. 5.9L; 8.5mm High Performance Wire	10008
1973-1972	8 Cyl. 5.0L; 8.5mm High Performance Wire	10008
1973-1972	8 Cyl. 5.0L; 8.5mm High Performance Wire; Equipped with Ceramic Spark Plug Boots	10059
1967-1965	8 Cyl. 5.8L; 8.5mm High Performance Wire	10008

Year	Model/Engine	Part No.
Spark Plug Wire Set		
F-250 Pickup		
1967-1965	8 Cyl. 5.8L; 8.5mm High Performance Wire; Equipped with Ceramic Spark Plug Boots	10059
1960	8 Cyl. 5.4L; 8.5mm High Performance Wire; Equipped with Ceramic Spark Plug Boots	10059
1960	8 Cyl. 4.8L; 8.5mm High Performance Wire	10008
1960	8 Cyl. 5.4L; 8.5mm High Performance Wire	10008
1960	8 Cyl. 4.8L; 8.5mm High Performance Wire; Equipped with Ceramic Spark Plug Boots	10059
1958	8 Cyl. 5.8L; 8.5mm High Performance Wire	10008
1958	8 Cyl. 5.8L; 8.5mm High Performance Wire; Equipped with Ceramic Spark Plug Boots	10059
1958	8 Cyl. 4.8L; 8.5mm High Performance Wire	10008
1958	8 Cyl. 4.8L; 8.5mm High Performance Wire; Equipped with Ceramic Spark Plug Boots	10059
1955	8 Cyl. 3.9L; 8.5mm High Performance Wire	10008
1955	8 Cyl. 3.9L; 8.5mm High Performance Wire; Equipped with Ceramic Spark Plug Boots	10059
F-350		
1997-1995	8 Cyl. 5.8L; 8.5mm High Performance Wire	10019
1997-1995	8 Cyl. 7.5L; 8.5mm High Performance Wire; Equipped with Ceramic Spark Plug Boots	10083
1997-1995	8 Cyl. 5.8L; 8.5mm High Performance Wire; Equipped with Ceramic Spark Plug Boots	10083
1997-1995	8 Cyl. 7.5L; 8.5mm High Performance Wire	10019
1997-1995	8 Cyl. 5.8L; 9.0mm High Performance Wire	10123
1997-1995	8 Cyl. 7.5L; 9.0mm High Performance Wire	10123
1996-1995	6 Cyl. 4.9L; 8.5mm High Performance Wire; Equipped with Ceramic Spark Plug Boots	10045
1996-1995	6 Cyl. 4.9L; 8.5mm High Performance Wire	10044
1994-1989	8 Cyl. 7.5L; 8.5mm High Performance Wire; Equipped with Ceramic Spark Plug Boots	10083
1994-1989	8 Cyl. 7.5L; 8.5mm High Performance Wire	10019
1994-1989	8 Cyl. 7.5L; 9.0mm High Performance Wire	10123
1994-1983	8 Cyl. 5.8L; 8.5mm High Performance Wire; Equipped with Ceramic Spark Plug Boots	10083
1994-1983	8 Cyl. 5.8L; 8.5mm High Performance Wire	10019
1994-1982	8 Cyl. 5.8L; 9.0mm High Performance Wire	10123
1994-1977	6 Cyl. 4.9L; 8.5mm High Performance Wire; Equipped with Ceramic Spark Plug Boots	10045
1994-1977	6 Cyl. 4.9L; 8.5mm High Performance Wire	10044
1982	8 Cyl. 5.8L; Windsor Eng.; 8.5mm High Performance Wire	10011

Ford

Wire Sets

Year	Model/Engine	Part No.
Spark Plug Wire Set		
F-350		
1982	8 Cyl. 5.8L; Windsor Eng.; 8.5mm High Performance Wire; Equipped with Ceramic Spark Plug Boots	10047
1981-1980	8 Cyl. 5.8L; Windsor Eng.; 8.5mm High Performance Wire	10019
1981-1980	8 Cyl. 5.8L; Windsor Eng.; 8.5mm High Performance Wire; Equipped with Ceramic Spark Plug Boots	10083
1981-1980	8 Cyl. 5.8L; Windsor Eng.; 9.0mm High Performance Wire	10123
1976-1975	8 Cyl. 5.0L; 8.5mm High Performance Wire; Equipped with Ceramic Spark Plug Boots	10059
1976-1975	8 Cyl. 6.4L; 8.5mm High Performance Wire; Equipped with Ceramic Spark Plug Boots	10059
1976-1975	8 Cyl. 5.9L; 8.5mm High Performance Wire; Equipped with Ceramic Spark Plug Boots	10059
1976-1975	8 Cyl. 6.4L; 8.5mm High Performance Wire	10008
1976-1975	8 Cyl. 7.5L; 8.5mm High Performance Wire	10008
1976-1975	8 Cyl. 7.5L; 8.5mm High Performance Wire; Equipped with Ceramic Spark Plug Boots	10059
1976-1975	8 Cyl. 5.9L; 8.5mm High Performance Wire	10008
1976-1975	8 Cyl. 5.0L; 8.5mm High Performance Wire	10008
F-350 Pickup		
1974-1973	8 Cyl. 7.5L; 8.5mm High Performance Wire	10008
1974-1973	8 Cyl. 7.5L; 8.5mm High Performance Wire; Equipped with Ceramic Spark Plug Boots	10059
1974-1968	8 Cyl. 6.4L; 8.5mm High Performance Wire	10008
1974-1968	8 Cyl. 6.4L; 8.5mm High Performance Wire; Equipped with Ceramic Spark Plug Boots	10059
1974-1968	8 Cyl. 5.9L; 8.5mm High Performance Wire; Equipped with Ceramic Spark Plug Boots	10059
1974-1968	8 Cyl. 5.9L; 8.5mm High Performance Wire	10008
1973-1972	8 Cyl. 5.0L; 8.5mm High Performance Wire	10008
1973-1972	8 Cyl. 5.0L; 8.5mm High Performance Wire; Equipped with Ceramic Spark Plug Boots	10059
1967-1965	8 Cyl. 5.8L; 8.5mm High Performance Wire	10008
1967-1965	8 Cyl. 5.8L; 8.5mm High Performance Wire; Equipped with Ceramic Spark Plug Boots	10059
1966-1965	8 Cyl. 5.9L; 8.5mm High Performance Wire; Equipped with Ceramic Spark Plug Boots	10059
1966-1965	8 Cyl. 5.9L; 8.5mm High Performance Wire	10008
1964	8 Cyl. 5.9L; 8.5mm High Performance Wire	10008
1964	8 Cyl. 5.9L; 8.5mm High Performance Wire; Equipped with Ceramic Spark Plug Boots	10059
1960	8 Cyl. 4.8L; 8.5mm High Performance Wire; Equipped with Ceramic Spark Plug Boots	10059

Year	Model/Engine	Part No.
Spark Plug Wire Set		
F-350 Pickup		
1960	8 Cyl. 4.8L; 8.5mm High Performance Wire	10008
1960	8 Cyl. 5.4L; 8.5mm High Performance Wire	10008
1960	8 Cyl. 5.4L; 8.5mm High Performance Wire; Equipped with Ceramic Spark Plug Boots	10059
1958	8 Cyl. 5.8L; 8.5mm High Performance Wire	10008
1958	8 Cyl. 5.8L; 8.5mm High Performance Wire; Equipped with Ceramic Spark Plug Boots	10059
1958	8 Cyl. 4.8L; 8.5mm High Performance Wire; Equipped with Ceramic Spark Plug Boots	10059
1958	8 Cyl. 4.8L; 8.5mm High Performance Wire	10008
1955	8 Cyl. 3.9L; 8.5mm High Performance Wire	10008
1955	8 Cyl. 3.9L; 8.5mm High Performance Wire; Equipped with Ceramic Spark Plug Boots	10059
F-450		
1997	8 Cyl. 7.5L; 8.5mm High Performance Wire; Equipped with Ceramic Spark Plug Boots	10083
1997	8 Cyl. 7.5L; 8.5mm High Performance Wire	10019
1997	8 Cyl. 7.5L; 9.0mm High Performance Wire	10123
F-500		
1977-1975	8 Cyl. 6.4L; 8.5mm High Performance Wire	10008
1977-1975	8 Cyl. 5.9L; 8.5mm High Performance Wire; Equipped with Ceramic Spark Plug Boots	10059
1977-1975	8 Cyl. 6.4L; 8.5mm High Performance Wire; Equipped with Ceramic Spark Plug Boots	10059
1977-1975	8 Cyl. 5.4L; 8.5mm High Performance Wire	10008
1977-1975	8 Cyl. 5.9L; 8.5mm High Performance Wire	10008
1977-1975	8 Cyl. 5.4L; 8.5mm High Performance Wire; Equipped with Ceramic Spark Plug Boots	10059
F Series		
1958	8 Cyl. 4.8L; 8.5mm High Performance Wire	10008
1958	8 Cyl. 5.8L; 8.5mm High Performance Wire	10008
1958	8 Cyl. 5.8L; 8.5mm High Performance Wire; Equipped with Ceramic Spark Plug Boots	10059
1958	8 Cyl. 4.8L; 8.5mm High Performance Wire; Equipped with Ceramic Spark Plug Boots	10059
Fairlane		
1970	8 Cyl. 5.8L; 8.5mm High Performance Wire	10008
1970	8 Cyl. 5.8L; 8.5mm High Performance Wire; Equipped with Ceramic Spark Plug Boots	10059
1970-1969	8 Cyl. 5.0L; 8.5mm High Performance Wire	10008
1970-1969	8 Cyl. 5.0L; 8.5mm High Performance Wire; Equipped with Ceramic Spark Plug Boots	10059

Wire Sets

Year	Model/Engine	Part No.
Spark Plug Wire Set		
Fairlane		
1970-1967	8 Cyl. 6.4L; 8.5mm High Performance Wire	10008
1970-1967	8 Cyl. 6.4L; 8.5mm High Performance Wire; Equipped with Ceramic Spark Plug Boots	10059
1969-1967	8 Cyl. 7.0L; 8.5mm High Performance Wire	10008
1969-1967	8 Cyl. 7.0L; 8.5mm High Performance Wire; Equipped with Ceramic Spark Plug Boots	10059
1968	8 Cyl. 5.0L; 8.5mm High Performance Wire; w/ Improved Combustion Emission	10008
1968	8 Cyl. 5.0L; 8.5mm High Performance Wire; Equipped with Ceramic Spark Plug Boots; w/ Improved Combustion Emission	10059
1968-1967	8 Cyl. 4.7L; 8.5mm High Performance Wire	10008
1968-1967	8 Cyl. 4.7L; 8.5mm High Performance Wire; Equipped with Ceramic Spark Plug Boots	10059
1966-1964	8 Cyl. 7.0L; 8.5mm High Performance Wire	10008
1966-1964	8 Cyl. 7.0L; 8.5mm High Performance Wire; Equipped with Ceramic Spark Plug Boots	10059
1966-1963	8 Cyl. 4.7L; 8.5mm High Performance Wire; Equipped with Ceramic Spark Plug Boots	10059
1966-1963	8 Cyl. 4.7L; 8.5mm High Performance Wire	10008
1966-1961	8 Cyl. 6.4L; 8.5mm High Performance Wire; Equipped with Ceramic Spark Plug Boots	10059
1966-1961	8 Cyl. 6.4L; 8.5mm High Performance Wire	10008
1966-1958	8 Cyl. 5.8L; 8.5mm High Performance Wire; Equipped with Ceramic Spark Plug Boots	10059
1966-1958	8 Cyl. 5.8L; 8.5mm High Performance Wire	10008
1964-1962	8 Cyl. 4.3L; 8.5mm High Performance Wire; Equipped with Ceramic Spark Plug Boots	10059
1964-1962	8 Cyl. 4.3L; 8.5mm High Performance Wire	10008
1963-1962	8 Cyl. 3.6L; 8.5mm High Performance Wire	10008
1963-1962	8 Cyl. 3.6L; 8.5mm High Performance Wire; Equipped with Ceramic Spark Plug Boots	10059
1962-1957	8 Cyl. 4.8L; 8.5mm High Performance Wire; Equipped with Ceramic Spark Plug Boots	10059
1962-1957	8 Cyl. 4.8L; 8.5mm High Performance Wire	10008
1959-1958	8 Cyl. 5.4L; 8.5mm High Performance Wire	10008
1959-1958	8 Cyl. 5.4L; 8.5mm High Performance Wire; Equipped with Ceramic Spark Plug Boots	10059
1957	8 Cyl. 4.5L; 8.5mm High Performance Wire; Equipped with Ceramic Spark Plug Boots	10059
1957	8 Cyl. 5.1L; 8.5mm High Performance Wire; Equipped with Ceramic Spark Plug Boots	10059
1957	8 Cyl. 4.5L; 8.5mm High Performance Wire	10008
1957	8 Cyl. 5.1L; 8.5mm High Performance Wire	10008

Year	Model/Engine	Part No.
Spark Plug Wire Set		
Fairmont		
1982	8 Cyl. 4.2L; 8.5mm High Performance Wire; Equipped with Ceramic Spark Plug Boots	10047
1982	8 Cyl. 4.2L; 8.5mm High Performance Wire	10011
1981	8 Cyl. 4.2L; 8.5mm High Performance Wire; Equipped with Ceramic Spark Plug Boots	10047
1981	8 Cyl. 4.2L; 8.5mm High Performance Wire	10011
Falcon		
1970	8 Cyl. 5.8L; 8.5mm High Performance Wire; Equipped with Ceramic Spark Plug Boots	10059
1970	8 Cyl. 5.8L; 8.5mm High Performance Wire	10008
1970-1969	8 Cyl. 5.0L; 8.5mm High Performance Wire; Equipped with Ceramic Spark Plug Boots	10059
1970-1969	8 Cyl. 5.0L; 8.5mm High Performance Wire	10008
1968	8 Cyl. 4.7L; 8.5mm High Performance Wire; Equipped with Ceramic Spark Plug Boots	10059
1968	8 Cyl. 5.0L; 8.5mm High Performance Wire; w/ Improved Combustion Emission	10008
1968	8 Cyl. 5.0L; 8.5mm High Performance Wire; Equipped with Ceramic Spark Plug Boots; w/ Improved Combustion Emission	10059
1968	8 Cyl. 4.7L; 8.5mm High Performance Wire	10008
1967-1964	8 Cyl. 4.7L; 8.5mm High Performance Wire; Equipped with Ceramic Spark Plug Boots	10059
1967-1964	8 Cyl. 4.7L; 8.5mm High Performance Wire	10008
1964-1963	8 Cyl. 4.3L; 8.5mm High Performance Wire; Equipped with Ceramic Spark Plug Boots	10059
1964-1963	8 Cyl. 4.3L; 8.5mm High Performance Wire	10008
Falcon Sedan Delivery		
1965-1964	8 Cyl. 4.7L; 8.5mm High Performance Wire	10008
1965-1964	8 Cyl. 4.7L; 8.5mm High Performance Wire; Equipped with Ceramic Spark Plug Boots	10059
1964-1963	8 Cyl. 4.3L; 8.5mm High Performance Wire	10008
1964-1963	8 Cyl. 4.3L; 8.5mm High Performance Wire; Equipped with Ceramic Spark Plug Boots	10059
Focus		
2004-2002	4 Cyl. 2.0L; 5; 8.5mm High Performance Wire; DOHC	10029
2004-2000	4 Cyl. 2.0L; 3; 8.5mm High Performance Wire; DOHC	10029
Ford 300		
1963	8 Cyl. 4.3L; 8.5mm High Performance Wire; Equipped with Ceramic Spark Plug Boots	10059
1963	8 Cyl. 5.8L; 8.5mm High Performance Wire; Equipped with Ceramic Spark Plug Boots	10059
1963	8 Cyl. 5.8L; 8.5mm High Performance Wire	10008
1963	8 Cyl. 4.3L; 8.5mm High Performance Wire	10008

Ford

Wire Sets

Year	Model/Engine	Part No.
Spark Plug Wire Set		
Ford 300		
1963	8 Cyl. 4.7L; 8.5mm High Performance Wire	10008
1963	8 Cyl. 4.7L; 8.5mm High Performance Wire; Equipped with Ceramic Spark Plug Boots	10059
Galaxie		
1967-1965	8 Cyl. 7.0L; 8.5mm High Performance Wire	10008
1967-1965	8 Cyl. 7.0L; 8.5mm High Performance Wire; Equipped with Ceramic Spark Plug Boots	10059
1967-1963	8 Cyl. 4.7L; 8.5mm High Performance Wire	10008
1967-1963	8 Cyl. 4.7L; 8.5mm High Performance Wire; Equipped with Ceramic Spark Plug Boots	10059
1967-1961	8 Cyl. 6.4L; 8.5mm High Performance Wire	10008
1967-1961	8 Cyl. 6.4L; 8.5mm High Performance Wire; Equipped with Ceramic Spark Plug Boots	10059
1966-1959	8 Cyl. 5.8L; 8.5mm High Performance Wire	10008
1966-1959	8 Cyl. 5.8L; 8.5mm High Performance Wire; Equipped with Ceramic Spark Plug Boots	10059
1964-1963	8 Cyl. 4.3L; 8.5mm High Performance Wire; Equipped with Ceramic Spark Plug Boots	10059
1964-1963	8 Cyl. 4.3L; 8.5mm High Performance Wire	10008
1962-1959	8 Cyl. 4.8L; 8.5mm High Performance Wire; Equipped with Ceramic Spark Plug Boots	10059
1962-1959	8 Cyl. 4.8L; 8.5mm High Performance Wire	10008
1959	8 Cyl. 5.4L; 8.5mm High Performance Wire	10008
1959	8 Cyl. 5.4L; 8.5mm High Performance Wire; Equipped with Ceramic Spark Plug Boots	10059
Galaxie 500		
1974-1973	8 Cyl. 7.5L; 8.5mm High Performance Wire; Equipped with Ceramic Spark Plug Boots	10059
1974-1973	8 Cyl. 7.5L; 8.5mm High Performance Wire	10008
1974-1971	8 Cyl. 6.6L; 8.5mm High Performance Wire	10008
1974-1971	8 Cyl. 6.6L; 8.5mm High Performance Wire; Equipped with Ceramic Spark Plug Boots	10059
1973-1971	8 Cyl. 7.0L; 8.5mm High Performance Wire	10008
1973-1971	8 Cyl. 7.0L; 8.5mm High Performance Wire; Equipped with Ceramic Spark Plug Boots	10059
1973-1970	8 Cyl. 5.8L; 8.5mm High Performance Wire	10008
1973-1970	8 Cyl. 5.8L; 8.5mm High Performance Wire; Equipped with Ceramic Spark Plug Boots	10059
1972-1969	8 Cyl. 5.0L; 8.5mm High Performance Wire; Equipped with Ceramic Spark Plug Boots	10059
1972-1969	8 Cyl. 5.0L; 8.5mm High Performance Wire	10008
1971-1968	8 Cyl. 6.4L; 8.5mm High Performance Wire; Equipped with Ceramic Spark Plug Boots	10059

Year	Model/Engine	Part No.
Spark Plug Wire Set		
Galaxie 500		
1971-1968	8 Cyl. 6.4L; 8.5mm High Performance Wire	10008
1969-1968	8 Cyl. 7.0L; 8.5mm High Performance Wire	10008
1969-1968	8 Cyl. 7.0L; 8.5mm High Performance Wire; Equipped with Ceramic Spark Plug Boots	10059
1968	8 Cyl. 5.0L; 8.5mm High Performance Wire; w/ Improved Combustion Emission	10008
1968	8 Cyl. 5.0L; 8.5mm High Performance Wire; Equipped with Ceramic Spark Plug Boots; w/ Improved Combustion Emission	10059
1967-1965	8 Cyl. 7.0L; 8.5mm High Performance Wire; Equipped with Ceramic Spark Plug Boots	10059
1967-1965	8 Cyl. 7.0L; 8.5mm High Performance Wire	10008
1967-1963	8 Cyl. 4.7L; 8.5mm High Performance Wire; Equipped with Ceramic Spark Plug Boots	10059
1967-1963	8 Cyl. 4.7L; 8.5mm High Performance Wire	10008
1967-1962	8 Cyl. 6.4L; 8.5mm High Performance Wire	10008
1967-1962	8 Cyl. 6.4L; 8.5mm High Performance Wire; Equipped with Ceramic Spark Plug Boots	10059
1966-1962	8 Cyl. 5.8L; 8.5mm High Performance Wire; Equipped with Ceramic Spark Plug Boots	10059
1966-1962	8 Cyl. 5.8L; 8.5mm High Performance Wire	10008
1964-1963	8 Cyl. 4.3L; 8.5mm High Performance Wire	10008
1964-1963	8 Cyl. 4.3L; 8.5mm High Performance Wire; Equipped with Ceramic Spark Plug Boots	10059
1963-1962	8 Cyl. 6.7L; 8.5mm High Performance Wire; Equipped with Ceramic Spark Plug Boots	10059
1963-1962	8 Cyl. 6.7L; 8.5mm High Performance Wire	10008
1962	8 Cyl. 4.8L; 8.5mm High Performance Wire; Equipped with Ceramic Spark Plug Boots	10059
1962	8 Cyl. 4.8L; 8.5mm High Performance Wire	10008
Gran Torino		
1976-1975	8 Cyl. 5.8L; Modified Eng.; 8.5mm High Performance Wire; Equipped with Ceramic Spark Plug Boots	10059
1976-1975	8 Cyl. 5.8L; Windsor Eng.; 8.5mm High Performance Wire; Equipped with Ceramic Spark Plug Boots	10059
1976-1975	8 Cyl. 5.8L; Windsor Eng.; 8.5mm High Performance Wire	10008
1976-1975	8 Cyl. 5.8L; Modified Eng.; 8.5mm High Performance Wire	10008
1976-1974	8 Cyl. 7.5L; 8.5mm High Performance Wire	10008
1976-1974	8 Cyl. 7.5L; 8.5mm High Performance Wire; Equipped with Ceramic Spark Plug Boots	10059
1976-1972	8 Cyl. 6.6L; 8.5mm High Performance Wire	10008
1976-1972	8 Cyl. 6.6L; 8.5mm High Performance Wire; Equipped with Ceramic Spark Plug Boots	10059
1974-1972	8 Cyl. 5.8L; 8.5mm High Performance Wire	10008

Wire Sets

Year	Model/Engine	Part No.
Spark Plug Wire Set		
Gran Torino		
1974-1972	8 Cyl. 5.0L; 8.5mm High Performance Wire	10008
1974-1972	8 Cyl. 5.0L; 8.5mm High Performance Wire; Equipped with Ceramic Spark Plug Boots	10059
1974-1972	8 Cyl. 5.8L; 8.5mm High Performance Wire; Equipped with Ceramic Spark Plug Boots	10059
1973-1972	8 Cyl. 7.0L; 8.5mm High Performance Wire; Equipped with Ceramic Spark Plug Boots	10059
1973-1972	8 Cyl. 7.0L; 8.5mm High Performance Wire	10008
GT40		
1969-1966	8 Cyl. 4.7L; 8.5mm High Performance Wire; Equipped with Ceramic Spark Plug Boots	10059
1969-1966	8 Cyl. 4.7L; 8.5mm High Performance Wire	10008
LTD		
1986	8 Cyl. 5.0L; 8.5mm High Performance Wire; Equipped with Ceramic Spark Plug Boots	10047
1986	8 Cyl. 5.0L; 8.5mm High Performance Wire	10011
1986-1984	8 Cyl. 5.8L; 8.5mm High Performance Wire	10019
1986-1984	8 Cyl. 5.8L; 8.5mm High Performance Wire; Equipped with Ceramic Spark Plug Boots	10083
1986-1984	8 Cyl. 5.8L; 9.0mm High Performance Wire	10123
1985-1984	8 Cyl. 5.0L; 8.5mm High Performance Wire; Carb.	10019
1985-1984	8 Cyl. 5.0L; 8.5mm High Performance Wire; Equipped with Ceramic Spark Plug Boots; FI	10047
1985-1984	8 Cyl. 5.0L; 8.5mm High Performance Wire; Carb.; Equipped with Ceramic Spark Plug Boots	10083
1985-1984	8 Cyl. 5.0L; 8.5mm High Performance Wire; FI	10011
1985-1984	8 Cyl. 5.0L; 9.0mm High Performance Wire; Carb.	10123
1983-1981	8 Cyl. 5.0L; 8.5mm High Performance Wire; Equipped with Ceramic Spark Plug Boots	10047
1983-1981	8 Cyl. 5.0L; 8.5mm High Performance Wire	10011
1983-1981	8 Cyl. 5.8L; 8.5mm High Performance Wire	10011
1983-1981	8 Cyl. 5.8L; 8.5mm High Performance Wire; Equipped with Ceramic Spark Plug Boots	10047
1982-1981	8 Cyl. 4.2L; 8.5mm High Performance Wire	10011
1982-1981	8 Cyl. 4.2L; 8.5mm High Performance Wire; Equipped with Ceramic Spark Plug Boots	10047
1976-1975	8 Cyl. 5.8L; Windsor Eng.; 8.5mm High Performance Wire	10008
1976-1975	8 Cyl. 5.8L; Windsor Eng.; 8.5mm High Performance Wire; Equipped with Ceramic Spark Plug Boots	10059
1976-1975	8 Cyl. 5.8L; Modified Eng.; 8.5mm High Performance Wire; Equipped with Ceramic Spark Plug Boots	10059
1976-1975	8 Cyl. 5.8L; Modified Eng.; 8.5mm High Performance Wire	10008

Year	Model/Engine	Part No.
Spark Plug Wire Set		
LTD		
1976-1972	8 Cyl. 7.5L; 8.5mm High Performance Wire; Equipped with Ceramic Spark Plug Boots	10059
1976-1972	8 Cyl. 7.5L; 8.5mm High Performance Wire	10008
1976-1971	8 Cyl. 6.6L; 8.5mm High Performance Wire; Equipped with Ceramic Spark Plug Boots	10059
1976-1971	8 Cyl. 6.6L; 8.5mm High Performance Wire	10008
1973-1971	8 Cyl. 7.0L; 8.5mm High Performance Wire	10008
1973-1971	8 Cyl. 7.0L; 8.5mm High Performance Wire; Equipped with Ceramic Spark Plug Boots	10059
1973-1970	8 Cyl. 5.8L; 8.5mm High Performance Wire	10008
1973-1970	8 Cyl. 5.8L; 8.5mm High Performance Wire; Equipped with Ceramic Spark Plug Boots	10059
1972-1969	8 Cyl. 5.0L; 8.5mm High Performance Wire	10008
1972-1969	8 Cyl. 5.0L; 8.5mm High Performance Wire; Equipped with Ceramic Spark Plug Boots	10059
1971-1968	8 Cyl. 6.4L; 8.5mm High Performance Wire; Equipped with Ceramic Spark Plug Boots	10059
1971-1968	8 Cyl. 6.4L; 8.5mm High Performance Wire	10008
1969-1968	8 Cyl. 7.0L; 8.5mm High Performance Wire	10008
1969-1968	8 Cyl. 7.0L; 8.5mm High Performance Wire; Equipped with Ceramic Spark Plug Boots	10059
1968	8 Cyl. 5.0L; 8.5mm High Performance Wire; Equipped with Ceramic Spark Plug Boots; w/ Improved Combustion Emission	10059
1968	8 Cyl. 4.7L; 8.5mm High Performance Wire	10008
1968	8 Cyl. 4.7L; 8.5mm High Performance Wire; Equipped with Ceramic Spark Plug Boots	10059
1968	8 Cyl. 5.0L; 8.5mm High Performance Wire; w/ Improved Combustion Emission	10008
1967-1965	8 Cyl. 4.7L; 8.5mm High Performance Wire	10008
1967-1965	8 Cyl. 7.0L; 8.5mm High Performance Wire	10008
1967-1965	8 Cyl. 7.0L; 8.5mm High Performance Wire; Equipped with Ceramic Spark Plug Boots	10059
1967-1965	8 Cyl. 6.4L; 8.5mm High Performance Wire	10008
1967-1965	8 Cyl. 6.4L; 8.5mm High Performance Wire; Equipped with Ceramic Spark Plug Boots	10059
1967-1965	8 Cyl. 4.7L; 8.5mm High Performance Wire; Equipped with Ceramic Spark Plug Boots	10059
1966-1965	8 Cyl. 5.8L; 8.5mm High Performance Wire; Equipped with Ceramic Spark Plug Boots	10059
1966-1965	8 Cyl. 5.8L; 8.5mm High Performance Wire	10008
LTD Crown Victoria		
1991-1987	8 Cyl. 5.8L; 8.5mm High Performance Wire; Equipped with Ceramic Spark Plug Boots	10083

Wire Sets

Year	Model/Engine	Part No.
Spark Plug Wire Set		
LTD Crown Victoria		
1991-1987	8 Cyl. 5.0L; 8.5mm High Performance Wire	10011
1991-1987	8 Cyl. 5.8L; 8.5mm High Performance Wire	10019
1991-1987	8 Cyl. 5.0L; 8.5mm High Performance Wire; Equipped with Ceramic Spark Plug Boots	10047
1991-1987	8 Cyl. 5.8L; 9.0mm High Performance Wire	10123
Maverick		
1976-1974	8 Cyl. 5.0L; 8.5mm High Performance Wire	10008
1976-1974	8 Cyl. 5.0L; 8.5mm High Performance Wire; Equipped with Ceramic Spark Plug Boots	10059
1972-1971	8 Cyl. 5.0L; 8.5mm High Performance Wire	10008
1972-1971	8 Cyl. 5.0L; 8.5mm High Performance Wire; Equipped with Ceramic Spark Plug Boots	10059
Mustang		
1998-1996	8 Cyl. 4.6L; GT; 9.0mm High Performance Wire; SOHC	10040
1998-1996	8 Cyl. 4.6L; SVT Cobra; 8.5mm High Performance Wire; DOHC	10027
1998-1996	8 Cyl. 4.6L; GT; 8.5mm High Performance Wire; SOHC	10028
1993-1991	4 Cyl. 2.3L; 8.5mm High Performance Wire; Dual Plug Engine	10054
1993-1991	4 Cyl. 2.3L; 8.5mm High Performance Wire; Dual Plug Engine; Equipped with Ceramic Spark Plug Boots	10055
1993-1986	8 Cyl. 5.0L; 8.5mm High Performance Wire; Equipped with Ceramic Spark Plug Boots	10083
1993-1986	8 Cyl. 5.0L; 8.5mm High Performance Wire	10019
1993-1986	8 Cyl. 5.0L; 9.0mm High Performance Wire	10123
1985	8 Cyl. 5.0L; 8.5mm High Performance Wire; Equipped with Ceramic Spark Plug Boots; w/o EEC IV	10047
1985	8 Cyl. 5.0L; 8.5mm High Performance Wire; w/ EEC IV	10019
1985	8 Cyl. 5.0L; 8.5mm High Performance Wire; Equipped with Ceramic Spark Plug Boots; w/ EEC IV	10083
1985	8 Cyl. 5.0L; 8.5mm High Performance Wire; w/o EEC IV	10011
1985	8 Cyl. 5.0L; 9.0mm High Performance Wire; w/ EEC IV	10123
1984	8 Cyl. 5.0L; 8.5mm High Performance Wire; Equipped with Ceramic Spark Plug Boots	10083
1984	8 Cyl. 5.0L; 8.5mm High Performance Wire	10019
1984	8 Cyl. 5.0L; 9.0mm High Performance Wire	10123
1983-1982	8 Cyl. 5.0L; 8.5mm High Performance Wire	10011
1983-1982	8 Cyl. 5.0L; 8.5mm High Performance Wire; Equipped with Ceramic Spark Plug Boots	10047
1982-1981	8 Cyl. 4.2L; 8.5mm High Performance Wire	10011
1982-1981	8 Cyl. 4.2L; 8.5mm High Performance Wire; Equipped with Ceramic Spark Plug Boots	10047
1973-1970	8 Cyl. 5.8L; 8.5mm High Performance Wire	10008

Year	Model/Engine	Part No.
Spark Plug Wire Set		
Mustang		
1973-1970	8 Cyl. 5.8L; 8.5mm High Performance Wire; Equipped with Ceramic Spark Plug Boots	10059
1973-1969	8 Cyl. 5.0L; 8.5mm High Performance Wire	10008
1973-1969	8 Cyl. 5.0L; 8.5mm High Performance Wire; Equipped with Ceramic Spark Plug Boots	10059
1971-1968	8 Cyl. 7.0L; 8.5mm High Performance Wire	10008
1971-1968	8 Cyl. 7.0L; 8.5mm High Performance Wire; Equipped with Ceramic Spark Plug Boots	10059
1969-1968	8 Cyl. 6.4L; 8.5mm High Performance Wire; Equipped with Ceramic Spark Plug Boots	10059
1969-1968	8 Cyl. 6.4L; 8.5mm High Performance Wire	10008
1968	8 Cyl. 5.0L; 8.5mm High Performance Wire; Equipped with Ceramic Spark Plug Boots; w/ Improved Combustion Emission	10059
1968	8 Cyl. 4.7L; 8.5mm High Performance Wire	10008
1968	8 Cyl. 5.0L; 8.5mm High Performance Wire; w/ Improved Combustion Emission	10008
1968	8 Cyl. 4.7L; 8.5mm High Performance Wire; Equipped with Ceramic Spark Plug Boots	10059
1967	8 Cyl. 6.4L; 8.5mm High Performance Wire	10008
1967	8 Cyl. 6.4L; 8.5mm High Performance Wire; Equipped with Ceramic Spark Plug Boots	10059
1967-1964	8 Cyl. 4.7L; 8.5mm High Performance Wire; Equipped with Ceramic Spark Plug Boots	10059
1967-1964	8 Cyl. 4.7L; 8.5mm High Performance Wire	10008
1964	8 Cyl. 4.3L; 8.5mm High Performance Wire; Equipped with Ceramic Spark Plug Boots	10059
1964	8 Cyl. 4.3L; 8.5mm High Performance Wire	10008
Mustang II		
1976-1975	8 Cyl. 5.0L; 8.5mm High Performance Wire	10008
1976-1975	8 Cyl. 5.0L; 8.5mm High Performance Wire; Equipped with Ceramic Spark Plug Boots	10059
Ranch Wagon		
1974-1973	8 Cyl. 7.5L; 8.5mm High Performance Wire; Equipped with Ceramic Spark Plug Boots	10059
1974-1973	8 Cyl. 7.5L; 8.5mm High Performance Wire	10008
1974-1971	8 Cyl. 6.6L; 8.5mm High Performance Wire; Equipped with Ceramic Spark Plug Boots	10059
1974-1971	8 Cyl. 6.6L; 8.5mm High Performance Wire	10008
1973-1970	8 Cyl. 5.8L; 8.5mm High Performance Wire; Equipped with Ceramic Spark Plug Boots	10059
1973-1970	8 Cyl. 5.8L; 8.5mm High Performance Wire	10008
1973-1968	8 Cyl. 7.0L; 8.5mm High Performance Wire; Equipped with Ceramic Spark Plug Boots	10059
1973-1968	8 Cyl. 7.0L; 8.5mm High Performance Wire	10008

Wire Sets

Year	Model/Engine	Part No.
Spark Plug Wire Set		
Ranch Wagon		
1972-1969	8 Cyl. 5.0L; 8.5mm High Performance Wire	10008
1972-1969	8 Cyl. 5.0L; 8.5mm High Performance Wire; Equipped with Ceramic Spark Plug Boots	10059
1971-1968	8 Cyl. 6.4L; 8.5mm High Performance Wire; Equipped with Ceramic Spark Plug Boots	10059
1971-1968	8 Cyl. 6.4L; 8.5mm High Performance Wire	10008
1968	8 Cyl. 4.7L; 8.5mm High Performance Wire; Equipped with Ceramic Spark Plug Boots	10059
1968	8 Cyl. 5.0L; 8.5mm High Performance Wire; w/ Improved Combustion Emission	10008
1968	8 Cyl. 5.0L; 8.5mm High Performance Wire; Equipped with Ceramic Spark Plug Boots; w/ Improved Combustion Emission	10059
1968	8 Cyl. 4.7L; 8.5mm High Performance Wire	10008
1967-1964	8 Cyl. 7.0L; 8.5mm High Performance Wire	10008
1967-1964	8 Cyl. 7.0L; 8.5mm High Performance Wire; Equipped with Ceramic Spark Plug Boots	10059
1967-1963	8 Cyl. 4.7L; 8.5mm High Performance Wire	10008
1967-1963	8 Cyl. 4.7L; 8.5mm High Performance Wire; Equipped with Ceramic Spark Plug Boots	10059
1967-1961	8 Cyl. 6.4L; 8.5mm High Performance Wire	10008
1967-1961	8 Cyl. 6.4L; 8.5mm High Performance Wire; Equipped with Ceramic Spark Plug Boots	10059
1966-1958	8 Cyl. 5.8L; 8.5mm High Performance Wire; Equipped with Ceramic Spark Plug Boots	10059
1966-1958	8 Cyl. 5.8L; 8.5mm High Performance Wire	10008
1964-1963	8 Cyl. 4.3L; 8.5mm High Performance Wire; Equipped with Ceramic Spark Plug Boots	10059
1964-1963	8 Cyl. 4.3L; 8.5mm High Performance Wire	10008
1962-1957	8 Cyl. 4.8L; 8.5mm High Performance Wire; Equipped with Ceramic Spark Plug Boots	10059
1962-1957	8 Cyl. 4.8L; 8.5mm High Performance Wire	10008
1959-1958	8 Cyl. 5.4L; 8.5mm High Performance Wire	10008
1959-1958	8 Cyl. 5.4L; 8.5mm High Performance Wire; Equipped with Ceramic Spark Plug Boots	10059
1957	8 Cyl. 4.4L; 8.5mm High Performance Wire; Equipped with Ceramic Spark Plug Boots	10059
1957	8 Cyl. 4.4L; 8.5mm High Performance Wire	10008
Ranchero		
1976-1975	8 Cyl. 5.8L; Windsor Eng.; 8.5mm High Performance Wire	10008
1976-1975	8 Cyl. 5.8L; Modified Eng.; 8.5mm High Performance Wire; Equipped with Ceramic Spark Plug Boots	10059
1976-1975	8 Cyl. 5.8L; Modified Eng.; 8.5mm High Performance Wire	10008

Year	Model/Engine	Part No.
Spark Plug Wire Set		
Ranchero		
1976-1975	8 Cyl. 5.8L; Windsor Eng.; 8.5mm High Performance Wire; Equipped with Ceramic Spark Plug Boots	10059
1976-1974	8 Cyl. 7.5L; 8.5mm High Performance Wire; Equipped with Ceramic Spark Plug Boots	10059
1976-1974	8 Cyl. 7.5L; 8.5mm High Performance Wire	10008
1976-1972	8 Cyl. 6.6L; 8.5mm High Performance Wire	10008
1976-1972	8 Cyl. 6.6L; 8.5mm High Performance Wire; Equipped with Ceramic Spark Plug Boots	10059
1974-1970	8 Cyl. 5.8L; 8.5mm High Performance Wire; Equipped with Ceramic Spark Plug Boots	10059
1974-1970	8 Cyl. 5.8L; 8.5mm High Performance Wire	10008
1974-1969	8 Cyl. 5.0L; 8.5mm High Performance Wire	10008
1974-1969	8 Cyl. 5.0L; 8.5mm High Performance Wire; Equipped with Ceramic Spark Plug Boots	10059
1973-1968	8 Cyl. 7.0L; 8.5mm High Performance Wire; Equipped with Ceramic Spark Plug Boots	10059
1973-1968	8 Cyl. 7.0L; 8.5mm High Performance Wire	10008
1969-1968	8 Cyl. 6.4L; 8.5mm High Performance Wire; Equipped with Ceramic Spark Plug Boots	10059
1969-1968	8 Cyl. 6.4L; 8.5mm High Performance Wire	10008
1968	8 Cyl. 5.0L; 8.5mm High Performance Wire; w/ Improved Combustion Emission	10008
1968	8 Cyl. 5.0L; 8.5mm High Performance Wire; Equipped with Ceramic Spark Plug Boots; w/ Improved Combustion Emission	10059
1967	8 Cyl. 6.4L; 8.5mm High Performance Wire; Equipped with Ceramic Spark Plug Boots	10059
1967	8 Cyl. 6.4L; 8.5mm High Performance Wire	10008
1967-1965	8 Cyl. 4.7L; 8.5mm High Performance Wire	10008
1967-1965	8 Cyl. 4.7L; 8.5mm High Performance Wire; Equipped with Ceramic Spark Plug Boots	10059
1964-1963	8 Cyl. 4.3L; 8.5mm High Performance Wire	10008
1964-1963	8 Cyl. 4.3L; 8.5mm High Performance Wire; Equipped with Ceramic Spark Plug Boots	10059
1959-1957	8 Cyl. 5.8L; 8.5mm High Performance Wire	10008
1959-1957	8 Cyl. 5.8L; 8.5mm High Performance Wire; Equipped with Ceramic Spark Plug Boots	10059
1959-1957	8 Cyl. 4.8L; 8.5mm High Performance Wire; Equipped with Ceramic Spark Plug Boots	10059
1959-1957	8 Cyl. 4.8L; 8.5mm High Performance Wire	10008
1957	8 Cyl. 4.4L; 8.5mm High Performance Wire	10008
1957	8 Cyl. 4.4L; 8.5mm High Performance Wire; Equipped with Ceramic Spark Plug Boots	10059

Wire Sets

Year	Model/Engine	Part No.
Spark Plug Wire Set		
Ranger		
2000-1998	6 Cyl. 4.0L; 8.5mm High Performance Wire	10084
2000-1998	6 Cyl. 4.0L; 8.5mm High Performance Wire; Equipped with Ceramic Spark Plug Boots	10085
1997-1993	6 Cyl. 4.0L; 8.5mm High Performance Wire	10084
1997-1993	6 Cyl. 4.0L; 8.5mm High Performance Wire; Equipped with Ceramic Spark Plug Boots	10085
1995	6 Cyl. 3.0L; 8.5mm High Performance Wire; w/ Distributor	10081
1995	6 Cyl. 3.0L; 8.5mm High Performance Wire; Equipped with Ceramic Spark Plug Boots; w/ Distributor	10082
1994-1993	6 Cyl. 3.0L; 8.5mm High Performance Wire	10081
1994-1993	6 Cyl. 3.0L; 8.5mm High Performance Wire; Equipped with Ceramic Spark Plug Boots	10082
1994-1993	4 Cyl. 2.3L; 8.5mm High Performance Wire; Dual Plug Engine	10054
1994-1993	4 Cyl. 2.3L; 8.5mm High Performance Wire; Dual Plug Engine; Equipped with Ceramic Spark Plug Boots	10055
1992-1991	6 Cyl. 3.0L; 8.5mm High Performance Wire	10081
1992-1991	6 Cyl. 3.0L; 8.5mm High Performance Wire; Equipped with Ceramic Spark Plug Boots	10082
1992-1990	6 Cyl. 4.0L; 8.5mm High Performance Wire	10084
1992-1990	6 Cyl. 4.0L; 8.5mm High Performance Wire; Equipped with Ceramic Spark Plug Boots	10085
1992-1989	4 Cyl. 2.3L; 8.5mm High Performance Wire; Dual Plug Engine	10054
1992-1989	4 Cyl. 2.3L; 8.5mm High Performance Wire; Dual Plug Engine; Equipped with Ceramic Spark Plug Boots	10055
1992-1986	6 Cyl. 2.9L; 8.5mm High Performance Wire; Equipped with Ceramic Spark Plug Boots	10082
1992-1986	6 Cyl. 2.9L; 8.5mm High Performance Wire	10081
1985-1983	6 Cyl. 2.8L; 8.5mm High Performance Wire; Equipped with Ceramic Spark Plug Boots	10082
1985-1983	6 Cyl. 2.8L; 8.5mm High Performance Wire	10081
Skyliner		
1959-1958	8 Cyl. 4.8L; 8.5mm High Performance Wire	10008
1959-1958	8 Cyl. 4.8L; 8.5mm High Performance Wire; Equipped with Ceramic Spark Plug Boots	10059
1959-1958	8 Cyl. 5.8L; 8.5mm High Performance Wire	10008
1959-1958	8 Cyl. 5.4L; 8.5mm High Performance Wire	10008
1959-1958	8 Cyl. 5.4L; 8.5mm High Performance Wire; Equipped with Ceramic Spark Plug Boots	10059
1959-1958	8 Cyl. 5.8L; 8.5mm High Performance Wire; Equipped with Ceramic Spark Plug Boots	10059
1957	8 Cyl. 4.4L; 8.5mm High Performance Wire	10008

Year	Model/Engine	Part No.
Spark Plug Wire Set		
Skyliner		
1957	8 Cyl. 4.4L; 8.5mm High Performance Wire; Equipped with Ceramic Spark Plug Boots	10059
Sprint		
1964-1963	8 Cyl. 4.3L; 8.5mm High Performance Wire	10008
1964-1963	8 Cyl. 4.3L; 8.5mm High Performance Wire; Equipped with Ceramic Spark Plug Boots	10059
1963	8 Cyl. 3.6L; 8.5mm High Performance Wire	10008
1963	8 Cyl. 3.6L; 8.5mm High Performance Wire; Equipped with Ceramic Spark Plug Boots	10059
Starliner		
1960	8 Cyl. 5.8L; 8.5mm High Performance Wire	10008
1960	8 Cyl. 4.8L; 8.5mm High Performance Wire; Equipped with Ceramic Spark Plug Boots	10059
1960	8 Cyl. 4.8L; 8.5mm High Performance Wire	10008
1960	8 Cyl. 5.8L; 8.5mm High Performance Wire; Equipped with Ceramic Spark Plug Boots	10059
Sunliner		
1964	8 Cyl. 4.3L; 8.5mm High Performance Wire; Equipped with Ceramic Spark Plug Boots	10059
1964	8 Cyl. 4.3L; 8.5mm High Performance Wire	10008
1964-1962	8 Cyl. 6.4L; 8.5mm High Performance Wire; Equipped with Ceramic Spark Plug Boots	10059
1964-1962	8 Cyl. 6.4L; 8.5mm High Performance Wire	10008
1964-1962	8 Cyl. 5.8L; 8.5mm High Performance Wire; Equipped with Ceramic Spark Plug Boots	10059
1964-1962	8 Cyl. 5.8L; 8.5mm High Performance Wire	10008
1963	8 Cyl. 4.7L; 8.5mm High Performance Wire	10008
1963	8 Cyl. 4.7L; 8.5mm High Performance Wire; Equipped with Ceramic Spark Plug Boots	10059
1962	8 Cyl. 4.8L; 8.5mm High Performance Wire; Equipped with Ceramic Spark Plug Boots	10059
1962	8 Cyl. 4.8L; 8.5mm High Performance Wire	10008
1960-1958	8 Cyl. 5.8L; 8.5mm High Performance Wire; Equipped with Ceramic Spark Plug Boots	10059
1960-1958	8 Cyl. 4.8L; 8.5mm High Performance Wire; Equipped with Ceramic Spark Plug Boots	10059
1960-1958	8 Cyl. 5.8L; 8.5mm High Performance Wire	10008
1960-1958	8 Cyl. 4.8L; 8.5mm High Performance Wire	10008
1959-1958	8 Cyl. 5.4L; 8.5mm High Performance Wire; Equipped with Ceramic Spark Plug Boots	10059
1959-1958	8 Cyl. 5.4L; 8.5mm High Performance Wire	10008
1957	8 Cyl. 4.4L; 8.5mm High Performance Wire; Equipped with Ceramic Spark Plug Boots	10059

Wire Sets

Year	Model/Engine	Part No.
Spark Plug Wire Set		
Sunliner		
1957	8 Cyl. 4.4L; 8.5mm High Performance Wire	10008
Thunderbird		
1988-1983	8 Cyl. 5.0L; 8.5mm High Performance Wire; Equipped with Ceramic Spark Plug Boots	10047
1988-1983	8 Cyl. 5.0L; 8.5mm High Performance Wire	10011
1982-1981	8 Cyl. 4.2L; 8.5mm High Performance Wire	10011
1982-1981	8 Cyl. 4.2L; 8.5mm High Performance Wire; Equipped with Ceramic Spark Plug Boots	10047
1981	8 Cyl. 5.0L; 8.5mm High Performance Wire; Equipped with Ceramic Spark Plug Boots	10047
1981	8 Cyl. 5.0L; 8.5mm High Performance Wire	10011
1976-1972	8 Cyl. 7.5L; 8.5mm High Performance Wire	10008
1976-1972	8 Cyl. 7.5L; 8.5mm High Performance Wire; Equipped with Ceramic Spark Plug Boots	10059
1973-1968	8 Cyl. 7.0L; 8.5mm High Performance Wire; Equipped with Ceramic Spark Plug Boots	10059
1973-1968	8 Cyl. 7.0L; 8.5mm High Performance Wire	10008
1972	8 Cyl. 6.6L; 8.5mm High Performance Wire	10008
1972	8 Cyl. 6.6L; 8.5mm High Performance Wire; Equipped with Ceramic Spark Plug Boots	10059
1968	8 Cyl. 6.4L; 8.5mm High Performance Wire	10008
1968	8 Cyl. 6.4L; 8.5mm High Performance Wire; Equipped with Ceramic Spark Plug Boots	10059
1967-1963	8 Cyl. 7.0L; 8.5mm High Performance Wire; Equipped with Ceramic Spark Plug Boots	10059
1967-1963	8 Cyl. 7.0L; 8.5mm High Performance Wire	10008
1967-1961	8 Cyl. 6.4L; 8.5mm High Performance Wire	10008
1967-1961	8 Cyl. 6.4L; 8.5mm High Performance Wire; Equipped with Ceramic Spark Plug Boots	10059
1963-1962	8 Cyl. 6.7L; 8.5mm High Performance Wire; Equipped with Ceramic Spark Plug Boots	10059
1963-1962	8 Cyl. 6.7L; 8.5mm High Performance Wire	10008
1960-1959	8 Cyl. 7.0L; 8.5mm High Performance Wire; Equipped with Ceramic Spark Plug Boots	10059
1960-1959	8 Cyl. 7.0L; 8.5mm High Performance Wire	10008
1960-1958	8 Cyl. 5.8L; 8.5mm High Performance Wire; Equipped with Ceramic Spark Plug Boots	10059
1960-1958	8 Cyl. 5.8L; 8.5mm High Performance Wire	10008
1959-1958	8 Cyl. 5.4L; 8.5mm High Performance Wire	10008
1959-1958	8 Cyl. 5.4L; 8.5mm High Performance Wire; Equipped with Ceramic Spark Plug Boots	10059
1958	8 Cyl. 4.8L; 8.5mm High Performance Wire	10008

Year	Model/Engine	Part No.
Spark Plug Wire Set		
Thunderbird		
1958	8 Cyl. 4.8L; 8.5mm High Performance Wire; Equipped with Ceramic Spark Plug Boots	10059
Torino		
1976-1975	8 Cyl. 5.8L; Windsor Eng.; 8.5mm High Performance Wire	10008
1976-1975	8 Cyl. 5.8L; Modified Eng.; 8.5mm High Performance Wire; Equipped with Ceramic Spark Plug Boots	10059
1976-1975	8 Cyl. 5.8L; Windsor Eng.; 8.5mm High Performance Wire; Equipped with Ceramic Spark Plug Boots	10059
1976-1975	8 Cyl. 5.8L; Modified Eng.; 8.5mm High Performance Wire	10008
1976-1973	8 Cyl. 7.5L; 8.5mm High Performance Wire	10008
1976-1973	8 Cyl. 7.5L; 8.5mm High Performance Wire; Equipped with Ceramic Spark Plug Boots	10059
1976-1972	8 Cyl. 6.6L; 8.5mm High Performance Wire; Equipped with Ceramic Spark Plug Boots	10059
1976-1972	8 Cyl. 6.6L; 8.5mm High Performance Wire	10008
1974-1970	8 Cyl. 5.8L; 8.5mm High Performance Wire; Equipped with Ceramic Spark Plug Boots	10059
1974-1970	8 Cyl. 5.8L; 8.5mm High Performance Wire	10008
1974-1968	8 Cyl. 5.0L; 8.5mm High Performance Wire	10008
1974-1968	8 Cyl. 5.0L; 8.5mm High Performance Wire; Equipped with Ceramic Spark Plug Boots	10059
1973-1971	8 Cyl. 7.0L; 8.5mm High Performance Wire	10008
1973-1971	8 Cyl. 7.0L; 8.5mm High Performance Wire; Equipped with Ceramic Spark Plug Boots	10059
1969-1968	8 Cyl. 6.4L; 8.5mm High Performance Wire; Equipped with Ceramic Spark Plug Boots	10059
1969-1968	8 Cyl. 7.0L; 8.5mm High Performance Wire	10008
1969-1968	8 Cyl. 7.0L; 8.5mm High Performance Wire; Equipped with Ceramic Spark Plug Boots	10059
1969-1968	8 Cyl. 6.4L; 8.5mm High Performance Wire	10008
1968	8 Cyl. 4.7L; 8.5mm High Performance Wire; Equipped with Ceramic Spark Plug Boots	10059
1968	8 Cyl. 4.7L; 8.5mm High Performance Wire	10008
Victoria		
1964	8 Cyl. 6.4L; 8.5mm High Performance Wire; Equipped with Ceramic Spark Plug Boots	10059
1964	8 Cyl. 6.4L; 8.5mm High Performance Wire	10008
1964-1963	8 Cyl. 4.3L; 8.5mm High Performance Wire	10008
1964-1963	8 Cyl. 4.3L; 8.5mm High Performance Wire; Equipped with Ceramic Spark Plug Boots	10059
1964-1962	8 Cyl. 5.8L; 8.5mm High Performance Wire; Equipped with Ceramic Spark Plug Boots	10059
1964-1962	8 Cyl. 5.8L; 8.5mm High Performance Wire	10008

Ford

Wire Sets

Year	Model/Engine	Part No.
Spark Plug Wire Set		
Victoria		
1963	8 Cyl. 4.7L; 8.5mm High Performance Wire; Equipped with Ceramic Spark Plug Boots	10059
1963	8 Cyl. 4.7L; 8.5mm High Performance Wire	10008
1962	8 Cyl. 6.4L; 8.5mm High Performance Wire; Equipped with Ceramic Spark Plug Boots	10059
1962	8 Cyl. 4.8L; 8.5mm High Performance Wire; Equipped with Ceramic Spark Plug Boots	10059
1962	8 Cyl. 4.8L; 8.5mm High Performance Wire	10008
1962	8 Cyl. 6.4L; 8.5mm High Performance Wire	10008
1960-1958	8 Cyl. 5.8L; 8.5mm High Performance Wire; Equipped with Ceramic Spark Plug Boots	10059
1960-1958	8 Cyl. 5.8L; 8.5mm High Performance Wire	10008
1960-1958	8 Cyl. 4.8L; 8.5mm High Performance Wire; Equipped with Ceramic Spark Plug Boots	10059
1960-1958	8 Cyl. 4.8L; 8.5mm High Performance Wire	10008
1959-1958	8 Cyl. 5.4L; 8.5mm High Performance Wire	10008
1959-1958	8 Cyl. 5.4L; 8.5mm High Performance Wire; Equipped with Ceramic Spark Plug Boots	10059
1957	8 Cyl. 4.4L; 8.5mm High Performance Wire	10008
1957	8 Cyl. 4.4L; 8.5mm High Performance Wire; Equipped with Ceramic Spark Plug Boots	10059
GMC		
Wire Sets		
Spark Plug Wire Set		
C15		
1978	8 Cyl. 6.6L; 8.5mm High Performance Wire	10002
1978	8 Cyl. 6.6L; 9.0mm High Performance Wire	10034
1978	8 Cyl. 6.6L; 8.5mm High Performance Wire; Equipped with Ceramic Spark Plug Boots	10053
1978-1977	8 Cyl. 7.4L; 8.5mm High Performance Wire	10001
1978-1977	8 Cyl. 7.4L; 8.5mm High Performance Wire; Equipped with Ceramic Spark Plug Boots	10069
1978-1976	8 Cyl. 5.0L; 8.5mm High Performance Wire	10002
1978-1976	8 Cyl. 5.0L; 9.0mm High Performance Wire	10034
1978-1976	8 Cyl. 5.0L; 8.5mm High Performance Wire; Equipped with Ceramic Spark Plug Boots	10053
1978-1975	8 Cyl. 5.7L; 8.5mm High Performance Wire; Equipped with Ceramic Spark Plug Boots	10053
1978-1975	8 Cyl. 5.7L; 8.5mm High Performance Wire	10002
1978-1975	8 Cyl. 5.7L; 9.0mm High Performance Wire	10034
1976	8 Cyl. 6.6L; 8.5mm High Performance Wire	10002
1976	8 Cyl. 6.6L; 9.0mm High Performance Wire	10034

Year	Model/Engine	Part No.
Spark Plug Wire Set		
C15		
1976	8 Cyl. 7.4L; 8.5mm High Performance Wire; Equipped with Ceramic Spark Plug Boots; w/o AC	10069
1976	8 Cyl. 6.6L; 8.5mm High Performance Wire; Equipped with Ceramic Spark Plug Boots	10053
1976	8 Cyl. 7.4L; 8.5mm High Performance Wire; w/o AC	10001
1975	8 Cyl. 7.4L; 8.5mm High Performance Wire	10001
1975	8 Cyl. 7.4L; 8.5mm High Performance Wire; Equipped with Ceramic Spark Plug Boots	10069
C15 Suburban		
1978	8 Cyl. 7.4L; 8.5mm High Performance Wire; Equipped with Ceramic Spark Plug Boots	10069
1978	8 Cyl. 7.4L; 8.5mm High Performance Wire	10001
1975	8 Cyl. 7.4L; 8.5mm High Performance Wire; Equipped with Ceramic Spark Plug Boots	10069
1975	8 Cyl. 7.4L; 8.5mm High Performance Wire	10001
C15/C1500 Pickup		
1974-1973	8 Cyl. 7.4L; 8.5mm High Performance Wire; w/ Straight Non-Bendable Spark Plug Boot	10006
1974-1973	8 Cyl. 7.4L; 8.5mm High Performance Wire; Equipped with Ceramic Spark Plug Boots	10114
1974-1973	8 Cyl. 7.4L; 8.5mm High Performance Wire; w/ Straight Bendable Spark Plug Boot	10116
1974-1971	8 Cyl. 5.7L; 8.5mm High Performance Wire; Routed Over Valve Cover	10007
1974-1971	8 Cyl. 5.7L; 8.5mm High Performance Wire; Equipped with Ceramic Spark Plug Boots; Routed Over Valve Cover	10079
1973-1971	8 Cyl. 5.0L; 8.5mm High Performance Wire; Equipped with Ceramic Spark Plug Boots; Routed Over Valve Cover	10079
1973-1971	8 Cyl. 5.0L; 8.5mm High Performance Wire; Routed Over Valve Cover	10007
1972	8 Cyl. 6.6L; 8.5mm High Performance Wire; Equipped with Ceramic Spark Plug Boots; Routed Over Valve Cover	10079
1972	8 Cyl. 6.6L; 8.5mm High Performance Wire; Routed Over Valve Cover	10007
1971-1970	8 Cyl. 6.6L; 8.5mm High Performance Wire; w/ Straight Non-Bendable Spark Plug Boot	10006
1971-1970	8 Cyl. 6.6L; 8.5mm High Performance Wire; w/ Straight Bendable Spark Plug Boot	10116
1970	8 Cyl. 6.6L; 8.5mm High Performance Wire; Equipped with Ceramic Spark Plug Boots	10114
1970-1969	8 Cyl. 5.7L; 8.5mm High Performance Wire; Equipped with Ceramic Spark Plug Boots; Routed Under Exhaust Manifold	10080
1970-1969	8 Cyl. 5.7L; 8.5mm High Performance Wire; Routed Under Exhaust Manifold	10005
1970-1968	8 Cyl. 5.0L; 8.5mm High Performance Wire; Equipped with Ceramic Spark Plug Boots; Routed Under Exhaust Manifold	10080
1970-1968	8 Cyl. 5.0L; 8.5mm High Performance Wire; Routed Under Exhaust Manifold	10005

Wire Sets

Year	Model/Engine	Part No.
Spark Plug Wire Set		
C15/C1500 Pickup		
1969	8 Cyl. 6.5L; 8.5mm High Performance Wire; w/ Straight Non-Bendable Spark Plug Boot	10006
1969	8 Cyl. 6.5L; 8.5mm High Performance Wire; Equipped with Ceramic Spark Plug Boots	10114
1969	8 Cyl. 6.5L; 8.5mm High Performance Wire; w/ Straight Bendable Spark Plug Boot	10116
1968	8 Cyl. 5.4L; 8.5mm High Performance Wire; Equipped with Ceramic Spark Plug Boots; Routed Under Exhaust Manifold	10080
1968	8 Cyl. 6.5L; 8.5mm High Performance Wire; Equipped with Ceramic Spark Plug Boots; Routed Under Exhaust Manifold	10080
1968	8 Cyl. 5.4L; 8.5mm High Performance Wire; Routed Under Exhaust Manifold	10005
1968	8 Cyl. 6.5L; 8.5mm High Performance Wire; Routed Under Exhaust Manifold	10005
1967	8 Cyl. 4.6L; 8.5mm High Performance Wire; Equipped with Ceramic Spark Plug Boots; Routed Under Exhaust Manifold	10080
1967	8 Cyl. 4.6L; 8.5mm High Performance Wire; Routed Under Exhaust Manifold	10005
1967	8 Cyl. 5.3L; 8.5mm High Performance Wire; Routed Under Exhaust Manifold	10005
1967	8 Cyl. 5.3L; 8.5mm High Performance Wire; Equipped with Ceramic Spark Plug Boots; Routed Under Exhaust Manifold	10080
C15/C1500 Suburban		
1974	8 Cyl. 5.7L; 8.5mm High Performance Wire; Routed Over Valve Cover	10007
1974	8 Cyl. 5.7L; 8.5mm High Performance Wire; Equipped with Ceramic Spark Plug Boots; Routed Over Valve Cover	10079
C25		
1978-1977	8 Cyl. 5.0L; 8.5mm High Performance Wire	10002
1978-1977	8 Cyl. 7.4L; 8.5mm High Performance Wire; Equipped with Ceramic Spark Plug Boots	10069
1978-1977	8 Cyl. 5.0L; 8.5mm High Performance Wire; Equipped with Ceramic Spark Plug Boots	10053
1978-1977	8 Cyl. 5.0L; 9.0mm High Performance Wire	10034
1978-1977	8 Cyl. 7.4L; 8.5mm High Performance Wire	10001
1978-1976	8 Cyl. 6.6L; 8.5mm High Performance Wire; Equipped with Ceramic Spark Plug Boots	10053
1978-1976	8 Cyl. 6.6L; 8.5mm High Performance Wire	10002
1978-1976	8 Cyl. 6.6L; 9.0mm High Performance Wire	10034
1978-1975	8 Cyl. 5.7L; 8.5mm High Performance Wire; Equipped with Ceramic Spark Plug Boots	10053
1978-1975	8 Cyl. 5.7L; 8.5mm High Performance Wire	10002
1978-1975	8 Cyl. 5.7L; 9.0mm High Performance Wire	10034
1976	8 Cyl. 7.4L; 8.5mm High Performance Wire; Equipped with Ceramic Spark Plug Boots; w/o AC	10069
1976	8 Cyl. 7.4L; 8.5mm High Performance Wire; w/o AC	10001
1975	8 Cyl. 7.4L; 8.5mm High Performance Wire; Equipped with Ceramic Spark Plug Boots	10069

Year	Model/Engine	Part No.
Spark Plug Wire Set		
C25		
1975	8 Cyl. 7.4L; 8.5mm High Performance Wire	10001
C25 Suburban		
1978	8 Cyl. 7.4L; 8.5mm High Performance Wire	10001
1978	8 Cyl. 7.4L; 8.5mm High Performance Wire; Equipped with Ceramic Spark Plug Boots	10069
1975	8 Cyl. 7.4L; 8.5mm High Performance Wire	10001
1975	8 Cyl. 7.4L; 8.5mm High Performance Wire; Equipped with Ceramic Spark Plug Boots	10069
C25/C2500 Pickup		
1974-1973	8 Cyl. 7.4L; 8.5mm High Performance Wire; w/ Straight Non-Bendable Spark Plug Boot	10006
1974-1973	8 Cyl. 7.4L; 8.5mm High Performance Wire; Equipped with Ceramic Spark Plug Boots	10114
1974-1973	8 Cyl. 7.4L; 8.5mm High Performance Wire; w/ Straight Bendable Spark Plug Boot	10116
1974-1971	8 Cyl. 5.7L; 8.5mm High Performance Wire; Routed Over Valve Cover	10007
1974-1971	8 Cyl. 5.7L; 8.5mm High Performance Wire; Equipped with Ceramic Spark Plug Boots; Routed Over Valve Cover	10079
1973-1971	8 Cyl. 5.0L; 8.5mm High Performance Wire; Equipped with Ceramic Spark Plug Boots; Routed Over Valve Cover	10079
1973-1971	8 Cyl. 5.0L; 8.5mm High Performance Wire; Routed Over Valve Cover	10007
1972	8 Cyl. 6.6L; 8.5mm High Performance Wire; Routed Over Valve Cover	10007
1972	8 Cyl. 6.6L; 8.5mm High Performance Wire; Equipped with Ceramic Spark Plug Boots; Routed Over Valve Cover	10079
1971-1970	8 Cyl. 6.6L; 8.5mm High Performance Wire; w/ Straight Non-Bendable Spark Plug Boot	10006
1971-1970	8 Cyl. 6.6L; 8.5mm High Performance Wire; Equipped with Ceramic Spark Plug Boots	10114
1971-1970	8 Cyl. 6.6L; 8.5mm High Performance Wire; w/ Straight Bendable Spark Plug Boot	10116
1970-1969	8 Cyl. 5.7L; 8.5mm High Performance Wire; Routed Under Exhaust Manifold	10005
1970-1969	8 Cyl. 5.7L; 8.5mm High Performance Wire; Equipped with Ceramic Spark Plug Boots; Routed Under Exhaust Manifold	10080
1969	8 Cyl. 6.5L; 8.5mm High Performance Wire; w/ Straight Non-Bendable Spark Plug Boot	10006
1969	8 Cyl. 6.5L; 8.5mm High Performance Wire; Equipped with Ceramic Spark Plug Boots	10114
1969	8 Cyl. 6.5L; 8.5mm High Performance Wire; w/ Straight Bendable Spark Plug Boot	10116
1969-1968	8 Cyl. 5.0L; 8.5mm High Performance Wire; Equipped with Ceramic Spark Plug Boots; Routed Under Exhaust Manifold	10080
1969-1968	8 Cyl. 5.0L; 8.5mm High Performance Wire; Routed Under Exhaust Manifold	10005
1968	8 Cyl. 5.4L; 8.5mm High Performance Wire; Equipped with Ceramic Spark Plug Boots; Routed Under Exhaust Manifold	10080

Wire Sets

Year	Model/Engine	Part No.
Spark Plug Wire Set		
C25/C2500 Pickup		
1968	8 Cyl. 6.5L; 8.5mm High Performance Wire; Equipped with Ceramic Spark Plug Boots; Routed Under Exhaust Manifold	10080
1968	8 Cyl. 6.5L; 8.5mm High Performance Wire; Routed Under Exhaust Manifold	10005
1968	8 Cyl. 5.4L; 8.5mm High Performance Wire; Routed Under Exhaust Manifold	10005
1967	8 Cyl. 5.3L; 8.5mm High Performance Wire; Equipped with Ceramic Spark Plug Boots; Routed Under Exhaust Manifold	10080
1967	8 Cyl. 4.6L; 8.5mm High Performance Wire; Equipped with Ceramic Spark Plug Boots; Routed Under Exhaust Manifold	10080
1967	8 Cyl. 4.6L; 8.5mm High Performance Wire; Routed Under Exhaust Manifold	10005
1967	8 Cyl. 5.3L; 8.5mm High Performance Wire; Routed Under Exhaust Manifold	10005
C25/C2500 Suburban		
1974	8 Cyl. 5.7L; 8.5mm High Performance Wire; Routed Over Valve Cover	10007
1974	8 Cyl. 5.7L; 8.5mm High Performance Wire; Equipped with Ceramic Spark Plug Boots; Routed Over Valve Cover	10079
C35		
1978	8 Cyl. 5.0L; 8.5mm High Performance Wire	10002
1978	8 Cyl. 5.0L; 8.5mm High Performance Wire; Equipped with Ceramic Spark Plug Boots	10053
1978	8 Cyl. 5.0L; 9.0mm High Performance Wire	10034
1978-1977	8 Cyl. 7.4L; 8.5mm High Performance Wire	10001
1978-1977	8 Cyl. 7.4L; 8.5mm High Performance Wire; Equipped with Ceramic Spark Plug Boots	10069
1978-1976	8 Cyl. 6.6L; 9.0mm High Performance Wire	10034
1978-1976	8 Cyl. 6.6L; 8.5mm High Performance Wire; Equipped with Ceramic Spark Plug Boots	10053
1978-1976	8 Cyl. 6.6L; 8.5mm High Performance Wire	10002
1978-1975	8 Cyl. 5.7L; 9.0mm High Performance Wire	10034
1978-1975	8 Cyl. 5.7L; 8.5mm High Performance Wire; Equipped with Ceramic Spark Plug Boots	10053
1978-1975	8 Cyl. 5.7L; 8.5mm High Performance Wire	10002
1976	8 Cyl. 7.4L; 8.5mm High Performance Wire; Equipped with Ceramic Spark Plug Boots; w/o AC	10069
1976	8 Cyl. 7.4L; 8.5mm High Performance Wire; w/o AC	10001
1975	8 Cyl. 7.4L; 8.5mm High Performance Wire	10001
1975	8 Cyl. 7.4L; 8.5mm High Performance Wire; Equipped with Ceramic Spark Plug Boots	10069
C35/C3500 Pickup		
1974-1973	8 Cyl. 7.4L; 8.5mm High Performance Wire; w/ Straight Non-Bendable Spark Plug Boot	10006
1974-1973	8 Cyl. 7.4L; 8.5mm High Performance Wire; Equipped with Ceramic Spark Plug Boots	10114
1974-1973	8 Cyl. 7.4L; 8.5mm High Performance Wire; w/ Straight Bendable Spark Plug Boot	10116

Year	Model/Engine	Part No.
Spark Plug Wire Set		
C35/C3500 Pickup		
1974-1971	8 Cyl. 5.7L; 8.5mm High Performance Wire; Equipped with Ceramic Spark Plug Boots; Routed Over Valve Cover	10079
1974-1971	8 Cyl. 5.7L; 8.5mm High Performance Wire; Routed Over Valve Cover	10007
1973-1971	8 Cyl. 5.0L; 8.5mm High Performance Wire; Routed Over Valve Cover	10007
1973-1971	8 Cyl. 5.0L; 8.5mm High Performance Wire; Equipped with Ceramic Spark Plug Boots; Routed Over Valve Cover	10079
1972	8 Cyl. 6.6L; 8.5mm High Performance Wire; Routed Over Valve Cover	10007
1972	8 Cyl. 6.6L; 8.5mm High Performance Wire; Equipped with Ceramic Spark Plug Boots; Routed Over Valve Cover	10079
1971-1970	8 Cyl. 6.6L; 8.5mm High Performance Wire; Equipped with Ceramic Spark Plug Boots	10114
1971-1970	8 Cyl. 6.6L; 8.5mm High Performance Wire; w/ Straight Non-Bendable Spark Plug Boot	10006
1971-1970	8 Cyl. 6.6L; 8.5mm High Performance Wire; w/ Straight Bendable Spark Plug Boot	10116
1970-1969	8 Cyl. 5.7L; 8.5mm High Performance Wire; Routed Under Exhaust Manifold	10005
1970-1969	8 Cyl. 5.7L; 8.5mm High Performance Wire; Equipped with Ceramic Spark Plug Boots; Routed Under Exhaust Manifold	10080
1970-1968	8 Cyl. 5.0L; 8.5mm High Performance Wire; Routed Under Exhaust Manifold	10005
1970-1968	8 Cyl. 5.0L; 8.5mm High Performance Wire; Equipped with Ceramic Spark Plug Boots; Routed Under Exhaust Manifold	10080
1969-1968	8 Cyl. 6.5L; 8.5mm High Performance Wire; Equipped with Ceramic Spark Plug Boots	10114
1969-1968	8 Cyl. 6.5L; 8.5mm High Performance Wire; w/ Straight Non-Bendable Spark Plug Boot	10006
1969-1968	8 Cyl. 6.5L; 8.5mm High Performance Wire; w/ Straight Bendable Spark Plug Boot	10116
1968	8 Cyl. 5.4L; 8.5mm High Performance Wire; Routed Under Exhaust Manifold	10005
1968	8 Cyl. 5.4L; 8.5mm High Performance Wire; Equipped with Ceramic Spark Plug Boots; Routed Under Exhaust Manifold	10080
1967	8 Cyl. 4.6L; 8.5mm High Performance Wire; Equipped with Ceramic Spark Plug Boots; Routed Under Exhaust Manifold	10080
1967	8 Cyl. 4.6L; 8.5mm High Performance Wire; Routed Under Exhaust Manifold	10005
1967	8 Cyl. 5.3L; 8.5mm High Performance Wire; Routed Under Exhaust Manifold	10005
1967	8 Cyl. 5.3L; 8.5mm High Performance Wire; Equipped with Ceramic Spark Plug Boots; Routed Under Exhaust Manifold	10080
C1500		
1999-1996	8 Cyl. 5.0L; 8.5mm High Performance Wire	10021
1999-1996	8 Cyl. 5.0L; 8.5mm High Performance Wire; Equipped with Ceramic Spark Plug Boots	10072
1999-1996	8 Cyl. 5.7L; 8.5mm High Performance Wire	10021
1999-1996	8 Cyl. 5.7L; 8.5mm High Performance Wire; Equipped with Ceramic Spark Plug Boots	10072

Wire Sets

Year	Model/Engine	Part No.
Spark Plug Wire Set		
C1500		
1998-1996	6 Cyl. 4.3L; 8.5mm High Performance Wire	10077
1998-1996	6 Cyl. 4.3L; 8.5mm High Performance Wire; Equipped with Ceramic Spark Plug Boots	10078
1995-1989	8 Cyl. 5.0L; 8.5mm High Performance Wire	10018
1995-1989	8 Cyl. 5.7L; 8.5mm High Performance Wire; Equipped with Ceramic Spark Plug Boots	10046
1995-1989	8 Cyl. 5.7L; 8.5mm High Performance Wire	10018
1995-1989	8 Cyl. 5.0L; 8.5mm High Performance Wire; Equipped with Ceramic Spark Plug Boots	10046
1995-1988	8 Cyl. 5.7L; 9.0mm High Performance Wire	10038
1995-1988	6 Cyl. 4.3L; 8.5mm High Performance Wire	10014
1995-1988	6 Cyl. 4.3L; 8.5mm High Performance Wire; Equipped with Ceramic Spark Plug Boots	10076
1995-1988	8 Cyl. 5.0L; 9.0mm High Performance Wire	10038
1986	8 Cyl. 5.7L; L; 8.5mm High Performance Wire; Equipped with Ceramic Spark Plug Boots	10056
1986	8 Cyl. 5.7L; L; 9.0mm High Performance Wire	10037
1986	8 Cyl. 5.7L; L; 8.5mm High Performance Wire	10010
1986	8 Cyl. 5.7L; M; 8.5mm High Performance Wire; Fed.	10002
1986	8 Cyl. 5.7L; M; 9.0mm High Performance Wire; Calif.	10037
1986	8 Cyl. 5.7L; M; 9.0mm High Performance Wire; Fed.	10034
1986	8 Cyl. 5.7L; M; 8.5mm High Performance Wire; Calif.; Equipped with Ceramic Spark Plug Boots	10056
1986	8 Cyl. 5.7L; M; 8.5mm High Performance Wire; Equipped with Ceramic Spark Plug Boots; Fed.	10053
1986	8 Cyl. 5.7L; M; 8.5mm High Performance Wire; Calif.	10010
1986-1981	8 Cyl. 5.0L; 8.5mm High Performance Wire	10010
1986-1981	8 Cyl. 5.0L; 9.0mm High Performance Wire	10037
1986-1981	8 Cyl. 5.0L; 8.5mm High Performance Wire; Equipped with Ceramic Spark Plug Boots	10056
1985-1982	8 Cyl. 5.7L; 9.0mm High Performance Wire	10037
1985-1982	8 Cyl. 5.7L; 8.5mm High Performance Wire; Equipped with Ceramic Spark Plug Boots	10056
1985-1982	8 Cyl. 5.7L; 8.5mm High Performance Wire	10010
1981	8 Cyl. 5.7L; L; 8.5mm High Performance Wire; Equipped with Ceramic Spark Plug Boots	10056
1981	8 Cyl. 5.7L; L; 9.0mm High Performance Wire	10037
1981	8 Cyl. 5.7L; L; 8.5mm High Performance Wire	10010
1981	8 Cyl. 5.7L; M; 9.0mm High Performance Wire	10034
1981	8 Cyl. 5.7L; M; 8.5mm High Performance Wire	10002

Year	Model/Engine	Part No.
Spark Plug Wire Set		
C1500		
1981	8 Cyl. 5.7L; M; 8.5mm High Performance Wire; Equipped with Ceramic Spark Plug Boots	10053
1980-1979	8 Cyl. 6.6L; 9.0mm High Performance Wire	10034
1980-1979	8 Cyl. 5.0L; 9.0mm High Performance Wire	10034
1980-1979	8 Cyl. 5.0L; 8.5mm High Performance Wire; Equipped with Ceramic Spark Plug Boots	10053
1980-1979	8 Cyl. 7.4L; 8.5mm High Performance Wire; Equipped with Ceramic Spark Plug Boots	10069
1980-1979	8 Cyl. 5.0L; 8.5mm High Performance Wire	10002
1980-1979	8 Cyl. 6.6L; 8.5mm High Performance Wire	10002
1980-1979	8 Cyl. 6.6L; 8.5mm High Performance Wire; Equipped with Ceramic Spark Plug Boots	10053
1980-1979	8 Cyl. 5.7L; 8.5mm High Performance Wire	10002
1980-1979	8 Cyl. 5.7L; 8.5mm High Performance Wire; Equipped with Ceramic Spark Plug Boots	10053
1980-1979	8 Cyl. 5.7L; 9.0mm High Performance Wire	10034
1980-1979	8 Cyl. 7.4L; 8.5mm High Performance Wire	10001
C1500 Suburban		
1986	8 Cyl. 5.0L; 8.5mm High Performance Wire; Equipped with Ceramic Spark Plug Boots	10056
1986	8 Cyl. 5.0L; 9.0mm High Performance Wire	10037
1986	8 Cyl. 5.0L; 8.5mm High Performance Wire	10010
1981	8 Cyl. 5.0L; 8.5mm High Performance Wire; Equipped with Ceramic Spark Plug Boots	10056
1981	8 Cyl. 5.0L; 9.0mm High Performance Wire	10037
1981	8 Cyl. 5.0L; 8.5mm High Performance Wire	10010
1980	8 Cyl. 5.0L; 8.5mm High Performance Wire; Equipped with Ceramic Spark Plug Boots	10053
1980	8 Cyl. 5.0L; 9.0mm High Performance Wire	10034
1980	8 Cyl. 5.0L; 8.5mm High Performance Wire	10002
1980-1979	8 Cyl. 7.4L; 8.5mm High Performance Wire	10001
1980-1979	8 Cyl. 7.4L; 8.5mm High Performance Wire; Equipped with Ceramic Spark Plug Boots	10069
C2500		
2000-1996	8 Cyl. 7.4L; 8.5mm High Performance Wire; Equipped with Ceramic Spark Plug Boots	10071
2000-1996	8 Cyl. 5.7L; 8.5mm High Performance Wire	10021
2000-1996	8 Cyl. 7.4L; 8.5mm High Performance Wire	10070
2000-1996	8 Cyl. 5.7L; 8.5mm High Performance Wire; Equipped with Ceramic Spark Plug Boots	10072
1998-1996	8 Cyl. 5.0L; 8.5mm High Performance Wire	10021

Wire Sets

Year	Model/Engine	Part No.
Spark Plug Wire Set		
C2500		
1998-1996	8 Cyl. 5.0L; 8.5mm High Performance Wire; Equipped with Ceramic Spark Plug Boots	10072
1995-1991	8 Cyl. 7.4L; 8.5mm High Performance Wire; Equipped with Ceramic Spark Plug Boots	10051
1995-1991	8 Cyl. 7.4L; 8.5mm High Performance Wire	10050
1995-1988	6 Cyl. 4.3L; 8.5mm High Performance Wire; Equipped with Ceramic Spark Plug Boots	10076
1995-1988	8 Cyl. 5.0L; 8.5mm High Performance Wire	10018
1995-1988	8 Cyl. 5.7L; 9.0mm High Performance Wire	10038
1995-1988	8 Cyl. 5.0L; 8.5mm High Performance Wire; Equipped with Ceramic Spark Plug Boots	10046
1995-1988	8 Cyl. 5.7L; 8.5mm High Performance Wire	10018
1995-1988	8 Cyl. 5.0L; 9.0mm High Performance Wire	10038
1995-1988	6 Cyl. 4.3L; 8.5mm High Performance Wire	10014
1995-1988	8 Cyl. 5.7L; 8.5mm High Performance Wire; Equipped with Ceramic Spark Plug Boots	10046
1986	8 Cyl. 7.4L; 8.5mm High Performance Wire; Calif.; Equipped with Ceramic Spark Plug Boots	10069
1986	8 Cyl. 7.4L; 8.5mm High Performance Wire; Equipped with Ceramic Spark Plug Boots; Fed.	10065
1986	8 Cyl. 7.4L; 8.5mm High Performance Wire; Calif.	10001
1986	8 Cyl. 7.4L; 8.5mm High Performance Wire; Fed.	10064
1986	8 Cyl. 5.7L; L; 9.0mm High Performance Wire	10037
1986	8 Cyl. 5.7L; L; 8.5mm High Performance Wire	10010
1986	8 Cyl. 5.7L; L; 8.5mm High Performance Wire; Equipped with Ceramic Spark Plug Boots	10056
1986	8 Cyl. 5.7L; M; 8.5mm High Performance Wire; Fed.	10002
1986	8 Cyl. 5.7L; M; 8.5mm High Performance Wire; Equipped with Ceramic Spark Plug Boots; Fed.	10053
1986	8 Cyl. 5.7L; M; 9.0mm High Performance Wire; Fed.	10034
1986	8 Cyl. 5.7L; M; 8.5mm High Performance Wire; Calif.	10010
1986	8 Cyl. 5.7L; M; 8.5mm High Performance Wire; Calif.; Equipped with Ceramic Spark Plug Boots	10056
1986	8 Cyl. 5.7L; M; 9.0mm High Performance Wire; Calif.	10037
1986-1981	8 Cyl. 5.0L; 8.5mm High Performance Wire	10010
1986-1981	8 Cyl. 5.0L; 8.5mm High Performance Wire; Equipped with Ceramic Spark Plug Boots	10056
1986-1981	8 Cyl. 5.0L; 9.0mm High Performance Wire	10037
1985	8 Cyl. 7.4L; 8.5mm High Performance Wire; w/ Cast Iron Exhaust Manifold	10001
1985	8 Cyl. 7.4L; 8.5mm High Performance Wire; Equipped with Ceramic Spark Plug Boots; w/ Cast Iron Exhaust Manifold	10069

Year	Model/Engine	Part No.
Spark Plug Wire Set		
C2500		
1985	8 Cyl. 7.4L; 8.5mm High Performance Wire; Equipped with Ceramic Spark Plug Boots; w/ Stainless Steel Exhaust Manifold	10065
1985	8 Cyl. 7.4L; 8.5mm High Performance Wire; w/ Stainless Steel Exhaust Manifold	10064
1985-1983	8 Cyl. 5.7L; 9.0mm High Performance Wire	10037
1985-1983	8 Cyl. 5.7L; 8.5mm High Performance Wire; Equipped with Ceramic Spark Plug Boots	10056
1985-1983	8 Cyl. 5.7L; 8.5mm High Performance Wire	10010
1984-1979	8 Cyl. 7.4L; 8.5mm High Performance Wire	10001
1984-1979	8 Cyl. 7.4L; 8.5mm High Performance Wire; Equipped with Ceramic Spark Plug Boots	10069
1982-1981	8 Cyl. 5.7L; L; 9.0mm High Performance Wire	10037
1982-1981	8 Cyl. 5.7L; L; 8.5mm High Performance Wire	10010
1982-1981	8 Cyl. 5.7L; L; 8.5mm High Performance Wire; Equipped with Ceramic Spark Plug Boots	10056
1982-1981	8 Cyl. 5.7L; M; 9.0mm High Performance Wire	10034
1982-1981	8 Cyl. 5.7L; M; 8.5mm High Performance Wire	10002
1982-1981	8 Cyl. 5.7L; M; 8.5mm High Performance Wire; Equipped with Ceramic Spark Plug Boots	10053
1980-1979	8 Cyl. 5.7L; 9.0mm High Performance Wire	10034
1980-1979	8 Cyl. 5.0L; 8.5mm High Performance Wire	10002
1980-1979	8 Cyl. 5.0L; 9.0mm High Performance Wire	10034
1980-1979	8 Cyl. 5.0L; 8.5mm High Performance Wire; Equipped with Ceramic Spark Plug Boots	10053
1980-1979	8 Cyl. 5.7L; 8.5mm High Performance Wire; Equipped with Ceramic Spark Plug Boots	10053
1980-1979	8 Cyl. 5.7L; 8.5mm High Performance Wire	10002
1979	8 Cyl. 6.6L; 9.0mm High Performance Wire	10034
1979	8 Cyl. 6.6L; 8.5mm High Performance Wire	10002
1979	8 Cyl. 6.6L; 8.5mm High Performance Wire; Equipped with Ceramic Spark Plug Boots	10053
C2500 Suburban		
1999-1996	8 Cyl. 7.4L; 8.5mm High Performance Wire	10070
1999-1996	8 Cyl. 7.4L; 8.5mm High Performance Wire; Equipped with Ceramic Spark Plug Boots	10071
1986	8 Cyl. 5.0L; 8.5mm High Performance Wire	10010
1986	8 Cyl. 7.4L; 8.5mm High Performance Wire; Calif.	10001
1986	8 Cyl. 5.0L; 9.0mm High Performance Wire	10037
1986	8 Cyl. 7.4L; 8.5mm High Performance Wire; Calif.; Equipped with Ceramic Spark Plug Boots	10069

Wire Sets

Year	Model/Engine	Part No.
Spark Plug Wire Set		
C2500 Suburban		
1986	8 Cyl. 7.4L; 8.5mm High Performance Wire; Equipped with Ceramic Spark Plug Boots; Fed.	10065
1986	8 Cyl. 5.0L; 8.5mm High Performance Wire; Equipped with Ceramic Spark Plug Boots	10056
1986	8 Cyl. 7.4L; 8.5mm High Performance Wire; Fed.	10064
1985	8 Cyl. 7.4L; 8.5mm High Performance Wire; w/ Cast Iron Exhaust Manifold	10001
1985	8 Cyl. 7.4L; 8.5mm High Performance Wire; w/ Stainless Steel Exhaust Manifold	10064
1985	8 Cyl. 7.4L; 8.5mm High Performance Wire; Equipped with Ceramic Spark Plug Boots; w/ Cast Iron Exhaust Manifold	10069
1985	8 Cyl. 7.4L; 8.5mm High Performance Wire; Equipped with Ceramic Spark Plug Boots; w/ Stainless Steel Exhaust Manifold	10065
1984-1979	8 Cyl. 7.4L; 8.5mm High Performance Wire; Equipped with Ceramic Spark Plug Boots	10069
1984-1979	8 Cyl. 7.4L; 8.5mm High Performance Wire	10001
C3500		
2000-1996	8 Cyl. 7.4L; 8.5mm High Performance Wire; Equipped with Ceramic Spark Plug Boots	10071
2000-1996	8 Cyl. 5.7L; 8.5mm High Performance Wire	10021
2000-1996	8 Cyl. 5.7L; 8.5mm High Performance Wire; Equipped with Ceramic Spark Plug Boots	10072
2000-1996	8 Cyl. 7.4L; 8.5mm High Performance Wire	10070
1995-1991	8 Cyl. 7.4L; 8.5mm High Performance Wire	10050
1995-1991	8 Cyl. 7.4L; 8.5mm High Performance Wire; Equipped with Ceramic Spark Plug Boots	10051
1995-1988	8 Cyl. 5.7L; 9.0mm High Performance Wire	10038
1995-1988	8 Cyl. 5.7L; 8.5mm High Performance Wire; Equipped with Ceramic Spark Plug Boots	10046
1995-1988	8 Cyl. 5.7L; 8.5mm High Performance Wire	10018
1990	8 Cyl. 7.4L; 8.5mm High Performance Wire; Equipped with Ceramic Spark Plug Boots	10049
1990	8 Cyl. 7.4L; 8.5mm High Performance Wire	10048
1989	8 Cyl. 7.4L; 8.5mm High Performance Wire	10050
1989	8 Cyl. 7.4L; 8.5mm High Performance Wire; Equipped with Ceramic Spark Plug Boots	10051
1986	8 Cyl. 5.7L; 8.5mm High Performance Wire; Calif.	10010
1986	8 Cyl. 5.7L; 9.0mm High Performance Wire; Fed.	10034
1986	8 Cyl. 5.0L; 9.0mm High Performance Wire	10037
1986	8 Cyl. 7.4L; 8.5mm High Performance Wire; Fed.	10064
1986	8 Cyl. 5.7L; 8.5mm High Performance Wire; Calif.; Equipped with Ceramic Spark Plug Boots	10056
1986	8 Cyl. 5.7L; 9.0mm High Performance Wire; Calif.	10037

Year	Model/Engine	Part No.
Spark Plug Wire Set		
C3500		
1986	8 Cyl. 5.0L; 8.5mm High Performance Wire	10010
1986	8 Cyl. 5.0L; 8.5mm High Performance Wire; Equipped with Ceramic Spark Plug Boots	10056
1986	8 Cyl. 7.4L; 8.5mm High Performance Wire; Calif.; Equipped with Ceramic Spark Plug Boots	10069
1986	8 Cyl. 7.4L; 8.5mm High Performance Wire; Equipped with Ceramic Spark Plug Boots; Fed.	10065
1986	8 Cyl. 5.7L; 8.5mm High Performance Wire; Fed.	10002
1986	8 Cyl. 7.4L; 8.5mm High Performance Wire; Calif.	10001
1986	8 Cyl. 5.7L; 8.5mm High Performance Wire; Equipped with Ceramic Spark Plug Boots; Fed.	10053
1985	8 Cyl. 7.4L; 8.5mm High Performance Wire; w/ Stainless Steel Exhaust Manifold	10064
1985	8 Cyl. 7.4L; 8.5mm High Performance Wire; Equipped with Ceramic Spark Plug Boots; w/ Stainless Steel Exhaust Manifold	10065
1985	8 Cyl. 7.4L; 8.5mm High Performance Wire; Equipped with Ceramic Spark Plug Boots; w/ Cast Iron Exhaust Manifold	10069
1985	8 Cyl. 7.4L; 8.5mm High Performance Wire; w/ Cast Iron Exhaust Manifold	10001
1985-1983	8 Cyl. 5.7L; 9.0mm High Performance Wire	10037
1985-1983	8 Cyl. 5.7L; 8.5mm High Performance Wire	10010
1985-1983	8 Cyl. 5.7L; 8.5mm High Performance Wire; Equipped with Ceramic Spark Plug Boots	10056
1984-1979	8 Cyl. 7.4L; 8.5mm High Performance Wire; Equipped with Ceramic Spark Plug Boots	10069
1984-1979	8 Cyl. 7.4L; 8.5mm High Performance Wire	10001
1982-1979	8 Cyl. 5.7L; 9.0mm High Performance Wire	10034
1982-1979	8 Cyl. 5.7L; 8.5mm High Performance Wire	10002
1982-1979	8 Cyl. 5.7L; 8.5mm High Performance Wire; Equipped with Ceramic Spark Plug Boots	10053
1979	8 Cyl. 6.6L; 8.5mm High Performance Wire	10002
1979	8 Cyl. 6.6L; 8.5mm High Performance Wire; Equipped with Ceramic Spark Plug Boots	10053
1979	8 Cyl. 6.6L; 9.0mm High Performance Wire	10034
C3500HD		
2000-1996	8 Cyl. 7.4L; 8.5mm High Performance Wire	10070
2000-1996	8 Cyl. 7.4L; 8.5mm High Performance Wire; Equipped with Ceramic Spark Plug Boots	10071
1995-1991	8 Cyl. 5.7L; 8.5mm High Performance Wire	10018
1995-1991	8 Cyl. 5.7L; 8.5mm High Performance Wire; Equipped with Ceramic Spark Plug Boots	10046
1995-1991	8 Cyl. 5.7L; 9.0mm High Performance Wire	10038
1995-1991	8 Cyl. 7.4L; 8.5mm High Performance Wire	10050

Wire Sets

Year	Model/Engine	Part No.
Spark Plug Wire Set		
C3500HD		
1995-1991	8 Cyl. 7.4L; 8.5mm High Performance Wire; Equipped with Ceramic Spark Plug Boots	10051
C5000		
1990	8 Cyl. 6.0L; 8.5mm High Performance Wire; Carb.; Equipped with Ceramic Spark Plug Boots	10065
1990	8 Cyl. 6.0L; 8.5mm High Performance Wire; Carb.	10064
1989-1986	8 Cyl. 6.0L; 8.5mm High Performance Wire	10064
1989-1986	8 Cyl. 6.0L; 8.5mm High Performance Wire; Equipped with Ceramic Spark Plug Boots	10065
1988-1986	8 Cyl. 7.0L; 8.5mm High Performance Wire	10064
1988-1986	8 Cyl. 7.0L; 8.5mm High Performance Wire; Equipped with Ceramic Spark Plug Boots	10065
C5000 Topkick		
1990	8 Cyl. 6.0L; 8.5mm High Performance Wire; Carb.	10064
1990	8 Cyl. 6.0L; 8.5mm High Performance Wire; Carb.; Equipped with Ceramic Spark Plug Boots	10065
C6000		
1990-1989	8 Cyl. 6.0L; 8.5mm High Performance Wire; Carb.	10064
1990-1989	8 Cyl. 6.0L; 8.5mm High Performance Wire; Carb.; Equipped with Ceramic Spark Plug Boots	10065
1989-1983	8 Cyl. 7.0L; 8.5mm High Performance Wire	10064
1989-1983	8 Cyl. 7.0L; 8.5mm High Performance Wire; Equipped with Ceramic Spark Plug Boots	10065
1988-1983	8 Cyl. 6.0L; 8.5mm High Performance Wire	10064
1988-1983	8 Cyl. 6.0L; 8.5mm High Performance Wire; Equipped with Ceramic Spark Plug Boots	10065
C6000 Topkick		
1990	8 Cyl. 6.0L; 8.5mm High Performance Wire; Carb.	10064
1990	8 Cyl. 6.0L; 8.5mm High Performance Wire; Carb.; Equipped with Ceramic Spark Plug Boots	10065
C6500 Topkick		
2000-1999	8 Cyl. 7.4L; 8.5mm High Performance Wire	10074
2000-1999	8 Cyl. 7.4L; 8.5mm High Performance Wire; Equipped with Ceramic Spark Plug Boots	10075
C7000		
1990-1989	8 Cyl. 6.0L; 8.5mm High Performance Wire; Carb.; Equipped with Ceramic Spark Plug Boots	10065
1990-1989	8 Cyl. 6.0L; 8.5mm High Performance Wire; Carb.	10064
1989-1986	8 Cyl. 7.0L; 8.5mm High Performance Wire	10064
1989-1986	8 Cyl. 7.0L; 8.5mm High Performance Wire; Equipped with Ceramic Spark Plug Boots	10065
1988-1986	8 Cyl. 6.0L; 8.5mm High Performance Wire	10064
1988-1986	8 Cyl. 6.0L; 8.5mm High Performance Wire; Equipped with Ceramic Spark Plug Boots	10065

Year	Model/Engine	Part No.
Spark Plug Wire Set		
C7000 Topkick		
1990	8 Cyl. 6.0L; 8.5mm High Performance Wire; Carb.; Equipped with Ceramic Spark Plug Boots	10065
1990	8 Cyl. 6.0L; 8.5mm High Performance Wire; Carb.	10064
C7500 Topkick		
2000-1999	8 Cyl. 7.4L; 8.5mm High Performance Wire	10074
2000-1999	8 Cyl. 7.4L; 8.5mm High Performance Wire; Equipped with Ceramic Spark Plug Boots	10075
Caballero		
1986-1978	8 Cyl. 5.0L; 9.0mm High Performance Wire	10037
1986-1978	8 Cyl. 5.0L; 8.5mm High Performance Wire	10010
1986-1978	8 Cyl. 5.0L; 8.5mm High Performance Wire; Equipped with Ceramic Spark Plug Boots	10056
1982-1979	8 Cyl. 4.4L; 8.5mm High Performance Wire; Equipped with Ceramic Spark Plug Boots	10056
1982-1979	8 Cyl. 4.4L; 8.5mm High Performance Wire	10010
1982-1979	8 Cyl. 4.4L; 9.0mm High Performance Wire	10037
1979-1978	8 Cyl. 5.7L; 8.5mm High Performance Wire	10010
1979-1978	8 Cyl. 5.7L; 8.5mm High Performance Wire; Equipped with Ceramic Spark Plug Boots	10056
1979-1978	8 Cyl. 5.7L; 9.0mm High Performance Wire	10037
Canyon		
2012-2009	8 Cyl. 5.3L; 9.0mm High Performance Wire	10039
2012-2009	8 Cyl. 5.3L; 8.5mm High Performance Wire	10026
Envoy		
2009	8 Cyl. 5.3L; 9.0mm High Performance Wire	10039
2009	8 Cyl. 5.3L; 8.5mm High Performance Wire	10026
2008-2005	8 Cyl. 5.3L; 9.0mm High Performance Wire	10042
2008-2005	8 Cyl. 5.3L; 8.5mm High Performance Wire	10041
Envoy XL		
2006-2003	8 Cyl. 5.3L; 8.5mm High Performance Wire	10041
2006-2003	8 Cyl. 5.3L; 9.0mm High Performance Wire	10042
Envoy XUV		
2005-2004	8 Cyl. 5.3L; 9.0mm High Performance Wire	10042
2005-2004	8 Cyl. 5.3L; 8.5mm High Performance Wire	10041
G15/G1500 Van		
1974	8 Cyl. 5.7L; 8.5mm High Performance Wire; Routed Over Valve Cover	10007
1974	8 Cyl. 5.7L; 8.5mm High Performance Wire; Equipped with Ceramic Spark Plug Boots; Routed Over Valve Cover	10079
G25/G2500 Van		
1974	8 Cyl. 5.7L; 8.5mm High Performance Wire; Routed Over Valve Cover	10007

Wire Sets

Year	Model/Engine	Part No.
Spark Plug Wire Set		
G25/G2500 Van		
1974	8 Cyl. 5.7L; 8.5mm High Performance Wire; Equipped with Ceramic Spark Plug Boots; Routed Over Valve Cover	10079
G35/G3500 Van		
1974-1971	8 Cyl. 5.7L; 8.5mm High Performance Wire; Routed Over Valve Cover	10007
1974-1971	8 Cyl. 5.7L; 8.5mm High Performance Wire; Equipped with Ceramic Spark Plug Boots; Routed Over Valve Cover	10079
1967	8 Cyl. 5.3L; 8.5mm High Performance Wire; Routed Under Exhaust Manifold	10005
1967	8 Cyl. 5.3L; 8.5mm High Performance Wire; Equipped with Ceramic Spark Plug Boots; Routed Under Exhaust Manifold	10080
G1500		
1995-1987	8 Cyl. 5.0L; 8.5mm High Performance Wire; Equipped with Ceramic Spark Plug Boots	10046
1995-1987	8 Cyl. 5.0L; 8.5mm High Performance Wire	10018
1993-1987	8 Cyl. 5.7L; 8.5mm High Performance Wire; Equipped with Ceramic Spark Plug Boots	10046
1993-1987	8 Cyl. 5.7L; 8.5mm High Performance Wire	10018
G2500		
1995-1987	8 Cyl. 5.0L; 8.5mm High Performance Wire; Equipped with Ceramic Spark Plug Boots	10046
1995-1987	8 Cyl. 5.7L; 8.5mm High Performance Wire	10018
1995-1987	8 Cyl. 5.7L; 8.5mm High Performance Wire; Equipped with Ceramic Spark Plug Boots	10046
1995-1987	8 Cyl. 5.0L; 8.5mm High Performance Wire	10018
G3500		
1996	8 Cyl. 7.4L; 8.5mm High Performance Wire; EFI; Equipped with Ceramic Spark Plug Boots	10051
1996	8 Cyl. 7.4L; 8.5mm High Performance Wire; TBI	10070
1996	8 Cyl. 7.4L; 8.5mm High Performance Wire; EFI	10050
1996	8 Cyl. 7.4L; 8.5mm High Performance Wire; Equipped with Ceramic Spark Plug Boots; TBI	10071
1996-1989	8 Cyl. 5.7L; 8.5mm High Performance Wire; Equipped with Ceramic Spark Plug Boots	10046
1996-1989	8 Cyl. 5.7L; 8.5mm High Performance Wire	10018
1995-1988	8 Cyl. 7.4L; 8.5mm High Performance Wire	10050
1995-1988	8 Cyl. 7.4L; 8.5mm High Performance Wire; Equipped with Ceramic Spark Plug Boots	10051
1988-1987	8 Cyl. 5.7L; 8.5mm High Performance Wire; TBI	10018
1988-1987	8 Cyl. 5.7L; 8.5mm High Performance Wire; Equipped with Ceramic Spark Plug Boots; TBI	10046
Jimmy		
2005-2002	6 Cyl. 4.3L; 8.5mm High Performance Wire; Equipped with Ceramic Spark Plug Boots	10078
2005-2002	6 Cyl. 4.3L; 8.5mm High Performance Wire	10077

Year	Model/Engine	Part No.
Spark Plug Wire Set		
Jimmy		
2001-1996	6 Cyl. 4.3L; 8.5mm High Performance Wire	10077
2001-1996	6 Cyl. 4.3L; 8.5mm High Performance Wire; Equipped with Ceramic Spark Plug Boots	10078
1995	6 Cyl. 4.3L; 8.5mm High Performance Wire; Vertical Towers	10014
1995	6 Cyl. 4.3L; 8.5mm High Performance Wire; Equipped with Ceramic Spark Plug Boots; Vertical Towers	10076
1994-1992	6 Cyl. 4.3L; 8.5mm High Performance Wire; Equipped with Ceramic Spark Plug Boots	10076
1994-1992	6 Cyl. 4.3L; 8.5mm High Performance Wire	10014
1991-1987	8 Cyl. 5.7L; 9.0mm High Performance Wire	10038
1991-1987	8 Cyl. 5.7L; 8.5mm High Performance Wire; Equipped with Ceramic Spark Plug Boots	10046
1991-1987	8 Cyl. 5.7L; 8.5mm High Performance Wire	10018
1987	8 Cyl. 5.0L; 8.5mm High Performance Wire	10018
1987	8 Cyl. 5.0L; 8.5mm High Performance Wire; Equipped with Ceramic Spark Plug Boots	10046
1987	8 Cyl. 5.0L; 9.0mm High Performance Wire	10038
1986-1983	8 Cyl. 5.0L; 8.5mm High Performance Wire; Equipped with Ceramic Spark Plug Boots	10056
1986-1981	8 Cyl. 5.0L; 8.5mm High Performance Wire	10010
1986-1981	8 Cyl. 5.7L; 9.0mm High Performance Wire	10037
1986-1981	8 Cyl. 5.7L; 8.5mm High Performance Wire	10010
1986-1981	8 Cyl. 5.0L; 9.0mm High Performance Wire	10037
1986-1981	8 Cyl. 5.7L; 8.5mm High Performance Wire; Equipped with Ceramic Spark Plug Boots	10056
1981	8 Cyl. 5.0L; 8.5mm High Performance Wire; Equipped with Ceramic Spark Plug Boots	10056
1980-1977	8 Cyl. 5.0L; 8.5mm High Performance Wire	10002
1980-1977	8 Cyl. 5.0L; 8.5mm High Performance Wire; Equipped with Ceramic Spark Plug Boots	10053
1980-1977	8 Cyl. 5.0L; 9.0mm High Performance Wire	10034
1980-1975	8 Cyl. 5.7L; 9.0mm High Performance Wire	10034
1980-1975	8 Cyl. 5.7L; 8.5mm High Performance Wire	10002
1980-1975	8 Cyl. 5.7L; 8.5mm High Performance Wire; Equipped with Ceramic Spark Plug Boots	10053
1979-1975	8 Cyl. 6.6L; 8.5mm High Performance Wire; Equipped with Ceramic Spark Plug Boots	10053
1979-1975	8 Cyl. 6.6L; 9.0mm High Performance Wire	10034
1979-1975	8 Cyl. 6.6L; 8.5mm High Performance Wire	10002
1976	8 Cyl. 7.4L; 8.5mm High Performance Wire; Equipped with Ceramic Spark Plug Boots; w/o AC	10069

Wire Sets

Year	Model/Engine	Part No.
Spark Plug Wire Set		
Jimmy		
1976	8 Cyl. 7.4L; 8.5mm High Performance Wire; w/o AC	10001
1974-1970	8 Cyl. 5.7L; 8.5mm High Performance Wire; Routed Over Valve Cover	10007
1974-1970	8 Cyl. 5.7L; 8.5mm High Performance Wire; Equipped with Ceramic Spark Plug Boots; Routed Over Valve Cover	10079
1973	8 Cyl. 7.4L; 8.5mm High Performance Wire; Equipped with Ceramic Spark Plug Boots	10114
1973	8 Cyl. 7.4L; 8.5mm High Performance Wire; w/ Straight Non-Bendable Spark Plug Boot	10006
1973	8 Cyl. 7.4L; 8.5mm High Performance Wire; w/ Straight Bendable Spark Plug Boot	10116
1972-1970	8 Cyl. 5.0L; 8.5mm High Performance Wire; Equipped with Ceramic Spark Plug Boots; Routed Over Valve Cover	10079
1972-1970	8 Cyl. 5.0L; 8.5mm High Performance Wire; Routed Over Valve Cover	10007
K15		
1978-1976	8 Cyl. 5.0L; 8.5mm High Performance Wire	10002
1978-1976	8 Cyl. 5.0L; 8.5mm High Performance Wire; Equipped with Ceramic Spark Plug Boots	10053
1978-1976	8 Cyl. 5.0L; 9.0mm High Performance Wire	10034
1978-1975	8 Cyl. 6.6L; 8.5mm High Performance Wire; Equipped with Ceramic Spark Plug Boots	10053
1978-1975	8 Cyl. 5.7L; 9.0mm High Performance Wire	10034
1978-1975	8 Cyl. 6.6L; 8.5mm High Performance Wire	10002
1978-1975	8 Cyl. 6.6L; 9.0mm High Performance Wire	10034
1978-1975	8 Cyl. 5.7L; 8.5mm High Performance Wire	10002
1978-1975	8 Cyl. 5.7L; 8.5mm High Performance Wire; Equipped with Ceramic Spark Plug Boots	10053
1976	8 Cyl. 7.4L; 8.5mm High Performance Wire; Equipped with Ceramic Spark Plug Boots; w/o AC	10069
1976	8 Cyl. 7.4L; 8.5mm High Performance Wire; w/o AC	10001
K15 Suburban		
1978-1976	8 Cyl. 5.0L; 9.0mm High Performance Wire	10034
1978-1976	8 Cyl. 5.0L; 8.5mm High Performance Wire; Equipped with Ceramic Spark Plug Boots	10053
1978-1976	8 Cyl. 5.0L; 8.5mm High Performance Wire	10002
1978-1975	8 Cyl. 5.7L; 8.5mm High Performance Wire; Equipped with Ceramic Spark Plug Boots	10053
1978-1975	8 Cyl. 6.6L; 8.5mm High Performance Wire	10002
1978-1975	8 Cyl. 5.7L; 8.5mm High Performance Wire	10002
1978-1975	8 Cyl. 5.7L; 9.0mm High Performance Wire	10034
1978-1975	8 Cyl. 6.6L; 9.0mm High Performance Wire	10034
1978-1975	8 Cyl. 6.6L; 8.5mm High Performance Wire; Equipped with Ceramic Spark Plug Boots	10053

Year	Model/Engine	Part No.
Spark Plug Wire Set		
K15/K1500 Pickup		
1974-1973	8 Cyl. 7.4L; 8.5mm High Performance Wire; Equipped with Ceramic Spark Plug Boots	10114
1974-1973	8 Cyl. 7.4L; 8.5mm High Performance Wire; w/ Straight Non-Bendable Spark Plug Boot	10006
1974-1973	8 Cyl. 7.4L; 8.5mm High Performance Wire; w/ Straight Bendable Spark Plug Boot	10116
1974-1971	8 Cyl. 5.7L; 8.5mm High Performance Wire; Routed Over Valve Cover	10007
1974-1971	8 Cyl. 5.7L; 8.5mm High Performance Wire; Equipped with Ceramic Spark Plug Boots; Routed Over Valve Cover	10079
1973-1971	8 Cyl. 5.0L; 8.5mm High Performance Wire; Equipped with Ceramic Spark Plug Boots; Routed Over Valve Cover	10079
1973-1971	8 Cyl. 5.0L; 8.5mm High Performance Wire; Routed Over Valve Cover	10007
1972	8 Cyl. 6.6L; 8.5mm High Performance Wire; Routed Over Valve Cover	10007
1972	8 Cyl. 6.6L; 8.5mm High Performance Wire; Equipped with Ceramic Spark Plug Boots; Routed Over Valve Cover	10079
1971-1970	8 Cyl. 6.6L; 8.5mm High Performance Wire; w/ Straight Non-Bendable Spark Plug Boot	10006
1971-1970	8 Cyl. 6.6L; 8.5mm High Performance Wire; Equipped with Ceramic Spark Plug Boots	10114
1971-1970	8 Cyl. 6.6L; 8.5mm High Performance Wire; w/ Straight Bendable Spark Plug Boot	10116
1970-1969	8 Cyl. 5.7L; 8.5mm High Performance Wire; Routed Under Exhaust Manifold	10005
1970-1969	8 Cyl. 5.7L; 8.5mm High Performance Wire; Equipped with Ceramic Spark Plug Boots; Routed Under Exhaust Manifold	10080
1970-1968	8 Cyl. 5.0L; 8.5mm High Performance Wire; Equipped with Ceramic Spark Plug Boots; Routed Under Exhaust Manifold	10080
1970-1968	8 Cyl. 5.0L; 8.5mm High Performance Wire; Routed Under Exhaust Manifold	10005
1969	8 Cyl. 6.5L; 8.5mm High Performance Wire; w/ Straight Non-Bendable Spark Plug Boot	10006
1969	8 Cyl. 6.5L; 8.5mm High Performance Wire; Equipped with Ceramic Spark Plug Boots	10114
1969	8 Cyl. 6.5L; 8.5mm High Performance Wire; w/ Straight Bendable Spark Plug Boot	10116
1968	8 Cyl. 5.4L; 8.5mm High Performance Wire; Equipped with Ceramic Spark Plug Boots; Routed Under Exhaust Manifold	10080
1968	8 Cyl. 5.4L; 8.5mm High Performance Wire; Routed Under Exhaust Manifold	10005
1968	8 Cyl. 6.5L; 8.5mm High Performance Wire; Equipped with Ceramic Spark Plug Boots; Routed Under Exhaust Manifold	10080
1968	8 Cyl. 6.5L; 8.5mm High Performance Wire; Routed Under Exhaust Manifold	10005
1967	8 Cyl. 4.6L; 8.5mm High Performance Wire; Routed Under Exhaust Manifold	10005
1967	8 Cyl. 4.6L; 8.5mm High Performance Wire; Equipped with Ceramic Spark Plug Boots; Routed Under Exhaust Manifold	10080
K15/K1500 Suburban		
1974-1973	8 Cyl. 7.4L; 8.5mm High Performance Wire; Equipped with Ceramic Spark Plug Boots	10114

Wire Sets

Year	Model/Engine	Part No.
Spark Plug Wire Set		
K15/K1500 Suburban		
1974-1973	8 Cyl. 7.4L; 8.5mm High Performance Wire; w/ Straight Non-Bendable Spark Plug Boot	10006
1974-1973	8 Cyl. 7.4L; 8.5mm High Performance Wire; w/ Straight Bendable Spark Plug Boot	10116
1974-1971	8 Cyl. 5.7L; 8.5mm High Performance Wire; Routed Over Valve Cover	10007
1974-1971	8 Cyl. 5.7L; 8.5mm High Performance Wire; Equipped with Ceramic Spark Plug Boots; Routed Over Valve Cover	10079
1973-1971	8 Cyl. 5.0L; 8.5mm High Performance Wire; Routed Over Valve Cover	10007
1973-1971	8 Cyl. 5.0L; 8.5mm High Performance Wire; Equipped with Ceramic Spark Plug Boots; Routed Over Valve Cover	10079
1972	8 Cyl. 6.6L; 8.5mm High Performance Wire; Routed Over Valve Cover	10007
1972	8 Cyl. 6.6L; 8.5mm High Performance Wire; Equipped with Ceramic Spark Plug Boots; Routed Over Valve Cover	10079
1971	8 Cyl. 6.6L; 8.5mm High Performance Wire; Equipped with Ceramic Spark Plug Boots	10114
1971	8 Cyl. 6.6L; 8.5mm High Performance Wire; w/ Straight Non-Bendable Spark Plug Boot	10006
1971	8 Cyl. 6.6L; 8.5mm High Performance Wire; w/ Straight Bendable Spark Plug Boot	10116
1970	8 Cyl. 6.6L; 8.5mm High Performance Wire; Routed Under Exhaust Manifold	10005
1970	8 Cyl. 6.6L; 8.5mm High Performance Wire; Equipped with Ceramic Spark Plug Boots; Routed Under Exhaust Manifold	10080
1970-1969	8 Cyl. 5.7L; 8.5mm High Performance Wire; Routed Under Exhaust Manifold	10005
1970-1969	8 Cyl. 5.7L; 8.5mm High Performance Wire; Equipped with Ceramic Spark Plug Boots; Routed Under Exhaust Manifold	10080
1970-1968	8 Cyl. 5.0L; 8.5mm High Performance Wire; Routed Under Exhaust Manifold	10005
1970-1968	8 Cyl. 5.0L; 8.5mm High Performance Wire; Equipped with Ceramic Spark Plug Boots; Routed Under Exhaust Manifold	10080
1969-1968	8 Cyl. 6.5L; 8.5mm High Performance Wire; w/ Straight Non-Bendable Spark Plug Boot	10006
1969-1968	8 Cyl. 6.5L; 8.5mm High Performance Wire; Equipped with Ceramic Spark Plug Boots	10114
1969-1968	8 Cyl. 6.5L; 8.5mm High Performance Wire; w/ Straight Bendable Spark Plug Boot	10116
1968	8 Cyl.; 327; 8.5mm High Performance Wire; Routed Under Exhaust Manifold	10005
1968	8 Cyl.; 327; 8.5mm High Performance Wire; Equipped with Ceramic Spark Plug Boots; Routed Under Exhaust Manifold	10080
1967	8 Cyl. 4.6L; 8.5mm High Performance Wire; Routed Under Exhaust Manifold	10005
1967	8 Cyl. 4.6L; 8.5mm High Performance Wire; Equipped with Ceramic Spark Plug Boots; Routed Under Exhaust Manifold	10080
K25		
1978-1977	8 Cyl. 5.0L; 8.5mm High Performance Wire	10002
1978-1977	8 Cyl. 7.4L; 8.5mm High Performance Wire; Equipped with Ceramic Spark Plug Boots	10069

Year	Model/Engine	Part No.
Spark Plug Wire Set		
K25		
1978-1977	8 Cyl. 5.0L; 8.5mm High Performance Wire; Equipped with Ceramic Spark Plug Boots	10053
1978-1977	8 Cyl. 7.4L; 8.5mm High Performance Wire	10001
1978-1977	8 Cyl. 5.0L; 9.0mm High Performance Wire	10034
1978-1975	8 Cyl. 5.7L; 9.0mm High Performance Wire	10034
1978-1975	8 Cyl. 6.6L; 9.0mm High Performance Wire	10034
1978-1975	8 Cyl. 5.7L; 8.5mm High Performance Wire	10002
1978-1975	8 Cyl. 6.6L; 8.5mm High Performance Wire	10002
1978-1975	8 Cyl. 5.7L; 8.5mm High Performance Wire; Equipped with Ceramic Spark Plug Boots	10053
1978-1975	8 Cyl. 6.6L; 8.5mm High Performance Wire; Equipped with Ceramic Spark Plug Boots	10053
1976	8 Cyl. 7.4L; 8.5mm High Performance Wire; w/o AC	10001
1976	8 Cyl. 7.4L; 8.5mm High Performance Wire; Equipped with Ceramic Spark Plug Boots; w/o AC	10069
K25 Suburban		
1978-1977	8 Cyl. 5.0L; 8.5mm High Performance Wire; Equipped with Ceramic Spark Plug Boots	10053
1978-1977	8 Cyl. 5.0L; 8.5mm High Performance Wire	10002
1978-1977	8 Cyl. 5.0L; 9.0mm High Performance Wire	10034
1978-1975	8 Cyl. 6.6L; 9.0mm High Performance Wire	10034
1978-1975	8 Cyl. 5.7L; 8.5mm High Performance Wire; Equipped with Ceramic Spark Plug Boots	10053
1978-1975	8 Cyl. 6.6L; 8.5mm High Performance Wire; Equipped with Ceramic Spark Plug Boots	10053
1978-1975	8 Cyl. 5.7L; 9.0mm High Performance Wire	10034
1978-1975	8 Cyl. 5.7L; 8.5mm High Performance Wire	10002
1978-1975	8 Cyl. 6.6L; 8.5mm High Performance Wire	10002
1977	8 Cyl. 7.4L; 8.5mm High Performance Wire; Equipped with Ceramic Spark Plug Boots	10069
1977	8 Cyl. 7.4L; 8.5mm High Performance Wire	10001
1976	8 Cyl. 7.4L; 8.5mm High Performance Wire; w/o AC	10001
1976	8 Cyl. 7.4L; 8.5mm High Performance Wire; Equipped with Ceramic Spark Plug Boots; w/o AC	10069
K25/K2500 Pickup		
1974	8 Cyl. 5.7L; 8.5mm High Performance Wire; Equipped with Ceramic Spark Plug Boots; Routed Over Valve Cover	10079
1974-1973	8 Cyl. 7.4L; 8.5mm High Performance Wire; Equipped with Ceramic Spark Plug Boots	10114
1974-1973	8 Cyl. 7.4L; 8.5mm High Performance Wire; w/ Straight Non-Bendable Spark Plug Boot	10006

Wire Sets

Year	Model/Engine	Part No.
Spark Plug Wire Set		
K25/K2500 Pickup		
1974-1973	8 Cyl. 7.4L; 8.5mm High Performance Wire; w/ Straight Bendable Spark Plug Boot	10116
1974-1971	8 Cyl. 5.7L; 8.5mm High Performance Wire; Routed Over Valve Cover	10007
1973-1971	8 Cyl. 5.0L; 8.5mm High Performance Wire; Equipped with Ceramic Spark Plug Boots; Routed Over Valve Cover	10079
1973-1971	8 Cyl. 5.0L; 8.5mm High Performance Wire; Routed Over Valve Cover	10007
1972	8 Cyl. 6.6L; 8.5mm High Performance Wire; Equipped with Ceramic Spark Plug Boots; Routed Over Valve Cover	10079
1972	8 Cyl. 6.6L; 8.5mm High Performance Wire; Routed Over Valve Cover	10007
1972-1971	8 Cyl. 5.7L; 8.5mm High Performance Wire; Equipped with Ceramic Spark Plug Boots; Routed Over Valve Cover	10079
1971-1970	8 Cyl. 6.6L; 8.5mm High Performance Wire; Equipped with Ceramic Spark Plug Boots	10114
1971-1970	8 Cyl. 6.6L; 8.5mm High Performance Wire; w/ Straight Non-Bendable Spark Plug Boot	10006
1971-1970	8 Cyl. 6.6L; 8.5mm High Performance Wire; w/ Straight Bendable Spark Plug Boot	10116
1970-1969	8 Cyl. 5.7L; 8.5mm High Performance Wire; Routed Under Exhaust Manifold	10005
1970-1969	8 Cyl. 5.7L; 8.5mm High Performance Wire; Equipped with Ceramic Spark Plug Boots; Routed Under Exhaust Manifold	10080
1969	8 Cyl. 5.7L; 8.5mm High Performance Wire; Equipped with Ceramic Spark Plug Boots; Routed Over Valve Cover	10079
1969	8 Cyl. 6.5L; 8.5mm High Performance Wire; w/ Straight Non-Bendable Spark Plug Boot	10006
1969	8 Cyl. 6.5L; 8.5mm High Performance Wire; w/ Straight Bendable Spark Plug Boot	10116
1969-1968	8 Cyl. 6.5L; 8.5mm High Performance Wire; Equipped with Ceramic Spark Plug Boots	10114
1969-1968	8 Cyl. 5.0L; 8.5mm High Performance Wire; Routed Under Exhaust Manifold	10005
1969-1968	8 Cyl. 5.0L; 8.5mm High Performance Wire; Equipped with Ceramic Spark Plug Boots; Routed Under Exhaust Manifold	10080
1968	8 Cyl. 6.5L; 8.5mm High Performance Wire; Equipped with Ceramic Spark Plug Boots; Routed Under Exhaust Manifold	10080
1968	8 Cyl. 6.5L; 8.5mm High Performance Wire; Routed Under Exhaust Manifold	10005
1968	8 Cyl. 5.4L; 8.5mm High Performance Wire; Routed Under Exhaust Manifold	10005
1968	8 Cyl. 5.4L; 8.5mm High Performance Wire; Equipped with Ceramic Spark Plug Boots; Routed Under Exhaust Manifold	10080
1967	8 Cyl. 4.6L; 8.5mm High Performance Wire; Routed Under Exhaust Manifold	10005
1967	8 Cyl. 4.6L; 8.5mm High Performance Wire; Equipped with Ceramic Spark Plug Boots; Routed Under Exhaust Manifold	10080
K25/K2500 Suburban		
1974-1973	8 Cyl. 7.4L; 8.5mm High Performance Wire; Equipped with Ceramic Spark Plug Boots	10114
1974-1973	8 Cyl. 7.4L; 8.5mm High Performance Wire; w/ Straight Non-Bendable Spark Plug Boot	10006

Year	Model/Engine	Part No.
Spark Plug Wire Set		
K25/K2500 Suburban		
1974-1973	8 Cyl. 7.4L; 8.5mm High Performance Wire; w/ Straight Bendable Spark Plug Boot	10116
1974-1971	8 Cyl. 5.7L; 8.5mm High Performance Wire; Routed Over Valve Cover	10007
1974-1971	8 Cyl. 5.7L; 8.5mm High Performance Wire; Equipped with Ceramic Spark Plug Boots; Routed Over Valve Cover	10079
1973-1971	8 Cyl. 5.0L; 8.5mm High Performance Wire; Equipped with Ceramic Spark Plug Boots; Routed Over Valve Cover	10079
1973-1971	8 Cyl. 5.0L; 8.5mm High Performance Wire; Routed Over Valve Cover	10007
1972	8 Cyl. 6.6L; 8.5mm High Performance Wire; Equipped with Ceramic Spark Plug Boots; Routed Over Valve Cover	10079
1972	8 Cyl. 6.6L; 8.5mm High Performance Wire; Routed Over Valve Cover	10007
1971	8 Cyl. 6.6L; 8.5mm High Performance Wire; Equipped with Ceramic Spark Plug Boots	10114
1971	8 Cyl. 6.6L; 8.5mm High Performance Wire; w/ Straight Non-Bendable Spark Plug Boot	10006
1971	8 Cyl. 6.6L; 8.5mm High Performance Wire; w/ Straight Bendable Spark Plug Boot	10116
1970	8 Cyl. 6.6L; 8.5mm High Performance Wire; Equipped with Ceramic Spark Plug Boots; Routed Under Exhaust Manifold	10080
1970	8 Cyl. 6.6L; 8.5mm High Performance Wire; Routed Under Exhaust Manifold	10005
1970-1969	8 Cyl. 5.7L; 8.5mm High Performance Wire; Routed Under Exhaust Manifold	10005
1970-1969	8 Cyl. 5.7L; 8.5mm High Performance Wire; Equipped with Ceramic Spark Plug Boots; Routed Under Exhaust Manifold	10080
1970-1968	8 Cyl. 5.0L; 8.5mm High Performance Wire; Routed Under Exhaust Manifold	10005
1970-1968	8 Cyl. 5.0L; 8.5mm High Performance Wire; Equipped with Ceramic Spark Plug Boots; Routed Under Exhaust Manifold	10080
1969-1968	8 Cyl. 6.5L; 8.5mm High Performance Wire; w/ Straight Non-Bendable Spark Plug Boot	10006
1969-1968	8 Cyl. 6.5L; 8.5mm High Performance Wire; Equipped with Ceramic Spark Plug Boots	10114
1969-1968	8 Cyl. 6.5L; 8.5mm High Performance Wire; w/ Straight Bendable Spark Plug Boot	10116
1968	8 Cyl.; 327; 8.5mm High Performance Wire; Equipped with Ceramic Spark Plug Boots; Routed Under Exhaust Manifold	10080
1968	8 Cyl.; 327; 8.5mm High Performance Wire; Routed Under Exhaust Manifold	10005
K35		
1978-1977	8 Cyl. 5.7L; 9.0mm High Performance Wire	10034
1978-1977	8 Cyl. 6.6L; 8.5mm High Performance Wire; Equipped with Ceramic Spark Plug Boots	10053
1978-1977	8 Cyl. 6.6L; 8.5mm High Performance Wire	10002
1978-1977	8 Cyl. 5.7L; 8.5mm High Performance Wire; Equipped with Ceramic Spark Plug Boots	10053
1978-1977	8 Cyl. 6.6L; 9.0mm High Performance Wire	10034

Wire Sets

Year	Model/Engine	Part No.
Spark Plug Wire Set		
K35		
1978-1977	8 Cyl. 5.7L; 8.5mm High Performance Wire	10002
K35/K3500 Pickup		
1974-1973	8 Cyl. 7.4L; 8.5mm High Performance Wire; Equipped with Ceramic Spark Plug Boots	10114
1974-1973	8 Cyl. 7.4L; 8.5mm High Performance Wire; w/ Straight Non-Bendable Spark Plug Boot	10006
1974-1973	8 Cyl. 7.4L; 8.5mm High Performance Wire; w/ Straight Bendable Spark Plug Boot	10116
1974-1971	8 Cyl. 5.7L; 8.5mm High Performance Wire; Equipped with Ceramic Spark Plug Boots; Routed Over Valve Cover	10079
1974-1971	8 Cyl. 5.7L; 8.5mm High Performance Wire; Routed Over Valve Cover	10007
1973-1971	8 Cyl. 5.0L; 8.5mm High Performance Wire; Equipped with Ceramic Spark Plug Boots; Routed Over Valve Cover	10079
1973-1971	8 Cyl. 5.0L; 8.5mm High Performance Wire; Routed Over Valve Cover	10007
1972	8 Cyl. 6.6L; 8.5mm High Performance Wire; Equipped with Ceramic Spark Plug Boots; Routed Over Valve Cover	10079
1972	8 Cyl. 6.6L; 8.5mm High Performance Wire; Routed Over Valve Cover	10007
1971-1970	8 Cyl. 6.6L; 8.5mm High Performance Wire; Equipped with Ceramic Spark Plug Boots	10114
1971-1970	8 Cyl. 6.6L; 8.5mm High Performance Wire; w/ Straight Non-Bendable Spark Plug Boot	10006
1971-1970	8 Cyl. 6.6L; 8.5mm High Performance Wire; w/ Straight Bendable Spark Plug Boot	10116
1970-1969	8 Cyl. 5.7L; 8.5mm High Performance Wire; Routed Under Exhaust Manifold	10005
1970-1969	8 Cyl. 5.7L; 8.5mm High Performance Wire; Equipped with Ceramic Spark Plug Boots; Routed Under Exhaust Manifold	10080
1970-1968	8 Cyl. 5.0L; 8.5mm High Performance Wire; Routed Under Exhaust Manifold	10005
1970-1968	8 Cyl. 5.0L; 8.5mm High Performance Wire; Equipped with Ceramic Spark Plug Boots; Routed Under Exhaust Manifold	10080
1969-1968	8 Cyl. 6.5L; 8.5mm High Performance Wire; w/ Straight Non-Bendable Spark Plug Boot	10006
1969-1968	8 Cyl. 6.5L; 8.5mm High Performance Wire; Equipped with Ceramic Spark Plug Boots	10114
1969-1968	8 Cyl. 6.5L; 8.5mm High Performance Wire; w/ Straight Bendable Spark Plug Boot	10116
1968	8 Cyl. 5.4L; 8.5mm High Performance Wire; Routed Under Exhaust Manifold	10005
1968	8 Cyl. 5.4L; 8.5mm High Performance Wire; Equipped with Ceramic Spark Plug Boots; Routed Under Exhaust Manifold	10080
1967	8 Cyl. 4.6L; 8.5mm High Performance Wire; Routed Under Exhaust Manifold	10005
1967	8 Cyl. 4.6L; 8.5mm High Performance Wire; Equipped with Ceramic Spark Plug Boots; Routed Under Exhaust Manifold	10080
K1500		
1999-1996	8 Cyl. 5.7L; 8.5mm High Performance Wire	10021
1999-1996	8 Cyl. 5.0L; 8.5mm High Performance Wire	10021

Year	Model/Engine	Part No.
Spark Plug Wire Set		
K1500		
1999-1996	8 Cyl. 5.0L; 8.5mm High Performance Wire; Equipped with Ceramic Spark Plug Boots	10072
1999-1996	8 Cyl. 5.7L; 8.5mm High Performance Wire; Equipped with Ceramic Spark Plug Boots	10072
1998-1996	6 Cyl. 4.3L; 8.5mm High Performance Wire	10077
1998-1996	6 Cyl. 4.3L; 8.5mm High Performance Wire; Equipped with Ceramic Spark Plug Boots	10078
1995-1988	6 Cyl. 4.3L; 8.5mm High Performance Wire	10014
1995-1988	8 Cyl. 5.7L; 8.5mm High Performance Wire	10018
1995-1988	8 Cyl. 5.0L; 9.0mm High Performance Wire	10038
1995-1988	8 Cyl. 5.7L; 9.0mm High Performance Wire	10038
1995-1988	6 Cyl. 4.3L; 8.5mm High Performance Wire; Equipped with Ceramic Spark Plug Boots	10076
1995-1988	8 Cyl. 5.0L; 8.5mm High Performance Wire	10018
1995-1988	8 Cyl. 5.0L; 8.5mm High Performance Wire; Equipped with Ceramic Spark Plug Boots	10046
1995-1988	8 Cyl. 5.7L; 8.5mm High Performance Wire; Equipped with Ceramic Spark Plug Boots	10046
1986	8 Cyl. 5.7L; L; 8.5mm High Performance Wire; Equipped with Ceramic Spark Plug Boots	10056
1986	8 Cyl. 5.7L; L; 9.0mm High Performance Wire	10037
1986	8 Cyl. 5.7L; L; 8.5mm High Performance Wire	10010
1986	8 Cyl. 5.7L; M; 8.5mm High Performance Wire; Calif.; Equipped with Ceramic Spark Plug Boots	10056
1986	8 Cyl. 5.7L; M; 8.5mm High Performance Wire; Calif.	10010
1986	8 Cyl. 5.7L; M; 9.0mm High Performance Wire; Fed.	10034
1986	8 Cyl. 5.7L; M; 9.0mm High Performance Wire; Calif.	10037
1986	8 Cyl. 5.7L; M; 8.5mm High Performance Wire; Equipped with Ceramic Spark Plug Boots; Fed.	10053
1986	8 Cyl. 5.7L; M; 8.5mm High Performance Wire; Fed.	10002
1986-1981	8 Cyl. 5.0L; 9.0mm High Performance Wire	10037
1986-1981	8 Cyl. 5.0L; 8.5mm High Performance Wire; Equipped with Ceramic Spark Plug Boots	10056
1986-1981	8 Cyl. 5.0L; 8.5mm High Performance Wire	10010
1985-1981	8 Cyl. 5.7L; 8.5mm High Performance Wire	10010
1985-1981	8 Cyl. 5.7L; 8.5mm High Performance Wire; Equipped with Ceramic Spark Plug Boots	10056
1985-1981	8 Cyl. 5.7L; 9.0mm High Performance Wire	10037
1980-1979	8 Cyl. 5.7L; 8.5mm High Performance Wire; Equipped with Ceramic Spark Plug Boots	10053
1980-1979	8 Cyl. 7.4L; 8.5mm High Performance Wire	10001

Wire Sets

Year	Model/Engine	Part No.
Spark Plug Wire Set		
K1500		
1980-1979	8 Cyl. 6.6L; 8.5mm High Performance Wire	10002
1980-1979	8 Cyl. 7.4L; 8.5mm High Performance Wire; Equipped with Ceramic Spark Plug Boots	10069
1980-1979	8 Cyl. 5.7L; 8.5mm High Performance Wire	10002
1980-1979	8 Cyl. 6.6L; 8.5mm High Performance Wire; Equipped with Ceramic Spark Plug Boots	10053
1980-1979	8 Cyl. 6.6L; 9.0mm High Performance Wire	10034
1980-1979	8 Cyl. 5.7L; 9.0mm High Performance Wire	10034
1979	8 Cyl. 5.0L; 9.0mm High Performance Wire	10034
1979	8 Cyl. 5.0L; 8.5mm High Performance Wire; Equipped with Ceramic Spark Plug Boots	10053
1979	8 Cyl. 5.0L; 8.5mm High Performance Wire	10002
K1500 Suburban		
1999-1996	8 Cyl. 5.7L; 8.5mm High Performance Wire	10021
1999-1996	8 Cyl. 5.7L; 8.5mm High Performance Wire; Equipped with Ceramic Spark Plug Boots	10072
1995-1992	8 Cyl. 5.7L; 8.5mm High Performance Wire; Equipped with Ceramic Spark Plug Boots	10046
1995-1992	8 Cyl. 5.7L; 8.5mm High Performance Wire	10018
1995-1992	8 Cyl. 5.7L; 9.0mm High Performance Wire	10038
1986	8 Cyl. 5.7L; L; 8.5mm High Performance Wire; Equipped with Ceramic Spark Plug Boots	10056
1986	8 Cyl. 5.7L; L; 8.5mm High Performance Wire	10010
1986	8 Cyl. 5.7L; L; 9.0mm High Performance Wire	10037
1985-1983	8 Cyl. 5.7L; 8.5mm High Performance Wire; Equipped with Ceramic Spark Plug Boots	10056
1985-1983	8 Cyl. 5.7L; 8.5mm High Performance Wire	10010
1985-1983	8 Cyl. 5.7L; 9.0mm High Performance Wire	10037
1985-1982	8 Cyl. 5.0L; 8.5mm High Performance Wire	10010
1985-1982	8 Cyl. 5.0L; 9.0mm High Performance Wire	10037
1985-1982	8 Cyl. 5.0L; 8.5mm High Performance Wire; Equipped with Ceramic Spark Plug Boots	10056
1982-1981	8 Cyl. 5.7L; L; 8.5mm High Performance Wire; Equipped with Ceramic Spark Plug Boots	10056
1982-1981	8 Cyl. 5.7L; L; 8.5mm High Performance Wire	10010
1982-1981	8 Cyl. 5.7L; L; 9.0mm High Performance Wire	10037
1981	8 Cyl. 5.7L; M; 9.0mm High Performance Wire	10034
1981	8 Cyl. 5.7L; M; 8.5mm High Performance Wire	10002
1981	8 Cyl. 5.7L; M; 8.5mm High Performance Wire; Equipped with Ceramic Spark Plug Boots	10053

Year	Model/Engine	Part No.
Spark Plug Wire Set		
K1500 Suburban		
1980-1979	8 Cyl. 5.7L; 9.0mm High Performance Wire	10034
1980-1979	8 Cyl. 6.6L; 9.0mm High Performance Wire	10034
1980-1979	8 Cyl. 6.6L; 8.5mm High Performance Wire	10002
1980-1979	8 Cyl. 5.7L; 8.5mm High Performance Wire	10002
1980-1979	8 Cyl. 6.6L; 8.5mm High Performance Wire; Equipped with Ceramic Spark Plug Boots	10053
1980-1979	8 Cyl. 5.7L; 8.5mm High Performance Wire; Equipped with Ceramic Spark Plug Boots	10053
1979	8 Cyl. 5.0L; 8.5mm High Performance Wire	10002
1979	8 Cyl. 5.0L; 8.5mm High Performance Wire; Equipped with Ceramic Spark Plug Boots	10053
1979	8 Cyl. 5.0L; 9.0mm High Performance Wire	10034
K2500		
2000-1996	8 Cyl. 5.7L; 8.5mm High Performance Wire	10021
2000-1996	8 Cyl. 7.4L; 8.5mm High Performance Wire	10070
2000-1996	8 Cyl. 7.4L; 8.5mm High Performance Wire; Equipped with Ceramic Spark Plug Boots	10071
2000-1996	8 Cyl. 5.7L; 8.5mm High Performance Wire; Equipped with Ceramic Spark Plug Boots	10072
1998	8 Cyl. 5.0L; 8.5mm High Performance Wire; Equipped with Ceramic Spark Plug Boots	10072
1998	8 Cyl. 5.0L; 8.5mm High Performance Wire	10021
1995-1991	8 Cyl. 7.4L; 8.5mm High Performance Wire; Equipped with Ceramic Spark Plug Boots	10051
1995-1991	8 Cyl. 7.4L; 8.5mm High Performance Wire	10050
1995-1988	8 Cyl. 5.7L; 8.5mm High Performance Wire; Equipped with Ceramic Spark Plug Boots	10046
1995-1988	8 Cyl. 5.0L; 8.5mm High Performance Wire; Equipped with Ceramic Spark Plug Boots	10046
1995-1988	8 Cyl. 5.0L; 9.0mm High Performance Wire	10038
1995-1988	8 Cyl. 5.7L; 8.5mm High Performance Wire	10018
1995-1988	6 Cyl. 4.3L; 8.5mm High Performance Wire	10014
1995-1988	6 Cyl. 4.3L; 8.5mm High Performance Wire; Equipped with Ceramic Spark Plug Boots	10076
1995-1988	8 Cyl. 5.0L; 8.5mm High Performance Wire	10018
1995-1988	8 Cyl. 5.7L; 9.0mm High Performance Wire	10038
1986	8 Cyl. 5.7L; L; 8.5mm High Performance Wire; Equipped with Ceramic Spark Plug Boots	10056
1986	8 Cyl. 5.7L; L; 8.5mm High Performance Wire	10010
1986	8 Cyl. 5.7L; L; 9.0mm High Performance Wire	10037

Wire Sets

Year	Model/Engine	Part No.
Spark Plug Wire Set		
K2500		
1986	8 Cyl. 5.7L; M; 8.5mm High Performance Wire; Equipped with Ceramic Spark Plug Boots; Fed.	10053
1986	8 Cyl. 5.7L; M; 8.5mm High Performance Wire; Calif.; Equipped with Ceramic Spark Plug Boots	10056
1986	8 Cyl. 5.7L; M; 8.5mm High Performance Wire; Fed.	10002
1986	8 Cyl. 5.7L; M; 9.0mm High Performance Wire; Fed.	10034
1986	8 Cyl. 5.7L; M; 8.5mm High Performance Wire; Calif.	10010
1986	8 Cyl. 5.7L; M; 9.0mm High Performance Wire; Calif.	10037
1985-1983	8 Cyl. 5.7L; 8.5mm High Performance Wire; Equipped with Ceramic Spark Plug Boots	10056
1985-1983	8 Cyl. 5.7L; 9.0mm High Performance Wire	10037
1985-1983	8 Cyl. 5.7L; 8.5mm High Performance Wire	10010
1982-1981	8 Cyl. 5.7L; L; 8.5mm High Performance Wire; Equipped with Ceramic Spark Plug Boots	10056
1982-1981	8 Cyl. 5.7L; L; 8.5mm High Performance Wire	10010
1982-1981	8 Cyl. 5.7L; L; 9.0mm High Performance Wire	10037
1982-1981	8 Cyl. 5.7L; M; 8.5mm High Performance Wire; Equipped with Ceramic Spark Plug Boots	10053
1982-1981	8 Cyl. 5.7L; M; 8.5mm High Performance Wire	10002
1982-1981	8 Cyl. 5.7L; M; 9.0mm High Performance Wire	10034
1980-1979	8 Cyl. 6.6L; 8.5mm High Performance Wire	10002
1980-1979	8 Cyl. 6.6L; 9.0mm High Performance Wire	10034
1980-1979	8 Cyl. 6.6L; 8.5mm High Performance Wire; Equipped with Ceramic Spark Plug Boots	10053
1980-1979	8 Cyl. 5.7L; 9.0mm High Performance Wire	10034
1980-1979	8 Cyl. 5.7L; 8.5mm High Performance Wire; Equipped with Ceramic Spark Plug Boots	10053
1980-1979	8 Cyl. 5.7L; 8.5mm High Performance Wire	10002
K2500 Suburban		
1999-1996	8 Cyl. 7.4L; 8.5mm High Performance Wire	10070
1999-1996	8 Cyl. 5.7L; 8.5mm High Performance Wire; Equipped with Ceramic Spark Plug Boots	10072
1999-1996	8 Cyl. 5.7L; 8.5mm High Performance Wire	10021
1999-1996	8 Cyl. 7.4L; 8.5mm High Performance Wire; Equipped with Ceramic Spark Plug Boots	10071
1995-1992	8 Cyl. 5.7L; 9.0mm High Performance Wire	10038
1995-1992	8 Cyl. 7.4L; 8.5mm High Performance Wire; Equipped with Ceramic Spark Plug Boots	10051
1995-1992	8 Cyl. 7.4L; 8.5mm High Performance Wire	10050
1995-1992	8 Cyl. 5.7L; 8.5mm High Performance Wire	10018

Year	Model/Engine	Part No.
Spark Plug Wire Set		
K2500 Suburban		
1995-1992	8 Cyl. 5.7L; 8.5mm High Performance Wire; Equipped with Ceramic Spark Plug Boots	10046
1986	8 Cyl. 5.7L; M; 8.5mm High Performance Wire; Fed.	10002
1986	8 Cyl. 5.7L; M; 8.5mm High Performance Wire; Calif.	10010
1986	8 Cyl. 5.7L; M; 8.5mm High Performance Wire; Equipped with Ceramic Spark Plug Boots; Fed.	10053
1986	8 Cyl. 5.7L; M; 8.5mm High Performance Wire; Calif.; Equipped with Ceramic Spark Plug Boots	10056
1986	8 Cyl. 5.7L; M; 9.0mm High Performance Wire; Fed.	10034
1986	8 Cyl. 5.7L; M; 9.0mm High Performance Wire; Calif.	10037
1985-1983	8 Cyl. 5.7L; 8.5mm High Performance Wire	10010
1985-1983	8 Cyl. 5.7L; 8.5mm High Performance Wire; Equipped with Ceramic Spark Plug Boots	10056
1985-1983	8 Cyl. 5.7L; 9.0mm High Performance Wire	10037
1982-1981	8 Cyl. 5.7L; M; 8.5mm High Performance Wire; Equipped with Ceramic Spark Plug Boots	10053
1982-1981	8 Cyl. 5.7L; M; 8.5mm High Performance Wire	10002
1982-1981	8 Cyl. 5.7L; M; 9.0mm High Performance Wire	10034
1981	8 Cyl. 5.7L; L; 9.0mm High Performance Wire	10037
1981	8 Cyl. 5.7L; L; 8.5mm High Performance Wire; Equipped with Ceramic Spark Plug Boots	10056
1981	8 Cyl. 5.7L; L; 8.5mm High Performance Wire	10010
1980-1979	8 Cyl. 6.6L; 8.5mm High Performance Wire; Equipped with Ceramic Spark Plug Boots	10053
1980-1979	8 Cyl. 6.6L; 9.0mm High Performance Wire	10034
1980-1979	8 Cyl. 6.6L; 8.5mm High Performance Wire	10002
1980-1979	8 Cyl. 5.7L; 8.5mm High Performance Wire; Equipped with Ceramic Spark Plug Boots	10053
1980-1979	8 Cyl. 5.7L; 9.0mm High Performance Wire	10034
1980-1979	8 Cyl. 5.7L; 8.5mm High Performance Wire	10002
K3500		
2000-1996	8 Cyl. 5.7L; 8.5mm High Performance Wire; Equipped with Ceramic Spark Plug Boots	10072
2000-1996	8 Cyl. 7.4L; 8.5mm High Performance Wire; Equipped with Ceramic Spark Plug Boots	10071
2000-1996	8 Cyl. 7.4L; 8.5mm High Performance Wire	10070
2000-1996	8 Cyl. 5.7L; 8.5mm High Performance Wire	10021
1995-1991	8 Cyl. 7.4L; 8.5mm High Performance Wire; Equipped with Ceramic Spark Plug Boots	10051
1995-1991	8 Cyl. 7.4L; 8.5mm High Performance Wire	10050
1995-1988	8 Cyl. 5.7L; 8.5mm High Performance Wire	10018

Wire Sets

Year	Model/Engine	Part No.
Spark Plug Wire Set		
K3500		
1995-1988	8 Cyl. 5.7L; 8.5mm High Performance Wire; Equipped with Ceramic Spark Plug Boots	10046
1995-1988	8 Cyl. 5.7L; 9.0mm High Performance Wire	10038
1990	8 Cyl. 7.4L; 8.5mm High Performance Wire	10048
1990	8 Cyl. 7.4L; 8.5mm High Performance Wire; Equipped with Ceramic Spark Plug Boots	10049
1989-1988	8 Cyl. 7.4L; 8.5mm High Performance Wire; Equipped with Ceramic Spark Plug Boots	10051
1989-1988	8 Cyl. 7.4L; 8.5mm High Performance Wire	10050
1986	8 Cyl. 5.7L; 8.5mm High Performance Wire; Fed.	10002
1986	8 Cyl. 5.7L; 9.0mm High Performance Wire; Fed.	10034
1986	8 Cyl. 5.7L; 8.5mm High Performance Wire; Calif.	10010
1986	8 Cyl. 5.7L; 8.5mm High Performance Wire; Calif.; Equipped with Ceramic Spark Plug Boots	10056
1986	8 Cyl. 5.7L; 8.5mm High Performance Wire; Equipped with Ceramic Spark Plug Boots; Fed.	10053
1986	8 Cyl. 7.4L; 8.5mm High Performance Wire; Calif.; Equipped with Ceramic Spark Plug Boots	10069
1986	8 Cyl. 7.4L; 8.5mm High Performance Wire; Fed.	10064
1986	8 Cyl. 5.7L; 9.0mm High Performance Wire; Calif.	10037
1986	8 Cyl. 7.4L; 8.5mm High Performance Wire; Calif.	10001
1986	8 Cyl. 7.4L; 8.5mm High Performance Wire; Equipped with Ceramic Spark Plug Boots; Fed.	10065
1985	8 Cyl. 7.4L; 8.5mm High Performance Wire; w/ Cast Iron Exhaust Manifold	10001
1985	8 Cyl. 7.4L; 8.5mm High Performance Wire; w/ Stainless Steel Exhaust Manifold	10064
1985	8 Cyl. 7.4L; 8.5mm High Performance Wire; Equipped with Ceramic Spark Plug Boots; w/ Stainless Steel Exhaust Manifold	10065
1985	8 Cyl. 7.4L; 8.5mm High Performance Wire; Equipped with Ceramic Spark Plug Boots; w/ Cast Iron Exhaust Manifold	10069
1985-1983	8 Cyl. 5.7L; 8.5mm High Performance Wire	10010
1985-1983	8 Cyl. 5.7L; 9.0mm High Performance Wire	10037
1985-1983	8 Cyl. 5.7L; 8.5mm High Performance Wire; Equipped with Ceramic Spark Plug Boots	10056
1984-1979	8 Cyl. 7.4L; 8.5mm High Performance Wire; Equipped with Ceramic Spark Plug Boots	10069
1984-1979	8 Cyl. 7.4L; 8.5mm High Performance Wire	10001
1982-1979	8 Cyl. 5.7L; 8.5mm High Performance Wire; Equipped with Ceramic Spark Plug Boots	10053
1982-1979	8 Cyl. 5.7L; 8.5mm High Performance Wire	10002
1982-1979	8 Cyl. 5.7L; 9.0mm High Performance Wire	10034

Year	Model/Engine	Part No.
Spark Plug Wire Set		
K3500		
1980-1979	8 Cyl. 6.6L; 9.0mm High Performance Wire	10034
1980-1979	8 Cyl. 6.6L; 8.5mm High Performance Wire	10002
1980-1979	8 Cyl. 6.6L; 8.5mm High Performance Wire; Equipped with Ceramic Spark Plug Boots	10053
P25/P2500 Van		
1974	8 Cyl. 5.7L; 8.5mm High Performance Wire; Routed Over Valve Cover	10007
1974	8 Cyl. 5.7L; 8.5mm High Performance Wire; Equipped with Ceramic Spark Plug Boots; Routed Over Valve Cover	10079
P35/P3500 Van		
1974	8 Cyl. 5.7L; 8.5mm High Performance Wire; Routed Over Valve Cover	10007
1974	8 Cyl. 5.7L; 8.5mm High Performance Wire; Equipped with Ceramic Spark Plug Boots; Routed Over Valve Cover	10079
P2500		
1989-1988	8 Cyl. 5.7L; 8.5mm High Performance Wire; Equipped with Ceramic Spark Plug Boots	10046
1989-1988	8 Cyl. 5.7L; 8.5mm High Performance Wire	10018
P3500		
1999-1998	8 Cyl. 7.4L; B; 8.5mm High Performance Wire	10074
1999-1998	8 Cyl. 7.4L; B; 8.5mm High Performance Wire; Equipped with Ceramic Spark Plug Boots	10075
1999-1998	8 Cyl. 7.4L; J; 8.5mm High Performance Wire; Equipped with Ceramic Spark Plug Boots	10071
1999-1998	8 Cyl. 7.4L; J; 8.5mm High Performance Wire	10070
1999-1996	6 Cyl. 4.3L; 8.5mm High Performance Wire; Equipped with Ceramic Spark Plug Boots	10078
1999-1996	6 Cyl. 4.3L; 8.5mm High Performance Wire	10077
1997-1996	8 Cyl. 7.4L; 8.5mm High Performance Wire; Equipped with Ceramic Spark Plug Boots; MFI	10071
1997-1996	8 Cyl. 7.4L; 8.5mm High Performance Wire; EFI	10050
1997-1996	8 Cyl. 7.4L; 8.5mm High Performance Wire; EFI; Equipped with Ceramic Spark Plug Boots	10051
1997-1996	8 Cyl. 7.4L; 8.5mm High Performance Wire; MFI	10070
1996	8 Cyl. 5.7L; 8.5mm High Performance Wire; Equipped with Ceramic Spark Plug Boots; TBI	10046
1996	8 Cyl. 5.7L; 8.5mm High Performance Wire; TBI	10018
1995-1990	8 Cyl. 7.4L; 8.5mm High Performance Wire; Equipped with Ceramic Spark Plug Boots	10051
1995-1990	8 Cyl. 7.4L; 8.5mm High Performance Wire	10050
1995-1989	8 Cyl. 5.7L; 8.5mm High Performance Wire	10018
1995-1989	8 Cyl. 5.7L; 8.5mm High Performance Wire; Equipped with Ceramic Spark Plug Boots	10046
1989-1988	8 Cyl. 7.4L; 8.5mm High Performance Wire	10064

Wire Sets

Year	Model/Engine	Part No.
Spark Plug Wire Set		
P3500		
1989-1988	8 Cyl. 7.4L; 8.5mm High Performance Wire; Equipped with Ceramic Spark Plug Boots	10065
1988-1987	8 Cyl. 5.7L; 8.5mm High Performance Wire; Equipped with Ceramic Spark Plug Boots; TBI	10046
1988-1987	8 Cyl. 5.7L; 8.5mm High Performance Wire; TBI	10018
1987-1986	8 Cyl. 7.4L; 8.5mm High Performance Wire; Equipped with Ceramic Spark Plug Boots; Fed.	10065
1987-1986	8 Cyl. 7.4L; 8.5mm High Performance Wire; Fed.	10064
R1500		
1987	8 Cyl. 5.0L; 8.5mm High Performance Wire; Equipped with Ceramic Spark Plug Boots	10046
1987	8 Cyl. 5.7L; 8.5mm High Performance Wire; Equipped with Ceramic Spark Plug Boots	10046
1987	6 Cyl. 4.3L; 8.5mm High Performance Wire	10014
1987	6 Cyl. 4.3L; 8.5mm High Performance Wire; Equipped with Ceramic Spark Plug Boots	10076
1987	8 Cyl. 5.7L; 8.5mm High Performance Wire	10018
1987	8 Cyl. 5.0L; 8.5mm High Performance Wire	10018
1987	8 Cyl. 5.7L; 9.0mm High Performance Wire	10038
1987	8 Cyl. 5.0L; 9.0mm High Performance Wire	10038
R1500 Suburban		
1991-1987	8 Cyl. 5.7L; 8.5mm High Performance Wire	10018
1991-1987	8 Cyl. 5.7L; 8.5mm High Performance Wire; Equipped with Ceramic Spark Plug Boots	10046
1991-1987	8 Cyl. 5.7L; 9.0mm High Performance Wire	10038
1987	8 Cyl. 5.0L; 9.0mm High Performance Wire	10038
1987	8 Cyl. 5.0L; 8.5mm High Performance Wire	10018
1987	8 Cyl. 5.0L; 8.5mm High Performance Wire; Equipped with Ceramic Spark Plug Boots	10046
R2500		
1989-1987	8 Cyl. 5.7L; 8.5mm High Performance Wire; Equipped with Ceramic Spark Plug Boots	10046
1989-1987	8 Cyl. 7.4L; 8.5mm High Performance Wire; Equipped with Ceramic Spark Plug Boots	10051
1989-1987	8 Cyl. 7.4L; 8.5mm High Performance Wire	10050
1989-1987	8 Cyl. 5.7L; 9.0mm High Performance Wire	10038
1989-1987	8 Cyl. 5.7L; 8.5mm High Performance Wire	10018
1987	8 Cyl. 5.0L; 9.0mm High Performance Wire	10038
1987	8 Cyl. 5.0L; 8.5mm High Performance Wire; Equipped with Ceramic Spark Plug Boots	10046
1987	8 Cyl. 5.0L; 8.5mm High Performance Wire	10018

Year	Model/Engine	Part No.
Spark Plug Wire Set		
R2500 Suburban		
1991-1990	8 Cyl. 7.4L; 8.5mm High Performance Wire; Equipped with Ceramic Spark Plug Boots	10049
1991-1990	8 Cyl. 7.4L; 8.5mm High Performance Wire	10048
1991-1987	8 Cyl. 5.7L; 8.5mm High Performance Wire; Equipped with Ceramic Spark Plug Boots	10046
1991-1987	8 Cyl. 5.7L; 9.0mm High Performance Wire	10038
1991-1987	8 Cyl. 5.7L; 8.5mm High Performance Wire	10018
1989-1987	8 Cyl. 7.4L; 8.5mm High Performance Wire; Equipped with Ceramic Spark Plug Boots	10051
1989-1987	8 Cyl. 7.4L; 8.5mm High Performance Wire	10050
R3500		
1991-1990	8 Cyl. 7.4L; 8.5mm High Performance Wire	10048
1991-1990	8 Cyl. 7.4L; 8.5mm High Performance Wire; Equipped with Ceramic Spark Plug Boots	10049
1991-1989	8 Cyl. 5.7L; 8.5mm High Performance Wire; Equipped with Ceramic Spark Plug Boots	10046
1991-1989	8 Cyl. 5.7L; 9.0mm High Performance Wire	10038
1991-1989	8 Cyl. 5.7L; 8.5mm High Performance Wire	10018
1989-1987	8 Cyl. 7.4L; 8.5mm High Performance Wire; EFI; Equipped with Ceramic Spark Plug Boots	10051
1989-1987	8 Cyl. 7.4L; 8.5mm High Performance Wire; Carb.; Equipped with Ceramic Spark Plug Boots	10065
1989-1987	8 Cyl. 7.4L; 8.5mm High Performance Wire; Carb.	10064
1989-1987	8 Cyl. 7.4L; 8.5mm High Performance Wire; EFI	10050
1988-1987	8 Cyl. 5.7L; 9.0mm High Performance Wire; TBI	10038
1988-1987	8 Cyl. 5.7L; 4 Bbl. Carb.; 8.5mm High Performance Wire	10002
1988-1987	8 Cyl. 5.7L; 8.5mm High Performance Wire; Equipped with Ceramic Spark Plug Boots; TBI	10046
1988-1987	8 Cyl. 5.7L; 4 Bbl. Carb.; 9.0mm High Performance Wire	10034
1988-1987	8 Cyl. 5.7L; 4 Bbl. Carb.; 8.5mm High Performance Wire; Equipped with Ceramic Spark Plug Boots	10053
1988-1987	8 Cyl. 5.7L; 8.5mm High Performance Wire; TBI	10018
S15		
1990	6 Cyl. 2.8L; 8.5mm High Performance Wire	10057
1990	6 Cyl. 2.8L; 8.5mm High Performance Wire; Equipped with Ceramic Spark Plug Boots	10058
1990-1988	6 Cyl. 4.3L; 8.5mm High Performance Wire	10014
1990-1988	6 Cyl. 4.3L; 8.5mm High Performance Wire; Equipped with Ceramic Spark Plug Boots	10076
1982	6 Cyl. 2.8L; 8.5mm High Performance Wire	10057
1982	6 Cyl. 2.8L; 8.5mm High Performance Wire; Equipped with Ceramic Spark Plug Boots	10058

Wire Sets

Year	Model/Engine	Part No.
Spark Plug Wire Set		
S15 Jimmy		
1991-1988	6 Cyl. 4.3L; 8.5mm High Performance Wire; Equipped with Ceramic Spark Plug Boots	10076
1991-1988	6 Cyl. 4.3L; 8.5mm High Performance Wire	10014
1989-1983	6 Cyl. 2.8L; 8.5mm High Performance Wire	10057
1989-1983	6 Cyl. 2.8L; 8.5mm High Performance Wire; Equipped with Ceramic Spark Plug Boots	10058
Safari		
2005-1996	6 Cyl. 4.3L; 8.5mm High Performance Wire; Equipped with Ceramic Spark Plug Boots	10078
2005-1996	6 Cyl. 4.3L; 8.5mm High Performance Wire	10077
1995-1986	6 Cyl. 4.3L; 8.5mm High Performance Wire	10014
1995-1986	6 Cyl. 4.3L; 8.5mm High Performance Wire; Equipped with Ceramic Spark Plug Boots	10076
Savana 1500		
2008-2003	8 Cyl. 5.3L; 9.0mm High Performance Wire	10042
2008-2003	8 Cyl. 5.3L; 8.5mm High Performance Wire	10041
2007-1996	6 Cyl. 4.3L; 8.5mm High Performance Wire	10077
2007-1996	6 Cyl. 4.3L; 8.5mm High Performance Wire; Equipped with Ceramic Spark Plug Boots	10078
Savana 2500		
2005-2003	8 Cyl. 5.3L; 9.0mm High Performance Wire	10042
2005-2003	8 Cyl. 5.3L; 8.5mm High Performance Wire	10041
2005-1996	6 Cyl. 4.3L; 8.5mm High Performance Wire	10077
2005-1996	6 Cyl. 4.3L; 8.5mm High Performance Wire; Equipped with Ceramic Spark Plug Boots	10078
Savana 3500		
2000-1996	8 Cyl. 7.4L; 8.5mm High Performance Wire; Equipped with Ceramic Spark Plug Boots	10071
2000-1996	8 Cyl. 7.4L; 8.5mm High Performance Wire	10070
Sierra		
2010-2009	8 Cyl. 6.2L; 9.0mm High Performance Wire	10039
2010-2009	8 Cyl. 5.3L; 9.0mm High Performance Wire	10039
2010-2009	8 Cyl. 6.2L; 8.5mm High Performance Wire	10026
2010-2009	8 Cyl. 5.3L; 8.5mm High Performance Wire	10026
2008	8 Cyl. 5.3L; 9.0mm High Performance Wire	10042
2008	8 Cyl. 5.3L; 8.5mm High Performance Wire	10041
2007	8 Cyl. 5.3L; 8.5mm High Performance Wire; Old Body Style; Round Coil	10026
2007	8 Cyl. 5.3L; 9.0mm High Performance Wire; Old Body Style; Round Coil	10039
2007	8 Cyl. 5.3L; 8.5mm High Performance Wire; New Body Style	10041
2007	8 Cyl. 5.3L; 9.0mm High Performance Wire; New Body Style	10042

Year	Model/Engine	Part No.
Spark Plug Wire Set		
Sierra 1500		
2010-2009	8 Cyl. 6.0L; 8.5mm High Performance Wire	10026
2010-2009	8 Cyl. 5.3L; 9.0mm High Performance Wire	10039
2010-2009	8 Cyl. 5.3L; 8.5mm High Performance Wire	10026
2010-2009	8 Cyl. 6.2L; 9.0mm High Performance Wire	10039
2010-2009	8 Cyl. 6.0L; 9.0mm High Performance Wire	10039
2010-2009	8 Cyl. 4.8L; 9.0mm High Performance Wire	10039
2010-2009	8 Cyl. 4.8L; 8.5mm High Performance Wire	10026
2010-2009	8 Cyl. 6.2L; 8.5mm High Performance Wire	10026
2008	8 Cyl. 5.3L; 9.0mm High Performance Wire	10042
2008	8 Cyl. 5.3L; 8.5mm High Performance Wire	10041
2007	8 Cyl. 4.8L; 8.5mm High Performance Wire; Old Body Style; Round Coil	10026
2007	8 Cyl. 5.3L; 8.5mm High Performance Wire; Equipped with Ceramic Spark Plug Boots; Old Body Style; Square Coil	10075
2007	8 Cyl. 5.3L; 9.0mm High Performance Wire; New Body Style	10042
2007	8 Cyl. 4.8L; 8.5mm High Performance Wire; Equipped with Ceramic Spark Plug Boots; Old Body Style; Square Coil	10075
2007	8 Cyl. 5.3L; 9.0mm High Performance Wire; Old Body Style; Round Coil	10039
2007	8 Cyl. 5.3L; 8.5mm High Performance Wire; Old Body Style; Round Coil	10026
2007	8 Cyl. 5.3L; 8.5mm High Performance Wire; Old Body Style; Square Coil	10074
2007	8 Cyl. 6.0L; 8.5mm High Performance Wire; Old Body Style; Square Coil	10074
2007	8 Cyl. 4.8L; 9.0mm High Performance Wire; Old Body Style; Round Coil	10039
2007	8 Cyl. 6.0L; 8.5mm High Performance Wire; Equipped with Ceramic Spark Plug Boots; Old Body Style; Square Coil	10075
2007	8 Cyl. 6.0L; 8.5mm High Performance Wire; Old Body Style; Round Coil	10026
2007	8 Cyl. 6.0L; 9.0mm High Performance Wire; Old Body Style; Round Coil	10039
2007	8 Cyl. 5.3L; 8.5mm High Performance Wire; New Body Style	10041
2007	8 Cyl. 4.8L; 8.5mm High Performance Wire; Old Body Style; Square Coil	10074
2006-2002	8 Cyl. 6.0L; 9.0mm High Performance Wire; Round Coil	10039
2006-2002	8 Cyl. 6.0L; 8.5mm High Performance Wire; Equipped with Ceramic Spark Plug Boots; Square Coil	10075
2006-2002	8 Cyl. 6.0L; 8.5mm High Performance Wire; Square Coil	10074
2006-2002	8 Cyl. 6.0L; 8.5mm High Performance Wire; Round Coil	10026
2006-1999	8 Cyl. 4.8L; 9.0mm High Performance Wire; Round Coil	10039
2006-1999	8 Cyl. 4.8L; 8.5mm High Performance Wire; Square Coil	10074
2006-1999	8 Cyl. 4.8L; 8.5mm High Performance Wire; Equipped with Ceramic Spark Plug Boots; Square Coil	10075
2006-1999	8 Cyl. 5.3L; 8.5mm High Performance Wire; Equipped with Ceramic Spark Plug Boots; Square Coil	10075

Wire Sets

Year	Model/Engine	Part No.
Spark Plug Wire Set		
Sierra 1500		
2006-1999	8 Cyl. 4.8L; 8.5mm High Performance Wire; Round Coil	10026
2006-1999	8 Cyl. 5.3L; 8.5mm High Performance Wire; Round Coil	10026
2006-1999	8 Cyl. 5.3L; 9.0mm High Performance Wire; Round Coil	10039
2006-1999	8 Cyl. 5.3L; 8.5mm High Performance Wire; Square Coil	10074
Sierra 1500 HD		
2007	8 Cyl. 6.0L; 8.5mm High Performance Wire; Old Body Style; Round Coil	10026
2007	8 Cyl. 6.0L; 8.5mm High Performance Wire; Old Body Style; Square Coil	10074
2007	8 Cyl. 6.0L; 9.0mm High Performance Wire; Old Body Style; Round Coil	10039
2007	8 Cyl. 6.0L; 8.5mm High Performance Wire; Equipped with Ceramic Spark Plug Boots; Old Body Style; Square Coil	10075
2006-2005	8 Cyl. 6.0L; 8.5mm High Performance Wire; Round Coil	10026
2006-2005	8 Cyl. 6.0L; 9.0mm High Performance Wire; Round Coil	10039
2006-2005	8 Cyl. 6.0L; 8.5mm High Performance Wire; Square Coil	10074
2006-2005	8 Cyl. 6.0L; 8.5mm High Performance Wire; Equipped with Ceramic Spark Plug Boots; Square Coil	10075
2003-2001	8 Cyl. 6.0L; 8.5mm High Performance Wire; Round Coil	10026
2003-2001	8 Cyl. 6.0L; 9.0mm High Performance Wire; Round Coil	10039
2003-2001	8 Cyl. 6.0L; 8.5mm High Performance Wire; Square Coil	10074
2003-2001	8 Cyl. 6.0L; 8.5mm High Performance Wire; Equipped with Ceramic Spark Plug Boots; Square Coil	10075
Sierra 2500		
2004-1999	8 Cyl. 6.0L; 9.0mm High Performance Wire; Round Coil	10039
2004-1999	8 Cyl. 6.0L; 8.5mm High Performance Wire; Round Coil	10026
2004-1999	8 Cyl. 6.0L; 8.5mm High Performance Wire; Equipped with Ceramic Spark Plug Boots; Square Coil	10075
2004-1999	8 Cyl. 6.0L; 8.5mm High Performance Wire; Square Coil	10074
2000-1999	8 Cyl. 5.3L; 9.0mm High Performance Wire; Round Coil	10039
2000-1999	8 Cyl. 5.3L; 8.5mm High Performance Wire; Equipped with Ceramic Spark Plug Boots; Square Coil	10075
2000-1999	8 Cyl. 5.3L; 8.5mm High Performance Wire; Round Coil	10026
2000-1999	8 Cyl. 5.3L; 8.5mm High Performance Wire; Square Coil	10074
Sierra 2500 HD		
2010-2009	8 Cyl. 6.0L; 8.5mm High Performance Wire	10026
2010-2009	8 Cyl. 6.0L; 9.0mm High Performance Wire	10039
2007	8 Cyl. 6.0L; 9.0mm High Performance Wire; Old Body Style; Round Coil	10039
2007	8 Cyl. 6.0L; 8.5mm High Performance Wire; Old Body Style; Square Coil	10074
2007	8 Cyl. 6.0L; 8.5mm High Performance Wire; Equipped with Ceramic Spark Plug Boots; Old Body Style; Square Coil	10075
2007	8 Cyl. 6.0L; 8.5mm High Performance Wire; Old Body Style; Round Coil	10026

Year	Model/Engine	Part No.
Spark Plug Wire Set		
Sierra 2500 HD		
2006-2001	8 Cyl. 6.0L; 8.5mm High Performance Wire; Equipped with Ceramic Spark Plug Boots; Square Coil	10075
2006-2001	8 Cyl. 6.0L; 8.5mm High Performance Wire; Square Coil	10074
2006-2001	8 Cyl. 6.0L; 9.0mm High Performance Wire; Round Coil	10039
2006-2001	8 Cyl. 6.0L; 8.5mm High Performance Wire; Round Coil	10026
Sierra 3500		
2007	8 Cyl. 6.0L; 8.5mm High Performance Wire; Old Body Style; Round Coil	10026
2007	8 Cyl. 6.0L; 8.5mm High Performance Wire; Old Body Style; Square Coil	10074
2007	8 Cyl. 6.0L; 8.5mm High Performance Wire; Equipped with Ceramic Spark Plug Boots; Old Body Style; Square Coil	10075
2007	8 Cyl. 6.0L; 9.0mm High Performance Wire; Old Body Style; Round Coil	10039
2006-2001	8 Cyl. 6.0L; 9.0mm High Performance Wire; Round Coil	10039
2006-2001	8 Cyl. 6.0L; 8.5mm High Performance Wire; Round Coil	10026
2006-2001	8 Cyl. 6.0L; 8.5mm High Performance Wire; Square Coil	10074
2006-2001	8 Cyl. 6.0L; 8.5mm High Performance Wire; Equipped with Ceramic Spark Plug Boots; Square Coil	10075
Sierra 3500 HD		
2010-2009	8 Cyl. 6.0L; 9.0mm High Performance Wire	10039
2010-2009	8 Cyl. 6.0L; 8.5mm High Performance Wire	10026
2007	8 Cyl. 6.0L; 8.5mm High Performance Wire; Old Body Style; Round Coil	10026
2007	8 Cyl. 6.0L; 8.5mm High Performance Wire; Old Body Style; Square Coil	10074
2007	8 Cyl. 6.0L; 9.0mm High Performance Wire; Old Body Style; Round Coil	10039
2007	8 Cyl. 6.0L; 8.5mm High Performance Wire; Equipped with Ceramic Spark Plug Boots; Old Body Style; Square Coil	10075
Sierra C3		
2001	8 Cyl. 6.0L; 9.0mm High Performance Wire; Round Coil	10039
2001	8 Cyl. 6.0L; 8.5mm High Performance Wire; Round Coil	10026
Sonoma		
2004-1996	6 Cyl. 4.3L; 8.5mm High Performance Wire; Equipped with Ceramic Spark Plug Boots	10078
2004-1996	6 Cyl. 4.3L; 8.5mm High Performance Wire	10077
1995	6 Cyl. 4.3L; 8.5mm High Performance Wire; Vertical Towers	10014
1995	6 Cyl. 4.3L; 8.5mm High Performance Wire; Equipped with Ceramic Spark Plug Boots; Vertical Towers	10076
1994-1991	6 Cyl. 4.3L; 8.5mm High Performance Wire; Equipped with Ceramic Spark Plug Boots	10076
1994-1991	6 Cyl. 4.3L; 8.5mm High Performance Wire	10014
1993-1991	6 Cyl. 2.8L; 8.5mm High Performance Wire; Equipped with Ceramic Spark Plug Boots	10058
1993-1991	6 Cyl. 2.8L; 8.5mm High Performance Wire	10057

Wire Sets

Year	Model/Engine	Part No.
Spark Plug Wire Set		
Sprint		
1977-1976	8 Cyl. 5.0L; 8.5mm High Performance Wire	10002
1977-1976	8 Cyl. 5.0L; 8.5mm High Performance Wire; Equipped with Ceramic Spark Plug Boots	10053
1977-1976	8 Cyl. 5.0L; 9.0mm High Performance Wire	10034
1977-1975	8 Cyl. 5.7L; 8.5mm High Performance Wire	10002
1977-1975	8 Cyl. 5.7L; 8.5mm High Performance Wire; Equipped with Ceramic Spark Plug Boots	10053
1977-1975	8 Cyl. 5.7L; 9.0mm High Performance Wire	10034
1976-1975	8 Cyl. 6.6L; 8.5mm High Performance Wire	10002
1976-1975	8 Cyl. 6.6L; 9.0mm High Performance Wire	10034
1976-1975	8 Cyl. 6.6L; 8.5mm High Performance Wire; Equipped with Ceramic Spark Plug Boots	10053
1975	8 Cyl. 7.4L; 8.5mm High Performance Wire	10001
1975	8 Cyl. 7.4L; 8.5mm High Performance Wire; Equipped with Ceramic Spark Plug Boots	10069
1974	8 Cyl. 5.7L; 8.5mm High Performance Wire; w/ High Energy Ignition	10002
1974	8 Cyl. 6.6L; 9.0mm High Performance Wire; w/ High Energy Ignition	10034
1974	8 Cyl. 6.6L; 400; 8.5mm High Performance Wire; Equipped with Ceramic Spark Plug Boots; Exc. High Energy Ignition; Routed Over Valve Cover	10079
1974	8 Cyl. 7.4L; 8.5mm High Performance Wire; Exc. High Energy Ignition; w/ Straight Non-Bendable Spark Plug Boot	10006
1974	8 Cyl. 6.6L; 8.5mm High Performance Wire; Equipped with Ceramic Spark Plug Boots; High Energy Ignition	10053
1974	8 Cyl. 7.4L; 8.5mm High Performance Wire; w/ High Energy Ignition	10001
1974	8 Cyl. 6.6L; 8.5mm High Performance Wire; w/ High Energy Ignition	10002
1974	8 Cyl. 7.4L; 8.5mm High Performance Wire; Equipped with Ceramic Spark Plug Boots; Exc. High Energy Ignition	10114
1974	8 Cyl. 5.7L; 9.0mm High Performance Wire; w/ High Energy Ignition	10034
1974	8 Cyl. 5.7L; 8.5mm High Performance Wire; Equipped with Ceramic Spark Plug Boots; Exc. High Energy Ignition; Routed Over Valve Cover	10079
1974	8 Cyl. 5.7L; 8.5mm High Performance Wire; Exc. High Energy Ignition; Routed Over Valve Cover	10007
1974	8 Cyl. 6.6L; 400; 8.5mm High Performance Wire; Exc. High Energy Ignition; Routed Over Valve Cover	10007
1974	8 Cyl. 5.7L; 8.5mm High Performance Wire; Equipped with Ceramic Spark Plug Boots; High Energy Ignition	10053
1974	8 Cyl. 7.4L; 8.5mm High Performance Wire; Equipped with Ceramic Spark Plug Boots; w/ High Energy Ignition	10069
1974	8 Cyl. 7.4L; 8.5mm High Performance Wire; Exc. High Energy Ignition; w/ Straight Bendable Spark Plug Boot	10116
1973-1971	8 Cyl. 7.4L; 8.5mm High Performance Wire; w/ Straight Non-Bendable Spark Plug Boot	10006

Year	Model/Engine	Part No.
Spark Plug Wire Set		
Sprint		
1973-1971	8 Cyl. 5.7L; 8.5mm High Performance Wire; Routed Over Valve Cover	10007
1973-1971	8 Cyl. 5.7L; 8.5mm High Performance Wire; Equipped with Ceramic Spark Plug Boots; Routed Over Valve Cover	10079
1973-1971	8 Cyl. 5.0L; 8.5mm High Performance Wire; Equipped with Ceramic Spark Plug Boots; Routed Over Valve Cover	10079
1973-1971	8 Cyl. 7.4L; 8.5mm High Performance Wire; Equipped with Ceramic Spark Plug Boots	10114
1973-1971	8 Cyl. 5.0L; 8.5mm High Performance Wire; Routed Over Valve Cover	10007
1973-1971	8 Cyl. 7.4L; 8.5mm High Performance Wire; w/ Straight Bendable Spark Plug Boot	10116
1972-1971	8 Cyl. 6.6L; 8.5mm High Performance Wire; w/ Straight Non-Bendable Spark Plug Boot	10006
1972-1971	8 Cyl. 6.6L; 8.5mm High Performance Wire; Equipped with Ceramic Spark Plug Boots	10114
1972-1971	8 Cyl. 6.6L; 8.5mm High Performance Wire; w/ Straight Bendable Spark Plug Boot	10116
Truck		
1959-1958	8 Cyl. 5.5L; 8.5mm High Performance Wire; Routed Under Exhaust Manifold	10005
1959-1958	8 Cyl. 5.5L; 8.5mm High Performance Wire; Equipped with Ceramic Spark Plug Boots; Routed Under Exhaust Manifold	10080
1957	8 Cyl. 5.7L; 8.5mm High Performance Wire; Routed Under Exhaust Manifold	10005
1957	8 Cyl. 5.7L; 8.5mm High Performance Wire; Equipped with Ceramic Spark Plug Boots; Routed Under Exhaust Manifold	10080
1956	8 Cyl. 5.2L; 8.5mm High Performance Wire; Equipped with Ceramic Spark Plug Boots; Routed Under Exhaust Manifold	10080
1956	8 Cyl. 5.2L; 8.5mm High Performance Wire; Routed Under Exhaust Manifold	10005
1955	8 Cyl. 4.7L; 8.5mm High Performance Wire; Equipped with Ceramic Spark Plug Boots; Routed Under Exhaust Manifold	10080
1955	8 Cyl. 4.7L; 8.5mm High Performance Wire; Routed Under Exhaust Manifold	10005
V1500		
1987	8 Cyl. 5.7L; 8.5mm High Performance Wire	10018
1987	8 Cyl. 5.0L; 9.0mm High Performance Wire	10038
1987	6 Cyl. 4.3L; 8.5mm High Performance Wire; Equipped with Ceramic Spark Plug Boots	10076
1987	8 Cyl. 5.0L; 8.5mm High Performance Wire	10018
1987	8 Cyl. 5.7L; 9.0mm High Performance Wire	10038
1987	8 Cyl. 5.0L; 8.5mm High Performance Wire; Equipped with Ceramic Spark Plug Boots	10046
1987	8 Cyl. 5.7L; 8.5mm High Performance Wire; Equipped with Ceramic Spark Plug Boots	10046
1987	6 Cyl. 4.3L; 8.5mm High Performance Wire	10014
V1500 Suburban		
1991-1987	8 Cyl. 5.7L; 9.0mm High Performance Wire	10038

Wire Sets

Year	Model/Engine	Part No.
Spark Plug Wire Set		
V1500 Suburban		
1991-1987	8 Cyl. 5.7L; 8.5mm High Performance Wire; Equipped with Ceramic Spark Plug Boots	10046
1991-1987	8 Cyl. 5.7L; 8.5mm High Performance Wire	10018
V2500		
1987	8 Cyl. 5.7L; 8.5mm High Performance Wire	10018
1987	8 Cyl. 5.7L; 9.0mm High Performance Wire	10038
1987	8 Cyl. 5.7L; 8.5mm High Performance Wire; Equipped with Ceramic Spark Plug Boots	10046
V2500 Suburban		
1991-1987	8 Cyl. 5.7L; 9.0mm High Performance Wire	10038
1991-1987	8 Cyl. 5.7L; 8.5mm High Performance Wire	10018
1991-1987	8 Cyl. 5.7L; 8.5mm High Performance Wire; Equipped with Ceramic Spark Plug Boots	10046
V3500		
1991-1990	8 Cyl. 7.4L; 8.5mm High Performance Wire	10048
1991-1990	8 Cyl. 7.4L; 8.5mm High Performance Wire; Equipped with Ceramic Spark Plug Boots	10049
1991-1989	8 Cyl. 5.7L; 9.0mm High Performance Wire	10038
1991-1989	8 Cyl. 5.7L; 8.5mm High Performance Wire	10018
1991-1989	8 Cyl. 5.7L; 8.5mm High Performance Wire; Equipped with Ceramic Spark Plug Boots	10046
1989-1987	8 Cyl. 7.4L; 8.5mm High Performance Wire; EFI; Equipped with Ceramic Spark Plug Boots	10051
1989-1987	8 Cyl. 7.4L; 8.5mm High Performance Wire; Carb.	10064
1989-1987	8 Cyl. 7.4L; 8.5mm High Performance Wire; EFI	10050
1989-1987	8 Cyl. 7.4L; 8.5mm High Performance Wire; Carb.; Equipped with Ceramic Spark Plug Boots	10065
1988-1987	8 Cyl. 5.7L; 4 Bbl. Carb.; 8.5mm High Performance Wire; Equipped with Ceramic Spark Plug Boots	10053
1988-1987	8 Cyl. 5.7L; 8.5mm High Performance Wire; TBI	10018
1988-1987	8 Cyl. 5.7L; 8.5mm High Performance Wire; Equipped with Ceramic Spark Plug Boots; TBI	10046
1988-1987	8 Cyl. 5.7L; 9.0mm High Performance Wire; TBI	10038
1988-1987	8 Cyl. 5.7L; 4 Bbl. Carb.; 9.0mm High Performance Wire	10034
1988-1987	8 Cyl. 5.7L; 4 Bbl. Carb.; 8.5mm High Performance Wire	10002
Yukon		
2013-2009	8 Cyl. 6.0L; 9.0mm High Performance Wire	10039
2013-2009	8 Cyl. 6.0L; 8.5mm High Performance Wire	10026
2010-2009	8 Cyl. 5.3L; 8.5mm High Performance Wire	10026
2010-2009	8 Cyl. 6.2L; 8.5mm High Performance Wire	10026
2010-2009	8 Cyl. 6.2L; 9.0mm High Performance Wire	10039

Year	Model/Engine	Part No.
Spark Plug Wire Set		
Yukon		
2010-2009	8 Cyl. 5.3L; 9.0mm High Performance Wire	10039
2009	8 Cyl. 4.8L; 8.5mm High Performance Wire	10026
2009	8 Cyl. 4.8L; 9.0mm High Performance Wire	10039
2008-2007	8 Cyl. 5.3L; 9.0mm High Performance Wire	10042
2008-2007	8 Cyl. 5.3L; 8.5mm High Performance Wire	10041
2007	8 Cyl. 4.8L; 8.5mm High Performance Wire; Old Body Style; Square Coil	10074
2007	8 Cyl. 4.8L; 9.0mm High Performance Wire; Old Body Style; Round Coil	10039
2007	8 Cyl. 4.8L; 8.5mm High Performance Wire; Equipped with Ceramic Spark Plug Boots; Old Body Style; Square Coil	10075
2007	8 Cyl. 4.8L; 8.5mm High Performance Wire; Old Body Style; Round Coil	10026
2006-2001	8 Cyl. 6.0L; 8.5mm High Performance Wire; Square Coil	10074
2006-2001	8 Cyl. 6.0L; Denali; 8.5mm High Performance Wire; Round Coil	10026
2006-2001	8 Cyl. 6.0L; 8.5mm High Performance Wire; Equipped with Ceramic Spark Plug Boots; Square Coil	10075
2006-2001	8 Cyl. 6.0L; Denali; 9.0mm High Performance Wire; Round Coil	10039
2006-2000	8 Cyl. 5.3L; 8.5mm High Performance Wire; Square Coil	10074
2006-2000	8 Cyl. 5.3L; 8.5mm High Performance Wire; Equipped with Ceramic Spark Plug Boots; Square Coil	10075
2006-2000	8 Cyl. 4.8L; 8.5mm High Performance Wire; Equipped with Ceramic Spark Plug Boots; Square Coil	10075
2006-2000	8 Cyl. 4.8L; 8.5mm High Performance Wire; Square Coil	10074
2006-2000	8 Cyl. 5.3L; 8.5mm High Performance Wire; Round Coil	10026
2006-2000	8 Cyl. 4.8L; 8.5mm High Performance Wire; Round Coil	10026
2006-2000	8 Cyl. 4.8L; 9.0mm High Performance Wire; Round Coil	10039
2006-2000	8 Cyl. 5.3L; 9.0mm High Performance Wire; Round Coil	10039
2000-1999	8 Cyl. 5.7L; Denali; 8.5mm High Performance Wire	10021
2000-1999	8 Cyl. 5.7L; Denali; 8.5mm High Performance Wire; Equipped with Ceramic Spark Plug Boots	10072
1999-1996	8 Cyl. 5.7L; 8.5mm High Performance Wire; Equipped with Ceramic Spark Plug Boots	10072
1999-1996	8 Cyl. 5.7L; 8.5mm High Performance Wire	10021
1995-1992	8 Cyl. 5.7L; 8.5mm High Performance Wire	10018
1995-1992	8 Cyl. 5.7L; 9.0mm High Performance Wire	10038
1995-1992	8 Cyl. 5.7L; 8.5mm High Performance Wire; Equipped with Ceramic Spark Plug Boots	10046
Yukon XL 1500		
2010-2009	8 Cyl. 5.3L; 8.5mm High Performance Wire	10026
2010-2009	8 Cyl. 6.2L; 9.0mm High Performance Wire	10039
2010-2009	8 Cyl. 5.3L; 9.0mm High Performance Wire	10039

Wire Sets

Year	Model/Engine	Part No.
Spark Plug Wire Set		
Yukon XL 1500		
2010-2009	8 Cyl. 6.2L; 8.5mm High Performance Wire	10026
2009	8 Cyl. 6.0L; 8.5mm High Performance Wire	10026
2009	8 Cyl. 6.0L; 9.0mm High Performance Wire	10039
2008-2007	8 Cyl. 5.3L; 8.5mm High Performance Wire	10041
2008-2007	8 Cyl. 5.3L; 9.0mm High Performance Wire	10042
2006-2001	8 Cyl. 6.0L; Denali; 9.0mm High Performance Wire; Round Coil	10039
2006-2001	8 Cyl. 6.0L; 8.5mm High Performance Wire; Square Coil	10074
2006-2001	8 Cyl. 6.0L; 8.5mm High Performance Wire; Equipped with Ceramic Spark Plug Boots; Square Coil	10075
2006-2001	8 Cyl. 6.0L; Denali; 8.5mm High Performance Wire; Round Coil	10026
2006-2000	8 Cyl. 5.3L; 9.0mm High Performance Wire; Round Coil	10039
2006-2000	8 Cyl. 5.3L; 8.5mm High Performance Wire; Equipped with Ceramic Spark Plug Boots; Square Coil	10075
2006-2000	8 Cyl. 5.3L; 8.5mm High Performance Wire; Round Coil	10026
2006-2000	8 Cyl. 5.3L; 8.5mm High Performance Wire; Square Coil	10074
Yukon XL 2500		
2010-2009	8 Cyl. 6.0L; 9.0mm High Performance Wire	10039
2010-2009	8 Cyl. 6.0L; 8.5mm High Performance Wire	10026
2006-2000	8 Cyl. 6.0L; 8.5mm High Performance Wire; Square Coil	10074
2006-2000	8 Cyl. 6.0L; 9.0mm High Performance Wire; Round Coil	10039
2006-2000	8 Cyl. 6.0L; 8.5mm High Performance Wire; Round Coil	10026
2006-2000	8 Cyl. 6.0L; 8.5mm High Performance Wire; Equipped with Ceramic Spark Plug Boots; Square Coil	10075
Honda		
Wire Sets		
Spark Plug Wire Set		
Accord		
1997	4 Cyl. 2.2L; SE; 8.5mm High Performance Wire	10025
1997-1996	4 Cyl. 2.2L; LX; 8.5mm High Performance Wire	10025
1997-1996	4 Cyl. 2.2L; DX; 8.5mm High Performance Wire	10025
1995-1994	4 Cyl. 2.2L; LX; 8.5mm High Performance Wire	10025
1995-1994	4 Cyl. 2.2L; DX; 8.5mm High Performance Wire	10025
1993-1990	4 Cyl. 2.2L; 8.5mm High Performance Wire	10025
Prelude		
1996-1993	4 Cyl. 2.2L; S; 8.5mm High Performance Wire	10025
1996-1992	4 Cyl. 2.3L; 8.5mm High Performance Wire	10025
1992	4 Cyl. 2.2L; 8.5mm High Performance Wire	10025

Year	Model/Engine	Part No.
Hummer		
Wire Sets		
Spark Plug Wire Set		
H2		
2009	8 Cyl. 6.2L; 9.0mm High Performance Wire	10039
2009	8 Cyl. 6.2L; 8.5mm High Performance Wire	10026
2007-2005	8 Cyl. 6.0L; 9.0mm High Performance Wire; Round Coil	10039
2007-2005	8 Cyl. 6.0L; 8.5mm High Performance Wire; Square Coil	10074
2007-2005	8 Cyl. 6.0L; 8.5mm High Performance Wire; Equipped with Ceramic Spark Plug Boots; Square Coil	10075
2007-2005	8 Cyl. 6.0L; 8.5mm High Performance Wire; Round Coil	10026
2004-2003	8 Cyl. 6.0L; 9.0mm High Performance Wire; Round Coil	10039
2004-2003	8 Cyl. 6.0L; 8.5mm High Performance Wire; Round Coil	10026
2004-2003	8 Cyl. 6.0L; 8.5mm High Performance Wire; Equipped with Ceramic Spark Plug Boots; Square Coil	10075
2004-2003	8 Cyl. 6.0L; 8.5mm High Performance Wire; Square Coil	10074
H3		
2010	8 Cyl. 5.3L; 9.0mm High Performance Wire	10039
2010	8 Cyl. 5.3L; 8.5mm High Performance Wire	10026
2009	8 Cyl. 5.3L; 8.5mm High Performance Wire	10026
2009	8 Cyl. 5.3L; 9.0mm High Performance Wire	10039
2008	8 Cyl. 5.3L; 8.5mm High Performance Wire	10041
2008	8 Cyl. 5.3L; 9.0mm High Performance Wire	10042
H3T		
2010	8 Cyl. 5.3L; 9.0mm High Performance Wire	10039
2010	8 Cyl. 5.3L; 8.5mm High Performance Wire	10026
2009	8 Cyl. 5.3L; 8.5mm High Performance Wire	10026
2009	8 Cyl. 5.3L; 9.0mm High Performance Wire	10039
Isuzu		
Wire Sets		
Spark Plug Wire Set		
Ascender		
2006	8 Cyl. 5.3L; 9.0mm High Performance Wire	10042
2006	8 Cyl. 5.3L; 8.5mm High Performance Wire	10041
2005	8 Cyl. 5.3L; 8.5mm High Performance Wire	10041
2005	8 Cyl. 5.3L; 9.0mm High Performance Wire	10042
2004-2003	8 Cyl. 5.3L; 9.0mm High Performance Wire	10042
2004-2003	8 Cyl. 5.3L; 8.5mm High Performance Wire	10041
Hombre		
2000-1997	6 Cyl. 4.3L; 8.5mm High Performance Wire	10077

Wire Sets

Year	Model/Engine	Part No.
Spark Plug Wire Set		
Hombre		
2000-1997	6 Cyl. 4.3L; 8.5mm High Performance Wire; Equipped with Ceramic Spark Plug Boots	10078
Pickup		
1994-1991	6 Cyl. 3.1L; 8.5mm High Performance Wire	10057
1994-1991	6 Cyl. 3.1L; 8.5mm High Performance Wire; Equipped with Ceramic Spark Plug Boots	10058
Rodeo		
1992-1991	6 Cyl. 3.1L; 8.5mm High Performance Wire; Equipped with Ceramic Spark Plug Boots	10058
1992-1991	6 Cyl. 3.1L; 8.5mm High Performance Wire	10057
Trooper		
1991-1989	6 Cyl. 2.8L; 8.5mm High Performance Wire	10057
1991-1989	6 Cyl. 2.8L; 8.5mm High Performance Wire; Equipped with Ceramic Spark Plug Boots	10058
Jeep		
Wire Sets		
Spark Plug Wire Set		
Cherokee		
1999-1998	6 Cyl. 4.0L; 8.5mm High Performance Wire	10020
1997-1991	6 Cyl. 4.0L; 8.5mm High Performance Wire	10020
1986-1984	6 Cyl. 2.8L; 8.5mm High Performance Wire; Equipped with Ceramic Spark Plug Boots	10058
1986-1984	6 Cyl. 2.8L; 8.5mm High Performance Wire	10057
1983-1975	8 Cyl. 5.9L; 8.5mm High Performance Wire; w/ Straight Non-Bendable Spark Plug Boot	10006
1983-1975	8 Cyl. 5.9L; 8.5mm High Performance Wire; Equipped with Ceramic Spark Plug Boots	10114
1983-1975	8 Cyl. 5.9L; 8.5mm High Performance Wire; w/ Straight Bendable Spark Plug Boot	10116
1978-1975	8 Cyl. 6.6L; 8.5mm High Performance Wire; w/ Straight Non-Bendable Spark Plug Boot	10006
1978-1975	8 Cyl. 6.6L; 8.5mm High Performance Wire; Equipped with Ceramic Spark Plug Boots	10114
1978-1975	8 Cyl. 6.6L; 8.5mm High Performance Wire; w/ Straight Bendable Spark Plug Boot	10116
1974	8 Cyl. 5.9L; 8.5mm High Performance Wire	10008
1974	8 Cyl. 5.9L; 8.5mm High Performance Wire; Equipped with Ceramic Spark Plug Boots	10059
1974	8 Cyl. 6.6L; 8.5mm High Performance Wire	10008
1974	8 Cyl. 6.6L; 8.5mm High Performance Wire; Equipped with Ceramic Spark Plug Boots	10059
CJ5		
1981-1975	8 Cyl. 5.0L; 8.5mm High Performance Wire; w/ Straight Non-Bendable Spark Plug Boot	10006

Year	Model/Engine	Part No.
Spark Plug Wire Set		
CJ5		
1981-1975	8 Cyl. 5.0L; 8.5mm High Performance Wire; Equipped with Ceramic Spark Plug Boots	10114
1981-1975	8 Cyl. 5.0L; 8.5mm High Performance Wire; w/ Straight Bendable Spark Plug Boot	10116
1974	8 Cyl. 5.0L; 8.5mm High Performance Wire; Equipped with Ceramic Spark Plug Boots	10059
1974	8 Cyl. 5.0L; 8.5mm High Performance Wire	10008
1973-1972	8 Cyl. 5.0L; 8.5mm High Performance Wire; w/ Straight Non-Bendable Spark Plug Boot	10006
1973-1972	8 Cyl. 5.0L; 8.5mm High Performance Wire; Equipped with Ceramic Spark Plug Boots	10114
1973-1972	8 Cyl. 5.0L; 8.5mm High Performance Wire; w/ Straight Bendable Spark Plug Boot	10116
CJ6		
1975	8 Cyl. 5.0L; 8.5mm High Performance Wire; w/ Straight Non-Bendable Spark Plug Boot	10006
1975	8 Cyl. 5.0L; 8.5mm High Performance Wire; Equipped with Ceramic Spark Plug Boots	10114
1975	8 Cyl. 5.0L; 8.5mm High Performance Wire; w/ Straight Bendable Spark Plug Boot	10116
1974	8 Cyl. 5.0L; 8.5mm High Performance Wire	10008
1974	8 Cyl. 5.0L; 8.5mm High Performance Wire; Equipped with Ceramic Spark Plug Boots	10059
1973-1972	8 Cyl. 5.0L; 8.5mm High Performance Wire; w/ Straight Non-Bendable Spark Plug Boot	10006
1973-1972	8 Cyl. 5.0L; 8.5mm High Performance Wire; Equipped with Ceramic Spark Plug Boots	10114
1973-1972	8 Cyl. 5.0L; 8.5mm High Performance Wire; w/ Straight Bendable Spark Plug Boot	10116
CJ7		
1981-1976	8 Cyl. 5.0L; 8.5mm High Performance Wire; Equipped with Ceramic Spark Plug Boots	10114
1981-1976	8 Cyl. 5.0L; 8.5mm High Performance Wire; w/ Straight Non-Bendable Spark Plug Boot	10006
1981-1976	8 Cyl. 5.0L; 8.5mm High Performance Wire; w/ Straight Bendable Spark Plug Boot	10116
Comanche		
1992-1991	6 Cyl. 4.0L; 8.5mm High Performance Wire	10020
1986	6 Cyl. 2.8L; 8.5mm High Performance Wire	10057
1986	6 Cyl. 2.8L; 8.5mm High Performance Wire; Equipped with Ceramic Spark Plug Boots	10058
Commando		
1973-1972	8 Cyl. 5.0L; 8.5mm High Performance Wire; Equipped with Ceramic Spark Plug Boots	10114
1973-1972	8 Cyl. 5.0L; 8.5mm High Performance Wire; w/ Straight Non-Bendable Spark Plug Boot	10006

Wire Sets

Year	Model/Engine	Part No.
Spark Plug Wire Set		
Commando		
1973-1972	8 Cyl. 5.0L; 8.5mm High Performance Wire; w/ Straight Bendable Spark Plug Boot	10116
Gladiator		
1967-1965	8 Cyl.; 327; 8.5mm High Performance Wire	10008
1967-1965	8 Cyl.; 327; 8.5mm High Performance Wire; Equipped with Ceramic Spark Plug Boots	10059
Grand Cherokee		
1998	8 Cyl. 5.9L; 8.5mm High Performance Wire	10016 ¹
1998	8 Cyl. 5.9L; 8.5mm High Performance Wire; Equipped with Ceramic Spark Plug Boots	10073
1998-1995	6 Cyl. 4.0L; 8.5mm High Performance Wire	10020
1998-1995	8 Cyl. 5.2L; 8.5mm High Performance Wire	10016 ¹
1998-1995	8 Cyl. 5.2L; 8.5mm High Performance Wire; Equipped with Ceramic Spark Plug Boots	10073
1994-1993	6 Cyl. 4.0L; 8.5mm High Performance Wire	10020
1994-1993	8 Cyl. 5.2L; 8.5mm High Performance Wire; Equipped with Ceramic Spark Plug Boots	10073
1994-1993	8 Cyl. 5.2L; 8.5mm High Performance Wire	10016 ¹
Grand Wagoneer		
1993	8 Cyl. 5.2L; 8.5mm High Performance Wire; Equipped with Ceramic Spark Plug Boots	10073
1993	8 Cyl. 5.2L; 8.5mm High Performance Wire	10016 ¹
1991-1984	8 Cyl. 5.9L; 8.5mm High Performance Wire; w/ Straight Non-Bendable Spark Plug Boot	10006
1991-1984	8 Cyl. 5.9L; 8.5mm High Performance Wire; Equipped with Ceramic Spark Plug Boots	10114
1991-1984	8 Cyl. 5.9L; 8.5mm High Performance Wire; w/ Straight Bendable Spark Plug Boot	10116
J10		
1988-1975	8 Cyl. 5.9L; 8.5mm High Performance Wire; w/ Straight Non-Bendable Spark Plug Boot	10006
1988-1975	8 Cyl. 5.9L; 8.5mm High Performance Wire; Equipped with Ceramic Spark Plug Boots	10114
1988-1975	8 Cyl. 5.9L; 8.5mm High Performance Wire; w/ Straight Bendable Spark Plug Boot	10116
1978-1975	8 Cyl. 6.6L; 8.5mm High Performance Wire; Equipped with Ceramic Spark Plug Boots	10114
1978-1975	8 Cyl. 6.6L; 8.5mm High Performance Wire; w/ Straight Non-Bendable Spark Plug Boot	10006
1978-1975	8 Cyl. 6.6L; 8.5mm High Performance Wire; w/ Straight Bendable Spark Plug Boot	10116
1974	8 Cyl. 5.9L; 8.5mm High Performance Wire	10008
1974	8 Cyl. 6.6L; 8.5mm High Performance Wire	10008
1974	8 Cyl. 6.6L; 8.5mm High Performance Wire; Equipped with Ceramic Spark Plug Boots	10059

Year	Model/Engine	Part No.
Spark Plug Wire Set		
J10		
1974	8 Cyl. 5.9L; 8.5mm High Performance Wire; Equipped with Ceramic Spark Plug Boots	10059
J20		
1988-1975	8 Cyl. 5.9L; 8.5mm High Performance Wire; Equipped with Ceramic Spark Plug Boots	10114
1988-1975	8 Cyl. 5.9L; 8.5mm High Performance Wire; w/ Straight Non-Bendable Spark Plug Boot	10006
1988-1975	8 Cyl. 5.9L; 8.5mm High Performance Wire; w/ Straight Bendable Spark Plug Boot	10116
1978-1975	8 Cyl. 6.6L; 8.5mm High Performance Wire; w/ Straight Non-Bendable Spark Plug Boot	10006
1978-1975	8 Cyl. 6.6L; 8.5mm High Performance Wire; Equipped with Ceramic Spark Plug Boots	10114
1978-1975	8 Cyl. 6.6L; 8.5mm High Performance Wire; w/ Straight Bendable Spark Plug Boot	10116
1974	8 Cyl. 5.9L; 8.5mm High Performance Wire	10008
1974	8 Cyl. 6.6L; 8.5mm High Performance Wire	10008
1974	8 Cyl. 6.6L; 8.5mm High Performance Wire; Equipped with Ceramic Spark Plug Boots	10059
1974	8 Cyl. 5.9L; 8.5mm High Performance Wire; Equipped with Ceramic Spark Plug Boots	10059
J-100		
1968	8 Cyl. 5.4L; 8.5mm High Performance Wire; Equipped with Ceramic Spark Plug Boots	10059
1968	8 Cyl. 5.4L; 8.5mm High Performance Wire	10008
1967-1965	8 Cyl. 5.3L; 8.5mm High Performance Wire	10008
1967-1965	8 Cyl. 5.3L; 8.5mm High Performance Wire; Equipped with Ceramic Spark Plug Boots	10059
J-2500		
1973-1972	8 Cyl. 5.9L; 8.5mm High Performance Wire; w/ Straight Non-Bendable Spark Plug Boot	10006
1973-1972	8 Cyl. 5.9L; 8.5mm High Performance Wire; Equipped with Ceramic Spark Plug Boots	10114
1973-1972	8 Cyl. 5.9L; 8.5mm High Performance Wire; w/ Straight Bendable Spark Plug Boot	10116
1972-1971	8 Cyl. 5.0L; 8.5mm High Performance Wire; w/ Straight Non-Bendable Spark Plug Boot	10006
1972-1971	8 Cyl. 5.0L; 8.5mm High Performance Wire; Equipped with Ceramic Spark Plug Boots	10114
1972-1971	8 Cyl. 5.0L; 8.5mm High Performance Wire; w/ Straight Bendable Spark Plug Boot	10116
1968-1965	8 Cyl.; 327; 8.5mm High Performance Wire	10008
1968-1965	8 Cyl.; 327; 8.5mm High Performance Wire; Equipped with Ceramic Spark Plug Boots	10059

Wire Sets

Year	Model/Engine	Part No.
Spark Plug Wire Set		
J-2600		
1973-1972	8 Cyl. 5.9L; 8.5mm High Performance Wire; Equipped with Ceramic Spark Plug Boots	10114
1973-1972	8 Cyl. 5.9L; 8.5mm High Performance Wire; w/ Straight Non-Bendable Spark Plug Boot	10006
1973-1972	8 Cyl. 5.9L; 8.5mm High Performance Wire; w/ Straight Bendable Spark Plug Boot	10116
1972	8 Cyl. 5.0L; 8.5mm High Performance Wire; Equipped with Ceramic Spark Plug Boots	10114
1972	8 Cyl. 5.0L; 8.5mm High Performance Wire; w/ Straight Non-Bendable Spark Plug Boot	10006
1972	8 Cyl. 5.0L; 8.5mm High Performance Wire; w/ Straight Bendable Spark Plug Boot	10116
1968	8 Cyl.; 327; 8.5mm High Performance Wire; Equipped with Ceramic Spark Plug Boots	10059
1968	8 Cyl.; 327; 8.5mm High Performance Wire	10008
1965	8 Cyl.; 327; 8.5mm High Performance Wire; Equipped with Ceramic Spark Plug Boots	10059
1965	8 Cyl.; 327; 8.5mm High Performance Wire	10008
J-2700		
1968	8 Cyl.; 327; 8.5mm High Performance Wire; Equipped with Ceramic Spark Plug Boots	10059
1968	8 Cyl.; 327; 8.5mm High Performance Wire	10008
1965	8 Cyl.; 327; 8.5mm High Performance Wire	10008
1965	8 Cyl.; 327; 8.5mm High Performance Wire; Equipped with Ceramic Spark Plug Boots	10059
J-2800		
1968	8 Cyl.; 327; 8.5mm High Performance Wire	10008
1968	8 Cyl.; 327; 8.5mm High Performance Wire; Equipped with Ceramic Spark Plug Boots	10059
1965	8 Cyl.; 327; 8.5mm High Performance Wire	10008
1965	8 Cyl.; 327; 8.5mm High Performance Wire; Equipped with Ceramic Spark Plug Boots	10059
J-3500		
1968	8 Cyl.; 327; 8.5mm High Performance Wire; Equipped with Ceramic Spark Plug Boots	10059
1968	8 Cyl.; 327; 8.5mm High Performance Wire	10008
1965	8 Cyl.; 327; 8.5mm High Performance Wire	10008
1965	8 Cyl.; 327; 8.5mm High Performance Wire; Equipped with Ceramic Spark Plug Boots	10059
J-3600		
1968	8 Cyl. 5.4L; 8.5mm High Performance Wire; Equipped with Ceramic Spark Plug Boots	10059
1968	8 Cyl. 5.4L; 8.5mm High Performance Wire	10008
1965	8 Cyl. 5.3L; 8.5mm High Performance Wire	10008

Year	Model/Engine	Part No.
Spark Plug Wire Set		
J-3600		
1965	8 Cyl. 5.3L; 8.5mm High Performance Wire; Equipped with Ceramic Spark Plug Boots	10059
J-3700		
1968	8 Cyl.; 327; 8.5mm High Performance Wire; Equipped with Ceramic Spark Plug Boots	10059
1968	8 Cyl.; 327; 8.5mm High Performance Wire	10008
1965	8 Cyl.; 327; 8.5mm High Performance Wire; Equipped with Ceramic Spark Plug Boots	10059
1965	8 Cyl.; 327; 8.5mm High Performance Wire	10008
J-3800		
1971	8 Cyl. 5.9L; 8.5mm High Performance Wire; w/ Straight Non-Bendable Spark Plug Boot	10006
1971	8 Cyl. 5.9L; 8.5mm High Performance Wire; Equipped with Ceramic Spark Plug Boots	10114
1971	8 Cyl. 5.9L; 8.5mm High Performance Wire; w/ Straight Bendable Spark Plug Boot	10116
1968	8 Cyl.; 327; 8.5mm High Performance Wire; Equipped with Ceramic Spark Plug Boots	10059
1968	8 Cyl.; 327; 8.5mm High Performance Wire	10008
1965	8 Cyl.; 327; 8.5mm High Performance Wire	10008
1965	8 Cyl.; 327; 8.5mm High Performance Wire; Equipped with Ceramic Spark Plug Boots	10059
J-4500		
1973-1971	8 Cyl. 5.9L; 8.5mm High Performance Wire; Equipped with Ceramic Spark Plug Boots	10114
1973-1971	8 Cyl. 5.9L; 8.5mm High Performance Wire; w/ Straight Non-Bendable Spark Plug Boot	10006
1973-1971	8 Cyl. 5.9L; 8.5mm High Performance Wire; w/ Straight Bendable Spark Plug Boot	10116
1972-1971	8 Cyl. 5.0L; 8.5mm High Performance Wire; w/ Straight Non-Bendable Spark Plug Boot	10006
1972-1971	8 Cyl. 5.0L; 8.5mm High Performance Wire; Equipped with Ceramic Spark Plug Boots	10114
1972-1971	8 Cyl. 5.0L; 8.5mm High Performance Wire; w/ Straight Bendable Spark Plug Boot	10116
J-4600		
1973-1971	8 Cyl. 5.9L; 8.5mm High Performance Wire; w/ Straight Non-Bendable Spark Plug Boot	10006
1973-1971	8 Cyl. 5.9L; 8.5mm High Performance Wire; Equipped with Ceramic Spark Plug Boots	10114
1973-1971	8 Cyl. 5.9L; 8.5mm High Performance Wire; w/ Straight Bendable Spark Plug Boot	10116
1972-1971	8 Cyl. 5.0L; 8.5mm High Performance Wire; w/ Straight Non-Bendable Spark Plug Boot	10006
1972-1971	8 Cyl. 5.0L; 8.5mm High Performance Wire; Equipped with Ceramic Spark Plug Boots	10114

Wire Sets

Year	Model/Engine	Part No.
Spark Plug Wire Set		
J-4600		
1972-1971	8 Cyl. 5.0L; 8.5mm High Performance Wire; w/ Straight Bendable Spark Plug Boot	10116
J-4700		
1973-1971	8 Cyl. 5.9L; 8.5mm High Performance Wire; w/ Straight Non-Bendable Spark Plug Boot	10006
1973-1971	8 Cyl. 5.9L; 8.5mm High Performance Wire; Equipped with Ceramic Spark Plug Boots	10114
1973-1971	8 Cyl. 5.9L; 8.5mm High Performance Wire; w/ Straight Bendable Spark Plug Boot	10116
J-4800		
1973-1971	8 Cyl. 5.9L; 8.5mm High Performance Wire; w/ Straight Non-Bendable Spark Plug Boot	10006
1973-1971	8 Cyl. 5.9L; 8.5mm High Performance Wire; Equipped with Ceramic Spark Plug Boots	10114
1973-1971	8 Cyl. 5.9L; 8.5mm High Performance Wire; w/ Straight Bendable Spark Plug Boot	10116
Jeepster		
1973-1972	8 Cyl. 5.0L; 8.5mm High Performance Wire; w/ Straight Non-Bendable Spark Plug Boot	10006
1973-1972	8 Cyl. 5.0L; 8.5mm High Performance Wire; Equipped with Ceramic Spark Plug Boots	10114
1973-1972	8 Cyl. 5.0L; 8.5mm High Performance Wire; w/ Straight Bendable Spark Plug Boot	10116
TJ		
1999-1997	6 Cyl. 4.0L; 8.5mm High Performance Wire	10020
Wagoneer		
1986-1984	6 Cyl. 2.8L; 8.5mm High Performance Wire	10057
1986-1984	6 Cyl. 2.8L; 8.5mm High Performance Wire; Equipped with Ceramic Spark Plug Boots	10058
1983-1975	8 Cyl. 5.9L; 8.5mm High Performance Wire; w/ Straight Non-Bendable Spark Plug Boot	10006
1983-1975	8 Cyl. 5.9L; 8.5mm High Performance Wire; Equipped with Ceramic Spark Plug Boots	10114
1983-1975	8 Cyl. 5.9L; 8.5mm High Performance Wire; w/ Straight Bendable Spark Plug Boot	10116
1978-1975	8 Cyl. 6.6L; 8.5mm High Performance Wire; w/ Straight Non-Bendable Spark Plug Boot	10006
1978-1975	8 Cyl. 6.6L; 8.5mm High Performance Wire; Equipped with Ceramic Spark Plug Boots	10114
1978-1975	8 Cyl. 6.6L; 8.5mm High Performance Wire; w/ Straight Bendable Spark Plug Boot	10116
1974	8 Cyl. 6.6L; 8.5mm High Performance Wire	10008
1974	8 Cyl. 6.6L; 8.5mm High Performance Wire; Equipped with Ceramic Spark Plug Boots	10059
1974	8 Cyl. 5.9L; 8.5mm High Performance Wire; Equipped with Ceramic Spark Plug Boots	10059
1974	8 Cyl. 5.9L; 8.5mm High Performance Wire	10008

Year	Model/Engine	Part No.
Spark Plug Wire Set		
Wagoneer		
1973-1972	8 Cyl. 5.9L; 8.5mm High Performance Wire; w/ Straight Non-Bendable Spark Plug Boot	10006
1973-1972	8 Cyl. 5.9L; 8.5mm High Performance Wire; Equipped with Ceramic Spark Plug Boots	10114
1973-1972	8 Cyl. 5.9L; 8.5mm High Performance Wire; w/ Straight Bendable Spark Plug Boot	10116
1968-1967	8 Cyl.; 327; 8.5mm High Performance Wire	10008
1968-1967	8 Cyl.; 327; 8.5mm High Performance Wire; Equipped with Ceramic Spark Plug Boots	10059
1966	8 Cyl.; 8.5mm High Performance Wire	10008
1966	8 Cyl.; 8.5mm High Performance Wire; Equipped with Ceramic Spark Plug Boots	10059
1965	8 Cyl.; 327; 8.5mm High Performance Wire	10008
1965	8 Cyl.; 327; 8.5mm High Performance Wire; Equipped with Ceramic Spark Plug Boots	10059
Wrangler		
1999-1998	6 Cyl. 4.0L; 8.5mm High Performance Wire	10020
1997	6 Cyl. 4.0L; 8.5mm High Performance Wire	10020
1995	6 Cyl. 4.0L; 8.5mm High Performance Wire	10020
1994-1991	6 Cyl. 4.0L; 8.5mm High Performance Wire	10020
Lincoln		
Wire Sets		
Spark Plug Wire Set		
Capri		
1959-1958	8 Cyl. 7.0L; 8.5mm High Performance Wire	10008
1959-1958	8 Cyl. 7.0L; 8.5mm High Performance Wire; Equipped with Ceramic Spark Plug Boots	10059
1957-1956	8 Cyl. 6.0L; 8.5mm High Performance Wire	10008
1957-1956	8 Cyl. 6.0L; 8.5mm High Performance Wire; Equipped with Ceramic Spark Plug Boots	10059
1955	8 Cyl. 5.6L; 8.5mm High Performance Wire	10008
1955	8 Cyl. 5.6L; 8.5mm High Performance Wire; Equipped with Ceramic Spark Plug Boots	10059
Continental		
1987-1982	8 Cyl. 5.0L; 8.5mm High Performance Wire	10011
1987-1982	8 Cyl. 5.0L; 8.5mm High Performance Wire; Equipped with Ceramic Spark Plug Boots	10047
1976-1968	8 Cyl. 7.5L; 8.5mm High Performance Wire; Equipped with Ceramic Spark Plug Boots	10059
1976-1968	8 Cyl. 7.5L; 8.5mm High Performance Wire	10008
1968	8 Cyl. 7.6L; 8.5mm High Performance Wire	10008
1968	8 Cyl. 7.6L; 8.5mm High Performance Wire; Equipped with Ceramic Spark Plug Boots	10059

Wire Sets

Year	Model/Engine	Part No.
Spark Plug Wire Set		
Continental		
1968	8 Cyl. 7.0L; 8.5mm High Performance Wire; Equipped with Ceramic Spark Plug Boots	10059
1968	8 Cyl. 7.0L; 8.5mm High Performance Wire	10008
1967-1966	8 Cyl. 7.6L; 8.5mm High Performance Wire; Equipped with Ceramic Spark Plug Boots	10059
1967-1966	8 Cyl. 7.6L; 8.5mm High Performance Wire	10008
1965-1958	8 Cyl. 7.0L; 8.5mm High Performance Wire; Equipped with Ceramic Spark Plug Boots	10059
1965-1958	8 Cyl. 7.0L; 8.5mm High Performance Wire	10008
Custom		
1955	8 Cyl. 5.6L; 8.5mm High Performance Wire	10008
1955	8 Cyl. 5.6L; 8.5mm High Performance Wire; Equipped with Ceramic Spark Plug Boots	10059
Lincoln Series		
1960	8 Cyl. 7.0L; 8.5mm High Performance Wire	10008
1960	8 Cyl. 7.0L; 8.5mm High Performance Wire; Equipped with Ceramic Spark Plug Boots	10059
Mark II		
1957-1956	8 Cyl. 6.0L; 8.5mm High Performance Wire; Equipped with Ceramic Spark Plug Boots	10059
1957-1956	8 Cyl. 6.0L; 8.5mm High Performance Wire	10008
Mark III		
1971-1968	8 Cyl. 7.5L; 8.5mm High Performance Wire	10008
1971-1968	8 Cyl. 7.5L; 8.5mm High Performance Wire; Equipped with Ceramic Spark Plug Boots	10059
1968	8 Cyl. 7.6L; 8.5mm High Performance Wire	10008
1968	8 Cyl. 7.6L; 8.5mm High Performance Wire; Equipped with Ceramic Spark Plug Boots	10059
Mark IV		
1976-1972	8 Cyl. 7.5L; 8.5mm High Performance Wire; Equipped with Ceramic Spark Plug Boots	10059
1976-1972	8 Cyl. 7.5L; 8.5mm High Performance Wire	10008
Mark VI		
1983-1981	8 Cyl. 5.0L; 8.5mm High Performance Wire; Equipped with Ceramic Spark Plug Boots	10047
1983-1981	8 Cyl. 5.0L; 8.5mm High Performance Wire	10011
Mark VII		
1992-1985	8 Cyl. 5.0L; LSC; 8.5mm High Performance Wire; Equipped with Ceramic Spark Plug Boots	10083
1992-1985	8 Cyl. 5.0L; Bill Blass; 8.5mm High Performance Wire; Equipped with Ceramic Spark Plug Boots	10047
1992-1985	8 Cyl. 5.0L; Bill Blass; 8.5mm High Performance Wire	10011
1992-1984	8 Cyl. 5.0L; 8.5mm High Performance Wire	10019
1992-1984	8 Cyl. 5.0L; 9.0mm High Performance Wire	10123

Year	Model/Engine	Part No.
Spark Plug Wire Set		
Mark VII		
1987-1985	8 Cyl. 5.0L; Base; 8.5mm High Performance Wire; Equipped with Ceramic Spark Plug Boots	10047
1987-1985	8 Cyl. 5.0L; Base; 8.5mm High Performance Wire	10011
1985	8 Cyl. 5.0L; Versace; 8.5mm High Performance Wire	10011
1985	8 Cyl. 5.0L; Versace; 8.5mm High Performance Wire; Equipped with Ceramic Spark Plug Boots	10047
1984	8 Cyl. 5.0L; 8.5mm High Performance Wire; Equipped with Ceramic Spark Plug Boots	10083
Premier		
1960-1958	8 Cyl. 7.0L; 8.5mm High Performance Wire	10008
1960-1958	8 Cyl. 7.0L; 8.5mm High Performance Wire; Equipped with Ceramic Spark Plug Boots	10059
1957-1956	8 Cyl. 6.0L; 8.5mm High Performance Wire; Equipped with Ceramic Spark Plug Boots	10059
1957-1956	8 Cyl. 6.0L; 8.5mm High Performance Wire	10008
Mazda		
Wire Sets		
Spark Plug Wire Set		
B2300		
1997-1994	4 Cyl. 2.3L; 8.5mm High Performance Wire; Dual Plug Engine; Equipped with Ceramic Spark Plug Boots	10055
1997-1994	4 Cyl. 2.3L; 8.5mm High Performance Wire; Dual Plug Engine	10054
B3000		
1994	6 Cyl. 3.0L; 8.5mm High Performance Wire	10081
1994	6 Cyl. 3.0L; 8.5mm High Performance Wire; Equipped with Ceramic Spark Plug Boots	10082
B4000		
2000-1994	6 Cyl. 4.0L; 8.5mm High Performance Wire; Equipped with Ceramic Spark Plug Boots	10085
2000-1994	6 Cyl. 4.0L; 8.5mm High Performance Wire	10084
Navajo		
1994-1991	6 Cyl. 4.0L; 8.5mm High Performance Wire; Equipped with Ceramic Spark Plug Boots	10085
1994-1991	6 Cyl. 4.0L; 8.5mm High Performance Wire	10084
Tribute		
2004-2001	4 Cyl. 2.0L; 8.5mm High Performance Wire; DOHC	10029
Mercury		
Wire Sets		
Spark Plug Wire Set		
Breezeway		
1967	8 Cyl. 6.7L; 8.5mm High Performance Wire	10008
1967	8 Cyl. 7.0L; 8.5mm High Performance Wire	10008
1967	8 Cyl. 7.0L; 8.5mm High Performance Wire; Equipped with Ceramic Spark Plug Boots	10059

Wire Sets

Year	Model/Engine	Part No.
Spark Plug Wire Set		
Breezeway		
1967	8 Cyl. 6.7L; 8.5mm High Performance Wire; Equipped with Ceramic Spark Plug Boots	10059
1967	8 Cyl. 6.4L; 8.5mm High Performance Wire; Equipped with Ceramic Spark Plug Boots	10059
1967	8 Cyl. 6.4L; 8.5mm High Performance Wire	10008
1966	8 Cyl. 6.7L; 8.5mm High Performance Wire; Equipped with Ceramic Spark Plug Boots	10059
1966	8 Cyl. 6.7L; 8.5mm High Performance Wire	10008
1966-1965	8 Cyl. 6.4L; 8.5mm High Performance Wire	10008
1966-1965	8 Cyl. 7.0L; 8.5mm High Performance Wire; Equipped with Ceramic Spark Plug Boots	10059
1966-1965	8 Cyl. 6.4L; 8.5mm High Performance Wire; Equipped with Ceramic Spark Plug Boots	10059
1966-1965	8 Cyl. 7.0L; 8.5mm High Performance Wire	10008
Brougham		
1967	8 Cyl. 7.0L; 8.5mm High Performance Wire; Equipped with Ceramic Spark Plug Boots; To 10/2/66	10059
1967	8 Cyl. 6.7L; 8.5mm High Performance Wire; Equipped with Ceramic Spark Plug Boots; To 10/2/66	10059
1967	8 Cyl. 7.0L; 8.5mm High Performance Wire	10008
1967	8 Cyl. 6.7L; 8.5mm High Performance Wire	10008
1967	8 Cyl. 7.0L; 8.5mm High Performance Wire; To 10/2/66	10008
1967	8 Cyl. 6.7L; 8.5mm High Performance Wire; To 10/2/66	10008
1967	8 Cyl. 7.0L; 8.5mm High Performance Wire; Equipped with Ceramic Spark Plug Boots	10059
1967	8 Cyl. 6.7L; 8.5mm High Performance Wire; Equipped with Ceramic Spark Plug Boots	10059
Caliente		
1967	8 Cyl. 6.4L; 8.5mm High Performance Wire; Equipped with Ceramic Spark Plug Boots; To 10/2/66	10059
1967	8 Cyl. 6.4L; 8.5mm High Performance Wire; To 10/2/66	10008
1967-1966	8 Cyl. 6.4L; 8.5mm High Performance Wire; Equipped with Ceramic Spark Plug Boots	10059
1967-1966	8 Cyl. 6.4L; 8.5mm High Performance Wire	10008
1967-1964	8 Cyl. 4.7L; 8.5mm High Performance Wire	10008
1967-1964	8 Cyl. 4.7L; 8.5mm High Performance Wire; Equipped with Ceramic Spark Plug Boots	10059
1965	8 Cyl. 7.0L; 8.5mm High Performance Wire; Equipped with Ceramic Spark Plug Boots	10059
1965	8 Cyl. 7.0L; 8.5mm High Performance Wire	10008
1964	8 Cyl. 4.3L; 8.5mm High Performance Wire	10008
1964	8 Cyl. 4.3L; 8.5mm High Performance Wire; Equipped with Ceramic Spark Plug Boots	10059

Year	Model/Engine	Part No.
Spark Plug Wire Set		
Capri		
1986-1984	8 Cyl. 5.0L; 8.5mm High Performance Wire	10019
1986-1984	8 Cyl. 5.0L; 8.5mm High Performance Wire; Equipped with Ceramic Spark Plug Boots	10083
1986-1984	8 Cyl. 5.0L; 9.0mm High Performance Wire	10123
1983-1982	8 Cyl. 5.0L; 8.5mm High Performance Wire	10011
1983-1982	8 Cyl. 5.0L; 8.5mm High Performance Wire; Equipped with Ceramic Spark Plug Boots	10047
1982-1981	8 Cyl. 4.2L; 8.5mm High Performance Wire	10011
1982-1981	8 Cyl. 4.2L; 8.5mm High Performance Wire; Equipped with Ceramic Spark Plug Boots	10047
Colony Park		
1991-1987	8 Cyl. 5.0L; 8.5mm High Performance Wire	10011
1991-1987	8 Cyl. 5.0L; 8.5mm High Performance Wire; Equipped with Ceramic Spark Plug Boots	10047
1973	8 Cyl. 5.8L; 8.5mm High Performance Wire	10008
1973	8 Cyl. 5.8L; 8.5mm High Performance Wire; Equipped with Ceramic Spark Plug Boots	10059
1973-1972	8 Cyl. 7.5L; 8.5mm High Performance Wire	10008
1973-1972	8 Cyl. 7.5L; 8.5mm High Performance Wire; Equipped with Ceramic Spark Plug Boots	10059
1973-1971	8 Cyl. 6.6L; 8.5mm High Performance Wire	10008
1973-1971	8 Cyl. 6.6L; 8.5mm High Performance Wire; Equipped with Ceramic Spark Plug Boots	10059
1973-1968	8 Cyl. 7.0L; 8.5mm High Performance Wire	10008
1973-1968	8 Cyl. 7.0L; 8.5mm High Performance Wire; Equipped with Ceramic Spark Plug Boots	10059
1971	8 Cyl. 5.8L; 8.5mm High Performance Wire	10008
1971	8 Cyl. 5.8L; 8.5mm High Performance Wire; Equipped with Ceramic Spark Plug Boots	10059
1970-1968	8 Cyl. 6.4L; 8.5mm High Performance Wire	10008
1970-1968	8 Cyl. 6.4L; 8.5mm High Performance Wire; Equipped with Ceramic Spark Plug Boots	10059
1967	8 Cyl. 6.4L; 8.5mm High Performance Wire; Equipped with Ceramic Spark Plug Boots; To 10/2/66	10059
1967	8 Cyl. 6.7L; 8.5mm High Performance Wire; Equipped with Ceramic Spark Plug Boots; To 10/2/66	10059
1967	8 Cyl. 7.0L; 8.5mm High Performance Wire; To 10/2/66	10008
1967	8 Cyl. 6.4L; 8.5mm High Performance Wire; To 10/2/66	10008
1967	8 Cyl. 7.0L; 8.5mm High Performance Wire; Equipped with Ceramic Spark Plug Boots; To 10/2/66	10059
1967	8 Cyl. 6.7L; 8.5mm High Performance Wire; To 10/2/66	10008
1967-1966	8 Cyl. 6.7L; 8.5mm High Performance Wire; To 10/2/66	10008

Wire Sets

Year	Model/Engine	Part No.
Spark Plug Wire Set		
Commuter		
1959	8 Cyl. 7.0L; 8.5mm High Performance Wire	10008
1959-1958	8 Cyl. 6.3L; 8.5mm High Performance Wire; Equipped with Ceramic Spark Plug Boots	10059
1959-1958	8 Cyl. 6.3L; 8.5mm High Performance Wire	10008
Cougar		
2002-2000	4 Cyl. 2.0L; 8.5mm High Performance Wire; DOHC	10029
1999	4 Cyl. 2.0L; 8.5mm High Performance Wire; DOHC; From 5/3/99	10029
1988-1983	8 Cyl. 5.0L; 8.5mm High Performance Wire	10011
1988-1983	8 Cyl. 5.0L; 8.5mm High Performance Wire; Equipped with Ceramic Spark Plug Boots	10047
1982-1981	8 Cyl. 4.2L; 8.5mm High Performance Wire	10011
1982-1981	8 Cyl. 4.2L; 8.5mm High Performance Wire; Equipped with Ceramic Spark Plug Boots	10047
1981	8 Cyl. 5.0L; 8.5mm High Performance Wire	10011
1981	8 Cyl. 5.0L; 8.5mm High Performance Wire; Equipped with Ceramic Spark Plug Boots	10047
1976	8 Cyl. 5.8L; Modified Eng.; 8.5mm High Performance Wire	10008
1976	8 Cyl. 5.8L; Windsor Eng.; 8.5mm High Performance Wire; Equipped with Ceramic Spark Plug Boots	10059
1976	8 Cyl. 5.8L; Windsor Eng.; 8.5mm High Performance Wire	10008
1976	8 Cyl. 5.8L; Modified Eng.; 8.5mm High Performance Wire; Equipped with Ceramic Spark Plug Boots	10059
1976-1973	8 Cyl. 7.5L; 8.5mm High Performance Wire	10008
1976-1973	8 Cyl. 7.5L; 8.5mm High Performance Wire; Equipped with Ceramic Spark Plug Boots	10059
1976-1973	8 Cyl. 6.6L; 8.5mm High Performance Wire; Equipped with Ceramic Spark Plug Boots	10059
1976-1973	8 Cyl. 6.6L; 8.5mm High Performance Wire	10008
1974-1970	8 Cyl. 5.8L; 8.5mm High Performance Wire	10008
1974-1970	8 Cyl. 5.8L; 8.5mm High Performance Wire; Equipped with Ceramic Spark Plug Boots	10059
1971-1968	8 Cyl. 7.0L; 8.5mm High Performance Wire	10008
1971-1968	8 Cyl. 7.0L; 8.5mm High Performance Wire; Equipped with Ceramic Spark Plug Boots	10059
1970	8 Cyl. 5.0L; 8.5mm High Performance Wire	10008
1970	8 Cyl. 5.0L; 8.5mm High Performance Wire; Equipped with Ceramic Spark Plug Boots	10059
1969-1968	8 Cyl. 6.4L; 8.5mm High Performance Wire	10008
1969-1968	8 Cyl. 6.4L; 8.5mm High Performance Wire; Equipped with Ceramic Spark Plug Boots	10059
1968	8 Cyl. 5.0L; 8.5mm High Performance Wire	10008

Year	Model/Engine	Part No.
Spark Plug Wire Set		
Cougar		
1968	8 Cyl. 4.7L; 8.5mm High Performance Wire; Equipped with Ceramic Spark Plug Boots	10059
1968	8 Cyl. 5.0L; 8.5mm High Performance Wire; Equipped with Ceramic Spark Plug Boots	10059
1968	8 Cyl. 4.7L; 8.5mm High Performance Wire	10008
1967	8 Cyl. 4.7L; 8.5mm High Performance Wire	10008
1967	8 Cyl. 4.7L; 8.5mm High Performance Wire; Equipped with Ceramic Spark Plug Boots	10059
1967	8 Cyl. 6.4L; 8.5mm High Performance Wire; Equipped with Ceramic Spark Plug Boots	10059
1967	8 Cyl. 6.4L; 8.5mm High Performance Wire	10008
Country Cruiser		
1963	8 Cyl. 3.6L; 8.5mm High Performance Wire; Equipped with Ceramic Spark Plug Boots	10059
1963	8 Cyl. 3.6L; 8.5mm High Performance Wire	10008
1959	8 Cyl. 7.0L; 8.5mm High Performance Wire	10008
1959	8 Cyl. 6.3L; 8.5mm High Performance Wire	10008
1959	8 Cyl. 6.3L; 8.5mm High Performance Wire; Equipped with Ceramic Spark Plug Boots	10059
1959	8 Cyl. 7.0L; 8.5mm High Performance Wire; Equipped with Ceramic Spark Plug Boots	10059
Cyclone		
1971	8 Cyl. 5.8L; 8.5mm High Performance Wire; Equipped with Ceramic Spark Plug Boots	10059
1971	8 Cyl. 5.8L; 8.5mm High Performance Wire	10008
1971-1968	8 Cyl. 7.0L; 8.5mm High Performance Wire	10008
1971-1968	8 Cyl. 7.0L; 8.5mm High Performance Wire; Equipped with Ceramic Spark Plug Boots	10059
1970-1968	8 Cyl. 5.0L; 8.5mm High Performance Wire	10008
1970-1968	8 Cyl. 5.0L; 8.5mm High Performance Wire; Equipped with Ceramic Spark Plug Boots	10059
1969-1968	8 Cyl. 6.4L; 8.5mm High Performance Wire	10008
1969-1968	8 Cyl. 6.4L; 8.5mm High Performance Wire; Equipped with Ceramic Spark Plug Boots	10059
1967	8 Cyl. 6.4L; 8.5mm High Performance Wire; To 10/2/66	10008
1967	8 Cyl. 6.4L; 8.5mm High Performance Wire; Equipped with Ceramic Spark Plug Boots; To 10/2/66	10059
1967-1966	8 Cyl. 6.4L; 8.5mm High Performance Wire; Equipped with Ceramic Spark Plug Boots	10059
1967-1966	8 Cyl. 6.4L; 8.5mm High Performance Wire	10008
1967-1964	8 Cyl. 4.7L; 8.5mm High Performance Wire	10008
1967-1964	8 Cyl. 4.7L; 8.5mm High Performance Wire; Equipped with Ceramic Spark Plug Boots	10059

Wire Sets

Year	Model/Engine	Part No.
Spark Plug Wire Set		
Cyclone		
1965	8 Cyl. 7.0L; 8.5mm High Performance Wire; Equipped with Ceramic Spark Plug Boots	10059
1965	8 Cyl. 7.0L; 8.5mm High Performance Wire	10008
1964	8 Cyl. 4.3L; 8.5mm High Performance Wire; Equipped with Ceramic Spark Plug Boots	10059
1964	8 Cyl. 4.3L; 8.5mm High Performance Wire	10008
Grand Marquis		
1991-1981	8 Cyl. 5.0L; 8.5mm High Performance Wire	10011
1991-1981	8 Cyl. 5.0L; 8.5mm High Performance Wire; Equipped with Ceramic Spark Plug Boots	10047
1989-1984	8 Cyl. 5.8L; 8.5mm High Performance Wire; Equipped with Ceramic Spark Plug Boots	10083
1989-1984	8 Cyl. 5.8L; 8.5mm High Performance Wire	10019
1989-1984	8 Cyl. 5.8L; 9.0mm High Performance Wire	10123
1983	8 Cyl. 5.8L; 8.5mm High Performance Wire	10011
1983	8 Cyl. 5.8L; 8.5mm High Performance Wire; Equipped with Ceramic Spark Plug Boots	10047
1982-1981	8 Cyl. 4.2L; 8.5mm High Performance Wire	10011
1982-1981	8 Cyl. 4.2L; 8.5mm High Performance Wire; Equipped with Ceramic Spark Plug Boots	10047
1981	8 Cyl. 5.8L; 8.5mm High Performance Wire	10011
1981	8 Cyl. 5.8L; 8.5mm High Performance Wire; Equipped with Ceramic Spark Plug Boots	10047
1976-1975	8 Cyl. 7.5L; 8.5mm High Performance Wire; Equipped with Ceramic Spark Plug Boots	10059
1976-1975	8 Cyl. 7.5L; 8.5mm High Performance Wire	10008
1976-1975	8 Cyl. 6.6L; 8.5mm High Performance Wire	10008
1976-1975	8 Cyl. 6.6L; 8.5mm High Performance Wire; Equipped with Ceramic Spark Plug Boots	10059
Marauder		
1970-1969	8 Cyl. 7.0L; 8.5mm High Performance Wire	10008
1970-1969	8 Cyl. 6.4L; 8.5mm High Performance Wire	10008
1970-1969	8 Cyl. 7.0L; 8.5mm High Performance Wire; Equipped with Ceramic Spark Plug Boots	10059
1970-1969	8 Cyl. 6.4L; 8.5mm High Performance Wire; Equipped with Ceramic Spark Plug Boots	10059
1967	8 Cyl. 6.4L; 8.5mm High Performance Wire; To 10/2/66	10008
1967	8 Cyl. 6.4L; 8.5mm High Performance Wire; Equipped with Ceramic Spark Plug Boots; To 10/2/66	10059
1967-1963	8 Cyl. 6.4L; 8.5mm High Performance Wire	10008
1967-1963	8 Cyl. 6.4L; 8.5mm High Performance Wire; Equipped with Ceramic Spark Plug Boots	10059

Year	Model/Engine	Part No.
Spark Plug Wire Set		
Marauder		
1965	8 Cyl. 7.0L; 8.5mm High Performance Wire	10008
1965	8 Cyl. 7.0L; 8.5mm High Performance Wire; Equipped with Ceramic Spark Plug Boots	10059
Marquis		
1985	8 Cyl. 5.0L; 8.5mm High Performance Wire; Equipped with Ceramic Spark Plug Boots	10083
1985	8 Cyl. 5.0L; 8.5mm High Performance Wire	10019
1985	8 Cyl. 5.0L; 9.0mm High Performance Wire	10123
1982-1981	8 Cyl. 5.0L; 8.5mm High Performance Wire	10011
1982-1981	8 Cyl. 4.2L; 8.5mm High Performance Wire; Equipped with Ceramic Spark Plug Boots	10047
1982-1981	8 Cyl. 5.0L; 8.5mm High Performance Wire; Equipped with Ceramic Spark Plug Boots	10047
1982-1981	8 Cyl. 4.2L; 8.5mm High Performance Wire	10011
1981	8 Cyl. 5.8L; 8.5mm High Performance Wire	10011
1981	8 Cyl. 5.8L; 8.5mm High Performance Wire; Equipped with Ceramic Spark Plug Boots	10047
1976-1975	8 Cyl. 7.5L; 8.5mm High Performance Wire; Equipped with Ceramic Spark Plug Boots	10059
1976-1975	8 Cyl. 7.5L; 8.5mm High Performance Wire	10008
1976-1975	8 Cyl. 6.6L; 8.5mm High Performance Wire	10008
1976-1975	8 Cyl. 6.6L; 8.5mm High Performance Wire; Equipped with Ceramic Spark Plug Boots	10059
1973-1972	8 Cyl. 7.5L; 8.5mm High Performance Wire; Equipped with Ceramic Spark Plug Boots	10059
1973-1972	8 Cyl. 7.5L; 8.5mm High Performance Wire	10008
1973-1972	8 Cyl. 6.6L; 8.5mm High Performance Wire	10008
1973-1972	8 Cyl. 6.6L; 8.5mm High Performance Wire; Equipped with Ceramic Spark Plug Boots	10059
1973-1971	8 Cyl. 5.8L; 8.5mm High Performance Wire	10008
1973-1971	8 Cyl. 5.8L; 8.5mm High Performance Wire; Equipped with Ceramic Spark Plug Boots	10059
1973-1968	8 Cyl. 7.0L; 8.5mm High Performance Wire; Equipped with Ceramic Spark Plug Boots	10059
1973-1968	8 Cyl. 7.0L; 8.5mm High Performance Wire	10008
1970-1968	8 Cyl. 6.4L; 8.5mm High Performance Wire	10008
1970-1968	8 Cyl. 6.4L; 8.5mm High Performance Wire; Equipped with Ceramic Spark Plug Boots	10059
1967	8 Cyl. 7.0L; 8.5mm High Performance Wire; Equipped with Ceramic Spark Plug Boots	10059
1967	8 Cyl. 6.7L; 8.5mm High Performance Wire; To 10/2/66	10008
1967	8 Cyl. 7.0L; 8.5mm High Performance Wire	10008

Wire Sets

Year	Model/Engine	Part No.
Spark Plug Wire Set		
Marquis		
1967	8 Cyl. 6.7L; 8.5mm High Performance Wire; Equipped with Ceramic Spark Plug Boots	10059
1967	8 Cyl. 7.0L; 8.5mm High Performance Wire; To 10/2/66	10008
1967	8 Cyl. 6.7L; 8.5mm High Performance Wire	10008
1967	8 Cyl. 7.0L; 8.5mm High Performance Wire; Equipped with Ceramic Spark Plug Boots; To 10/2/66	10059
1967	8 Cyl. 6.7L; 8.5mm High Performance Wire; Equipped with Ceramic Spark Plug Boots; To 10/2/66	10059
Meteor		
1963-1962	8 Cyl. 3.6L; 8.5mm High Performance Wire	10008
1963-1962	8 Cyl. 3.6L; 8.5mm High Performance Wire; Equipped with Ceramic Spark Plug Boots	10059
1961	8 Cyl. 6.4L; 8.5mm High Performance Wire	10008
1961	8 Cyl. 6.4L; 8.5mm High Performance Wire; Equipped with Ceramic Spark Plug Boots	10059
1961	8 Cyl. 5.8L; 8.5mm High Performance Wire; Equipped with Ceramic Spark Plug Boots	10059
1961	8 Cyl. 5.8L; 8.5mm High Performance Wire	10008
Monarch		
1976-1975	8 Cyl. 5.8L; 8.5mm High Performance Wire; Equipped with Ceramic Spark Plug Boots	10059
1976-1975	8 Cyl. 5.8L; 8.5mm High Performance Wire	10008
1976-1975	8 Cyl. 5.0L; 8.5mm High Performance Wire; Equipped with Ceramic Spark Plug Boots	10059
1976-1975	8 Cyl. 5.0L; 8.5mm High Performance Wire	10008
Montclair		
1968	8 Cyl. 6.4L; 8.5mm High Performance Wire	10008
1968	8 Cyl. 6.4L; 8.5mm High Performance Wire; Equipped with Ceramic Spark Plug Boots	10059
1968	8 Cyl. 7.0L; 8.5mm High Performance Wire; Equipped with Ceramic Spark Plug Boots	10059
1968	8 Cyl. 7.0L; 8.5mm High Performance Wire	10008
1967	8 Cyl. 6.7L; 8.5mm High Performance Wire; Equipped with Ceramic Spark Plug Boots; To 10/2/66	10059
1967	8 Cyl. 6.4L; 8.5mm High Performance Wire; Equipped with Ceramic Spark Plug Boots; To 10/2/66	10059
1967	8 Cyl. 6.4L; 8.5mm High Performance Wire; To 10/2/66	10008
1967	8 Cyl. 7.0L; 8.5mm High Performance Wire; To 10/2/66	10008
1967	8 Cyl. 7.0L; 8.5mm High Performance Wire; Equipped with Ceramic Spark Plug Boots; To 10/2/66	10059
1967	8 Cyl. 6.7L; 8.5mm High Performance Wire; To 10/2/66	10008
1967-1966	8 Cyl. 6.7L; 8.5mm High Performance Wire	10008

Year	Model/Engine	Part No.
Spark Plug Wire Set		
Montclair		
1967-1966	8 Cyl. 6.7L; 8.5mm High Performance Wire; Equipped with Ceramic Spark Plug Boots	10059
1967-1965	8 Cyl. 7.0L; 8.5mm High Performance Wire; Equipped with Ceramic Spark Plug Boots	10059
1967-1965	8 Cyl. 7.0L; 8.5mm High Performance Wire	10008
1967-1964	8 Cyl. 6.4L; 8.5mm High Performance Wire; Equipped with Ceramic Spark Plug Boots	10059
1967-1964	8 Cyl. 6.4L; 8.5mm High Performance Wire	10008
1959-1958	8 Cyl. 6.3L; 8.5mm High Performance Wire	10008
1959-1958	8 Cyl. 6.3L; 8.5mm High Performance Wire; Equipped with Ceramic Spark Plug Boots	10059
1959-1958	8 Cyl. 7.0L; 8.5mm High Performance Wire; Equipped with Ceramic Spark Plug Boots	10059
1959-1958	8 Cyl. 7.0L; 8.5mm High Performance Wire	10008
1957	8 Cyl. 6.0L; 8.5mm High Performance Wire	10008
1957	8 Cyl. 6.0L; 8.5mm High Performance Wire; Equipped with Ceramic Spark Plug Boots	10059
Montego		
1976	8 Cyl. 5.8L; Modified Eng.; 8.5mm High Performance Wire	10008
1976	8 Cyl. 5.8L; Modified Eng.; 8.5mm High Performance Wire; Equipped with Ceramic Spark Plug Boots	10059
1976	8 Cyl. 5.8L; Windsor Eng.; 8.5mm High Performance Wire	10008
1976	8 Cyl. 5.8L; Windsor Eng.; 8.5mm High Performance Wire; Equipped with Ceramic Spark Plug Boots	10059
1976-1973	8 Cyl. 7.5L; 8.5mm High Performance Wire	10008
1976-1973	8 Cyl. 7.5L; 8.5mm High Performance Wire; Equipped with Ceramic Spark Plug Boots	10059
1976-1972	8 Cyl. 6.6L; 8.5mm High Performance Wire; Equipped with Ceramic Spark Plug Boots	10059
1976-1972	8 Cyl. 6.6L; 8.5mm High Performance Wire	10008
1975-1971	8 Cyl. 5.8L; 8.5mm High Performance Wire; Equipped with Ceramic Spark Plug Boots	10059
1975-1971	8 Cyl. 5.8L; 8.5mm High Performance Wire	10008
1974-1968	8 Cyl. 5.0L; 8.5mm High Performance Wire; Equipped with Ceramic Spark Plug Boots	10059
1974-1968	8 Cyl. 5.0L; 8.5mm High Performance Wire	10008
1973-1968	8 Cyl. 7.0L; 8.5mm High Performance Wire	10008
1973-1968	8 Cyl. 7.0L; 8.5mm High Performance Wire; Equipped with Ceramic Spark Plug Boots	10059
1969-1968	8 Cyl. 6.4L; 8.5mm High Performance Wire; Equipped with Ceramic Spark Plug Boots	10059
1969-1968	8 Cyl. 6.4L; 8.5mm High Performance Wire	10008

Wire Sets

Year	Model/Engine	Part No.
Spark Plug Wire Set		
Monterey		
1973-1972	8 Cyl. 7.5L; 8.5mm High Performance Wire	10008
1973-1972	8 Cyl. 7.5L; 8.5mm High Performance Wire; Equipped with Ceramic Spark Plug Boots	10059
1973-1971	8 Cyl. 5.8L; 8.5mm High Performance Wire	10008
1973-1971	8 Cyl. 5.8L; 8.5mm High Performance Wire; Equipped with Ceramic Spark Plug Boots	10059
1973-1971	8 Cyl. 6.6L; 8.5mm High Performance Wire; Equipped with Ceramic Spark Plug Boots	10059
1973-1971	8 Cyl. 6.6L; 8.5mm High Performance Wire	10008
1973-1968	8 Cyl. 7.0L; 8.5mm High Performance Wire; Equipped with Ceramic Spark Plug Boots	10059
1973-1968	8 Cyl. 7.0L; 8.5mm High Performance Wire	10008
1970-1968	8 Cyl. 6.4L; 8.5mm High Performance Wire; Equipped with Ceramic Spark Plug Boots	10059
1970-1968	8 Cyl. 6.4L; 8.5mm High Performance Wire	10008
1967	8 Cyl. 6.4L; 8.5mm High Performance Wire; Equipped with Ceramic Spark Plug Boots; To 10/2/66	10059
1967	8 Cyl. 6.7L; 8.5mm High Performance Wire; Equipped with Ceramic Spark Plug Boots; To 10/2/66	10059
1967	8 Cyl. 6.4L; 8.5mm High Performance Wire; To 10/2/66	10008
1967	8 Cyl. 6.7L; 8.5mm High Performance Wire; To 10/2/66	10008
1967	8 Cyl. 7.0L; 8.5mm High Performance Wire; Equipped with Ceramic Spark Plug Boots; To 10/2/66	10059
1967	8 Cyl. 7.0L; 8.5mm High Performance Wire; To 10/2/66	10008
1967-1966	8 Cyl. 6.7L; 8.5mm High Performance Wire	10008
1967-1966	8 Cyl. 6.7L; 8.5mm High Performance Wire; Equipped with Ceramic Spark Plug Boots	10059
1967-1965	8 Cyl. 7.0L; 8.5mm High Performance Wire	10008
1967-1962	8 Cyl. 6.4L; 8.5mm High Performance Wire	10008
1967-1962	8 Cyl. 6.4L; 8.5mm High Performance Wire; Equipped with Ceramic Spark Plug Boots	10059
1962-1961	8 Cyl. 5.8L; 8.5mm High Performance Wire	10008
1962-1961	8 Cyl. 5.8L; 8.5mm High Performance Wire; Equipped with Ceramic Spark Plug Boots	10059
1959	8 Cyl. 7.0L; 8.5mm High Performance Wire	10008
1959	8 Cyl. 7.0L; 8.5mm High Performance Wire; Equipped with Ceramic Spark Plug Boots	10059
1959-1958	8 Cyl. 6.3L; 8.5mm High Performance Wire	10008
1959-1958	8 Cyl. 6.3L; 8.5mm High Performance Wire; Equipped with Ceramic Spark Plug Boots	10059

Year	Model/Engine	Part No.
Spark Plug Wire Set		
Mystique		
2000	4 Cyl. 2.0L; 8.5mm High Performance Wire; DOHC	10029
1999	4 Cyl. 2.0L; 8.5mm High Performance Wire; DOHC; From 5/3/99	10029
Park Lane		
1968	8 Cyl. 6.4L; 8.5mm High Performance Wire	10008
1968	8 Cyl. 6.4L; 8.5mm High Performance Wire; Equipped with Ceramic Spark Plug Boots	10059
1967	8 Cyl. 6.7L; 8.5mm High Performance Wire; To 10/2/66	10008
1967	8 Cyl. 7.0L; 8.5mm High Performance Wire; Equipped with Ceramic Spark Plug Boots; To 10/2/66	10059
1967	8 Cyl. 7.0L; 8.5mm High Performance Wire; To 10/2/66	10008
1967	8 Cyl. 6.7L; 8.5mm High Performance Wire; Equipped with Ceramic Spark Plug Boots; To 10/2/66	10059
1967-1966	8 Cyl. 6.7L; 8.5mm High Performance Wire	10008
1967-1966	8 Cyl. 6.7L; 8.5mm High Performance Wire; Equipped with Ceramic Spark Plug Boots	10059
1967-1965	8 Cyl. 7.0L; 8.5mm High Performance Wire	10008
1967-1965	8 Cyl. 7.0L; 8.5mm High Performance Wire; Equipped with Ceramic Spark Plug Boots	10059
1966-1964	8 Cyl. 6.4L; 8.5mm High Performance Wire	10008
1966-1964	8 Cyl. 6.4L; 8.5mm High Performance Wire; Equipped with Ceramic Spark Plug Boots	10059
1960-1958	8 Cyl. 7.0L; 8.5mm High Performance Wire	10008
1960-1958	8 Cyl. 7.0L; 8.5mm High Performance Wire; Equipped with Ceramic Spark Plug Boots	10059
1959	8 Cyl. 6.3L; 8.5mm High Performance Wire	10008
1959	8 Cyl. 6.3L; 8.5mm High Performance Wire; Equipped with Ceramic Spark Plug Boots	10059
Parklane		
1968	8 Cyl. 7.0L; 8.5mm High Performance Wire	10008
1968	8 Cyl. 7.0L; 8.5mm High Performance Wire; Equipped with Ceramic Spark Plug Boots	10059
S-55		
1966	8 Cyl. 6.4L; 8.5mm High Performance Wire	10008
1966	8 Cyl. 7.0L; 8.5mm High Performance Wire	10008
1966	8 Cyl. 6.7L; 8.5mm High Performance Wire	10008
1966	8 Cyl. 6.4L; 8.5mm High Performance Wire; Equipped with Ceramic Spark Plug Boots	10059
1966	8 Cyl. 7.0L; 8.5mm High Performance Wire; Equipped with Ceramic Spark Plug Boots	10059
1966	8 Cyl. 6.7L; 8.5mm High Performance Wire; Equipped with Ceramic Spark Plug Boots	10059

Wire Sets

Year	Model/Engine	Part No.
Spark Plug Wire Set		
Turnpike Cruiser		
1957	8 Cyl. 6.0L; 8.5mm High Performance Wire; Equipped with Ceramic Spark Plug Boots	10059
1957	8 Cyl. 6.0L; 8.5mm High Performance Wire	10008
Villager		
1967	8 Cyl. 6.4L; 8.5mm High Performance Wire; Equipped with Ceramic Spark Plug Boots; To 10/2/66	10059
1967	8 Cyl. 6.4L; 8.5mm High Performance Wire; To 10/2/66	10008
1967-1966	8 Cyl. 6.4L; 8.5mm High Performance Wire; Equipped with Ceramic Spark Plug Boots	10059
1967-1966	8 Cyl. 6.4L; 8.5mm High Performance Wire	10008
1967-1964	8 Cyl. 4.7L; 8.5mm High Performance Wire; Equipped with Ceramic Spark Plug Boots	10059
1967-1964	8 Cyl. 4.7L; 8.5mm High Performance Wire	10008
1965	8 Cyl. 7.0L; 8.5mm High Performance Wire	10008
1965	8 Cyl. 7.0L; 8.5mm High Performance Wire; Equipped with Ceramic Spark Plug Boots	10059
1964-1963	8 Cyl. 4.3L; 8.5mm High Performance Wire; Equipped with Ceramic Spark Plug Boots	10059
1964-1963	8 Cyl. 4.3L; 8.5mm High Performance Wire	10008
Voyager		
1967	8 Cyl. 6.4L; 8.5mm High Performance Wire; Equipped with Ceramic Spark Plug Boots; To 10/2/66	10059
1967	8 Cyl. 6.4L; 8.5mm High Performance Wire; To 10/2/66	10008
1967-1966	8 Cyl. 4.7L; 8.5mm High Performance Wire; Equipped with Ceramic Spark Plug Boots	10059
1967-1966	8 Cyl. 6.4L; 8.5mm High Performance Wire	10008
1967-1966	8 Cyl. 6.4L; 8.5mm High Performance Wire; Equipped with Ceramic Spark Plug Boots	10059
1967-1966	8 Cyl. 4.7L; 8.5mm High Performance Wire	10008
1959-1958	8 Cyl. 7.0L; 8.5mm High Performance Wire	10008
1959-1958	8 Cyl. 6.3L; 8.5mm High Performance Wire	10008
1959-1958	8 Cyl. 6.3L; 8.5mm High Performance Wire; Equipped with Ceramic Spark Plug Boots	10059
1959-1958	8 Cyl. 7.0L; 8.5mm High Performance Wire; Equipped with Ceramic Spark Plug Boots	10059
1957	8 Cyl. 6.0L; 8.5mm High Performance Wire; Equipped with Ceramic Spark Plug Boots	10059
1957	8 Cyl. 6.0L; 8.5mm High Performance Wire	10008
Zephyr		
1982-1981	8 Cyl. 4.2L; 8.5mm High Performance Wire	10011
1982-1981	8 Cyl. 4.2L; 8.5mm High Performance Wire; Equipped with Ceramic Spark Plug Boots	10047

Year	Model/Engine	Part No.
Mitsubishi		
Wire Sets		
Spark Plug Wire Set		
Eclipse		
1999-1995	4 Cyl. 2.0L; 8.5mm High Performance Wire; Naturally Aspirated	10024
Oldsmobile		
Wire Sets		
Spark Plug Wire Set		
88		
1957	8 Cyl. 6.1L; 8.5mm High Performance Wire; Equipped with Ceramic Spark Plug Boots	10059
1957	8 Cyl. 6.1L; 8.5mm High Performance Wire	10008
1956-1954	8 Cyl. 5.3L; 8.5mm High Performance Wire; Equipped with Ceramic Spark Plug Boots	10059
1956-1954	8 Cyl. 5.3L; 8.5mm High Performance Wire	10008
1950	8 Cyl. 5.0L; 8.5mm High Performance Wire	10008
1950	8 Cyl. 5.0L; 8.5mm High Performance Wire; Equipped with Ceramic Spark Plug Boots	10059
98		
1974	8 Cyl. 7.5L; 8.5mm High Performance Wire; Exc. High Energy Ignition; Fed.; w/ Straight Non-Bendable Spark Plug Boot	10006
1974	8 Cyl. 7.5L; 8.5mm High Performance Wire; Equipped with Ceramic Spark Plug Boots; Exc. High Energy Ignition; Fed.	10114
1974	8 Cyl. 7.5L; 8.5mm High Performance Wire; Exc. High Energy Ignition; Fed.; w/ Straight Bendable Spark Plug Boot	10116
1973	8 Cyl. 7.5L; 8.5mm High Performance Wire; Equipped with Ceramic Spark Plug Boots; Exc. High Energy Ignition	10059
1973	8 Cyl. 7.5L; 8.5mm High Performance Wire; Exc. High Energy Ignition	10008
1973-1972	8 Cyl. 5.7L; 8.5mm High Performance Wire; Equipped with Ceramic Spark Plug Boots	10059
1973-1972	8 Cyl. 5.7L; 8.5mm High Performance Wire	10008
1972-1968	8 Cyl. 7.5L; 8.5mm High Performance Wire	10008
1972-1968	8 Cyl. 7.5L; 8.5mm High Performance Wire; Equipped with Ceramic Spark Plug Boots	10059
1967-1965	8 Cyl. 7.0L; 8.5mm High Performance Wire; Equipped with Ceramic Spark Plug Boots	10059
1967-1965	8 Cyl. 7.0L; 8.5mm High Performance Wire	10008
1964-1960	8 Cyl. 6.5L; 8.5mm High Performance Wire	10008
1964-1960	8 Cyl. 6.5L; 8.5mm High Performance Wire; Equipped with Ceramic Spark Plug Boots	10059
1959-1958	8 Cyl. 6.1L; 8.5mm High Performance Wire; Equipped with Ceramic Spark Plug Boots	10059
1959-1958	8 Cyl. 6.1L; 8.5mm High Performance Wire	10008
1956-1954	8 Cyl. 5.3L; 8.5mm High Performance Wire; Equipped with Ceramic Spark Plug Boots	10059

Wire Sets

Year	Model/Engine	Part No.
Spark Plug Wire Set		
98		
1956-1954	8 Cyl. 5.3L; 8.5mm High Performance Wire	10008
1953-1950	8 Cyl. 5.0L; 8.5mm High Performance Wire; Equipped with Ceramic Spark Plug Boots	10059
1953-1950	8 Cyl. 5.0L; 8.5mm High Performance Wire	10008
442		
1971-1968	8 Cyl. 7.5L; 8.5mm High Performance Wire; Equipped with Ceramic Spark Plug Boots	10059
1971-1968	8 Cyl. 7.5L; 8.5mm High Performance Wire	10008
1970-1968	8 Cyl. 5.7L; 8.5mm High Performance Wire	10008
1970-1968	8 Cyl. 5.7L; 8.5mm High Performance Wire; Equipped with Ceramic Spark Plug Boots	10059
1969-1968	8 Cyl. 6.6L; 8.5mm High Performance Wire	10008
1969-1968	8 Cyl. 6.6L; 8.5mm High Performance Wire; Equipped with Ceramic Spark Plug Boots	10059
1967-1965	8 Cyl. 6.6L; 8.5mm High Performance Wire; Equipped with Ceramic Spark Plug Boots	10059
1967-1965	8 Cyl. 6.6L; 8.5mm High Performance Wire	10008
Bravada		
2001-1996	6 Cyl. 4.3L; 8.5mm High Performance Wire	10077
2001-1996	6 Cyl. 4.3L; 8.5mm High Performance Wire; Equipped with Ceramic Spark Plug Boots	10078
1994-1991	6 Cyl. 4.3L; 8.5mm High Performance Wire	10014
1994-1991	6 Cyl. 4.3L; 8.5mm High Performance Wire; Equipped with Ceramic Spark Plug Boots	10076
Custom Cruiser		
1979-1978	8 Cyl. 5.7L; 8.5mm High Performance Wire	10010
1979-1978	8 Cyl. 5.7L; 9.0mm High Performance Wire	10037
1979-1978	8 Cyl. 5.7L; 8.5mm High Performance Wire; Equipped with Ceramic Spark Plug Boots	10056
1977	8 Cyl. 5.7L; L; 9.0mm High Performance Wire	10034
1977	8 Cyl. 5.7L; L; 8.5mm High Performance Wire	10002
1977	8 Cyl. 5.7L; L; 8.5mm High Performance Wire; Equipped with Ceramic Spark Plug Boots	10053
1974	8 Cyl. 7.5L; 8.5mm High Performance Wire; Exc. Calif.; Exc. High Energy Ignition; w/ Straight Non-Bendable Spark Plug Boot	10006
1974	8 Cyl. 7.5L; 8.5mm High Performance Wire; Equipped with Ceramic Spark Plug Boots; Exc. Calif.; Exc. High Energy Ignition	10114
1974	8 Cyl. 7.5L; 8.5mm High Performance Wire; Exc. Calif.; Exc. High Energy Ignition; w/ Straight Bendable Spark Plug Boot	10116
1973	8 Cyl. 5.7L; 8.5mm High Performance Wire; Equipped with Ceramic Spark Plug Boots	10059

Year	Model/Engine	Part No.
Spark Plug Wire Set		
Custom Cruiser		
1973	8 Cyl. 5.7L; 8.5mm High Performance Wire	10008
1973	8 Cyl. 7.5L; 8.5mm High Performance Wire; Equipped with Ceramic Spark Plug Boots; Exc. High Energy Ignition	10059
1973	8 Cyl. 7.5L; 8.5mm High Performance Wire; Exc. High Energy Ignition	10008
1972-1971	8 Cyl. 7.5L; 8.5mm High Performance Wire	10008
1972-1971	8 Cyl. 7.5L; 8.5mm High Performance Wire; Equipped with Ceramic Spark Plug Boots	10059
Cutlass		
1986	8 Cyl. 5.0L; 8.5mm High Performance Wire; Canada; Equipped with Ceramic Spark Plug Boots	10056
1986	8 Cyl. 5.0L; 9.0mm High Performance Wire; Canada	10037
1986	8 Cyl. 5.0L; 8.5mm High Performance Wire; Canada	10010
1985	8 Cyl. 5.0L; 8.5mm High Performance Wire; Equipped with Ceramic Spark Plug Boots	10056
1985	8 Cyl. 5.0L; 8.5mm High Performance Wire	10010
1985	8 Cyl. 5.0L; 9.0mm High Performance Wire	10037
1981	8 Cyl. 4.4L; 9.0mm High Performance Wire	10037
1981	8 Cyl. 4.4L; 8.5mm High Performance Wire; Equipped with Ceramic Spark Plug Boots	10056
1981	8 Cyl. 4.4L; 8.5mm High Performance Wire	10010
1980-1979	8 Cyl. 5.0L; 8.5mm High Performance Wire	10010
1980-1979	8 Cyl. 5.0L; 8.5mm High Performance Wire; Equipped with Ceramic Spark Plug Boots	10056
1980-1979	8 Cyl. 5.0L; 9.0mm High Performance Wire	10037
1978	8 Cyl. 5.0L; H; 8.5mm High Performance Wire	10010
1978	8 Cyl. 5.0L; H; 8.5mm High Performance Wire; Equipped with Ceramic Spark Plug Boots	10056
1978	8 Cyl. 5.0L; H; 9.0mm High Performance Wire	10037
1978	8 Cyl. 5.0L; U; 8.5mm High Performance Wire	10010
1978	8 Cyl. 5.0L; U; 8.5mm High Performance Wire; Equipped with Ceramic Spark Plug Boots	10056
1978	8 Cyl. 5.0L; U; 9.0mm High Performance Wire	10037
1974	8 Cyl. 5.7L; 8.5mm High Performance Wire; Equipped with Ceramic Spark Plug Boots; Exc. High Energy Ignition; Fed.	10114
1974	8 Cyl. 7.5L; 8.5mm High Performance Wire; Equipped with Ceramic Spark Plug Boots; Exc. Calif.; Exc. High Energy Ignition	10114
1974	8 Cyl. 5.7L; 8.5mm High Performance Wire; Exc. High Energy Ignition; Fed.; w/ Straight Non-Bendable Spark Plug Boot	10006
1974	8 Cyl. 7.5L; 8.5mm High Performance Wire; Exc. Calif.; Exc. High Energy Ignition; w/ Straight Non-Bendable Spark Plug Boot	10006

Wire Sets

Year	Model/Engine	Part No.
Spark Plug Wire Set		
Cutlass		
1974	8 Cyl. 7.5L; 8.5mm High Performance Wire; Exc. Calif.; Exc. High Energy Ignition; w/ Straight Bendable Spark Plug Boot	10116
1974	8 Cyl. 5.7L; 8.5mm High Performance Wire; Exc. High Energy Ignition; Fed.; w/ Straight Bendable Spark Plug Boot	10116
1973	8 Cyl. 7.5L; 8.5mm High Performance Wire; Exc. High Energy Ignition	10008
1973	8 Cyl. 7.5L; 8.5mm High Performance Wire; Equipped with Ceramic Spark Plug Boots; Exc. High Energy Ignition	10059
1973-1968	8 Cyl. 5.7L; 8.5mm High Performance Wire; Equipped with Ceramic Spark Plug Boots	10059
1973-1968	8 Cyl. 5.7L; 8.5mm High Performance Wire	10008
1972-1970	8 Cyl. 7.5L; 8.5mm High Performance Wire	10008
1972-1970	8 Cyl. 7.5L; 8.5mm High Performance Wire; Equipped with Ceramic Spark Plug Boots	10059
1968	8 Cyl. 6.6L; 8.5mm High Performance Wire	10008
1968	8 Cyl. 6.6L; 8.5mm High Performance Wire; Equipped with Ceramic Spark Plug Boots	10059
1967-1965	8 Cyl. 6.6L; 8.5mm High Performance Wire; Equipped with Ceramic Spark Plug Boots	10059
1967-1965	8 Cyl. 6.6L; 8.5mm High Performance Wire	10008
1967-1964	8 Cyl. 5.4L; 8.5mm High Performance Wire; Equipped with Ceramic Spark Plug Boots	10059
1967-1964	8 Cyl. 5.4L; 8.5mm High Performance Wire	10008
1963-1962	8 Cyl. 3.5L; 8.5mm High Performance Wire; Equipped with Ceramic Spark Plug Boots	10059
1963-1962	8 Cyl. 3.5L; 8.5mm High Performance Wire	10008
Cutlass Calais		
1984	8 Cyl. 5.0L; 9.0mm High Performance Wire	10037
1984	8 Cyl. 5.0L; 8.5mm High Performance Wire	10010
1984	8 Cyl. 5.0L; 8.5mm High Performance Wire; Equipped with Ceramic Spark Plug Boots	10056
1982	8 Cyl. 4.4L; 9.0mm High Performance Wire	10037
1982	8 Cyl. 4.4L; 8.5mm High Performance Wire; Equipped with Ceramic Spark Plug Boots	10056
1982	8 Cyl. 4.4L; 8.5mm High Performance Wire	10010
1980-1979	8 Cyl. 5.0L; 9.0mm High Performance Wire	10037
1980-1979	8 Cyl. 5.0L; 8.5mm High Performance Wire	10010
1980-1979	8 Cyl. 5.0L; 8.5mm High Performance Wire; Equipped with Ceramic Spark Plug Boots	10056
1978	8 Cyl. 5.0L; H; 8.5mm High Performance Wire	10010
1978	8 Cyl. 5.0L; H; 8.5mm High Performance Wire; Equipped with Ceramic Spark Plug Boots	10056
1978	8 Cyl. 5.0L; H; 9.0mm High Performance Wire	10037
1978	8 Cyl. 5.0L; U; 8.5mm High Performance Wire; Equipped with Ceramic Spark Plug Boots	10056
1978	8 Cyl. 5.0L; U; 9.0mm High Performance Wire	10037
1978	8 Cyl. 5.0L; U; 8.5mm High Performance Wire	10010
Cutlass Supreme		
1986-1985	8 Cyl. 5.0L; 8.5mm High Performance Wire; Equipped with Ceramic Spark Plug Boots	10056
1986-1985	8 Cyl. 5.0L; 8.5mm High Performance Wire	10010
1986-1985	8 Cyl. 5.0L; 9.0mm High Performance Wire	10037

Year	Model/Engine	Part No.
Spark Plug Wire Set		
Cutlass Calais		
1978	8 Cyl. 5.0L; H; 8.5mm High Performance Wire; Equipped with Ceramic Spark Plug Boots	10056
1978	8 Cyl. 5.0L; U; 8.5mm High Performance Wire; Equipped with Ceramic Spark Plug Boots	10056
1978	8 Cyl. 5.0L; U; 9.0mm High Performance Wire	10037
1978	8 Cyl. 5.0L; U; 8.5mm High Performance Wire	10010
Cutlass Ciera		
1986-1984	6 Cyl. 2.8L; 8.5mm High Performance Wire	10057
1986-1984	6 Cyl. 2.8L; 8.5mm High Performance Wire; Equipped with Ceramic Spark Plug Boots	10058
Cutlass Cruiser		
1983-1982	8 Cyl. 5.0L; 8.5mm High Performance Wire	10010
1983-1982	8 Cyl. 5.0L; 8.5mm High Performance Wire; Equipped with Ceramic Spark Plug Boots	10056
1983-1982	8 Cyl. 5.0L; 9.0mm High Performance Wire	10037
1982	8 Cyl. 4.4L; 8.5mm High Performance Wire	10010
1982	8 Cyl. 4.4L; 9.0mm High Performance Wire	10037
1982	8 Cyl. 4.4L; 8.5mm High Performance Wire; Equipped with Ceramic Spark Plug Boots	10056
1980	8 Cyl. 5.0L; 8.5mm High Performance Wire	10010
1980	8 Cyl. 5.0L; 8.5mm High Performance Wire; Equipped with Ceramic Spark Plug Boots	10056
1980	8 Cyl. 5.0L; 9.0mm High Performance Wire	10037
Cutlass Salon		
1980-1979	8 Cyl. 5.0L; 9.0mm High Performance Wire	10037
1980-1979	8 Cyl. 5.0L; 8.5mm High Performance Wire	10010
1980-1979	8 Cyl. 5.0L; 8.5mm High Performance Wire; Equipped with Ceramic Spark Plug Boots	10056
1978	8 Cyl. 5.0L; H; 8.5mm High Performance Wire	10010
1978	8 Cyl. 5.0L; H; 8.5mm High Performance Wire; Equipped with Ceramic Spark Plug Boots	10056
1978	8 Cyl. 5.0L; H; 9.0mm High Performance Wire	10037
1978	8 Cyl. 5.0L; U; 8.5mm High Performance Wire; Equipped with Ceramic Spark Plug Boots	10056
1978	8 Cyl. 5.0L; U; 9.0mm High Performance Wire	10037
1978	8 Cyl. 5.0L; U; 8.5mm High Performance Wire	10010
Cutlass Supreme		
1986-1985	8 Cyl. 5.0L; 8.5mm High Performance Wire; Equipped with Ceramic Spark Plug Boots	10056
1986-1985	8 Cyl. 5.0L; 8.5mm High Performance Wire	10010
1986-1985	8 Cyl. 5.0L; 9.0mm High Performance Wire	10037

Wire Sets

Year	Model/Engine	Part No.
Spark Plug Wire Set		
Cutlass Supreme		
1983	8 Cyl. 5.0L; 8.5mm High Performance Wire; Equipped with Ceramic Spark Plug Boots	10056
1983	8 Cyl. 5.0L; 8.5mm High Performance Wire	10010
1983	8 Cyl. 5.0L; 9.0mm High Performance Wire	10037
1982	8 Cyl. 4.4L; 8.5mm High Performance Wire; Equipped with Ceramic Spark Plug Boots	10056
1982	8 Cyl. 4.4L; 9.0mm High Performance Wire	10037
1982	8 Cyl. 4.4L; 8.5mm High Performance Wire	10010
1980-1979	8 Cyl. 5.0L; 8.5mm High Performance Wire; Equipped with Ceramic Spark Plug Boots	10056
1980-1979	8 Cyl. 5.0L; 8.5mm High Performance Wire	10010
1980-1979	8 Cyl. 5.0L; 9.0mm High Performance Wire	10037
1978	8 Cyl. 5.0L; H; 8.5mm High Performance Wire; Equipped with Ceramic Spark Plug Boots	10056
1978	8 Cyl. 5.0L; H; 8.5mm High Performance Wire	10010
1978	8 Cyl. 5.0L; H; 9.0mm High Performance Wire	10037
1978	8 Cyl. 5.7L; L; 8.5mm High Performance Wire	10010
1978	8 Cyl. 5.7L; L; 8.5mm High Performance Wire; Equipped with Ceramic Spark Plug Boots	10056
1978	8 Cyl. 5.7L; L; 9.0mm High Performance Wire	10037
1978	8 Cyl. 5.0L; U; 9.0mm High Performance Wire	10037
1978	8 Cyl. 5.0L; U; 8.5mm High Performance Wire	10010
1978	8 Cyl. 5.0L; U; 8.5mm High Performance Wire; Equipped with Ceramic Spark Plug Boots	10056
1974	8 Cyl. 5.7L; 8.5mm High Performance Wire; Equipped with Ceramic Spark Plug Boots; Exc. High Energy Ignition; Fed.	10114
1974	8 Cyl. 7.5L; 8.5mm High Performance Wire; Exc. Calif.; Exc. High Energy Ignition; w/ Straight Non-Bendable Spark Plug Boot	10006
1974	8 Cyl. 7.5L; 8.5mm High Performance Wire; Equipped with Ceramic Spark Plug Boots; Exc. Calif.; Exc. High Energy Ignition	10114
1974	8 Cyl. 5.7L; 8.5mm High Performance Wire; Exc. High Energy Ignition; Fed.; w/ Straight Non-Bendable Spark Plug Boot	10006
1974	8 Cyl. 7.5L; 8.5mm High Performance Wire; Exc. Calif.; Exc. High Energy Ignition; w/ Straight Bendable Spark Plug Boot	10116
1974	8 Cyl. 5.7L; 8.5mm High Performance Wire; Exc. High Energy Ignition; Fed.; w/ Straight Bendable Spark Plug Boot	10116
1973	8 Cyl. 7.5L; 8.5mm High Performance Wire; Exc. High Energy Ignition	10008
1973	8 Cyl. 7.5L; 8.5mm High Performance Wire; Equipped with Ceramic Spark Plug Boots; Exc. High Energy Ignition	10059
1973-1968	8 Cyl. 5.7L; 8.5mm High Performance Wire	10008

Year	Model/Engine	Part No.
Spark Plug Wire Set		
Cutlass Supreme		
1973-1968	8 Cyl. 5.7L; 8.5mm High Performance Wire; Equipped with Ceramic Spark Plug Boots	10059
1972-1971	8 Cyl. 7.5L; 8.5mm High Performance Wire	10008
1972-1971	8 Cyl. 7.5L; 8.5mm High Performance Wire; Equipped with Ceramic Spark Plug Boots	10059
1967	8 Cyl. 5.4L; 8.5mm High Performance Wire; Equipped with Ceramic Spark Plug Boots	10059
1967	8 Cyl. 5.4L; 8.5mm High Performance Wire	10008
Delmont 88		
1968	8 Cyl. 7.5L; 8.5mm High Performance Wire; Equipped with Ceramic Spark Plug Boots	10059
1968	8 Cyl. 5.7L; 8.5mm High Performance Wire; Equipped with Ceramic Spark Plug Boots	10059
1968	8 Cyl. 5.7L; 8.5mm High Performance Wire	10008
1968	8 Cyl. 7.5L; 8.5mm High Performance Wire	10008
1967	8 Cyl. 5.4L; 8.5mm High Performance Wire	10008
1967	8 Cyl. 7.0L; 8.5mm High Performance Wire	10008
1967	8 Cyl. 5.4L; 8.5mm High Performance Wire; Equipped with Ceramic Spark Plug Boots	10059
1967	8 Cyl. 7.0L; 8.5mm High Performance Wire; Equipped with Ceramic Spark Plug Boots	10059
Delta 88		
1982	8 Cyl. 4.4L; 9.0mm High Performance Wire; Canada; Export	10037
1982	8 Cyl. 4.4L; 8.5mm High Performance Wire; Canada; Equipped with Ceramic Spark Plug Boots; Export	10056
1982	8 Cyl. 4.4L; 8.5mm High Performance Wire; Canada; Export	10010
1981	8 Cyl. 4.4L; 8.5mm High Performance Wire; Equipped with Ceramic Spark Plug Boots	10056
1981	8 Cyl. 4.4L; 8.5mm High Performance Wire	10010
1981	8 Cyl. 4.4L; 9.0mm High Performance Wire	10037
1977	8 Cyl. 5.7L; L; 8.5mm High Performance Wire; Equipped with Ceramic Spark Plug Boots	10053
1977	8 Cyl. 5.7L; L; 8.5mm High Performance Wire	10002
1977	8 Cyl. 5.7L; L; 9.0mm High Performance Wire	10034
1974	8 Cyl. 5.7L; 8.5mm High Performance Wire; Exc. High Energy Ignition; Fed.; w/ Straight Non-Bendable Spark Plug Boot	10006
1974	8 Cyl. 5.7L; 8.5mm High Performance Wire; Equipped with Ceramic Spark Plug Boots; Exc. High Energy Ignition; Fed.	10114
1974	8 Cyl. 7.5L; 8.5mm High Performance Wire; Exc. Calif.; Exc. High Energy Ignition; w/ Straight Non-Bendable Spark Plug Boot	10006
1974	8 Cyl. 7.5L; 8.5mm High Performance Wire; Equipped with Ceramic Spark Plug Boots; Exc. Calif.; Exc. High Energy Ignition	10114

Wire Sets

Year	Model/Engine	Part No.
Spark Plug Wire Set		
Delta 88		
1974	8 Cyl. 5.7L; 8.5mm High Performance Wire; Exc. High Energy Ignition; Fed.; w/ Straight Bendable Spark Plug Boot	10116
1974	8 Cyl. 7.5L; 8.5mm High Performance Wire; Exc. Calif.; Exc. High Energy Ignition; w/ Straight Bendable Spark Plug Boot	10116
1973	8 Cyl. 7.5L; 8.5mm High Performance Wire; Exc. High Energy Ignition	10008
1973	8 Cyl. 7.5L; 8.5mm High Performance Wire; Equipped with Ceramic Spark Plug Boots; Exc. High Energy Ignition	10059
1973-1968	8 Cyl. 5.7L; 8.5mm High Performance Wire; Equipped with Ceramic Spark Plug Boots	10059
1973-1968	8 Cyl. 5.7L; 8.5mm High Performance Wire	10008
1972-1968	8 Cyl. 7.5L; 8.5mm High Performance Wire; Equipped with Ceramic Spark Plug Boots	10059
1972-1968	8 Cyl. 7.5L; 8.5mm High Performance Wire	10008
1967	8 Cyl. 5.4L; 8.5mm High Performance Wire	10008
1967	8 Cyl. 5.4L; 8.5mm High Performance Wire; Equipped with Ceramic Spark Plug Boots	10059
1967-1965	8 Cyl. 7.0L; 8.5mm High Performance Wire	10008
1967-1965	8 Cyl. 7.0L; 8.5mm High Performance Wire; Equipped with Ceramic Spark Plug Boots	10059
Deluxe 88		
1953-1951	8 Cyl. 5.0L; 8.5mm High Performance Wire	10008
1953-1951	8 Cyl. 5.0L; 8.5mm High Performance Wire; Equipped with Ceramic Spark Plug Boots	10059
Dynamic		
1966-1965	8 Cyl. 7.0L; 8.5mm High Performance Wire	10008
1966-1965	8 Cyl. 7.0L; 8.5mm High Performance Wire; Equipped with Ceramic Spark Plug Boots	10059
1964-1960	8 Cyl. 6.5L; 8.5mm High Performance Wire; Equipped with Ceramic Spark Plug Boots	10059
1964-1960	8 Cyl. 6.5L; 8.5mm High Performance Wire	10008
1960-1958	8 Cyl. 6.1L; 8.5mm High Performance Wire	10008
1960-1958	8 Cyl. 6.1L; 8.5mm High Performance Wire; Equipped with Ceramic Spark Plug Boots	10059
F85		
1972	8 Cyl. 7.5L; 8.5mm High Performance Wire	10008
1972	8 Cyl. 7.5L; 8.5mm High Performance Wire; Equipped with Ceramic Spark Plug Boots	10059
1972-1968	8 Cyl. 5.7L; 8.5mm High Performance Wire; Equipped with Ceramic Spark Plug Boots	10059
1972-1968	8 Cyl. 5.7L; 8.5mm High Performance Wire	10008
1970	8 Cyl. 7.5L; 8.5mm High Performance Wire	10008
1970	8 Cyl. 7.5L; 8.5mm High Performance Wire; Equipped with Ceramic Spark Plug Boots	10059

Year	Model/Engine	Part No.
Spark Plug Wire Set		
F85		
1967-1964	8 Cyl. 5.4L; 8.5mm High Performance Wire; Equipped with Ceramic Spark Plug Boots	10059
1967-1964	8 Cyl. 5.4L; 8.5mm High Performance Wire	10008
1966-1965	8 Cyl. 6.6L; 8.5mm High Performance Wire; Equipped with Ceramic Spark Plug Boots	10059
1966-1965	8 Cyl. 6.6L; 8.5mm High Performance Wire	10008
1963-1961	8 Cyl. 3.5L; 8.5mm High Performance Wire	10008
1963-1961	8 Cyl. 3.5L; 8.5mm High Performance Wire; Equipped with Ceramic Spark Plug Boots	10059
Fiesta		
1963-1960	8 Cyl. 6.5L; 8.5mm High Performance Wire	10008
1963-1960	8 Cyl. 6.5L; 8.5mm High Performance Wire; Equipped with Ceramic Spark Plug Boots	10059
1960-1957	8 Cyl. 6.1L; 8.5mm High Performance Wire	10008
1960-1957	8 Cyl. 6.1L; 8.5mm High Performance Wire; Equipped with Ceramic Spark Plug Boots	10059
1953	8 Cyl. 5.0L; 8.5mm High Performance Wire; Equipped with Ceramic Spark Plug Boots	10059
1953	8 Cyl. 5.0L; 8.5mm High Performance Wire	10008
Firenza		
1986-1985	6 Cyl. 2.8L; 8.5mm High Performance Wire	10057
1986-1985	6 Cyl. 2.8L; 8.5mm High Performance Wire; Equipped with Ceramic Spark Plug Boots	10058
Jetfire		
1963-1962	8 Cyl. 3.5L; 8.5mm High Performance Wire	10008
1963-1962	8 Cyl. 3.5L; 8.5mm High Performance Wire; Equipped with Ceramic Spark Plug Boots	10059
Jetstar 88		
1966-1964	8 Cyl. 5.4L; 8.5mm High Performance Wire; Equipped with Ceramic Spark Plug Boots	10059
1966-1964	8 Cyl. 5.4L; 8.5mm High Performance Wire	10008
1965	8 Cyl. 7.0L; 8.5mm High Performance Wire; Equipped with Ceramic Spark Plug Boots	10059
1965	8 Cyl. 7.0L; 8.5mm High Performance Wire	10008
1964	8 Cyl. 6.5L; 8.5mm High Performance Wire	10008
1964	8 Cyl. 6.5L; 8.5mm High Performance Wire; Equipped with Ceramic Spark Plug Boots	10059
Jetstar I		
1965	8 Cyl. 7.0L; 8.5mm High Performance Wire; Equipped with Ceramic Spark Plug Boots	10059
1965	8 Cyl. 7.0L; 8.5mm High Performance Wire	10008
1964	8 Cyl. 6.5L; 8.5mm High Performance Wire; Equipped with Ceramic Spark Plug Boots	10059

Wire Sets

Year	Model/Engine	Part No.
Spark Plug Wire Set		
Jetstar I		
1964	8 Cyl. 6.5L; 8.5mm High Performance Wire	10008
Omega		
1984	6 Cyl. 2.8L; 8.5mm High Performance Wire	10057
1984	6 Cyl. 2.8L; 8.5mm High Performance Wire; Equipped with Ceramic Spark Plug Boots	10058
1979-1977	8 Cyl. 5.7L; 8.5mm High Performance Wire	10002
1979-1977	8 Cyl. 5.0L; 8.5mm High Performance Wire; Equipped with Ceramic Spark Plug Boots	10053
1979-1977	8 Cyl. 5.0L; 9.0mm High Performance Wire	10034
1979-1977	8 Cyl. 5.0L; 8.5mm High Performance Wire	10002
1979-1977	8 Cyl. 5.7L; 9.0mm High Performance Wire	10034
1979-1977	8 Cyl. 5.7L; 8.5mm High Performance Wire; Equipped with Ceramic Spark Plug Boots	10053
1974	8 Cyl. 5.7L; 8.5mm High Performance Wire; Exc. High Energy Ignition; Fed.; w/ Straight Non-Bendable Spark Plug Boot	10006
1974	8 Cyl. 5.7L; 8.5mm High Performance Wire; Equipped with Ceramic Spark Plug Boots; Exc. High Energy Ignition; Fed.	10114
1974	8 Cyl. 5.7L; 8.5mm High Performance Wire; Exc. High Energy Ignition; Fed.; w/ Straight Bendable Spark Plug Boot	10116
1973	8 Cyl. 5.7L; 8.5mm High Performance Wire	10008
1973	8 Cyl. 5.7L; 8.5mm High Performance Wire; Equipped with Ceramic Spark Plug Boots	10059
Standard 88		
1951	8 Cyl. 5.0L; 8.5mm High Performance Wire	10008
1951	8 Cyl. 5.0L; 8.5mm High Performance Wire; Equipped with Ceramic Spark Plug Boots	10059
Starfire		
1979-1977	8 Cyl. 5.0L; 9.0mm High Performance Wire	10034
1979-1977	8 Cyl. 5.0L; 8.5mm High Performance Wire; Equipped with Ceramic Spark Plug Boots	10053
1979-1977	8 Cyl. 5.0L; 8.5mm High Performance Wire	10002
1966-1965	8 Cyl. 7.0L; 8.5mm High Performance Wire	10008
1966-1965	8 Cyl. 7.0L; 8.5mm High Performance Wire; Equipped with Ceramic Spark Plug Boots	10059
1964-1961	8 Cyl. 6.5L; 8.5mm High Performance Wire; Equipped with Ceramic Spark Plug Boots	10059
1964-1961	8 Cyl. 6.5L; 8.5mm High Performance Wire	10008
1957	8 Cyl. 6.1L; 8.5mm High Performance Wire; Equipped with Ceramic Spark Plug Boots	10059
1957	8 Cyl. 6.1L; 8.5mm High Performance Wire	10008
Super 88		
1964-1960	8 Cyl. 6.5L; 8.5mm High Performance Wire	10008

Year	Model/Engine	Part No.
Spark Plug Wire Set		
Super 88		
1964-1960	8 Cyl. 6.5L; 8.5mm High Performance Wire; Equipped with Ceramic Spark Plug Boots	10059
1960-1957	8 Cyl. 6.1L; 8.5mm High Performance Wire; Equipped with Ceramic Spark Plug Boots	10059
1960-1957	8 Cyl. 6.1L; 8.5mm High Performance Wire	10008
1956-1954	8 Cyl. 5.3L; 8.5mm High Performance Wire	10008
1956-1954	8 Cyl. 5.3L; 8.5mm High Performance Wire; Equipped with Ceramic Spark Plug Boots	10059
1953-1951	8 Cyl. 5.0L; 8.5mm High Performance Wire; Equipped with Ceramic Spark Plug Boots	10059
1953-1951	8 Cyl. 5.0L; 8.5mm High Performance Wire	10008
Toronado		
1974-1973	8 Cyl. 7.5L; 8.5mm High Performance Wire; Exc. High Energy Ignition; w/ Straight Non-Bendable Spark Plug Boot	10006
1974-1973	8 Cyl. 7.5L; 8.5mm High Performance Wire; Equipped with Ceramic Spark Plug Boots; Exc. High Energy Ignition	10114
1974-1973	8 Cyl. 7.5L; 8.5mm High Performance Wire; Exc. High Energy Ignition; w/ Straight Bendable Spark Plug Boot	10116
1972-1968	8 Cyl. 7.5L; 8.5mm High Performance Wire	10008
1972-1968	8 Cyl. 7.5L; 8.5mm High Performance Wire; Equipped with Ceramic Spark Plug Boots	10059
1967-1966	8 Cyl. 7.0L; 8.5mm High Performance Wire	10008
1967-1966	8 Cyl. 7.0L; 8.5mm High Performance Wire; Equipped with Ceramic Spark Plug Boots	10059
Vista Cruiser		
1974	8 Cyl. 7.5L; 8.5mm High Performance Wire; Equipped with Ceramic Spark Plug Boots; Exc. Calif.; Exc. High Energy Ignition	10114
1974	8 Cyl. 7.5L; 8.5mm High Performance Wire; Exc. Calif.; Exc. High Energy Ignition; w/ Straight Non-Bendable Spark Plug Boot	10006
1974	8 Cyl. 5.7L; 8.5mm High Performance Wire; Exc. Calif.; Exc. High Energy Ignition; w/ Straight Non-Bendable Spark Plug Boot	10006
1974	8 Cyl. 5.7L; 8.5mm High Performance Wire; Equipped with Ceramic Spark Plug Boots; Exc. Calif.; Exc. High Energy Ignition	10114
1974	8 Cyl. 5.7L; 8.5mm High Performance Wire; Exc. Calif.; Exc. High Energy Ignition; w/ Straight Bendable Spark Plug Boot	10116
1974	8 Cyl. 7.5L; 8.5mm High Performance Wire; Exc. Calif.; Exc. High Energy Ignition; w/ Straight Bendable Spark Plug Boot	10116
1973	8 Cyl. 7.5L; 8.5mm High Performance Wire; Equipped with Ceramic Spark Plug Boots; Exc. High Energy Ignition	10059
1973	8 Cyl. 7.5L; 8.5mm High Performance Wire; Exc. High Energy Ignition	10008
1973-1968	8 Cyl. 5.7L; 8.5mm High Performance Wire	10008

Wire Sets

Year	Model/Engine	Part No.
Spark Plug Wire Set		
Vista Cruiser		
1973-1968	8 Cyl. 5.7L; 8.5mm High Performance Wire; Equipped with Ceramic Spark Plug Boots	10059
1972-1970	8 Cyl. 7.5L; 8.5mm High Performance Wire; Equipped with Ceramic Spark Plug Boots	10059
1972-1970	8 Cyl. 7.5L; 8.5mm High Performance Wire	10008
1969-1968	8 Cyl. 6.6L; 8.5mm High Performance Wire	10008
1969-1968	8 Cyl. 6.6L; 8.5mm High Performance Wire; Equipped with Ceramic Spark Plug Boots	10059
1967-1964	8 Cyl. 5.4L; 8.5mm High Performance Wire	10008
1967-1964	8 Cyl. 5.4L; 8.5mm High Performance Wire; Equipped with Ceramic Spark Plug Boots	10059
Plymouth		
Wire Sets		
Spark Plug Wire Set		
Barracuda		
1974	8 Cyl. 5.9L; 8.5mm High Performance Wire; Equipped with Ceramic Spark Plug Boots	10052
1974	8 Cyl. 5.9L; 8.5mm High Performance Wire; w/ Straight Non-Bendable Spark Plug Boot	10009
1974	8 Cyl. 5.9L; 8.5mm High Performance Wire; w/ Straight Bendable Spark Plug Boot	10117
1974-1968	8 Cyl. 5.2L; 8.5mm High Performance Wire; w/ Straight Non-Bendable Spark Plug Boot	10009
1974-1968	8 Cyl. 5.2L; 8.5mm High Performance Wire; Equipped with Ceramic Spark Plug Boots	10052
1974-1968	8 Cyl. 5.2L; 8.5mm High Performance Wire; w/ Straight Bendable Spark Plug Boot	10117
1973-1972	8 Cyl. 5.6L; 8.5mm High Performance Wire; Equipped with Ceramic Spark Plug Boots	10052
1973-1972	8 Cyl. 5.6L; 8.5mm High Performance Wire; w/ Straight Non-Bendable Spark Plug Boot	10009
1973-1972	8 Cyl. 5.6L; 8.5mm High Performance Wire; w/ Straight Bendable Spark Plug Boot	10117
1971-1967	8 Cyl. 6.3L; 8.5mm High Performance Wire	10043
1969-1968	8 Cyl. 5.6L; 8.5mm High Performance Wire; Equipped with Ceramic Spark Plug Boots	10052
1969-1968	8 Cyl. 5.6L; 8.5mm High Performance Wire; w/ Straight Non-Bendable Spark Plug Boot	10009
1969-1968	8 Cyl. 5.6L; 8.5mm High Performance Wire; w/ Straight Bendable Spark Plug Boot	10117
1967	8 Cyl. 4.5L; 8.5mm High Performance Wire; Equipped with Ceramic Spark Plug Boots	10052
1967	8 Cyl. 4.5L; 8.5mm High Performance Wire; w/ Straight Non-Bendable Spark Plug Boot	10009
1967	8 Cyl. 4.5L; 8.5mm High Performance Wire; w/ Straight Bendable Spark Plug Boot	10117

Year	Model/Engine	Part No.
Spark Plug Wire Set		
Barracuda		
1966-1965	8 Cyl. 4.5L; 8.5mm High Performance Wire; w/ Straight Non-Bendable Spark Plug Boot	10009
1966-1965	8 Cyl. 4.5L; 8.5mm High Performance Wire; Equipped with Ceramic Spark Plug Boots	10052
1966-1965	8 Cyl. 4.5L; 8.5mm High Performance Wire; w/ Straight Bendable Spark Plug Boot	10117
Belvedere		
1970-1969	8 Cyl. 6.3L; 8.5mm High Performance Wire	10043
1970-1968	8 Cyl. 5.2L; 8.5mm High Performance Wire; w/ Straight Non-Bendable Spark Plug Boot	10009
1970-1968	8 Cyl. 5.2L; 8.5mm High Performance Wire; Equipped with Ceramic Spark Plug Boots	10052
1970-1968	8 Cyl. 5.2L; 8.5mm High Performance Wire; w/ Straight Bendable Spark Plug Boot	10117
1968	8 Cyl. 4.5L; 8.5mm High Performance Wire; Equipped with Ceramic Spark Plug Boots	10052
1968	8 Cyl. 4.5L; 8.5mm High Performance Wire; w/ Straight Non-Bendable Spark Plug Boot	10009
1968	8 Cyl. 4.5L; 8.5mm High Performance Wire; w/ Straight Bendable Spark Plug Boot	10117
1967-1964	8 Cyl. 4.5L; 8.5mm High Performance Wire; Equipped with Ceramic Spark Plug Boots	10052
1967-1964	8 Cyl. 4.5L; 8.5mm High Performance Wire; w/ Straight Non-Bendable Spark Plug Boot	10009
1967-1964	8 Cyl. 4.5L; 8.5mm High Performance Wire; w/ Straight Bendable Spark Plug Boot	10117
1967-1960	8 Cyl. 5.2L; 8.5mm High Performance Wire; w/ Straight Non-Bendable Spark Plug Boot	10009
1967-1960	8 Cyl. 5.2L; 8.5mm High Performance Wire; Equipped with Ceramic Spark Plug Boots	10052
1967-1960	8 Cyl. 5.2L; 8.5mm High Performance Wire; w/ Straight Bendable Spark Plug Boot	10117
1962	8 Cyl.; 413; 8.5mm High Performance Wire; Equipped with Ceramic Spark Plug Boots	10052
1962	8 Cyl.; 413; 8.5mm High Performance Wire; w/ Straight Non-Bendable Spark Plug Boot	10009
1962	8 Cyl.; 413; 8.5mm High Performance Wire; w/ Straight Bendable Spark Plug Boot	10117
1961	8 Cyl. 6.7L; 8.5mm High Performance Wire; Equipped with Ceramic Spark Plug Boots	10052
1961	8 Cyl. 6.7L; 8.5mm High Performance Wire; w/ Straight Non-Bendable Spark Plug Boot	10009
1961	8 Cyl. 6.7L; 8.5mm High Performance Wire; w/ Straight Bendable Spark Plug Boot	10117
1959	8 Cyl. 5.9L; 8.5mm High Performance Wire; Equipped with Ceramic Spark Plug Boots	10059
1959	8 Cyl. 5.9L; 8.5mm High Performance Wire	10008

Wire Sets

Year	Model/Engine	Part No.
Spark Plug Wire Set		
Belvedere		
1959-1958	8 Cyl. 5.2L; 8.5mm High Performance Wire; Equipped with Ceramic Spark Plug Boots	10059
1959-1958	8 Cyl. 5.2L; 8.5mm High Performance Wire	10008
1958	8 Cyl. 5.7L; 8.5mm High Performance Wire	10008
1958	8 Cyl. 5.7L; 8.5mm High Performance Wire; Equipped with Ceramic Spark Plug Boots	10059
1957	8 Cyl. 4.9L; 8.5mm High Performance Wire; Equipped with Ceramic Spark Plug Boots	10059
1957	8 Cyl. 4.9L; 8.5mm High Performance Wire	10008
1957	8 Cyl. 4.5L; 8.5mm High Performance Wire	10008
1957	8 Cyl. 4.5L; 8.5mm High Performance Wire; Equipped with Ceramic Spark Plug Boots	10059
Belvedere II		
1967	8 Cyl. 6.3L; 8.5mm High Performance Wire	10043
1967-1965	8 Cyl. 5.2L; 8.5mm High Performance Wire; w/ Straight Non-Bendable Spark Plug Boot	10009
1967-1965	8 Cyl. 4.5L; 8.5mm High Performance Wire; Equipped with Ceramic Spark Plug Boots	10052
1967-1965	8 Cyl. 5.2L; 8.5mm High Performance Wire; Equipped with Ceramic Spark Plug Boots	10052
1967-1965	8 Cyl. 4.5L; 8.5mm High Performance Wire; w/ Straight Non-Bendable Spark Plug Boot	10009
1967-1965	8 Cyl. 4.5L; 8.5mm High Performance Wire; w/ Straight Bendable Spark Plug Boot	10117
1967-1965	8 Cyl. 5.2L; 8.5mm High Performance Wire; w/ Straight Bendable Spark Plug Boot	10117
Breeze		
2000-1996	4 Cyl. 2.4L; 8.5mm High Performance Wire	10024
1996	4 Cyl. 2.0L; 8.5mm High Performance Wire	10024
Caravelle		
1989	8 Cyl. 5.2L; 8.5mm High Performance Wire; w/ Straight Non-Bendable Spark Plug Boot	10009
1989	8 Cyl. 5.2L; 8.5mm High Performance Wire; Equipped with Ceramic Spark Plug Boots	10052
1989	8 Cyl. 5.2L; 8.5mm High Performance Wire; w/ Straight Bendable Spark Plug Boot	10117
1988-1985	8 Cyl. 5.2L; 8.5mm High Performance Wire; Equipped with Ceramic Spark Plug Boots	10052
1988-1985	8 Cyl. 5.2L; 8.5mm High Performance Wire; w/ Straight Non-Bendable Spark Plug Boot	10009
1988-1985	8 Cyl. 5.2L; 8.5mm High Performance Wire; w/ Straight Bendable Spark Plug Boot	10117
1984-1978	8 Cyl. 5.2L; 8.5mm High Performance Wire; w/ Straight Non-Bendable Spark Plug Boot	10009

Year	Model/Engine	Part No.
Spark Plug Wire Set		
Caravelle		
1984-1978	8 Cyl. 5.2L; 8.5mm High Performance Wire; Equipped with Ceramic Spark Plug Boots	10052
1984-1978	8 Cyl. 5.2L; 8.5mm High Performance Wire; w/ Straight Bendable Spark Plug Boot	10117
1979-1978	8 Cyl. 5.9L; 8.5mm High Performance Wire; Equipped with Ceramic Spark Plug Boots	10052
1979-1978	8 Cyl. 5.9L; 8.5mm High Performance Wire; w/ Straight Non-Bendable Spark Plug Boot	10009
1979-1978	8 Cyl. 5.9L; 8.5mm High Performance Wire; w/ Straight Bendable Spark Plug Boot	10117
Cuda		
1974	8 Cyl. 5.9L; 8.5mm High Performance Wire; w/ Straight Non-Bendable Spark Plug Boot	10009
1974	8 Cyl. 5.9L; 8.5mm High Performance Wire; Equipped with Ceramic Spark Plug Boots	10052
1974	8 Cyl. 5.9L; 8.5mm High Performance Wire; w/ Straight Bendable Spark Plug Boot	10117
1974-1970	8 Cyl. 5.2L; 8.5mm High Performance Wire; w/ Straight Non-Bendable Spark Plug Boot	10009
1974-1970	8 Cyl. 5.2L; 8.5mm High Performance Wire; Equipped with Ceramic Spark Plug Boots	10052
1974-1970	8 Cyl. 5.2L; 8.5mm High Performance Wire; w/ Straight Bendable Spark Plug Boot	10117
1973-1970	8 Cyl. 5.6L; 8.5mm High Performance Wire; w/ Straight Non-Bendable Spark Plug Boot	10009
1973-1970	8 Cyl. 5.6L; 8.5mm High Performance Wire; Equipped with Ceramic Spark Plug Boots	10052
1973-1970	8 Cyl. 5.6L; 8.5mm High Performance Wire; w/ Straight Bendable Spark Plug Boot	10117
1971-1970	8 Cyl. 6.3L; 8.5mm High Performance Wire	10043
Custom		
1959	8 Cyl. 5.9L; 8.5mm High Performance Wire; Equipped with Ceramic Spark Plug Boots	10059
1959	8 Cyl. 5.9L; 8.5mm High Performance Wire	10008
1959-1958	8 Cyl. 5.2L; 8.5mm High Performance Wire; Equipped with Ceramic Spark Plug Boots	10059
1959-1958	8 Cyl. 5.2L; 8.5mm High Performance Wire	10008
1958	8 Cyl. 5.7L; 8.5mm High Performance Wire	10008
1958	8 Cyl. 5.7L; 8.5mm High Performance Wire; Equipped with Ceramic Spark Plug Boots	10059
Duster		
1976-1974	8 Cyl. 5.9L; 8.5mm High Performance Wire; w/ Straight Non-Bendable Spark Plug Boot	10009
1976-1974	8 Cyl. 5.9L; 8.5mm High Performance Wire; Equipped with Ceramic Spark Plug Boots	10052

Wire Sets

Year	Model/Engine	Part No.
Spark Plug Wire Set		
Duster		
1976-1974	8 Cyl. 5.9L; 8.5mm High Performance Wire; w/ Straight Bendable Spark Plug Boot	10117
1976-1970	8 Cyl. 5.2L; 8.5mm High Performance Wire; Equipped with Ceramic Spark Plug Boots	10052
1976-1970	8 Cyl. 5.2L; 8.5mm High Performance Wire; w/ Straight Non-Bendable Spark Plug Boot	10009
1976-1970	8 Cyl. 5.2L; 8.5mm High Performance Wire; w/ Straight Bendable Spark Plug Boot	10117
1973-1970	8 Cyl. 5.6L; 8.5mm High Performance Wire; w/ Straight Non-Bendable Spark Plug Boot	10009
1973-1970	8 Cyl. 5.6L; 8.5mm High Performance Wire; Equipped with Ceramic Spark Plug Boots	10052
1973-1970	8 Cyl. 5.6L; 8.5mm High Performance Wire; w/ Straight Bendable Spark Plug Boot	10117
Fury		
1978-1975	8 Cyl. 5.2L; 8.5mm High Performance Wire; w/ Straight Non-Bendable Spark Plug Boot	10009
1978-1975	8 Cyl. 5.2L; 8.5mm High Performance Wire; Equipped with Ceramic Spark Plug Boots	10052
1978-1975	8 Cyl. 5.2L; 8.5mm High Performance Wire; w/ Straight Bendable Spark Plug Boot	10117
1978-1971	8 Cyl. 5.9L; 8.5mm High Performance Wire; w/ Straight Non-Bendable Spark Plug Boot	10009
1978-1971	8 Cyl. 5.9L; 8.5mm High Performance Wire; Equipped with Ceramic Spark Plug Boots	10052
1978-1971	8 Cyl. 5.9L; 8.5mm High Performance Wire; w/ Straight Bendable Spark Plug Boot	10117
1973-1967	8 Cyl. 5.2L; 8.5mm High Performance Wire; w/ Straight Non-Bendable Spark Plug Boot	10009
1973-1967	8 Cyl. 5.2L; 8.5mm High Performance Wire; Equipped with Ceramic Spark Plug Boots	10052
1973-1967	8 Cyl. 5.2L; 8.5mm High Performance Wire; w/ Straight Bendable Spark Plug Boot	10117
1972	8 Cyl. 7.2L; 8.5mm High Performance Wire; Exc. Electronic Ignition	10043
1972	8 Cyl. 6.6L; 8.5mm High Performance Wire; Exc. Electronic Ignition	10043
1971-1969	8 Cyl. 6.3L; 8.5mm High Performance Wire	10043
1971-1969	8 Cyl. 7.2L; 8.5mm High Performance Wire	10043
1968	8 Cyl. 7.2L; 8.5mm High Performance Wire; w/ High Performance Engine	10043
1968	8 Cyl. 6.3L; 8.5mm High Performance Wire; w/ High Performance Engine	10043
1967	8 Cyl. 6.3L; 8.5mm High Performance Wire	10043
1966-1964	8 Cyl. 5.2L; 8.5mm High Performance Wire; w/ Straight Non-Bendable Spark Plug Boot	10009
1966-1964	8 Cyl. 5.2L; 8.5mm High Performance Wire; Equipped with Ceramic Spark Plug Boots	10052

Year	Model/Engine	Part No.
Spark Plug Wire Set		
Fury		
1966-1964	8 Cyl. 5.2L; 8.5mm High Performance Wire; w/ Straight Bendable Spark Plug Boot	10117
1965-1964	8 Cyl. 4.5L; 8.5mm High Performance Wire; Equipped with Ceramic Spark Plug Boots	10052
1965-1964	8 Cyl. 4.5L; 8.5mm High Performance Wire; w/ Straight Non-Bendable Spark Plug Boot	10009
1965-1964	8 Cyl. 4.5L; 8.5mm High Performance Wire; w/ Straight Bendable Spark Plug Boot	10117
1962	8 Cyl. 6.8L; 8.5mm High Performance Wire; w/ Straight Non-Bendable Spark Plug Boot	10009
1962	8 Cyl. 6.8L; 8.5mm High Performance Wire; Equipped with Ceramic Spark Plug Boots	10052
1962	8 Cyl. 6.8L; 8.5mm High Performance Wire; w/ Straight Bendable Spark Plug Boot	10117
1961-1960	8 Cyl. 5.2L; 8.5mm High Performance Wire; w/ Straight Non-Bendable Spark Plug Boot	10009
1961-1960	8 Cyl. 5.2L; 8.5mm High Performance Wire; Equipped with Ceramic Spark Plug Boots	10052
1961-1960	8 Cyl. 5.2L; 8.5mm High Performance Wire; w/ Straight Bendable Spark Plug Boot	10117
1959	8 Cyl. 5.9L; 8.5mm High Performance Wire	10008
1959	8 Cyl. 5.9L; 8.5mm High Performance Wire; Equipped with Ceramic Spark Plug Boots	10059
1959-1957	8 Cyl. 5.2L; 8.5mm High Performance Wire	10008
1959-1957	8 Cyl. 5.2L; 8.5mm High Performance Wire; Equipped with Ceramic Spark Plug Boots	10059
1958	8 Cyl. 5.7L; 8.5mm High Performance Wire	10008
1958	8 Cyl. 5.7L; 8.5mm High Performance Wire; Equipped with Ceramic Spark Plug Boots	10059
1957	8 Cyl. 4.9L; 8.5mm High Performance Wire	10008
1957	8 Cyl. 4.9L; 8.5mm High Performance Wire; Equipped with Ceramic Spark Plug Boots	10059
Gran Fury		
1989-1980	8 Cyl. 5.2L; 8.5mm High Performance Wire; w/ Straight Non-Bendable Spark Plug Boot	10009
1989-1980	8 Cyl. 5.2L; 8.5mm High Performance Wire; Equipped with Ceramic Spark Plug Boots	10052
1989-1980	8 Cyl. 5.2L; 8.5mm High Performance Wire; w/ Straight Bendable Spark Plug Boot	10117
1980	8 Cyl. 5.9L; 8.5mm High Performance Wire; Equipped with Ceramic Spark Plug Boots	10052
1980	8 Cyl. 5.9L; 8.5mm High Performance Wire; w/ Straight Non-Bendable Spark Plug Boot	10009
1980	8 Cyl. 5.9L; 8.5mm High Performance Wire; w/ Straight Bendable Spark Plug Boot	10117

Wire Sets

Year	Model/Engine	Part No.
Spark Plug Wire Set		
Gran Fury		
1977-1975	8 Cyl. 5.2L; 8.5mm High Performance Wire; w/ Straight Non-Bendable Spark Plug Boot	10009
1977-1975	8 Cyl. 5.2L; 8.5mm High Performance Wire; Equipped with Ceramic Spark Plug Boots	10052
1977-1975	8 Cyl. 5.2L; 8.5mm High Performance Wire; w/ Straight Bendable Spark Plug Boot	10117
1977-1972	8 Cyl. 5.9L; 8.5mm High Performance Wire; Equipped with Ceramic Spark Plug Boots	10052
1977-1972	8 Cyl. 5.9L; 8.5mm High Performance Wire; w/ Straight Non-Bendable Spark Plug Boot	10009
1977-1972	8 Cyl. 5.9L; 8.5mm High Performance Wire; w/ Straight Bendable Spark Plug Boot	10117
1973-1972	8 Cyl. 5.2L; 8.5mm High Performance Wire; w/ Straight Non-Bendable Spark Plug Boot	10009
1973-1972	8 Cyl. 5.2L; 8.5mm High Performance Wire; Equipped with Ceramic Spark Plug Boots	10052
1973-1972	8 Cyl. 5.2L; 8.5mm High Performance Wire; w/ Straight Bendable Spark Plug Boot	10117
1972	8 Cyl. 7.2L; 8.5mm High Performance Wire; Exc. Electronic Ignition	10043
1972	8 Cyl. 6.6L; 8.5mm High Performance Wire; Exc. Electronic Ignition	10043
GTX		
1971-1969	8 Cyl. 7.2L; 8.5mm High Performance Wire	10043
1968	8 Cyl. 6.3L; 8.5mm High Performance Wire; w/ High Performance Engine	10043
1968	8 Cyl. 5.2L; 8.5mm High Performance Wire; Equipped with Ceramic Spark Plug Boots	10052
1968	8 Cyl. 7.2L; 8.5mm High Performance Wire; w/ High Performance Engine	10043
1968	8 Cyl. 5.2L; 8.5mm High Performance Wire; w/ Straight Non-Bendable Spark Plug Boot	10009
1968	8 Cyl. 5.2L; 8.5mm High Performance Wire; w/ Straight Bendable Spark Plug Boot	10117
1967	8 Cyl. 4.5L; 8.5mm High Performance Wire; w/ Straight Non-Bendable Spark Plug Boot	10009
1967	8 Cyl. 5.2L; 8.5mm High Performance Wire; w/ Straight Non-Bendable Spark Plug Boot	10009
1967	8 Cyl. 5.2L; 8.5mm High Performance Wire; Equipped with Ceramic Spark Plug Boots	10052
1967	8 Cyl. 4.5L; 8.5mm High Performance Wire; Equipped with Ceramic Spark Plug Boots	10052
1967	8 Cyl. 6.3L; 8.5mm High Performance Wire	10043
1967	8 Cyl. 4.5L; 8.5mm High Performance Wire; w/ Straight Bendable Spark Plug Boot	10117
1967	8 Cyl. 5.2L; 8.5mm High Performance Wire; w/ Straight Bendable Spark Plug Boot	10117
Neon		
1999-1995	4 Cyl. 2.0L; 8.5mm High Performance Wire	10024

Year	Model/Engine	Part No.
Spark Plug Wire Set		
PB100		
1980-1975	8 Cyl. 5.2L; 8.5mm High Performance Wire; w/ Straight Non-Bendable Spark Plug Boot	10009
1980-1975	8 Cyl. 5.2L; 8.5mm High Performance Wire; Equipped with Ceramic Spark Plug Boots	10052
1980-1975	8 Cyl. 5.2L; 8.5mm High Performance Wire; w/ Straight Bendable Spark Plug Boot	10117
1978-1976	8 Cyl. 5.9L; 8.5mm High Performance Wire; w/ Straight Non-Bendable Spark Plug Boot	10009
1978-1976	8 Cyl. 5.9L; 8.5mm High Performance Wire; Equipped with Ceramic Spark Plug Boots	10052
1978-1976	8 Cyl. 5.9L; 8.5mm High Performance Wire; w/ Straight Bendable Spark Plug Boot	10117
PB150		
1983-1981	8 Cyl. 5.2L; 8.5mm High Performance Wire; Equipped with Ceramic Spark Plug Boots	10052
1983-1981	8 Cyl. 5.2L; 8.5mm High Performance Wire; w/ Straight Non-Bendable Spark Plug Boot	10009
1983-1981	8 Cyl. 5.2L; 8.5mm High Performance Wire; w/ Straight Bendable Spark Plug Boot	10117
PB200		
1980-1975	8 Cyl. 5.9L; 8.5mm High Performance Wire; Equipped with Ceramic Spark Plug Boots	10052
1980-1975	8 Cyl. 5.2L; 8.5mm High Performance Wire; Equipped with Ceramic Spark Plug Boots	10052
1980-1975	8 Cyl. 5.2L; 8.5mm High Performance Wire; w/ Straight Non-Bendable Spark Plug Boot	10009
1980-1975	8 Cyl. 5.9L; 8.5mm High Performance Wire; w/ Straight Non-Bendable Spark Plug Boot	10009
1980-1975	8 Cyl. 5.2L; 8.5mm High Performance Wire; w/ Straight Bendable Spark Plug Boot	10117
1980-1975	8 Cyl. 5.9L; 8.5mm High Performance Wire; w/ Straight Bendable Spark Plug Boot	10117
PB200 Van		
1974	8 Cyl. 5.9L; 8.5mm High Performance Wire; Equipped with Ceramic Spark Plug Boots	10052
1974	8 Cyl. 5.2L; 8.5mm High Performance Wire; w/ Straight Non-Bendable Spark Plug Boot	10009
1974	8 Cyl. 5.2L; 8.5mm High Performance Wire; Equipped with Ceramic Spark Plug Boots	10052
1974	8 Cyl. 5.9L; 8.5mm High Performance Wire; w/ Straight Non-Bendable Spark Plug Boot	10009
1974	8 Cyl. 5.9L; 8.5mm High Performance Wire; w/ Straight Bendable Spark Plug Boot	10117
1974	8 Cyl. 5.2L; 8.5mm High Performance Wire; w/ Straight Bendable Spark Plug Boot	10117
PB250		
1983-1981	8 Cyl. 5.2L; 8.5mm High Performance Wire; w/ Straight Non-Bendable Spark Plug Boot	10009

Wire Sets

Year	Model/Engine	Part No.
Spark Plug Wire Set		
PB250		
1983-1981	8 Cyl. 5.2L; 8.5mm High Performance Wire; Equipped with Ceramic Spark Plug Boots	10052
1983-1981	8 Cyl. 5.2L; 8.5mm High Performance Wire; w/ Straight Bendable Spark Plug Boot	10117
1981	8 Cyl. 5.9L; 8.5mm High Performance Wire; w/ Straight Non-Bendable Spark Plug Boot	10009
1981	8 Cyl. 5.9L; 8.5mm High Performance Wire; Equipped with Ceramic Spark Plug Boots	10052
1981	8 Cyl. 5.9L; 8.5mm High Performance Wire; w/ Straight Bendable Spark Plug Boot	10117
PB300		
1980-1975	8 Cyl. 5.9L; 8.5mm High Performance Wire; Equipped with Ceramic Spark Plug Boots	10052
1980-1975	8 Cyl. 5.9L; 8.5mm High Performance Wire; w/ Straight Non-Bendable Spark Plug Boot	10009
1980-1975	8 Cyl. 5.2L; 8.5mm High Performance Wire; Equipped with Ceramic Spark Plug Boots	10052
1980-1975	8 Cyl. 5.2L; 8.5mm High Performance Wire; w/ Straight Non-Bendable Spark Plug Boot	10009
1980-1975	8 Cyl. 5.2L; 8.5mm High Performance Wire; w/ Straight Bendable Spark Plug Boot	10117
1980-1975	8 Cyl. 5.9L; 8.5mm High Performance Wire; w/ Straight Bendable Spark Plug Boot	10117
PB300 Van		
1974	8 Cyl. 5.9L; 8.5mm High Performance Wire; w/ Straight Non-Bendable Spark Plug Boot	10009
1974	8 Cyl. 5.2L; 8.5mm High Performance Wire; w/ Straight Non-Bendable Spark Plug Boot	10009
1974	8 Cyl. 5.2L; 8.5mm High Performance Wire; Equipped with Ceramic Spark Plug Boots	10052
1974	8 Cyl. 5.9L; 8.5mm High Performance Wire; Equipped with Ceramic Spark Plug Boots	10052
1974	8 Cyl. 5.2L; 8.5mm High Performance Wire; w/ Straight Bendable Spark Plug Boot	10117
1974	8 Cyl. 5.9L; 8.5mm High Performance Wire; w/ Straight Bendable Spark Plug Boot	10117
PB350		
1983-1981	8 Cyl. 5.2L; 8.5mm High Performance Wire; Equipped with Ceramic Spark Plug Boots	10052
1983-1981	8 Cyl. 5.2L; 8.5mm High Performance Wire; w/ Straight Non-Bendable Spark Plug Boot	10009
1983-1981	8 Cyl. 5.9L; 8.5mm High Performance Wire; w/ Straight Non-Bendable Spark Plug Boot	10009
1983-1981	8 Cyl. 5.9L; 8.5mm High Performance Wire; Equipped with Ceramic Spark Plug Boots	10052
1983-1981	8 Cyl. 5.2L; 8.5mm High Performance Wire; w/ Straight Bendable Spark Plug Boot	10117

Year	Model/Engine	Part No.
Spark Plug Wire Set		
PB350		
1983-1981	8 Cyl. 5.9L; 8.5mm High Performance Wire; w/ Straight Bendable Spark Plug Boot	10117
Plaza		
1958	8 Cyl. 5.2L; 8.5mm High Performance Wire; Equipped with Ceramic Spark Plug Boots	10059
1958	8 Cyl. 5.7L; 8.5mm High Performance Wire; Equipped with Ceramic Spark Plug Boots	10059
1958	8 Cyl. 5.2L; 8.5mm High Performance Wire	10008
1958	8 Cyl. 5.7L; 8.5mm High Performance Wire	10008
1957	8 Cyl. 4.9L; 8.5mm High Performance Wire; Equipped with Ceramic Spark Plug Boots	10059
1957	8 Cyl. 4.5L; 8.5mm High Performance Wire; Equipped with Ceramic Spark Plug Boots	10059
1957	8 Cyl. 4.9L; 8.5mm High Performance Wire	10008
1957	8 Cyl. 4.5L; 8.5mm High Performance Wire	10008
Roadrunner		
1975-1974	8 Cyl. 5.9L; 8.5mm High Performance Wire; w/ Straight Non-Bendable Spark Plug Boot	10009
1975-1974	8 Cyl. 5.9L; 8.5mm High Performance Wire; Equipped with Ceramic Spark Plug Boots	10052
1975-1974	8 Cyl. 5.9L; 8.5mm High Performance Wire; w/ Straight Bendable Spark Plug Boot	10117
1975-1972	8 Cyl. 5.2L; 8.5mm High Performance Wire; w/ Straight Non-Bendable Spark Plug Boot	10009
1975-1972	8 Cyl. 5.2L; 8.5mm High Performance Wire; Equipped with Ceramic Spark Plug Boots	10052
1975-1972	8 Cyl. 5.2L; 8.5mm High Performance Wire; w/ Straight Bendable Spark Plug Boot	10117
1973-1971	8 Cyl. 5.6L; 8.5mm High Performance Wire; w/ Straight Non-Bendable Spark Plug Boot	10009
1973-1971	8 Cyl. 5.6L; 8.5mm High Performance Wire; Equipped with Ceramic Spark Plug Boots	10052
1973-1971	8 Cyl. 5.6L; 8.5mm High Performance Wire; w/ Straight Bendable Spark Plug Boot	10117
1972	8 Cyl. 6.6L; 8.5mm High Performance Wire; Exc. Electronic Ignition	10043
1972	8 Cyl. 7.2L; 8.5mm High Performance Wire; Exc. Electronic Ignition	10043
1971-1969	8 Cyl. 6.3L; 8.5mm High Performance Wire	10043
1971-1969	8 Cyl. 7.2L; 8.5mm High Performance Wire	10043
1968	8 Cyl. 6.3L; 8.5mm High Performance Wire; w/ High Performance Engine	10043
1968	8 Cyl. 5.2L; 8.5mm High Performance Wire; w/ Straight Non-Bendable Spark Plug Boot	10009
1968	8 Cyl. 5.2L; 8.5mm High Performance Wire; Equipped with Ceramic Spark Plug Boots	10052

Wire Sets

Year	Model/Engine	Part No.
Spark Plug Wire Set		
Roadrunner		
1968	8 Cyl. 4.5L; 8.5mm High Performance Wire; Equipped with Ceramic Spark Plug Boots	10052
1968	8 Cyl. 4.5L; 8.5mm High Performance Wire; w/ Straight Non-Bendable Spark Plug Boot	10009
1968	8 Cyl. 4.5L; 8.5mm High Performance Wire; w/ Straight Bendable Spark Plug Boot	10117
1968	8 Cyl. 5.2L; 8.5mm High Performance Wire; w/ Straight Bendable Spark Plug Boot	10117
Satellite		
1974	8 Cyl. 5.9L; 8.5mm High Performance Wire; w/ Straight Non-Bendable Spark Plug Boot	10009
1974	8 Cyl. 5.9L; 8.5mm High Performance Wire; Equipped with Ceramic Spark Plug Boots	10052
1974	8 Cyl. 5.9L; 8.5mm High Performance Wire; w/ Straight Bendable Spark Plug Boot	10117
1974-1968	8 Cyl. 5.2L; 8.5mm High Performance Wire; Equipped with Ceramic Spark Plug Boots	10052
1974-1968	8 Cyl. 5.2L; 8.5mm High Performance Wire; w/ Straight Non-Bendable Spark Plug Boot	10009
1974-1968	8 Cyl. 5.2L; 8.5mm High Performance Wire; w/ Straight Bendable Spark Plug Boot	10117
1972	8 Cyl. 6.6L; 8.5mm High Performance Wire; Exc. Electronic Ignition	10043
1972	8 Cyl. 5.6L; 8.5mm High Performance Wire; w/ Straight Non-Bendable Spark Plug Boot	10009
1972	8 Cyl. 5.6L; 8.5mm High Performance Wire; Equipped with Ceramic Spark Plug Boots	10052
1972	8 Cyl. 5.6L; 8.5mm High Performance Wire; w/ Straight Bendable Spark Plug Boot	10117
1971-1969	8 Cyl. 6.3L; 8.5mm High Performance Wire	10043
1968	8 Cyl. 4.5L; 8.5mm High Performance Wire; w/ Straight Non-Bendable Spark Plug Boot	10009
1968	8 Cyl. 4.5L; 8.5mm High Performance Wire; Equipped with Ceramic Spark Plug Boots	10052
1968	8 Cyl. 4.5L; 8.5mm High Performance Wire; w/ Straight Bendable Spark Plug Boot	10117
1967-1965	8 Cyl. 4.5L; 8.5mm High Performance Wire; Equipped with Ceramic Spark Plug Boots	10052
1967-1965	8 Cyl. 5.2L; 8.5mm High Performance Wire; Equipped with Ceramic Spark Plug Boots	10052
1967-1965	8 Cyl. 4.5L; 8.5mm High Performance Wire; w/ Straight Non-Bendable Spark Plug Boot	10009
1967-1965	8 Cyl. 5.2L; 8.5mm High Performance Wire; w/ Straight Non-Bendable Spark Plug Boot	10009
1967-1965	8 Cyl. 4.5L; 8.5mm High Performance Wire; w/ Straight Bendable Spark Plug Boot	10117
1967-1965	8 Cyl. 5.2L; 8.5mm High Performance Wire; w/ Straight Bendable Spark Plug Boot	10117

Year	Model/Engine	Part No.
Spark Plug Wire Set		
Savoy		
1964	8 Cyl. 4.5L; 8.5mm High Performance Wire; Equipped with Ceramic Spark Plug Boots	10052
1964	8 Cyl. 4.5L; 8.5mm High Performance Wire; w/ Straight Non-Bendable Spark Plug Boot	10009
1964	8 Cyl. 4.5L; 8.5mm High Performance Wire; w/ Straight Bendable Spark Plug Boot	10117
1964-1960	8 Cyl. 5.2L; 8.5mm High Performance Wire; w/ Straight Non-Bendable Spark Plug Boot	10009
1964-1960	8 Cyl. 5.2L; 8.5mm High Performance Wire; Equipped with Ceramic Spark Plug Boots	10052
1964-1960	8 Cyl. 5.2L; 8.5mm High Performance Wire; w/ Straight Bendable Spark Plug Boot	10117
1959	8 Cyl. 5.9L; 8.5mm High Performance Wire	10008
1959	8 Cyl. 5.9L; 8.5mm High Performance Wire; Equipped with Ceramic Spark Plug Boots	10059
1959-1958	8 Cyl. 5.2L; 8.5mm High Performance Wire	10008
1959-1958	8 Cyl. 5.2L; 8.5mm High Performance Wire; Equipped with Ceramic Spark Plug Boots	10059
1958	8 Cyl. 5.7L; 8.5mm High Performance Wire; Equipped with Ceramic Spark Plug Boots	10059
1958	8 Cyl. 5.7L; 8.5mm High Performance Wire	10008
1957	8 Cyl. 4.5L; 8.5mm High Performance Wire	10008
1957	8 Cyl. 4.9L; 8.5mm High Performance Wire	10008
1957	8 Cyl. 4.9L; 8.5mm High Performance Wire; Equipped with Ceramic Spark Plug Boots	10059
1957	8 Cyl. 4.5L; 8.5mm High Performance Wire; Equipped with Ceramic Spark Plug Boots	10059
Scamp		
1976-1971	8 Cyl. 5.2L; 8.5mm High Performance Wire; w/ Straight Non-Bendable Spark Plug Boot	10009
1976-1971	8 Cyl. 5.2L; 8.5mm High Performance Wire; Equipped with Ceramic Spark Plug Boots	10052
1976-1971	8 Cyl. 5.2L; 8.5mm High Performance Wire; w/ Straight Bendable Spark Plug Boot	10117
Sport Wagon		
1961-1960	8 Cyl. 5.2L; 8.5mm High Performance Wire; Equipped with Ceramic Spark Plug Boots	10052
1961-1960	8 Cyl. 5.2L; 8.5mm High Performance Wire; w/ Straight Non-Bendable Spark Plug Boot	10009
1961-1960	8 Cyl. 5.2L; 8.5mm High Performance Wire; w/ Straight Bendable Spark Plug Boot	10117
Suburban		
1961-1960	8 Cyl. 5.2L; 8.5mm High Performance Wire; Equipped with Ceramic Spark Plug Boots	10052
1961-1960	8 Cyl. 5.2L; 8.5mm High Performance Wire; w/ Straight Non-Bendable Spark Plug Boot	10009

Wire Sets

Year	Model/Engine	Part No.
Spark Plug Wire Set		
Suburban		
1961-1960	8 Cyl. 5.2L; 8.5mm High Performance Wire; w/ Straight Bendable Spark Plug Boot	10117
1959-1958	8 Cyl. 5.2L; 8.5mm High Performance Wire; Equipped with Ceramic Spark Plug Boots	10059
1959-1958	8 Cyl. 5.9L; 8.5mm High Performance Wire; Equipped with Ceramic Spark Plug Boots	10059
1959-1958	8 Cyl. 5.9L; 8.5mm High Performance Wire	10008
1959-1958	8 Cyl. 5.2L; 8.5mm High Performance Wire	10008
1958	8 Cyl. 5.7L; 8.5mm High Performance Wire; Equipped with Ceramic Spark Plug Boots	10059
1958	8 Cyl. 5.7L; 8.5mm High Performance Wire	10008
1957	8 Cyl. 4.5L; 8.5mm High Performance Wire	10008
1957	8 Cyl. 4.9L; 8.5mm High Performance Wire	10008
1957	8 Cyl. 4.9L; 8.5mm High Performance Wire; Equipped with Ceramic Spark Plug Boots	10059
1957	8 Cyl. 4.5L; 8.5mm High Performance Wire; Equipped with Ceramic Spark Plug Boots	10059
Superbird		
1970	8 Cyl. 7.2L; 8.5mm High Performance Wire	10043
Trailduster		
1981-1974	8 Cyl. 5.2L; 8.5mm High Performance Wire; Equipped with Ceramic Spark Plug Boots	10052
1981-1974	8 Cyl. 5.9L; 8.5mm High Performance Wire; Equipped with Ceramic Spark Plug Boots	10052
1981-1974	8 Cyl. 5.2L; 8.5mm High Performance Wire; w/ Straight Non-Bendable Spark Plug Boot	10009
1981-1974	8 Cyl. 5.9L; 8.5mm High Performance Wire; w/ Straight Non-Bendable Spark Plug Boot	10009
1981-1974	8 Cyl. 5.2L; 8.5mm High Performance Wire; w/ Straight Bendable Spark Plug Boot	10117
1981-1974	8 Cyl. 5.9L; 8.5mm High Performance Wire; w/ Straight Bendable Spark Plug Boot	10117
Valiant		
1976	8 Cyl. 5.9L; 8.5mm High Performance Wire; Equipped with Ceramic Spark Plug Boots	10052
1976	8 Cyl. 5.9L; 8.5mm High Performance Wire; w/ Straight Non-Bendable Spark Plug Boot	10009
1976	8 Cyl. 5.9L; 8.5mm High Performance Wire; w/ Straight Bendable Spark Plug Boot	10117
1976-1968	8 Cyl. 5.2L; 8.5mm High Performance Wire; w/ Straight Non-Bendable Spark Plug Boot	10009
1976-1968	8 Cyl. 5.2L; 8.5mm High Performance Wire; Equipped with Ceramic Spark Plug Boots	10052
1976-1968	8 Cyl. 5.2L; 8.5mm High Performance Wire; w/ Straight Bendable Spark Plug Boot	10117

Year	Model/Engine	Part No.
Spark Plug Wire Set		
Valiant		
1969-1968	8 Cyl. 4.5L; 8.5mm High Performance Wire; Equipped with Ceramic Spark Plug Boots	10052
1969-1968	8 Cyl. 4.5L; 8.5mm High Performance Wire; w/ Straight Non-Bendable Spark Plug Boot	10009
1969-1968	8 Cyl. 4.5L; 8.5mm High Performance Wire; w/ Straight Bendable Spark Plug Boot	10117
1967-1964	8 Cyl. 4.5L; 8.5mm High Performance Wire; w/ Straight Non-Bendable Spark Plug Boot	10009
1967-1964	8 Cyl. 4.5L; 8.5mm High Performance Wire; Equipped with Ceramic Spark Plug Boots	10052
1967-1964	8 Cyl. 4.5L; 8.5mm High Performance Wire; w/ Straight Bendable Spark Plug Boot	10117
VIP		
1967	8 Cyl. 6.3L; 8.5mm High Performance Wire	10043
1967	8 Cyl. 5.2L; 8.5mm High Performance Wire; Equipped with Ceramic Spark Plug Boots	10052
1967	8 Cyl. 5.2L; 8.5mm High Performance Wire; w/ Straight Non-Bendable Spark Plug Boot	10009
1967	8 Cyl. 5.2L; 8.5mm High Performance Wire; w/ Straight Bendable Spark Plug Boot	10117
Volare		
1980-1976	8 Cyl. 5.2L; 8.5mm High Performance Wire; w/ Straight Non-Bendable Spark Plug Boot	10009
1980-1976	8 Cyl. 5.2L; 8.5mm High Performance Wire; Equipped with Ceramic Spark Plug Boots	10052
1980-1976	8 Cyl. 5.9L; 8.5mm High Performance Wire; w/ Straight Non-Bendable Spark Plug Boot	10009
1980-1976	8 Cyl. 5.9L; 8.5mm High Performance Wire; Equipped with Ceramic Spark Plug Boots	10052
1980-1976	8 Cyl. 5.2L; 8.5mm High Performance Wire; w/ Straight Bendable Spark Plug Boot	10117
1980-1976	8 Cyl. 5.9L; 8.5mm High Performance Wire; w/ Straight Bendable Spark Plug Boot	10117
Pontiac		
Wire Sets		
Spark Plug Wire Set		
6000		
1986-1984	6 Cyl. 2.8L; 8.5mm High Performance Wire	10057
1986-1984	6 Cyl. 2.8L; 8.5mm High Performance Wire; Equipped with Ceramic Spark Plug Boots	10058
Acadian		
1971-1970	8 Cyl. 5.0L; 8.5mm High Performance Wire; Routed Over Valve Cover	10007
1971-1970	8 Cyl. 5.0L; 8.5mm High Performance Wire; Equipped with Ceramic Spark Plug Boots; Routed Over Valve Cover	10079
1971-1968	8 Cyl. 5.7L; 8.5mm High Performance Wire; w/ Straight Non-Bendable Spark Plug Boot	10006

Wire Sets

Year	Model/Engine	Part No.
Spark Plug Wire Set		
Acadian		
1971-1968	8 Cyl. 5.7L; 8.5mm High Performance Wire; Equipped with Ceramic Spark Plug Boots	10114
1971-1968	8 Cyl. 5.7L; 8.5mm High Performance Wire; w/ Straight Bendable Spark Plug Boot	10116
1969-1968	8 Cyl. 5.0L; 8.5mm High Performance Wire; Equipped with Ceramic Spark Plug Boots	10114
1969-1968	8 Cyl. 5.0L; 8.5mm High Performance Wire; w/ Straight Non-Bendable Spark Plug Boot	10006
1969-1968	8 Cyl. 5.0L; 8.5mm High Performance Wire; w/ Straight Bendable Spark Plug Boot	10116
1968	8 Cyl. 5.3L; 8.5mm High Performance Wire; w/ Straight Non-Bendable Spark Plug Boot	10006
1968	8 Cyl. 5.3L; 8.5mm High Performance Wire; Equipped with Ceramic Spark Plug Boots	10114
1968	8 Cyl. 5.3L; 8.5mm High Performance Wire; w/ Straight Bendable Spark Plug Boot	10116
Bonneville		
1986-1983	8 Cyl. 5.0L; 8.5mm High Performance Wire	10010
1986-1983	8 Cyl. 5.0L; 9.0mm High Performance Wire	10037
1986-1983	8 Cyl. 5.0L; 8.5mm High Performance Wire; Equipped with Ceramic Spark Plug Boots	10056
1981	8 Cyl. 4.3L; 8.5mm High Performance Wire; Canada; Equipped with Ceramic Spark Plug Boots; Export	10056
1981	8 Cyl. 4.3L; 9.0mm High Performance Wire; Canada; Export	10037
1981	8 Cyl. 4.3L; 8.5mm High Performance Wire; Canada; Export	10010
1975	8 Cyl. 7.5L; 8.5mm High Performance Wire	10001
1975	8 Cyl. 6.6L; 8.5mm High Performance Wire	10001
1975	8 Cyl. 7.5L; 8.5mm High Performance Wire; Equipped with Ceramic Spark Plug Boots	10069
1975	8 Cyl. 6.6L; 8.5mm High Performance Wire; Equipped with Ceramic Spark Plug Boots	10069
1974	8 Cyl. 7.5L; 8.5mm High Performance Wire; Exc. High Energy Ignition; w/ Straight Non-Bendable Spark Plug Boot	10006
1974	8 Cyl. 6.6L; 8.5mm High Performance Wire; Exc. High Energy Ignition; w/ Straight Non-Bendable Spark Plug Boot	10006
1974	8 Cyl. 7.5L; 8.5mm High Performance Wire; Equipped with Ceramic Spark Plug Boots; Exc. High Energy Ignition	10114
1974	8 Cyl. 6.6L; 8.5mm High Performance Wire; Exc. High Energy Ignition; w/ Straight Bendable Spark Plug Boot	10116
1974	8 Cyl. 7.5L; 8.5mm High Performance Wire; Exc. High Energy Ignition; w/ Straight Bendable Spark Plug Boot	10116
1974-1968	8 Cyl. 6.6L; 8.5mm High Performance Wire; Equipped with Ceramic Spark Plug Boots	10114
1973-1970	8 Cyl. 7.5L; 8.5mm High Performance Wire; w/ Straight Non-Bendable Spark Plug Boot	10006

Year	Model/Engine	Part No.
Spark Plug Wire Set		
Bonneville		
1973-1970	8 Cyl. 7.5L; 8.5mm High Performance Wire; Equipped with Ceramic Spark Plug Boots	10114
1973-1970	8 Cyl. 7.5L; 8.5mm High Performance Wire; w/ Straight Bendable Spark Plug Boot	10116
1973-1968	8 Cyl. 6.6L; 8.5mm High Performance Wire; w/ Straight Non-Bendable Spark Plug Boot	10006
1973-1968	8 Cyl. 6.6L; 8.5mm High Performance Wire; w/ Straight Bendable Spark Plug Boot	10116
1970	8 Cyl. 5.7L; 8.5mm High Performance Wire; Equipped with Ceramic Spark Plug Boots	10114
1970	8 Cyl. 5.7L; 8.5mm High Performance Wire; w/ Straight Non-Bendable Spark Plug Boot	10006
1970	8 Cyl. 5.7L; 8.5mm High Performance Wire; w/ Straight Bendable Spark Plug Boot	10116
1969-1968	8 Cyl. 7.0L; 8.5mm High Performance Wire; w/ Straight Non-Bendable Spark Plug Boot	10006
1969-1968	8 Cyl. 7.0L; 8.5mm High Performance Wire; Equipped with Ceramic Spark Plug Boots	10114
1969-1968	8 Cyl. 7.0L; 8.5mm High Performance Wire; w/ Straight Bendable Spark Plug Boot	10116
1967	8 Cyl. 6.6L; 8.5mm High Performance Wire; w/ Straight Non-Bendable Spark Plug Boot	10006
1967	8 Cyl. 7.0L; 8.5mm High Performance Wire; Equipped with Ceramic Spark Plug Boots	10114
1967	8 Cyl. 7.0L; 8.5mm High Performance Wire; w/ Straight Non-Bendable Spark Plug Boot	10006
1967	8 Cyl. 6.6L; 8.5mm High Performance Wire; Equipped with Ceramic Spark Plug Boots	10114
1967	8 Cyl. 6.6L; 8.5mm High Performance Wire; w/ Straight Bendable Spark Plug Boot	10116
1967	8 Cyl. 7.0L; 8.5mm High Performance Wire; w/ Straight Bendable Spark Plug Boot	10116
1966-1964	8 Cyl. 6.9L; 8.5mm High Performance Wire; w/ Straight Non-Bendable Spark Plug Boot	10006
1966-1964	8 Cyl. 6.4L; 8.5mm High Performance Wire; Equipped with Ceramic Spark Plug Boots	10114
1966-1964	8 Cyl. 6.9L; 8.5mm High Performance Wire; Equipped with Ceramic Spark Plug Boots	10114
1966-1964	8 Cyl. 6.4L; 8.5mm High Performance Wire; w/ Straight Non-Bendable Spark Plug Boot	10006
1966-1964	8 Cyl. 6.4L; 8.5mm High Performance Wire; w/ Straight Bendable Spark Plug Boot	10116
1966-1964	8 Cyl. 6.9L; 8.5mm High Performance Wire; w/ Straight Bendable Spark Plug Boot	10116
1963	8 Cyl. 6.9L; 8.5mm High Performance Wire	10008
1963	8 Cyl. 6.9L; 8.5mm High Performance Wire; Equipped with Ceramic Spark Plug Boots	10059

Wire Sets

Year	Model/Engine	Part No.
Spark Plug Wire Set		
Bonneville		
1963-1961	8 Cyl. 6.4L; 8.5mm High Performance Wire; Equipped with Ceramic Spark Plug Boots	10059
1963-1961	8 Cyl. 6.4L; 8.5mm High Performance Wire	10008
1960-1959	8 Cyl. 6.4L; 8.5mm High Performance Wire; Equipped with Ceramic Spark Plug Boots	10114
1960-1959	8 Cyl. 6.4L; 8.5mm High Performance Wire; w/ Straight Non-Bendable Spark Plug Boot	10006
1960-1959	8 Cyl. 6.4L; 8.5mm High Performance Wire; w/ Straight Bendable Spark Plug Boot	10116
1958	8 Cyl. 6.1L; 8.5mm High Performance Wire; w/ Straight Non-Bendable Spark Plug Boot	10006
1958	8 Cyl. 6.1L; 8.5mm High Performance Wire; Equipped with Ceramic Spark Plug Boots	10114
1958	8 Cyl. 6.1L; 8.5mm High Performance Wire; w/ Straight Bendable Spark Plug Boot	10116
1957	8 Cyl. 5.7L; 8.5mm High Performance Wire; w/ Straight Non-Bendable Spark Plug Boot	10006
1957	8 Cyl. 5.7L; 8.5mm High Performance Wire; Equipped with Ceramic Spark Plug Boots	10114
1957	8 Cyl. 5.7L; 8.5mm High Performance Wire; w/ Straight Bendable Spark Plug Boot	10116
Catalina		
1981-1980	8 Cyl. 5.0L; 9.0mm High Performance Wire	10037
1981-1980	8 Cyl. 4.4L; 8.5mm High Performance Wire; Equipped with Ceramic Spark Plug Boots	10056
1981-1980	8 Cyl. 5.0L; 8.5mm High Performance Wire	10010
1981-1980	8 Cyl. 5.0L; 8.5mm High Performance Wire; Equipped with Ceramic Spark Plug Boots	10056
1981-1980	8 Cyl. 4.4L; 9.0mm High Performance Wire	10037
1981-1980	8 Cyl. 4.4L; 8.5mm High Performance Wire	10010
1975	8 Cyl. 6.6L; 8.5mm High Performance Wire	10001
1975	8 Cyl. 7.5L; 8.5mm High Performance Wire; Equipped with Ceramic Spark Plug Boots	10069
1975	8 Cyl. 7.5L; 8.5mm High Performance Wire	10001
1975	8 Cyl. 6.6L; 8.5mm High Performance Wire; Equipped with Ceramic Spark Plug Boots	10069
1974	8 Cyl. 7.5L; 8.5mm High Performance Wire; Exc. High Energy Ignition; w/ Straight Non-Bendable Spark Plug Boot	10006
1974	8 Cyl. 6.6L; 8.5mm High Performance Wire; Exc. High Energy Ignition; w/ Straight Non-Bendable Spark Plug Boot	10006
1974	8 Cyl. 7.5L; 8.5mm High Performance Wire; Equipped with Ceramic Spark Plug Boots; Exc. High Energy Ignition	10114
1974	8 Cyl. 6.6L; 8.5mm High Performance Wire; Exc. High Energy Ignition; w/ Straight Bendable Spark Plug Boot	10116

Year	Model/Engine	Part No.
Spark Plug Wire Set		
Catalina		
1974	8 Cyl. 7.5L; 8.5mm High Performance Wire; Exc. High Energy Ignition; w/ Straight Bendable Spark Plug Boot	10116
1974-1967	8 Cyl. 6.6L; 8.5mm High Performance Wire; Equipped with Ceramic Spark Plug Boots	10114
1973-1970	8 Cyl. 5.7L; 8.5mm High Performance Wire; w/ Straight Non-Bendable Spark Plug Boot	10006
1973-1970	8 Cyl. 7.5L; 8.5mm High Performance Wire; w/ Straight Non-Bendable Spark Plug Boot	10006
1973-1970	8 Cyl. 7.5L; 8.5mm High Performance Wire; Equipped with Ceramic Spark Plug Boots	10114
1973-1970	8 Cyl. 5.7L; 8.5mm High Performance Wire; Equipped with Ceramic Spark Plug Boots	10114
1973-1970	8 Cyl. 5.7L; 8.5mm High Performance Wire; w/ Straight Bendable Spark Plug Boot	10116
1973-1970	8 Cyl. 7.5L; 8.5mm High Performance Wire; w/ Straight Bendable Spark Plug Boot	10116
1973-1967	8 Cyl. 6.6L; 8.5mm High Performance Wire; w/ Straight Non-Bendable Spark Plug Boot	10006
1973-1967	8 Cyl. 6.6L; 8.5mm High Performance Wire; w/ Straight Bendable Spark Plug Boot	10116
1969-1967	8 Cyl. 7.0L; 8.5mm High Performance Wire; Equipped with Ceramic Spark Plug Boots	10114
1969-1967	8 Cyl. 7.0L; 8.5mm High Performance Wire; w/ Straight Non-Bendable Spark Plug Boot	10006
1969-1967	8 Cyl. 7.0L; 8.5mm High Performance Wire; w/ Straight Bendable Spark Plug Boot	10116
1966-1964	8 Cyl. 6.9L; 8.5mm High Performance Wire; Equipped with Ceramic Spark Plug Boots	10114
1966-1964	8 Cyl. 6.4L; 8.5mm High Performance Wire; w/ Straight Non-Bendable Spark Plug Boot	10006
1966-1964	8 Cyl. 6.4L; 8.5mm High Performance Wire; Equipped with Ceramic Spark Plug Boots	10114
1966-1964	8 Cyl. 6.9L; 8.5mm High Performance Wire; w/ Straight Non-Bendable Spark Plug Boot	10006
1966-1964	8 Cyl. 6.4L; 8.5mm High Performance Wire; w/ Straight Bendable Spark Plug Boot	10116
1966-1964	8 Cyl. 6.9L; 8.5mm High Performance Wire; w/ Straight Bendable Spark Plug Boot	10116
1963	8 Cyl. 6.9L; 8.5mm High Performance Wire	10008
1963	8 Cyl. 6.9L; 8.5mm High Performance Wire; Equipped with Ceramic Spark Plug Boots	10059
1963-1961	8 Cyl. 6.4L; 8.5mm High Performance Wire; Equipped with Ceramic Spark Plug Boots	10059
1963-1961	8 Cyl. 6.4L; 8.5mm High Performance Wire	10008
1960-1959	8 Cyl. 6.4L; 8.5mm High Performance Wire; w/ Straight Non-Bendable Spark Plug Boot	10006

Wire Sets

Year	Model/Engine	Part No.
Spark Plug Wire Set		
Catalina		
1960-1959	8 Cyl. 6.4L; 8.5mm High Performance Wire; Equipped with Ceramic Spark Plug Boots	10114
1960-1959	8 Cyl. 6.4L; 8.5mm High Performance Wire; w/ Straight Bendable Spark Plug Boot	10116
1958	8 Cyl. 6.1L; 8.5mm High Performance Wire; Equipped with Ceramic Spark Plug Boots	10114
1958	8 Cyl. 6.1L; 8.5mm High Performance Wire; w/ Straight Non-Bendable Spark Plug Boot	10006
1958	8 Cyl. 6.1L; 8.5mm High Performance Wire; w/ Straight Bendable Spark Plug Boot	10116
1957	8 Cyl. 5.7L; 8.5mm High Performance Wire; w/ Straight Non-Bendable Spark Plug Boot	10006
1957	8 Cyl. 5.7L; 8.5mm High Performance Wire; Equipped with Ceramic Spark Plug Boots	10114
1957	8 Cyl. 5.7L; 8.5mm High Performance Wire; w/ Straight Bendable Spark Plug Boot	10116
1956	8 Cyl. 5.2L; 8.5mm High Performance Wire; Equipped with Ceramic Spark Plug Boots	10114
1956	8 Cyl. 5.2L; 8.5mm High Performance Wire; w/ Straight Non-Bendable Spark Plug Boot	10006
1956	8 Cyl. 5.2L; 8.5mm High Performance Wire; w/ Straight Bendable Spark Plug Boot	10116
1955	8 Cyl. 4.7L; 8.5mm High Performance Wire; w/ Straight Non-Bendable Spark Plug Boot	10006
1955	8 Cyl. 4.7L; 8.5mm High Performance Wire; Equipped with Ceramic Spark Plug Boots	10114
1955	8 Cyl. 4.7L; 8.5mm High Performance Wire; w/ Straight Bendable Spark Plug Boot	10116
Chieftain		
1958	8 Cyl. 6.1L; 8.5mm High Performance Wire; w/ Straight Non-Bendable Spark Plug Boot	10006
1958	8 Cyl. 6.1L; 8.5mm High Performance Wire; Equipped with Ceramic Spark Plug Boots	10114
1958	8 Cyl. 6.1L; 8.5mm High Performance Wire; w/ Straight Bendable Spark Plug Boot	10116
1957	8 Cyl. 5.7L; 8.5mm High Performance Wire; w/ Straight Non-Bendable Spark Plug Boot	10006
1957	8 Cyl. 5.7L; 8.5mm High Performance Wire; Equipped with Ceramic Spark Plug Boots	10114
1957	8 Cyl. 5.7L; 8.5mm High Performance Wire; w/ Straight Bendable Spark Plug Boot	10116
1956	8 Cyl. 5.2L; 8.5mm High Performance Wire; Equipped with Ceramic Spark Plug Boots	10114
1956	8 Cyl. 5.2L; 8.5mm High Performance Wire; w/ Straight Non-Bendable Spark Plug Boot	10006
1956	8 Cyl. 5.2L; 8.5mm High Performance Wire; w/ Straight Bendable Spark Plug Boot	10116

Year	Model/Engine	Part No.
Spark Plug Wire Set		
Chieftain		
1955	8 Cyl. 4.7L; 8.5mm High Performance Wire; Equipped with Ceramic Spark Plug Boots	10114
1955	8 Cyl. 4.7L; 8.5mm High Performance Wire; w/ Straight Non-Bendable Spark Plug Boot	10006
1955	8 Cyl. 4.7L; 8.5mm High Performance Wire; w/ Straight Bendable Spark Plug Boot	10116
Fiero		
1988-1985	6 Cyl. 2.8L; 8.5mm High Performance Wire	10057
1988-1985	6 Cyl. 2.8L; 8.5mm High Performance Wire; Equipped with Ceramic Spark Plug Boots	10058
Firebird		
2002	6 Cyl. 3.8L; 8.5mm High Performance Wire	10023
2002	8 Cyl. 5.7L; 9.0mm High Performance Wire	10039
2002	8 Cyl. 5.7L; 8.5mm High Performance Wire	10026
2001-2000	6 Cyl. 3.8L; 8.5mm High Performance Wire	10023
2001-1998	8 Cyl. 5.7L; 9.0mm High Performance Wire	10039
2001-1998	8 Cyl. 5.7L; 8.5mm High Performance Wire	10026
1999-1995	6 Cyl. 3.8L; 8.5mm High Performance Wire	10022
1997-1995	8 Cyl. 5.7L; 8.5mm High Performance Wire	10033
1994-1993	8 Cyl. 5.7L; 8.5mm High Performance Wire	10033
1989-1982	6 Cyl. 2.8L; 8.5mm High Performance Wire	10057
1989-1982	6 Cyl. 2.8L; 8.5mm High Performance Wire; Equipped with Ceramic Spark Plug Boots	10058
1986-1985	8 Cyl. 5.0L; 8.5mm High Performance Wire; Carb.; Equipped with Ceramic Spark Plug Boots	10056
1986-1985	8 Cyl. 5.0L; 8.5mm High Performance Wire; Carb.	10010
1986-1985	8 Cyl. 5.0L; 9.0mm High Performance Wire; Carb.	10037
1984-1982	8 Cyl. 5.0L; 8.5mm High Performance Wire; Equipped with Ceramic Spark Plug Boots	10056
1984-1982	8 Cyl. 5.0L; 8.5mm High Performance Wire	10010
1984-1982	8 Cyl. 5.0L; 9.0mm High Performance Wire	10037
1981	8 Cyl. 5.0L; 8.5mm High Performance Wire	10002
1981	8 Cyl. 4.4L; 8.5mm High Performance Wire	10010
1981	8 Cyl. 5.0L; 9.0mm High Performance Wire	10034
1981	8 Cyl. 4.4L; 8.5mm High Performance Wire; Equipped with Ceramic Spark Plug Boots	10056
1981	8 Cyl. 4.4L; 9.0mm High Performance Wire	10037
1981-1977	8 Cyl. 5.0L; 8.5mm High Performance Wire; Equipped with Ceramic Spark Plug Boots	10053
1980	8 Cyl. 5.0L; 8.5mm High Performance Wire; Calif.	10002

Wire Sets

Year	Model/Engine	Part No.
Spark Plug Wire Set		
Firebird		
1980	8 Cyl. 5.0L; 9.0mm High Performance Wire; Calif.	10034
1980	8 Cyl. 5.0L; 9.0mm High Performance Wire; Fed.	10034
1980	8 Cyl. 5.0L; 8.5mm High Performance Wire; Fed.	10002
1979-1978	8 Cyl. 5.7L; 9.0mm High Performance Wire	10034
1979-1978	8 Cyl. 5.7L; 8.5mm High Performance Wire; Equipped with Ceramic Spark Plug Boots	10053
1979-1978	8 Cyl. 5.7L; 8.5mm High Performance Wire	10002
1979-1977	8 Cyl. 5.0L; 8.5mm High Performance Wire	10002
1979-1977	8 Cyl. 5.0L; 9.0mm High Performance Wire	10034
1975	8 Cyl. 6.6L; 8.5mm High Performance Wire; Equipped with Ceramic Spark Plug Boots	10069
1975	8 Cyl. 7.5L; 8.5mm High Performance Wire; Equipped with Ceramic Spark Plug Boots	10069
1975	8 Cyl. 6.6L; 8.5mm High Performance Wire	10001
1975	8 Cyl. 5.7L; 8.5mm High Performance Wire	10001
1975	8 Cyl. 7.5L; 8.5mm High Performance Wire	10001
1975	8 Cyl. 5.7L; 8.5mm High Performance Wire; Equipped with Ceramic Spark Plug Boots	10069
1974	8 Cyl. 7.5L; 8.5mm High Performance Wire; Equipped with Ceramic Spark Plug Boots; Exc. High Energy Ignition	10114
1974	8 Cyl. 5.7L; 8.5mm High Performance Wire; Exc. High Energy Ignition; w/ Straight Non-Bendable Spark Plug Boot	10006
1974	8 Cyl. 6.6L; 8.5mm High Performance Wire; Exc. High Energy Ignition; w/ Straight Non-Bendable Spark Plug Boot	10006
1974	8 Cyl. 7.5L; 8.5mm High Performance Wire; Exc. High Energy Ignition; w/ Straight Non-Bendable Spark Plug Boot	10006
1974	8 Cyl. 5.7L; 8.5mm High Performance Wire; Exc. High Energy Ignition; w/ Straight Bendable Spark Plug Boot	10116
1974	8 Cyl. 6.6L; 8.5mm High Performance Wire; Exc. High Energy Ignition; w/ Straight Bendable Spark Plug Boot	10116
1974	8 Cyl. 7.5L; 8.5mm High Performance Wire; Exc. High Energy Ignition; w/ Straight Bendable Spark Plug Boot	10116
1974-1969	8 Cyl. 6.6L; 8.5mm High Performance Wire; Equipped with Ceramic Spark Plug Boots	10114
1974-1969	8 Cyl. 5.7L; 8.5mm High Performance Wire; Equipped with Ceramic Spark Plug Boots	10114
1973-1971	8 Cyl. 7.5L; 8.5mm High Performance Wire; w/ Straight Non-Bendable Spark Plug Boot	10006
1973-1971	8 Cyl. 7.5L; 8.5mm High Performance Wire; Equipped with Ceramic Spark Plug Boots	10114
1973-1971	8 Cyl. 7.5L; 8.5mm High Performance Wire; w/ Straight Bendable Spark Plug Boot	10116
1973-1969	8 Cyl. 6.6L; 8.5mm High Performance Wire; w/ Straight Non-Bendable Spark Plug Boot	10006

Year	Model/Engine	Part No.
Spark Plug Wire Set		
Firebird		
1973-1969	8 Cyl. 5.7L; 8.5mm High Performance Wire; w/ Straight Non-Bendable Spark Plug Boot	10006
1973-1969	8 Cyl. 5.7L; 8.5mm High Performance Wire; w/ Straight Bendable Spark Plug Boot	10116
1973-1969	8 Cyl. 6.6L; 8.5mm High Performance Wire; w/ Straight Bendable Spark Plug Boot	10116
1968	8 Cyl. 5.7L; 8.5mm High Performance Wire; w/ AC; w/ Straight Non-Bendable Spark Plug Boot	10006
1968	8 Cyl. 5.7L; 8.5mm High Performance Wire; w/o AC	10008
1968	8 Cyl. 5.7L; 8.5mm High Performance Wire; Equipped with Ceramic Spark Plug Boots; w/o AC	10059
1968	8 Cyl. 5.7L; 8.5mm High Performance Wire; Equipped with Ceramic Spark Plug Boots; w/ AC	10114
1968	8 Cyl. 5.7L; 8.5mm High Performance Wire; w/ AC; w/ Straight Bendable Spark Plug Boot	10116
1968-1967	8 Cyl. 6.6L; 8.5mm High Performance Wire; Equipped with Ceramic Spark Plug Boots; w/o AC	10059
1968-1967	8 Cyl. 6.6L; 8.5mm High Performance Wire; w/o AC	10008
1968-1967	8 Cyl. 6.6L; 8.5mm High Performance Wire; Equipped with Ceramic Spark Plug Boots; w/ AC	10114
1968-1967	8 Cyl. 6.6L; 8.5mm High Performance Wire; w/ AC; w/ Straight Non-Bendable Spark Plug Boot	10006
1968-1967	8 Cyl. 6.6L; 8.5mm High Performance Wire; w/ AC; w/ Straight Bendable Spark Plug Boot	10116
1967	8 Cyl. 5.3L; 8.5mm High Performance Wire; w/o AC	10008
1967	8 Cyl. 5.3L; 8.5mm High Performance Wire; w/ AC; w/ Straight Non-Bendable Spark Plug Boot	10006
1967	8 Cyl. 5.3L; 8.5mm High Performance Wire; Equipped with Ceramic Spark Plug Boots; w/o AC	10059
1967	8 Cyl. 5.3L; 8.5mm High Performance Wire; Equipped with Ceramic Spark Plug Boots; w/ AC	10114
1967	8 Cyl. 5.3L; 8.5mm High Performance Wire; w/ AC; w/ Straight Bendable Spark Plug Boot	10116
G8		
2009	8 Cyl. 6.2L; 8.5mm High Performance Wire	10026
2009	8 Cyl. 6.2L; 9.0mm High Performance Wire	10039
2009-2008	8 Cyl. 6.0L; 8.5mm High Performance Wire	10026
2009-2008	8 Cyl. 6.0L; 9.0mm High Performance Wire	10039
Grand Am		
1980	8 Cyl. 5.0L; 8.5mm High Performance Wire; Equipped with Ceramic Spark Plug Boots	10056
1980-1979	8 Cyl. 5.0L; 8.5mm High Performance Wire	10010
1980-1979	8 Cyl. 5.0L; 9.0mm High Performance Wire	10037
1978	8 Cyl. 5.0L; U; 9.0mm High Performance Wire	10037

Wire Sets

Year	Model/Engine	Part No.
Spark Plug Wire Set		
Grand Am		
1978	8 Cyl. 5.0L; U; 8.5mm High Performance Wire	10010
1978	8 Cyl. 5.0L; U; 8.5mm High Performance Wire; Equipped with Ceramic Spark Plug Boots	10056
1975	8 Cyl. 5.7L; 8.5mm High Performance Wire	10001
1975	8 Cyl. 7.5L; 8.5mm High Performance Wire; Equipped with Ceramic Spark Plug Boots	10069
1975	8 Cyl. 6.6L; 8.5mm High Performance Wire	10001
1975	8 Cyl. 5.7L; 8.5mm High Performance Wire; Equipped with Ceramic Spark Plug Boots	10069
1975	8 Cyl. 6.6L; 8.5mm High Performance Wire; Equipped with Ceramic Spark Plug Boots	10069
1975	8 Cyl. 7.5L; 8.5mm High Performance Wire	10001
1974	8 Cyl. 7.5L; 8.5mm High Performance Wire; Equipped with Ceramic Spark Plug Boots; Exc. High Energy Ignition	10114
1974	8 Cyl. 7.5L; 8.5mm High Performance Wire; Exc. High Energy Ignition; w/ Straight Non-Bendable Spark Plug Boot	10006
1974	8 Cyl. 7.5L; 8.5mm High Performance Wire; Exc. High Energy Ignition; w/ Straight Bendable Spark Plug Boot	10116
1974-1973	8 Cyl. 6.6L; 8.5mm High Performance Wire; w/ Straight Non-Bendable Spark Plug Boot	10006
1974-1973	8 Cyl. 6.6L; 8.5mm High Performance Wire; Equipped with Ceramic Spark Plug Boots	10114
1974-1973	8 Cyl. 6.6L; 8.5mm High Performance Wire; w/ Straight Bendable Spark Plug Boot	10116
1973	8 Cyl. 5.7L; 8.5mm High Performance Wire; w/ Straight Non-Bendable Spark Plug Boot	10006
1973	8 Cyl. 7.5L; 8.5mm High Performance Wire; w/ Straight Non-Bendable Spark Plug Boot	10006
1973	8 Cyl. 7.5L; 8.5mm High Performance Wire; Equipped with Ceramic Spark Plug Boots	10114
1973	8 Cyl. 5.7L; 8.5mm High Performance Wire; Equipped with Ceramic Spark Plug Boots	10114
1973	8 Cyl. 5.7L; 8.5mm High Performance Wire; w/ Straight Bendable Spark Plug Boot	10116
1973	8 Cyl. 7.5L; 8.5mm High Performance Wire; w/ Straight Bendable Spark Plug Boot	10116
Grand LeMans		
1983-1982	8 Cyl. 5.0L; 8.5mm High Performance Wire	10010
1983-1982	8 Cyl. 5.0L; 9.0mm High Performance Wire	10037
1983-1982	8 Cyl. 5.0L; 8.5mm High Performance Wire; Equipped with Ceramic Spark Plug Boots	10056
1982	8 Cyl. 4.4L; 8.5mm High Performance Wire	10010
1982	8 Cyl. 4.4L; 8.5mm High Performance Wire; Equipped with Ceramic Spark Plug Boots	10056
1982	8 Cyl. 4.4L; 9.0mm High Performance Wire	10037

Year	Model/Engine	Part No.
Spark Plug Wire Set		
Grand LeMans		
1981	8 Cyl. 4.3L; 9.0mm High Performance Wire; Canada; Export	10037
1981	8 Cyl. 4.3L; 8.5mm High Performance Wire; Canada; Export	10010
1981	8 Cyl. 4.3L; 8.5mm High Performance Wire; Canada; Equipped with Ceramic Spark Plug Boots; Export	10056
1981-1979	8 Cyl. 5.0L; 9.0mm High Performance Wire	10037
1981-1979	8 Cyl. 4.4L; 8.5mm High Performance Wire	10010
1981-1979	8 Cyl. 4.4L; 9.0mm High Performance Wire	10037
1981-1979	8 Cyl. 5.0L; 8.5mm High Performance Wire; Equipped with Ceramic Spark Plug Boots	10056
1981-1979	8 Cyl. 4.4L; 8.5mm High Performance Wire; Equipped with Ceramic Spark Plug Boots	10056
1981-1979	8 Cyl. 5.0L; 8.5mm High Performance Wire	10010
1979	8 Cyl. 5.7L; 8.5mm High Performance Wire; Equipped with Ceramic Spark Plug Boots	10056
1979	8 Cyl. 5.7L; 8.5mm High Performance Wire	10010
1979	8 Cyl. 5.7L; 9.0mm High Performance Wire	10037
1978	8 Cyl. 5.7L; L; 8.5mm High Performance Wire	10010
1978	8 Cyl. 5.7L; L; 9.0mm High Performance Wire	10037
1978	8 Cyl. 5.7L; L; 8.5mm High Performance Wire; Equipped with Ceramic Spark Plug Boots	10056
1978	8 Cyl. 5.0L; U; 9.0mm High Performance Wire	10037
1978	8 Cyl. 5.0L; U; 8.5mm High Performance Wire; Equipped with Ceramic Spark Plug Boots	10056
1978	8 Cyl. 5.0L; U; 8.5mm High Performance Wire	10010
1977	8 Cyl. 5.0L; 8.5mm High Performance Wire; Equipped with Ceramic Spark Plug Boots	10053
1977	8 Cyl. 5.0L; 9.0mm High Performance Wire	10034
1977	8 Cyl. 5.0L; 8.5mm High Performance Wire	10002
1977	8 Cyl. 5.7L; L; 8.5mm High Performance Wire	10002
1977	8 Cyl. 5.7L; L; 9.0mm High Performance Wire	10034
1977	8 Cyl. 5.7L; L; 8.5mm High Performance Wire; Equipped with Ceramic Spark Plug Boots	10053
1975	8 Cyl. 7.5L; 8.5mm High Performance Wire	10001
1975	8 Cyl. 7.5L; 8.5mm High Performance Wire; Equipped with Ceramic Spark Plug Boots	10069
1975	8 Cyl. 5.7L; 8.5mm High Performance Wire; Equipped with Ceramic Spark Plug Boots	10069
1975	8 Cyl. 6.6L; 8.5mm High Performance Wire	10001
1975	8 Cyl. 5.7L; 8.5mm High Performance Wire	10001

Wire Sets

Year	Model/Engine	Part No.
Spark Plug Wire Set		
Grand LeMans		
1975	8 Cyl. 6.6L; 8.5mm High Performance Wire; Equipped with Ceramic Spark Plug Boots	10069
Grand Prix		
2008-2005	8 Cyl. 5.3L; 9.0mm High Performance Wire	10042
2008-2005	8 Cyl. 5.3L; 8.5mm High Performance Wire	10041
1986-1983	8 Cyl. 5.0L; 8.5mm High Performance Wire	10010
1986-1983	8 Cyl. 5.0L; 9.0mm High Performance Wire	10037
1986-1983	8 Cyl. 5.0L; 8.5mm High Performance Wire; Equipped with Ceramic Spark Plug Boots	10056
1982-1981	8 Cyl. 4.4L; 8.5mm High Performance Wire; Equipped with Ceramic Spark Plug Boots	10056
1982-1981	8 Cyl. 4.4L; 8.5mm High Performance Wire	10010
1982-1981	8 Cyl. 4.4L; 9.0mm High Performance Wire	10037
1981	8 Cyl. 4.3L; 8.5mm High Performance Wire; Canada; Equipped with Ceramic Spark Plug Boots; Export	10056
1981	8 Cyl. 4.3L; 8.5mm High Performance Wire; Canada; Export	10010
1981	8 Cyl. 4.3L; 9.0mm High Performance Wire; Canada; Export	10037
1980-1979	8 Cyl. 5.0L; 8.5mm High Performance Wire	10010
1980-1979	8 Cyl. 5.0L; 9.0mm High Performance Wire	10037
1980-1979	8 Cyl. 5.0L; 8.5mm High Performance Wire; Equipped with Ceramic Spark Plug Boots	10056
1978	8 Cyl. 5.0L; U; 8.5mm High Performance Wire; Equipped with Ceramic Spark Plug Boots	10056
1978	8 Cyl. 5.0L; U; 9.0mm High Performance Wire	10037
1978	8 Cyl. 5.0L; U; 8.5mm High Performance Wire	10010
1975	8 Cyl. 6.6L; 8.5mm High Performance Wire	10001
1975	8 Cyl. 7.5L; 8.5mm High Performance Wire	10001
1975	8 Cyl. 7.5L; 8.5mm High Performance Wire; Equipped with Ceramic Spark Plug Boots	10069
1975	8 Cyl. 6.6L; 8.5mm High Performance Wire; Equipped with Ceramic Spark Plug Boots	10069
1974	8 Cyl. 7.5L; 8.5mm High Performance Wire; Equipped with Ceramic Spark Plug Boots; Exc. High Energy Ignition	10114
1974	8 Cyl. 7.5L; 8.5mm High Performance Wire; Exc. High Energy Ignition; w/ Straight Non-Bendable Spark Plug Boot	10006
1974	8 Cyl. 6.6L; 8.5mm High Performance Wire; Exc. High Energy Ignition; w/ Straight Non-Bendable Spark Plug Boot	10006
1974	8 Cyl. 6.6L; 8.5mm High Performance Wire; Equipped with Ceramic Spark Plug Boots; Exc. High Energy Ignition	10114
1974	8 Cyl. 6.6L; 8.5mm High Performance Wire; Exc. High Energy Ignition; w/ Straight Bendable Spark Plug Boot	10116

Year	Model/Engine	Part No.
Spark Plug Wire Set		
Grand Prix		
1974	8 Cyl. 7.5L; 8.5mm High Performance Wire; Exc. High Energy Ignition; w/ Straight Bendable Spark Plug Boot	10116
1973-1970	8 Cyl. 7.5L; 8.5mm High Performance Wire; w/ Straight Non-Bendable Spark Plug Boot	10006
1973-1970	8 Cyl. 7.5L; 8.5mm High Performance Wire; Equipped with Ceramic Spark Plug Boots	10114
1973-1970	8 Cyl. 7.5L; 8.5mm High Performance Wire; w/ Straight Bendable Spark Plug Boot	10116
1973-1968	8 Cyl. 6.6L; 8.5mm High Performance Wire; Equipped with Ceramic Spark Plug Boots	10114
1973-1968	8 Cyl. 6.6L; 8.5mm High Performance Wire; w/ Straight Non-Bendable Spark Plug Boot	10006
1973-1968	8 Cyl. 6.6L; 8.5mm High Performance Wire; w/ Straight Bendable Spark Plug Boot	10116
1969-1968	8 Cyl. 7.0L; 8.5mm High Performance Wire; w/ Straight Non-Bendable Spark Plug Boot	10006
1969-1968	8 Cyl. 7.0L; 8.5mm High Performance Wire; Equipped with Ceramic Spark Plug Boots	10114
1969-1968	8 Cyl. 7.0L; 8.5mm High Performance Wire; w/ Straight Bendable Spark Plug Boot	10116
1967	8 Cyl. 6.6L; 8.5mm High Performance Wire; Equipped with Ceramic Spark Plug Boots	10114
1967	8 Cyl. 6.6L; 8.5mm High Performance Wire; w/ Straight Non-Bendable Spark Plug Boot	10006
1967	8 Cyl. 7.0L; 8.5mm High Performance Wire; w/ Straight Non-Bendable Spark Plug Boot	10006
1967	8 Cyl. 7.0L; 8.5mm High Performance Wire; Equipped with Ceramic Spark Plug Boots	10114
1967	8 Cyl. 6.6L; 8.5mm High Performance Wire; w/ Straight Bendable Spark Plug Boot	10116
1967	8 Cyl. 7.0L; 8.5mm High Performance Wire; w/ Straight Bendable Spark Plug Boot	10116
1966-1964	8 Cyl. 6.9L; 8.5mm High Performance Wire; Equipped with Ceramic Spark Plug Boots	10114
1966-1964	8 Cyl. 6.9L; 8.5mm High Performance Wire; w/ Straight Non-Bendable Spark Plug Boot	10006
1966-1964	8 Cyl. 6.4L; 8.5mm High Performance Wire; Equipped with Ceramic Spark Plug Boots	10114
1966-1964	8 Cyl. 6.4L; 8.5mm High Performance Wire; w/ Straight Non-Bendable Spark Plug Boot	10006
1966-1964	8 Cyl. 6.4L; 8.5mm High Performance Wire; w/ Straight Bendable Spark Plug Boot	10116
1966-1964	8 Cyl. 6.9L; 8.5mm High Performance Wire; w/ Straight Bendable Spark Plug Boot	10116
1963	8 Cyl. 6.9L; 8.5mm High Performance Wire	10008
1963	8 Cyl. 6.9L; 8.5mm High Performance Wire; Equipped with Ceramic Spark Plug Boots	10059

Wire Sets

Year	Model/Engine	Part No.
Spark Plug Wire Set		
Grand Prix		
1963-1962	8 Cyl. 6.4L; 8.5mm High Performance Wire	10008
1963-1962	8 Cyl. 6.4L; 8.5mm High Performance Wire; Equipped with Ceramic Spark Plug Boots	10059
Grand Safari		
1975	8 Cyl. 6.6L; 8.5mm High Performance Wire	10001
1975	8 Cyl. 7.5L; 8.5mm High Performance Wire	10001
1975	8 Cyl. 6.6L; 8.5mm High Performance Wire; Equipped with Ceramic Spark Plug Boots	10069
1975	8 Cyl. 7.5L; 8.5mm High Performance Wire; Equipped with Ceramic Spark Plug Boots	10069
1974	8 Cyl. 6.6L; 8.5mm High Performance Wire; Equipped with Ceramic Spark Plug Boots; Exc. High Energy Ignition	10114
1974	8 Cyl. 7.5L; 8.5mm High Performance Wire; Exc. High Energy Ignition; w/ Straight Non-Bendable Spark Plug Boot	10006
1974	8 Cyl. 6.6L; 8.5mm High Performance Wire; Exc. High Energy Ignition; w/ Straight Non-Bendable Spark Plug Boot	10006
1974	8 Cyl. 7.5L; 8.5mm High Performance Wire; Equipped with Ceramic Spark Plug Boots; Exc. High Energy Ignition	10114
1974	8 Cyl. 6.6L; 8.5mm High Performance Wire; Exc. High Energy Ignition; w/ Straight Bendable Spark Plug Boot	10116
1974	8 Cyl. 7.5L; 8.5mm High Performance Wire; Exc. High Energy Ignition; w/ Straight Bendable Spark Plug Boot	10116
1973	8 Cyl. 6.6L; 8.5mm High Performance Wire; w/ Straight Non-Bendable Spark Plug Boot	10006
1973	8 Cyl. 6.6L; 8.5mm High Performance Wire; Equipped with Ceramic Spark Plug Boots	10114
1973	8 Cyl. 6.6L; 8.5mm High Performance Wire; w/ Straight Bendable Spark Plug Boot	10116
1973-1971	8 Cyl. 7.5L; 8.5mm High Performance Wire; w/ Straight Non-Bendable Spark Plug Boot	10006
1973-1971	8 Cyl. 7.5L; 8.5mm High Performance Wire; Equipped with Ceramic Spark Plug Boots	10114
1973-1971	8 Cyl. 7.5L; 8.5mm High Performance Wire; w/ Straight Bendable Spark Plug Boot	10116
1971	8 Cyl. 6.6L; 8.5mm High Performance Wire; Equipped with Ceramic Spark Plug Boots	10114
1971	8 Cyl. 6.6L; 8.5mm High Performance Wire; w/ Straight Non-Bendable Spark Plug Boot	10006
1971	8 Cyl. 6.6L; 8.5mm High Performance Wire; w/ Straight Bendable Spark Plug Boot	10116
Grandville		
1975	8 Cyl. 6.6L; 8.5mm High Performance Wire; Equipped with Ceramic Spark Plug Boots	10069
1975	8 Cyl. 6.6L; 8.5mm High Performance Wire	10001
1975	8 Cyl. 7.5L; 8.5mm High Performance Wire; Equipped with Ceramic Spark Plug Boots	10069

Year	Model/Engine	Part No.
Spark Plug Wire Set		
Grandville		
1975	8 Cyl. 7.5L; 8.5mm High Performance Wire	10001
1974	8 Cyl. 7.5L; 8.5mm High Performance Wire; Equipped with Ceramic Spark Plug Boots; Exc. High Energy Ignition	10114
1974	8 Cyl. 7.5L; 8.5mm High Performance Wire; Exc. High Energy Ignition; w/ Straight Non-Bendable Spark Plug Boot	10006
1974	8 Cyl. 7.5L; 8.5mm High Performance Wire; Exc. High Energy Ignition; w/ Straight Bendable Spark Plug Boot	10116
1973	8 Cyl. 6.6L; 8.5mm High Performance Wire; Equipped with Ceramic Spark Plug Boots	10114
1973	8 Cyl. 6.6L; 8.5mm High Performance Wire; w/ Straight Non-Bendable Spark Plug Boot	10006
1973	8 Cyl. 6.6L; 8.5mm High Performance Wire; w/ Straight Bendable Spark Plug Boot	10116
1973-1971	8 Cyl. 7.5L; 8.5mm High Performance Wire; w/ Straight Non-Bendable Spark Plug Boot	10006
1973-1971	8 Cyl. 7.5L; 8.5mm High Performance Wire; Equipped with Ceramic Spark Plug Boots	10114
1973-1971	8 Cyl. 7.5L; 8.5mm High Performance Wire; w/ Straight Bendable Spark Plug Boot	10116
1971	8 Cyl. 6.6L; 8.5mm High Performance Wire; Equipped with Ceramic Spark Plug Boots	10114
1971	8 Cyl. 6.6L; 8.5mm High Performance Wire; w/ Straight Non-Bendable Spark Plug Boot	10006
1971	8 Cyl. 6.6L; 8.5mm High Performance Wire; w/ Straight Bendable Spark Plug Boot	10116
GTO		
2006-2005	8 Cyl. 6.0L; 8.5mm High Performance Wire	10041
2006-2005	8 Cyl. 6.0L; 9.0mm High Performance Wire	10042
2004	8 Cyl. 5.7L; 9.0mm High Performance Wire	10039
2004	8 Cyl. 5.7L; 8.5mm High Performance Wire	10026
1973-1970	8 Cyl. 7.5L; 8.5mm High Performance Wire; Equipped with Ceramic Spark Plug Boots	10114
1973-1970	8 Cyl. 7.5L; 8.5mm High Performance Wire; w/ Straight Non-Bendable Spark Plug Boot	10006
1973-1970	8 Cyl. 7.5L; 8.5mm High Performance Wire; w/ Straight Bendable Spark Plug Boot	10116
1973-1967	8 Cyl. 6.6L; 8.5mm High Performance Wire; Equipped with Ceramic Spark Plug Boots	10114
1973-1967	8 Cyl. 6.6L; 8.5mm High Performance Wire; w/ Straight Non-Bendable Spark Plug Boot	10006
1973-1967	8 Cyl. 6.6L; 8.5mm High Performance Wire; w/ Straight Bendable Spark Plug Boot	10116
1970	8 Cyl. 5.7L; 8.5mm High Performance Wire; Equipped with Ceramic Spark Plug Boots	10114
1970	8 Cyl. 5.7L; 8.5mm High Performance Wire; w/ Straight Non-Bendable Spark Plug Boot	10006

Wire Sets

Year	Model/Engine	Part No.
Spark Plug Wire Set		
GTO		
1970	8 Cyl. 5.7L; 8.5mm High Performance Wire; w/ Straight Bendable Spark Plug Boot	10116
1966-1964	8 Cyl. 6.4L; 8.5mm High Performance Wire; Equipped with Ceramic Spark Plug Boots	10114
1966-1964	8 Cyl. 6.4L; 8.5mm High Performance Wire; w/ Straight Non-Bendable Spark Plug Boot	10006
1966-1964	8 Cyl. 6.4L; 8.5mm High Performance Wire; w/ Straight Bendable Spark Plug Boot	10116
1965-1964	8 Cyl. 5.3L; 8.5mm High Performance Wire; Equipped with Ceramic Spark Plug Boots	10114
1965-1964	8 Cyl. 5.3L; 8.5mm High Performance Wire; w/ Straight Non-Bendable Spark Plug Boot	10006
1965-1964	8 Cyl. 5.3L; 8.5mm High Performance Wire; w/ Straight Bendable Spark Plug Boot	10116
LeMans		
1981	8 Cyl. 4.3L; 8.5mm High Performance Wire; Canada; Export	10010
1981	8 Cyl. 4.3L; 8.5mm High Performance Wire; Canada; Equipped with Ceramic Spark Plug Boots; Export	10056
1981	8 Cyl. 4.3L; 9.0mm High Performance Wire; Canada; Export	10037
1981-1979	8 Cyl. 4.4L; 8.5mm High Performance Wire; Equipped with Ceramic Spark Plug Boots	10056
1981-1979	8 Cyl. 5.0L; 8.5mm High Performance Wire	10010
1981-1979	8 Cyl. 4.4L; 8.5mm High Performance Wire	10010
1981-1979	8 Cyl. 4.4L; 9.0mm High Performance Wire	10037
1981-1979	8 Cyl. 5.0L; 9.0mm High Performance Wire	10037
1981-1979	8 Cyl. 5.0L; 8.5mm High Performance Wire; Equipped with Ceramic Spark Plug Boots	10056
1979-1978	8 Cyl. 5.7L; 8.5mm High Performance Wire; Equipped with Ceramic Spark Plug Boots	10056
1979-1978	8 Cyl. 5.7L; 9.0mm High Performance Wire	10037
1979-1978	8 Cyl. 5.7L; 8.5mm High Performance Wire	10010
1978	8 Cyl. 5.0L; U; 8.5mm High Performance Wire	10010
1978	8 Cyl. 5.0L; U; 8.5mm High Performance Wire; Equipped with Ceramic Spark Plug Boots	10056
1978	8 Cyl. 5.0L; U; 9.0mm High Performance Wire	10037
1977	8 Cyl. 5.7L; L; 8.5mm High Performance Wire; Equipped with Ceramic Spark Plug Boots	10053
1977	8 Cyl. 5.7L; L; 9.0mm High Performance Wire	10034
1977	8 Cyl. 5.7L; L; 8.5mm High Performance Wire	10002
1977-1976	8 Cyl. 5.0L; 8.5mm High Performance Wire	10002
1977-1976	8 Cyl. 5.0L; 8.5mm High Performance Wire; Equipped with Ceramic Spark Plug Boots	10053

Year	Model/Engine	Part No.
Spark Plug Wire Set		
LeMans		
1977-1976	8 Cyl. 5.0L; 9.0mm High Performance Wire	10034
1975	8 Cyl. 6.6L; 8.5mm High Performance Wire; Equipped with Ceramic Spark Plug Boots	10069
1975	8 Cyl. 6.6L; 8.5mm High Performance Wire	10001
1975	8 Cyl. 5.7L; 8.5mm High Performance Wire; Equipped with Ceramic Spark Plug Boots	10069
1975	8 Cyl. 5.7L; 8.5mm High Performance Wire	10001
1974	8 Cyl. 7.5L; 8.5mm High Performance Wire; Equipped with Ceramic Spark Plug Boots; Exc. High Energy Ignition	10114
1974	8 Cyl. 7.5L; 8.5mm High Performance Wire; Exc. High Energy Ignition; w/ Straight Non-Bendable Spark Plug Boot	10006
1974	8 Cyl. 6.6L; 8.5mm High Performance Wire; Equipped with Ceramic Spark Plug Boots; Exc. High Energy Ignition	10114
1974	8 Cyl. 6.6L; 8.5mm High Performance Wire; Exc. High Energy Ignition; w/ Straight Non-Bendable Spark Plug Boot	10006
1974	8 Cyl. 6.6L; 8.5mm High Performance Wire; Exc. High Energy Ignition; w/ Straight Bendable Spark Plug Boot	10116
1974	8 Cyl. 7.5L; 8.5mm High Performance Wire; Exc. High Energy Ignition; w/ Straight Bendable Spark Plug Boot	10116
1974-1968	8 Cyl. 5.7L; 8.5mm High Performance Wire; Equipped with Ceramic Spark Plug Boots	10114
1974-1968	8 Cyl. 5.7L; 8.5mm High Performance Wire; w/ Straight Non-Bendable Spark Plug Boot	10006
1974-1968	8 Cyl. 5.7L; 8.5mm High Performance Wire; w/ Straight Bendable Spark Plug Boot	10116
1973-1970	8 Cyl. 7.5L; 8.5mm High Performance Wire; Equipped with Ceramic Spark Plug Boots	10114
1973-1970	8 Cyl. 7.5L; 8.5mm High Performance Wire; w/ Straight Non-Bendable Spark Plug Boot	10006
1973-1970	8 Cyl. 7.5L; 8.5mm High Performance Wire; w/ Straight Bendable Spark Plug Boot	10116
1973-1968	8 Cyl. 6.6L; 8.5mm High Performance Wire; Equipped with Ceramic Spark Plug Boots	10114
1973-1968	8 Cyl. 6.6L; 8.5mm High Performance Wire; w/ Straight Non-Bendable Spark Plug Boot	10006
1973-1968	8 Cyl. 6.6L; 8.5mm High Performance Wire; w/ Straight Bendable Spark Plug Boot	10116
1969-1968	8 Cyl. 7.0L; 8.5mm High Performance Wire; w/ Straight Non-Bendable Spark Plug Boot	10006
1969-1968	8 Cyl. 7.0L; 8.5mm High Performance Wire; Equipped with Ceramic Spark Plug Boots	10114
1969-1968	8 Cyl. 7.0L; 8.5mm High Performance Wire; w/ Straight Bendable Spark Plug Boot	10116
1967	8 Cyl. 6.6L; 8.5mm High Performance Wire; w/ Straight Bendable Spark Plug Boot	10116

Wire Sets

Year	Model/Engine	Part No.
Spark Plug Wire Set		
LeMans		
1967-1964	8 Cyl. 5.3L; 8.5mm High Performance Wire; Equipped with Ceramic Spark Plug Boots	10114
1967-1964	8 Cyl. 5.3L; 8.5mm High Performance Wire; w/ Straight Non-Bendable Spark Plug Boot	10006
1967-1964	8 Cyl. 5.3L; 8.5mm High Performance Wire; w/ Straight Bendable Spark Plug Boot	10116
1965-1964	8 Cyl. 6.4L; 8.5mm High Performance Wire; Equipped with Ceramic Spark Plug Boots	10114
1965-1964	8 Cyl. 6.4L; 8.5mm High Performance Wire; w/ Straight Non-Bendable Spark Plug Boot	10006
1965-1964	8 Cyl. 6.4L; 8.5mm High Performance Wire; w/ Straight Bendable Spark Plug Boot	10116
1963	8 Cyl. 5.3L; 8.5mm High Performance Wire; Equipped with Ceramic Spark Plug Boots	10059
1963	8 Cyl. 5.3L; 8.5mm High Performance Wire	10008
Phoenix		
1984	6 Cyl. 2.8L; 8.5mm High Performance Wire; Equipped with Ceramic Spark Plug Boots	10058
1984	6 Cyl. 2.8L; 8.5mm High Performance Wire	10057
1979-1978	8 Cyl. 5.7L; 9.0mm High Performance Wire	10034
1979-1978	8 Cyl. 5.7L; 8.5mm High Performance Wire	10002
1979-1978	8 Cyl. 5.7L; 8.5mm High Performance Wire; Equipped with Ceramic Spark Plug Boots	10053
1979-1977	8 Cyl. 5.0L; 9.0mm High Performance Wire	10034
1979-1977	8 Cyl. 5.0L; 8.5mm High Performance Wire; Equipped with Ceramic Spark Plug Boots	10053
1979-1977	8 Cyl. 5.0L; 8.5mm High Performance Wire	10002
1977	8 Cyl. 5.7L; L; 8.5mm High Performance Wire; Equipped with Ceramic Spark Plug Boots	10053
1977	8 Cyl. 5.7L; L; 8.5mm High Performance Wire	10002
1977	8 Cyl. 5.7L; L; 9.0mm High Performance Wire	10034
Safari		
1970	8 Cyl. 6.6L; 8.5mm High Performance Wire; Equipped with Ceramic Spark Plug Boots	10114
1970	8 Cyl. 6.6L; 8.5mm High Performance Wire; w/ Straight Non-Bendable Spark Plug Boot	10006
1970	8 Cyl. 6.6L; 8.5mm High Performance Wire; w/ Straight Bendable Spark Plug Boot	10116
1970-1968	8 Cyl. 5.7L; 8.5mm High Performance Wire; w/ Straight Non-Bendable Spark Plug Boot	10006
1970-1968	8 Cyl. 5.7L; 8.5mm High Performance Wire; Equipped with Ceramic Spark Plug Boots	10114
1970-1968	8 Cyl. 5.7L; 8.5mm High Performance Wire; w/ Straight Bendable Spark Plug Boot	10116

Year	Model/Engine	Part No.
Spark Plug Wire Set		
Safari		
1968	8 Cyl. 6.6L; 8.5mm High Performance Wire; Equipped with Ceramic Spark Plug Boots	10114
1968	8 Cyl. 6.6L; 8.5mm High Performance Wire; w/ Straight Non-Bendable Spark Plug Boot	10006
1968	8 Cyl. 6.6L; 8.5mm High Performance Wire; w/ Straight Bendable Spark Plug Boot	10116
1965-1964	8 Cyl. 6.9L; 8.5mm High Performance Wire; w/ Straight Non-Bendable Spark Plug Boot	10006
1965-1964	8 Cyl. 6.4L; 8.5mm High Performance Wire; w/ Straight Non-Bendable Spark Plug Boot	10006
1965-1964	8 Cyl. 6.4L; 8.5mm High Performance Wire; Equipped with Ceramic Spark Plug Boots	10114
1965-1964	8 Cyl. 6.9L; 8.5mm High Performance Wire; Equipped with Ceramic Spark Plug Boots	10114
1965-1964	8 Cyl. 6.4L; 8.5mm High Performance Wire; w/ Straight Bendable Spark Plug Boot	10116
1965-1964	8 Cyl. 6.9L; 8.5mm High Performance Wire; w/ Straight Bendable Spark Plug Boot	10116
1963	8 Cyl. 6.9L; 8.5mm High Performance Wire; Equipped with Ceramic Spark Plug Boots	10059
1963	8 Cyl. 6.9L; 8.5mm High Performance Wire	10008
1963-1961	8 Cyl. 6.4L; 8.5mm High Performance Wire	10008
1963-1961	8 Cyl. 6.4L; 8.5mm High Performance Wire; Equipped with Ceramic Spark Plug Boots	10059
Star Chief		
1966-1964	8 Cyl. 6.4L; 8.5mm High Performance Wire; w/ Straight Non-Bendable Spark Plug Boot	10006
1966-1964	8 Cyl. 6.9L; 8.5mm High Performance Wire; w/ Straight Non-Bendable Spark Plug Boot	10006
1966-1964	8 Cyl. 6.4L; 8.5mm High Performance Wire; Equipped with Ceramic Spark Plug Boots	10114
1966-1964	8 Cyl. 6.9L; 8.5mm High Performance Wire; Equipped with Ceramic Spark Plug Boots	10114
1966-1964	8 Cyl. 6.4L; 8.5mm High Performance Wire; w/ Straight Bendable Spark Plug Boot	10116
1966-1964	8 Cyl. 6.9L; 8.5mm High Performance Wire; w/ Straight Bendable Spark Plug Boot	10116
1963	8 Cyl. 6.9L; 8.5mm High Performance Wire	10008
1963	8 Cyl. 6.9L; 8.5mm High Performance Wire; Equipped with Ceramic Spark Plug Boots	10059
1963-1961	8 Cyl. 6.4L; 8.5mm High Performance Wire; Equipped with Ceramic Spark Plug Boots	10059
1963-1961	8 Cyl. 6.4L; 8.5mm High Performance Wire	10008
1960-1959	8 Cyl. 6.4L; 8.5mm High Performance Wire; w/ Straight Non-Bendable Spark Plug Boot	10006

Wire Sets

Year	Model/Engine	Part No.
Spark Plug Wire Set		
Star Chief		
1960-1959	8 Cyl. 6.4L; 8.5mm High Performance Wire; Equipped with Ceramic Spark Plug Boots	10114
1960-1959	8 Cyl. 6.4L; 8.5mm High Performance Wire; w/ Straight Bendable Spark Plug Boot	10116
1958	8 Cyl. 6.1L; 8.5mm High Performance Wire; w/ Straight Non-Bendable Spark Plug Boot	10006
1958	8 Cyl. 6.1L; 8.5mm High Performance Wire; Equipped with Ceramic Spark Plug Boots	10114
1958	8 Cyl. 6.1L; 8.5mm High Performance Wire; w/ Straight Bendable Spark Plug Boot	10116
1957	8 Cyl. 5.7L; 8.5mm High Performance Wire; w/ Straight Non-Bendable Spark Plug Boot	10006
1957	8 Cyl. 5.7L; 8.5mm High Performance Wire; Equipped with Ceramic Spark Plug Boots	10114
1957	8 Cyl. 5.7L; 8.5mm High Performance Wire; w/ Straight Bendable Spark Plug Boot	10116
1956	8 Cyl. 5.2L; 8.5mm High Performance Wire; Equipped with Ceramic Spark Plug Boots	10114
1956	8 Cyl. 5.2L; 8.5mm High Performance Wire; w/ Straight Non-Bendable Spark Plug Boot	10006
1956	8 Cyl. 5.2L; 8.5mm High Performance Wire; w/ Straight Bendable Spark Plug Boot	10116
1955	8 Cyl. 4.7L; 8.5mm High Performance Wire; w/ Straight Non-Bendable Spark Plug Boot	10006
1955	8 Cyl. 4.7L; 8.5mm High Performance Wire; Equipped with Ceramic Spark Plug Boots	10114
1955	8 Cyl. 4.7L; 8.5mm High Performance Wire; w/ Straight Bendable Spark Plug Boot	10116
Sunbird		
1979-1978	8 Cyl. 5.0L; 8.5mm High Performance Wire	10002
1979-1978	8 Cyl. 5.0L; 9.0mm High Performance Wire	10034
1979-1978	8 Cyl. 5.0L; 8.5mm High Performance Wire; Equipped with Ceramic Spark Plug Boots	10053
Super Chief		
1958	8 Cyl. 6.1L; 8.5mm High Performance Wire; w/ Straight Non-Bendable Spark Plug Boot	10006
1958	8 Cyl. 6.1L; 8.5mm High Performance Wire; Equipped with Ceramic Spark Plug Boots	10114
1958	8 Cyl. 6.1L; 8.5mm High Performance Wire; w/ Straight Bendable Spark Plug Boot	10116
1957	8 Cyl. 5.7L; 8.5mm High Performance Wire; Equipped with Ceramic Spark Plug Boots	10114
1957	8 Cyl. 5.7L; 8.5mm High Performance Wire; w/ Straight Non-Bendable Spark Plug Boot	10006
1957	8 Cyl. 5.7L; 8.5mm High Performance Wire; w/ Straight Bendable Spark Plug Boot	10116

Year	Model/Engine	Part No.
Spark Plug Wire Set		
Tempest		
1970	8 Cyl. 5.7L; 8.5mm High Performance Wire; Equipped with Ceramic Spark Plug Boots	10114
1970	8 Cyl. 5.7L; 8.5mm High Performance Wire; w/ Straight Non-Bendable Spark Plug Boot	10006
1970	8 Cyl. 5.7L; 8.5mm High Performance Wire; w/ Straight Bendable Spark Plug Boot	10116
1970-1968	8 Cyl. 6.6L; 8.5mm High Performance Wire; Equipped with Ceramic Spark Plug Boots	10114
1970-1968	8 Cyl. 6.6L; 8.5mm High Performance Wire; w/ Straight Non-Bendable Spark Plug Boot	10006
1970-1968	8 Cyl. 6.6L; 8.5mm High Performance Wire; w/ Straight Bendable Spark Plug Boot	10116
1969-1968	8 Cyl. 7.0L; 8.5mm High Performance Wire; Equipped with Ceramic Spark Plug Boots	10114
1969-1968	8 Cyl. 7.0L; 8.5mm High Performance Wire; w/ Straight Non-Bendable Spark Plug Boot	10006
1969-1968	8 Cyl. 7.0L; 8.5mm High Performance Wire; w/ Straight Bendable Spark Plug Boot	10116
1968	8 Cyl. 5.7L; 8.5mm High Performance Wire; Equipped with Ceramic Spark Plug Boots	10114
1968	8 Cyl. 5.7L; 8.5mm High Performance Wire; w/ Straight Non-Bendable Spark Plug Boot	10006
1968	8 Cyl. 5.7L; 8.5mm High Performance Wire; w/ Straight Bendable Spark Plug Boot	10116
1967-1964	8 Cyl. 5.3L; 8.5mm High Performance Wire; w/ Straight Non-Bendable Spark Plug Boot	10006
1967-1964	8 Cyl. 5.3L; 8.5mm High Performance Wire; Equipped with Ceramic Spark Plug Boots	10114
1967-1964	8 Cyl. 5.3L; 8.5mm High Performance Wire; w/ Straight Bendable Spark Plug Boot	10116
1964	8 Cyl. 6.4L; 8.5mm High Performance Wire; Equipped with Ceramic Spark Plug Boots	10114
1964	8 Cyl. 6.4L; 8.5mm High Performance Wire; w/ Straight Non-Bendable Spark Plug Boot	10006
1964	8 Cyl. 6.4L; 8.5mm High Performance Wire; w/ Straight Bendable Spark Plug Boot	10116
1963	8 Cyl. 5.3L; 8.5mm High Performance Wire	10008
1963	8 Cyl. 5.3L; 8.5mm High Performance Wire; Equipped with Ceramic Spark Plug Boots	10059
1963-1961	8 Cyl. 6.4L; 8.5mm High Performance Wire	10008
1963-1961	8 Cyl. 6.4L; 8.5mm High Performance Wire; Equipped with Ceramic Spark Plug Boots	10059
1962-1961	8 Cyl. 3.5L; 8.5mm High Performance Wire; w/ Straight Non-Bendable Spark Plug Boot	10009
1962-1961	8 Cyl. 3.5L; 8.5mm High Performance Wire; Equipped with Ceramic Spark Plug Boots	10052

Wire Sets

Year	Model/Engine	Part No.
Spark Plug Wire Set		
Tempest		
1962-1961	8 Cyl. 3.5L; 8.5mm High Performance Wire; w/ Straight Bendable Spark Plug Boot	10117
Ventura		
1977	8 Cyl. 5.0L; 8.5mm High Performance Wire; Equipped with Ceramic Spark Plug Boots	10053
1977	8 Cyl. 5.0L; 8.5mm High Performance Wire	10002
1977	8 Cyl. 5.0L; 9.0mm High Performance Wire	10034
1977	8 Cyl. 5.7L; L; 8.5mm High Performance Wire; Equipped with Ceramic Spark Plug Boots	10053
1977	8 Cyl. 5.7L; L; 9.0mm High Performance Wire	10034
1977	8 Cyl. 5.7L; L; 8.5mm High Performance Wire	10002
1974-1973	8 Cyl. 5.7L; 8.5mm High Performance Wire; Equipped with Ceramic Spark Plug Boots	10114
1974-1973	8 Cyl. 5.7L; 8.5mm High Performance Wire; w/ Straight Non-Bendable Spark Plug Boot	10006
1974-1973	8 Cyl. 5.7L; 8.5mm High Performance Wire; w/ Straight Bendable Spark Plug Boot	10116
1973-1971	8 Cyl. 5.0L; 8.5mm High Performance Wire; Equipped with Ceramic Spark Plug Boots; Routed Over Valve Cover	10079
1973-1971	8 Cyl. 5.0L; 8.5mm High Performance Wire; Routed Over Valve Cover	10007
1961	8 Cyl. 6.4L; 8.5mm High Performance Wire	10008
1961	8 Cyl. 6.4L; 8.5mm High Performance Wire; Equipped with Ceramic Spark Plug Boots	10059
1960	8 Cyl. 6.4L; 8.5mm High Performance Wire; Equipped with Ceramic Spark Plug Boots	10114
1960	8 Cyl. 6.4L; 8.5mm High Performance Wire; w/ Straight Non-Bendable Spark Plug Boot	10006
1960	8 Cyl. 6.4L; 8.5mm High Performance Wire; w/ Straight Bendable Spark Plug Boot	10116
Saab		
Wire Sets		
Spark Plug Wire Set		
9-7x		
2009	8 Cyl. 5.3L; 9.0mm High Performance Wire	10039
2009	8 Cyl. 5.3L; 8.5mm High Performance Wire	10026
2009	8 Cyl. 6.0L; 9.0mm High Performance Wire	10039
2009	8 Cyl. 6.0L; 8.5mm High Performance Wire	10026
2008	8 Cyl. 5.3L; 9.0mm High Performance Wire	10042
2008	8 Cyl. 5.3L; 8.5mm High Performance Wire	10041
2007-2006	8 Cyl. 5.3L; 9.0mm High Performance Wire	10042
2007-2006	8 Cyl. 5.3L; 8.5mm High Performance Wire	10041
2005	8 Cyl. 5.3L; 9.0mm High Performance Wire	10042

Year	Model/Engine	Part No.
Spark Plug Wire Set		
9-7x		
2005	8 Cyl. 5.3L; 8.5mm High Performance Wire	10041
Studebaker		
Wire Sets		
Spark Plug Wire Set		
Avanti		
1964-1963	8 Cyl. 4.7L; 8.5mm High Performance Wire; Equipped with Ceramic Spark Plug Boots	10059
1964-1963	8 Cyl. 4.7L; 8.5mm High Performance Wire	10008
Challenger		
1964	8 Cyl. 4.2L; 8.5mm High Performance Wire	10008
1964	8 Cyl. 4.2L; 8.5mm High Performance Wire; Equipped with Ceramic Spark Plug Boots	10059
Champ		
1964-1960	8 Cyl. 4.8L; 8.5mm High Performance Wire	10008
1964-1960	8 Cyl. 4.8L; 8.5mm High Performance Wire; Equipped with Ceramic Spark Plug Boots	10059
1964-1960	8 Cyl. 4.2L; 8.5mm High Performance Wire; Equipped with Ceramic Spark Plug Boots	10059
1964-1960	8 Cyl. 4.2L; 8.5mm High Performance Wire	10008
Commander		
1964	8 Cyl. 4.2L; 8.5mm High Performance Wire	10008
1964	8 Cyl. 4.7L; 8.5mm High Performance Wire	10008
1964	8 Cyl. 4.2L; 8.5mm High Performance Wire; Equipped with Ceramic Spark Plug Boots	10059
1964	8 Cyl. 4.7L; 8.5mm High Performance Wire; Equipped with Ceramic Spark Plug Boots	10059
1958-1956	8 Cyl. 4.2L; 8.5mm High Performance Wire	10008
1958-1956	8 Cyl. 4.2L; 8.5mm High Performance Wire; Equipped with Ceramic Spark Plug Boots	10059
1955	8 Cyl. 3.7L; 8.5mm High Performance Wire; Equipped with Ceramic Spark Plug Boots	10059
1955	8 Cyl. 3.7L; 8.5mm High Performance Wire	10008
Cruiser		
1964	8 Cyl. 4.2L; 8.5mm High Performance Wire; Equipped with Ceramic Spark Plug Boots	10059
1964	8 Cyl. 4.2L; 8.5mm High Performance Wire	10008
1964-1963	8 Cyl. 4.7L; 8.5mm High Performance Wire; Equipped with Ceramic Spark Plug Boots	10059
1964-1963	8 Cyl. 4.7L; 8.5mm High Performance Wire	10008
Daytona		
1964	8 Cyl. 4.7L; 8.5mm High Performance Wire	10008
1964	8 Cyl. 4.7L; 8.5mm High Performance Wire; Equipped with Ceramic Spark Plug Boots	10059

Wire Sets

Year	Model/Engine	Part No.
Spark Plug Wire Set		
Daytona		
1964	8 Cyl. 4.2L; 8.5mm High Performance Wire; Equipped with Ceramic Spark Plug Boots	10059
1964	8 Cyl. 4.2L; 8.5mm High Performance Wire	10008
Deluxe		
1959	8 Cyl. 4.8L; 8.5mm High Performance Wire	10008
1959	8 Cyl. 4.8L; 8.5mm High Performance Wire; Equipped with Ceramic Spark Plug Boots	10059
E7		
1955	8 Cyl. 3.7L; 8.5mm High Performance Wire	10008
1955	8 Cyl. 3.7L; 8.5mm High Performance Wire; Equipped with Ceramic Spark Plug Boots	10059
E12		
1955	8 Cyl. 3.7L; 8.5mm High Performance Wire	10008
1955	8 Cyl. 3.7L; 8.5mm High Performance Wire; Equipped with Ceramic Spark Plug Boots	10059
Golden Hawk		
1958-1957	8 Cyl. 4.7L; 8.5mm High Performance Wire	10008
1958-1957	8 Cyl. 4.7L; 8.5mm High Performance Wire; Equipped with Ceramic Spark Plug Boots	10059
1956	8 Cyl. 5.8L; 8.5mm High Performance Wire	10008
1956	8 Cyl. 5.8L; 8.5mm High Performance Wire; Equipped with Ceramic Spark Plug Boots	10059
Gran		
1963	8 Cyl. 4.2L; 8.5mm High Performance Wire	10008
1963	8 Cyl. 4.2L; 8.5mm High Performance Wire; Equipped with Ceramic Spark Plug Boots	10059
1963-1962	8 Cyl. 4.7L; 8.5mm High Performance Wire	10008
1963-1962	8 Cyl. 4.7L; 8.5mm High Performance Wire; Equipped with Ceramic Spark Plug Boots	10059
Hawk		
1962-1960	8 Cyl. 4.7L; 8.5mm High Performance Wire; Equipped with Ceramic Spark Plug Boots	10059
1962-1960	8 Cyl. 4.7L; 8.5mm High Performance Wire	10008
1962-1960	8 Cyl. 4.2L; 8.5mm High Performance Wire	10008
1962-1960	8 Cyl. 4.2L; 8.5mm High Performance Wire; Equipped with Ceramic Spark Plug Boots	10059
Lark		
1963	8 Cyl. 4.7L; 8.5mm High Performance Wire; Equipped with Ceramic Spark Plug Boots	10059
1963	8 Cyl. 4.7L; 8.5mm High Performance Wire	10008
1963-1959	8 Cyl. 4.2L; 8.5mm High Performance Wire; Equipped with Ceramic Spark Plug Boots	10059
1963-1959	8 Cyl. 4.2L; 8.5mm High Performance Wire	10008

Year	Model/Engine	Part No.
Spark Plug Wire Set		
Power Hawk		
1956	8 Cyl. 4.2L; 8.5mm High Performance Wire	10008
1956	8 Cyl. 4.2L; 8.5mm High Performance Wire; Equipped with Ceramic Spark Plug Boots	10059
President		
1958-1956	8 Cyl. 4.7L; 8.5mm High Performance Wire	10008
1958-1956	8 Cyl. 4.7L; 8.5mm High Performance Wire; Equipped with Ceramic Spark Plug Boots	10059
1955	8 Cyl. 4.2L; 8.5mm High Performance Wire; Equipped with Ceramic Spark Plug Boots	10059
1955	8 Cyl. 4.2L; 8.5mm High Performance Wire	10008
Scotsman		
1959	8 Cyl. 4.2L; 8.5mm High Performance Wire	10008
1959	8 Cyl. 4.2L; 8.5mm High Performance Wire; Equipped with Ceramic Spark Plug Boots	10059
Silver Hawk		
1959-1957	8 Cyl. 4.2L; 8.5mm High Performance Wire; Equipped with Ceramic Spark Plug Boots	10059
1959-1957	8 Cyl. 4.2L; 8.5mm High Performance Wire	10008
1958-1957	8 Cyl. 4.7L; 8.5mm High Performance Wire	10008
1958-1957	8 Cyl. 4.7L; 8.5mm High Performance Wire; Equipped with Ceramic Spark Plug Boots	10059
Sky Hawk		
1956	8 Cyl. 4.7L; 8.5mm High Performance Wire	10008
1956	8 Cyl. 4.7L; 8.5mm High Performance Wire; Equipped with Ceramic Spark Plug Boots	10059
Transtar		
1958-1957	8 Cyl. 4.2L; 8.5mm High Performance Wire	10008
1958-1957	8 Cyl. 4.2L; 8.5mm High Performance Wire; Equipped with Ceramic Spark Plug Boots	10059
1956	8 Cyl. 3.7L; 8.5mm High Performance Wire	10008
1956	8 Cyl. 3.7L; 8.5mm High Performance Wire; Equipped with Ceramic Spark Plug Boots	10059
Toyota		
Wire Sets		
Spark Plug Wire Set		
4Runner		
1992-1984	4 Cyl. 2.4L; 8.5mm High Performance Wire; Equipped with Ceramic Spark Plug Boots	10061
1992-1984	4 Cyl. 2.4L; 8.5mm High Performance Wire	10060
Celica		
1985-1981	4 Cyl. 2.4L; 8.5mm High Performance Wire	10060
1985-1981	4 Cyl. 2.4L; 8.5mm High Performance Wire; Equipped with Ceramic Spark Plug Boots	10061

Wire Sets

Year	Model/Engine	Part No.
Spark Plug Wire Set		
Celica		
1980	4 Cyl. 2.2L; 8.5mm High Performance Wire; Equipped with Ceramic Spark Plug Boots	10061
1980	4 Cyl. 2.2L; 8.5mm High Performance Wire	10060
Corona		
1982-1981	4 Cyl. 2.4L; 8.5mm High Performance Wire	10060
1982-1981	4 Cyl. 2.4L; 8.5mm High Performance Wire; Equipped with Ceramic Spark Plug Boots	10061
1980	4 Cyl. 2.2L; 8.5mm High Performance Wire	10060
1980	4 Cyl. 2.2L; 8.5mm High Performance Wire; Equipped with Ceramic Spark Plug Boots	10061
Pickup		
1992-1981	4 Cyl. 2.4L; 8.5mm High Performance Wire	10060
1992-1981	4 Cyl. 2.4L; 8.5mm High Performance Wire; Equipped with Ceramic Spark Plug Boots	10061
1980	4 Cyl. 2.2L; 8.5mm High Performance Wire	10060
1980	4 Cyl. 2.2L; 8.5mm High Performance Wire; Equipped with Ceramic Spark Plug Boots	10061

Part No.	Page	Part No.	Page
10001.....	141	10069.....	144
10002.....	141	10070.....	144
10003.....	141	10071.....	144
10004.....	141	10072.....	144
10005.....	141	10073.....	144
10006.....	141	10074.....	144
10007.....	141	10075.....	144
10008.....	141	10076.....	144
10009.....	141	10077.....	144
10010.....	141	10078.....	145
10011.....	141	10079.....	145
10012.....	141	10080.....	145
10013.....	141	10081.....	145
10014.....	141	10082.....	145
10015.....	141	10083.....	145
10016.....	141	10084.....	145
10017.....	141	10085.....	145
10018.....	141	10086.....	145
10019.....	141	10087.....	145
10020.....	142	10088.....	145
10021.....	142	10089.....	145
10022.....	142	10090.....	145
10023.....	142	10091.....	145
10024.....	142	10092.....	145
10025.....	142	10093.....	145
10026.....	142	10094.....	145
10027.....	142	10095.....	145
10028.....	142	10096.....	145
10029.....	142	10097.....	145
10030.....	142	10098.....	146
10031.....	142	10099.....	146
10032.....	142	10100.....	146
10033.....	142	10101.....	146
10034.....	142	10102.....	146
10035.....	142	10103.....	146
10036.....	142	10104.....	146
10037.....	142	10105.....	146
10038.....	142	10106.....	146
10039.....	142	10107.....	146
10040.....	143	10108.....	146
10041.....	143	10109.....	146
10042.....	143	10110.....	146
10043.....	143	10111.....	146
10044.....	143	10112.....	146
10045.....	143	10113.....	146
10046.....	143	10114.....	146
10047.....	143	10115.....	147
10048.....	143	10116.....	147
10049.....	143	10117.....	147
10050.....	143	10118.....	147
10051.....	143	10119.....	147
10052.....	143	10120.....	147
10053.....	143	10121.....	147
10054.....	143	10122.....	147
10055.....	143	10123.....	147
10056.....	143		
10057.....	143		
10058.....	143		
10059.....	144		
10060.....	144		
10061.....	144		
10062.....	144		
10063.....	144		
10064.....	144		
10065.....	144		
10066.....	144		
10067.....	144		
10068.....	144		



10001
Spark Plug Wire Set

Chevrolet 1986 - 1974
GMC 1986 - 1974
Pontiac..... 1975



10002
Spark Plug Wire Set

Buick..... 1979 - 1977
Chevrolet 1988 - 1974
GMC 1988 - 1974
Oldsmobile..... 1979 - 1977
Pontiac..... 1981 - 1976



10003
Spark Plug Wire Set

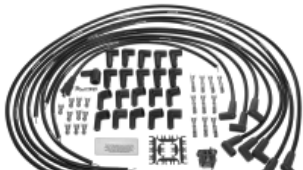

10004
Spark Plug Wire Set



10005
Spark Plug Wire Set

Chevrolet 1974 - 1955
GMC 1970 - 1955



10006
Spark Plug Wire Set

American Motors 1979 - 1968
Buick..... 1974 - 1966
Chevrolet 1974 - 1963
GMC 1974 - 1968
Jeep..... 1991 - 1971
Oldsmobile..... 1974 - 1973
Pontiac..... 1974 - 1955



10007
Spark Plug Wire Set

Chevrolet 1974 - 1964
GMC 1974 - 1970
Pontiac..... 1973 - 1970

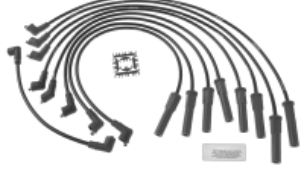

10008
Spark Plug Wire Set

American Motors 1974 - 1960
Buick..... 1967 - 1961
Chevrolet 1965 - 1958
DeTomaso 1974 - 1971
Dodge..... 1959 - 1953
Ford 1977 - 1955
Jeep..... 1974 - 1965
Lincoln 1976 - 1955
Mercury 1976 - 1957
Oldsmobile..... 1973 - 1950
Plymouth..... 1959 - 1957
Pontiac..... 1968 - 1961
Studebaker 1964 - 1955



10009
Spark Plug Wire Set

Buick..... 1966 - 1957
Chrysler..... 1989 - 1979
Dodge 1992 - 1960
Plymouth..... 1989 - 1960
Pontiac..... 1962 - 1961



10010
Spark Plug Wire Set

Buick..... 1986 - 1978
Chevrolet 1986 - 1978
GMC 1986 - 1978
Oldsmobile..... 1986 - 1978
Pontiac..... 1986 - 1978

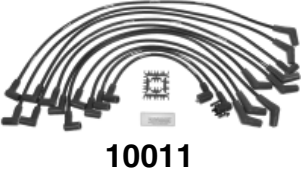

10011
Spark Plug Wire Set

Ford 1992 - 1981
Lincoln 1992 - 1981
Mercury 1991 - 1981



10012
Spark Plug Wire Set



10013
Spark Plug Wire Set



10014
Spark Plug Wire Set

Chevrolet 1995 - 1986
GMC 1995 - 1986
Oldsmobile..... 1994 - 1991

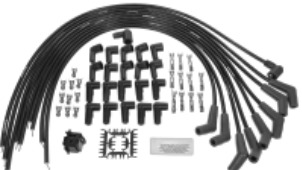

10015
Spark Plug Wire Set



10016
Spark Plug Wire Set

Dodge..... 2003 - 1992
Jeep..... 1998 - 1993

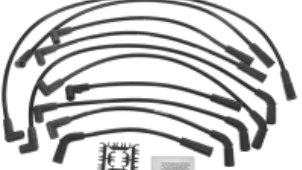

10017
Spark Plug Wire Set

Buick..... 1996 - 1994
Chevrolet 1996 - 1994



10018
Spark Plug Wire Set

AM General 1996 - 1995
Chevrolet 1996 - 1987
GMC 1996 - 1987



10019
Spark Plug Wire Set

Ford 1997 - 1980
Lincoln 1992 - 1984
Mercury 1989 - 1984

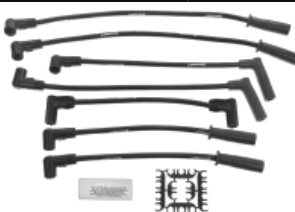

10020
Spark Plug Wire Set

Jeep..... 1999 - 1991

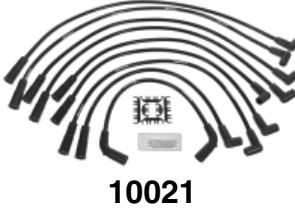

10021
Spark Plug Wire Set

Cadillac..... 2000 - 1999
Chevrolet..... 2000 - 1996
GMC..... 2000 - 1996

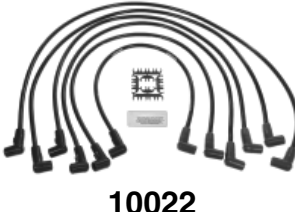

10022
Spark Plug Wire Set

Chevrolet..... 1999 - 1995
Pontiac..... 1999 - 1995

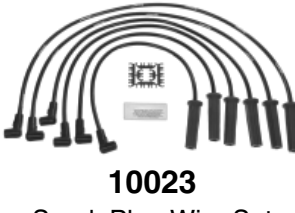

10023
Spark Plug Wire Set

Buick..... 1987 - 1984
Chevrolet..... 2002 - 2000
Pontiac..... 2002 - 2000



10024
Spark Plug Wire Set

Chrysler..... 2000 - 1995
Dodge..... 2000 - 1995
Eagle..... 1998 - 1995
Mitsubishi..... 1999 - 1995
Plymouth..... 2000 - 1995

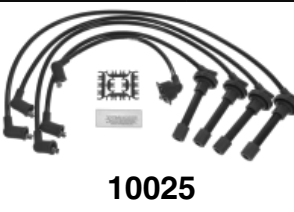

10025
Spark Plug Wire Set

Honda..... 1997 - 1990



10026
Spark Plug Wire Set

Buick..... 2009
Cadillac..... 2014 - 2002
Chevrolet..... 2013 - 1997
GMC..... 2013 - 1999
Hummer..... 2010 - 2003
Pontiac..... 2009 - 1998
Saab..... 2009



10027
Spark Plug Wire Set

Ford..... 1998 - 1996

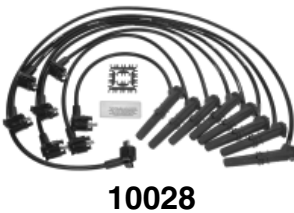

10028
Spark Plug Wire Set

Ford..... 1998 - 1996

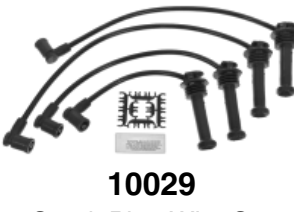

10029
Spark Plug Wire Set

Ford..... 2004 - 1999
Mazda..... 2004 - 2001
Mercury..... 2002 - 1999



10030
Spark Plug Wire Set

Dodge..... 2005 - 2003

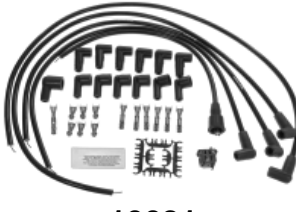

10031
Spark Plug Wire Set

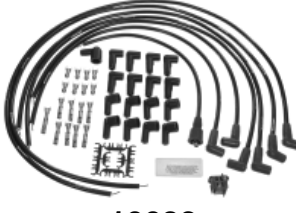

10032
Spark Plug Wire Set

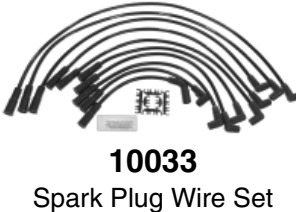

10033
Spark Plug Wire Set

Chevrolet..... 1997 - 1993
Pontiac..... 1997 - 1993



10034
Spark Plug Wire Set

Buick..... 1979 - 1977
Chevrolet..... 1988 - 1974
GMC..... 1988 - 1974
Oldsmobile..... 1979 - 1977
Pontiac..... 1981 - 1976



10035
Spark Plug Wire Set



10036
Spark Plug Wire Set



10037
Spark Plug Wire Set

Buick..... 1986 - 1978
Chevrolet..... 1986 - 1978
GMC..... 1986 - 1978
Oldsmobile..... 1986 - 1978
Pontiac..... 1986 - 1978

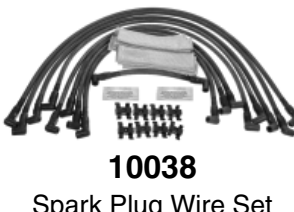

10038
Spark Plug Wire Set

AM General..... 1996 - 1995
Chevrolet..... 1995 - 1987
GMC..... 1995 - 1987



10039
Spark Plug Wire Set

Buick..... 2009
Cadillac..... 2014 - 2002
Chevrolet..... 2013 - 1997
GMC..... 2013 - 1999
Hummer..... 2010 - 2003
Pontiac..... 2009 - 1998

Saab 2009

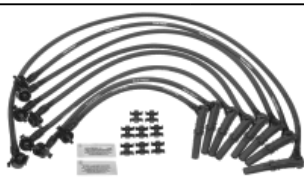

10040
Spark Plug Wire Set

Ford 1998 - 1996



10041
Spark Plug Wire Set

Buick 2008 - 2004
Chevrolet 2008 - 2003
GMC 2008 - 2003
Hummer 2008
Isuzu 2006 - 2003
Pontiac 2008 - 2005
Saab 2008 - 2005



10042
Spark Plug Wire Set

Buick 2008 - 2004
Chevrolet 2008 - 2003
GMC 2008 - 2003
Hummer 2008
Isuzu 2006 - 2003
Pontiac 2008 - 2005
Saab 2008 - 2005

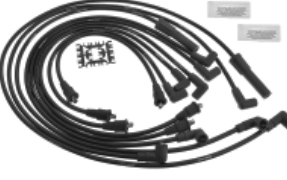

10043
Spark Plug Wire Set

Chrysler 1972 - 1967
Dodge 1972 - 1967
Plymouth 1972 - 1967

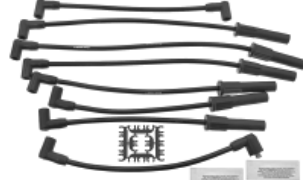

10044
Spark Plug Wire Set

Ford 1996 - 1977

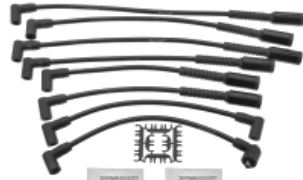

10045
Spark Plug Wire Set

Ford 1996 - 1977



10046
Spark Plug Wire Set

AM General 1996 - 1995
Chevrolet 1996 - 1987
GMC 1996 - 1987

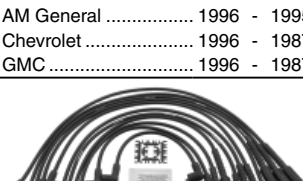

10047
Spark Plug Wire Set

Ford 1992 - 1981
Lincoln 1992 - 1981
Mercury 1991 - 1981



10048
Spark Plug Wire Set

Chevrolet 1991 - 1990
GMC 1991 - 1990

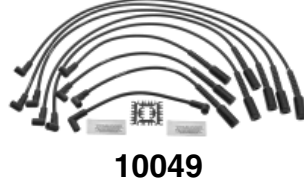

10049
Spark Plug Wire Set

Chevrolet 1991 - 1990
GMC 1991 - 1990



10050
Spark Plug Wire Set

Chevrolet 1997 - 1987
GMC 1997 - 1987



10051
Spark Plug Wire Set

Chevrolet 1997 - 1987
GMC 1997 - 1987



10052
Spark Plug Wire Set

Buick 1966 - 1957
Chrysler 1989 - 1979
Dodge 1992 - 1960
Plymouth 1989 - 1960
Pontiac 1962 - 1961



10053
Spark Plug Wire Set

Buick 1979 - 1977
Chevrolet 1988 - 1974
GMC 1988 - 1974
Oldsmobile 1979 - 1977
Pontiac 1981 - 1976



10054
Spark Plug Wire Set

Ford 1994 - 1989
Mazda 1997 - 1994

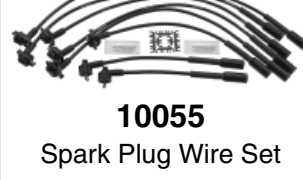

10055
Spark Plug Wire Set

Ford 1994 - 1989
Mazda 1997 - 1994



10056
Spark Plug Wire Set

Buick 1986 - 1978
Chevrolet 1986 - 1978
GMC 1986 - 1978
Oldsmobile 1986 - 1978
Pontiac 1986 - 1978



10057
Spark Plug Wire Set

Buick 1986 - 1984
Cadillac 1986 - 1985
Chevrolet 1993 - 1982
GMC 1993 - 1982
Isuzu 1994 - 1989
Jeep 1986 - 1984
Oldsmobile 1986 - 1984
Pontiac 1989 - 1982



10058
Spark Plug Wire Set

Buick 1986 - 1984
Cadillac 1986 - 1985
Chevrolet 1993 - 1982
GMC 1993 - 1982
Isuzu 1994 - 1989
Jeep 1986 - 1984

Oldsmobile..... 1986 - 1984
Pontiac..... 1989 - 1982



10059

Spark Plug Wire Set

American Motors 1974 - 1960
Buick 1967 - 1961
Chevrolet 1965 - 1958
DeTomaso 1974 - 1971
Dodge 1959 - 1953
Ford 1977 - 1955
Jeep 1974 - 1965
Lincoln 1976 - 1955
Mercury 1976 - 1957
Oldsmobile..... 1973 - 1950
Plymouth..... 1959 - 1957
Pontiac..... 1968 - 1961
Studebaker 1964 - 1955

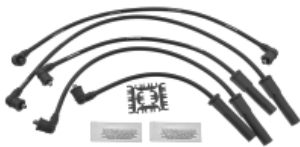

10060

Spark Plug Wire Set

Toyota 1992 - 1980



10061

Spark Plug Wire Set

Toyota 1992 - 1980

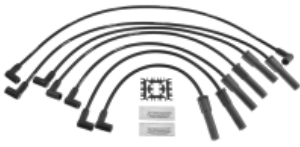

10062

Spark Plug Wire Set

Dodge..... 2003 - 1992



10063

Spark Plug Wire Set

Dodge..... 2003 - 1992



10064

Spark Plug Wire Set

Chevrolet 1998 - 1985
GMC 1990 - 1983



10065

Spark Plug Wire Set

Chevrolet 1998 - 1985
GMC 1990 - 1983

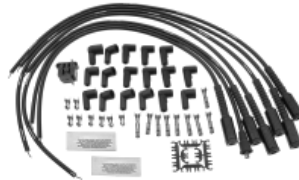

10066

Spark Plug Wire Set

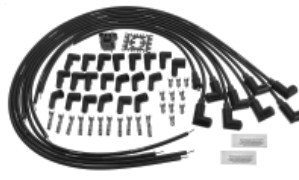

10067

Spark Plug Wire Set

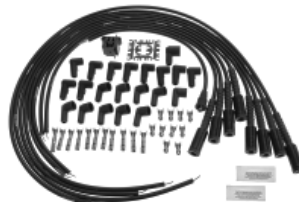

10068

Spark Plug Wire Set



10069

Spark Plug Wire Set

Chevrolet 1986 - 1974
GMC 1986 - 1974
Pontiac..... 1975



10070

Spark Plug Wire Set

Chevrolet 2000 - 1995
GMC 2000 - 1996



10071

Spark Plug Wire Set

Chevrolet 2000 - 1995
GMC 2000 - 1996



10072

Spark Plug Wire Set

Cadillac..... 2000 - 1999
Chevrolet 2000 - 1996
GMC 2000 - 1996



10073

Spark Plug Wire Set

Dodge..... 2003 - 1992
Jeep..... 1998 - 1993



10074

Spark Plug Wire Set

Cadillac..... 2006 - 2002
Chevrolet 2007 - 1998
GMC 2007 - 1998
Hummer..... 2007 - 2003



10075

Spark Plug Wire Set

Cadillac..... 2006 - 2002
Chevrolet 2007 - 1998
GMC 2007 - 1998
Hummer..... 2007 - 2003



10076

Spark Plug Wire Set

Chevrolet 1995 - 1986
GMC 1995 - 1986
Oldsmobile..... 1994 - 1991



10077

Spark Plug Wire Set

Chevrolet 2007 - 1996
GMC 2007 - 1996
Isuzu 2000 - 1997
Oldsmobile..... 2001 - 1996



10078
Spark Plug Wire Set

Chevrolet 2007 - 1996
GMC 2007 - 1996
Isuzu 2000 - 1997
Oldsmobile 2001 - 1996



10083
Spark Plug Wire Set

Ford 1997 - 1980
Lincoln 1992 - 1984
Mercury 1989 - 1984



10088
Spark Plug Boot



10093
8.5 mm Socket Coil Wire



10079
Spark Plug Wire Set

Chevrolet 1974 - 1964
GMC 1974 - 1969
Pontiac 1973 - 1970



10084
Spark Plug Wire Set

Ford 2001 - 1990
Mazda 2000 - 1991



10089
Distributor Boot



10094
9.0 mm Tower Coil Wire

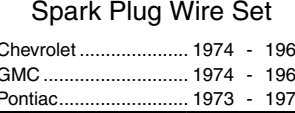

10080
Spark Plug Wire Set

Chevrolet 1974 - 1955
GMC 1970 - 1955



10085
Spark Plug Wire Set

Ford 2001 - 1990
Mazda 2000 - 1991



10090
Distributor Boot



10095
9.0 mm Socket Coil Wire



10081
Spark Plug Wire Set

Ford 1995 - 1983
Mazda 1994



10086
Spark Plug Boot



10091
Distributor Boot



10096
Crimper/Stripper



10082
Spark Plug Wire Set

Ford 1995 - 1983
Mazda 1994



10087
Spark Plug Boot Bendable/Straight



10092
8.5 mm Tower Coil Wire



10097
Single Lead Spark Plug Wire

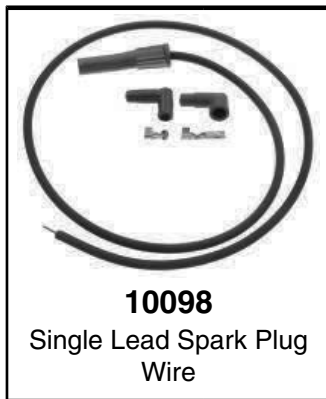

10098
Single Lead Spark Plug Wire

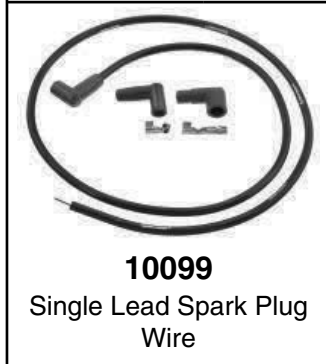

10099
Single Lead Spark Plug Wire

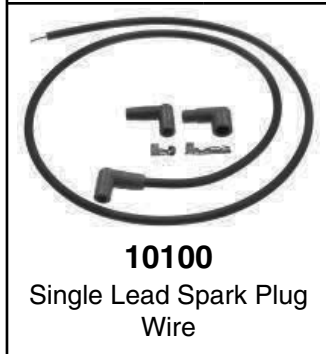

10100
Single Lead Spark Plug Wire



10101
Ignition Wire Separators

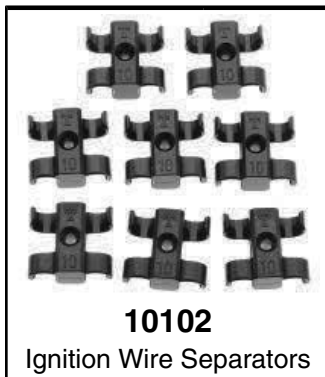

10102
Ignition Wire Separators

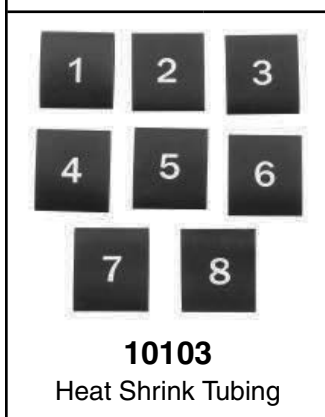

10103
Heat Shrink Tubing



10104
25 ft Wire Loom 400°F

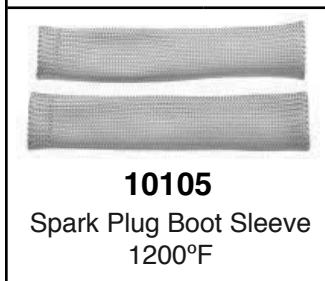

10105
Spark Plug Boot Sleeve
1200°F

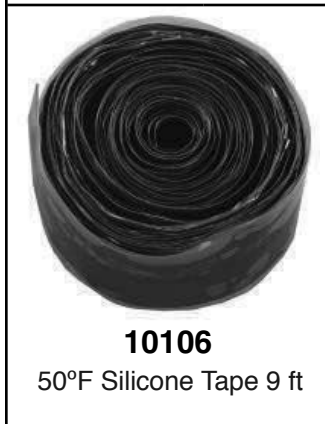

10106
50°F Silicone Tape 9 ft

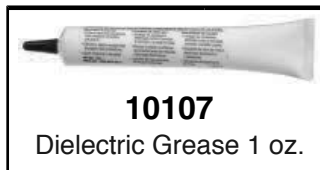

10107
Dielectric Grease 1 oz.



10108
8.5 mm Ignition Wire



10109
9.0 mm Ignition Wire



10110
Distributor Boot



10111
Coil Boot

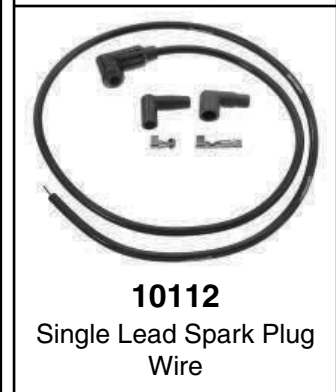

10112
Single Lead Spark Plug Wire

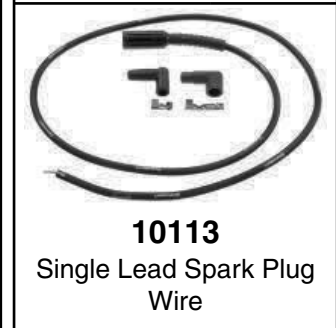

10113
Single Lead Spark Plug Wire



10114
Spark Plug Wire Set

American Motors	1979 - 1968
Buick	1974 - 1966
Chevrolet	1974 - 1963
GMC	1974 - 1968
Jeep	1991 - 1971
Oldsmobile	1974 - 1973
Pontiac	1974 - 1955



10115
Spark Plug Wire Set



10120
Spark Plug Wire Set



10116
Spark Plug Wire Set

American Motors 1979 - 1968
 Buick 1974 - 1966
 Chevrolet 1974 - 1963
 GMC 1974 - 1968
 Jeep 1991 - 1971
 Oldsmobile 1974 - 1973
 Pontiac 1974 - 1955



10121
Spark Plug Wire Set

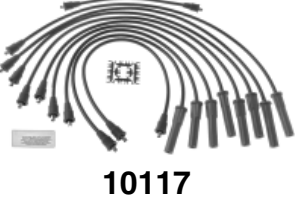

10117
Spark Plug Wire Set

Buick 1966 - 1957
 Chrysler 1989 - 1979
 Dodge 1992 - 1960
 Plymouth 1989 - 1960
 Pontiac 1962 - 1961



10122
Spark Plug Wire Set



10118
Spark Plug Wire Set



10123
Spark Plug Wire Set

Ford 1997 - 1980
 Lincoln 1992 - 1984
 Mercury 1989 - 1984



10119
Spark Plug Wire Set

ENGINE IDENTIFICATION GUIDE

GUIDE D'IDENTIFICATION DE MOTEURS

GUÍA DE IDENTIFICACIÓN DE MOTORES

Cyl	Liter	CID	CC	Year Range	Cyl	Liter	CID	CC	Year Range
AM GENERAL									
L4	2.2	134		69-71	V8	5.3	325		06-09
L6	3.8	232		72-74	V8	5.6	340		66-67
L6	4.2	258		74	V8	5.7	350		68-96
V8	5.7	350		95-96	V8	6.0	364		57-61
V8	6.2	379		92-93	V8	6.6	400		65-75
V8	6.5	395		94-01	V8	6.6	401		59-66
AMERICAN MOTORS									
L4	2.0	121		77-79	V8	6.6	403		77-79
L4	2.5	150		83-84	V8	7.0	425		63-66
L4	2.5	151		80-83	V8	7.0	430		67-69
L6	3.2	196		58-65	V8	7.5	455		70-76
L6	3.3	199		65-70	CADILLAC				
L6	3.8	232		64-79	L4	1.4	85		14-15
L6	4.2	258		71-88	L4	1.8	112		82
V8	4.1	250		58-62	L4	2.0	122		83-15
V8	4.7	287		63-67	L4	2.5	150		13-15
V8	4.7	290		66-69	V6	2.8	170		05-11
V8	4.8	290		68-69	V6	2.8	173		85-88
V8	5.0	304		70-79	V6	3.0	181		97-01
V8	5.1	309		69	V6	3.0	182		10-14
V8	5.3	327		60-66	V6	3.0	183		11-12
V8	5.4	327		58-66	V6	3.2	194		03
V8	5.6	343		67-69	V6	3.2	197		03-04
V8	5.9	360		70-78	V6	3.6	217		04-15
V8	6.4	390		68-70	V6	3.6	220		14
V8	6.6	401		71-76	V6	4.1	252		80-82
BUICK									
L4	1.4	83		13-15	V6	4.3	260		85
L4	1.8	112		76-79; 82-86	V8	4.1	250		82-88
L4	2.0	122		83-15	V8	4.4	267		06-09
L4	2.2	134		93-96	V8	4.5	273		88-92
L4	2.3	138		88-95	V8	4.6	279		07-10
L4	2.4	145		10-15	V8	4.6	281		93-11
L4	2.4	146		96-98	V8	4.9	300		91-95
L4	2.5	151		80-92	V8	5.0	305		91-92
L6	4.1	250		68-75	V8	5.0	307		86-90
L6	4.2	256		04-07	V8	5.3	322		42
V6	2.8	173		80-89	V8	5.3	325		02-05
V6	3.0	181		82-88	V8	5.4	331		49-55
V6	3.0	182		10	V8	5.7	346		42-05
V6	3.1	189		89-05	V8	5.7	350		76-00
V6	3.2	196		78-79	V8	6.0	364		02-13
V6	3.2	198		62-63	V8	6.0	365		56-58
V6	3.3	204		89-93	V8	6.0	368		80-84
V6	3.4	207		02-05	V8	6.2	376		09-15
V6	3.5	213		05-07	V8	6.2	378		07-14
V6	3.6	217		04-15	V8	6.4	390		59-63
V6	3.7	225		64-67	V8	7.0	425		77-79
V6	3.8	231		75-09	V8	7.0	429		64-67
V6	3.9	237		06-11	V8	7.7	472		68-74
V6	4.1	252		80-84	V8	8.2	500		70-76
V6	4.3	260		82-85	CHEVROLET				
L8	4.1	248		42-50	L3	1.0	61		85-00
L8	4.3	263		50-53	L3	2.6	159		65-70
L8	5.2	320		42-52	L4	1.0	61		11-14
V8	3.5	215		61-63	L4	1.2	74		12-14
V8	4.3	260		75-76	L4	1.2	76		13-15
V8	4.3	264		54-55	L4	1.3	79		92-01
V8	4.3	265		80-81	L4	1.4	83		11-15
V8	4.4	267		81-82	L4	1.4	85		76-15
V8	4.6	281		06-11	L4	1.5	92		85-88
V8	4.9	300		64-67	L4	1.6	97		98-12
V8	4.9	301		77-80	L4	1.6	98		76-14
V8	5.0	305		77-91	L4	1.8	110		81-15
V8	5.0	307		80-90	L4	1.8	111		72-82
V8	5.3	322		53-56	L4	1.8	112		82
V8	5.3	323		04-05	L4	1.9	119		82-85
					L4	2.0	119		14-15
					L4	2.0	122		75-15
					L4	2.2	132		03-05

ENGINE IDENTIFICATION GUIDE (CONT'D)

Cyl	Liter	CID	CC	Year Range	Cyl	Liter	CID	CC	Year Range
CHEVROLET (CONT'D)									
L4	2.2	133		93	V8	5.3	322		56-59
L4	2.2	134		81-11	V8	5.3	323		99-14
L4	2.3	138		95-97	V8	5.3	324		55-56
L4	2.3	140		71-94	V8	5.3	325		03-15
L4	2.4	145		06-15	V8	5.3	327		62-69
L4	2.4	146		95-02	V8	5.4	327		64-69
L4	2.4	147		08-14	V8	5.7	348		58-65
L4	2.5	151		78-93	V8	5.7	350		67-04
L4	2.5	152		14	V8	6.0	364		99-15
L4	2.5	153		62-15	V8	6.0	366		80-12
L4	2.8	169		04-06	V8	6.2	376		08-15
L4	2.9	178		07-12	V8	6.2	378		08-14
L4	3.9	236		95-98	V8	6.2	379		82-93
L4	3.9	239		90-91	V8	6.5	395		92-02
L4	4.8	290		99-04	V8	6.5	396		65-70
L4	5.2	317		05-10	V8	6.6	400		70-15
L5	3.5	211		04-06	V8	6.6	402		70-72
L5	3.7	223		07-12	V8	6.6	403		03-09
H6	2.3	140		60-61	V8	6.7	409		61-65
H6	2.4	145		61-63	V8	7.0	427		63-15
H6	2.7	164		64-69	V8	7.4	454		70-00
L6	2.5		2492	04-06	V8	8.1	496		01-09
L6	3.2	194		62-67	V8	8.2	501		80-91
L6	3.5	217		42-53	V8	9.1	555		80-82
L6	3.8	230		63-70	V8	10.4	636		80-90
L6	3.8	235		42-63	CHRYSLER				
L6	3.9	235		55-62	L4	2.0	122		95-02
L6	3.9	236		50-60	L4	2.2	135		82-93
L6	4.1	250		65-98	L4	2.4		2351	01-05
L6	4.2	256		02-09	L4	2.4	144		07-15
L6	4.3	261		54-62	L4	2.4	146		95
L6	4.8	292		63-90	L4	2.4	148		95-10
L6	6.1	374		82-85	L4	2.5	153		86-94
L6	6.6	403		90-98	L4	2.6	156		82-89
L6	7.2	441		98-09	L6	3.7	225		78-83
L6	7.8	475		99-09	L6	4.1	250		50-52
V6	2.5		2500	01-04	L6	4.1	251		42-52
V6	2.8	170		06-08	L6	4.3	265		52-54
V6	2.8	173		80-93	V6	2.5	152		95-00
V6	3.0	182		10-12	V6	2.7	167		98-10
V6	3.0	183		11-14	V6	3.0	181		88-05
V6	3.1	189		90-03	V6	3.2	195		04-08
V6	3.1	191		97-03	V6	3.2	197		98-01
V6	3.2	194		03	V6	3.3	201		90-10
V6	3.2	196		78-79	V6	3.5	215		93-10
V6	3.3	200		78-79	V6	3.6	220		11-15
V6	3.4	204		97-01	V6	3.8	230		91-08
V6	3.4	207		91-09	V6	3.8	231		09-10
V6	3.4	209		05-08	V6	4.0	241		07-10
V6	3.5	213		04-11	L8	5.3	324		42-50
V6	3.5	214		05-06	V8	4.7	285		07-09
V6	3.6	217		08-15	V8	4.9	301		55
V6	3.6	220		10-12	V8	5.2	318		75-89
V6	3.8	229		80-84	V8	5.3	324		50
V6	3.8	231		78-05	V8	5.4	331		51-56
V6	3.8	232		95-96	V8	5.7	345		05-14
V6	3.9	237		06-11	V8	5.8	353		56
V6	4.2	254		02	V8	5.8	354		56-58
V6	4.3	260		82-85	V8	5.9	360		71-80
V6	4.3	262		85-15	V8	5.9	361		61-64
V8	4.3	262		75-76	V8	6.1	370		05-10
V8	4.3	265		55-96	V8	6.3	383		59-71
V8	4.4	267		79-82	V8	6.4	392		57-14
V8	4.6	283		57-67	V8	6.6	400		72-78
V8	4.8	293		11-13	V8	6.7	413		59-65
V8	4.8	294		99-15	V8	6.8	413		59-65
V8	4.9	302		67-69	V8	7.0	426		63
V8	5.0	305		76-02	V8	7.2	440		66-78
V8	5.0	307		68-90					

ENGINE IDENTIFICATION GUIDE (CONT'D)

Cyl	Liter	CID	CC	Year Range	Cyl	Liter	CID	CC	Year Range
DETOMASO									
V8	5.8	351		71-74	V8	5.6	340		68-73
DODGE									
L4	1.0	61		01-04	V8	5.7	345		02-15
L4	1.1	66		05-14	V8	5.7	348		09-10
L4	1.4	83		13-14	V8	5.7	350		58
L4	1.4	85		12-14	V8	5.8	353		55-56
L4	1.4		1410	79-84	V8	5.8	354		55-59
L4	1.5	90		85-95	V8	5.9	360		68-03
L4	1.6	97		83-14	V8	5.9	361		58-71
L4	1.6	98		71-10	V8	6.1	370		06-10
L4	1.7	105		78-83	V8	6.3	383		59-71
L4	1.8	107		89-90	V8	6.4	392		11-15
L4	1.8	110		07-09	V8	6.6	400		71-78
L4	1.8	112		92-94	V8	6.7	413		60-71
L4	2.0	122		74-14	V8	6.8	413		61-65
L4	2.2	135		81-94	V8	7.0	426		63-71
L4	2.3	143		83-85	V8	7.2	440		66-79
L4	2.4		2351	90-94; 01-05; 08	V10	8.0	488		92-03
L4	2.4	144		07-14	V10	8.3	505		03-06
L4	2.4	148		95-07	V10	8.4	512		08
L4	2.5	151		06-13	V10	8.4	515		08-10
L4	2.5	153		86-02	EAGLE				
L4	2.6	156		78-89	L4	1.5		1468	88
L5	2.7	165		03-06	L4	1.5	90		89-96
L6	2.8	170		60-71	L4	1.6	98		89-90
L6	3.2	198		70-74	L4	1.8	107		93-94
L6	3.6	218		42-56	L4	1.8	112		92-96
L6	3.7	225		60-87	L4	2.0	122		89-98
L6	3.7	228		48-56	L4	2.2	132		88-89
L6	3.8	230		42-60	L4	2.4		2351	92-96
L6	3.9	237		42-53	L4	2.5	150		88-89
L6	4.0	243		78-80	V6	3.0	182		88-92
L6	4.1	250		68	V6	3.3	201		93-97
L6	4.1	251		48-68	V6	3.5	215		93-97
L6	4.3	265		54-60	FORD				
L6	5.9	359		89-10	L3	1.0	61		14-15
L6	6.7	408		07-10	L4	1.0	61		59-68
V6	2.5	152		95-00	L4	1.2	72		46-61
V6	2.7	167		98-10	L4	1.2	73		62-67
V6	3.0		2987	07-09	L4	1.3	79		88-00
V6	3.0	181		87-05	L4	1.3	82		62-64
V6	3.0	182		90-92	L4	1.5	91		55-15
V6	3.2	197		98-01	L4	1.5	92		51-67
V6	3.3	201		90-10	L4	1.6	95		65-66
V6	3.5	215		93-10	L4	1.6	97		01-15
V6	3.6	220		11-15	L4	1.6	98		67-15
V6	3.7	226		02-12	L4	1.7	104		56-62
V6	3.8	230		94-08	L4	1.8	110		72-79
V6	3.8	231		09-10	L4	1.8	112		91-96
V6	3.9	238		97-99	L4	1.9	113		95-96
V6	3.9	239		87-03	L4	1.9	116		85-96
V6	4.0	241		07-11	L4	2.0	120		42
V8	3.9	239		53-54	L4	2.0	121		95-13
V8	4.0	241		53-56	L4	2.0	122		71-15
V8	4.3	259		55-56	L4	2.2	133		89-92
V8	4.4	270		55-56	L4	2.2	134		83-14
V8	4.5	273		64-69	L4	2.3	138		01-10
V8	4.7	285		98-10	L4	2.3	140		74-15
V8	4.7	287		00-04	L4	2.5	152		09-15
V8	5.0	303		57	L4	2.5	153		86-14
V8	5.1	313		57-64	L4	3.6	220		63-66
V8	5.1	314		58	L4	4.0	242		67-70
V8	5.1	315		56-59	L4	4.2	254		71-72
V8	5.2	318		59-03	L5	2.5	153		10
V8	5.3	325		57-59	L5	2.5	154		10-11
V8	5.3	326		59	L5	3.2	195		15
V8	5.4	331		54-56	L6	2.3	138		52-56
					L6	2.4	144		60-66
					L6	2.6	156		56-64

ENGINE IDENTIFICATION GUIDE (CONT'D)

Cyl	Liter	CID	CC	Year Range	Cyl	Liter	CID	CC	Year Range
FORD (CONT'D)									
L6	2.8	170		60-72	V8	6.6	406		62-63
L6	3.3	200		63-83	V8	6.7	406		62-15
L6	3.5	215		51-53	V8	6.7	409		11-14
L6	3.6	223		54-64	V8	6.7	410		62-74
L6	3.7	223		57-64	V8	6.9	420		83-87
L6	3.7	226		42-52	V8	7.0	427		63-69
L6	3.9	240		65-76	V8	7.0	428		65-70
L6	4.1	250		69-80	V8	7.0	429		68-98
L6	4.3	262		61-64	V8	7.0	430		59-60
L6	4.9	300		65-97	V8	7.3	444		00-03
L6	5.9	359		93-08	V8	7.3	445		88-03
L6	6.6	401		86-93	V8	7.5	460		72-97
L6	6.7	408		08-13	V8	8.2	501		80-87
L6	7.2	441		00-10	V8	10.4	636		80-89
L6	7.8	473		86-93	V10	6.8	412		10-14
L6	8.3	504		92-98	V10	6.8	415		97-15
V6	2.5	152		93-97	GMC				
V6	2.5	153		95-96	L3	2.6	159		67-69
V6	2.5	155		95-07	L4	1.6	98		89-91
V6	2.7	164		15	L4	1.9	119		82-85
V6	2.8	171		74-86	L4	2.0	122		83-84
V6	2.9	177		86-92	L4	2.2	134		84-03
V6	3.0	181		11-12	L4	2.4	145		10-15
V6	3.0	182		86-08	L4	2.5	151		85-93
V6	3.0	183		96-12	L4	2.5	153		63-15
V6	3.2	195		93-95	L4	2.8	169		04-06
V6	3.5	213		07-15	L4	2.9	178		07-12
V6	3.5	214		11-12	L4	3.9	236		95-98
V6	3.7	226		11-12	L4	3.9	239		89-91
V6	3.7	227		11-15	L4	4.8	290		99-04
V6	3.7	228		11-14	L4	5.2	317		05-10
V6	3.8	232		82-04	L5	3.5	211		04-06
V6	3.9	238		04-07	L5	3.7	223		07-12
V6	4.0	245		90-11	L6	3.2	194		63-66
V6	4.2	256		97-10	L6	3.7	228		42-53
V6	4.5	275		06-10	L6	3.8	230		63-69
V8	3.4	207		96-99	L6	3.8	235		60-62
V8	3.6	221		42-63	L6	4.1	248		53-55
V8	3.7	225		53	L6	4.1	250		66-84
V8	3.9	239		42-68	L6	4.2	256		02-09
V8	3.9	242		02-05	L6	4.3	261		61-62
V8	4.2	255		48-82	L6	4.4	270		56-62
V8	4.2	256		54-55	L6	4.8	292		63-90
V8	4.3	260		62-65	L6	6.1	374		82-85
V8	4.4	272		55-58	L6	6.6	403		90-98
V8	4.5	272		57	L6	7.2	441		98-09
V8	4.6	281		92-14	L6	7.8	475		99-09
V8	4.7	289		63-69	V6	2.8	173		82-93
V8	4.8	292		55-65	V6	3.0	182		10-12
V8	5.0	302		68-15	V6	3.0	183		11-12
V8	5.0	305		11-12	V6	3.3	200		78-79
V8	5.1	312		56-57	V6	3.6	217		07-15
V8	5.4	330		75-14	V6	3.6	220		13-14
V8	5.4	332		58-63	V6	3.8	229		80-84
V8	5.8	351		69-97	V6	3.8	231		78-84
V8	5.8	352		57-67	V6	4.3	262		85-15
V8	5.8	354		13-14	V6	5.0	305		60-69
V8	5.8	355		13-14	V6	5.7	351		65-68
V8	5.9	360		64-77	V8	4.4	267		79-82
V8	5.9	361		58-66	V8	4.6	283		60-67
V8	6.0	363		03-10	V8	4.7	288		55
V8	6.0	365		04-08	V8	4.8	294		99-15
V8	6.1	370		80-91	V8	5.0	305		76-02
V8	6.2	378		11-14	V8	5.0	307		68-73
V8	6.2	379		10-15	V8	5.2	316		55-56
V8	6.2	380		11-14	V8	5.2	317		56
V8	6.4	390		61-77	V8	5.3	322		56-59
V8	6.4	391		08-10	V8	5.3	323		99-05
V8	6.6	400		71-82	V8	5.3	324		55-56

ENGINE IDENTIFICATION GUIDE (CONT'D)

Cyl	Liter	CID	CC	Year Range	Cyl	Liter	CID	CC	Year Range
GMC (CONT'D)									
V8	5.3	325		05-15	V6	3.5		3471	05-14
V8	5.3	327		67-68	V6	3.5		3474	99-04
V8	5.4	327		67-68	V6	3.5		3475	03-04
V8	5.5	336		58-59	HUMMER				
V8	5.5	337		58-59	L5	3.5	211		06
V8	5.7	347		57	L5	3.7	223		07-10
V8	5.7	350		69-03	V8	5.3	325		08-10
V8	6.0	364		99-15	V8	6.0	364		03-07
V8	6.0	366		80-98	V8	6.2	376		09
V8	6.1	370		57-59	V8	6.2	378		08
V8	6.2	376		09-15	V8	6.5	395		02-04
V8	6.2	378		07-10	V8	6.6	400		06
V8	6.2	379		82-93	ISUZU				
V8	6.5	395		92-02	L4	1.5		1471	85-89
V8	6.5	396		68-69	L4	1.6		1588	89-93
V8	6.6	400		71-15	L4	1.8		1817	81-92
V8	6.6	402		70-75	L4	1.9		1949	83-87
V8	6.6	403		03-09	L4	2.0		1991	61-66
V8	7.0	427		80-98	L4	2.0		1994	85-89
V8	7.4	454		70-00	L4	2.2		2156	96-97
V8	7.5	455		73-74	L4	2.2		2180	96-03
V8	8.1	496		01-09	L4	2.2		2238	81-87
V8	8.2	501		80-91	L4	2.3		2234	99
V8	9.1	555		80-82	L4	2.3		2254	86-98
V8	10.4	636		80-90	L4	2.6		2559	88-97
HONDA					L4	2.8		2770	06
L2	0.6	598		69-72	L4	2.9		2921	07-08
L3	1.0	995		00-06	L4	3.0	183		11-13
L4	1.2	1169		73	L4	3.9	236		86-98
L4	1.2	1237		73-79	L4	4.8	290		98-04
L4	1.2	1238	74		L4	5.2	317		05-13
L4	1.3	1335		80-83	L5	3.5		3460	06
L4	1.3	1339		03-14	L5	3.7		3654	07-08
L4	1.3	1342		84-87	L6	4.2	256		03-08
L4	1.5	1487		75-87	L6	5.8	353		85-91
L4	1.5	1491		87	L6	6.5	396		87-94
L4	1.5	1493		86-95	L6	7.1	435		95-98
L4	1.5	1496		10-14	L6	7.8	475		98-11
L4	1.5	1497		07-14	L6	8.4	513		87-93
L4	1.6	1590		88-00	V6	2.8		2827	89-91
L4	1.6	1595		96-00	V6	3.1		3137	91-94
L4	1.6	1598	85		V6	3.2		3165	92-04
L4	1.6	1599		76-78	V6	3.5		3475	98-02
L4	1.7	1668		01-05	V6	3.5		3491	03
L4	1.7	1700		02-04	V6	3.5		3494	04
L4	1.8	1751		79-83	V6	4.3	262		00
L4	1.8	1799		06-14	V6	4.3		4294	97-99
L4	1.8	1829		83-87	V8	5.3	323		03-06
L4	2.0	1955		85-89	V8	5.7	350		92-02
L4	2.0	1958		88-91	V8	6.0		5967	03-12
L4	2.0	1972		97-01	JEEP				
L4	2.0	1993		14	L4	2.0	122		07-14
L4	2.0	1997		00-03	L4	2.1	126		85-87
L4	2.0	1998		02-11	L4	2.2	134		42-73
L4	2.1	2056		90-91	L4	2.4	144		07-15
L4	2.2	2156		90-01	L4	2.4	148		02-06
L4	2.2	2157		04-09	L4	2.5	150		83-02
L4	2.3	2234	98		L4	2.5	151		80-83
L4	2.3	2254		98-02	L4	2.8	171		05-06
L4	2.3	2259		92-96	L4	3.1	192		68
L4	2.4	2354		02-14	L4	3.2	192		63-68
L4	2.4	2356		13-14	L6	2.4	148		47-51
L4	2.4	2400		12-14	L6	2.6	161		50-54
L4	2.6	2559		94-96	L6	3.7	225		55-66
V6	2.7	2675		95-97	L6	3.7	226		47-66
V6	3.0	2977		03-05	L6	3.8	230		62-67
V6	3.0	2997		98-07	L6	3.8	232		64-78
V6	3.2	3165		94-02					

ENGINE IDENTIFICATION GUIDE (CONT'D)

Cyl	Liter	CID	CC	Year Range	Cyl	Liter	CID	CC	Year Range
JEEP (CONT'D)									
L6	4.0	241		03-06	L4	1.8		1796	70-78
L6	4.0	242		87-06	L4	1.8		1839	90-05
L6	4.2	258		71-90	L4	2.0		1970	79-84
V6	2.8	173		84-86	L4	2.0		1991	93-04
V6	3.0	182		07-14	L4	2.0		1998	84-15
V6	3.2	195		14	L4	2.0		1999	06-14
V6	3.2	198		14-15	L4	2.0		2000	01-14
V6	3.6	220		11-14	L4	2.2		2184	87-93
V6	3.7	225		66-71	L4	2.2		2209	82-84
V6	3.7	226		02-13	L4	2.3		2260	03-13
V6	3.8	231		07-11	L4	2.3		2261	10
V8	4.7	285		02-10	L4	2.3		2294	01
V8	4.7	287		99-01	L4	2.3		2295	94-97
V8	5.0	304		71-81	L4	2.3		2300	02-10
V8	5.2	317		95	L4	2.5		2488	09-15
V8	5.2	318		93-98	L4	2.5		2489	10-14
V8	5.3	327		65-70	L4	2.5		2492	98-01
V8	5.4	327		68	L4	2.6		2555	87-88
V8	5.7	345		05-14	L4	2.6		2606	89-94
V8	5.7	348		05-06	V6	1.8		1845	92-95
V8	5.7	350		68-71	V6	2.3		2254	95-02
V8	5.9	360		70-98	V6	2.5		2497	93-02
V8	6.1	370		06-10	V6	3.0		2954	88-08
V8	6.4	392		12-14	V6	3.0		2968	03-08
V8	6.6	401		74-78	V6	3.0	183	2983	94-97
LINCOLN					V6	3.0			99-11
L4	2.0	122		13-15	V6	3.5		3496	07
L4	2.3	140		15	V6	3.7		3726	08-14
L4	2.5	152		11-12	V6	4.0		4016	91-10
L6	2.4	146		84-85	MERCURY				
V6	3.0	182		00-05	L4	1.6	98		70-94
V6	3.0	183		06	L4	1.8	112		91-96
V6	3.5	213		07-15	L4	1.9	116		85-96
V6	3.7	226		13-14	L4	2.0	121		95-02
V6	3.7	227		09-14	L4	2.0	122		71-87
V6	3.7	228		11	L4	2.3	140		75-09
V6	3.8	232		82-94	L4	2.5	152		09-11
V8	3.9	242		00-06	L4	2.5	153		86
V8	4.6	281		91-11	L6	2.4	144		60-63
V8	5.0	302		77-92	L6	2.8	170		61-72
V8	5.0	305		11-14	L6	3.3	200		63-83
V8	5.2	318		52-54	L6	3.6	223		61-62
V8	5.4	330		98-14	L6	3.7	223		61
V8	5.5	337		49-51	L6	4.1	250		69-80
V8	5.6	341		55	V6	2.5	155		95-02
V8	5.8	351		77-80	V6	2.6	156		72-73
V8	6.0	368		56-57	V6	2.8	171		74-79
V8	6.6	400		77-79	V6	3.0	181		10-11
V8	7.0	429		68	V6	3.0	182		86-05
V8	7.0	430		58-65	V6	3.0	183		02-11
V8	7.5	460		68-78	V6	3.3		3275	99-02
V8	7.6	462		66-68	V6	3.5	213		08-09
V12	4.8	292		42-48	V6	3.8	232		82-97
V12	5.0	305		42	V6	4.0	245		98-10
MAZDA					V6	4.2	256		04-07
R2	1.1		1146	70-85	V8	3.6	221		62-63
R2	1.3		1308	74-11	V8	3.7	225		49
L4	1.2		1169	70-72	V8	3.9	239		42-50
L4	1.3		1272	76-78	V8	4.2	255		48-82
L4	1.4		1415	79-80	V8	4.2	256		54
L4	1.5		1489	95-98	V8	4.3	260		62-65
L4	1.5		1490	67-85	V8	4.6	281		92-11
L4	1.5		1498	11-14	V8	4.7	289		63-68
L4	1.6		1586	70-76	V8	4.8	292		55-62
L4	1.6		1587	72-77	V8	5.0	302		68-01
L4	1.6		1589	99-03	V8	5.1	312		56-60
L4	1.6		1597	86-96	V8	5.8	351		69-89
					V8	5.8	352		61-62
					V8	6.0	368		57

ENGINE IDENTIFICATION GUIDE (CONT'D)

Cyl	Liter	CID	CC	Year Range	Cyl	Liter	CID	CC	Year Range
MERCURY (CONT'D)									
V8	6.3	383		58-60	V8	4.9	301		79
V8	6.4	390		61-71	V8	5.0	303		49-53
V8	6.6	400		71-78	V8	5.0	305		77-92
V8	6.6	406		62-63	V8	5.0	307		80-90
V8	6.7	410		66-67	V8	5.3	324		54-56
V8	7.0	427		63-69	V8	5.4	330		64-67
V8	7.0	428		66-70	V8	5.7	350		68-92
V8	7.0	429		69-73	V8	6.1	371		57-60
V8	7.0	430		58-60	V8	6.5	394		59-64
V8	7.5	460		72-78	V8	6.6	400		65-75
MITSUBISHI					V8	6.6	403		77-79
L3	1.2		1193	14	V8	7.0	425		65-67
L4	1.5		1468	85-02	V8	7.5	455		68-76
L4	1.6		1597	85-92	PLYMOUTH				
L4	1.8		1755	90-94	L4	1.4		1410	79-84
L4	1.8		1795	83-88	L4	1.5	90		58-95
L4	1.8		1834	92-04	L4	1.5		1498	71-73
L4	2.0		1997	83-06	L4	1.5	91		71-73
L4	2.0		1998	08-14	L4	1.6	97		83-86
L4	2.0		1999	04-07	L4	1.6	98		76-90
L4	2.0		2000	02-12	L4	1.7	105		78-83
L4	2.3		2346	83-85	L4	1.8	107		89-94
L4	2.4		2351	85-15	L4	1.8	112		92-94
L4	2.4		2360	08-14	L4	2.0	122		76-01
L4	2.4		2378	04-12	L4	2.2	135		81-94
L4	2.4		2400	04-12	L4	2.4		2351	92-94
L4	2.5		2477	10-15	L4	2.4	148		96-00
L4	2.6		2555	83-89	L4	2.5	153		86-95
V6	3.0		2972	88-05	L4	2.6	156		78-87
V6	3.0		2998	07-14	L6	2.8	170		60-71
V6	3.0		3000	12	L6	3.2	198		70-74
V6	3.5		3497	94-11	L6	3.6	218		42-54
V6	3.7	226		06-09	L6	3.7	225		60-83
V6	3.8		3797	03-05	L6	3.8	230		49-59
V6	3.8		3800	04	V6	3.0	181		87-00
V6	3.8		3828	04-14	V6	3.3	201		90-00
V8	4.7	285		06-07	V6	3.5	215		97-01
OLDSMOBILE					V6	3.8	230		94-99
L4	1.8	112		82-86	V6	4.0	245		89
L4	2.0	121		87-88	V8	3.9	239		55
L4	2.0	122		83-88	V8	4.0	241		55
L4	2.2	134		93-04	V8	4.2	259		55
L4	2.3	138		87-95	V8	4.3	260		55
L4	2.3	140		76-94	V8	4.4	270		56
L4	2.4	146		96-01	V8	4.5	273		56-69
L4	2.5	151		78-92	V8	4.5	276		56
L6	3.8	232		50	V8	4.5	277		56-57
L6	3.9	238		42-48	V8	4.9	299		57
L6	4.1	250		66-76	V8	4.9	301		57
L6	4.2	256		02-04	V8	5.0	303		56
L6	4.2	257		46-50	V8	5.1	313		57-58
V6	2.8	173		80-89	V8	5.2	317		57-59
V6	3.0	181		82-88	V8	5.2	318		57-89
V6	3.1	189		89-99	V8	5.6	340		68-73
V6	3.3	204		89-93	V8	5.7	350		58
V6	3.4	207		91-04	V8	5.9	360		71-83
V6	3.5	214		99-02	V8	5.9	361		58-66
V6	3.7	225		64-65	V8	6.3	383		60-71
V6	3.8	231		75-99	V8	6.6	400		72-78
V6	4.1	252		81-84	V8	6.7	413		61-64
V6	4.3	260		82-85	V8	6.8	413		61-62
V6	4.3	262		91-01	V8	7.0	426		63-71
L8	4.2	257		42-48	V8	7.2	440		66-78
V8	3.5	215		61-63	PONTIAC				
V8	4.0	244		95-03	L3	1.0	61		85-00
V8	4.3	260		75-82	L4	1.0	61		04-10
V8	4.4	267		81-82	L4	1.3	79		94-00
					L4	1.4	85		76-77

ENGINE IDENTIFICATION GUIDE (CONT'D)

Cyl	Liter	CID	CC	Year Range	Cyl	Liter	CID	CC	Year Range
PONTIAC (CONT'D)									
L4	1.5	92		85-88	V8	7.4	454		70-71
L4	1.6	98		76-10	V8	7.5	455		70-76
L4	1.8		1795	03-10	SAAB				
L4	1.8	110		81-86	L2	0.8		764	50-55
L4	1.8	112		82-86	L3	0.7		748	56-65
L4	2.0	122		83-09	L3	0.8		795	68
L4	2.2	134		90-10	L3	0.8		841	59-68
L4	2.3	138		88-95	H4	2.0		1994	05
L4	2.3	140		75-94	H4	2.5		2458	05-06
L4	2.4	145		06-10	L4	1.7		1709	69-72
L4	2.4	146		96-10	L4	1.9		1854	71-72
L4	2.5	151		77-91	L4	2.0		1985	72-11
L4	2.5	153		62-70	L4	2.0		1998	01-11
L4	3.2	195		61-63	L4	2.1		2119	91-94
L6	3.2	194		62-67	L4	2.3		2290	90-09
L6	3.5	215		64-65	V4	1.5		1498	67-70
L6	3.8	230		63-70	V4	1.7		1698	70-74
L6	3.9	239		42-54	V4	1.7		1699	69-74
L6	4.1	250		66-79	L6	4.2	256		05-09
L6	4.3	261		55-62	V6	2.5		2498	94-97
V6	2.8	173		80-89	V6	2.8		2792	06-11
V6	3.0	181		85-87	V6	3.0		2961	95-03
V6	3.1	189		88-03	V6	3.0		2962	02
V6	3.1	191		97-98	V6	3.0	182		11
V6	3.3	200		78-79	V8	5.3	325		05-09
V6	3.3	204		92-93	V8	6.0	364		08-09
V6	3.4	204		99-08	STUDEBAKER				
V6	3.4	207		91-09	L6	2.8	170		42-64
V6	3.5	211		05	L6	3.0	186		55-58
V6	3.5	213		05-10	L6	3.2	194		65-66
V6	3.5	214		06	L6	3.7	226		47-48
V6	3.6	217		07-09	L6	3.8	230		66
V6	3.8	229		80-81	L6	4.0	246		49-60
V6	3.8	231		76-08	V8	3.7	224		55-56
V6	3.9	237		06-09	V8	3.8	232		51-54
V6	4.1	252		82	V8	4.2	259		55-64
V6	4.3	260		82-85	V8	4.6	283		65-66
V6	4.3	262		85-87	V8	4.7	289		56-64
L8	4.1	249		42-49	V8	4.8	289		59-64
L8	4.4	268		50-54	V8	5.0	304		63-64
V8	3.5	215		61-62	V8	5.8	352		56
V8	4.3	260		75-76	TOYOTA				
V8	4.3	265		55-81	L4	1.1		1077	68-69
V8	4.4	267		79-82	L4	1.2		1166	69-79
V8	4.6	281		04-05	L4	1.3		1290	81-84
V8	4.6	283		57-67	L4	1.3		1299	04
V8	4.7	287		55	L4	1.5		1452	80-88
V8	4.9	301		77-81	L4	1.5		1453	58-66
V8	5.0	305		76-92	L4	1.5		1456	87-94
V8	5.0	307		68-89	L4	1.5		1495	10-14
V8	5.2	316		56	L4	1.5		1497	92-14
V8	5.3	325		05-08	L4	1.6		1587	83-97
V8	5.3	326		63-67	L4	1.6		1588	71-79
V8	5.3	327		62-69	L4	1.8		1762	93-97
V8	5.7	347		57	L4	1.8		1770	80-82
V8	5.7	348		58-65	L4	1.8		1794	98-14
V8	5.7	350		68-04	L4	1.8		1795	00-06
V8	6.0	364		05-09	L4	1.8		1798	09-15
V8	6.1	370		58	L4	1.8		1800	10-13
V8	6.2	376		09	L4	1.8		1839	84-86
V8	6.4	389		59-66	L4	1.9		1858	69-71
V8	6.5	396		65-69	L4	1.9		1897	61-70
V8	6.6	400		67-79	L4	1.9		1898	66-71
V8	6.6	402		70-71	L4	2.0		1968	72-74
V8	6.6	403		77-79	L4	2.0		1974	86
V8	6.7	409		61-65	L4	2.0		1995	83-86
V8	6.9	421		61-66	L4	2.0		1998	84-03
V8	7.0	427		66-69					
V8	7.0	428		67-69					

ENGINE IDENTIFICATION GUIDE (CONT'D)

Cyl	Liter	CID	CC	Year Range	Cyl	Liter	CID	CC	Year Range
TOYOTA (CONT'D)									
L4	2.2		2164	90-01					
L4	2.2		2188	81-83					
L4	2.2		2189	75-80					
L4	2.2		2237	86-89					
L4	2.4		2357	02-07					
L4	2.4		2362	01-13					
L4	2.4		2366	81-95					
L4	2.4		2400	10-13					
L4	2.4		2438	91-04					
L4	2.4		2446	84-85					
L4	2.4		2466	86-87					
L4	2.5		2494	09-15					
L4	2.5		2500	10-14					
L4	2.7		2672	09-15					
L4	2.7		2692	10-14					
L4	2.7		2694	94-14					
L4	2.7		2700	10-14					
L4	3.4		3431	81-87					
L6	2.0		1988	67-68					
L6	2.3		2253	67-72					
L6	2.6		2563	71-80					
L6	2.8		2754	82-88					
L6	2.8		2759	81-82					
L6	3.0		2954	86-92					
L6	3.0		2997	93-98					
L6	3.9		3878	60-74					
L6	4.0		3956	88-92					
L6	4.2		4227	75-87					
L6	4.2		4228	81-86					
L6	4.5		4477	93-97					
V6	2.5		2508	88-91					
V6	3.0		2959	88-95					
V6	3.0		2995	94-06					
V6	3.3		3300	04-10					
V6	3.4		3378	95-04					
V6	3.5		3456	05-15					
V6	3.5		3500	07-14					
V6	4.0		3956	03-14					
V6	4.0		4000	10-14					
V8	4.6		4600	10-12					
V8	4.6		4608	10-14					
V8	4.7		4663	98-09					
V8	5.7		5663	07-14					

SEMI-CUSTOM WIRE SET SPECIFICATIONS

Part Number	Wire Diam. (mm)	Lead Length (inches) / Plug Boot								Coil Length (inches) / Boot
10003	8.5	32/D	32/D	32/D	32/D	37/D	37/D	45/D	45/D	18/E
10004	8.5	29/A	29/A	37/A	37/A	49/A	49/A	55/A	55/A	18/E
10012	8.5	29/D	29/D	32/D	32/D	37/D	37/D	—	—	32/E
10013	8.5	29/D	37/D	45/D	45/D	—	—	—	—	30/E
10015	8.5	32/C	32/C	34/C	34/C	36/C	36/C	38/C	38/C	36/H
10031	8.5	29/A	29/A	37/A	37/A	—	—	—	—	18/E
10032	8.5	29/A	29/A	37/A	37/A	49/A	49/A	—	—	18/E
10035	9.0	32/B	32/B	37/B	37/B	49/B	49/B	55/B	55/B	18/E
10036	9.0	29/A	29/A	37/A	37/A	49/A	49/A	55/A	55/A	18/E
10066	8.5	29/F	29/F	32/F	32/F	37/F	37/F	—	—	32/E
10067	8.5	29/G	29/G	37/G	37/G	49/G	49/G	55/G	55/G	18/E
10068	8.5	32/F	32/F	37/F	37/F	49/F	49/F	55/F	55/F	18/E
10115	8.5	32/B	32/B	37/B	37/B	49/B	49/B	55/B	55/B	18/E
10118	8.5	29/B	29/B	32/B	32/B	37/B	37/B	—	—	32/E
10119	8.5	29/B	37/B	45/B	45/B	—	—	—	—	30/E
10120	8.5	45/B	45/B	45/B	45/B	45/B	45/B	45/B	45/B	—
10121	9.0	45/B	45/B	45/B	45/B	45/B	45/B	45/B	45/B	—
10122	8.5	37/I	37/I	42/I	42/I	54/I	54/I	72/I	72/I	48/J

The sets listed are unfinished on the distributor/coil end.
 Note: 10120 and 10121 are designed for LS series engines with coil packs.

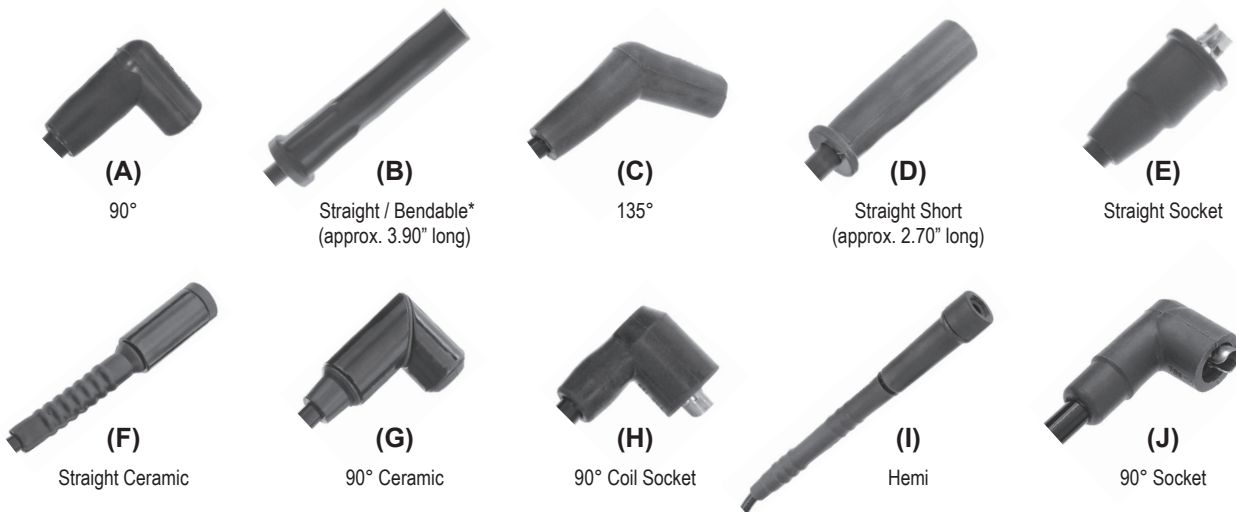

* Repeated bending may result in premature failure and misfire.

BLUE STREAK® HIGH PERFORMANCE WIRE SETS WITH BENDABLE BOOTS

- ✓ The bendable spark plug boots are made from the same high temperature (600 °F+) silicone rubber as the rest of the Blue Streak® line
- ✓ Designed to allow for clearance with custom exhaust systems
- ✓ Terminals are made of high quality stainless steel which resists corrosion and assures continuity
- ✓ Boots are extra thick to resist voltage leaks
- ✓ Designed to bend approximately 1.5" from the plug end of the boot
- ✓ The boots will safely bend to 115-135 degrees and stay in place once bent



MAKING LOTS OF HEAT?

BLUE STREAK® CAN TAKE IT!

Blue Streak® wire sets feature 600 °F spark plugs boots as standard equipment... but sometimes that isn't enough. For those who need it, we have wire sets that feature 600 °F spark plug boots surrounded by a 1500 °F ceramic shell.

- ✓ 27 custom finished sets for hard working cars and trucks
- ✓ 3 semi-custom unfinished sets for everything else
- ✓ 2 semi-custom unfinished single leads

SEMI-CUSTOM UNFINISHED SETS

Part No.	Wire Size	Cyl.	Description
10066	8.5 mm	6	Straight Plug Boots - Wire Set
10067	8.5 mm	8	90 Degree Plug Boots - Wire Set
10068	8.5 mm	8	Straight Plug Boots - Wire Set
10112	8.5 mm	—	90 Degree Plug Boot - Single Lead
10113	8.5 mm	—	Straight Plug Boot - Single Lead

These wire sets and single leads are finished on the spark plug end. The wire sets also include terminals, boots and a crimper/stripper tool to give the distributor end a professional finish. The single leads also include terminals and distributor boots. The crimper/stripper tool is also available separately (P/N 10096).

See the application section and buyer's guide for coverage information for the custom finished sets.



UNE CHALEUR VRAIMENT INTENSE?

BLUE STREAK® EST CAPABLE D'EN PRENDRE!

Les jeux de câbles Blue Streak® sont munis de série de couvre-bornes qui résistent à plus de 315 °C [600 °F] de chaleur... mais ce n'est pas toujours suffisant. Pour les applications qui dégagent une chaleur vraiment intense, nous offrons des jeux de câbles avec couvre-bornes de 315 °C entourés d'un blindage en céramique résistant à 815 °C [1500 °F].

- ✓ 27 jeux de câbles personnalisés avec raccordements pour voitures et camions qui travaillent dur
- ✓ 3 jeux de câbles semi-personnalisés sans raccordements pour tout le reste
- ✓ 2 câbles individuels semi-personnalisés sans raccordements

JEUX DE CÂBLES SEMI-PERSONNALISÉS SANS RACCORDEMENTS

N° de pièce	Calibre du câble	Cyl.	Description
10066	8,5 mm	6	Couvre-bornes droits – jeu de câbles
10067	8,5 mm	8	Couvre-bornes 90 degrés – jeu de câbles
10068	8,5 mm	8	Couvre-bornes droits – jeu de câbles
10112	8,5 mm	–	Couvre-borne 90 degrés – câble individuel
10113	8,5 mm	–	Couvre-borne droit – câble individuel

Sur les jeux de câbles et les câbles individuels, le couvre-borne de bougie est déjà raccordé. Les jeux de câbles comprennent les cosses, les couvre-bornes ainsi qu'un sertisseur/dénudeur pour installer le couvre-borne de distributeur de manière professionnelle. Les câbles individuels comprennent aussi les cosses et le couvre-borne de distributeur. Le sertisseur/dénudeur est aussi offert séparément (N/P 10096).

Consulter la section des applications et le guide d'achat pour voir la couverture des jeux de câbles personnalisés avec raccordements.



NEED WIRES

FOR YOUR **LS POWERED** **VEHICLE?**

BLUE STREAK® **HAS YOU COVERED!**

The General Motors LS engine is one of the most popular V8's available today. Whether your ride is stock or modified, Blue Streak® has custom sets to fit the top applications and semi-custom sets for those who want to equip their hot rod with a performance wire set that is second to none.

Part No.	Wire Size	Length	Spark Plug Boot Type	Assembly
10026	8.5 mm	9"	Straight 600 °F	Custom Finished
10039	9.0 mm	9"	Straight 600 °F	Custom Finished
10041	8.5 mm	9"	90 Degree 600 °F	Custom Finished
10042	9.0 mm	9"	90 Degree 600 °F	Custom Finished
10074	8.5 mm	12"	Straight 600 °F	Custom Finished
10075	8.5 mm	12"	Straight Ceramic	Custom Finished
10120	8.5 mm	45"	Straight Bendable 600 °F	Semi-Custom Unfinished
10121	9.0 mm	45"	Straight Bendable 600 °F	Semi-Custom Unfinished

The semi-custom unfinished sets include terminals, boots and a crimper/stripper tool to give the coil end a professional finish. The 10120 and 10121 sets are finished on the spark plug end. The spark plug boot and terminal will safely bend to a 115-135 degree angle. The 10121 set also includes 1200 °F spark plug boot protectors and 400 °F spark plug wire sleeving to protect your investment from the stress of competition.

See the application section and buyer's guide for coverage information for the custom finished sets.



[View other replacement engine cooling parts made by Four Seasons on our website.](#)