

REGULAR & THAR-FOR3 INSTALLATION

ADDENDUM - SUGGESTED WIRING CONFIGURATION



ONLY COMPATIBLE WITH AUTOMATIC TRANSMISSION VEHICLES.

Vehicle functions supported in this diagram (functional if equipped) |

VEHICLE	YEARS	Immobilizer bypass	Lock	Unlock	Arm	Disarm	Heated Seats**	Rear Defrost**	RAP Disable	Parking Lights***	Tachometer	Door Status	Trunk Status	Hood Status*	Hand-Brake Status	Foot-Brake Status	Active OEM Remote Start
FORD Bronco Sport	Push-to-Start 2021	•	•	•	•	•	•	•	•	•	•	•	•	•	•	•	•



	COMPATIBLE MODULE REQUIRED:	QR CODE ON THE LABEL MANUFACTURED AFTER: 2019	FIRMWARE VERSION 58.[02] MINIMUM	To add the firmware version and the options, use the FLASH LINK UPDATER or FLASH LINK MOBILE tool, sold separately.

UNIT OPTION	DESCRIPTION
C1	OEM Remote status (Lock/Unlock) monitoring
D6	Push-to-Start
A11	OFF Hood trigger (Output Status).

Program bypass option:

IF THE VEHICLE IS NOT EQUIPPED WITH FUNCTIONAL HOOD PIN:

NOTES

The vehicles OEM remote and SmartKey are still operable during remote start.

**Heatd seats The heated seats and rear defrost will activate automatically when cold.

**Rear Defrost

***Parking Lights The parking lights will activate during remote start only.

MANDATORY INSTALL

*HOOD PIN CONTACT

HOOD STATUS: THE HOOD PIN SWITCH MUST BE INSTALLED IF THE VEHICLE CAN BE REMOTE STARTED WITH THE HOOD OPEN, SET FUNCTION A11 TO OFF.

A11 OFF

Notice: the installation of safety elements are mandatory. The hood pin is an essential security element and must be installed.

THIS MODULE MUST BE INSTALLED BY A QUALIFIED TECHNICIAN. A WRONG CONNECTION CAN CAUSE PERMANENT DAMAGE TO THE VEHICLE.

DESCRIPTION

	Parts required (Not included)		PAGE
--	-------------------------------	--	------

WIRE TO WIRE DIAGRAM

AUTOMATIC TRANSMISSION	1x 7.5 Amp. fuse	1x Fusible 7.5 Amp.	Page 3
------------------------	------------------	---------------------	--------

THARNESS DIAGRAM

THARNESS THAR-FOR3 AUTOMATIC TRANSMISSION	1x THAR-FOR3	1x THAR-FOR3	Page 4
---	--------------	--------------	--------

BRONCO SPORT



① Gateway module, Behind OBD-II connector

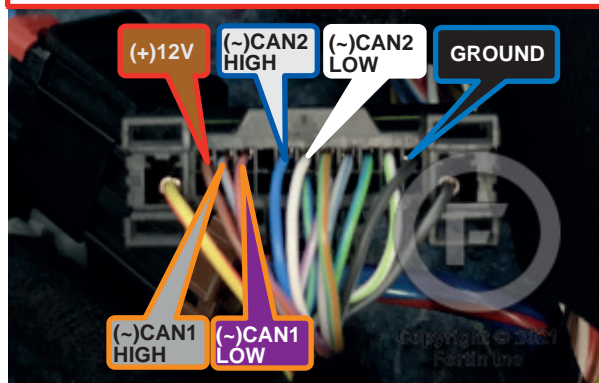

AUTOMATIC TRANSMISSION WIRING CONNECTION |

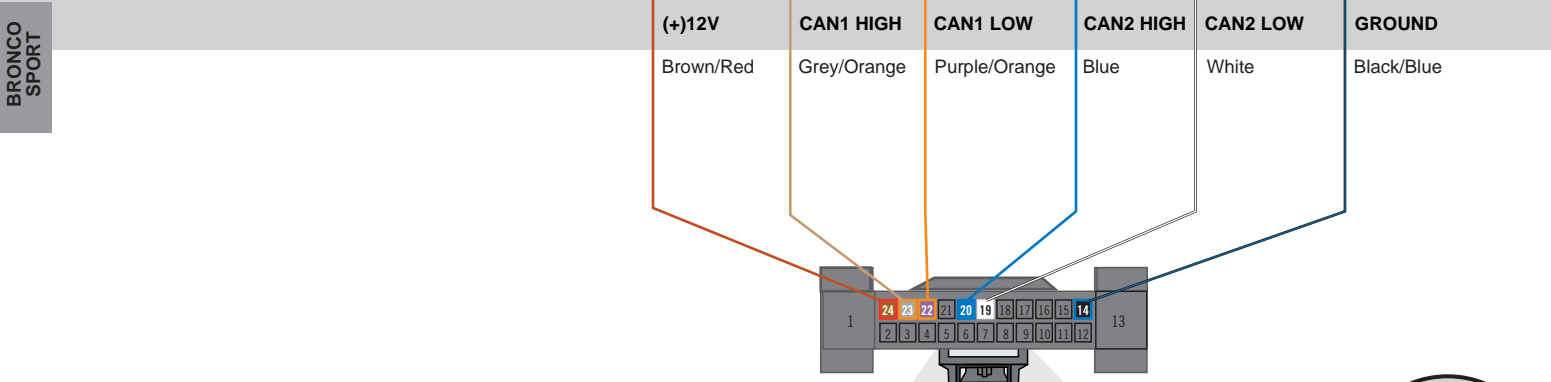
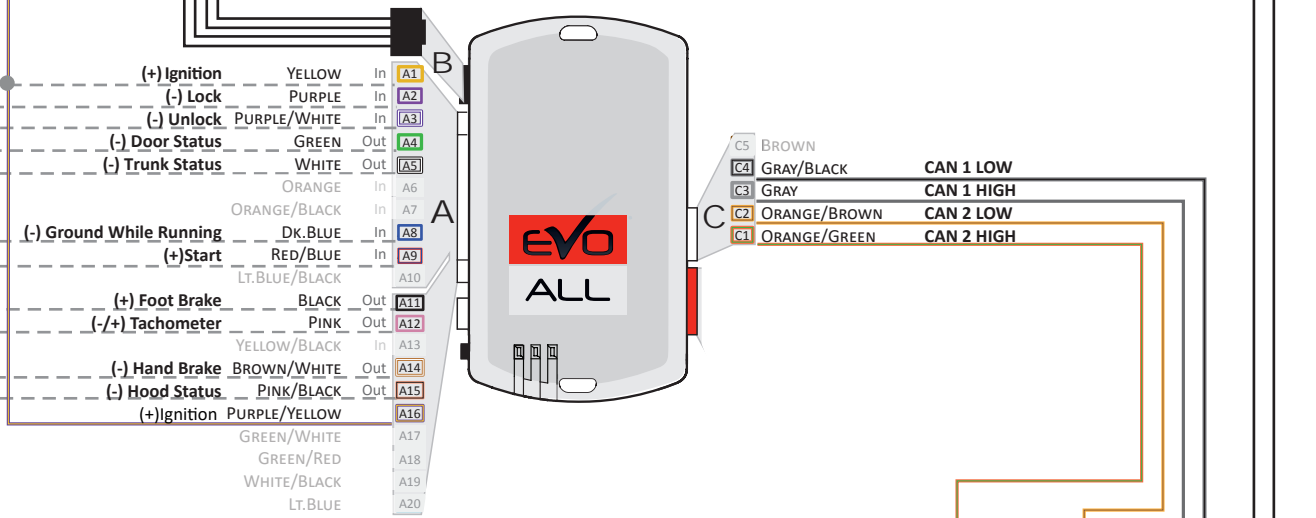
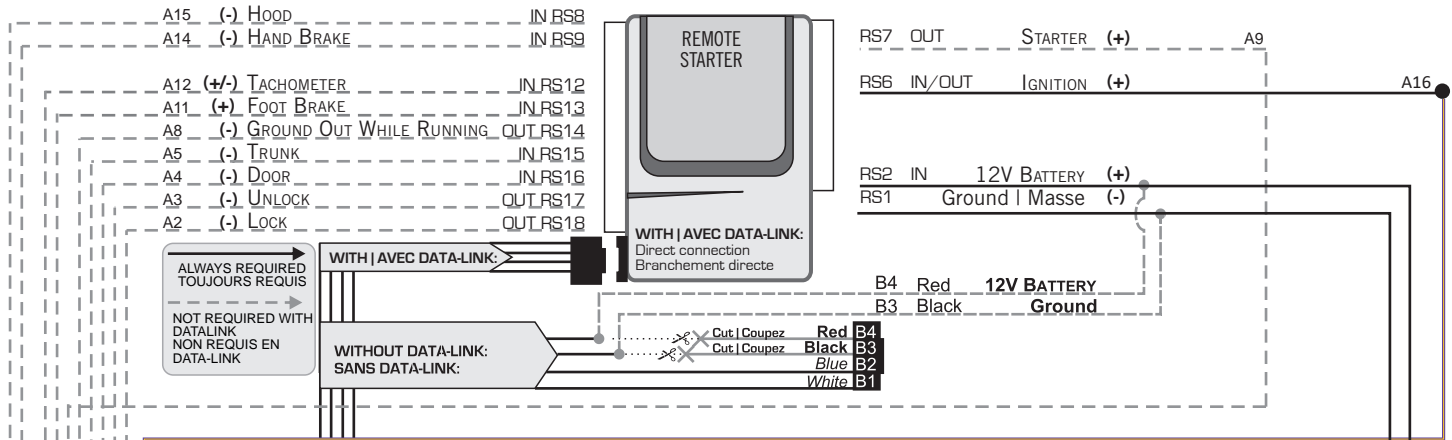

① Gateway module, Behind OBD-II connector - located at dash board driver's side - Back view, 24-pin black connector.

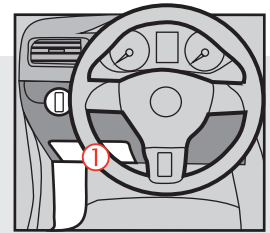

THAR-FOR3 | T-HARNESS - AUTOMATIC TRANSMISSION |

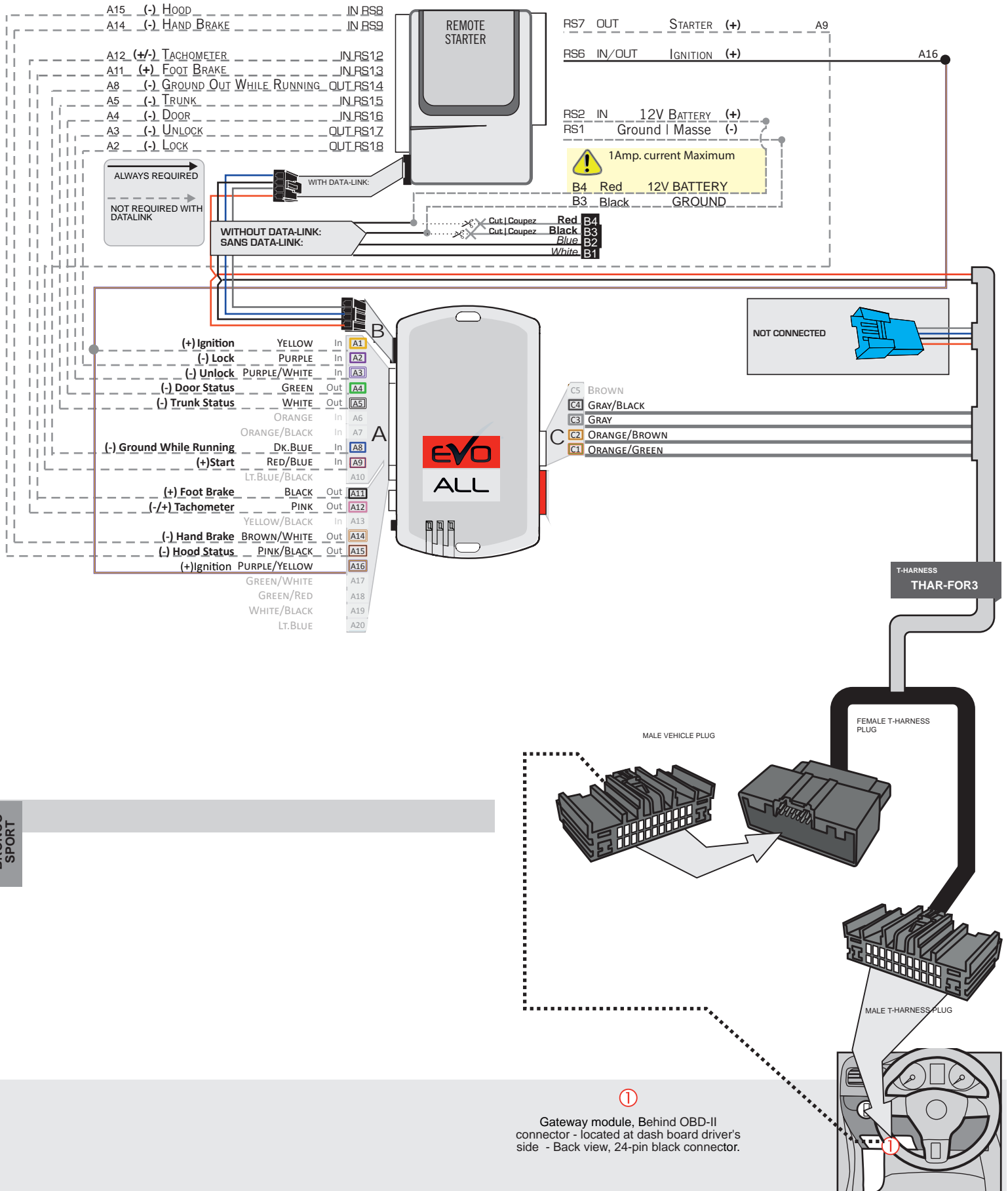

BRONCO SPORT



Parts required (not included)

- 1x FLASH LINK UPDATER, SOFTWARE
- 1x FLASH LINK MANAGER SOFTWARE
- 1x Microsoft Windows Computer with Internet connection

OR
OU

- 1x FLASH LINK MOBILE
- 1x FLASH LINK MOBILE APP
- Smartphone Android or iOS with Internet connection (Internet provider charges may apply)

BEFORE PROGRAMMING SET THE UNIT OPTIONS AND SAVE.

1

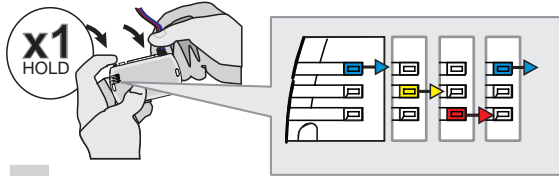

Press and hold the programming button:
Insert the 4-Pin (Data-Link) connector.

↳ The Blue, Red, Yellow and Blue & Red LEDs will alternatively illuminate.

2

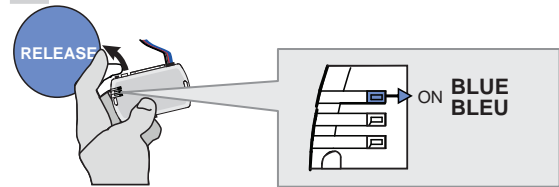

Release the programming button when the LED is BLUE.

If the LED is not solid BLUE disconnect the 4-Pin connector (Data-Link) and go back to step 1.

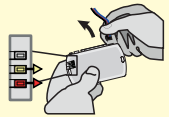

3

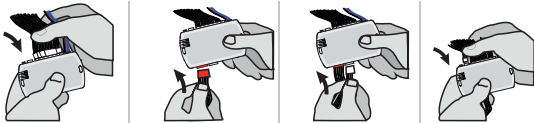

Insert the required remaining connectors.

4

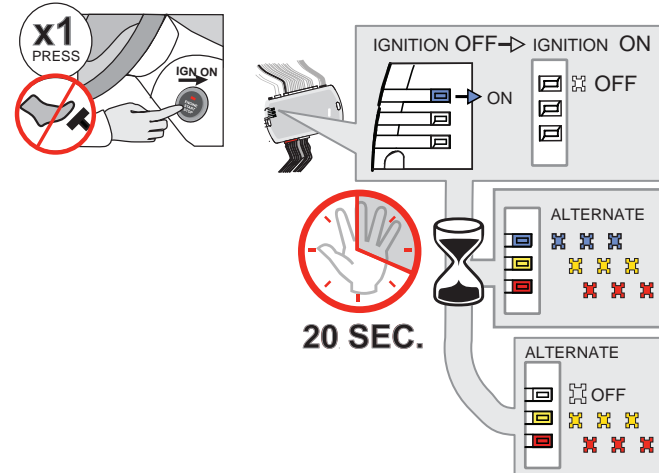

Do not press the brake pedal.
Press the Push-to-Start button once to turn on the ignition.

↳ The BLUE LED will turn OFF.

↳ The BLUE, YELLOW and RED LEDs will alternate.

Wait, at least 20 seconds, do not disconnect the modules or turn off the ignition.

↳ The RED and YELLOW LEDs will alternate.

Make sure that the DELs are flashing RED and YELLOW before continuing programming.

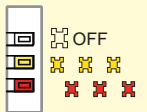

5

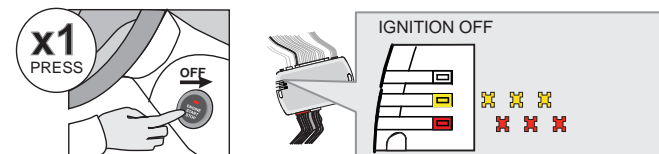

Press the Push-to-Start button once to turn off the ignition.

↳ The RED and YELLOW LEDs alternate.

KEY BYPASS PROGRAMMING PROCEDURE 2/2 |

6

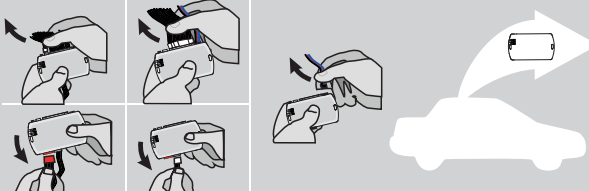

Disconnect all the connectors and after the Data-Link (4-pins) connector.

7



Microsoft Windows Computer with Internet connection*

FLASH LINK UPDATER* **FLASH LINK MANAGER*** SOFTWARE

OR

Smartphone* (Internet provider charges may apply)

VEHICLE'S OBDII CONNECTOR **FLASH LINK MOBILE***

Use the tool: FLASH LINK UPDATER or FLASH LINK MOBILE to visit the DCryptor menu.

*Parts required (not included)

8

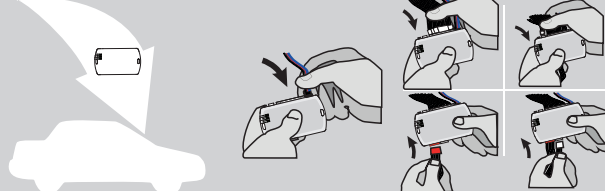

AFTER DCRYPTOR PROGRAMMING COMPLETED
Go back to the vehicle and **reconnect** the 4-Pin (Data-Link) connector and after, all the remaining connector.

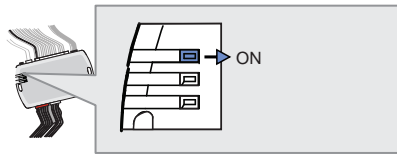

↳ The BLUE LED will turn ON.

9

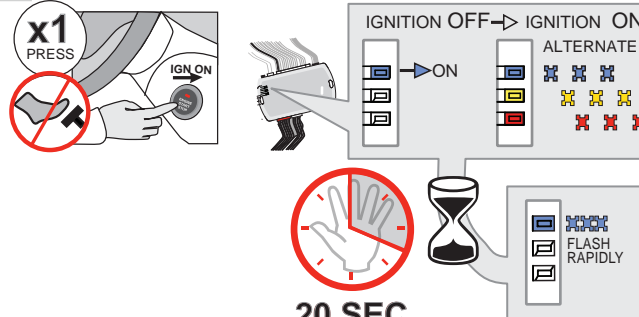

x1 PRESS (with a red 'X' over the push-to-start button)

IGNITION OFF → IGNITION ON

ALTERNATE

↳ The RED and YELLOW LEDs will turn ON.

Wait, at least 20 seconds, do not disconnect the modules or turn off the ignition.

↳ The BLUE LED will flash rapidly.

20 SEC.

FLASH RAPIDLY

10

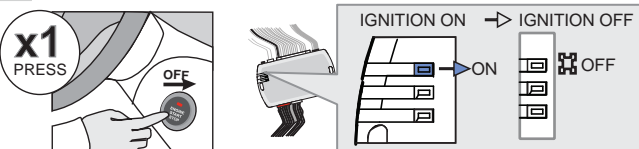

x1 PRESS (with a red 'X' over the push-to-start button)

IGNITION ON → IGNITION OFF





OFF

↳ The BLUE will turn OFF.

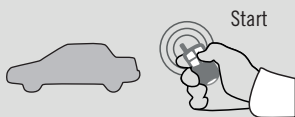

The module is now programmed.

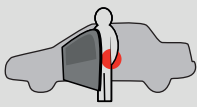
REMOTE STARTER FUNCTIONALITY |

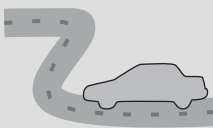
 <p>Start</p> <p>All doors must be closed.</p> <p>Remote start the vehicle.</p>	 <p>UNLOCK</p> <p>Unlock the doors with either:</p> <ul style="list-style-type: none"> • The OEM remote • The remote-starter remote • Or the proximity remote 	 <p>Enter the vehicle with the SMART-KEY.</p>	 <p>x1 PRESS</p> <p>DO NOT PRESS THE BRAKE PEDAL.</p> <p>Press and release the Push-to-Start button once.</p>	 <p>Press the brake pedal. The vehicle can now be put in to gear and driven.</p> <p>If the Smart-Key is not detected the vehicle will shut down.</p>
--	---	--	--	---



REGULAR & THAR-FOR3 INSTALLATION

ADDENDUM - SUGGESTED WIRING CONFIGURATION



ONLY COMPATIBLE WITH AUTOMATIC TRANSMISSION VEHICLES.

VEHICLE	YEARS	Vehicle functions supported in this diagram (functional if equipped)												
		T-Harness available (sold separately)	Lock	Unlock	Arm	Disarm	Parking Lights	Tachometer	Door Status	Hood Status*	Hand-Brake Status	Foot-Brake Status		
														
FORD														
E-350	2021	•	•	•	•	•	•	•	•	•	•	•	•	•
E-450	2021	•	•	•	•	•	•	•	•	•	•	•	•	•



FIRMWARE VERSION

71.[52]

MINIMUM

To add the firmware version and the options, use the **FLASH LINK UPDATER** or **FLASH LINK MOBILE** tool, sold separately.

	Program bypass option:	UNIT OPTION	DESCRIPTION
		A3	OFF
IF THE VEHICLE IS NOT EQUIPPED WITH FUNCTIONAL HOOD PIN:		A11	OFF
			Hood trigger (Output Status).

Parts required (Not included)			PAGE
WIRE TO WIRE DIAGRAM			
1x	Relay (Parking lights)		Page 3
THARNNESS DIAGRAM			
1x	THAR-FOR3		Page 4
1x	Relay (Parking lights)		

MANDATORY INSTALL

*HOOD PIN



HOOD STATUS: THE HOOD PIN SWITCH MUST BE INSTALLED IF THE VEHICLE CAN BE REMOTE STARTED WITH THE HOOD OPEN, SET FUNCTION A11 TO OFF.

A11

OFF

Notice: the installation of safety elements are mandatory. The hood pin is an essential security element and must be installed.

THIS MODULE MUST BE INSTALLED BY A QUALIFIED TECHNICIAN. A WRONG CONNECTION CAN CAUSE PERMANENT DAMAGE TO THE VEHICLE.

DESCRIPTION



② Parking Lights switch

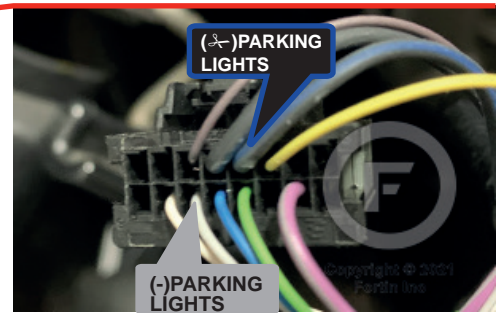

③ Gateway module, Behind OBD-II connector

④ Passenger kick panel

① Ignition switch

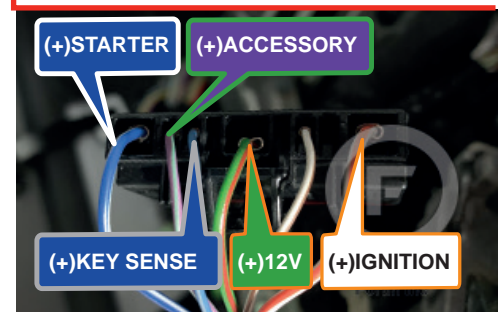
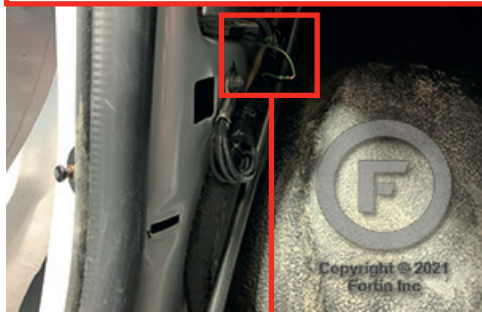
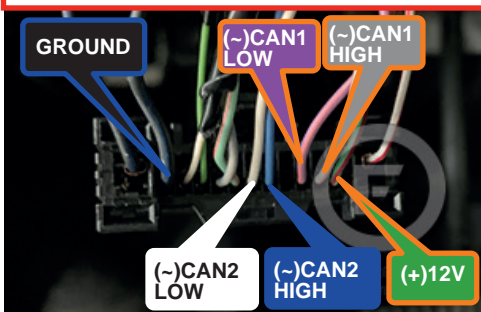

AUTOMATIC TRANSMISSION WIRING CONNECTION

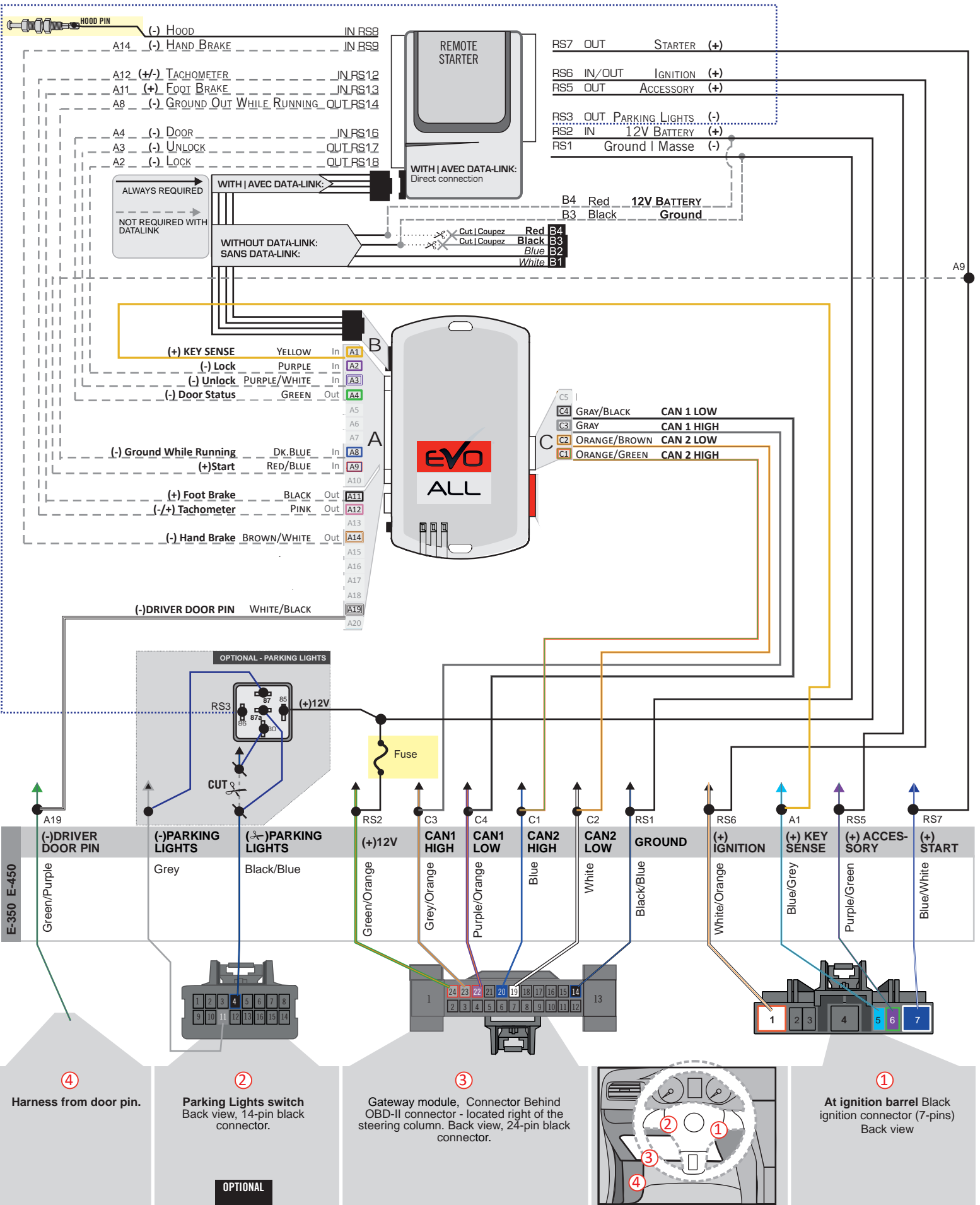

THAR-FOR3 | T-HARNESS - AUTOMATIC TRANSMISSION

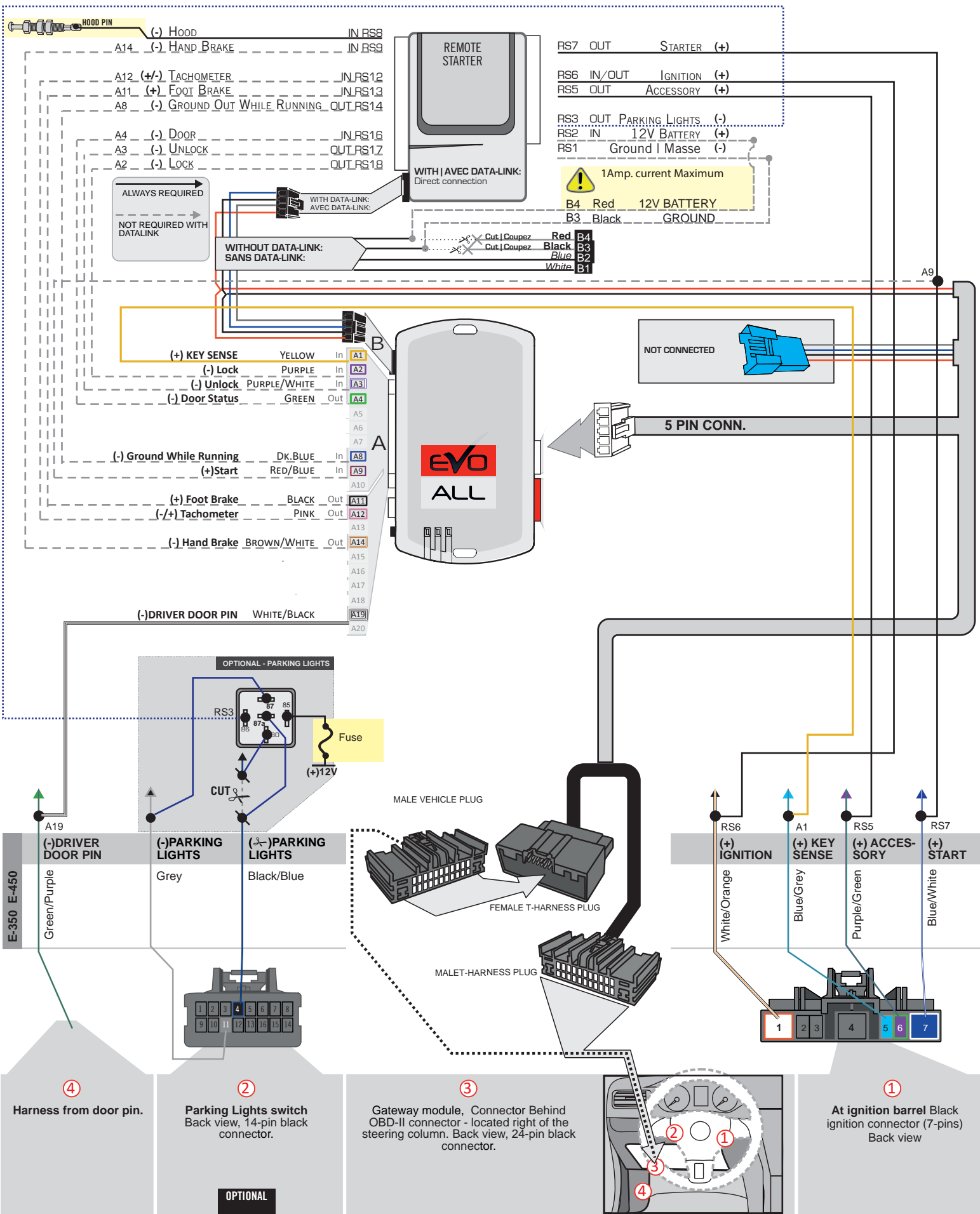

PROGRAMMING PROCEDURE

1

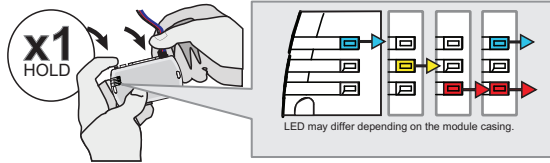

Press and hold the programming button:
Connect the 4-PIN Data-link harness (Black connector).

↳ The Blue, Red, Yellow and Blue & Red LEDs will alternatively illuminate.

2

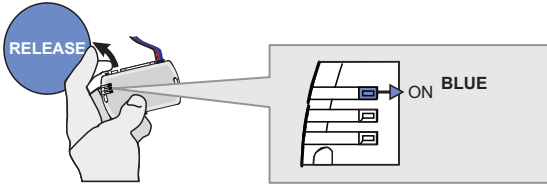

Release the programming button when the LED is BLUE.

If the LED is not solid BLUE disconnect the 4-Pin connector (Data-Link) and go back to step 1.

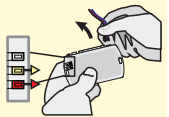

3

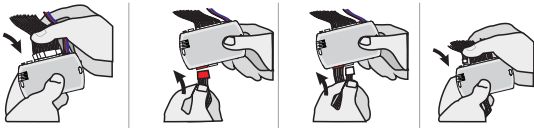

Insert the required remaining connectors.

4

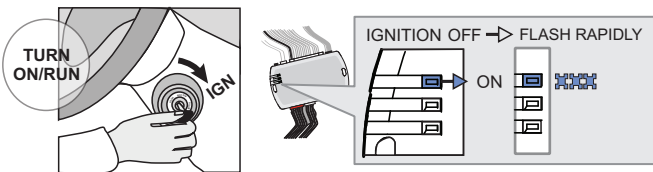

Turn the key to the Ignition ON/RUN position.

↳ The BLUE LED will flash rapidly.

5

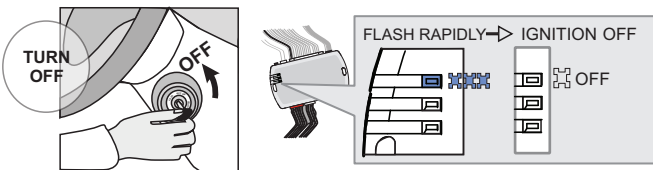

Turn the key to the OFF position.

↳ The BLUE LED will turn off.



The module is now programmed.

REMOTE STARTER FUNCTIONALITY



All doors must be closed.



Remote start the vehicle.



Unlock the doors with the remote-starter remote or the OEM remote.



Insert and Turn the key to the Ignition ON/RUN position.



Press the brake pedal.



The vehicle can now be put in to gear and driven.

REGULAR & THAR-FOR3 INSTALLATION

ADDENDUM - SUGGESTED WIRING CONFIGURATION



ONLY COMPATIBLE WITH AUTOMATIC TRANSMISSION VEHICLES.



Vehicle functions supported in this diagram (functional if equipped)

VEHICLE	YEARS	Immobilizer bypass	Lock	Unlock	Arm	Disarm	Heated Seats**	Rear Defrost**	RAP Disable	Parking Lights***	Tachometer	Door Status	Trunk Status	Hood Status*	Hand-Brake Status	Foot-Brake Status	Active OEM Remote Start
LINCOLN Aviator	Push-to-Start 2020	•	•	•	•	•	•	•	•	•	•	•	•	•	•	•	•

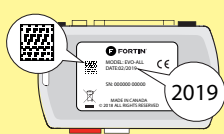

COMPATIBLE MODULE REQUIRED:

QR CODE ON THE LABEL
MANUFACTURED AFTER: 2019

FIRMWARE VERSION
58.[02]
MINIMUM

To add the firmware version and the options, use the **FLASH LINK UPDATER** or **FLASH LINK MOBILE** tool, sold separately.



Program bypass option:

UNIT OPTION

DESCRIPTION

C1

OEM Remote status (Lock/Unlock) monitoring

D6

Push-to-Start

IF THE VEHICLE IS NOT EQUIPPED WITH FUNCTIONAL HOOD PIN:

A11

OFF

Hood trigger (Output Status).

NOTES

The vehicles OEM remote and SmartKey are still operable during remote start.

**Heatd seats The heated seats and rear defrost activate automatically when it cold.

***Parking Lights The parking Lights at remote start only.

MANDATORY INSTALL

*HOOD PIN



HOOD STATUS: THE HOOD PIN SWITCH MUST BE INSTALLED IF THE VEHICLE CAN BE REMOTE STARTED WITH THE HOOD OPEN, SET FUNCTION A11 TO OFF.

A11

OFF

Notice: the installation of safety elements are mandatory. The hood pin is an essential security element and must be installed.

THIS MODULE MUST BE INSTALLED BY A QUALIFIED TECHNICIAN. A WRONG CONNECTION CAN CAUSE PERMANENT DAMAGE TO THE VEHICLE.

DESCRIPTION |

	Parts required (Not included)		PAGE
--	-------------------------------	--	------

WIRE TO WIRE DIAGRAM

AUTOMATIC TRANSMISSION	1x 7.5 Amp. fuse	1x Fusible 7.5 Amp.	Page 3
------------------------	------------------	---------------------	--------

THARNES DIAGRAM

THARNES THAR-FOR3 AUTOMATIC TRANSMISSION	1x THAR-FOR3	1x THAR-FOR3	Page 4
--	--------------	--------------	--------

① Gateway module, located at dash board driver's side,

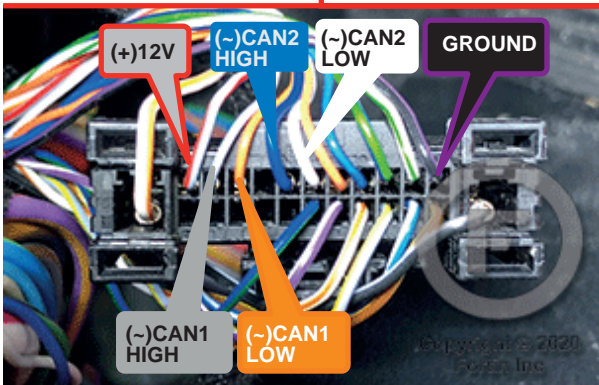

② Fuse box

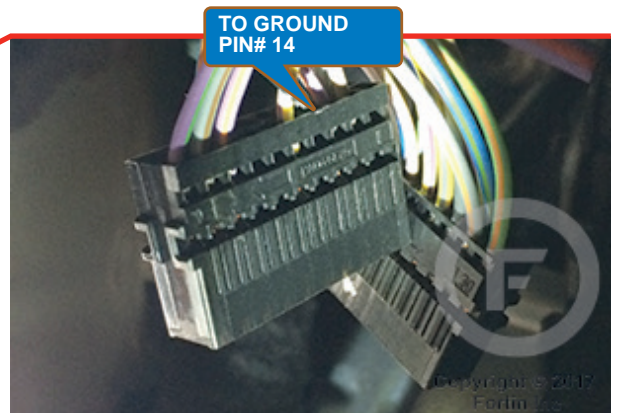
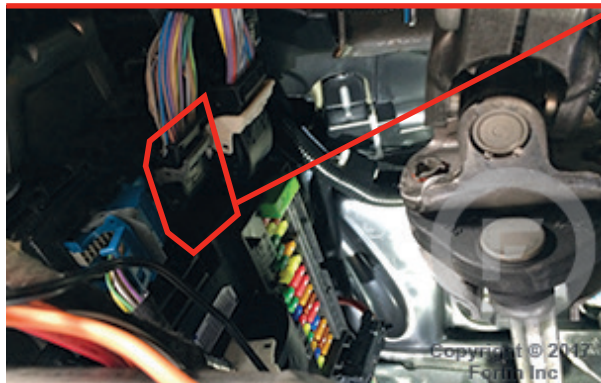

AUTOMATIC TRANSMISSION WIRING CONNECTION |

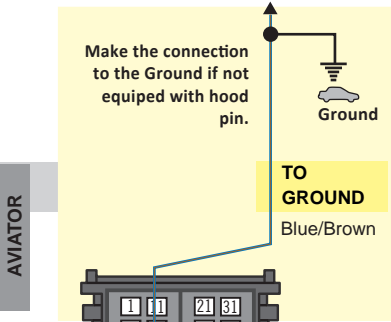
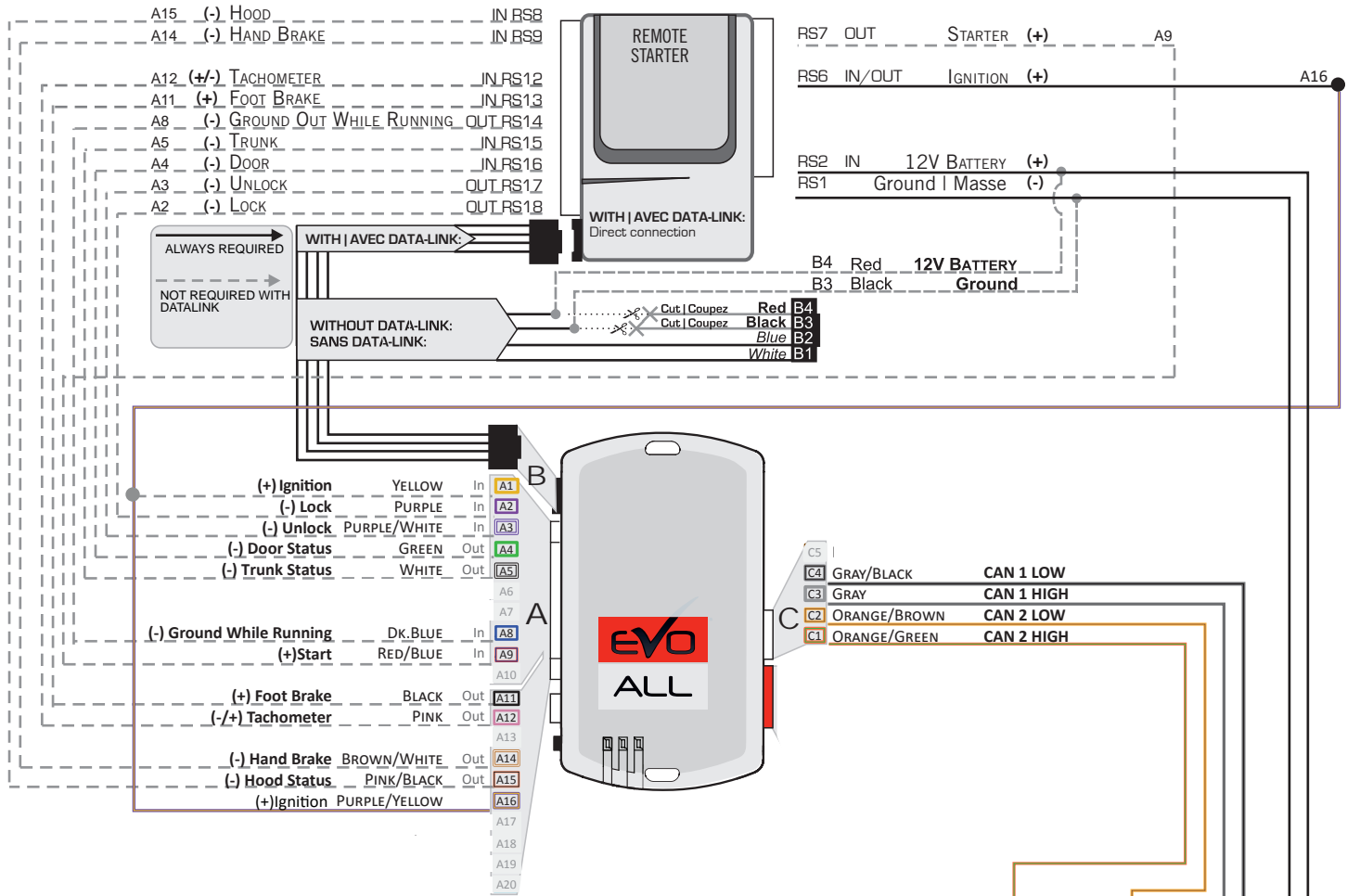

AVIATOR

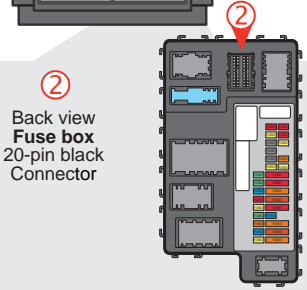
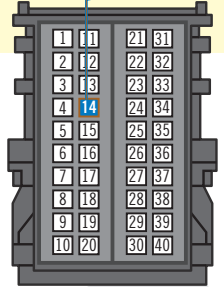
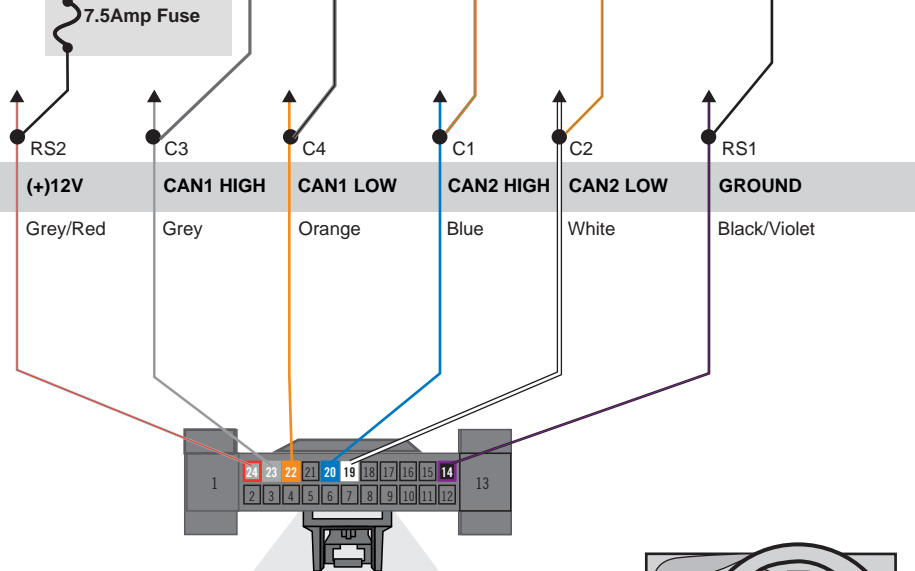

② Back view Fuse box 20-pin black Connector

① Gateway module, Behind OBD-II connector - located at dash board driver's side - Back view, 24-pin black connector.

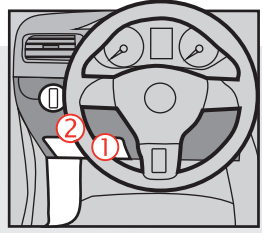

THAR-FOR3 | T-HARNESS - AUTOMATIC TRANSMISSION |

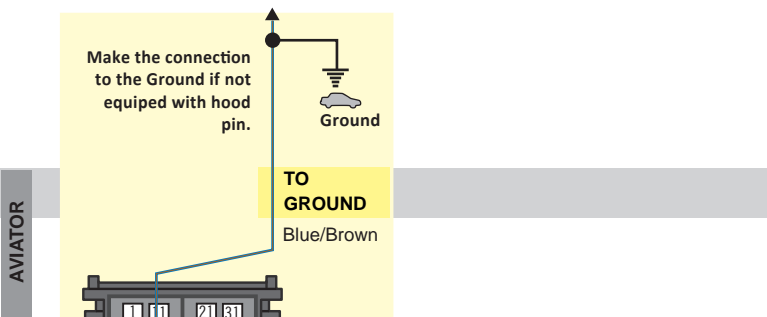
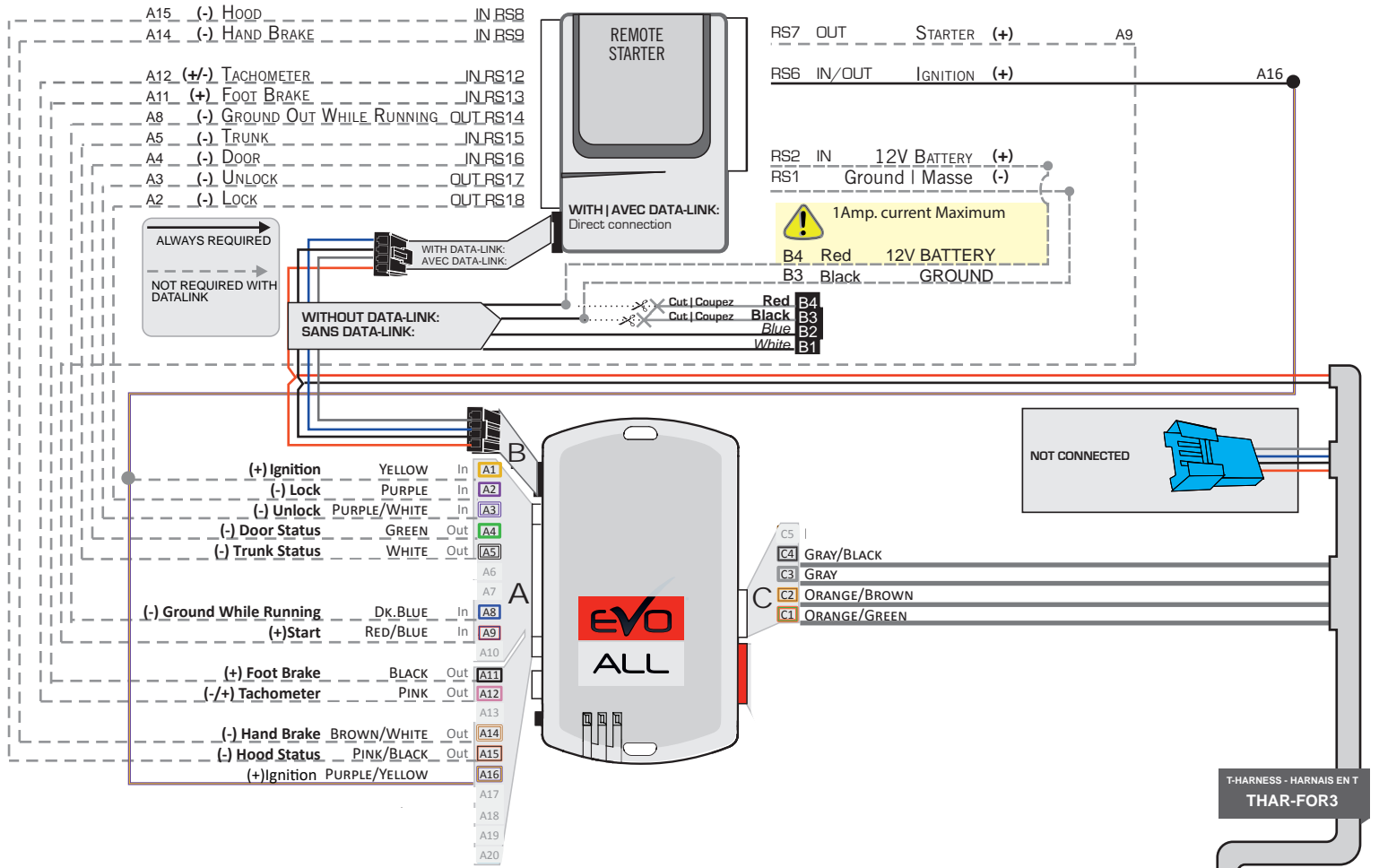

AVIATOR

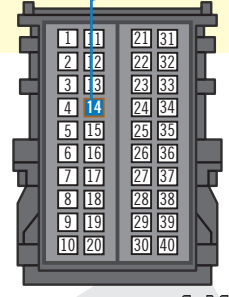

② Back view Fuse box 20-pin black Connector

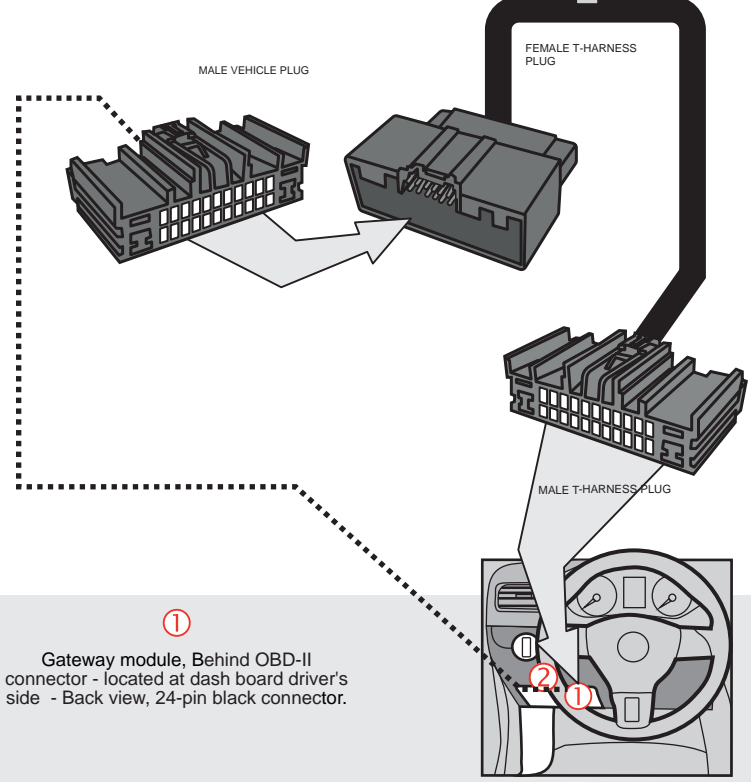

T-HARNESS - HARNAIS EN T THAR-FOR3



Parts required (not included)

- 1x FLASH LINK UPDATER, SOFTWARE | PROGRAMME
- 1x FLASH LINK MANAGER
- 1x Microsoft Windows Computer with Internet connection

OR

- 1x FLASH LINK MOBILE
- 1x FLASH LINK MOBILE APP
- Smartphone Android or iOS with Internet connection (Internet provider charges may apply)

BEFORE PROGRAMMING SET THE UNIT OPTIONS AND SAVE.

1

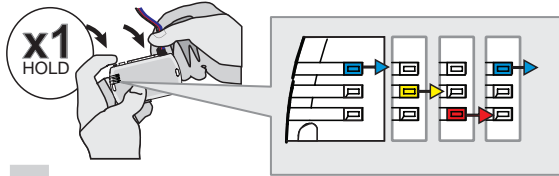

Press and hold the programming button:
Insert the 4-Pin (Data-Link) connector.

↳ The Blue, Red, Yellow and Blue & Red LEDs will alternatively illuminate.

2

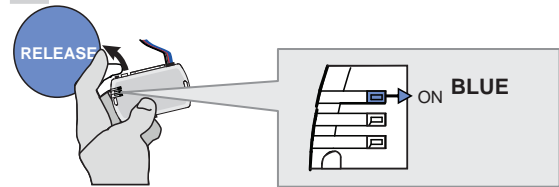

Release the programming button when the LED is BLUE.

If the LED is not solid BLUE disconnect the 4-Pin connector (Data-Link) and go back to step 1.

3

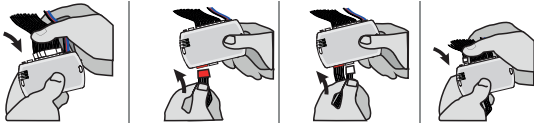

Insert the required remaining connectors.

4

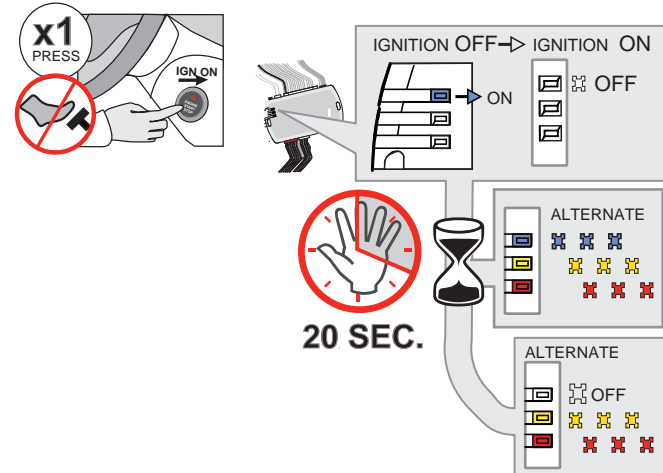

Do not press the brake pedal.
Press the Push-to-Start button once to turn on the ignition.

↳ The BLUE LED will turn OFF.

↳ The BLUE, YELLOW and RED LEDs will alternate.

Wait, at least 20 seconds, do not disconnect the modules or turn off the ignition.

↳ The RED and YELLOW LEDs will alternate.

Make sure that the DELs are flashing RED and YELLOW before continuing programming.

5

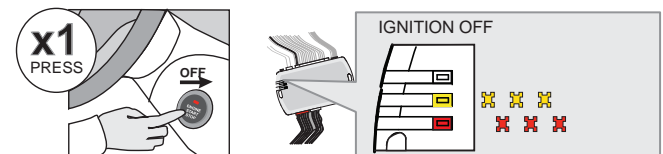

Press the Push-to-Start button once to turn off the ignition.

↳ The RED and YELLOW LEDs alternate.

KEY BYPASS PROGRAMMING PROCEDURE 2/2 |

6

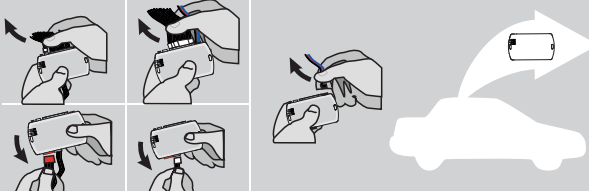

Disconnect all the connectors and after the Data-Link (4-pins) connector.

7



Microsoft Windows Computer with Internet connection*

FLASH LINK UPDATER* **FLASH LINK MANAGER***
SOFTWARE | PROGRAMME

OR

Smartphone* (Internet provider charges may apply)

VEHICLE'S OBDII CONNECTOR **FLASH LINK MOBILE***

Use the tool: FLASH LINK UPDATER or FLASH LINK MOBILE to visit the DCryptor menu.

*Parts required (not included)

8

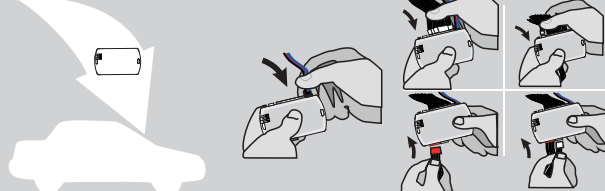

AFTER DCRYPTOR PROGRAMMING COMPLETED
Go back to the vehicle and reconnect the 4-Pin (Data-Link) connector and after, all the remaining connector.

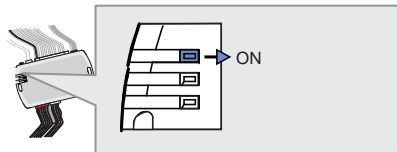

↳ The BLUE LED will turn ON.

9

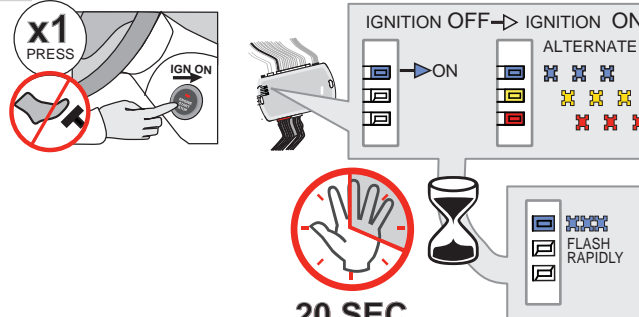

x1 PRESS (with a red 'X' over the push-to-start button)

IGNITION OFF → IGNITION ON

ALTERNATE

The RED and YELLOW LEDs will turn ON.

20 SEC. (with a hand icon and an hourglass)

FLASH RAPIDLY

Wait, at least 20 seconds, do not disconnect the modules or turn off the ignition.

↳ The BLUE LED will flash rapidly.

10

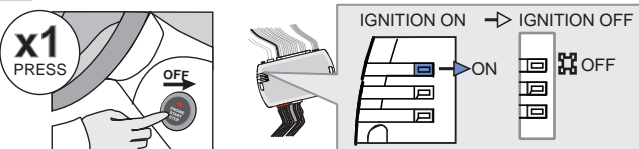

x1 PRESS (with a red 'X' over the push-to-start button)

IGNITION ON → IGNITION OFF

OFF





Press the Push-to-Start button once to turn off the ignition.

↳ The BLUE will turn OFF.

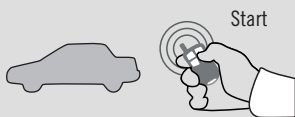

The module is now programmed.

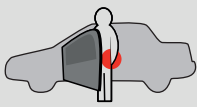
REMOTE STARTER FUNCTIONALITY |

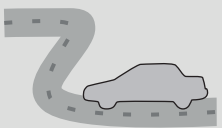
 <p>Start</p> <p>All doors must be closed.</p> <p>Remote start the vehicle.</p>	 <p>UNLOCK</p> <p>Unlock the doors with either:</p> <ul style="list-style-type: none"> • The OEM remote • The remote-starter remote • Or the proximity remote 	 <p>Enter the vehicle with the SMART-KEY.</p>	 <p>DO NOT PRESS THE BRAKE PEDAL.</p> <p>Press and release the Push-to-Start button once.</p>	 <p>Press the brake pedal. The vehicle can now be put in to gear and driven.</p> <p>If the Smart-Key is not detected the vehicle will shut down.</p>
--	---	--	---	---

REGULAR & THAR-FOR3 INSTALLATION

ADDENDUM - SUGGESTED WIRING CONFIGURATION



ONLY COMPATIBLE WITH AUTOMATIC TRANSMISSION VEHICLES.



Vehicle functions supported in this diagram (functional if equipped)

VEHICLE	YEARS	Immobilizer bypass	T-Harness available (sold separately)	Lock	Unlock	Arm	Disarm	Heated Seats**	Rear Defrost**	RAP Disable	Parking Lights***	Tachometer	Door Status	Trunk Status	Hood Status*	Hand-Brake Status	Foot-Brake Status	Active OEM Remote Start	
FORD																			
Edge	2020	•	•	•	•	•	•	•	•	•	•	•	•	•	•	•	•	•	•

	COMPATIBLE MODULE REQUIRED: 2019	QR CODE ON THE LABEL MANUFACTURED AFTER: 2019	FIRMWARE VERSION 58.[02] MINIMUM	To add the firmware version and the options, use the FLASH LINK UPDATER or FLASH LINK MOBILE tool, sold separately.

	Program bypass option:	UNIT OPTION	DESCRIPTION
		C1	OEM Remote status (Lock/Unlock) monitoring errouillage/Déverrouil-
		D6	Push-to-Start
	IF THE VEHICLE IS NOT EQUIPPED WITH FUNCTIONAL HOOD PIN:	A11	<input type="checkbox"/> OFF Hood trigger (Output Status).

NOTES

The vehicles OEM remote and SmartKey are still operable during remote start.

**Heated seats The heated seats and rear defrost activate automatically when it cold.

**Rear Defrost

***Parking Lights The parking Lights at remote start only.

MANDATORY INSTALL



HOOD STATUS: THE HOOD PIN SWITCH MUST BE INSTALLED IF THE VEHICLE CAN BE REMOTE STARTED WITH THE HOOD OPEN, SET FUNCTION A11 TO OFF.

A11	<input type="checkbox"/> OFF
------------	-------------------------------------

Notice: the installation of safety elements are mandatory. The hood pin is an essential security element and must be installed.

THIS MODULE MUST BE INSTALLED BY A QUALIFIED TECHNICIAN. A WRONG CONNECTION CAN CAUSE PERMANENT DAMAGE TO THE VEHICLE.

DESCRIPTION | DESCRIPTION

	Parts required (Not included)	PAGE
--	-------------------------------	------

WIRE TO WIRE DIAGRAM

AUTOMATIC TRANSMISSION	1x 7.5 Amp. fuse	Page 3
------------------------	------------------	--------

THARNES DIAGRAM

THARNES THAR-FOR3 AUTOMATIC TRANSMISSION	1x THAR-FOR3	Page 4
--	--------------	--------



② Parking Lights switch

① Gateway module, located at right of steering column.

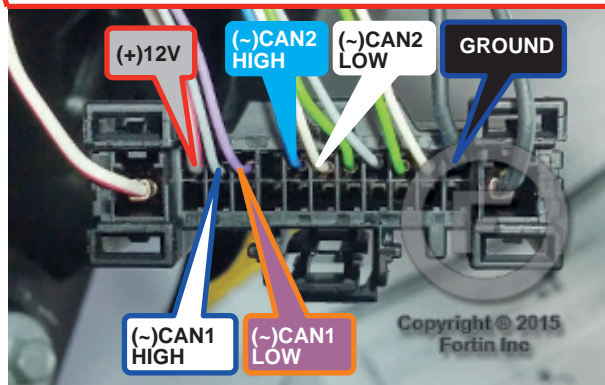
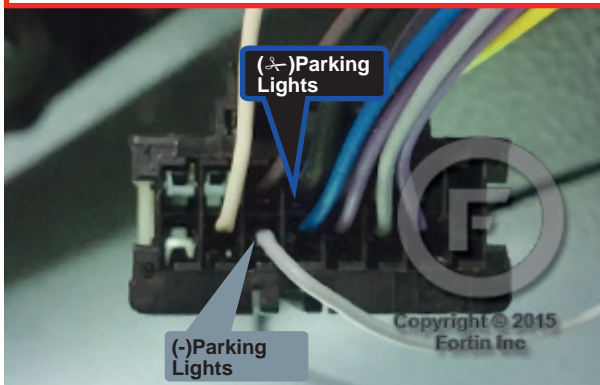

AUTOMATIC TRANSMISSION WIRING CONNECTION |

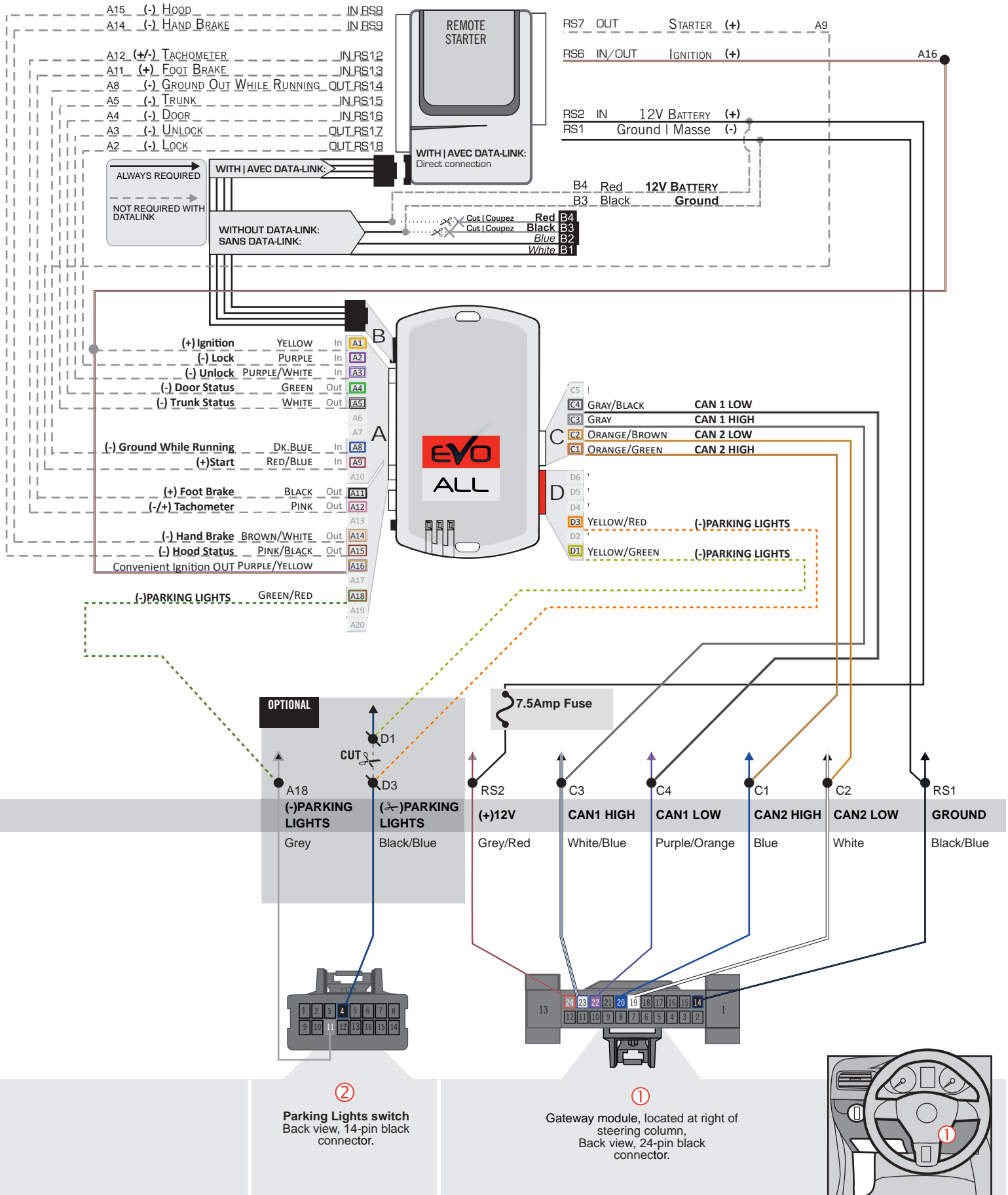

THAR-FOR3 | T-HARNESS - AUTOMATIC TRANSMISSION |

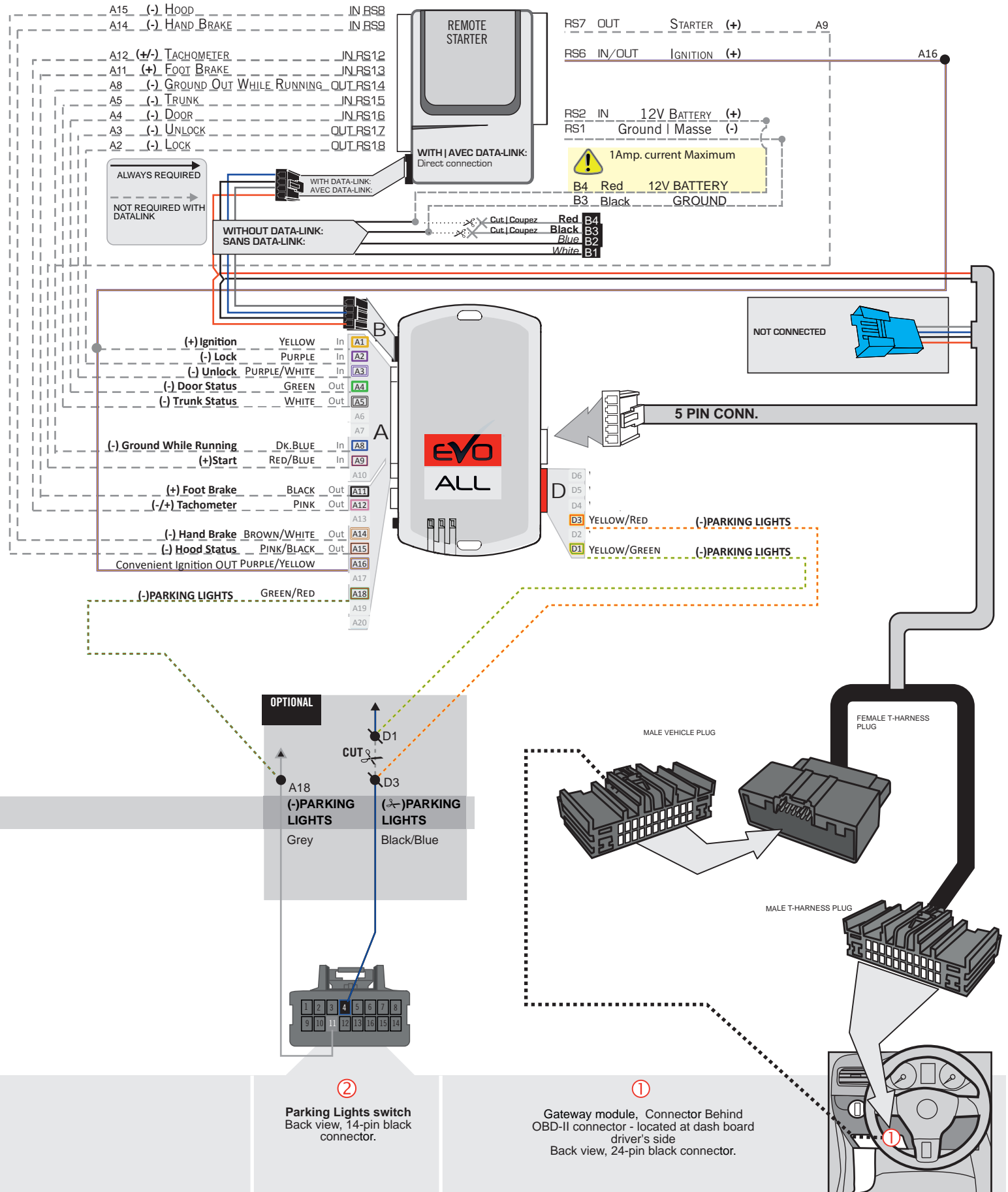



Parts required (not included)

- 1x FLASH LINK UPDATER, SOFTWARE | PROGRAMME
- 1x FLASH LINK MANAGER
- 1x Microsoft Windows Computer with Internet connection

OR

- 1x FLASH LINK MOBILE
- 1x FLASH LINK MOBILE APP
- Smartphone Android or iOS with Internet connection (Internet provider charges may apply)

BEFORE PROGRAMMING SET THE UNIT OPTIONS AND SAVE.

1

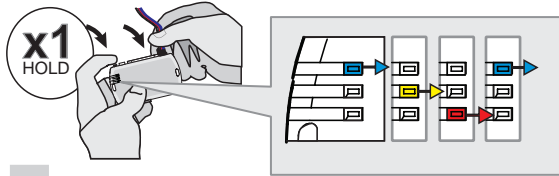

Press and hold the programming button:
Insert the 4-Pin (Data-Link) connector.

↳ The Blue, Red, Yellow and Blue & Red LEDs will alternatively illuminate.

2

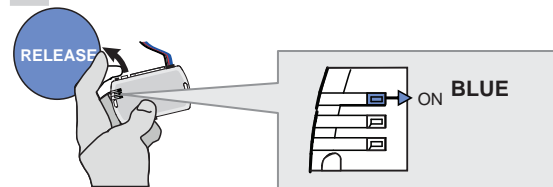

Release the programming button when the LED is BLUE.

If the LED is not solid BLUE disconnect the 4-Pin connector (Data-Link) and go back to step 1.

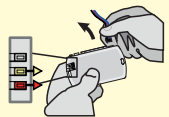

3

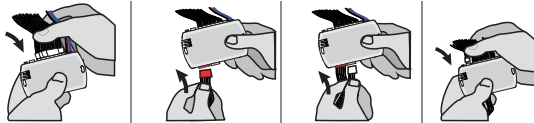

Insert the required remaining connectors.

4

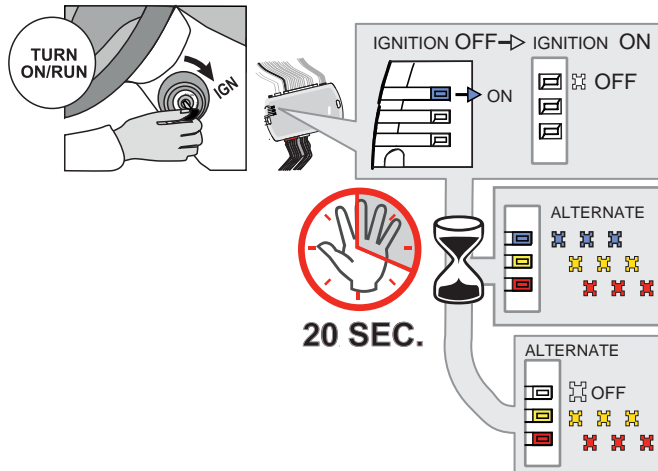

Turn the key to the Ignition ON/RUN position.

↳ The BLUE LED will turn OFF.

↳ The BLUE, YELLOW and RED LEDs will alternate.

Wait, at least 20 seconds, do not disconnect the modules or turn off the ignition.

↳ The RED and YELLOW LEDs will alternate.

Make sure that the DELs are flashing RED and YELLOW before continuing programming.

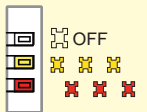

5

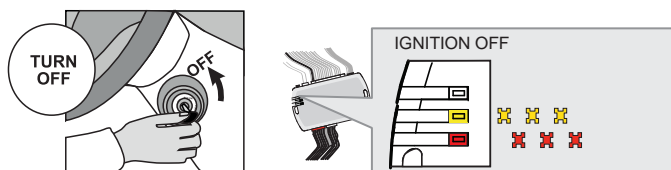

Turn the key to the OFF position.

↳ The RED and YELLOW LEDs alternate.

KEY BYPASS PROGRAMMING PROCEDURE 2/2 |

6

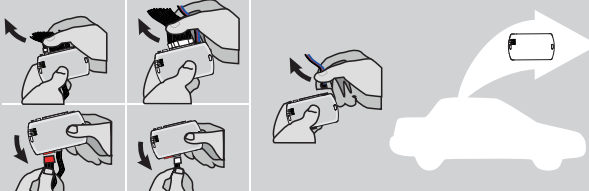

Disconnect all the connectors and after the Data-Link (4-pins) connector.

7



Microsoft Windows Computer with Internet connection*

FLASH LINK UPDATER* **FLASH LINK MANAGER***
SOFTWARE | PROGRAMME

OR

Smartphone* (Internet provider charges may apply)

FLASH LINK MOBILE*

VEHICLE'S OBDII CONNECTOR

Use the tool: FLASH LINK UPDATER or FLASH LINK MOBILE to visit the DCRYPTOR menu.

*Parts required (not included)

8

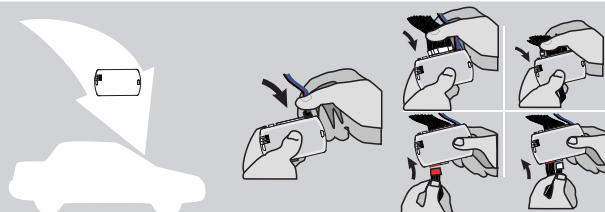

AFTER DCRYPTOR PROGRAMMING COMPLETED
Go back to the vehicle and reconnect the 4-Pin (Data-Link) connector and after, all the remaining connector.



↳ The BLUE LED will turn ON.

9

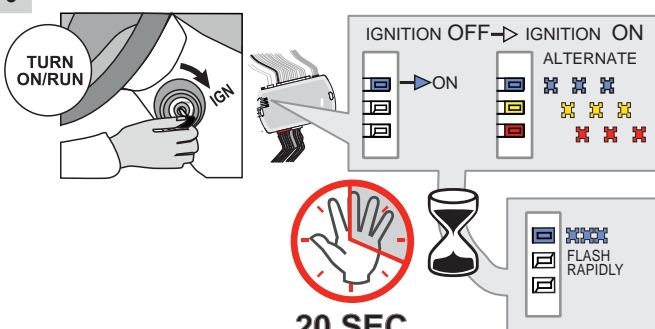

TURN ON/RUN

IGNITION OFF → IGNITION ON

ALTERNATE

↳ The RED and YELLOW LEDs will turn ON.

Wait, at least 20 seconds, do not disconnect the modules or turn off the ignition.

↳ The BLUE LED will flash rapidly.

20 SEC.

FLASH RAPIDLY

10

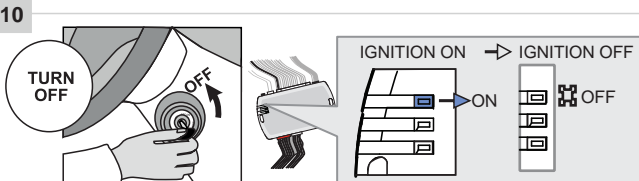

TURN OFF

IGNITION ON → IGNITION OFF

↳ The BLUE will turn OFF.



The module is now programmed.

REMOTE STARTER FUNCTIONALITY |



All doors must be closed.



Remote start the vehicle.



Unlock the doors with the remote-starter remote or the OEM remote.



Insert and Turn the key to the Ignition ON/RUN position.



Press the brake pedal.



The vehicle can now be put in to gear and driven.

REGULAR & THAR-FOR3 INSTALLATION

ADDENDUM - SUGGESTED WIRING CONFIGURATION



ONLY COMPATIBLE WITH AUTOMATIC TRANSMISSION VEHICLES.



Vehicle functions supported in this diagram (functional if equipped)

VEHICLE	YEARS	Immobilizer bypass	T-Harness available (sold separately)	Lock	Unlock	Arm	Disarm	Heated Seats**	Rear Defrost**	RAP Disable	Parking Lights***	Tachometer	Door Status	Trunk Status	Hood Status*	Hand-Brake Status	Foot-Brake Status	Active OEM Remote Start	
FORD																			
Edge	Push-to-Start 2020	•	•	•	•	•	•	•	•	•	•	•	•	•	•	•	•	•	•

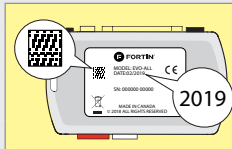

COMPATIBLE MODULE REQUIRED:

QR CODE ON THE LABEL
MANUFACTURED AFTER: 2019

FIRMWARE VERSION

58.[02]
MINIMUM

To add the firmware version and the options, use the FLASH LINK UPDATER or FLASH LINK MOBILE tool, sold separately.



Program bypass option:

UNIT OPTION

DESCRIPTION

C1

OEM Remote status (Lock/Unlock) monitoring

D6

Push-to-Start

IF THE VEHICLE IS NOT EQUIPPED WITH FUNCTIONAL HOOD PIN:

A11

OFF
NON

Hood trigger (Output Status).

NOTES

The vehicles OEM remote and SmartKey are still operable during remote start.

**Heated seats The heated seats and rear defrost activate automatically when it cold.
**Rear Defrost

***Parking Lights The parking Lights at remote start only.

MANDATORY INSTALL

*HOOD PIN



HOOD STATUS: THE HOOD PIN SWITCH MUST BE INSTALLED IF THE VEHICLE CAN BE REMOTE STARTED WITH THE HOOD OPEN, SET FUNCTION A11 TO OFF.

A11

OFF

Notice: the installation of safety elements are mandatory. The hood pin is an essential security element and must be installed.

THIS MODULE MUST BE INSTALLED BY A QUALIFIED TECHNICIAN. A WRONG CONNECTION CAN CAUSE PERMANENT DAMAGE TO THE VEHICLE.

DESCRIPTION

	Parts required (Not included)	PAGE
--	-------------------------------	------

WIRE TO WIRE DIAGRAM

AUTOMATIC TRANSMISSION	1x 7.5 Amp. fuse	Page 3
------------------------	------------------	--------

THARNESSE DIAGRAM

THARNESSE THAR-FOR3 AUTOMATIC TRANSMISSION	1x THAR-FOR3	Page 4
--	--------------	--------



② Parking Lights switch

① Gateway module, located at right of steering column.

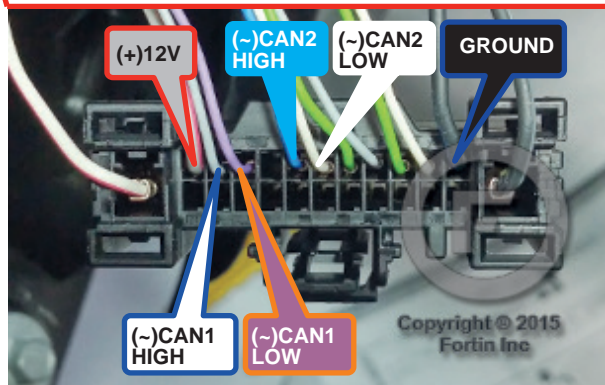
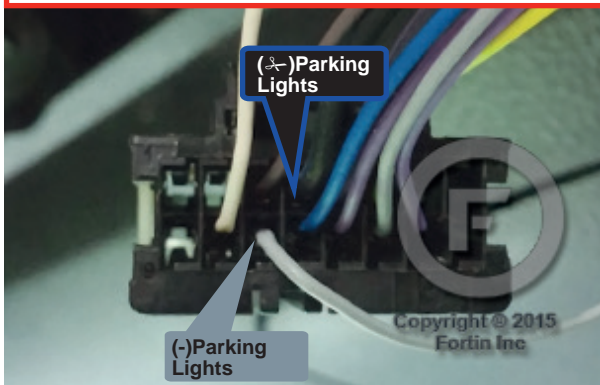

AUTOMATIC TRANSMISSION WIRING CONNECTION |

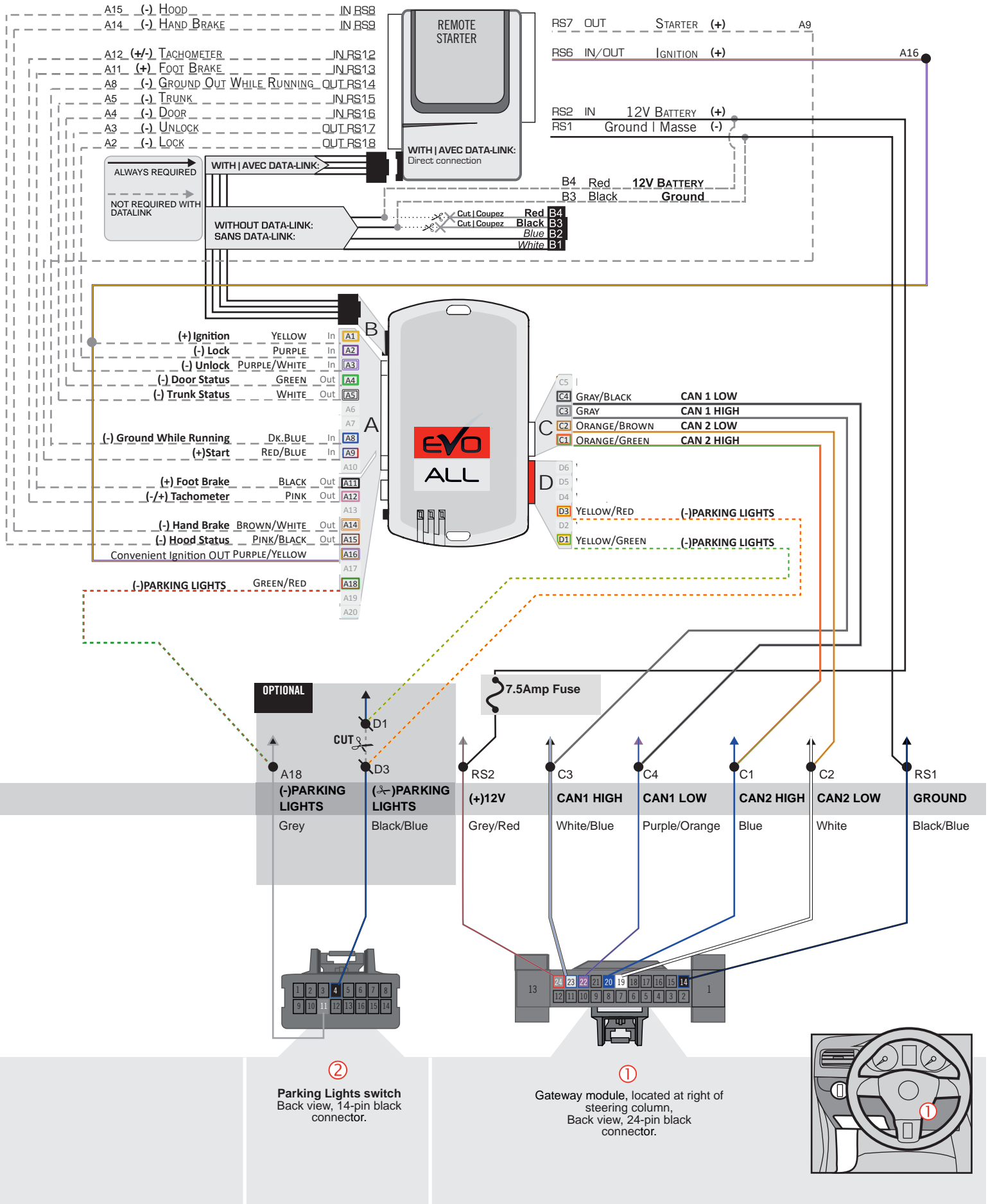

② Parking Lights switch
Back view, 14-pin black connector.

① Gateway module, located at right of steering column, Back view, 24-pin black connector.

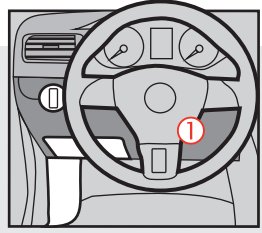

THAR-FOR3 | T-HARNESS - AUTOMATIC TRANSMISSION |

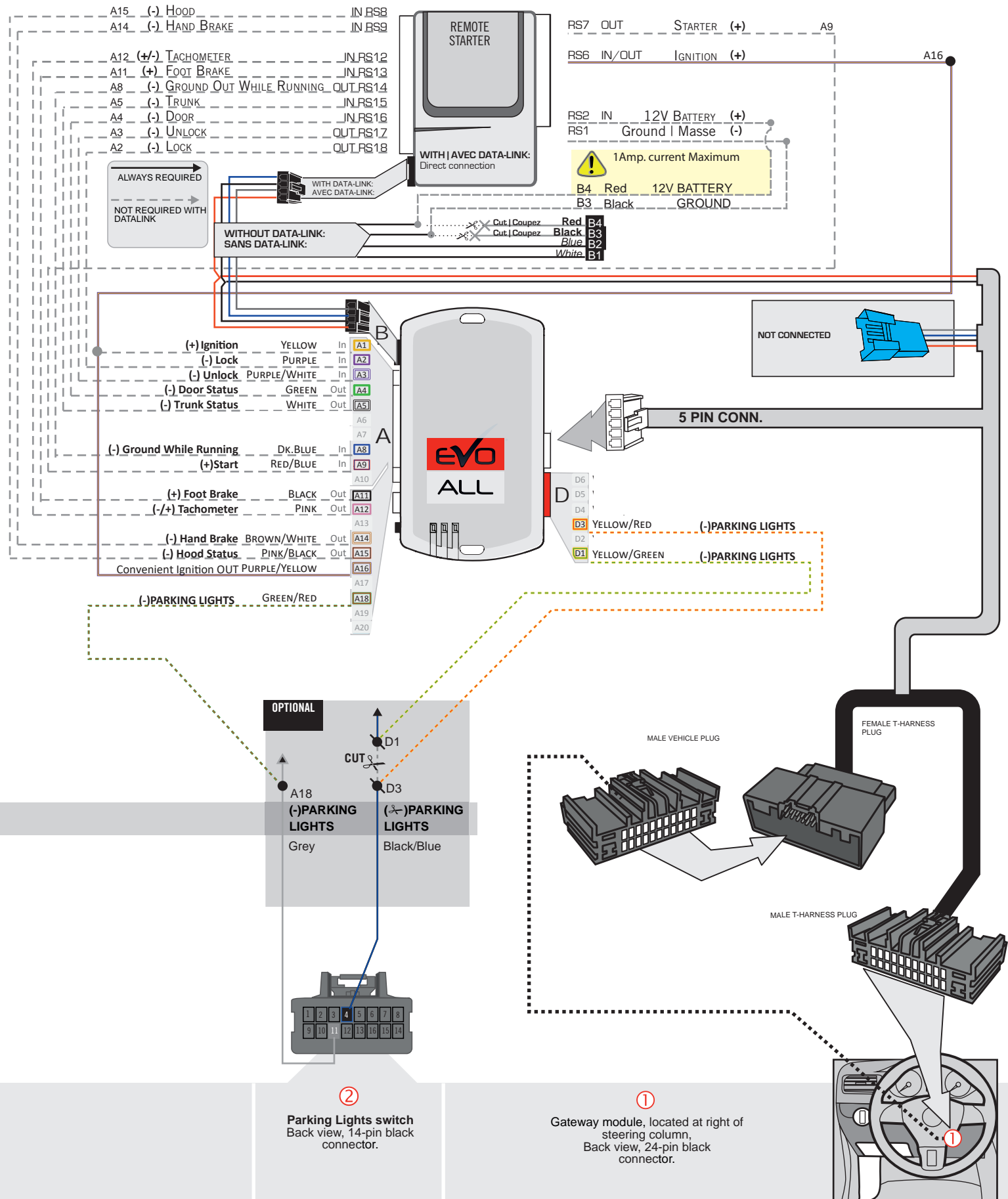



Parts required (not included)

- 1x FLASH LINK UPDATER, SOFTWARE | PROGRAMME
- 1x FLASH LINK MANAGER
- 1x Microsoft Windows Computer with Internet connection

OR

- 1x FLASH LINK MOBILE
- 1x FLASH LINK MOBILE APP
- Smartphone Android or iOS with Internet connection (Internet provider charges may apply)

BEFORE PROGRAMMING SET THE UNIT OPTIONS AND SAVE.

1

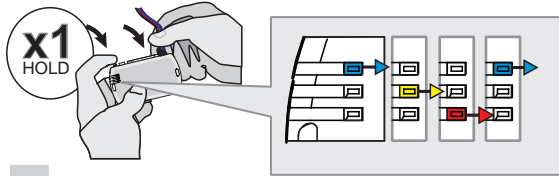

Press and hold the programming button:
Insert the 4-Pin (Data-Link) connector.

↳ The Blue, Red, Yellow and Blue & Red LEDs will alternatively illuminate.

2

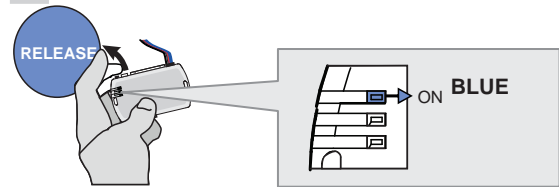

Release the programming button when the LED is BLUE.

If the LED is not solid BLUE disconnect the 4-Pin connector (Data-Link) and go back to step 1.

3

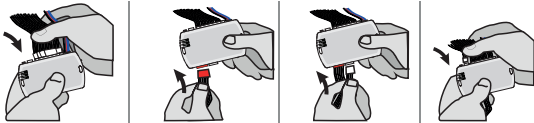

Insert the required remaining connectors.

4

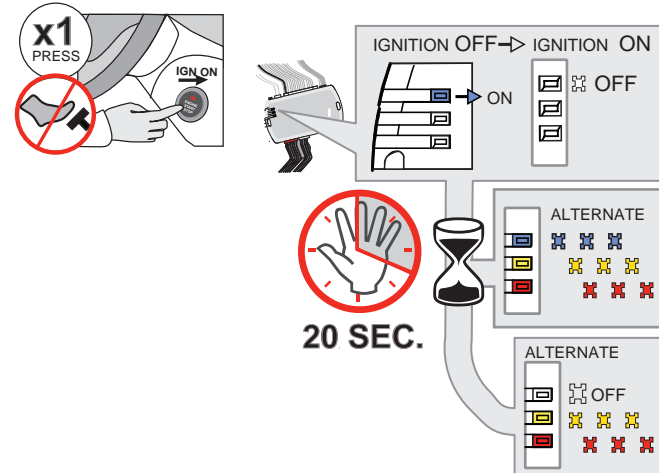

Do not press the brake pedal.
Press the Push-to-Start button once to turn on the ignition.

↳ The BLUE LED will turn OFF.

↳ The BLUE, YELLOW and RED LEDs will alternate.

Wait, at least 20 seconds, do not disconnect the modules or turn off the ignition.

↳ The RED and YELLOW LEDs will alternate.

Make sure that the DELs are flashing RED and YELLOW before continuing programming.



5

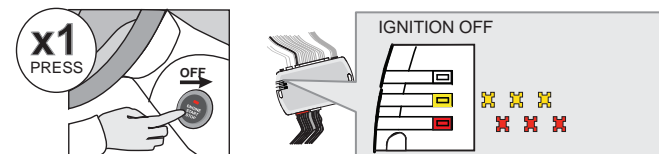

Press the Push-to-Start button once to turn off the ignition.

↳ The RED and YELLOW LEDs alternate.

KEY BYPASS PROGRAMMING PROCEDURE 2/2

6

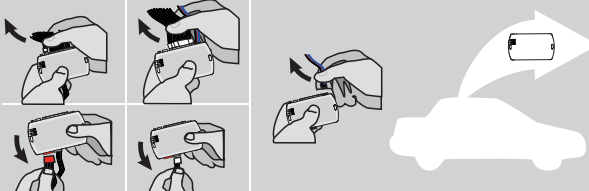

Disconnect all the connectors and after the Data-Link (4-pins) connector.

7



Microsoft Windows Computer with Internet connection*

FLASH LINK UPDATER* **FLASH LINK MANAGER***
SOFTWARE | PROGRAMME

OR

Smartphone* (Internet provider charges may apply)

FLASH LINK MOBILE*

VEHICLE'S OBDII CONNECTOR

Use the tool: FLASH LINK UPDATER or FLASH LINK MOBILE to visit the DCRYPTOR menu.

*Parts required (not included)

8

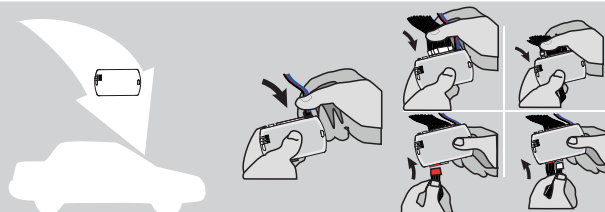

AFTER DCRYPTOR PROGRAMMING COMPLETED
Go back to the vehicle and reconnect the 4-Pin (Data-Link) connector and after, all the remaining connector.

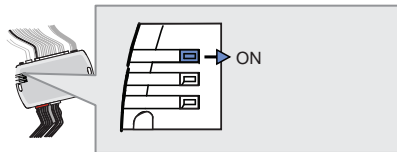

↳ The BLUE LED will turn ON.

9

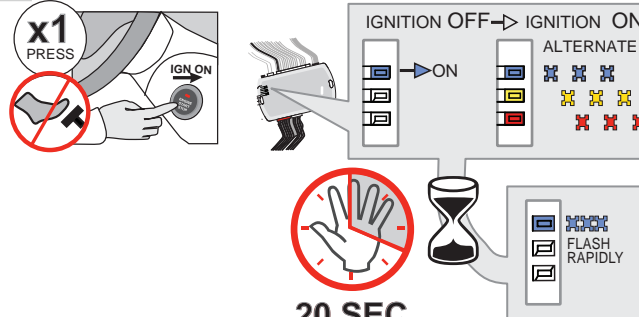

x1 PRESS (with a 'no brake pedal' symbol)

IGNITION OFF → IGNITION ON

ALTERNATE

↳ The RED and YELLOW LEDs will turn ON.

Wait, at least 20 seconds, do not disconnect the modules or turn off the ignition.

↳ The BLUE LED will flash rapidly.

20 SEC.

FLASH RAPIDLY

10

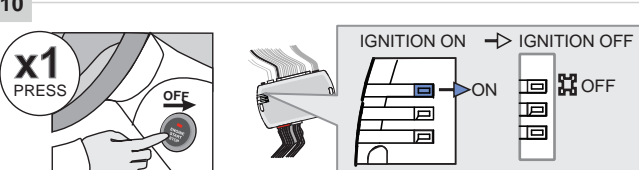

x1 PRESS (with a 'no brake pedal' symbol)

IGNITION ON → IGNITION OFF





OFF

↳ The BLUE will turn OFF.

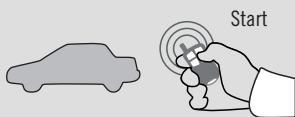

The module is now programmed.

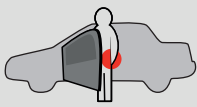
REMOTE STARTER FUNCTIONALITY |

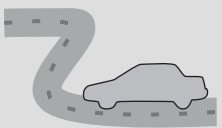
 <p>Start</p> <p>All doors must be closed.</p> <p>Remote start the vehicle.</p>	 <p>UNLOCK</p> <p>Unlock the doors with either:</p> <ul style="list-style-type: none"> • The OEM remote • The remote-starter remote • Or the proximity remote 	 <p>Enter the vehicle with the SMART-KEY.</p>	 <p>DO NOT PRESS THE BRAKE PEDAL.</p> <p>Press and release the Push-to-Start button once.</p>	 <p>Press the brake pedal. The vehicle can now be put in to gear and driven.</p> <p>If the Smart-Key is not detected the vehicle will shut down.</p>
--	---	--	---	---

REGULAR & THAR-FOR3 INSTALLATION

ADDENDUM - SUGGESTED WIRING CONFIGURATION



Vehicle functions supported in this diagram (functional if equipped)

VEHICLE	YEARS	Immobilizer bypass	Lock	Unlock	Arm	Disarm	Heated Seats**	Rear Defrost**	RAP Disable	Parking Lights***	Tachometer	Door Status	Trunk Status	Hood Status*	Hand-Brake Status	Foot-Brake Status	Active OEM Remote Start
FORD Escape	Key 2020	•	•	•	•	•	•	•	•	•	•	•	•	•	•	•	•

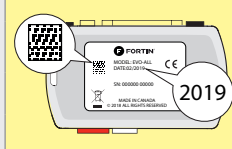

COMPATIBLE MODULE REQUIRED:

QR CODE ON THE LABEL
MANUFACTURED AFTER: 2019

FIRMWARE VERSION
58.[02]
MINIMUM

To add the firmware version and the options, use the **FLASH LINK UPDATER** or **FLASH LINK MOBILE** tool, sold separately.



Program bypass option:

UNIT OPTION

DESCRIPTION

C1

OEM Remote status (Lock/Unlock) monitoring

IF THE VEHICLE IS NOT EQUIPPED WITH FUNCTIONAL HOOD PIN:

A11

OFF

Hood trigger (Output Status).

NOTES

The vehicles OEM remote and SmartKey are still operable during remote start.

**Heated seats The heated seats and rear defrost activate automatically when it cold.

***Parking Lights The parking Lights at remote start only.



The vehicle must be equipped with the OEM remote with the door locks.

MANDATORY INSTALL

*HOOD PIN



HOOD STATUS: THE HOOD PIN SWITCH MUST BE INSTALLED IF THE VEHICLE CAN BE REMOTE STARTED WITH THE HOOD OPEN, SET FUNCTION A11 TO OFF.

A11

OFF

Notice: the installation of safety elements are mandatory. The hood pin is an essential security element and must be installed.

THIS MODULE MUST BE INSTALLED BY A QUALIFIED TECHNICIAN. A WRONG CONNECTION CAN CAUSE PERMANENT DAMAGE TO THE VEHICLE.

DESCRIPTION

	Parts required (Not included)	PAGE
--	-------------------------------	------

WIRE TO WIRE DIAGRAM

AUTOMATIC TRANSMISSION	1x 7.5 Amp. fuse	Page 3
------------------------	------------------	--------

THARNES DIAGRAM

THARNES THAR-FOR3 AUTOMATIC TRANSMISSION	1x THAR-FOR3	Page 4
--	--------------	--------



① Gateway module, Behind OBD-II connector

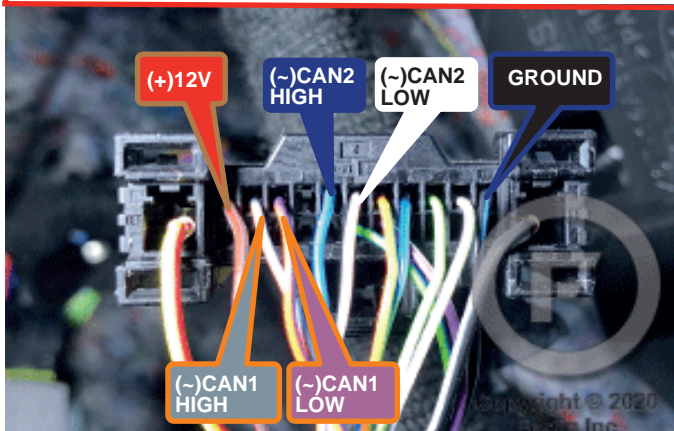

AUTOMATIC TRANSMISSION WIRING CONNECTION |

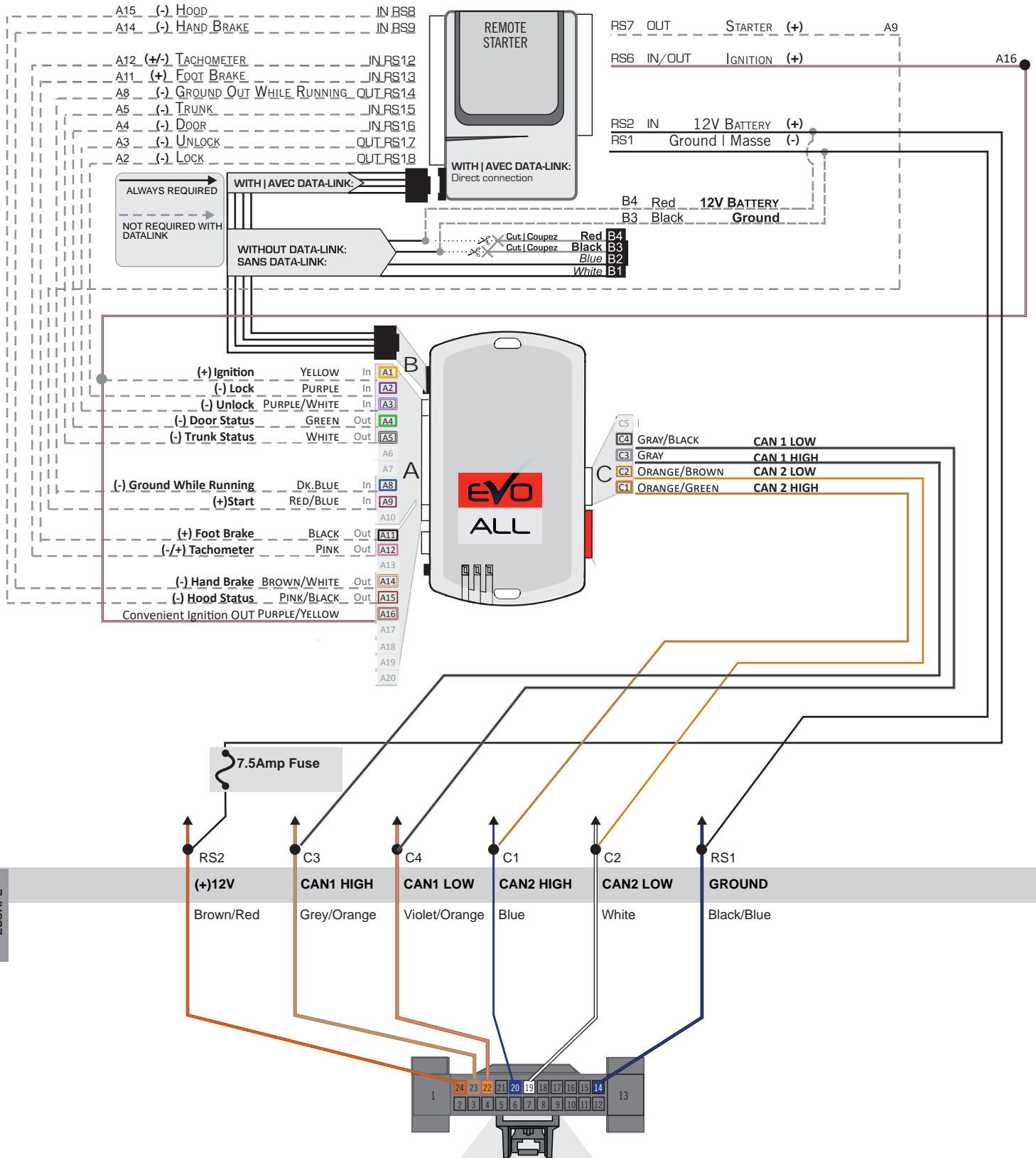

① Gateway module, Connector Behind OBD-II connector - located at dash board driver's side
 Back view, 24-pin black connector.

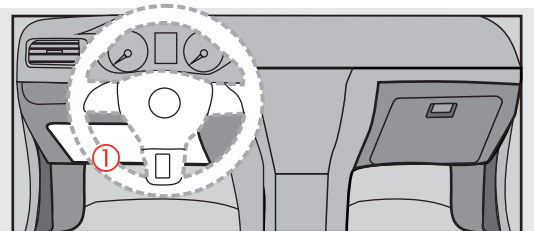

ESCAPE

THAR-FOR3 | T-HARNESS - AUTOMATIC TRANSMISSION |

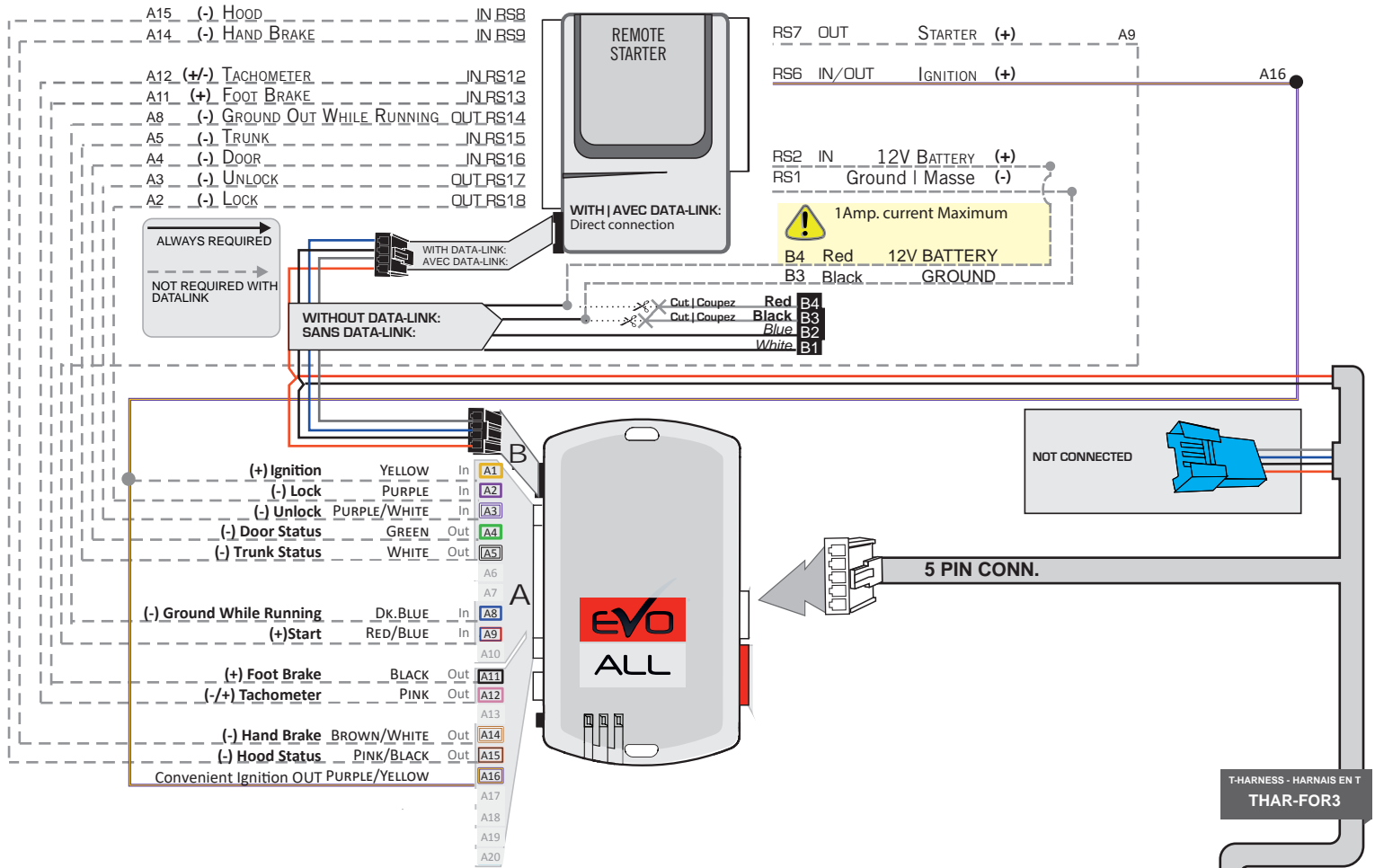

ESCAPE

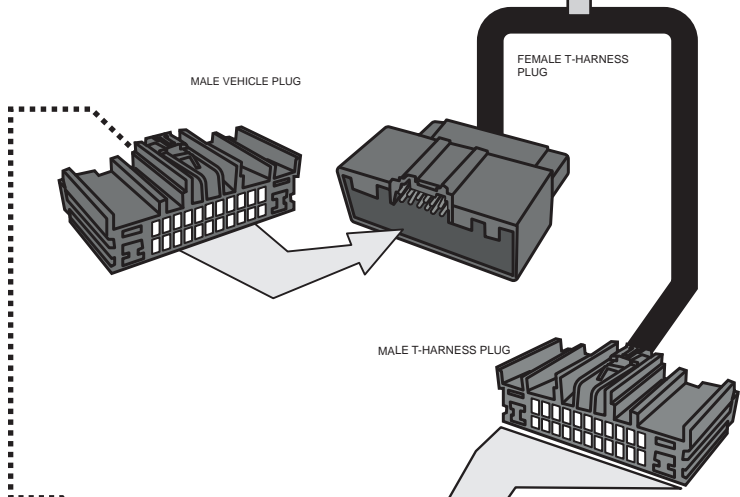

① Gateway module, Connector Behind OBD-II connector - located at dash board driver's side Back view, 24-pin black connector.

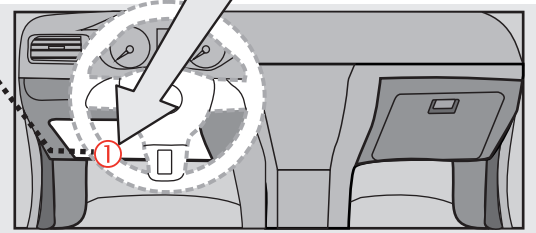



Parts required (not included)

- 1x FLASH LINK UPDATER, SOFTWARE | PROGRAMME
- 1x FLASH LINK MANAGER
- 1x Microsoft Windows Computer with Internet connection

OR

- 1x FLASH LINK MOBILE
- 1x FLASH LINK MOBILE APP
- Smartphone Android or iOS with Internet connection (Internet provider charges may apply)

BEFORE PROGRAMMING SET THE UNIT OPTIONS AND SAVE.

1

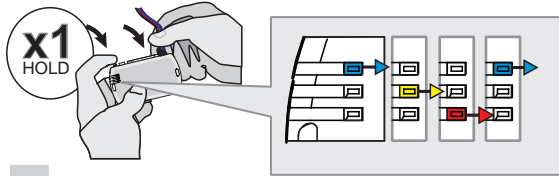

Press and hold the programming button:
Insert the 4-Pin (Data-Link) connector.

↳ The Blue, Red, Yellow and Blue & Red LEDs will alternatively illuminate.

2

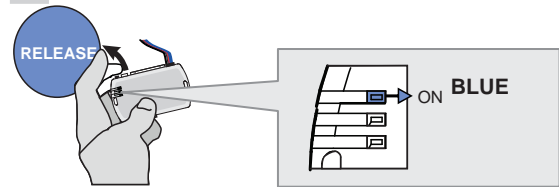

Release the programming button when the LED is BLUE.

If the LED is not solid BLUE disconnect the 4-Pin connector (Data-Link) and go back to step 1.

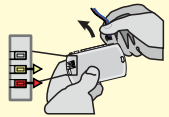

3

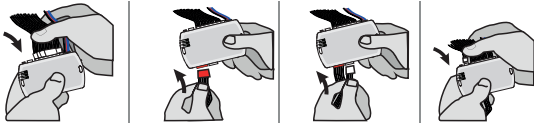

Insert the required remaining connectors.

4

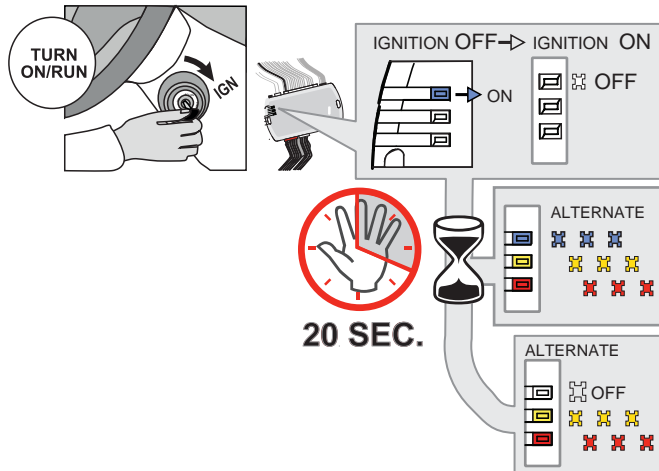

Turn the key to the Ignition ON/RUN position.

↳ The BLUE LED will turn OFF.

↳ The BLUE, YELLOW and RED LEDs will alternate.

Wait, at least 20 seconds, do not disconnect the modules or turn off the ignition.

↳ The RED and YELLOW LEDs will alternate.

Make sure that the DELs are flashing RED and YELLOW before continuing programming.

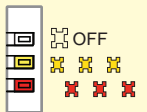

5

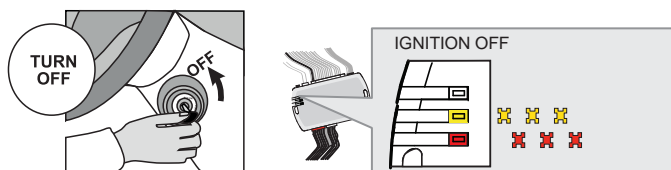

Turn the key to the OFF position.

↳ The RED and YELLOW LEDs alternate.

KEY BYPASS PROGRAMMING PROCEDURE 2/2 |

6

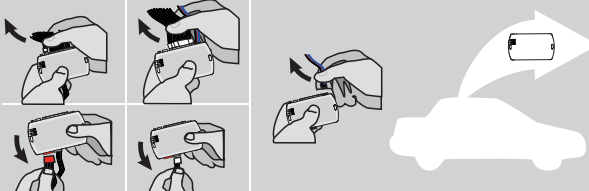

Disconnect all the connectors and after the Data-Link (4-pins) connector.

7



Microsoft Windows Computer with Internet connection*

FLASH LINK UPDATER* **FLASH LINK MANAGER***
SOFTWARE | PROGRAMME

OR

Smartphone* (Internet provider charges may apply)

FLASH LINK MOBILE*

VEHICLE'S OBDII CONNECTOR

Use the tool: FLASH LINK UPDATER or FLASH LINK MOBILE to visit the DCRYPTOR menu.

*Parts required (not included)

8

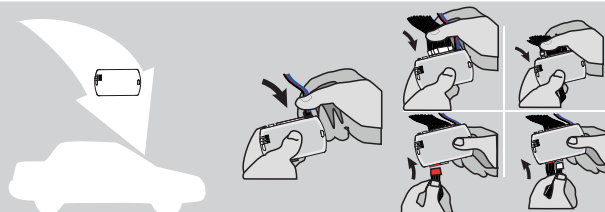

AFTER DCRYPTOR PROGRAMMING COMPLETED
Go back to the vehicle and reconnect the 4-Pin (Data-Link) connector and after, all the remaining connector.



↳ The BLUE LED will turn ON.

9

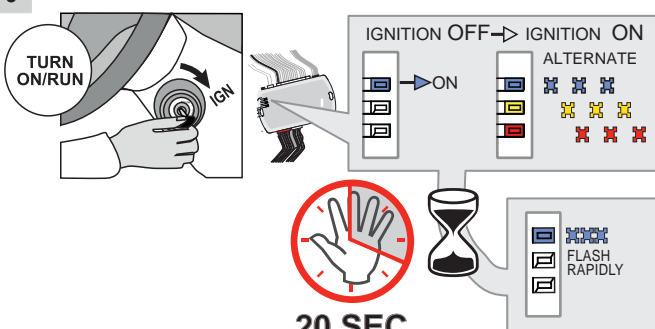

TURN ON/RUN

IGNITION OFF → IGNITION ON

ALTERNATE

↳ The RED and YELLOW LEDs will turn ON.

Wait, at least 20 seconds, do not disconnect the modules or turn off the ignition.

↳ The BLUE LED will flash rapidly.

20 SEC.

FLASH RAPIDLY

10

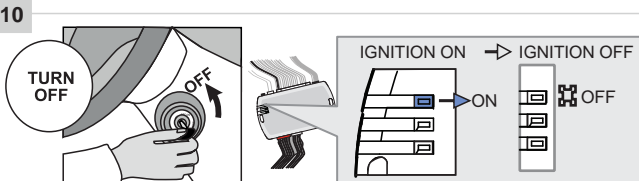

TURN OFF

IGNITION ON → IGNITION OFF

↳ The BLUE will turn OFF.



The module is now programmed.

REMOTE STARTER FUNCTIONALITY |



All doors must be closed.



Remote start the vehicle.



Unlock the doors with the remote-starter remote or the OEM remote.



Insert and Turn the key to the Ignition ON/RUN position.



Press the brake pedal.



The vehicle can now be put in to gear and driven.

REGULAR & THAR-FOR3 INSTALLATION

ADDENDUM - SUGGESTED WIRING CONFIGURATION



ONLY COMPATIBLE WITH AUTOMATIC TRANSMISSION VEHICLES.

Vehicle functions supported in this diagram (functional if equipped)

VEHICLE	YEARS	Immobilizer bypass	Lock	Unlock	Arm	Disarm	Heated Seats**	Rear Defrost**	RAP Disable	Parking Lights***	Tachometer	Door Status	Trunk Status	Hood Status*	Hand-Brake Status	Foot-Brake Status	Active OEM Remote Start
FORD Escape	Push-to-Start 2020	•	•	•	•	•	•	•	•	•	•	•	•	•	•	•	•

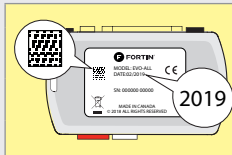

COMPATIBLE MODULE REQUIRED:

QR CODE ON THE LABEL
MANUFACTURED AFTER: 2019

FIRMWARE VERSION
58.[02]
MINIMUM

To add the firmware version and the options, use the **FLASH LINK UPDATER** or **FLASH LINK MOBILE** tool, sold separately.



Program bypass option:

UNIT OPTION

DESCRIPTION

C1

OEM Remote status (Lock/Unlock) monitoring

D6

Push-to-Start

IF THE VEHICLE IS NOT EQUIPPED WITH FUNCTIONAL HOOD PIN:

A11

OFF

Hood trigger (Output Status).

NOTES

The vehicles OEM remote and SmartKey are still operable during remote start.

**Heated seats The heated seats and rear defrost activate automatically when it cold.
**Rear Defrost

***Parking Lights The parking Lights at remote start only.

MANDATORY INSTALL

*HOOD PIN



HOOD STATUS: THE HOOD PIN SWITCH MUST BE INSTALLED IF THE VEHICLE CAN BE REMOTE STARTED WITH THE HOOD OPEN, SET FUNCTION A11 TO OFF.

A11

OFF

Notice: the installation of safety elements are mandatory. The hood pin is an essential security element and must be installed.

THIS MODULE MUST BE INSTALLED BY A QUALIFIED TECHNICIAN. A WRONG CONNECTION CAN CAUSE PERMANENT DAMAGE TO THE VEHICLE.

DESCRIPTION | DESCRIPTION

	Parts required (Not included)	PAGE
--	-------------------------------	------

WIRE TO WIRE DIAGRAM

AUTOMATIC TRANSMISSION	1x 7.5 Amp. fuse	Page 3
------------------------	------------------	--------

THARNES DIAGRAM

THARNES THAR-FOR3 AUTOMATIC TRANSMISSION	1x THAR-FOR3	Page 4
--	--------------	--------



① Gateway module, Behind OBD-II connector

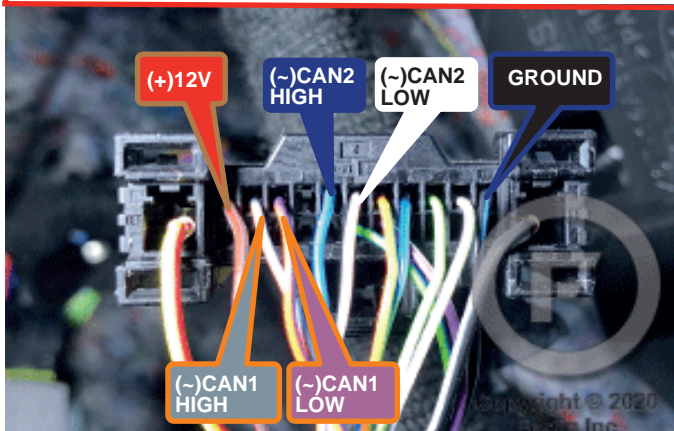

AUTOMATIC TRANSMISSION WIRING CONNECTION |

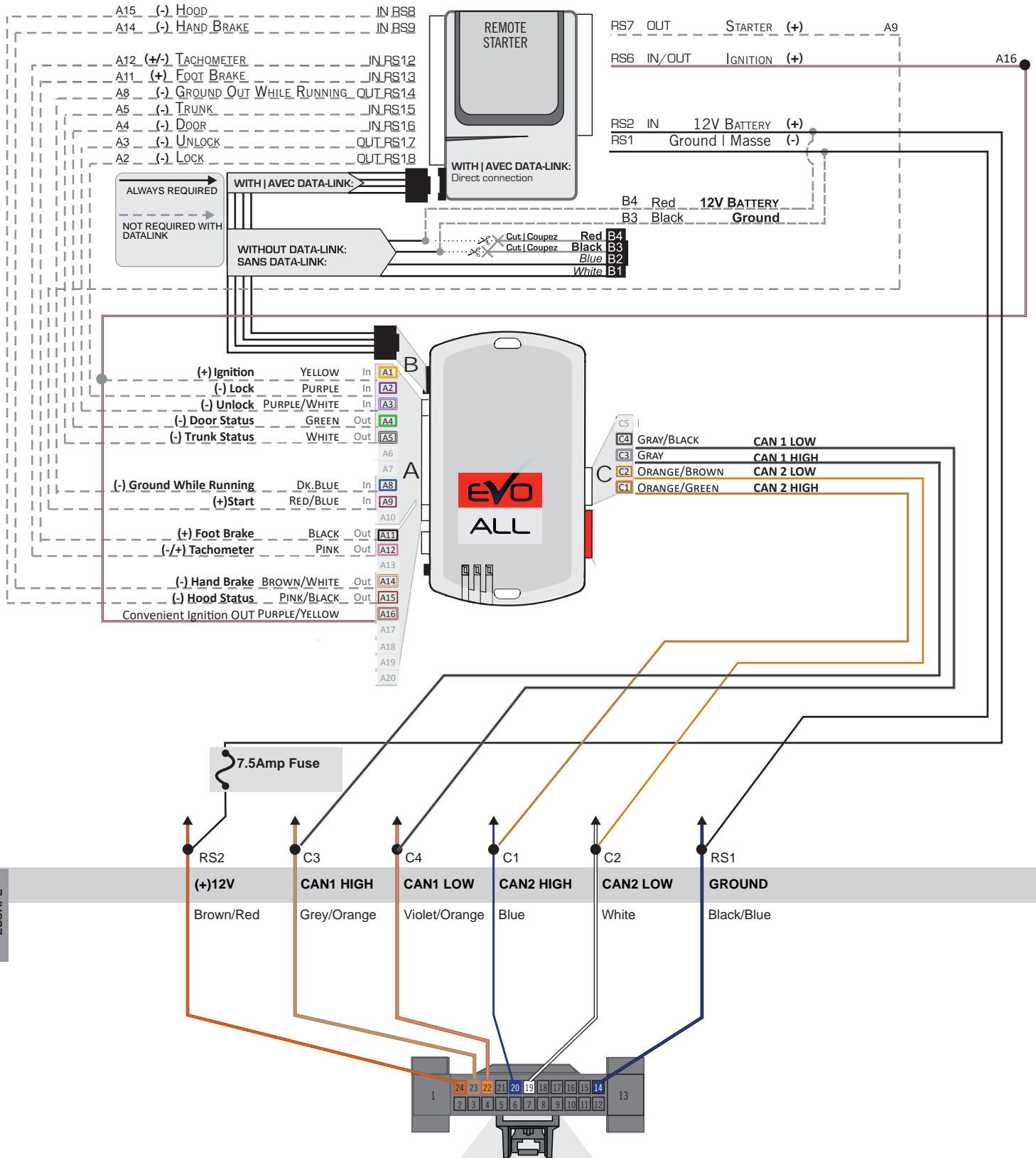

① Gateway module, Connector Behind OBD-II connector - located at dash board driver's side
 Back view, 24-pin black connector.

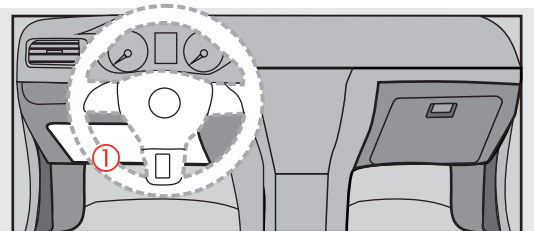

THAR-FOR3 | T-HARNESS - AUTOMATIC TRANSMISSION |

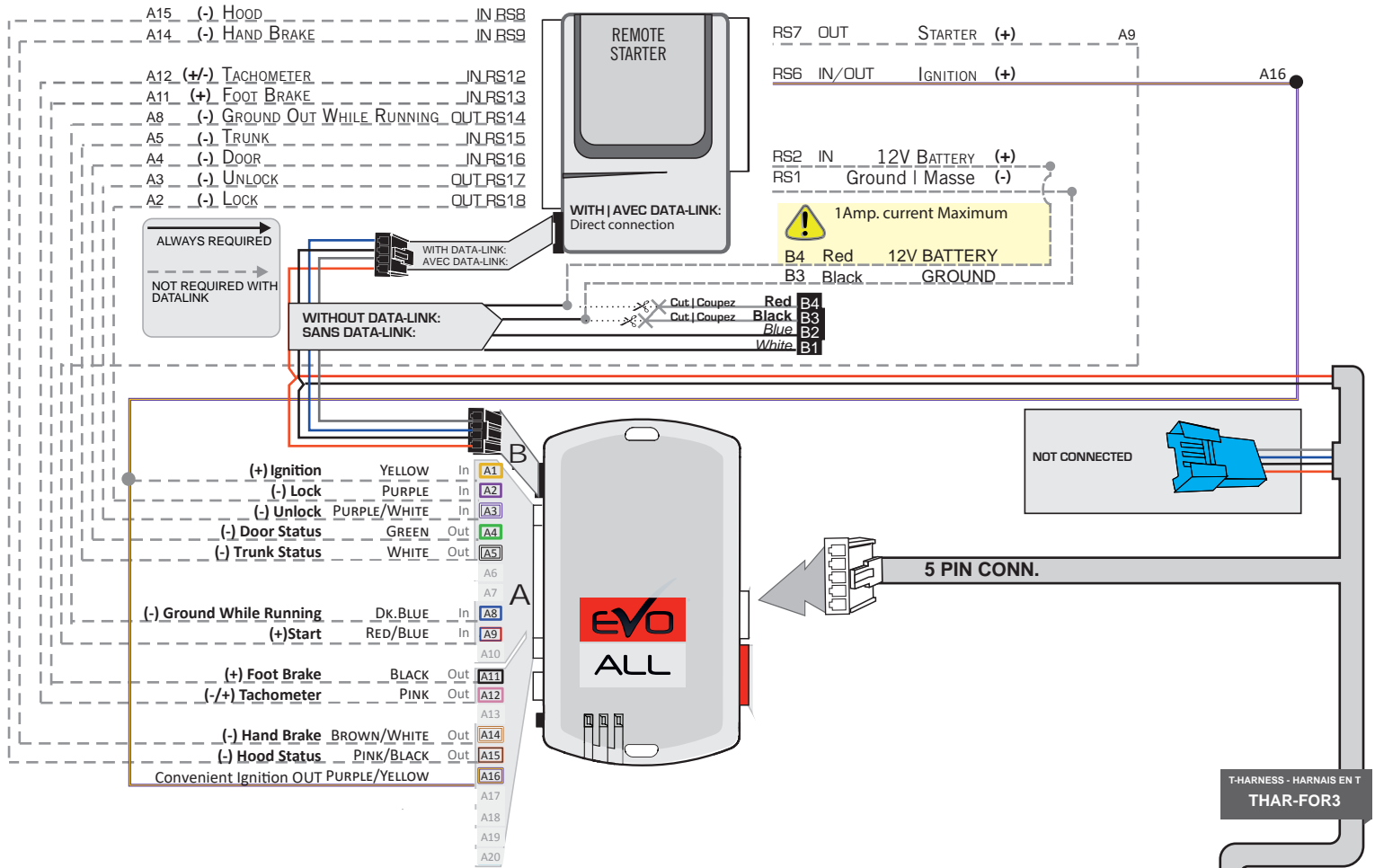

ESCAPE

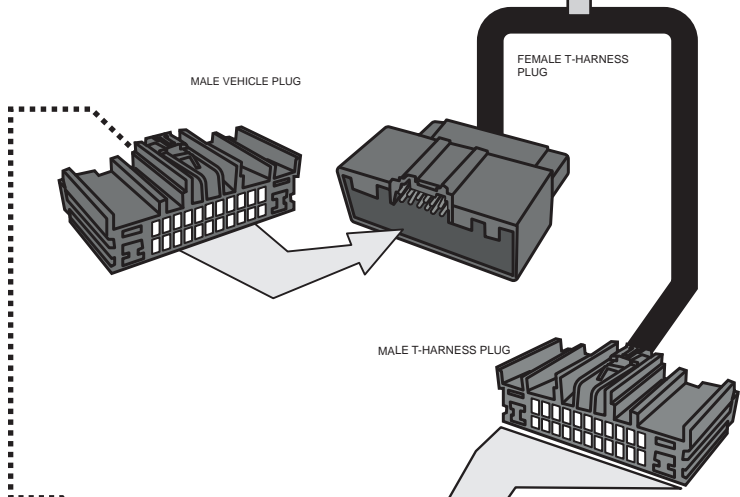

① Gateway module, Connector Behind OBD-II connector - located at dash board driver's side Back view, 24-pin black connector.

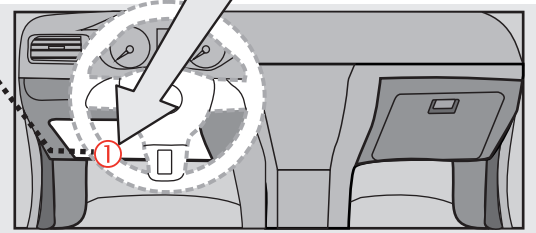



Parts required (not included)

- 1x FLASH LINK UPDATER, SOFTWARE | PROGRAMME
- 1x FLASH LINK MANAGER
- 1x Microsoft Windows Computer with Internet connection

OR

- 1x FLASH LINK MOBILE
- 1x FLASH LINK MOBILE APP
- Smartphone Android or iOS with Internet connection (Internet provider charges may apply)

BEFORE PROGRAMMING SET THE UNIT OPTIONS AND SAVE.

1

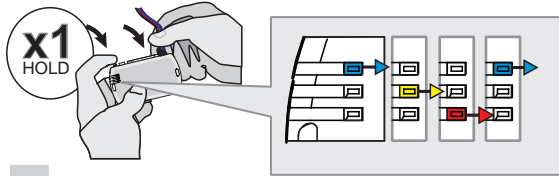

Press and hold the programming button:
Insert the 4-Pin (Data-Link) connector.

↳ The Blue, Red, Yellow and Blue & Red LEDs will alternatively illuminate.

2

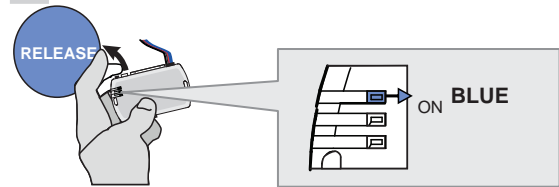

Release the programming button when the LED is BLUE.

If the LED is not solid BLUE disconnect the 4-Pin connector (Data-Link) and go back to step 1.

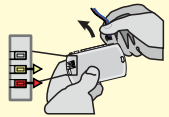

3

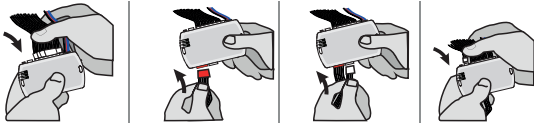

Insert the required remaining connectors.

4

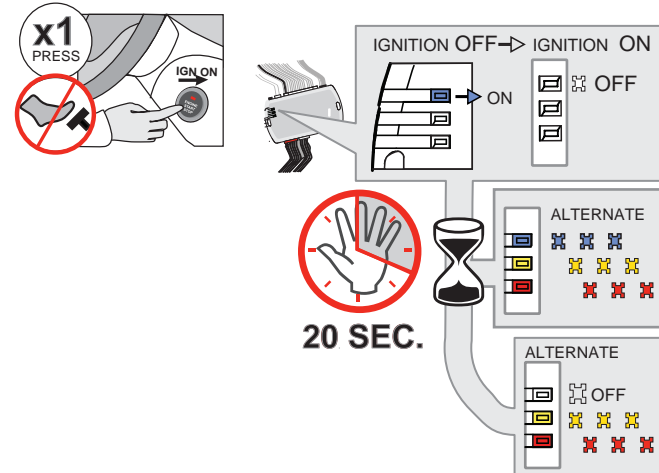

Do not press the brake pedal.
Press the Push-to-Start button once to turn on the ignition.

↳ The BLUE LED will turn OFF.

↳ The BLUE, YELLOW and RED LEDs will alternate.

Wait, at least 20 seconds, do not disconnect the modules or turn off the ignition.

↳ The RED and YELLOW LEDs will alternate.

Make sure that the DELs are flashing RED and YELLOW before continuing programming.

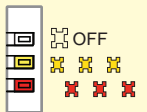

5

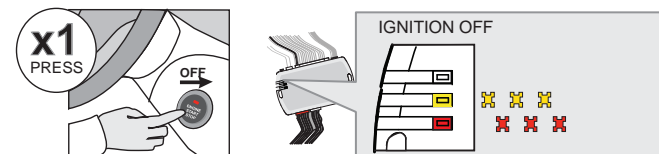

Press the Push-to-Start button once to turn off the ignition.

↳ The RED and YELLOW LEDs alternate.

KEY BYPASS PROGRAMMING PROCEDURE 2/2 |

6

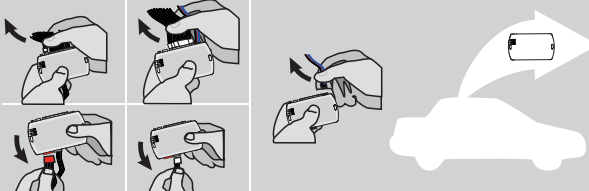

Disconnect all the connectors and after the Data-Link (4-pins) connector.

7



Microsoft Windows Computer with Internet connection*

FLASH LINK UPDATER* **FLASH LINK MANAGER***
SOFTWARE | PROGRAMME

OR

Smartphone* (Internet provider charges may apply)

FLASH LINK MOBILE*

VEHICLE'S OBDII CONNECTOR

Use the tool: FLASH LINK UPDATER or FLASH LINK MOBILE to visit the DCryptor menu.

*Parts required (not included)

8

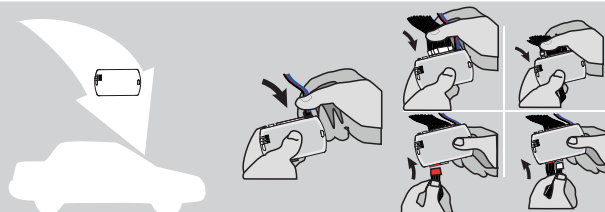

AFTER DCRYPTOR PROGRAMMING COMPLETED
Go back to the vehicle and reconnect the 4-Pin (Data-Link) connector and after, all the remaining connector.

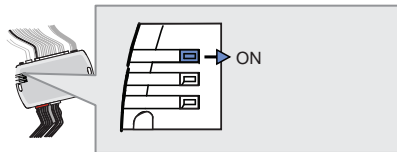

↳ The BLUE LED will turn ON.

9

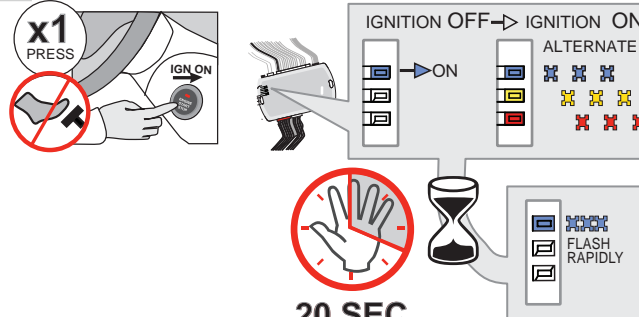

x1 PRESS (with a red 'X' over the push-to-start button)

IGNITION OFF → IGNITION ON

ALTERNATE

↳ The RED and YELLOW LEDs will turn ON.

20 SEC.

↳ The BLUE LED will flash rapidly.

Wait, at least 20 seconds, do not disconnect the modules or turn off the ignition.

10

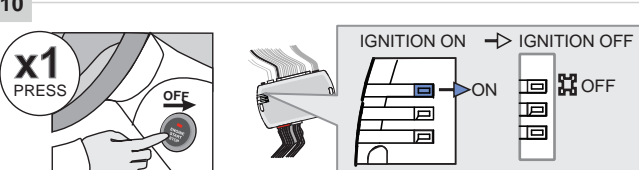

x1 PRESS (with a red 'X' over the push-to-start button)

IGNITION ON → IGNITION OFF





OFF

↳ The BLUE will turn OFF.

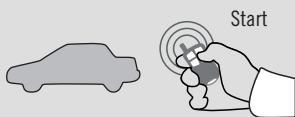

The module is now programmed.

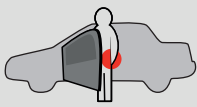
REMOTE STARTER FUNCTIONALITY |

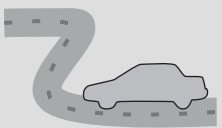
 <p>Start</p> <p>All doors must be closed.</p> <p>Remote start the vehicle.</p>	 <p>UNLOCK</p> <p>Unlock the doors with either:</p> <ul style="list-style-type: none"> • The OEM remote • The remote-starter remote • Or the proximity remote 	 <p>Enter the vehicle with the SMART-KEY.</p>	 <p>DO NOT PRESS THE BRAKE PEDAL.</p> <p>Press and release the Push-to-Start button once.</p>	 <p>Press the brake pedal. The vehicle can now be put in to gear and driven.</p> <p>If the Smart-Key is not detected the vehicle will shut down.</p>
--	---	--	---	---

REGULAR & THAR-FOR3 INSTALLATION

ADDENDUM - SUGGESTED WIRING CONFIGURATION



ONLY COMPATIBLE WITH AUTOMATIC TRANSMISSION VEHICLES.



Vehicle functions supported in this diagram (functional if equipped)

VEHICLE	YEARS	Immobilizer bypass	T-Harness available (sold separately)	Lock	Unlock	Arm	Disarm	Heated Seats**	Rear Defrost**	RAP Disable	Parking Lights***	Tachometer	Door Status	Trunk Status	Hood Status*	Hand-Brake Status	Foot-Brake Status	Active OEM Remote Start
FORD																		
Expedition	2018-2020	•	•	•	•	•	•	•	•	•	•	•	•	•	•	•	•	•

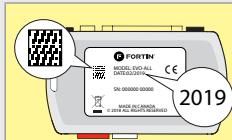

COMPATIBLE MODULE REQUIRED:

QR CODE ON THE LABEL
MANUFACTURED AFTER: 2019

FIRMWARE VERSION

58.[02]
MINIMUM

To add the firmware version and the options, use the **FLASH LINK UPDATER** or **FLASH LINK MOBILE** tool, sold separately.



Program bypass option:

UNIT OPTION

C1

DESCRIPTION

OEM Remote status (Lock/Unlock) monitoring

IF THE VEHICLE IS NOT EQUIPPED WITH FUNCTIONAL HOOD PIN:

A11

OFF

Hood trigger (Output Status).

NOTES

The vehicles OEM remote and SmartKey are still operable during remote start.

**Heated seats The heated seats and rear defrost activate automatically when it cold.

***Parking Lights The parking Lights at remote start only.



The vehicle must be equipped with the OEM remote with the door locks. avec le verrouillage des portes.

MANDATORY INSTALL

*HOOD PIN



HOOD STATUS: THE HOOD PIN SWITCH MUST BE INSTALLED IF THE VEHICLE CAN BE REMOTE STARTED WITH THE HOOD OPEN, SET FUNCTION A11 TO OFF.

A11

OFF

Notice: the installation of safety elements are mandatory. The hood pin is an essential security element and must be installed.

THIS MODULE MUST BE INSTALLED BY A QUALIFIED TECHNICIAN. A WRONG CONNECTION CAN CAUSE PERMANENT DAMAGE TO THE VEHICLE.

DESCRIPTION |

	Parts required (Not included)	PAGE
--	-------------------------------	------

WIRE TO WIRE DIAGRAM

AUTOMATIC TRANSMISSION	1x 7.5 Amp. fuse	Page 3
------------------------	------------------	--------

THARNES DIAGRAM

THARNES THAR-FOR3 AUTOMATIC TRANSMISSION	1x THAR-FOR3	Page 4
--	--------------	--------

EXPÉDITION



②

Parking Lights switch

①

Gateway module, Behind OBD-II connector

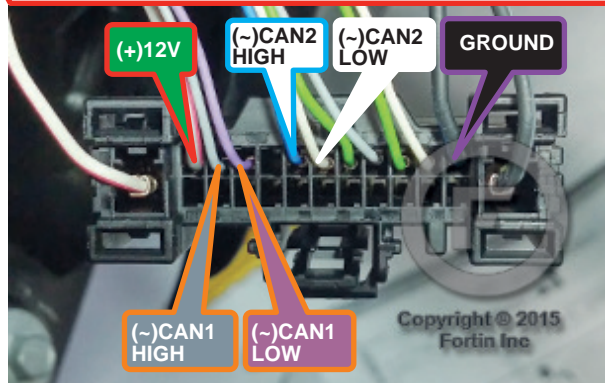
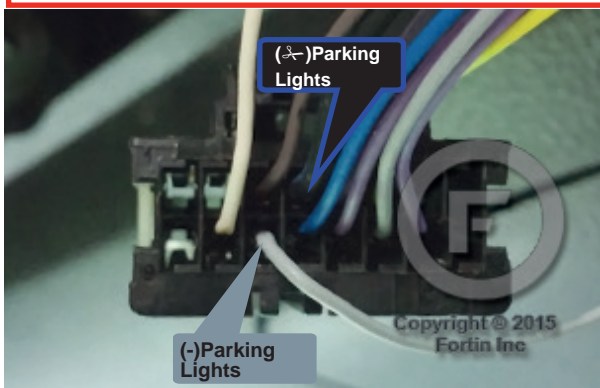

AUTOMATIC TRANSMISSION WIRING CONNECTION |

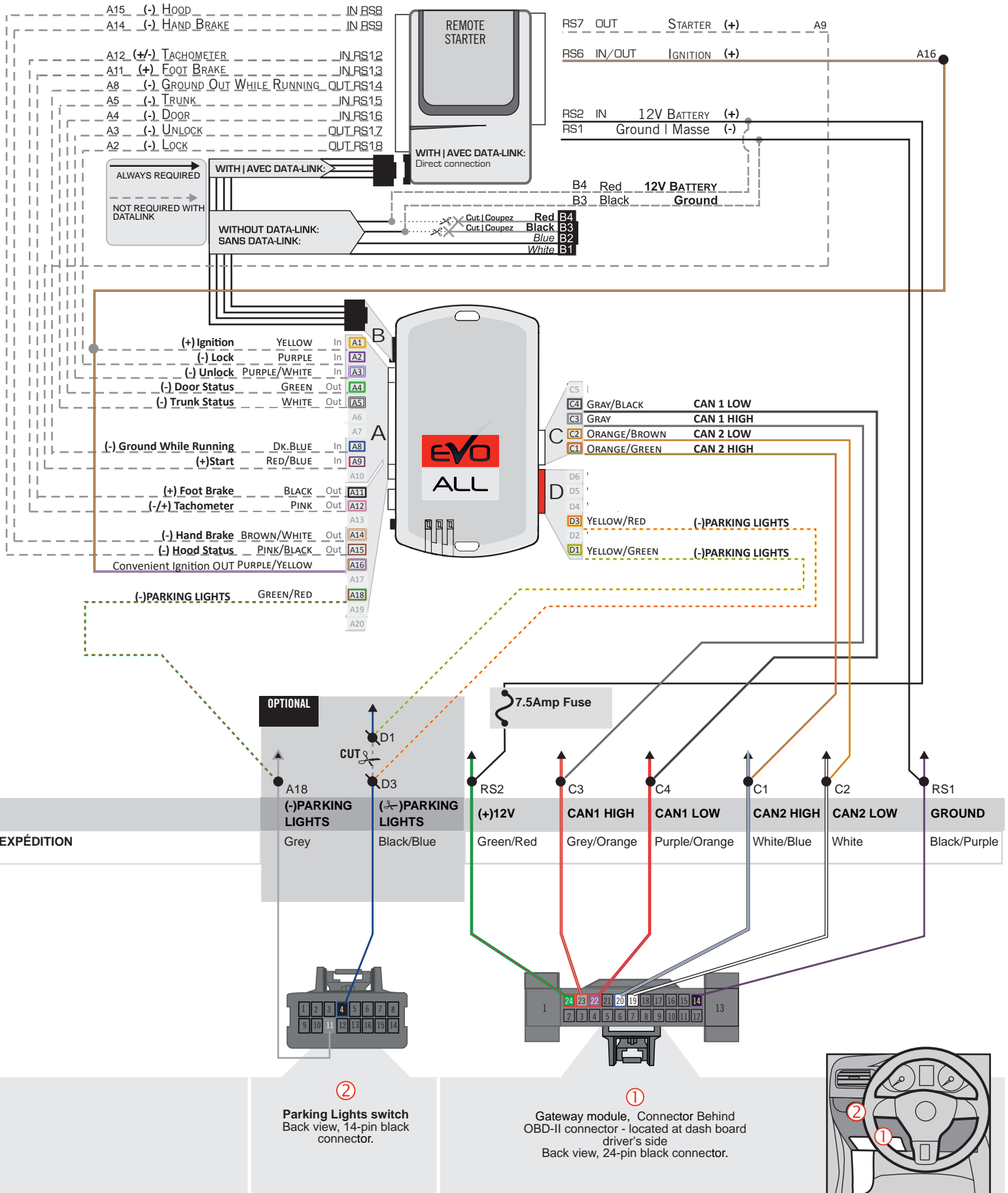

THAR-FOR3 | T-HARNESS - AUTOMATIC TRANSMISSION |

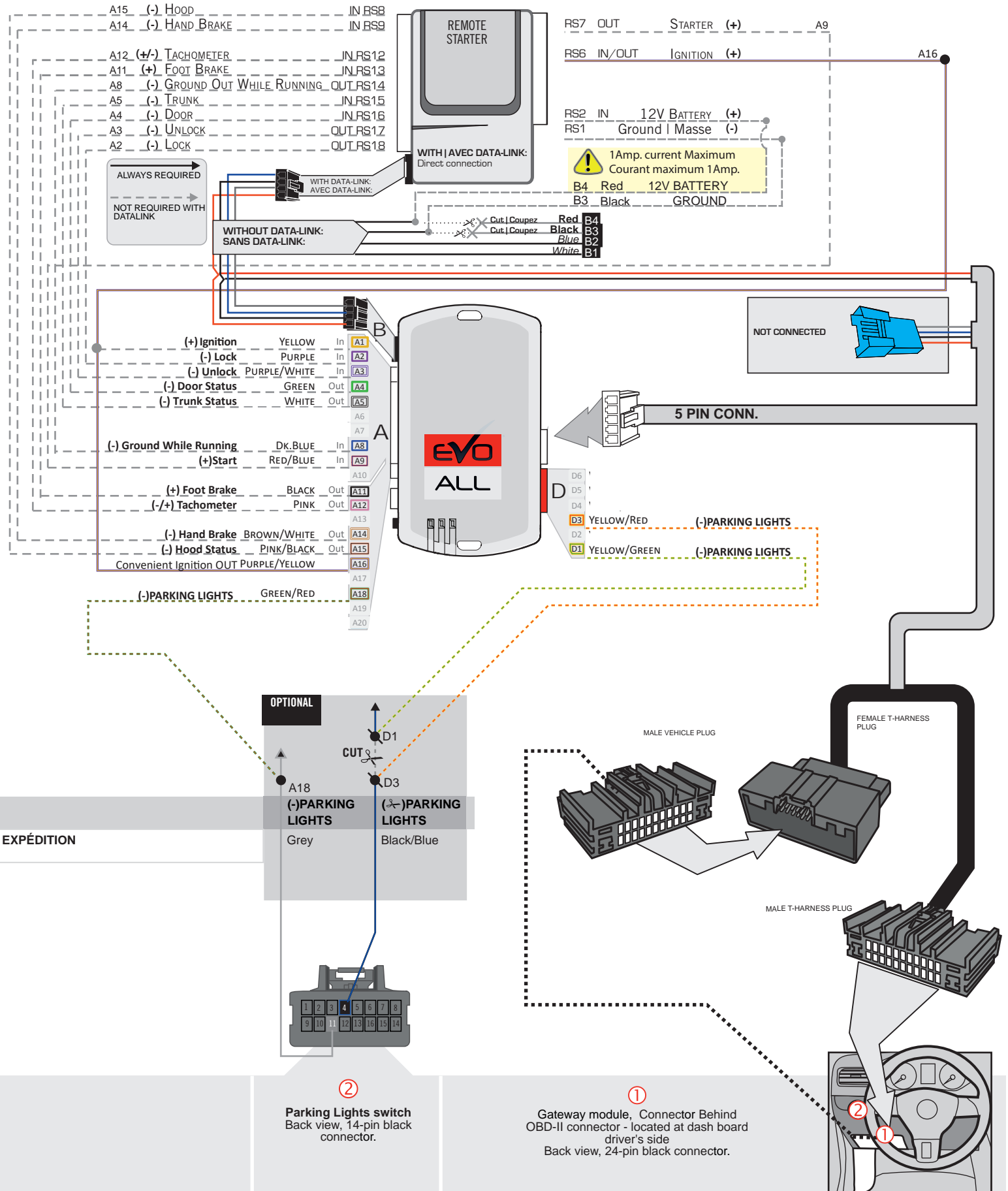



Parts required (not included)

- 1x FLASH LINK UPDATER, SOFTWARE | PROGRAMME
- 1x FLASH LINK MANAGER
- 1x Microsoft Windows Computer with Internet connection

OR

- 1x FLASH LINK MOBILE
- 1x FLASH LINK MOBILE APP
- Smartphone Android or iOS with Internet connection (Internet provider charges may apply)

BEFORE PROGRAMMING SET THE UNIT OPTIONS AND SAVE.

1

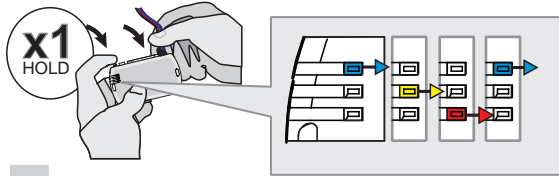

Press and hold the programming button:
Insert the 4-Pin (Data-Link) connector.

↳ The Blue, Red, Yellow and Blue & Red LEDs will alternatively illuminate.

2

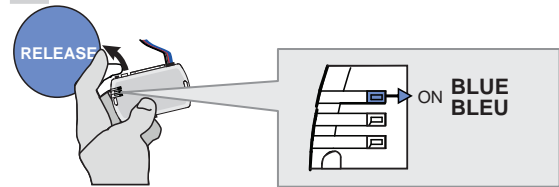

Release the programming button when the LED is BLUE.

If the LED is not solid BLUE disconnect the 4-Pin connector (Data-Link) and go back to step 1.

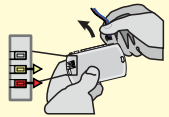

3

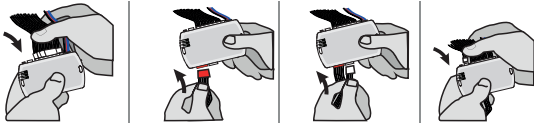

Insert the required remaining connectors.

4

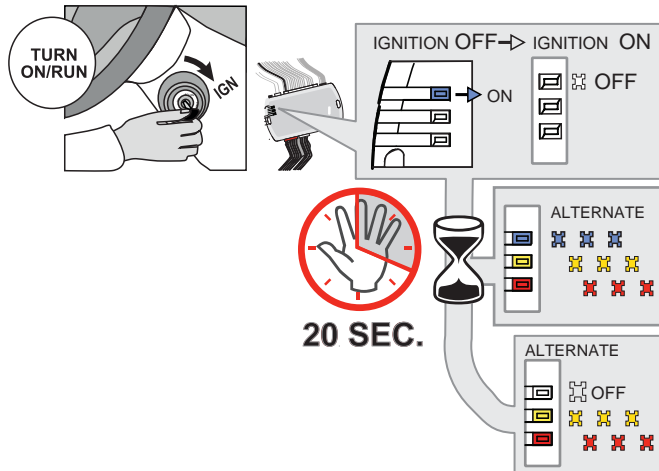

Turn the key to the Ignition ON/RUN position.

↳ The BLUE LED will turn OFF.

↳ The BLUE, YELLOW and RED LEDs will alternate.

Wait, at least 20 seconds, do not disconnect the modules or turn off the ignition.

↳ The RED and YELLOW LEDs will alternate.

Make sure that the DELs are flashing RED and YELLOW before continuing programming.

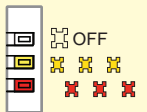

5

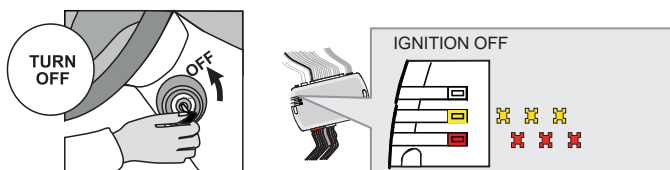

Turn the key to the OFF position.

↳ The RED and YELLOW LEDs alternate.

KEY BYPASS PROGRAMMING PROCEDURE 2/2 |

6

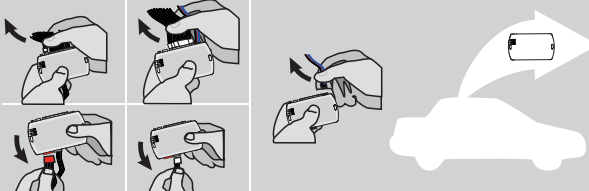

Disconnect all the connectors and after the Data-Link (4-pins) connector.

7



Microsoft Windows Computer with Internet connection*

FLASH LINK UPDATER* **FLASH LINK MANAGER***
SOFTWARE | PROGRAMME

OR

Smartphone* (Internet provider charges may apply)

FLASH LINK MOBILE*

VEHICLE'S OBDII CONNECTOR

Use the tool: FLASH LINK UPDATER or FLASH LINK MOBILE to visit the DCRYPTOR menu.

*Parts required (not included)

8

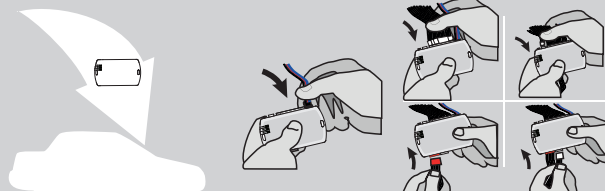

AFTER DCRYPTOR PROGRAMMING COMPLETED
Go back to the vehicle and reconnect the 4-Pin (Data-Link) connector and after, all the remaining connector.



↳ The **BLUE LED** will turn ON.

9

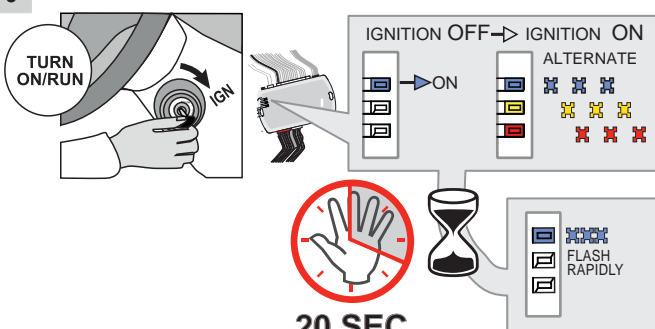

TURN ON/RUN

IGNITION OFF → IGNITION ON

ALTERNATE

↳ The **RED and YELLOW LEDs** will turn ON.

Wait, at least 20 seconds, do not disconnect the modules or turn off the ignition.

↳ The **BLUE LED** will flash rapidly.

20 SEC.

FLASH RAPIDLY

10

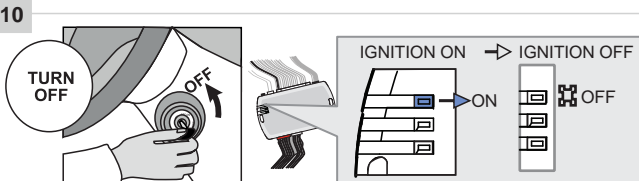

TURN OFF

IGNITION ON → IGNITION OFF

↳ The **BLUE** will turn OFF.



The module is now programmed.

REMOTE STARTER FUNCTIONALITY |



All doors must be closed.



Remote start the vehicle.



Unlock the doors with the remote-starter remote or the OEM remote.



Insert and Turn the key to the Ignition ON/RUN position.



Press the brake pedal.



The vehicle can now be put in to gear and driven.

REGULAR & THAR-FOR3 INSTALLATION

ADDENDUM - SUGGESTED WIRING CONFIGURATION



ONLY COMPATIBLE WITH AUTOMATIC TRANSMISSION VEHICLES.



Vehicle functions supported in this diagram (functional if equipped)

VEHICLE	YEARS	Immobilizer bypass	T-Harness available (sold separately)	Lock	Unlock	Arm	Disarm	Heated Seats**	Rear Defrost**	RAP Disable	Parking Lights***	Tachometer	Door Status	Trunk Status	Hood Status*	Hand-Brake Status	Foot-Brake Status	Active OEM Remote Start	
FORD																			
Expedition	Push-to-Start 2018-2020	•	•	•	•	•	•	•	•	•	•	•	•	•	•	•	•	•	•

	COMPATIBLE MODULE REQUIRED:	QR CODE ON THE LABEL MANUFACTURED AFTER: 2019	FIRMWARE VERSION 58.[02] MINIMUM	To add the firmware version and the options, use the FLASH LINK UPDATER or FLASH LINK MOBILE tool, sold separately.
		2019		

	Program bypass option:	UNIT OPTION	DESCRIPTION
		C1	OEM Remote status (Lock/Unlock) monitoring
		D6	Push-to-Start
IF THE VEHICLE IS NOT EQUIPPED WITH FUNCTIONAL HOOD PIN:		A11	OFF Hood trigger (Output Status).

NOTES

The vehicles OEM remote and SmartKey are still operable during remote start.

**Heated seats The heated seats and rear defrost activate automatically when it cold.

**Rear Defrost

***Parking Lights The parking Lights at remote start only.

MANDATORY INSTALL

***HOOD PIN** **HOOD STATUS:** THE HOOD PIN SWITCH MUST BE INSTALLED IF THE VEHICLE CAN BE REMOTE STARTED WITH THE HOOD OPEN, SET FUNCTION A11 TO OFF.

A11 **OFF**

Notice: the installation of safety elements are mandatory. The hood pin is an essential security element and must be installed.

THIS MODULE MUST BE INSTALLED BY A QUALIFIED TECHNICIAN. A WRONG CONNECTION CAN CAUSE PERMANENT DAMAGE TO THE VEHICLE.

DESCRIPTION

	Parts required (Not included)	PAGE
--	-------------------------------	------

WIRE TO WIRE DIAGRAM

AUTOMATIC TRANSMISSION	1x 7.5 Amp. fuse	Page 3
------------------------	------------------	--------

THARNESSE DIAGRAM

THARNESSE THAR-FOR3 AUTOMATIC TRANSMISSION	1x THAR-FOR3	Page 4
--	--------------	--------

EXPÉDITION



②

Parking Lights switch

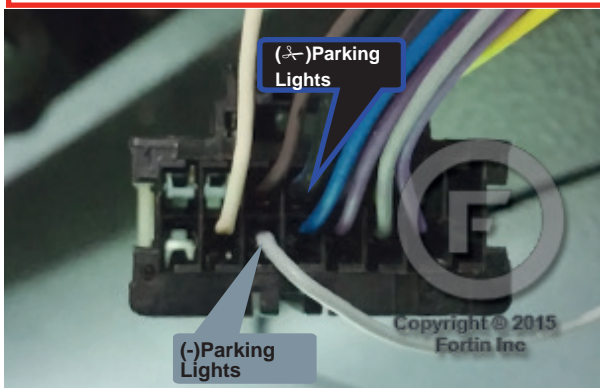

①

Gateway module, Behind OBD-II connector

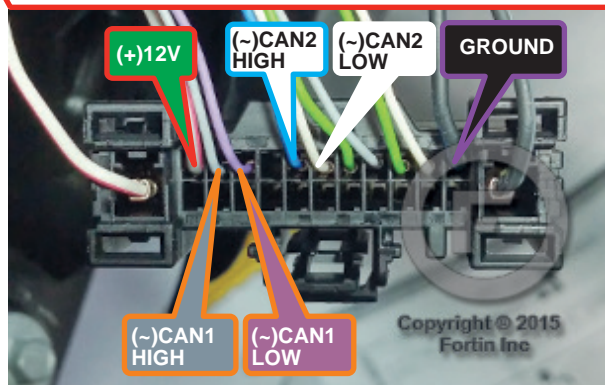

AUTOMATIC TRANSMISSION WIRING CONNECTION |

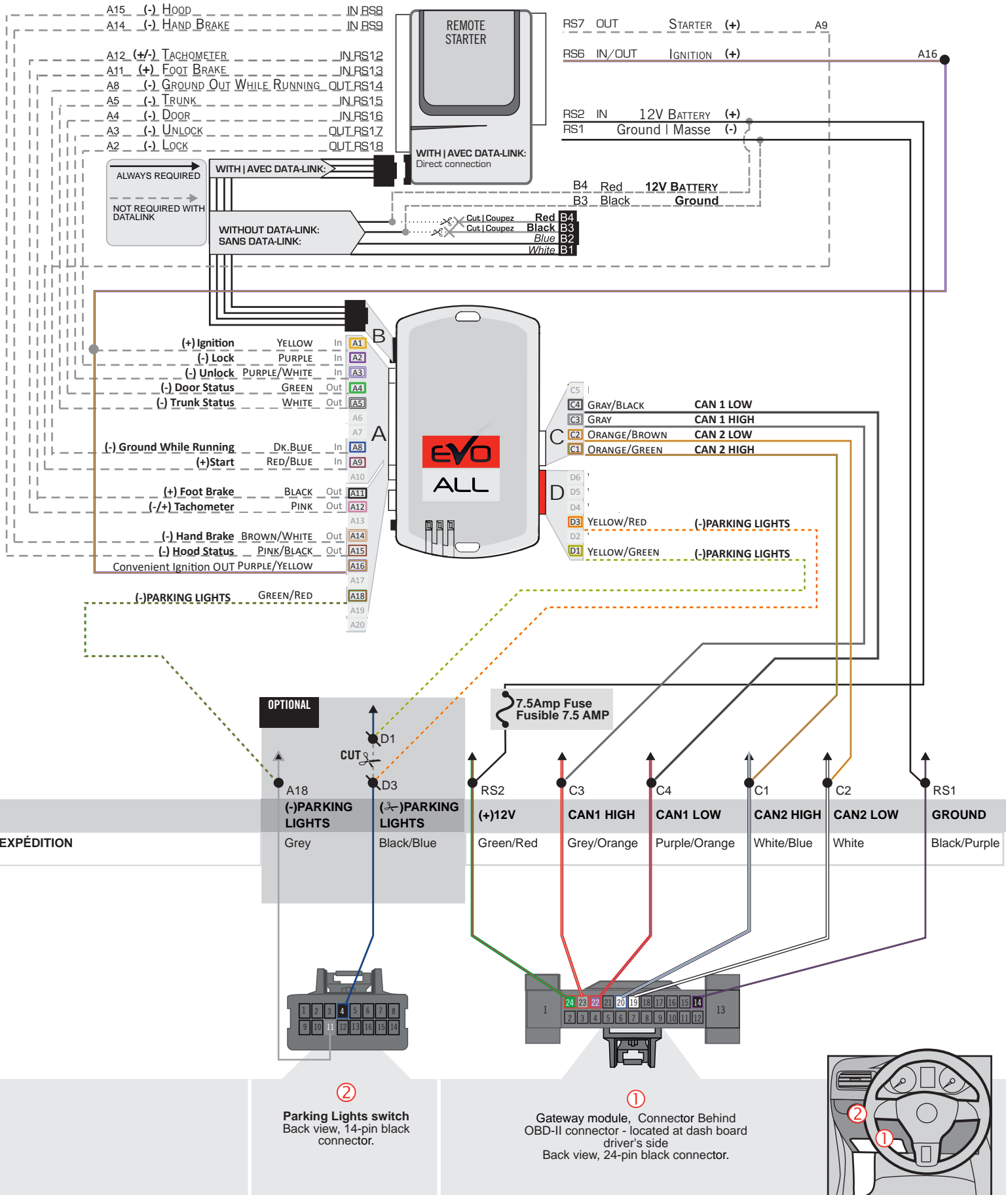

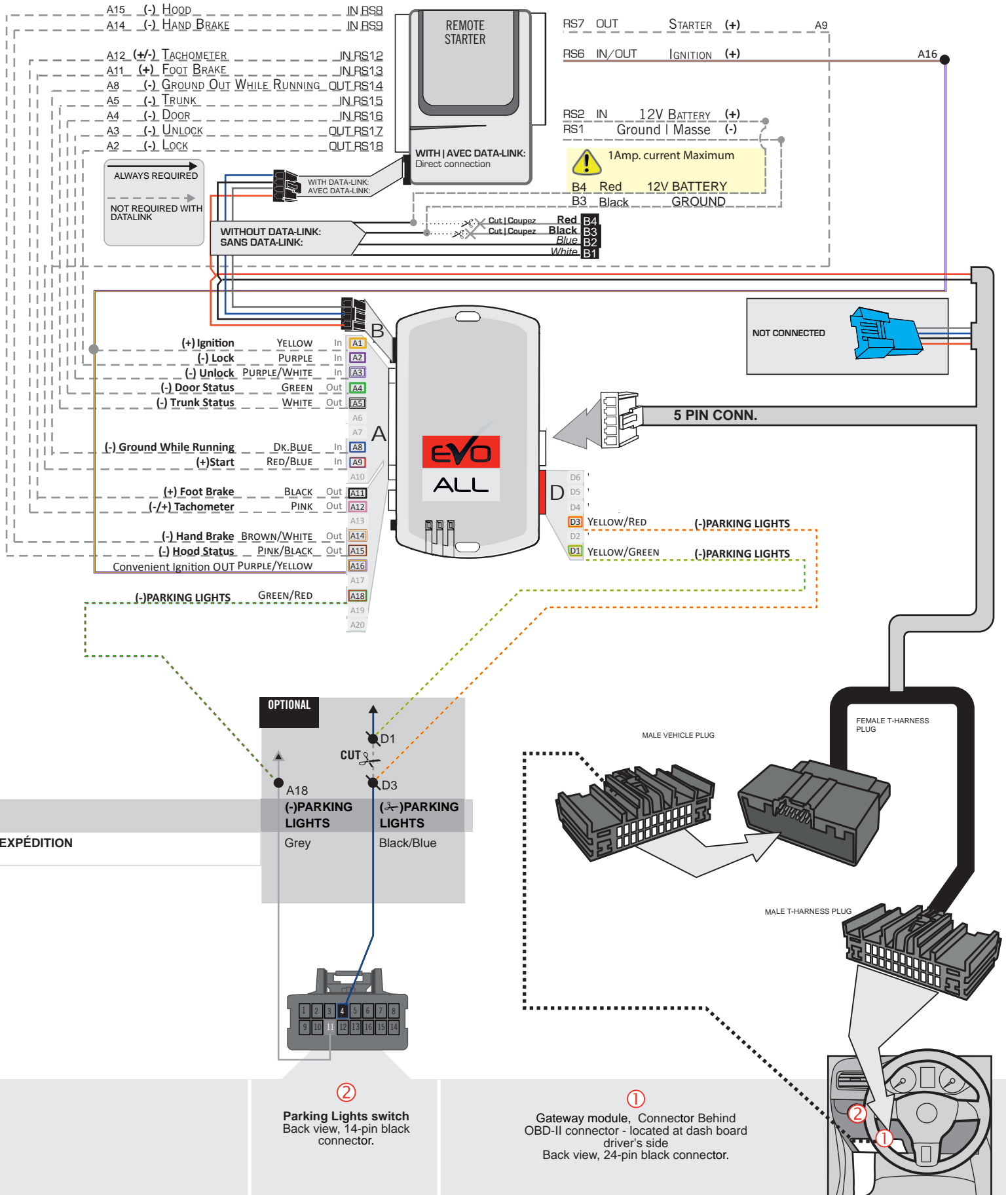



Parts required (not included)

- 1x FLASH LINK UPDATER, SOFTWARE | PROGRAMME
- 1x FLASH LINK MANAGER
- 1x Microsoft Windows Computer with Internet connection

OR

- 1x FLASH LINK MOBILE
- 1x FLASH LINK MOBILE APP
- Smartphone Android or iOS with Internet connection (Internet provider charges may apply)

BEFORE PROGRAMMING SET THE UNIT OPTIONS AND SAVE.

1

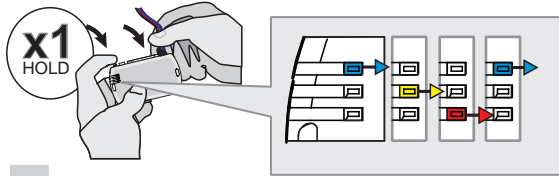

Press and hold the programming button:
Insert the 4-Pin (Data-Link) connector.

↳ The Blue, Red, Yellow and Blue & Red LEDs will alternatively illuminate.

2

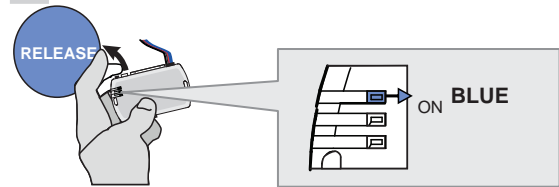

Release the programming button when the LED is BLUE.

If the LED is not solid BLUE disconnect the 4-Pin connector (Data-Link) and go back to step 1.

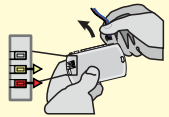

3

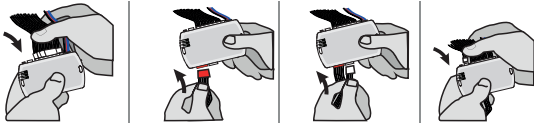

Insert the required remaining connectors.

4

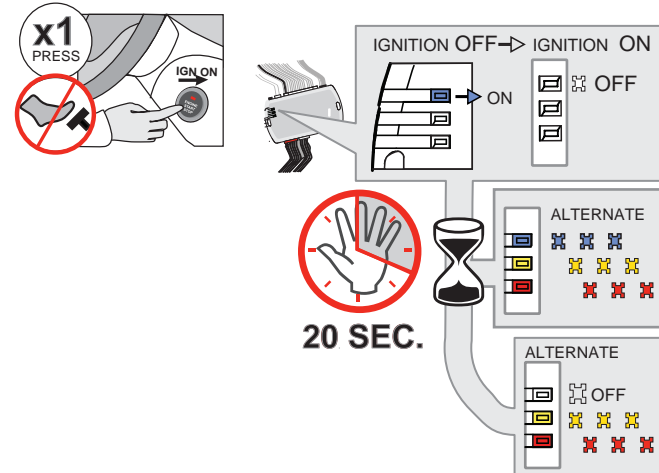

Do not press the brake pedal.
Press the Push-to-Start button once to turn on the ignition.

↳ The BLUE LED will turn OFF.

↳ The BLUE, YELLOW and RED LEDs will alternate.

Wait, at least 20 seconds, do not disconnect the modules or turn off the ignition.

↳ The RED and YELLOW LEDs will alternate.

Make sure that the DELs are flashing RED and YELLOW before continuing programming.

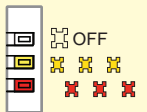

5

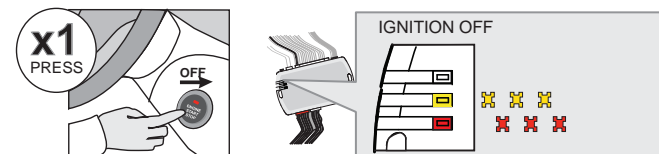

Press the Push-to-Start button once to turn off the ignition.

↳ The RED and YELLOW LEDs alternate.

KEY BYPASS PROGRAMMING PROCEDURE 2/2 |

6

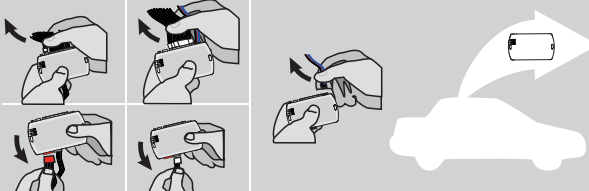

Disconnect all the connectors and after the Data-Link (4-pins) connector.

7



Microsoft Windows Computer with Internet connection*

FLASH LINK UPDATER* **FLASH LINK MANAGER***
SOFTWARE | PROGRAMME

OR

Smartphone* (Internet provider charges may apply)

VEHICLE'S OBDII CONNECTOR **FLASH LINK MOBILE***

Use the tool: FLASH LINK UPDATER or FLASH LINK MOBILE to visit the DCryptor menu.

*Parts required (not included)

8

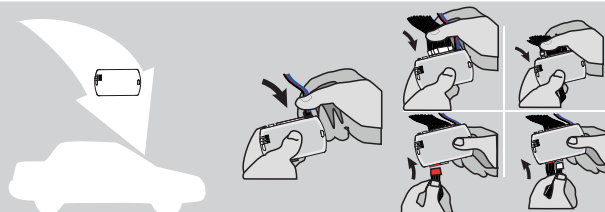

AFTER DCRYPTOR PROGRAMMING COMPLETED
Go back to the vehicle and reconnect the 4-Pin (Data-Link) connector and after, all the remaining connector.

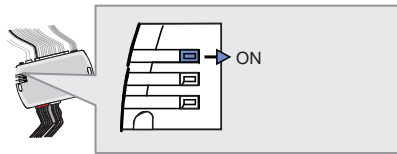

↳ The BLUE LED will turn ON.

9

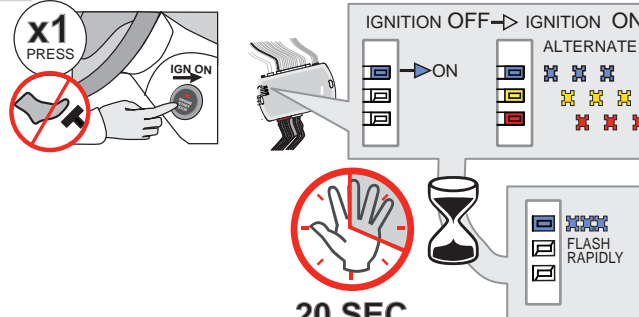

x1 PRESS (with a red 'X' over the push-to-start button)

IGNITION OFF → IGNITION ON

ALTERNATE

↳ The RED and YELLOW LEDs will turn ON.

20 SEC. (with a hand icon and an hourglass)

FLASH RAPIDLY

Wait, at least 20 seconds, do not disconnect the modules or turn off the ignition.

↳ The BLUE LED will flash rapidly.

10

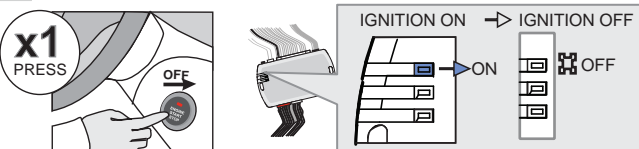

x1 PRESS (with a hand icon)

IGNITION ON → IGNITION OFF

OFF





Press the Push-to-Start button once to turn off the ignition.

↳ The BLUE will turn OFF.

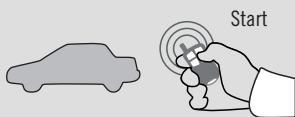

The module is now programmed.

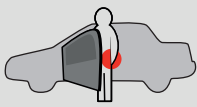
REMOTE STARTER FUNCTIONALITY |

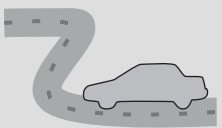
 <p>Start</p> <p>All doors must be closed.</p> <p>Remote start the vehicle.</p>	 <p>UNLOCK</p> <p>Unlock the doors with either:</p> <ul style="list-style-type: none"> • The OEM remote • The remote-starter remote • Or the proximity remote 	 <p>Enter the vehicle with the SMART-KEY.</p>	 <p>DO NOT PRESS THE BRAKE PEDAL.</p> <p>Press and release the Push-to-Start button once.</p>	 <p>Press the brake pedal. The vehicle can now be put in to gear and driven.</p> <p>If the Smart-Key is not detected the vehicle will shut down.</p>
--	---	--	---	---

REGULAR & THAR-FOR3 INSTALLATION

ADDENDUM - SUGGESTED WIRING CONFIGURATION



ONLY COMPATIBLE WITH AUTOMATIC TRANSMISSION VEHICLES.



Vehicle functions supported in this diagram (functional if equipped)

VEHICLE	YEARS	Immobilizer bypass	Lock	Unlock	Armn	Disarm	RAP Disable	Parking Lights***	Tachometer	Heated seats**	Heated Mirrors**	Rear defrost	Door Status	Trunk Status	Hood Status*	Hand-Brake Status	Foot-Brake Status	Active OEM Remote Start
FORD Explorer	Key 2020	•	•	•	•	•	•	•	•	•	•	•	•	•	•	•	•	•

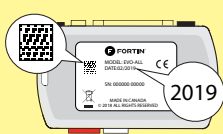

COMPATIBLE MODULE REQUIRED:

QR CODE ON THE LABEL
MANUFACTURED AFTER: 2019

FIRMWARE VERSION

58.[02]
MINIMUM

To add the firmware version and the options, use the **FLASH LINK UPDATER** or **FLASH LINK MOBILE** tool, sold separately.



Program bypass option:

UNIT OPTION

C1

DESCRIPTION

OEM Remote status (Lock/Unlock) monitoring

IF THE VEHICLE IS NOT EQUIPPED WITH FUNCTIONAL HOOD PIN:

A11

OFF

Hood trigger (Output Status).

NOTES

The vehicles OEM remote and SmartKey are still operable during remote start.

**Heated seats The heated seats and rear defrost activate automatically when it cold.

***Parking Lights The parking Lights at remote start only.



The vehicle must be equipped with the OEM remote with the door locks.

MANDATORY INSTALL

*HOOD PIN



HOOD STATUS: THE HOOD PIN SWITCH MUST BE INSTALLED IF THE VEHICLE CAN BE REMOTE STARTED WITH THE HOOD OPEN, SET FUNCTION A11 TO OFF.

A11

OFF

Notice: the installation of safety elements are mandatory. The hood pin is an essential security element and must be installed.

THIS MODULE MUST BE INSTALLED BY A QUALIFIED TECHNICIAN. A WRONG CONNECTION CAN CAUSE PERMANENT DAMAGE TO THE VEHICLE.

DESCRIPTION | DESCRIPTION

	Parts required (Not included)	PAGE
--	-------------------------------	------

WIRE TO WIRE DIAGRAM

AUTOMATIC TRANSMISSION	1x 7.5 Amp. fuse	Page 3
------------------------	------------------	--------

THARNES DIAGRAM

THARNES THAR-FOR3 AUTOMATIC TRANSMISSION	1x THAR-FOR3	Page 4
--	--------------	--------

① Gateway module, located at dash board driver's side,

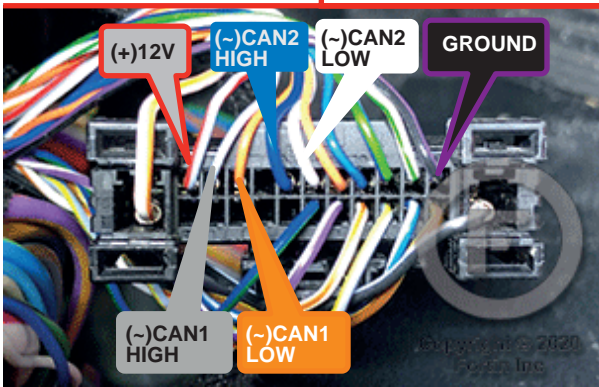

② Fuse box

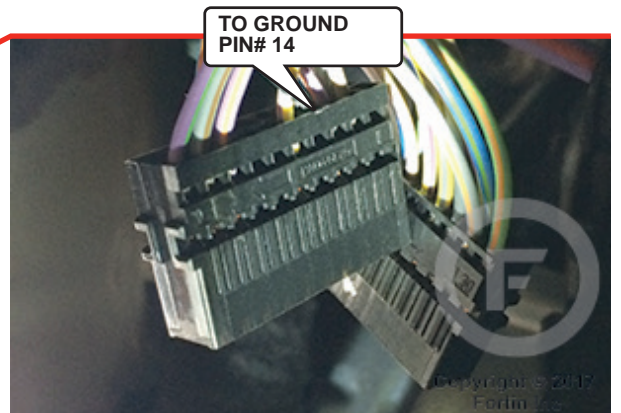
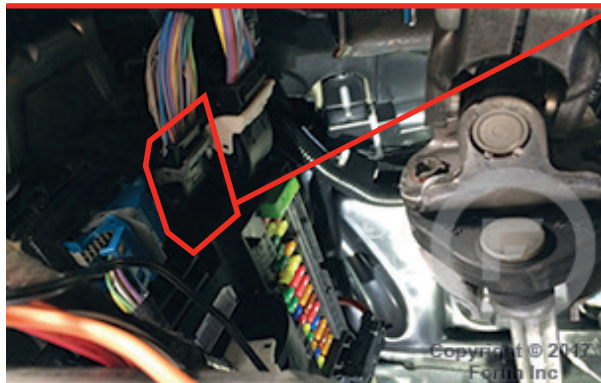

AUTOMATIC TRANSMISSION WIRING CONNECTION |

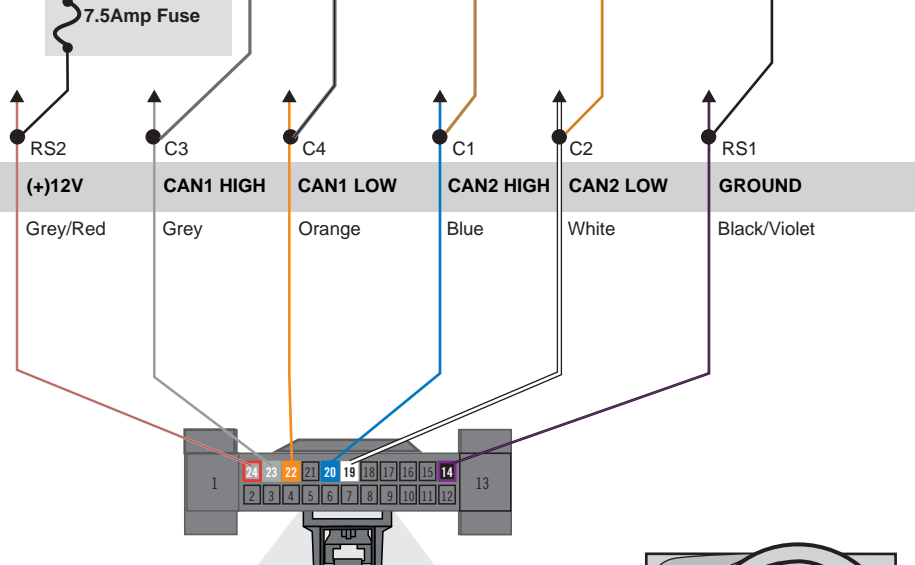
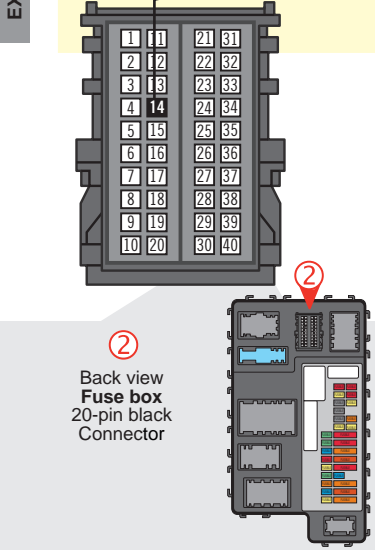
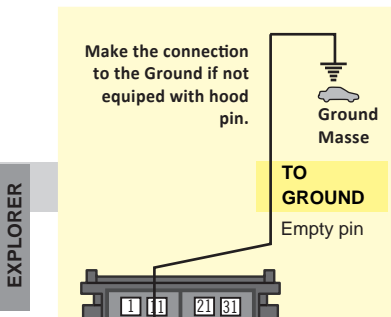
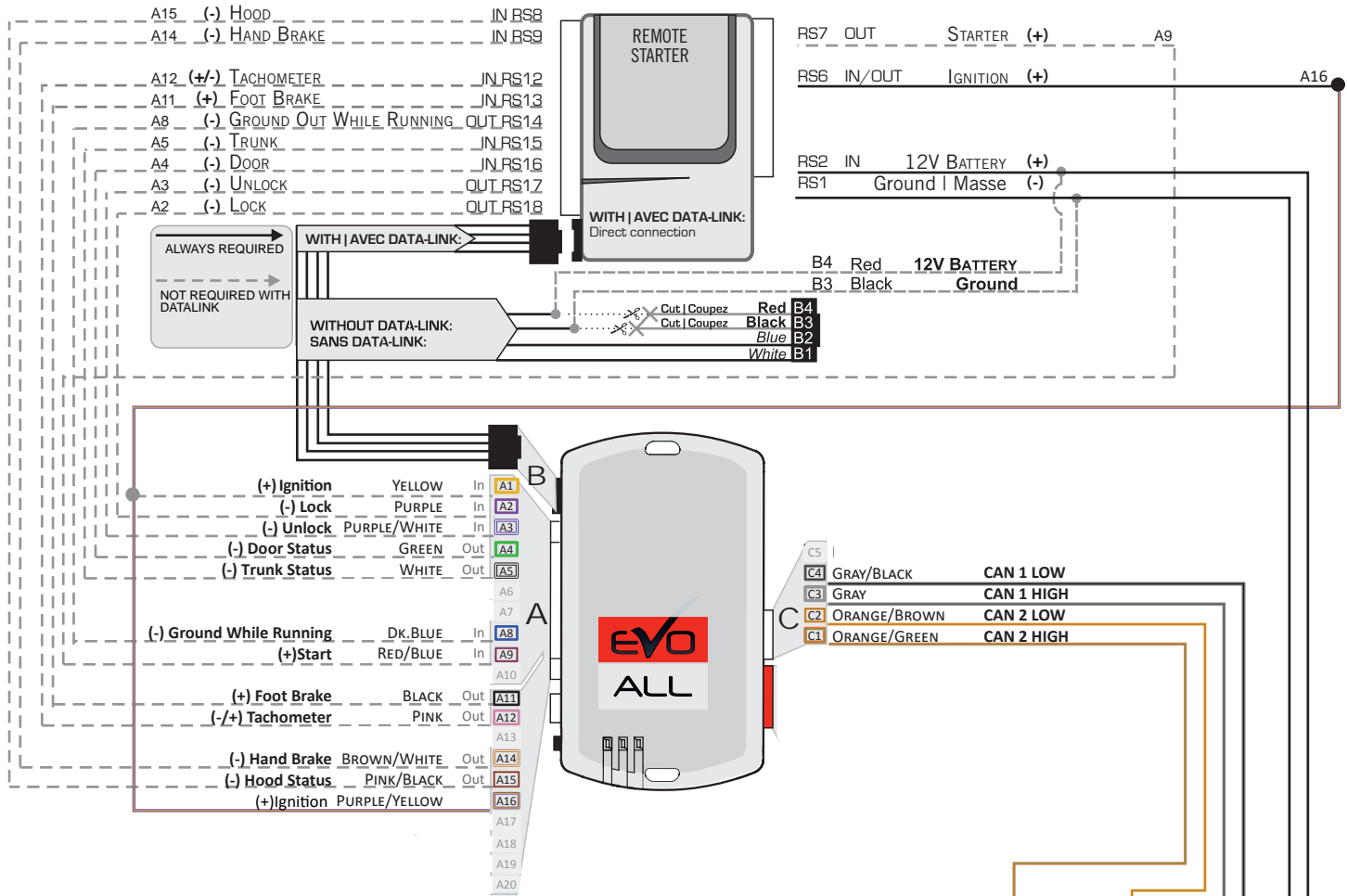

① Gateway module, Behind OBD-II connector - located at dash board driver's side - Back view, 24-pin black connector.

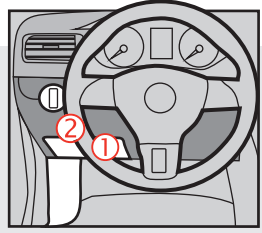

THAR-FOR3 | T-HARNESS - AUTOMATIC TRANSMISSION |

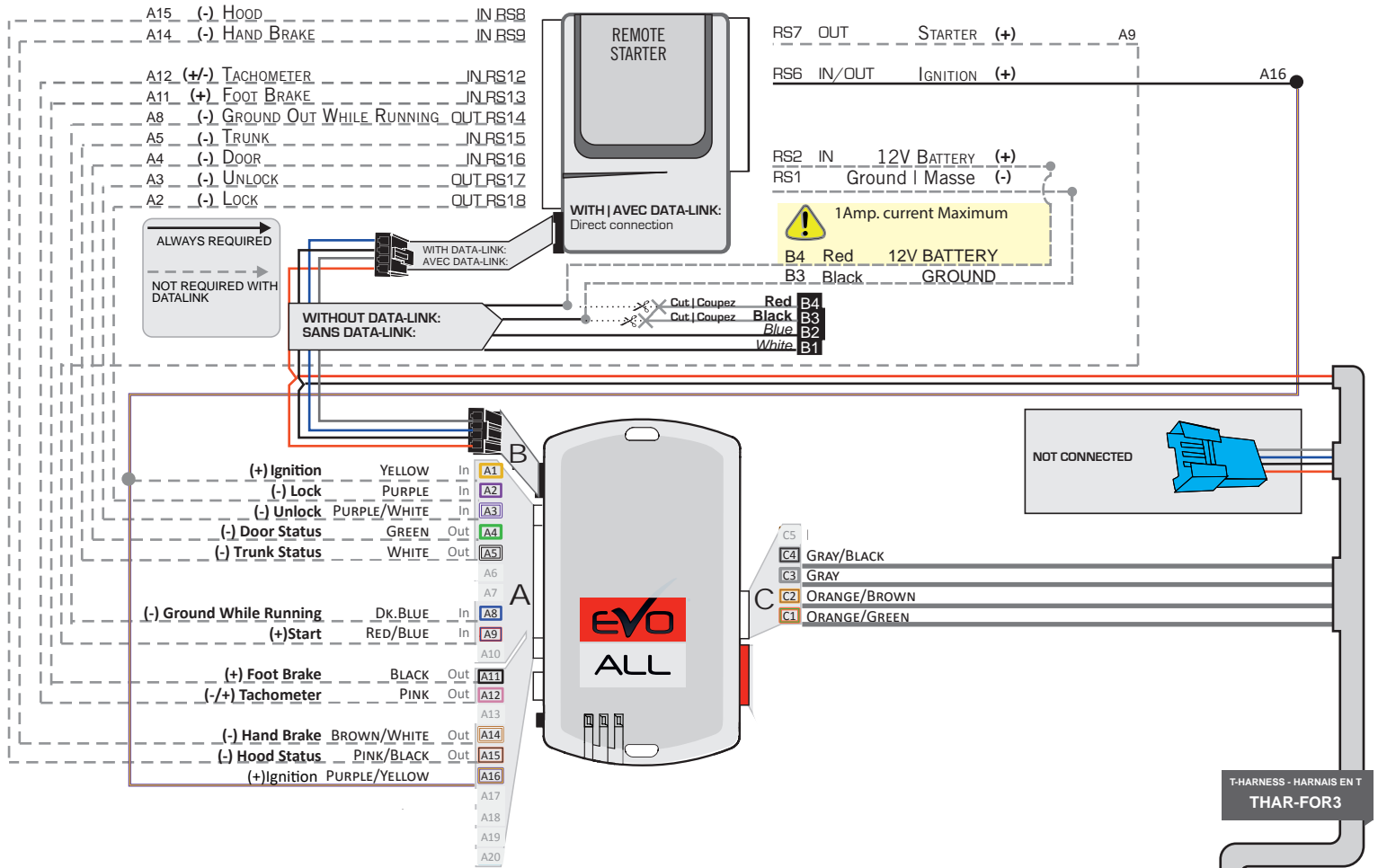

EXPLORER

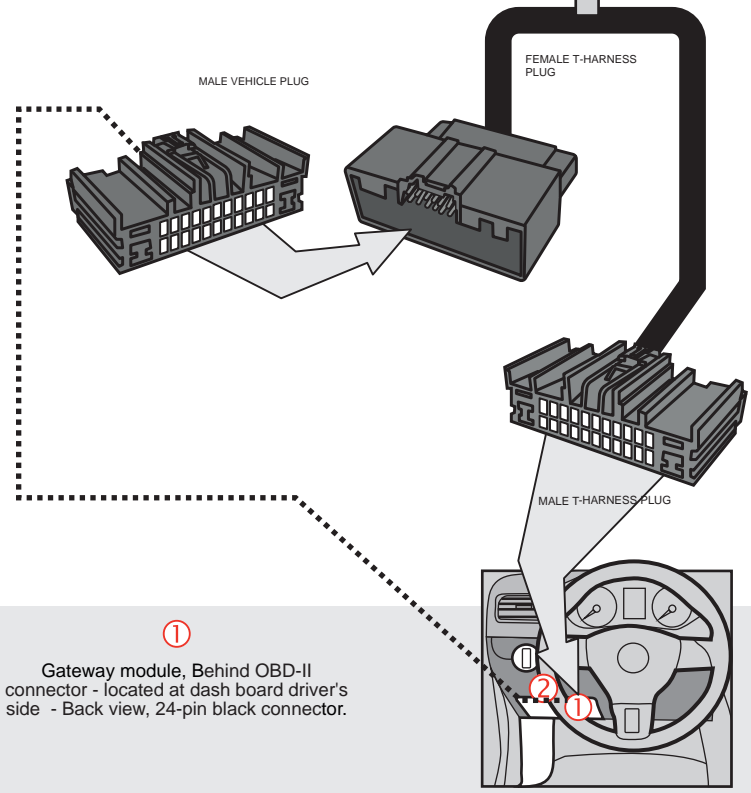
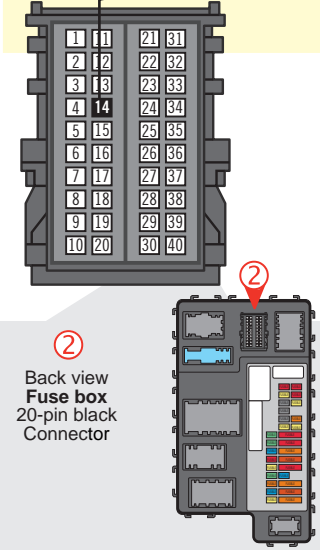
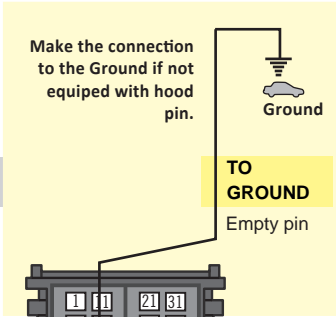



Parts required (not included)

- 1x **FLASH LINK UPDATER,**
- 1x **FLASH LINK MANAGER**
SOFTWARE | PROGRAMME
- 1x Microsoft Windows Computer with Internet connection

OR

- 1x **FLASH LINK MOBILE**
- 1x **FLASH LINK MOBILE APP**
- Smartphone *Android* or *iOS* with Internet connection
(Internet provider charges may apply)

BEFORE PROGRAMMING SET THE UNIT OPTIONS AND SAVE.

1

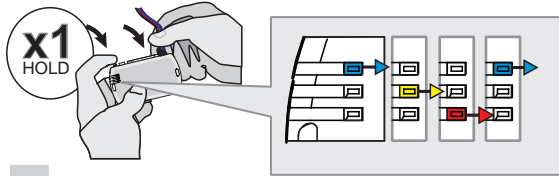

Press and hold the programming button:
Insert the 4-Pin (Data-Link) connector.

↳ The Blue, Red, Yellow and Blue & Red LEDs will alternatively illuminate.

2

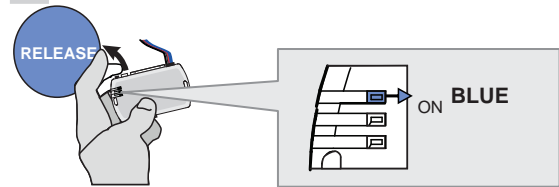

Release the programming button when the LED is BLUE.

If the LED is not solid BLUE disconnect the 4-Pin connector (Data-Link) and go back to step 1.

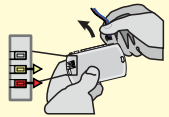

3

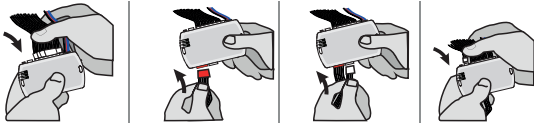

Insert the required remaining connectors.

4

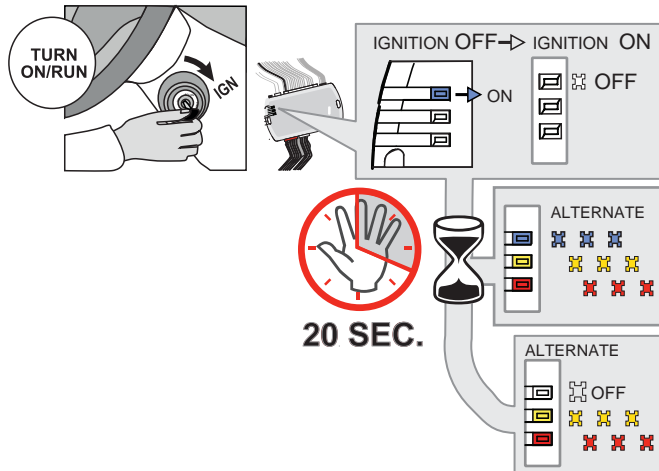

Turn the key to the Ignition ON/RUN position.

↳ The BLUE LED will turn OFF.

↳ The BLUE, YELLOW and RED LEDs will alternate.

Wait, at least 20 seconds, do not disconnect the modules or turn off the ignition.

↳ The RED and YELLOW LEDs will alternate.

Make sure that the DELs are flashing RED and YELLOW before continuing programming.

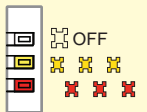

5

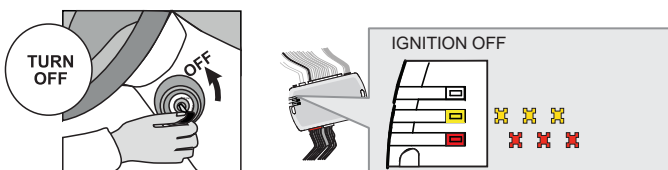

Turn the key to the OFF position.

↳ The RED and YELLOW LEDs alternate.

KEY BYPASS PROGRAMMING PROCEDURE 2/2 |

6

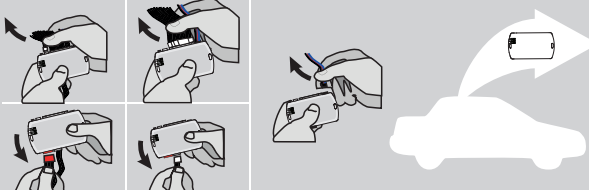

Disconnect all the connectors and after the Data-Link (4-pins) connector.

7



Microsoft Windows Computer with Internet connection*

FLASH LINK UPDATER* **FLASH LINK MANAGER***
SOFTWARE | PROGRAMME

OR

Smartphone* (Internet provider charges may apply)

FLASH LINK MOBILE*

VEHICLE'S OBDII CONNECTOR

Use the tool: FLASH LINK UPDATER or FLASH LINK MOBILE to visit the DCRYPTOR menu.

*Parts required (not included)

8

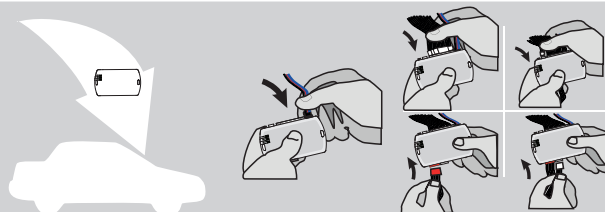

AFTER DCRYPTOR PROGRAMMING COMPLETED
Go back to the vehicle and reconnect the 4-Pin (Data-Link) connector and after, all the remaining connector.

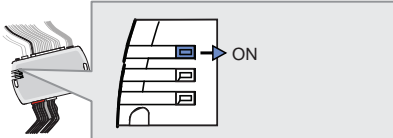

↳ The BLUE LED will turn ON.

9

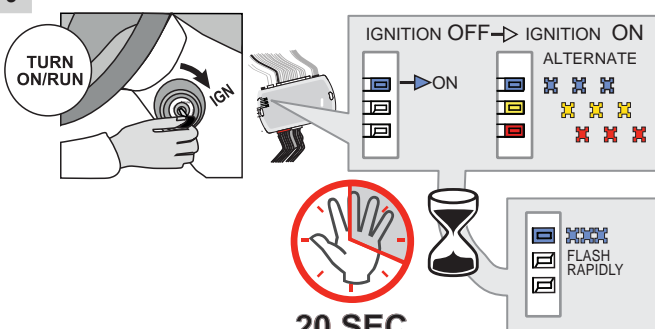

TURN ON/RUN

IGNITION OFF → IGNITION ON

ALTERNATE

↳ The RED and YELLOW LEDs will turn ON.

Wait, at least 20 seconds, do not disconnect the modules or turn off the ignition.

↳ The BLUE LED will flash rapidly.

20 SEC.

FLASH RAPIDLY

10

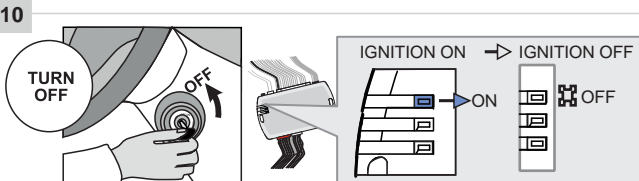

TURN OFF

IGNITION ON → IGNITION OFF

↳ The BLUE will turn OFF.



The module is now programmed.

REMOTE STARTER FUNCTIONALITY |



All doors must be closed.



Remote start the vehicle.



Unlock the doors with the remote-starter remote or the OEM remote.



Insert and Turn the key to the Ignition ON/RUN position.



Press the brake pedal.



The vehicle can now be put in to gear and driven.

REGULAR & THAR-FOR3 INSTALLATION

ADDENDUM - SUGGESTED WIRING CONFIGURATION



ONLY COMPATIBLE WITH AUTOMATIC TRANSMISSION VEHICLES.



Vehicle functions supported in this diagram (functional if equipped)

VEHICLE	YEARS	Immobilizer bypass	Lock	Unlock	Arm	Disarm	Heated Seats**	Rear Defrost**	RAP Disable	Parking Lights***	Tachometer	Door Status	Trunk Status	Hood Status*	Hand-Brake Status	Foot-Brake Status	Active OEM Remote Start
FORD Explorer	Push-to-Start 2020	•	•	•	•	•	•	•	•	•	•	•	•	•	•	•	•

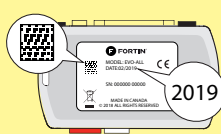

COMPATIBLE MODULE REQUIRED:

QR CODE ON THE LABEL
MANUFACTURED AFTER:
2019

FIRMWARE VERSION
58.[02]
MINIMUM

To add the firmware version and the options, use the **FLASH LINK UPDATER** or **FLASH LINK MOBILE** tool, sold separately.



Program bypass option:

UNIT OPTION

DESCRIPTION

C1

OEM Remote status (Lock/Unlock) monitoring

D6

Push-to-Start

IF THE VEHICLE IS NOT EQUIPPED WITH FUNCTIONAL HOOD PIN:

A11

OFF

Hood trigger (Output Status).

NOTES

The vehicles OEM remote and SmartKey are still operable during remote start.

**Heatd seats The heated seats and rear defrost activate automatically when it cold.

***Parking Lights The parking Lights at remote start only.

MANDATORY INSTALL

*HOOD PIN



HOOD STATUS: THE HOOD PIN SWITCH MUST BE INSTALLED IF THE VEHICLE CAN BE REMOTE STARTED WITH THE HOOD OPEN, SET FUNCTION A11 TO OFF.

A11

OFF

Notice: the installation of safety elements are mandatory. The hood pin is an essential security element and must be installed.

THIS MODULE MUST BE INSTALLED BY A QUALIFIED TECHNICIAN. A WRONG CONNECTION CAN CAUSE PERMANENT DAMAGE TO THE VEHICLE.

DESCRIPTION | DESCRIPTION

		Parts required (Not included)	PAGE
--	--	-------------------------------	------

WIRE TO WIRE DIAGRAM

AUTOMATIC TRANSMISSION	1x 7.5 Amp. fuse	1x Fusible 7.5 Amp.	Page 3
------------------------	------------------	---------------------	--------

THARNESSE DIAGRAM

THARNESSE THAR-FOR3	AUTOMATIC TRANSMISSION	1x THAR-FOR3	1x THAR-FOR3	Page 4
---------------------	------------------------	--------------	--------------	--------

① Gateway module, located at dash board driver's side,

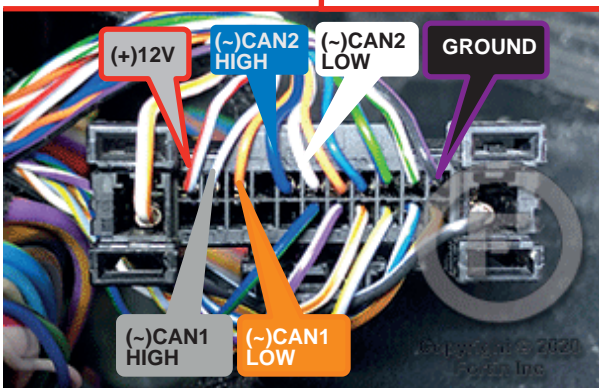

② Fuse box

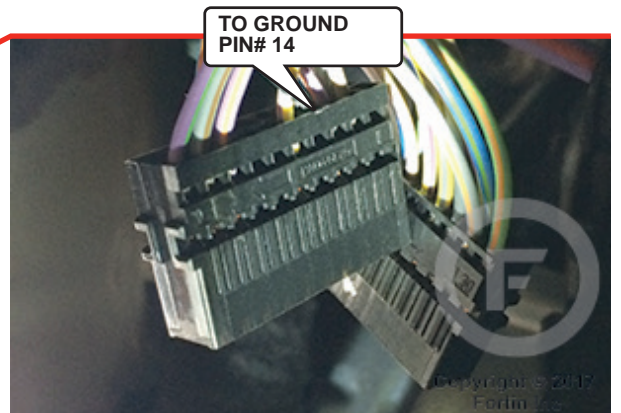
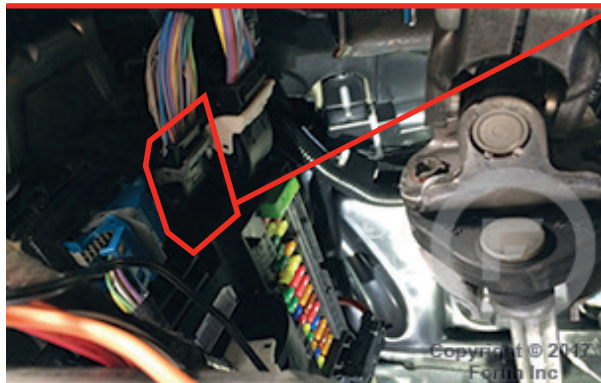

AUTOMATIC TRANSMISSION WIRING CONNECTION |

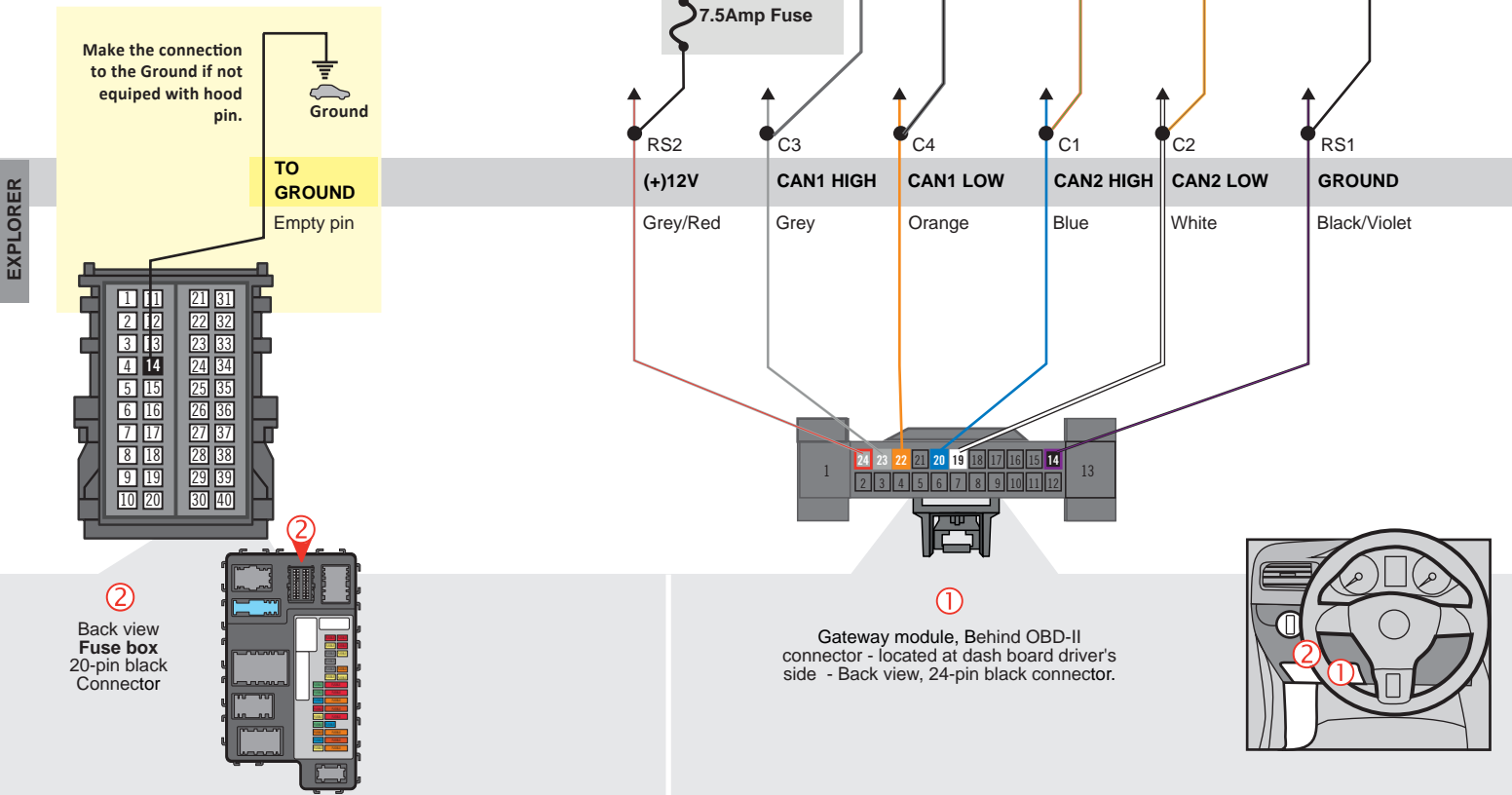
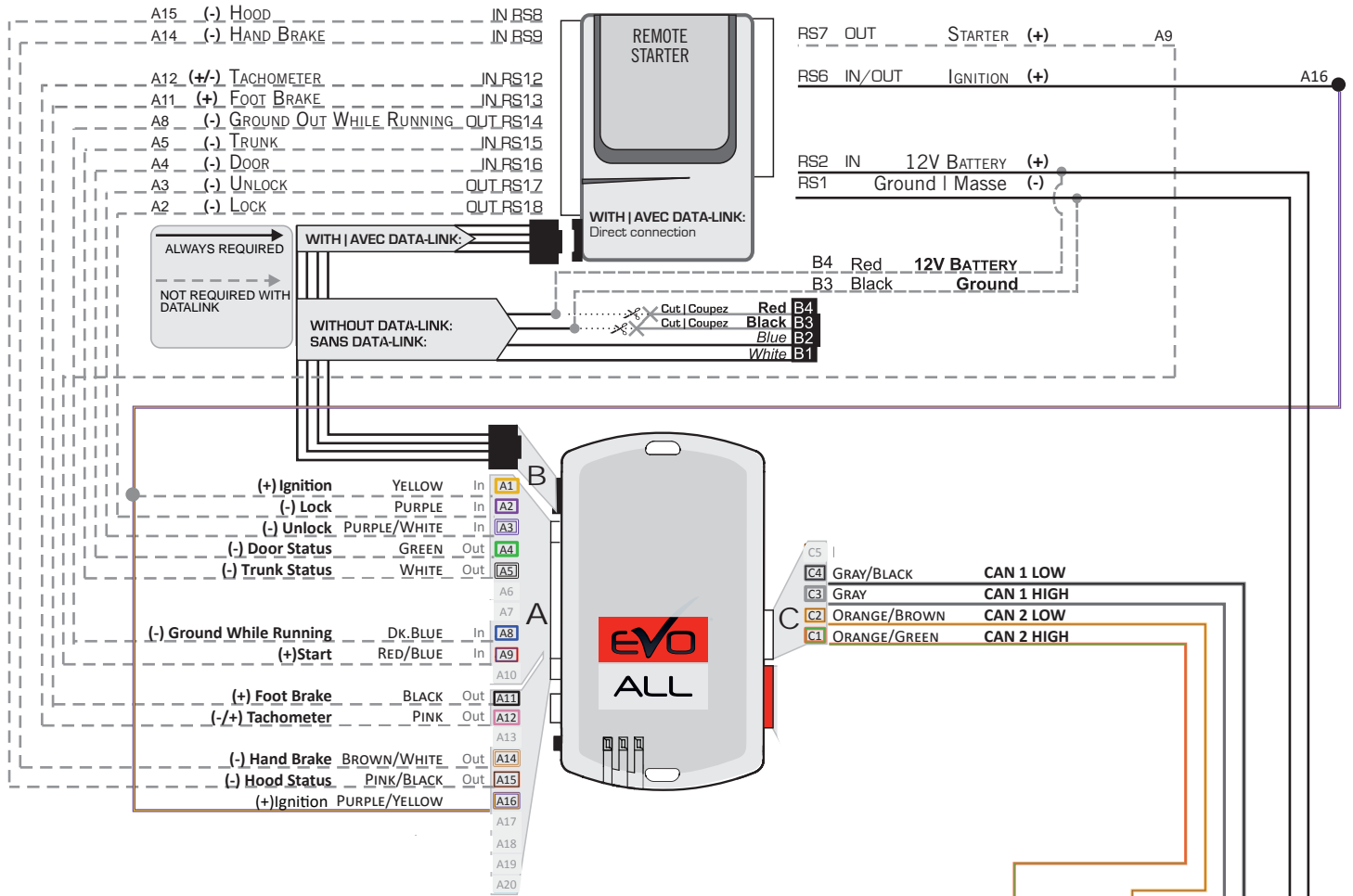

THAR-FOR3 | T-HARNESS - AUTOMATIC TRANSMISSION |

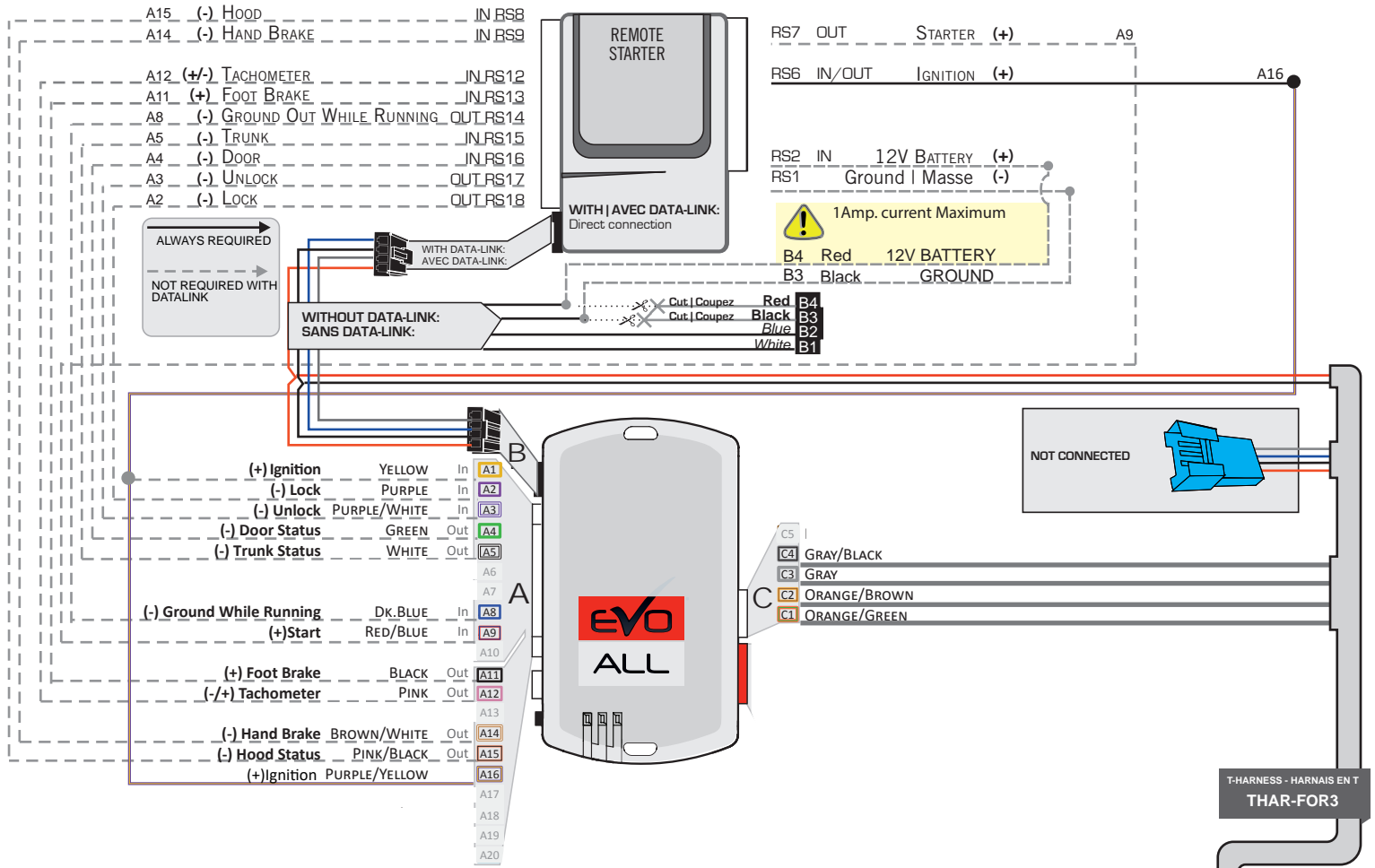

EXPLORER

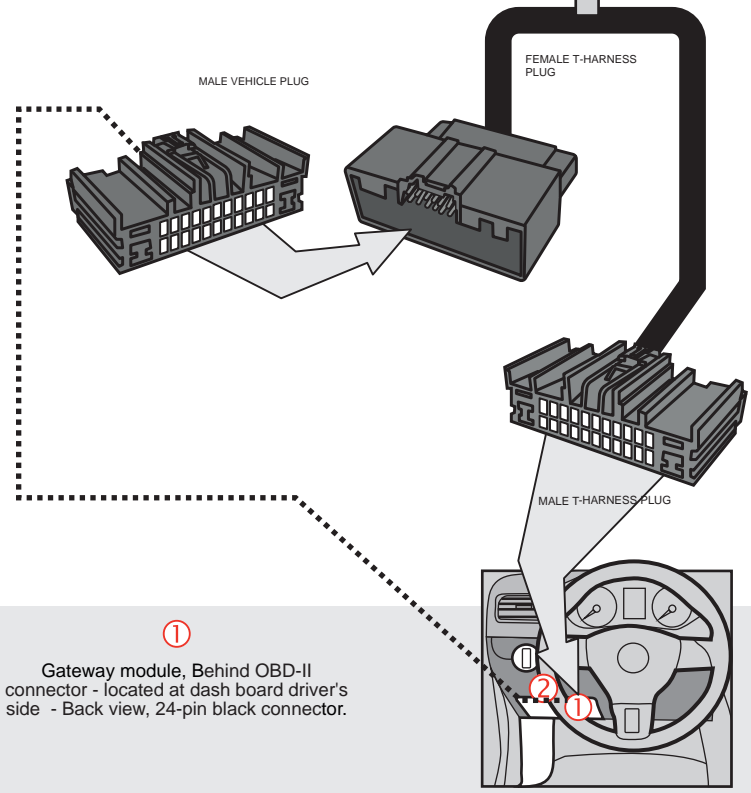
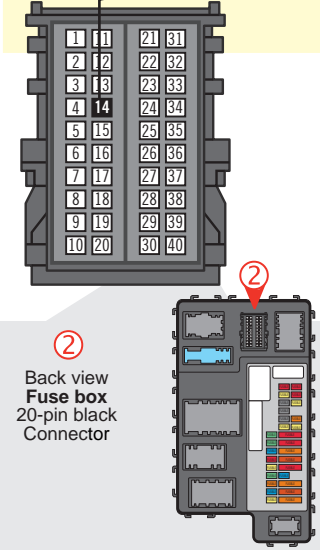
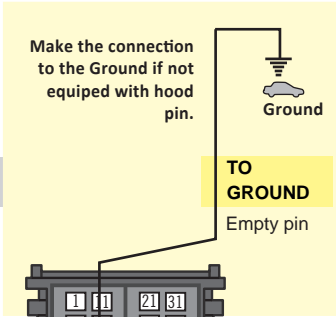



Parts required (not included)

- 1x FLASH LINK UPDATER, SOFTWARE | PROGRAMME
- 1x FLASH LINK MANAGER
- 1x Microsoft Windows Computer with Internet connection

OR

- 1x FLASH LINK MOBILE
- 1x FLASH LINK MOBILE APP
- Smartphone Android or iOS with Internet connection (Internet provider charges may apply)

BEFORE PROGRAMMING SET THE UNIT OPTIONS AND SAVE.

1

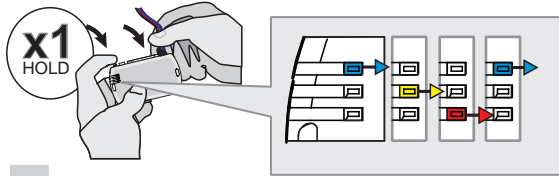

Press and hold the programming button:
Insert the 4-Pin (Data-Link) connector.

↳ The Blue, Red, Yellow and Blue & Red LEDs will alternatively illuminate.

2

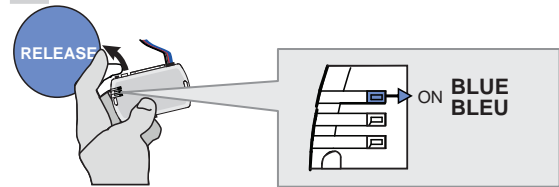

Release the programming button when the LED is BLUE.

If the LED is not solid BLUE disconnect the 4-Pin connector (Data-Link) and go back to step 1.

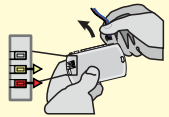

3

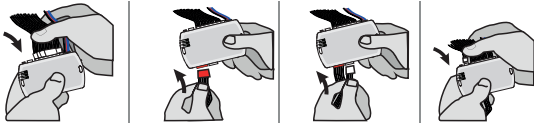

Insert the required remaining connectors.

4

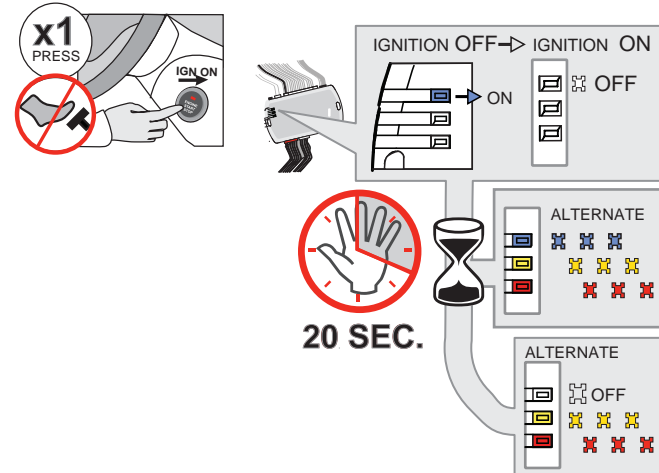

Do not press the brake pedal.
Press the Push-to-Start button once to turn on the ignition.

↳ The BLUE LED will turn OFF.

↳ The BLUE, YELLOW and RED LEDs will alternate.

Wait, at least 20 seconds, do not disconnect the modules or turn off the ignition.

↳ The RED and YELLOW LEDs will alternate.

Make sure that the DELs are flashing RED and YELLOW before continuing programming.

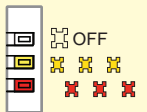

5

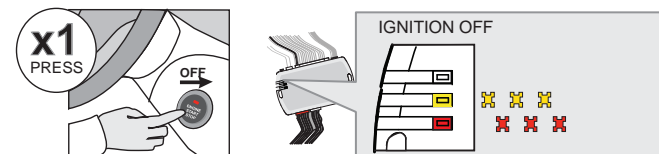

Press the Push-to-Start button once to turn off the ignition.

↳ The RED and YELLOW LEDs alternate.

KEY BYPASS PROGRAMMING PROCEDURE 2/2 |

6

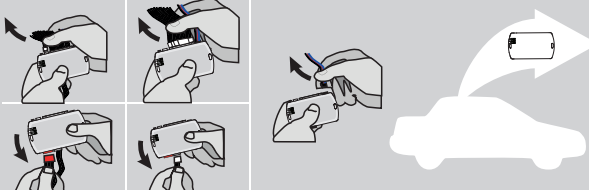

Disconnect all the connectors and after the Data-Link (4-pins) connector.

7



Microsoft Windows Computer with Internet connection*

FLASH LINK UPDATER* **FLASH LINK MANAGER***
SOFTWARE | PROGRAMME

OR

Smartphone* (Internet provider charges may apply)

VEHICLE'S OBDII CONNECTOR **FLASH LINK MOBILE***

Use the tool: FLASH LINK UPDATER or FLASH LINK MOBILE to visit the DCryptor menu.

*Parts required (not included)

8

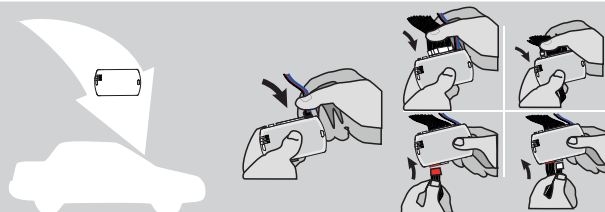

AFTER DCRYPTOR PROGRAMMING COMPLETED
Go back to the vehicle and reconnect the 4-Pin (Data-Link) connector and after, all the remaining connector.

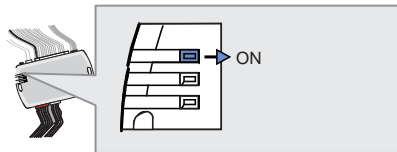

↳ The BLUE LED will turn ON.

9

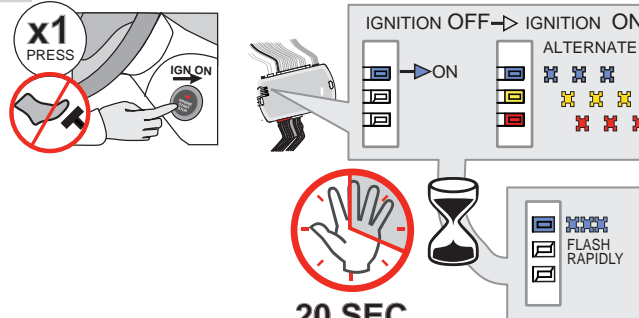

x1 PRESS (with a red 'X' over the push-to-start button)

IGNITION OFF → IGNITION ON

ALTERNATE

↳ The RED and YELLOW LEDs will turn ON.

20 SEC.

↳ The BLUE LED will flash rapidly.

Do not press the brake pedal. **Press** the Push-to-Start button once to turn on the ignition.

Wait, at least 20 seconds, do not disconnect the modules or turn off the ignition.

10

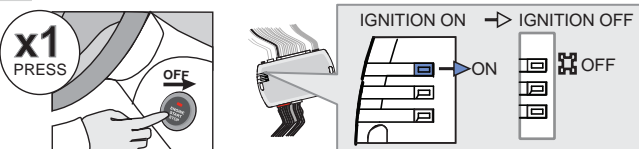

x1 PRESS (with a red 'X' over the push-to-start button)

IGNITION ON → IGNITION OFF

OFF





↳ The BLUE will turn OFF.

Press the Push-to-Start button once to turn off the ignition.

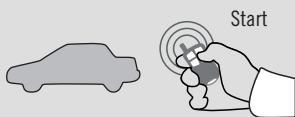

The module is now programmed.

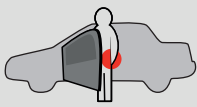
REMOTE STARTER FUNCTIONALITY |

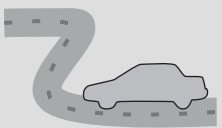
 <p>Start</p> <p>All doors must be closed.</p> <p>Remote start the vehicle.</p>	 <p>UNLOCK</p> <p>Unlock the doors with either:</p> <ul style="list-style-type: none"> • The OEM remote • The remote-starter remote • Or the proximity remote 	 <p>Enter the vehicle with the SMART-KEY.</p>	 <p>DO NOT PRESS THE BRAKE PEDAL.</p> <p>Press and release the Push-to-Start button once.</p>	 <p>Press the brake pedal. The vehicle can now be put in to gear and driven.</p> <p>If the Smart-Key is not detected the vehicle will shut down.</p>
--	---	--	---	---

REGULAR & THAR-FOR3 INSTALLATION

ADDENDUM - SUGGESTED WIRING CONFIGURATION



ONLY COMPATIBLE WITH AUTOMATIC TRANSMISSION VEHICLES.



VEHICLE	YEARS	Vehicle functions supported in this diagram (functional if equipped)														
		Immobilizer bypass	T-Harness available (sold separately)	Lock	Unlock	Arm	Disarm	Tachometer	Door Status	Trunk Status	Hood Status*	Hand-Brake Status	Foot-Brake Status	Active OEM Remote Start		
FORD																
Explorer Interceptor	2020	•	•	•	•	•	•	•	•	•	•	•	•	•	•	•

	COMPATIBLE MODULE REQUIRED: 2019	QR CODE ON THE LABEL MANUFACTURED AFTER: 2019	FIRMWARE VERSION 58.[01] MINIMUM	To add the firmware version and the options, use the FLASH LINK UPDATER or FLASH LINK MOBILE tool, sold separately.

	Program bypass option:	UNIT OPTION	DESCRIPTION
		C1	OEM Remote status (Lock/Unlock) monitoring
IF THE VEHICLE IS NOT EQUIPPED WITH FUNCTIONAL HOOD PIN:		A11	<input type="checkbox"/> OFF Hood trigger (Output Status).

MANDATORY INSTALL

*HOOD PIN



HOOD STATUS: THE HOOD PIN SWITCH MUST BE INSTALLED IF THE VEHICLE CAN BE REMOTE STARTED WITH THE HOOD OPEN, SET FUNCTION A11 TO OFF.

A11 **OFF**

Notice: the installation of safety elements are mandatory. The hood pin is an essential security element and must be installed.

THIS MODULE MUST BE INSTALLED BY A QUALIFIED TECHNICIAN. A WRONG CONNECTION CAN CAUSE PERMANENT DAMAGE TO THE VEHICLE.

DESCRIPTION |

Parts required (Not included) **PAGE**

WIRE TO WIRE DIAGRAM

AUTOMATIC TRANSMISSION	1x 7.5 Amp. fuse	Page 3
------------------------	------------------	--------

THARNESS DIAGRAM

THARNESS THAR-FOR3 AUTOMATIC TRANSMISSION	1x THAR-FOR3	Page 4
---	--------------	--------



① Gateway module, Behind OBD-II connector - located behind driver side fusebox

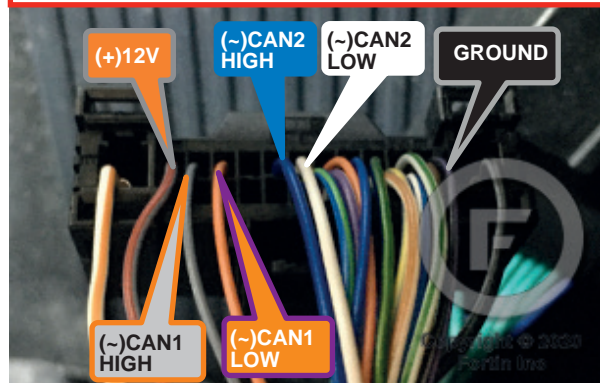

AUTOMATIC TRANSMISSION WIRING CONNECTION |

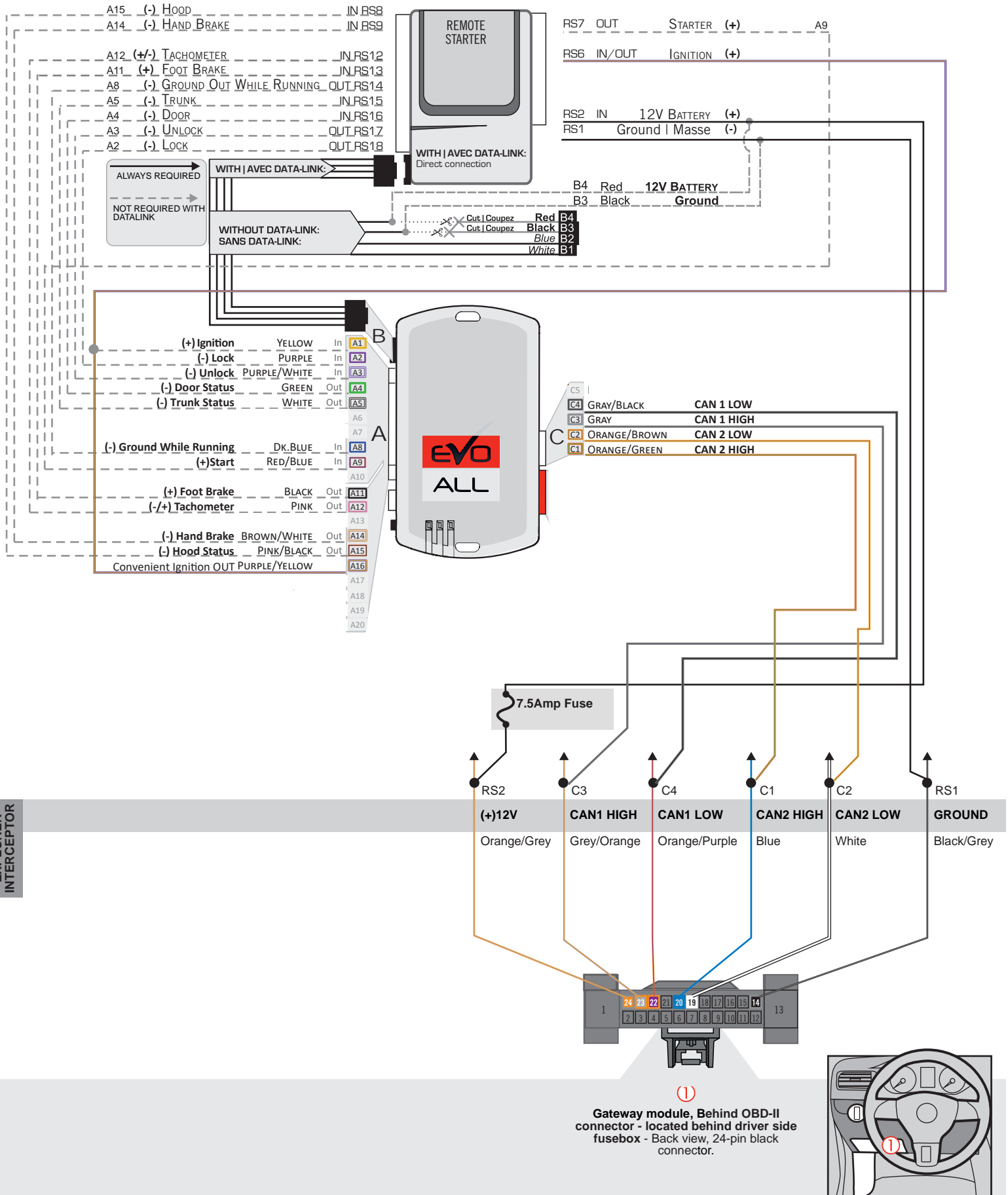

THAR-FOR3 | T-HARNESS - AUTOMATIC TRANSMISSION |

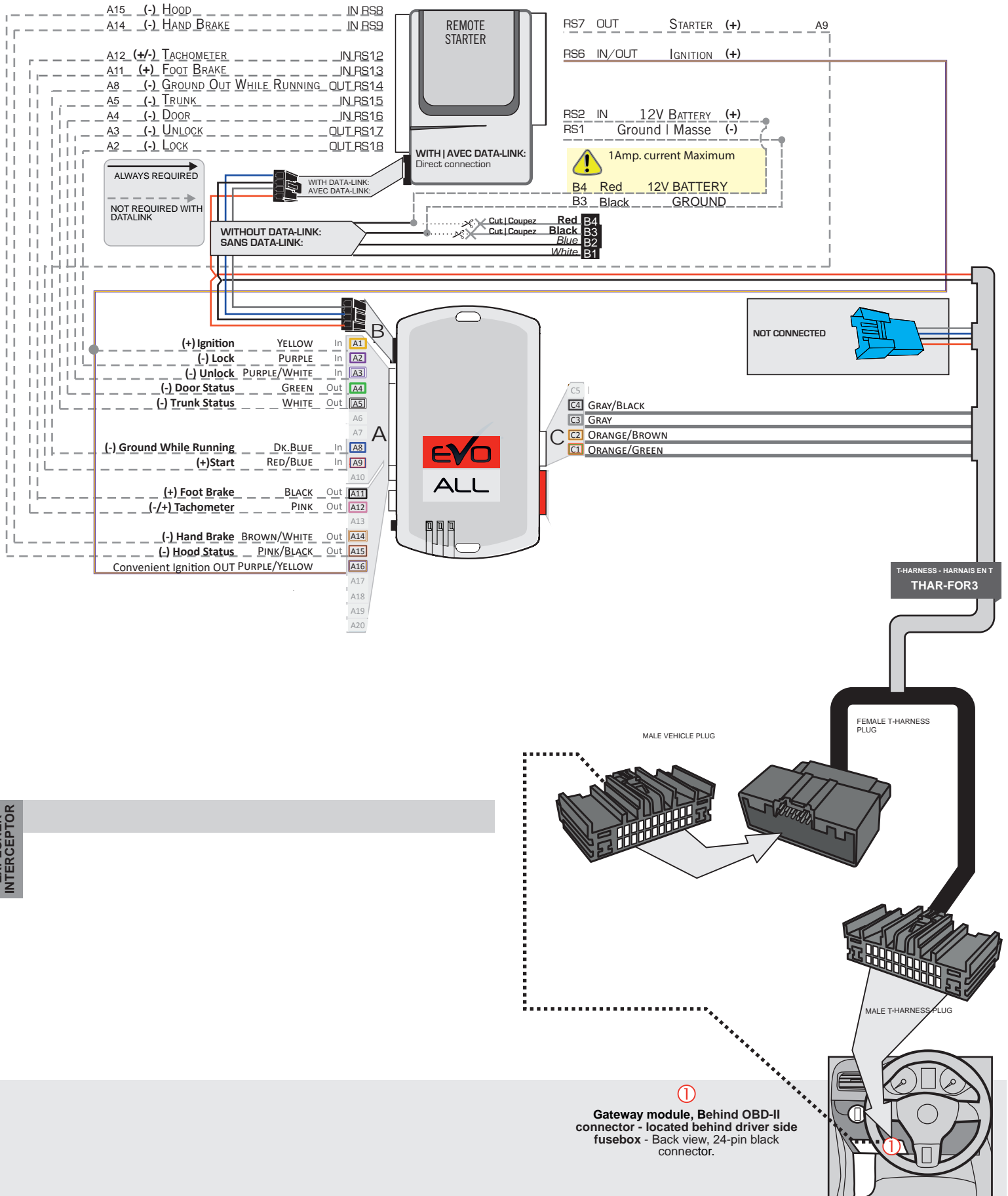



Parts required (not included)

- 1x **FLASH LINK UPDATER,**
- 1x **FLASH LINK MANAGER**
SOFTWARE | PROGRAMME
- 1x Microsoft Windows Computer with Internet connection

OR

- 1x **FLASH LINK MOBILE**
- 1x **FLASH LINK MOBILE APP**
- Smartphone *Android* or *iOS* with Internet connection
(Internet provider charges may apply)

BEFORE PROGRAMMING SET THE UNIT OPTIONS AND SAVE.

1

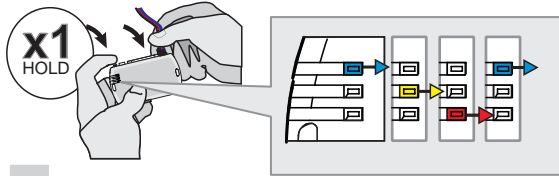

Press and hold the programming button:
Insert the 4-Pin (Data-Link) connector.

↳ The Blue, Red, Yellow and Blue & Red LEDs will alternatively illuminate.

2

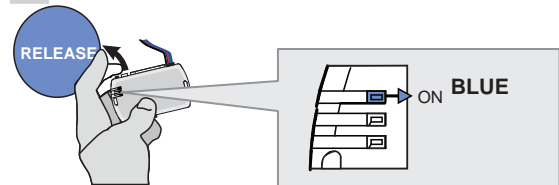

Release the programming button when the LED is BLUE.

If the LED is not solid BLUE disconnect the 4-Pin connector (Data-Link) and go back to step 1.

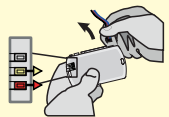

3

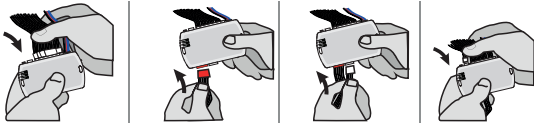

Insert the required remaining connectors.

4

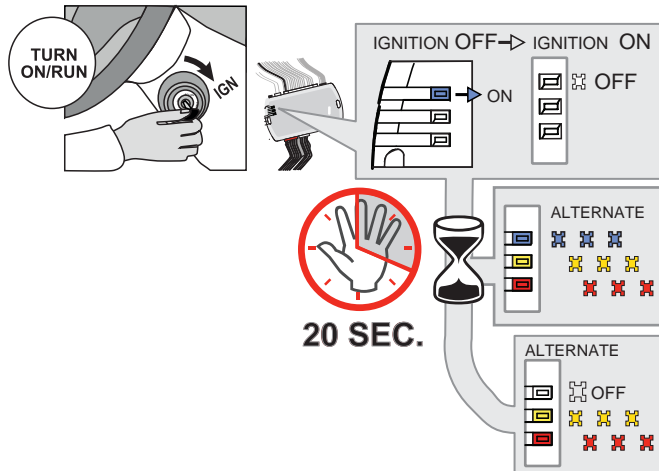

Turn the key to the Ignition ON/RUN position.

↳ The BLUE LED will turn OFF.

↳ The BLUE, YELLOW and RED LEDs will alternate.

Wait, at least 20 seconds, do not disconnect the modules or turn off the ignition.

↳ The RED and YELLOW LEDs will alternate.

Make sure that the DELs are flashing RED and YELLOW before continuing programming.



5

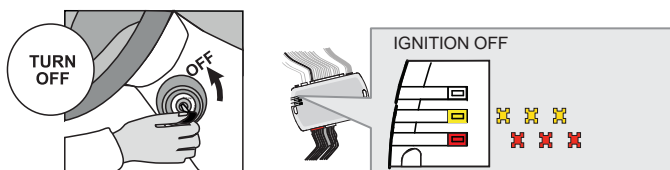

Turn the key to the OFF position.

↳ The RED and YELLOW LEDs alternate.

KEY BYPASS PROGRAMMING PROCEDURE 2/2 |

16

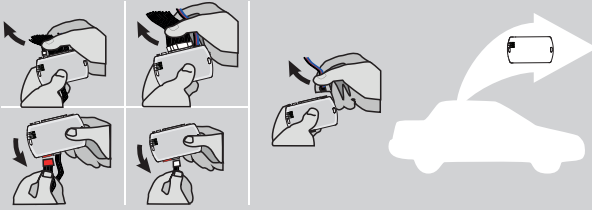

Disconnect all the connectors and after the Data-Link (4-pins) connector.

17

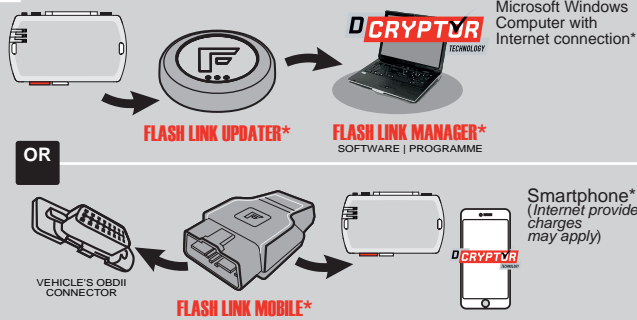

Use the tool: **FLASH LINK UPDATER** or **FLASH LINK MOBILE** to visit the DCRYPTOR menu.

*Parts required (not included)

18

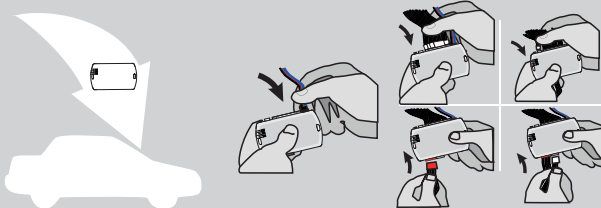

AFTER DCRYPTOR PROGRAMMING COMPLETED
Go back to the vehicle and **reconnect** the 4-Pin (Data-Link) connector and after, all the remaining connector.

9

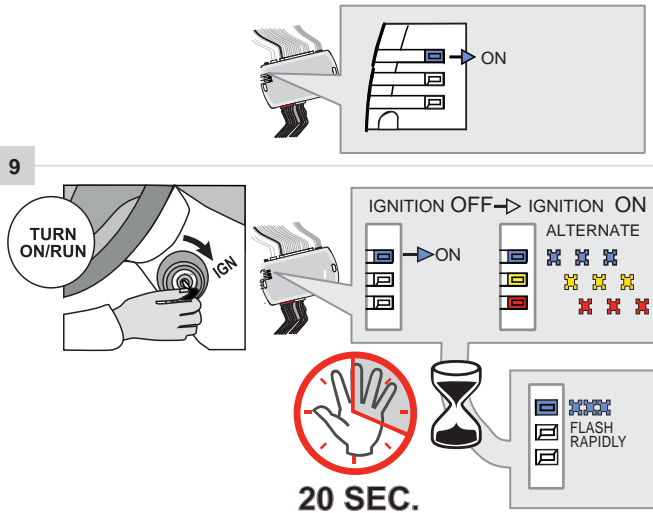

↳ The BLUE LED will turn ON.

Turn the key to the Ignition ON/RUN position.

↳ The RED and YELLOW LEDs will turn ON.

Wait, at least 20 seconds, do not disconnect the modules or turn off the ignition.

↳ The BLUE LED will flash rapidly.

10

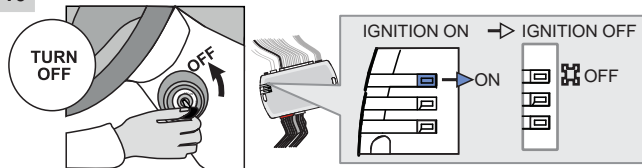

Turn the key to the OFF position.

↳ The BLUE will turn OFF.



The module is now programmed.

REMOTE STARTER FUNCTIONALITY |



All doors must be closed.



Remote start the vehicle.



Unlock the doors with the remote-starter remote or the OEM remote.



Insert and Turn the key to the Ignition ON/RUN position.



Press the brake pedal.



The vehicle can now be put in to gear and driven.

REGULAR & THAR-FOR3 INSTALLATION

ADDENDUM - SUGGESTED WIRING CONFIGURATION



ONLY COMPATIBLE WITH AUTOMATIC TRANSMISSION VEHICLES.



Vehicle functions supported in this diagram (functional if equipped)

VEHICLE	YEARS	Immobilizer bypass	Lock	Unlock	Arm	Disarm	RAP Disable	Parking Lights	Tachometer	Heated seats	Heated Mirrors	Rear defrost	Door Status	Trunk Status	Hood Status*	Hand-Brake Status	Foot-Brake Status	Active OEM Remote Start
FORD																		
F-150	Key 2020	•	•	•	•	•	•	•	•	•	•	•	•	•	•	•	•	•
F-250	Key 2020	•	•	•	•	•	•	•	•	•	•	•	•	•	•	•	•	•
F-350	Key 2020	•	•	•	•	•	•	•	•	•	•	•	•	•	•	•	•	•
F-450	Key 2020	•	•	•	•	•	•	•	•	•	•	•	•	•	•	•	•	•

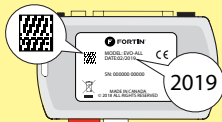

COMPATIBLE MODULE REQUIRED:

QR CODE ON THE LABEL
MANUFACTURED AFTER: 2019

FIRMWARE VERSION

58.[02]
MINIMUM

To add the firmware version and the options, use the **FLASH LINK UPDATER** or **FLASH LINK MOBILE** tool, sold separately.



Program bypass option:

UNIT OPTION

C1

DESCRIPTION

OEM Remote status (Lock/Unlock) monitoring

IF THE VEHICLE IS NOT EQUIPPED WITH FUNCTIONAL HOOD PIN:

A11

OFF

Hood trigger (Output Status).

NOTES

The vehicles OEM remote and SmartKey are still operable during remote start.

**Heated seats The heated seats and rear defrost activate automatically when it cold.

***Parking Lights The parking Lights at remote start only.



The vehicle must be equipped with the OEM remote with the door locks.

MANDATORY INSTALL

*HOOD PIN



HOOD STATUS: THE HOOD PIN SWITCH MUST BE INSTALLED IF THE VEHICLE CAN BE REMOTE STARTED WITH THE HOOD OPEN, SET FUNCTION A11 TO OFF.

A11

OFF

Notice: the installation of safety elements are mandatory. The hood pin is an essential security element and must be installed.

THIS MODULE MUST BE INSTALLED BY A QUALIFIED TECHNICIAN. A WRONG CONNECTION CAN CAUSE PERMANENT DAMAGE TO THE VEHICLE.

DESCRIPTION

		Parts required (Not included)	PAGE
WIRE TO WIRE DIAGRAM			
AUTOMATIC TRANSMISSION		1x 7.5 Amp. fuse	Page 3
THARNESS DIAGRAM			
THARNESS THAR-FOR3	AUTOMATIC TRANSMISSION	1x THAR-FOR3	Page 4



① Gateway module, located at dash board driver's side,

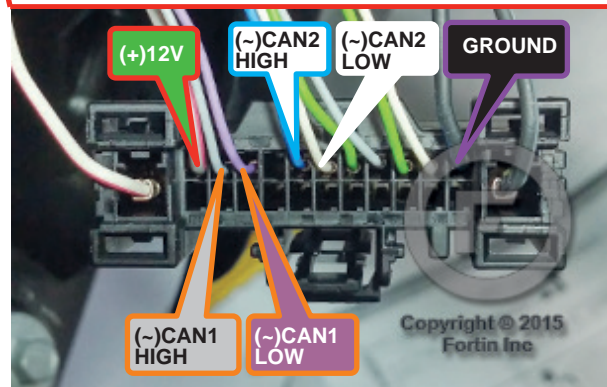

② Under the hood If not equipped with hood pin.

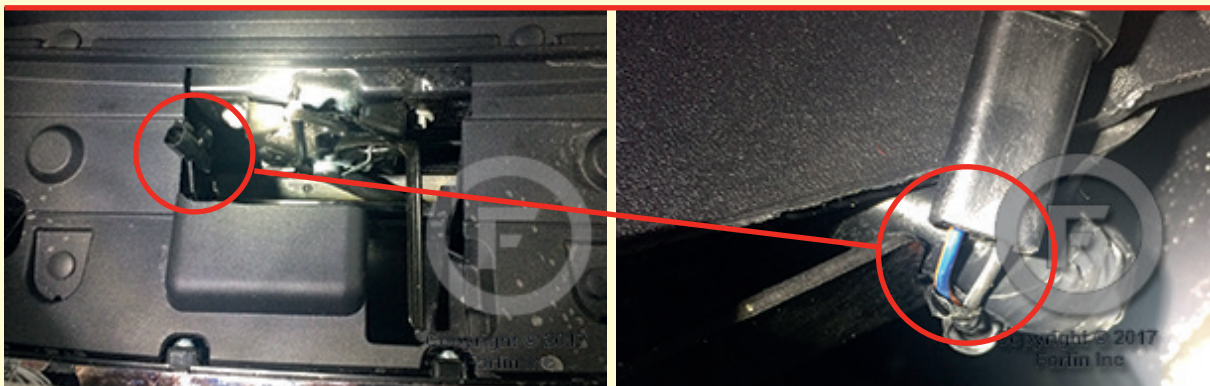

AUTOMATIC TRANSMISSION WIRING CONNECTION

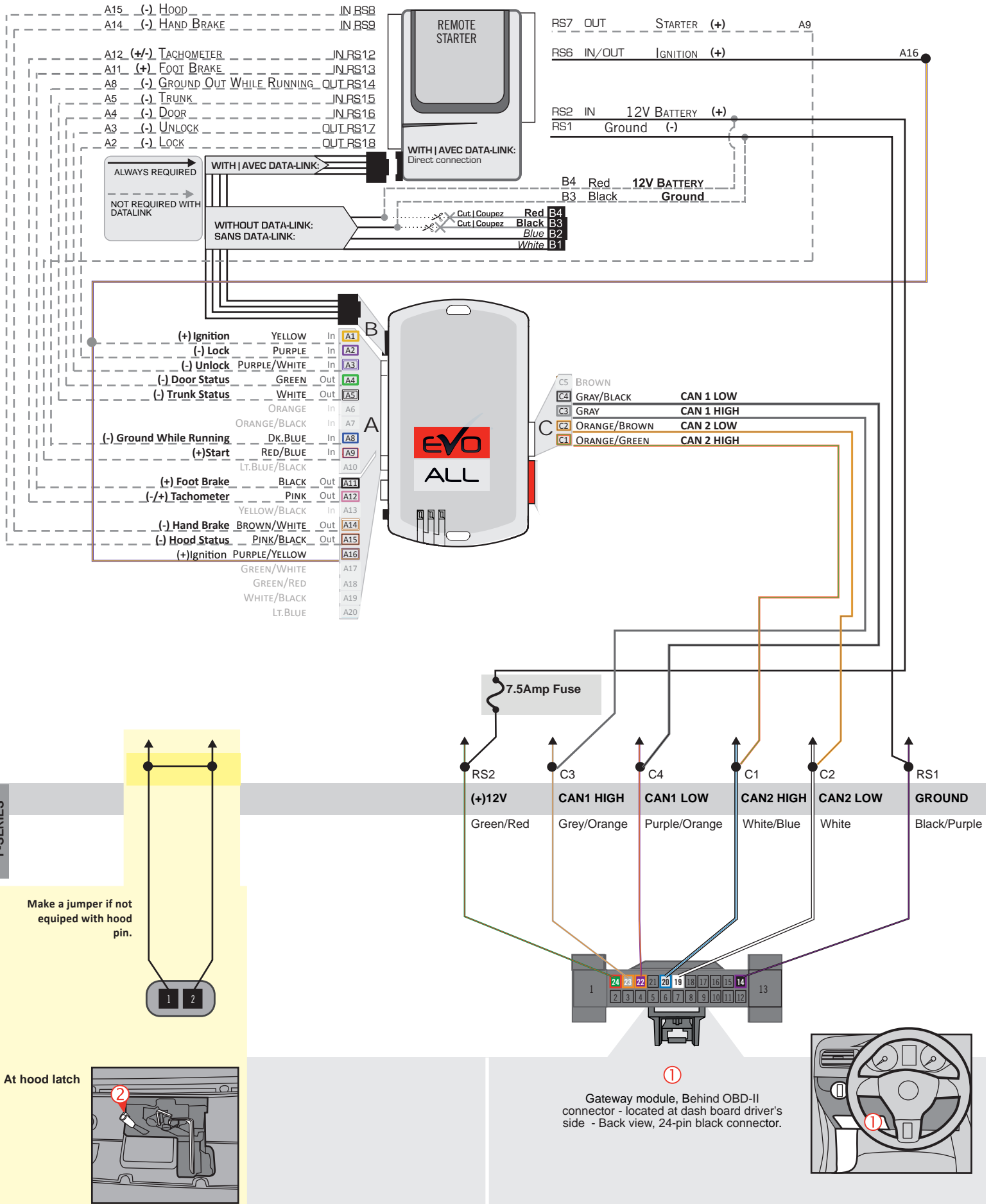

THAR-FOR3 | T-HARNESS - AUTOMATIC TRANSMISSION

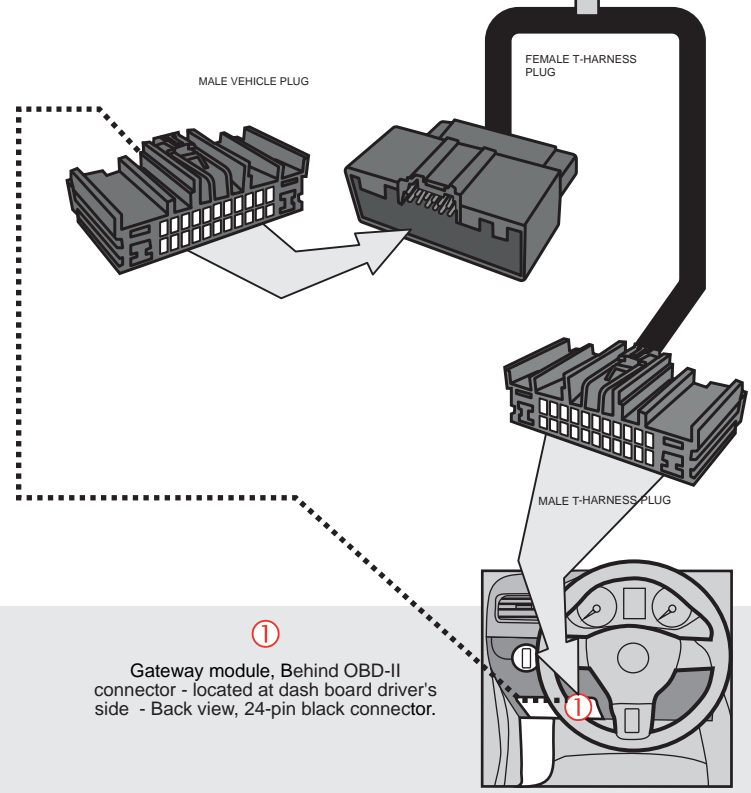
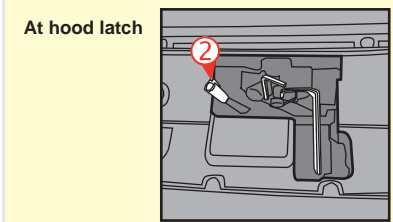
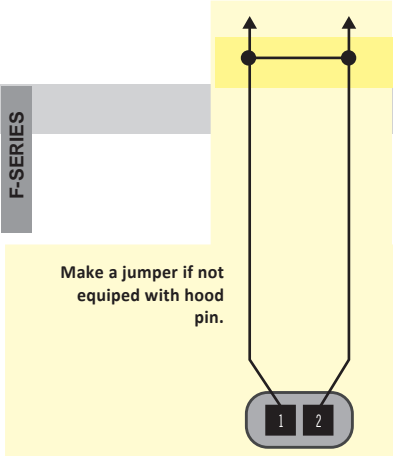
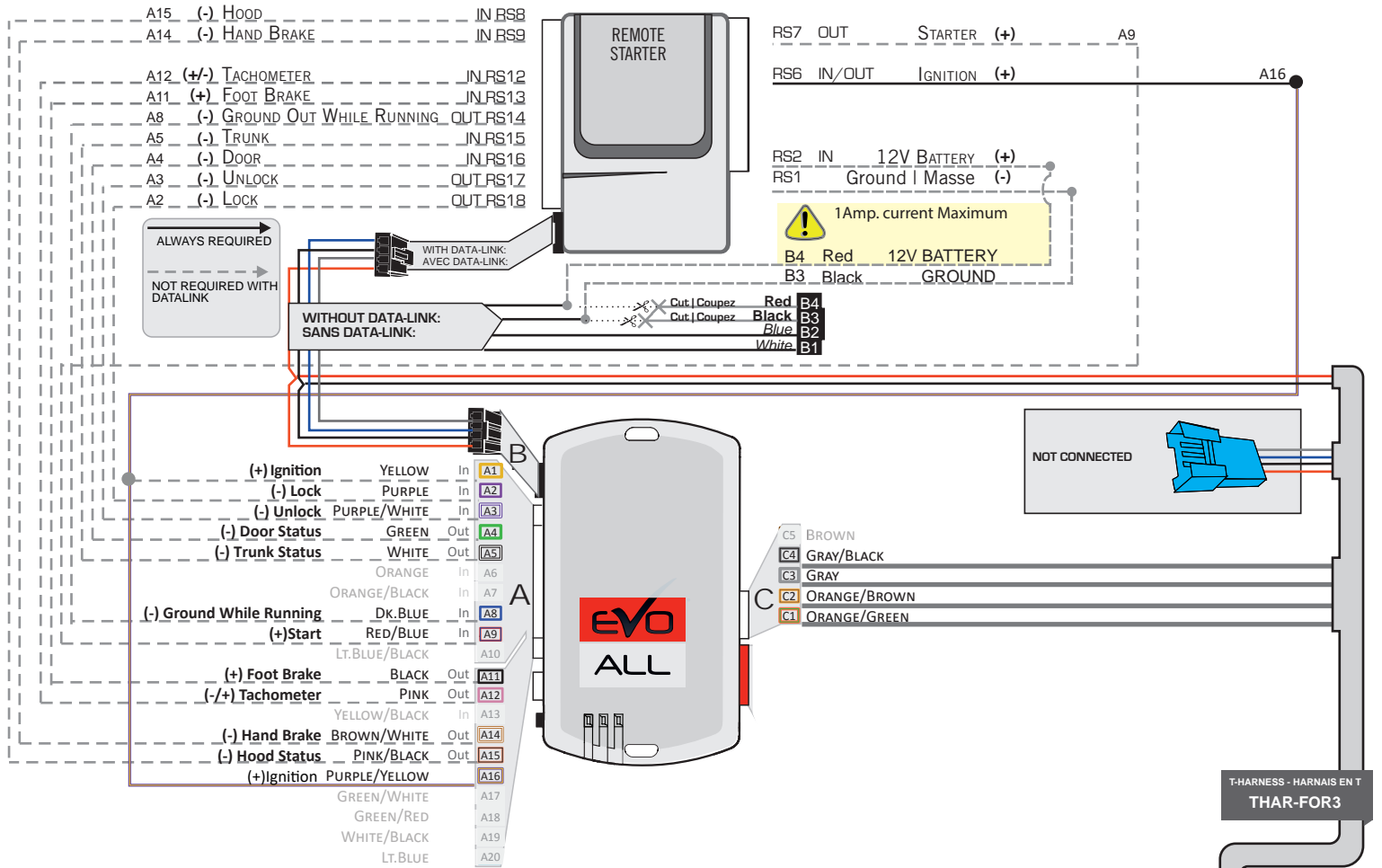

DCRYPTOR PROGRAMMING PROCEDURE



Parts required (not included)

- 1x **FLASH LINK UPDATER,**
- 1x **FLASH LINK MANAGER**
SOFTWARE | PROGRAMME
- 1x Microsoft Windows Computer with Internet connection

OR

- 1x **FLASH LINK MOBILE**
- 1x **FLASH LINK MOBILE APP**
- Smartphone *Android* or *iOS* with Internet connection
(Internet provider charges may apply)

BEFORE PROGRAMMING SET THE UNIT OPTIONS AND SAVE.

1

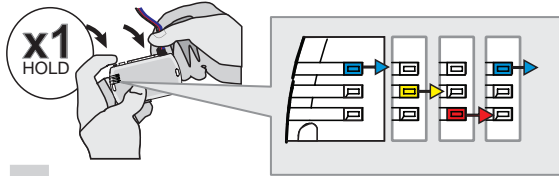

Press and hold the programming button:
Insert the 4-Pin (Data-Link) connector.

↳ The Blue, Red, Yellow and Blue & Red LEDs will alternatively illuminate.

2

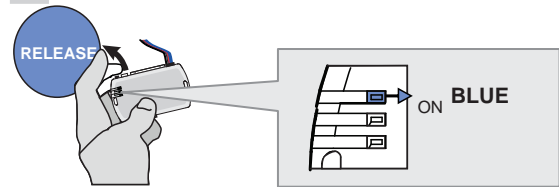

Release the programming button when the LED is **BLUE**.

If the LED is not solid BLUE disconnect the 4-Pin connector (Data-Link) and go back to step 1.

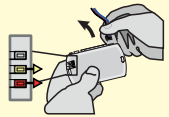

3

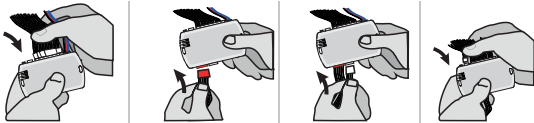

Insert the required remaining connectors.

4

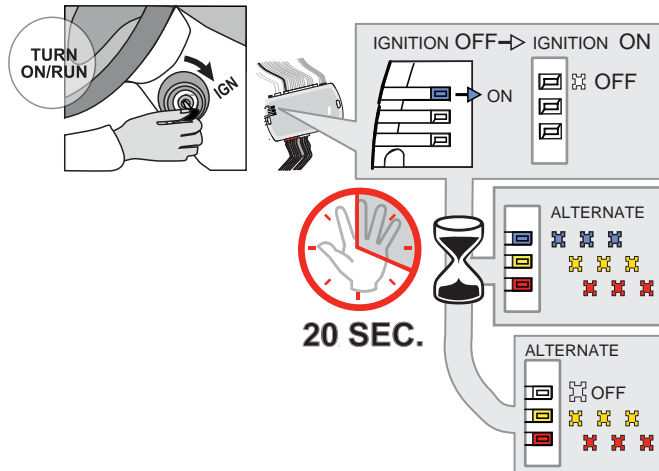

Turn the key to the Ignition ON/RUN position.

↳ The BLUE LED will turn OFF.

↳ The BLUE, YELLOW and RED LEDs will alternate.

Wait, at least 20 seconds, do not disconnect the modules or turn off the ignition.

↳ The RED and YELLOW LEDs will alternate.

Make sure that the DELs are flashing RED and YELLOW before continuing programming.

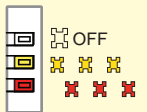

5

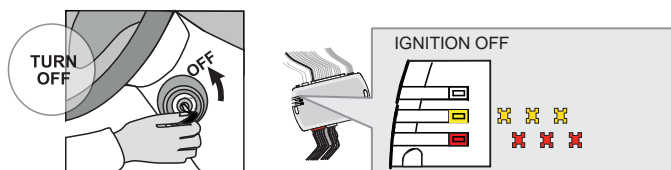

Turn the key to the OFF position.

↳ The RED and YELLOW LEDs alternate.

KEY BYPASS PROGRAMMING PROCEDURE 2/2

6

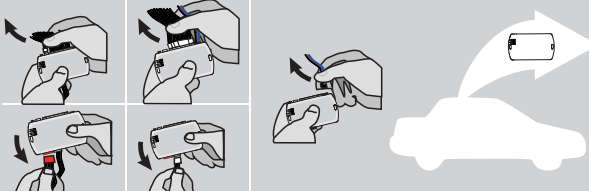

Disconnect all the connectors and after the Data-Link (4-pins) connector.

7



Microsoft Windows Computer with Internet connection*

FLASH LINK UPDATER* **FLASH LINK MANAGER***
SOFTWARE | PROGRAMME

OR

Smartphone* (Internet provider charges may apply)

FLASH LINK MOBILE*

VEHICLE'S OBDII CONNECTOR

Use the tool: FLASH LINK UPDATER or FLASH LINK MOBILE to visit the DCryptor menu.

*Parts required (not included)

8

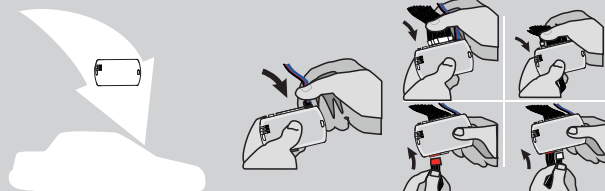

AFTER DCRYPTOR PROGRAMMING COMPLETED
Go back to the vehicle and reconnect the 4-Pin (Data-Link) connector and after, all the remaining connector.



↳ The BLUE LED will turn ON.

9

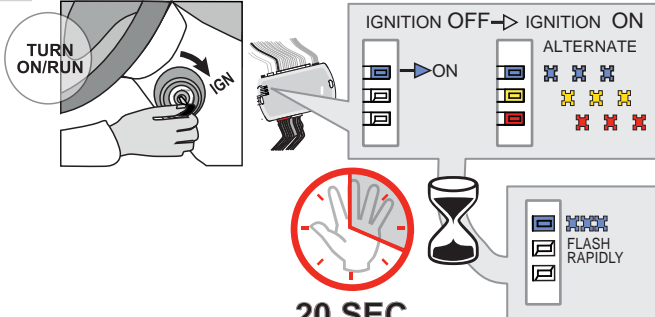

TURN ON/RUN

IGNITION OFF → IGNITION ON

ALTERNATE

↳ The RED and YELLOW LEDs will turn ON.

Wait, at least 20 seconds, do not disconnect the modules or turn off the ignition.

↳ The BLUE LED will flash rapidly.

20 SEC.

FLASH RAPIDLY

10

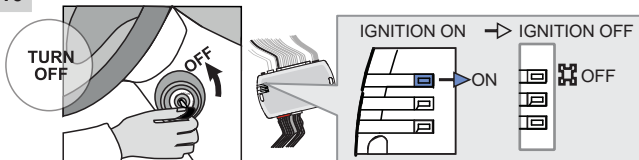

TURN OFF

IGNITION ON → IGNITION OFF

↳ The BLUE will turn OFF.



The module is now programmed.

REMOTE STARTER FUNCTIONALITY



All doors must be closed.



Remote start the vehicle.



Unlock the doors with the remote-starter remote or the OEM remote.



Insert and Turn the key to the Ignition ON/RUN position.



Press the brake pedal.



The vehicle can now be put in to gear and driven.

REGULAR & THAR-FOR3 INSTALLATION

ADDENDUM - SUGGESTED WIRING CONFIGURATION



ONLY COMPATIBLE WITH AUTOMATIC TRANSMISSION VEHICLES.



Vehicle functions supported in this diagram (functional if equipped)

VEHICLE	YEARS	Immobilizer bypass	Lock	Unlock	Arm	Disarm	RAP Disable	Parking Lights	Tachometer	Heated seats	Heated Mirrors	Rear defrost	Door Status	Trunk Status	Hood Status*	Hand-Brake Status	Foot-Brake Status	Active OEM Remote Start
FORD																		
F-150	Push-to-start 2020	•	•	•	•	•	•	•	•	•	•	•	•	•	•	•	•	•
F-250	Push-to-start 2020	•	•	•	•	•	•	•	•	•	•	•	•	•	•	•	•	•
F-350	Push-to-start 2020	•	•	•	•	•	•	•	•	•	•	•	•	•	•	•	•	•
F-450	Push-to-start 2020	•	•	•	•	•	•	•	•	•	•	•	•	•	•	•	•	•

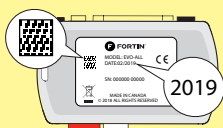

COMPATIBLE MODULE REQUIRED:

QR CODE ON THE LABEL
MANUFACTURED AFTER: 2019

FIRMWARE VERSION

58.[02]
MINIMUM

To add the firmware version and the options, use the **FLASH LINK UPDATER** or **FLASH LINK MOBILE** tool, sold separately.



Program bypass option:

UNIT OPTION

DESCRIPTION

C1

OEM Remote status (Lock/Unlock) monitoring

D6

Push-to-Start

IF THE VEHICLE IS NOT EQUIPPED WITH FUNCTIONAL HOOD PIN:

A11

OFF

Hood trigger (Output Status).

NOTES

The vehicles OEM remote and SmartKey are still operable during remote start.

**Heated seats The heated seats and rear defrost activate automatically when it cold.

***Parking Lights The parking Lights at remote start only.

MANDATORY INSTALL

*HOOD PIN



HOOD STATUS: THE HOOD PIN SWITCH MUST BE INSTALLED IF THE VEHICLE CAN BE REMOTE STARTED WITH THE HOOD OPEN, SET FUNCTION A11 TO OFF.

A11

OFF

Notice: the installation of safety elements are mandatory. The hood pin is an essential security element and must be installed.

THIS MODULE MUST BE INSTALLED BY A QUALIFIED TECHNICIAN. A WRONG CONNECTION CAN CAUSE PERMANENT DAMAGE TO THE VEHICLE.

DESCRIPTION | DESCRIPTION

		Parts required (Not included)	PAGE
WIRE TO WIRE DIAGRAM			
AUTOMATIC TRANSMISSION		1x 7.5 Amp. fuse	Page 3
THARNESS DIAGRAM			
THARNESS THAR-FOR3	AUTOMATIC TRANSMISSION	1x THAR-FOR3	Page 4



① Gateway module, located at dash board driver's side,

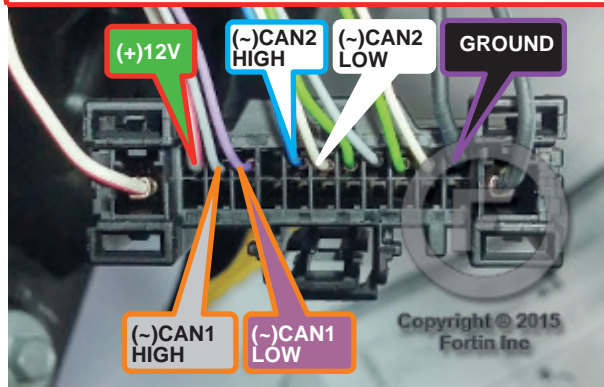

② Under the hood If not equipped with hood pin.



AUTOMATIC TRANSMISSION WIRING CONNECTION |

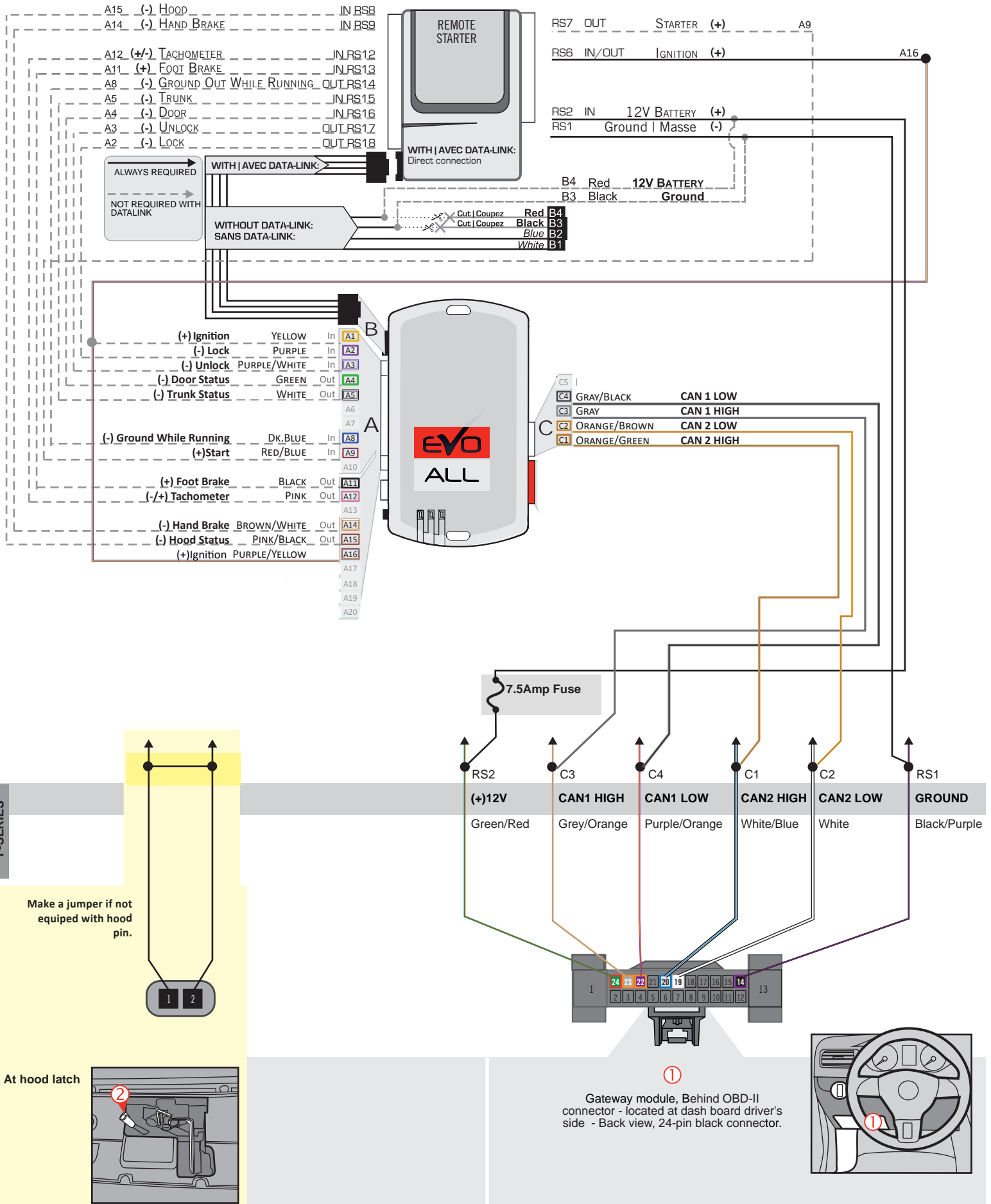

THAR-FOR3 | T-HARNESS - AUTOMATIC TRANSMISSION |

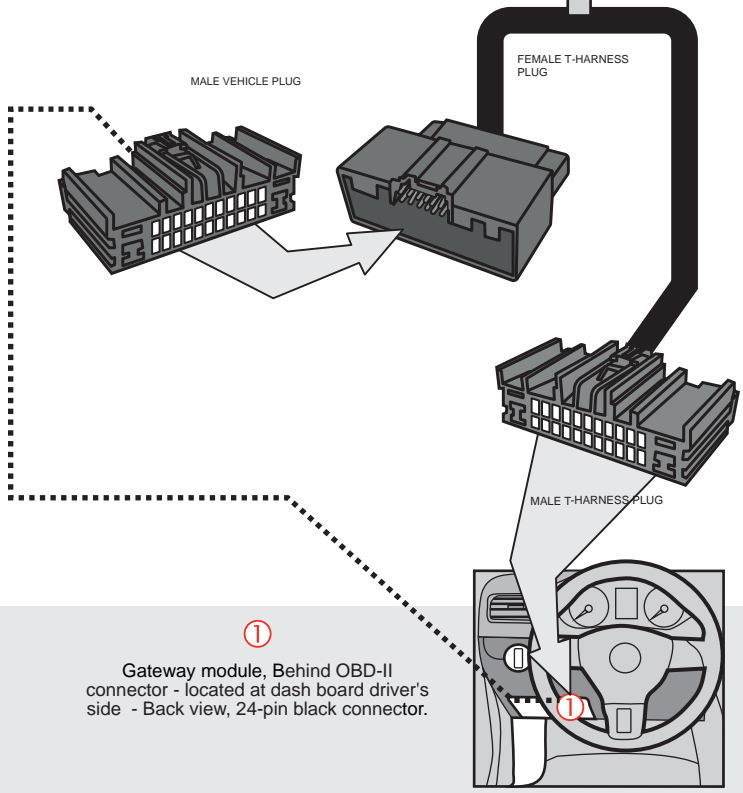
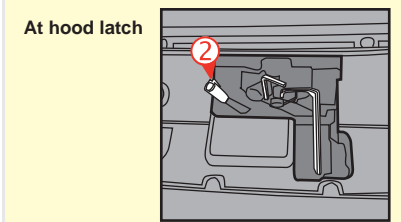
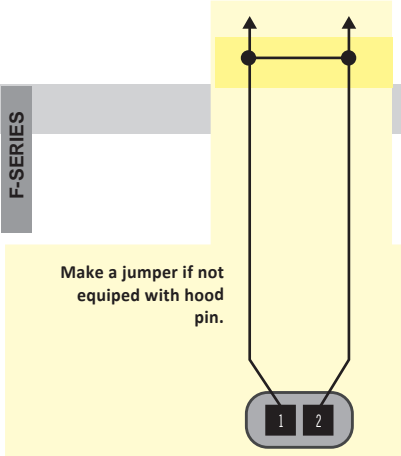
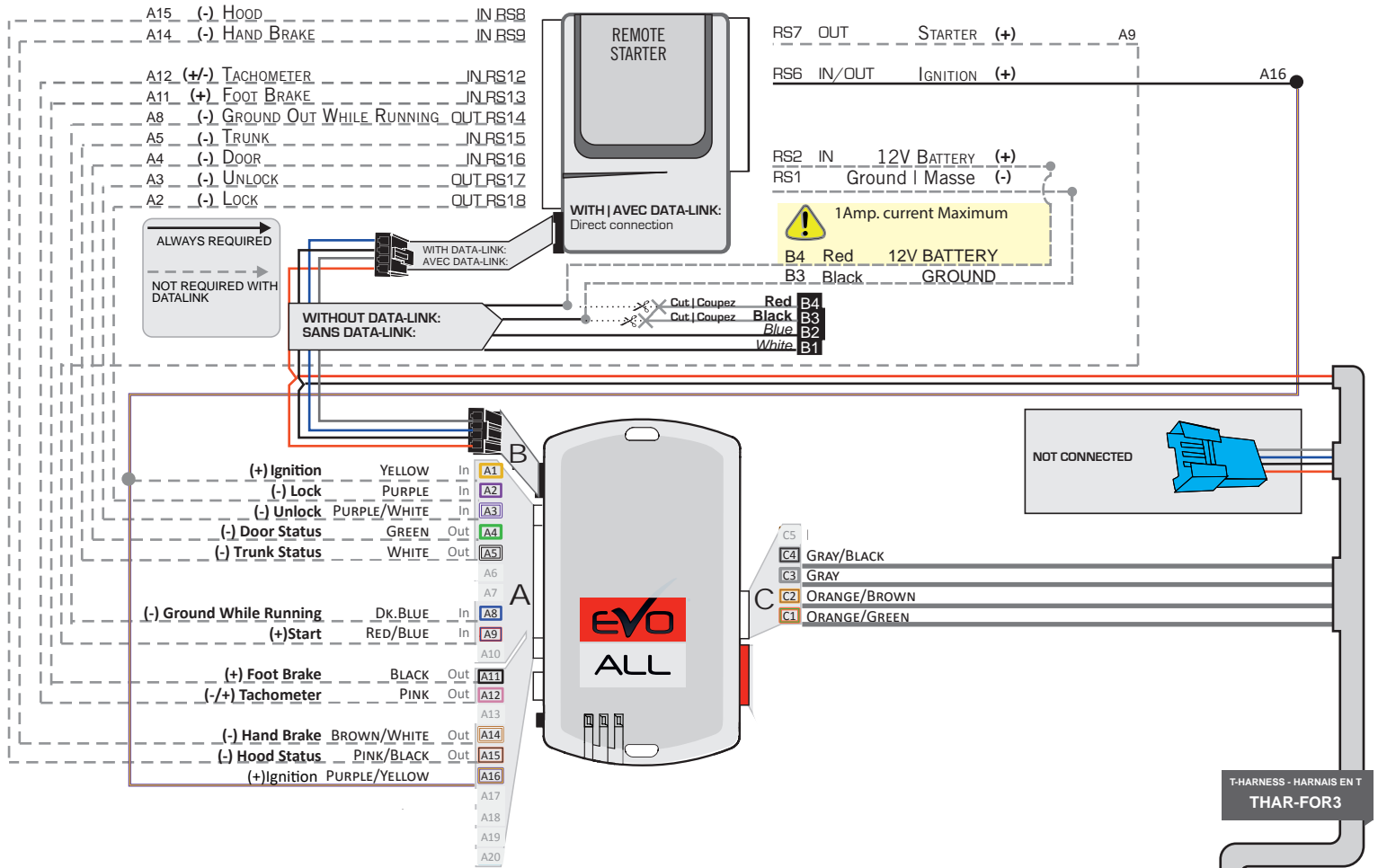



Parts required (not included)

- 1x FLASH LINK UPDATER, SOFTWARE | PROGRAMME
- 1x FLASH LINK MANAGER
- 1x Microsoft Windows Computer with Internet connection

OR

- 1x FLASH LINK MOBILE
- 1x FLASH LINK MOBILE APP
- Smartphone Android or iOS with Internet connection (Internet provider charges may apply)

BEFORE PROGRAMMING SET THE UNIT OPTIONS AND SAVE.

1

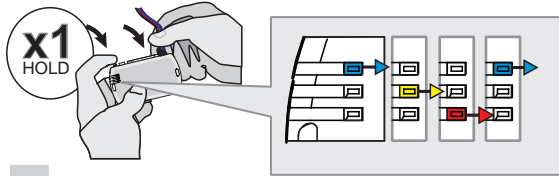

Press and hold the programming button:
Insert the 4-Pin (Data-Link) connector.

↳ The Blue, Red, Yellow and Blue & Red LEDs will alternatively illuminate.

2

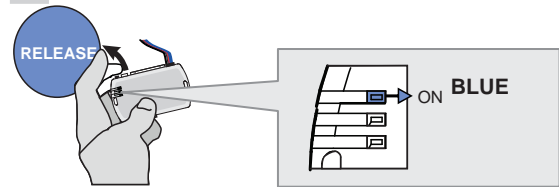

Release the programming button when the LED is BLUE.

If the LED is not solid BLUE disconnect the 4-Pin connector (Data-Link) and go back to step 1.

3

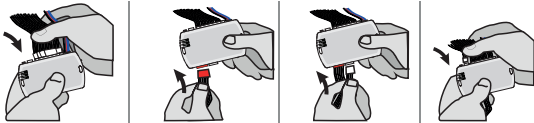

Insert the required remaining connectors.

4

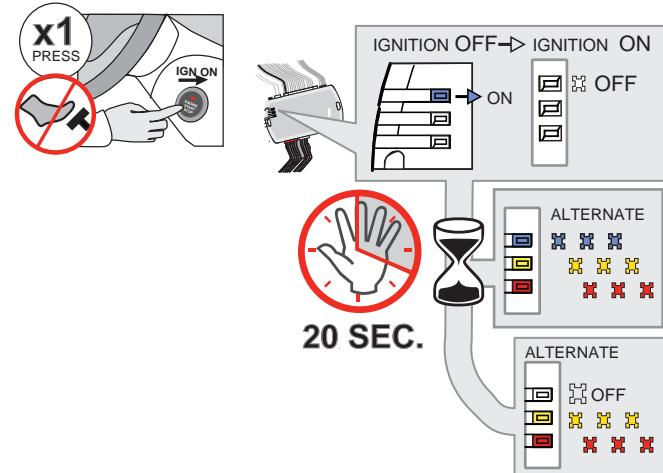

Do not press the brake pedal.
Press the Push-to-Start button once to turn on the ignition.

↳ The BLUE LED will turn OFF.

↳ The BLUE, YELLOW and RED LEDs will alternate.

Wait, at least 20 seconds, do not disconnect the modules or turn off the ignition.

↳ The RED and YELLOW LEDs will alternate.

Make sure that the DELs are flashing RED and YELLOW before continuing programming.

5

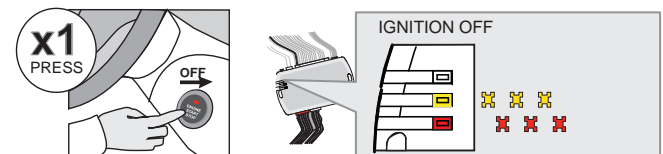

Press the Push-to-Start button once to turn off the ignition.

↳ The RED and YELLOW LEDs alternate.

KEY BYPASS PROGRAMMING PROCEDURE 2/2 |

6

Disconnect all the connectors and after the Data-Link (4-pins) connector.

7

Microsoft Windows Computer with Internet connection*

FLASH LINK UPDATER* **FLASH LINK MANAGER*** SOFTWARE | PROGRAMME

OR

Smartphone* (Internet provider charges may apply)

VEHICLE'S OBDII CONNECTOR **FLASH LINK MOBILE***

Use the tool:
FLASH LINK UPDATER or **FLASH LINK MOBILE**
 to visit the DCryptor menu.

*Parts required (not included)

8

AFTER DCRYPTOR PROGRAMMING COMPLETED
Go back to the vehicle and reconnect connector and after, all the remaining connector.

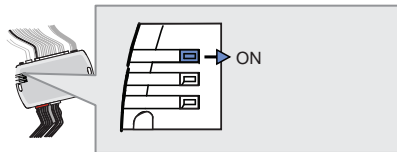

↳ The BLUE LED will turn ON.

9

x1 PRESS IGN ON

IGNITION OFF → IGNITION ON

ALTERNATE

20 SEC.

FLASH RAPIDLY

Do not press the brake pedal. **Press** the Push-to-Start button once to turn on the ignition.

↳ The RED and YELLOW LEDs will turn ON.

Wait, at least 20 seconds, do not disconnect the modules or turn off the ignition.

↳ The BLUE LED will flash rapidly.

10

x1 PRESS OFF

IGNITION ON → IGNITION OFF





OFF

Press the Push-to-Start button once to turn off the ignition.

↳ The BLUE will turn OFF.

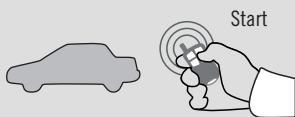
The module is now programmed.

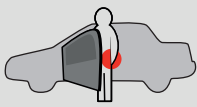
REMOTE STARTER FUNCTIONALITY |

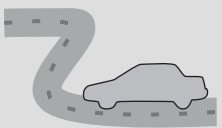
 <p>Start</p> <p>All doors must be closed.</p> <p>Remote start the vehicle.</p>	 <p>UNLOCK</p> <p>Unlock the doors with either:</p> <ul style="list-style-type: none"> • The OEM remote • The remote-starter remote • Or the proximity remote 	 <p>Enter the vehicle with the SMART-KEY.</p>	 <p>DO NOT PRESS THE BRAKE PEDAL.</p> <p>Press and release the Push-to-Start button once.</p>	 <p>Press the brake pedal. The vehicle can now be put in to gear and driven.</p> <p>If the Smart-Key is not detected the vehicle will shut down.</p>
--	---	--	---	---

REGULAR & THAR-FOR3 INSTALLATION

ADDENDUM - SUGGESTED WIRING CONFIGURATION



Vehicle functions supported in this diagram (functional if equipped)

VEHICLE	YEARS	Immobilizer bypass	T-Harness available (sold separately)	Lock	Unlock	Arm	Disarm	Heated Seats**	Rear Defrost**	RAP Disable	Parking Lights****	Tachometer	Door Status	Trunk Status	Hood Status*	Hand-Brake Status	Foot-Brake Status	Active OEM Remote Start
FORD																		
Fusion	Key 2020	•	•	•	•	•	•	•	•	•	•	•	•	•	•	•	•	•
	Hybrid Key 2020	•	•	•	•	•	•	•	•	•	•	•	•	•	•	•	•	•

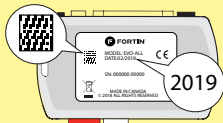

COMPATIBLE MODULE REQUIRED:

QR CODE ON THE LABEL
MANUFACTURED AFTER: 2019

FIRMWARE VERSION

58.[02]
MINIMUM

To add the firmware version and the options, use the **FLASH LINK UPDATER** or **FLASH LINK MOBILE** tool, sold separately.

	UNIT OPTION	DESCRIPTION
<p>Program bypass option:</p>	C1	OEM Remote status (Lock/Unlock) monitoring
<p>IF THE VEHICLE IS NOT EQUIPPED WITH FUNCTIONAL HOOD PIN:</p>	A11 OFF	Hood trigger (Output Status).
<p>Program bypass option (Vehicle hybrid only):</p>	D4	Hybrid mode (Vehicle hybrid only)

NOTES

The vehicles OEM remote and SmartKey are still operable during remote start.

**Heated seats The heated seats and rear defrost activate automatically when it cold.

***Parking Lights The parking Lights at remote start only.



The vehicle must be equipped with the OEM remote with the door locks.

MANDATORY INSTALL

*HOOD PIN



HOOD STATUS: THE HOOD PIN SWITCH MUST BE INSTALLED IF THE VEHICLE CAN BE REMOTE STARTED WITH THE HOOD OPEN, SET FUNCTION A11 TO OFF.

A11

OFF

Notice: the installation of safety elements are mandatory. The hood pin is an essential security element and must be installed.

THIS MODULE MUST BE INSTALLED BY A QUALIFIED TECHNICIAN. A WRONG CONNECTION CAN CAUSE PERMANENT DAMAGE TO THE VEHICLE.

DESCRIPTION

	Parts required (Not included)	PAGE
--	-------------------------------	------

WIRE TO WIRE DIAGRAM

AUTOMATIC TRANSMISSION	1x 7.5 Amp. fuse	Page 3
------------------------	------------------	--------

THARNES DIAGRAM

THARNES THAR-FOR3 AUTOMATIC TRANSMISSION	1x THAR-FOR3	Page 4
--	--------------	--------



②

Parking Lights switch

①

Gateway module, Behind OBD-II connector

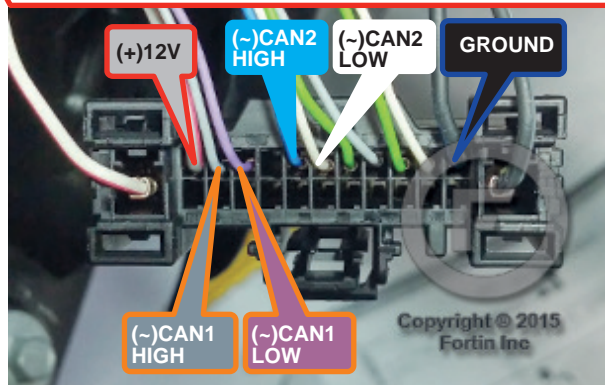
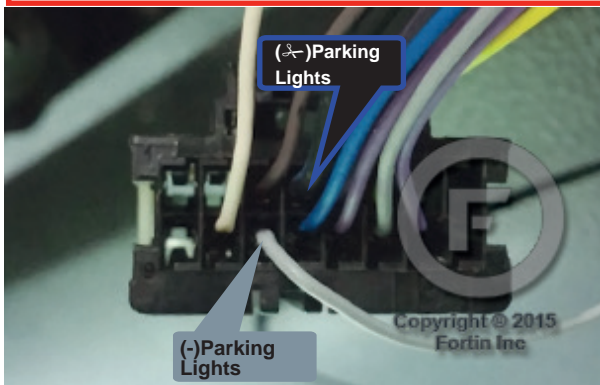

AUTOMATIC TRANSMISSION WIRING CONNECTION |

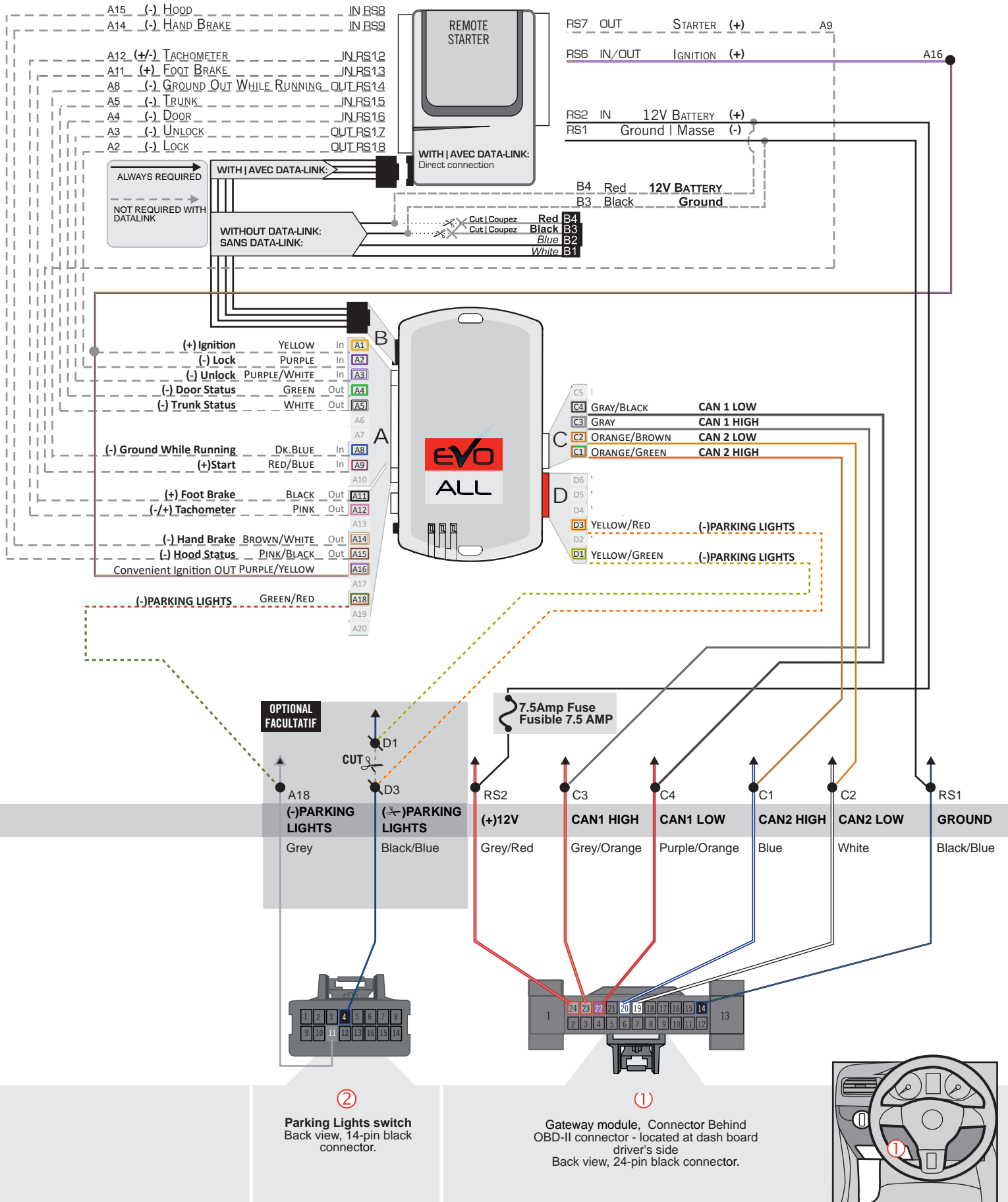

THAR-FOR3 | T-HARNESS - AUTOMATIC TRANSMISSION |

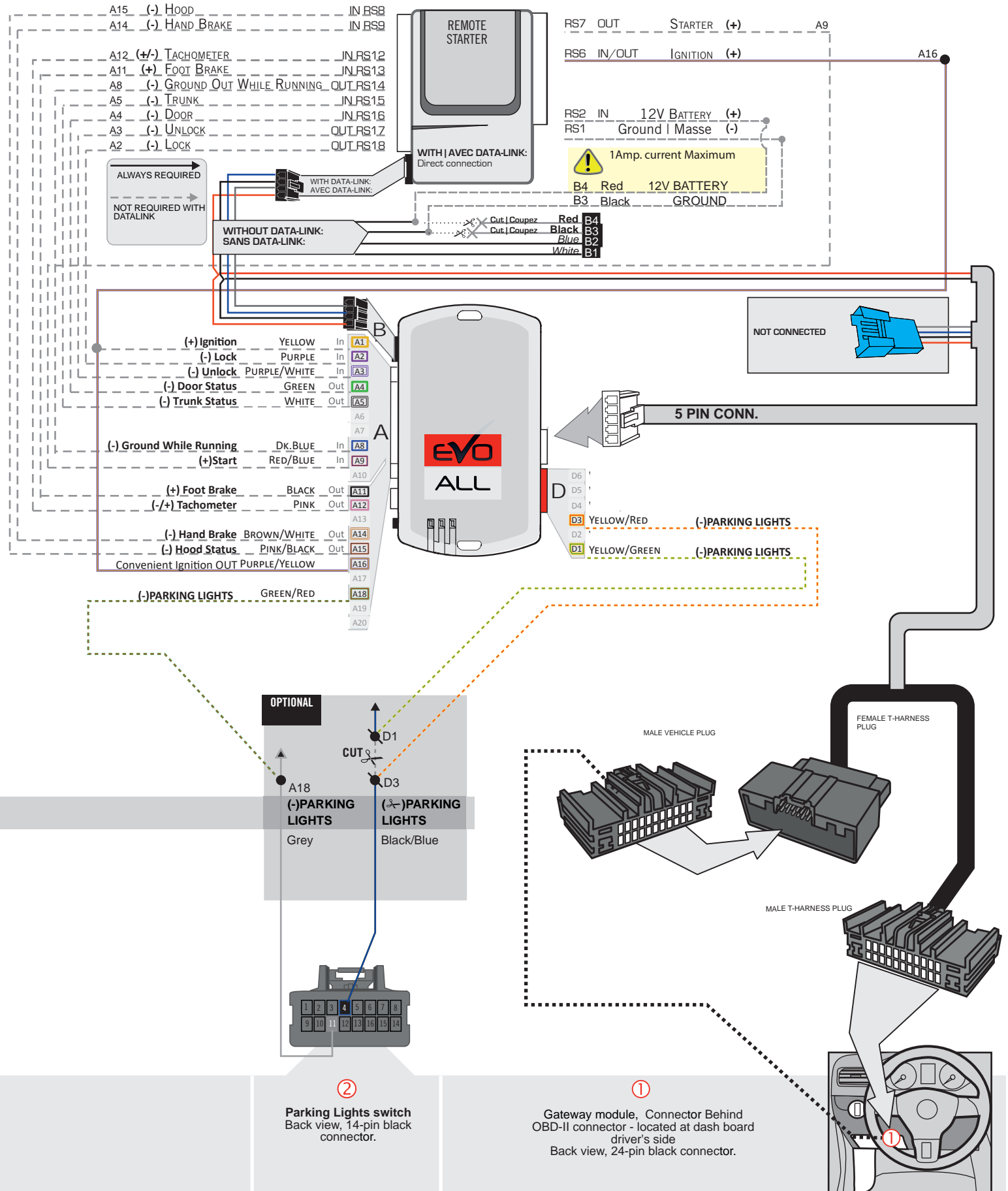



Parts required (not included)

- 1x FLASH LINK UPDATER, SOFTWARE | PROGRAMME
- 1x FLASH LINK MANAGER
- 1x Microsoft Windows Computer with Internet connection

OR
OU

- 1x FLASH LINK MOBILE
- 1x FLASH LINK MOBILE APP
- Smartphone Android or iOS with Internet connection (Internet provider charges may apply)

BEFORE PROGRAMMING SET THE UNIT OPTIONS AND SAVE.

1

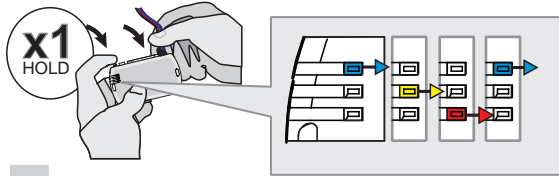

Press and hold the programming button:
Insert the 4-Pin (Data-Link) connector.

↳ The Blue, Red, Yellow and Blue & Red LEDs will alternatively illuminate.

2

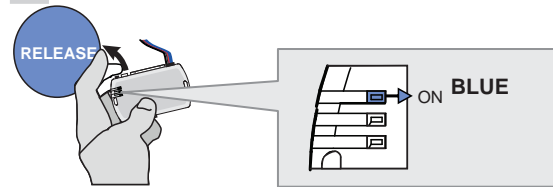

Release the programming button when the LED is BLUE.

If the LED is not solid BLUE disconnect the 4-Pin connector (Data-Link) and go back to step 1.

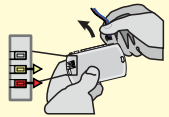

3

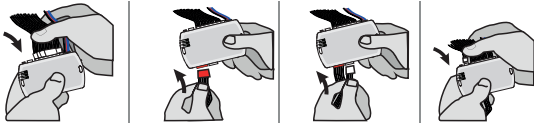

Insert the required remaining connectors.

4

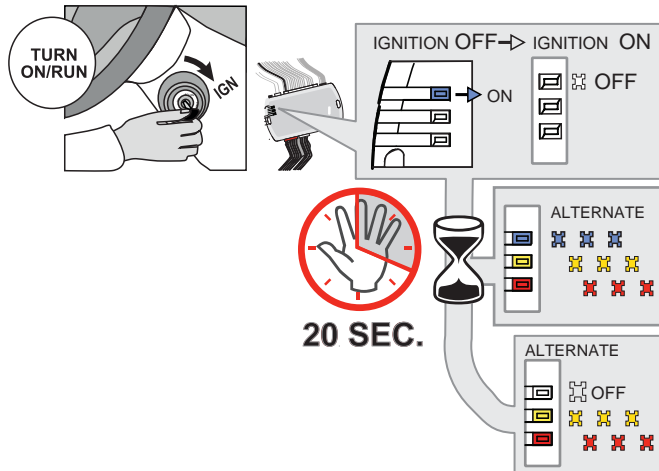

Turn the key to the Ignition ON/RUN position.

↳ The BLUE LED will turn OFF.

↳ The BLUE, YELLOW and RED LEDs will alternate.

Wait, at least 20 seconds, do not disconnect the modules or turn off the ignition.

↳ The RED and YELLOW LEDs will alternate.

Make sure that the DELs are flashing RED and YELLOW before continuing programming.

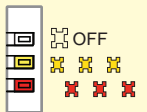

5

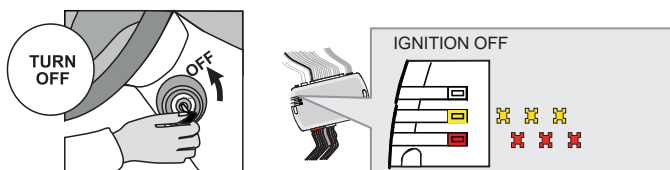

Turn the key to the OFF position.

↳ The RED and YELLOW LEDs alternate.

KEY BYPASS PROGRAMMING PROCEDURE 2/2 |

6

Disconnect all the connectors and after the Data-Link (4-pins) connector.

7

Microsoft Windows Computer with Internet connection*

FLASH LINK UPDATER* **FLASH LINK MANAGER***
SOFTWARE | PROGRAMME

OR

Smartphone* (Internet provider charges may apply)

VEHICLE'S OBDII CONNECTOR **FLASH LINK MOBILE***

Use the tool: FLASH LINK UPDATER or FLASH LINK MOBILE to visit the DCRYPTOR menu.

*Parts required (not included)

8

AFTER DCRYPTOR PROGRAMMING COMPLETED
Go back to the vehicle and reconnect the 4-Pin (Data-Link) connector and after, all the remaining connector.

APRÈS LA PROCÉDURE DE PROGRAMMATION DCRYPTOR COMPLÉTÉE : retournez au véhicule et rebranchez le connecteur 4-pins (Data-Link) et après, tous les connecteurs du EVO-ALL.

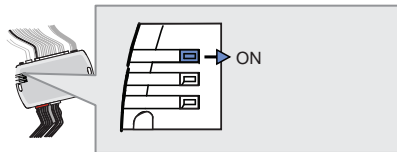

↳ The BLUE LED will turn ON.

9

TURN ON/RUN

IGNITION OFF → IGNITION ON

ALTERNATE

↳ The RED and YELLOW LEDs will turn ON.

20 SEC.

FLASH RAPIDLY

Wait, at least 20 seconds, do not disconnect the modules or turn off the ignition.

↳ The BLUE LED will flash rapidly.

10

TURN OFF

IGNITION ON → IGNITION OFF

↳ The BLUE will turn OFF.

The module is now programmed.

REMOTE STARTER FUNCTIONALITY |



All doors must be closed.



Remote start the vehicle.



Unlock the doors with the remote-starter remote or the OEM remote.



Insert and Turn the key to the Ignition ON/RUN position.



Press the brake pedal.



The vehicle can now be put in to gear and driven.

REGULAR & THAR-FOR3 INSTALLATION

ADDENDUM - SUGGESTED WIRING CONFIGURATION



Vehicle functions supported in this diagram (functional if equipped)



VEHICLE

YEARS

Immobilizer bypass	T-Harness available (sold separately)	Lock	Unlock	Arm	Disarm	Heated Seats**	Rear Defrost**	RAP Disable	Parking Lights***	Tachometer	Door Status	Trunk Status	Hood Status*	Hand-Brake Status	Foot-Brake Status	Active OEM Remote Start
--------------------	---------------------------------------	------	--------	-----	--------	----------------	----------------	-------------	-------------------	------------	-------------	--------------	--------------	-------------------	-------------------	-------------------------

FORD

Fusion	Push-to-Start	2020	•	•	•	•	•	•	•	•	•	•	•	•	•	•
	Hybrid Push-to-Start	2020	•	•	•	•	•	•	•	•	•	•	•	•	•	•

LINCOLN

Continental	Push-to-Start	2020	•	•	•	•	•	•	•	•	•	•	•	•	•	•
-------------	---------------	------	---	---	---	---	---	---	---	---	---	---	---	---	---	---

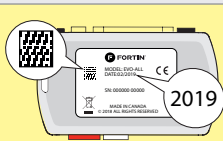

COMPATIBLE MODULE REQUIRED:

QR CODE ON THE LABEL
MANUFACTURED AFTER: 2019

FIRMWARE VERSION

58.[02]
MINIMUM

To add the firmware version and the options, use the **FLASH LINK UPDATER** or **FLASH LINK MOBILE** tool, sold separately.



Program bypass option:

UNIT OPTION

DESCRIPTION

C1

OEM Remote status (Lock/Unlock) monitoring

D6

Push-to-Start

IF THE VEHICLE IS NOT EQUIPPED WITH FUNCTIONAL HOOD PIN:

A11

OFF

Hood trigger (Output Status).

Program bypass option (Vehicle hybrid only):

D4

Hybrid mode (Vehicle hybrid only)

NOTES

The vehicles OEM remote and SmartKey are still operable during remote start.

**Heated seats The heated seats and rear defrost activate automatically when it cold.

***Parking Lights The parking Lights at remote start only.

MANDATORY INSTALL

*HOOD PIN



HOOD STATUS: THE HOOD PIN SWITCH MUST BE INSTALLED IF THE VEHICLE CAN BE REMOTE STARTED WITH THE HOOD OPEN, SET FUNCTION A11 TO OFF.

A11

OFF

Notice: the installation of safety elements are mandatory. The hood pin is an essential security element and must be installed.

THIS MODULE MUST BE INSTALLED BY A QUALIFIED TECHNICIAN. A WRONG CONNECTION CAN CAUSE PERMANENT DAMAGE TO THE VEHICLE.

DESCRIPTION | DESCRIPTION

	Parts required (Not included)	PAGE
--	-------------------------------	------

WIRE TO WIRE DIAGRAM

AUTOMATIC TRANSMISSION	1x 7.5 Amp. fuse	Page 3
------------------------	------------------	--------

THARNES DIAGRAM

THARNES THAR-FOR3 AUTOMATIC TRANSMISSION	1x THAR-FOR3	Page 4
--	--------------	--------



②

Parking Lights switch

①

Gateway module, Behind OBD-II connector

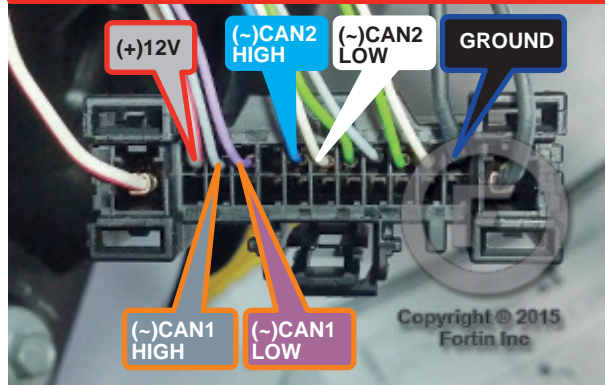
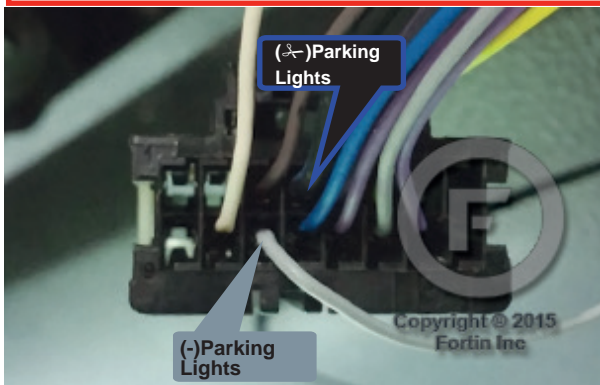

THAR-FOR3 | T-HARNESS - AUTOMATIC TRANSMISSION |

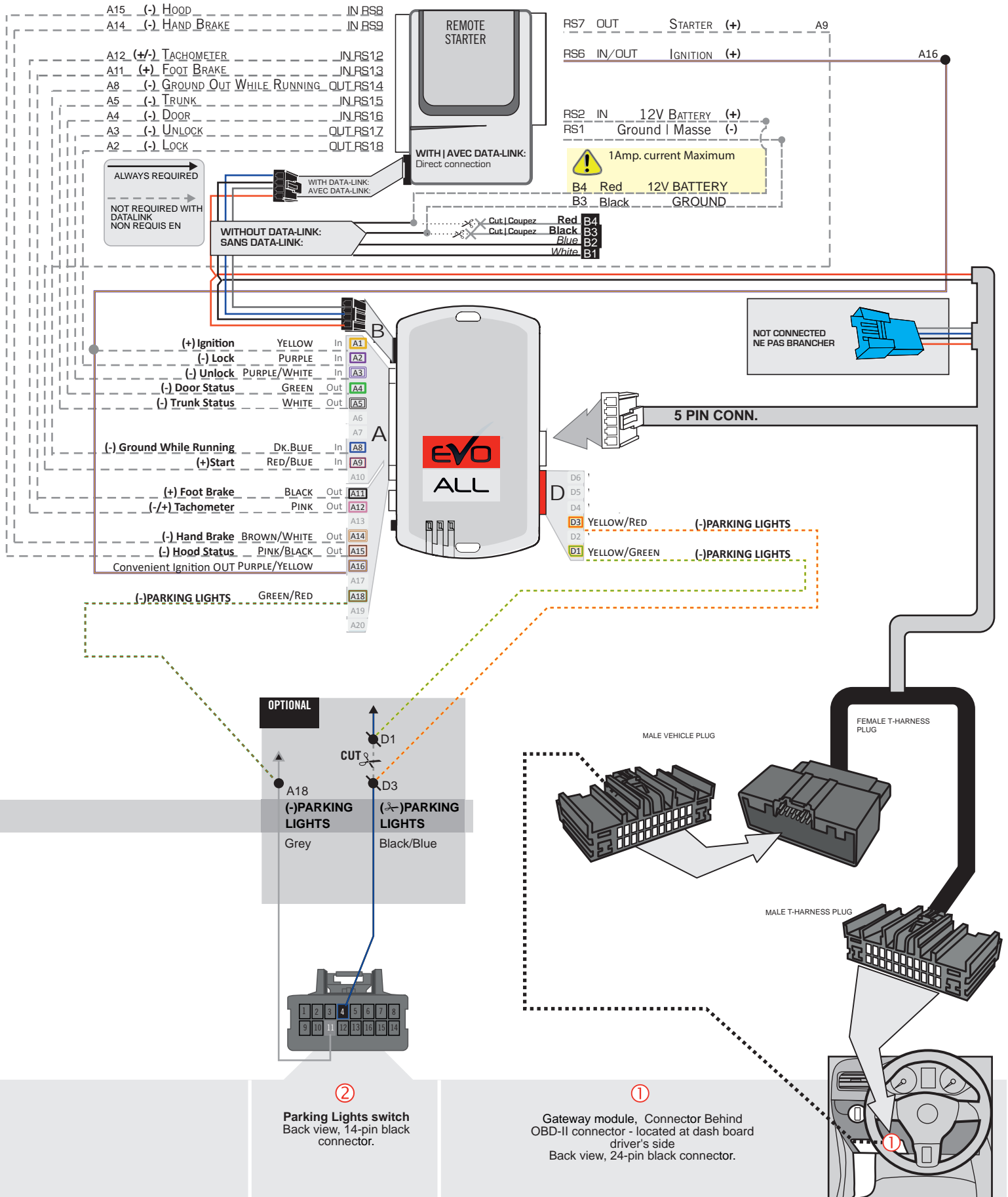



Parts required (not included)

- 1x FLASH LINK UPDATER, SOFTWARE | PROGRAMME
- 1x FLASH LINK MANAGER
- 1x Microsoft Windows Computer with Internet connection

OR

- 1x FLASH LINK MOBILE
- 1x FLASH LINK MOBILE APP
- Smartphone Android or iOS with Internet connection (Internet provider charges may apply)

BEFORE PROGRAMMING SET THE UNIT OPTIONS AND SAVE.

1

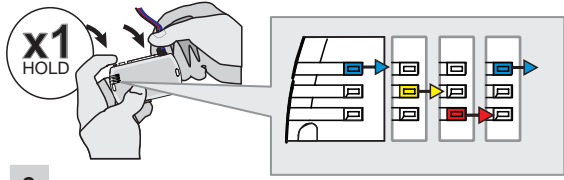

Press and hold the programming button:
Insert the 4-Pin (Data-Link) connector.

↳ The Blue, Red, Yellow and Blue & Red LEDs will alternatively illuminate.

2

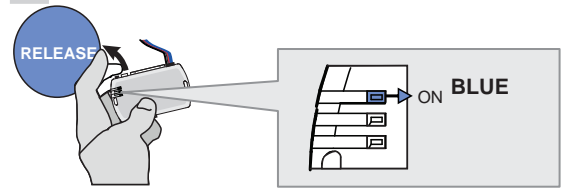

Release the programming button when the LED is BLUE.

If the LED is not solid BLUE disconnect the 4-Pin connector (Data-Link) and go back to step 1.

3

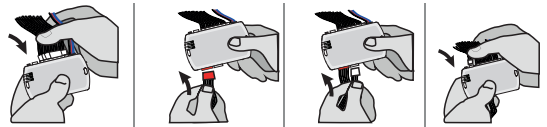

Insert the required remaining connectors.

4

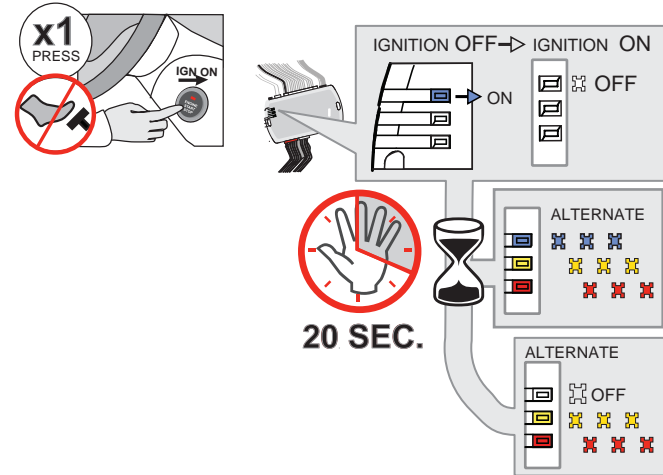

Do not press the brake pedal.
Press the Push-to-Start button once to turn on the ignition.

↳ The BLUE LED will turn OFF.

↳ The BLUE, YELLOW and RED LEDs will alternate.

Wait, at least 20 seconds, do not disconnect the modules or turn off the ignition.

↳ The RED and YELLOW LEDs will alternate.

Make sure that the DELs are flashing RED and YELLOW before continuing programming.

5

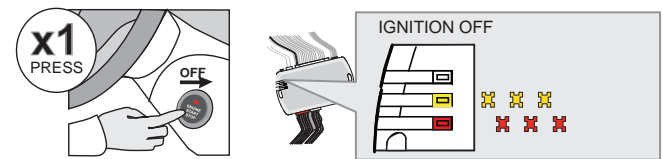

Press the Push-to-Start button once to turn off the ignition.

↳ The RED and YELLOW LEDs alternate.

KEY BYPASS PROGRAMMING PROCEDURE 2/2 |

6

Disconnect all the connectors and after the Data-Link (4-pins) connector.

7

Use the tool: **FLASH LINK UPDATER** or **FLASH LINK MOBILE** to visit the DCryptor menu.

OR

FLASH LINK UPDATER* **FLASH LINK MANAGER***
SOFTWARE | PROGRAMME

FLASH LINK MOBILE*

Smartphone*
(Internet provider charges may apply)

VEHICLE'S OBDII CONNECTOR

*Parts required (not included)

8

AFTER DCRYPTOR PROGRAMMING COMPLETED
Go back to the vehicle and **reconnect** connector and after, all the remaining connector.

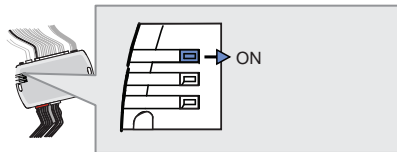

↳ The BLUE LED will turn ON.

9

x1 PRESS

IGNITION OFF → IGNITION ON

ALTERNATE

20 SEC.

FLASH RAPIDLY

Do not press the brake pedal. **Press** the Push-to-Start button once to turn on the ignition.

↳ The RED and YELLOW LEDs will turn ON.

Wait, at least 20 seconds, do not disconnect the modules or turn off the ignition.

↳ The BLUE LED will flash rapidly.

10

x1 PRESS

IGNITION ON → IGNITION OFF





Press the Push-to-Start button once to turn off the ignition.

↳ The BLUE will turn OFF.

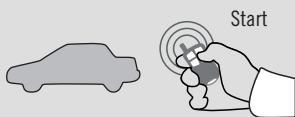

The module is now programmed.

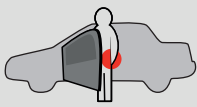
REMOTE STARTER FUNCTIONALITY |

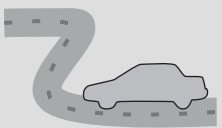
 <p>Start</p> <p>All doors must be closed.</p> <p>Remote start the vehicle.</p>	 <p>UNLOCK</p> <p>Unlock the doors with either:</p> <ul style="list-style-type: none"> • The OEM remote • The remote-starter remote • Or the proximity remote 	 <p>Enter the vehicle with the SMART-KEY.</p>	 <p>DO NOT PRESS THE BRAKE PEDAL.</p> <p>Press and release the Push-to-Start button once.</p>	 <p>Press the brake pedal. The vehicle can now be put in to gear and driven.</p> <p>If the Smart-Key is not detected the vehicle will shut down.</p>
--	---	--	---	---

REGULAR & THAR-FOR3 INSTALLATION

ADDENDUM - SUGGESTED WIRING CONFIGURATION



ONLY COMPATIBLE WITH AUTOMATIC TRANSMISSION VEHICLES.



Vehicle functions supported in this diagram (functional if equipped)

VEHICLE	YEARS	Immobilizer bypass	T-Harness available (sold separately)	Lock	Unlock	Arm	Disarm	Heated Seats**	Rear Defrost**	RAP Disable	Parking Lights***	Tachometer	Door Status	Trunk Status	Hood Status*	Hand-Brake Status	Foot-Brake Status	Active OEM Remote Start	
LINCOLN																			
Nautilus	Push-to-Start 2020	•	•	•	•	•	•	•	•	•	•	•	•	•	•	•	•	•	•

COMPATIBLE MODULE REQUIRED:

2019

QR CODE ON THE LABEL

MANUFACTURED AFTER: 2019

FIRMWARE VERSION

58.[02]

MINIMUM

To add the firmware version and the options, use the **FLASH LINK UPDATER** or **FLASH LINK MOBILE** tool, sold separately.

UNIT OPTION	DESCRIPTION
C1	OEM Remote status (Lock/Unlock) monitoring
D6	Push-to-Start
A11	<p>IF THE VEHICLE IS NOT EQUIPPED WITH FUNCTIONAL HOOD PIN:</p> <p>OFF Hood trigger (Output Status).</p>

NOTES

The vehicles OEM remote and SmartKey are still operable during remote start.

**Heated seats The heated seats and rear defrost activate automatically when it cold.

**Rear Defrost

***Parking Lights The parking Lights at remote start only.

MANDATORY INSTALL

*HOOD PIN

HOOD STATUS: THE HOOD PIN SWITCH MUST BE INSTALLED IF THE VEHICLE CAN BE REMOTE STARTED WITH THE HOOD OPEN, SET FUNCTION A11 TO OFF.

A11 **OFF**

Notice: the installation of safety elements are mandatory. The hood pin is an essential security element and must be installed.

THIS MODULE MUST BE INSTALLED BY A QUALIFIED TECHNICIAN. A WRONG CONNECTION CAN CAUSE PERMANENT DAMAGE TO THE VEHICLE.

Parts required (Not included) **PAGE**

WIRE TO WIRE DIAGRAM

AUTOMATIC TRANSMISSION	1x 7.5 Amp. fuse	Page 3
------------------------	------------------	--------

THARNESS DIAGRAM

THARNESS THAR-FOR3 AUTOMATIC TRANSMISSION	1x THAR-FOR3	Page 4
---	--------------	--------



②

Parking Lights switch

①

Gateway module, Behind OBD-II connector

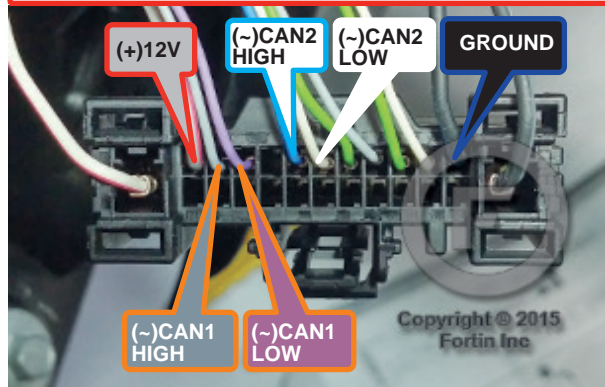
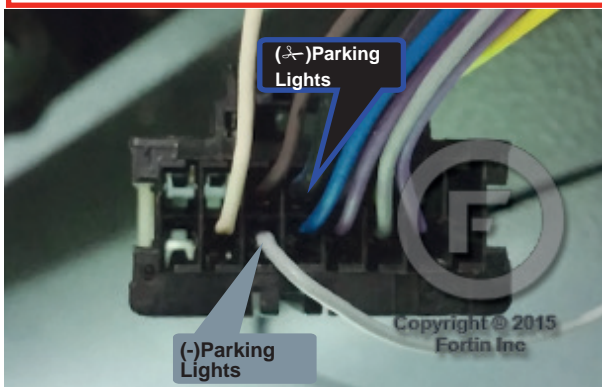

AUTOMATIC TRANSMISSION WIRING CONNECTION |

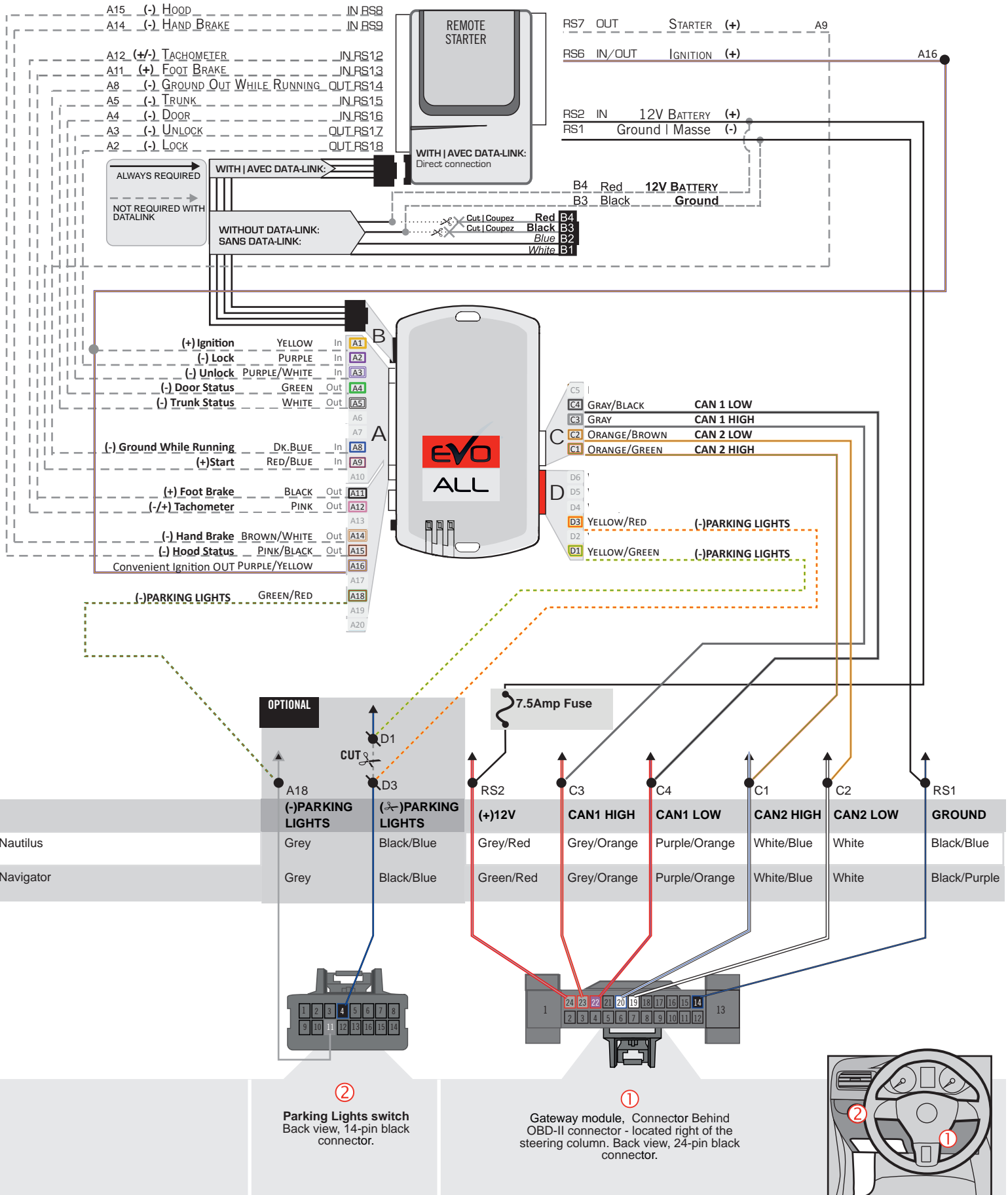

THAR-FOR3 | T-HARNESS - AUTOMATIC TRANSMISSION |

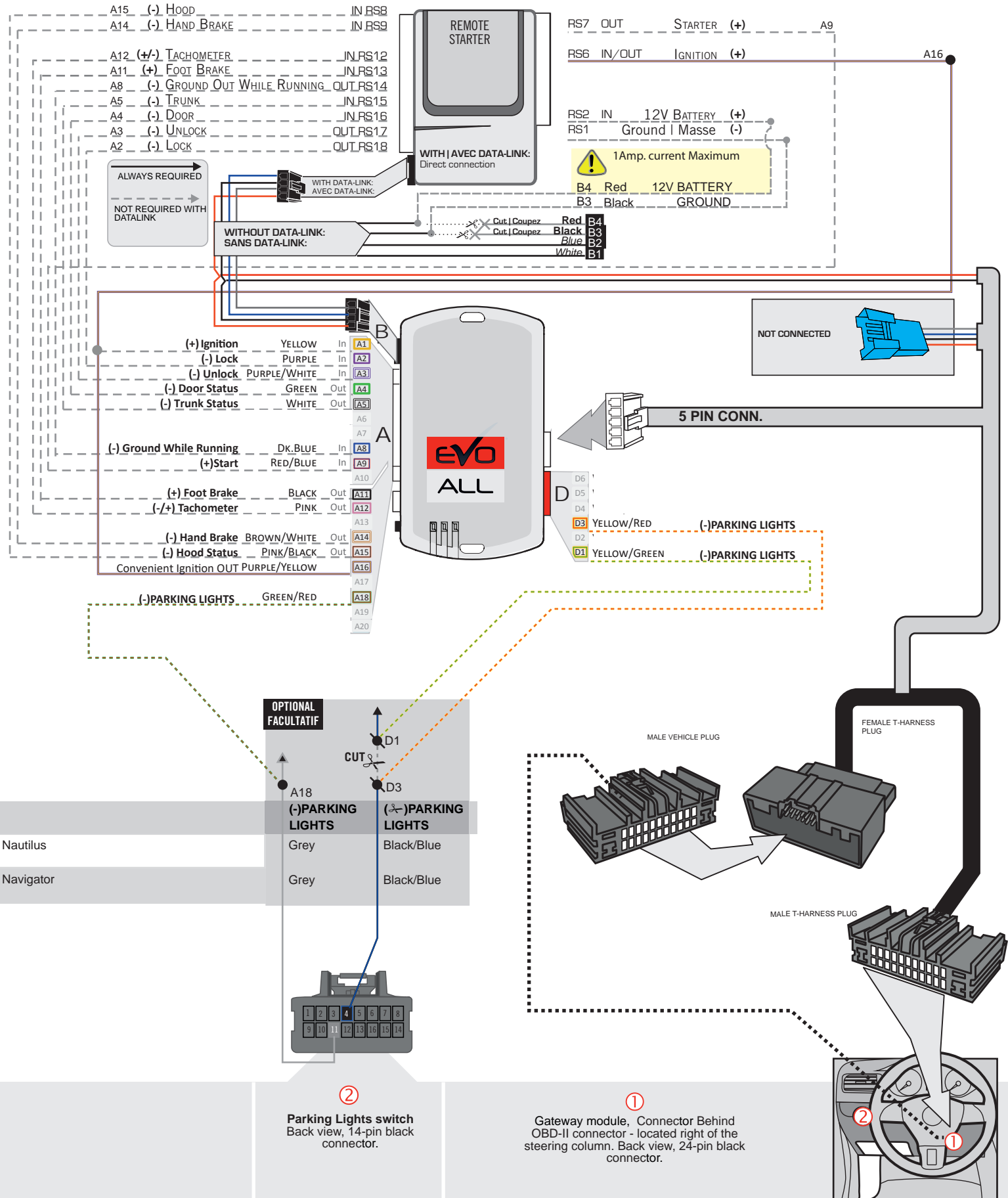



Parts required (not included)

- 1x FLASH LINK UPDATER, SOFTWARE | PROGRAMME
- 1x FLASH LINK MANAGER
- 1x Microsoft Windows Computer with Internet connection

OR

- 1x FLASH LINK MOBILE
- 1x FLASH LINK MOBILE APP
- x Smartphone Android or iOS with Internet connection (Internet provider charges may apply)

BEFORE PROGRAMMING SET THE UNIT OPTIONS AND SAVE.

1

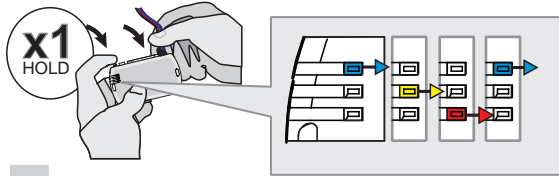

Press and hold the programming button:
Insert the 4-Pin (Data-Link) connector.

↳ The Blue, Red, Yellow and Blue & Red LEDs will alternatively illuminate.

2

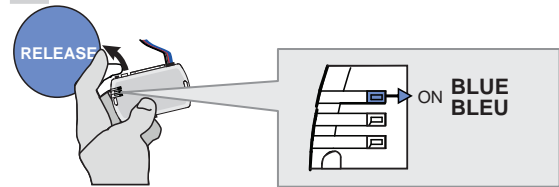

Release the programming button when the LED is BLUE.

If the LED is not solid BLUE disconnect the 4-Pin connector (Data-Link) and go back to step 1.

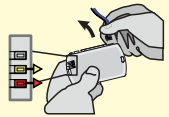

3

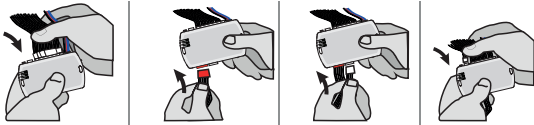

Insert the required remaining connectors.

4

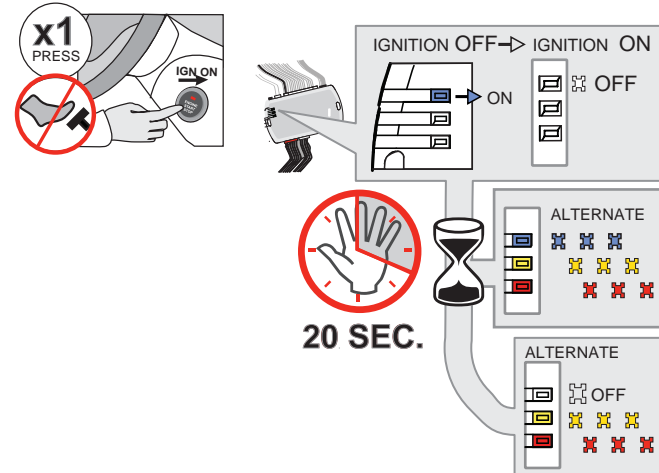

Do not press the brake pedal.
Press the Push-to-Start button once to turn on the ignition.

↳ The BLUE LED will turn OFF.

↳ The BLUE, YELLOW and RED LEDs will alternated.

Wait, at least 20 seconds, do not disconnect the modules or turn off the ignition.

↳ The RED and YELLOW LEDs will alternated.

Make sure that the DELs are flashing RED and YELLOW before continuing programming.

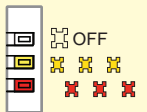

5

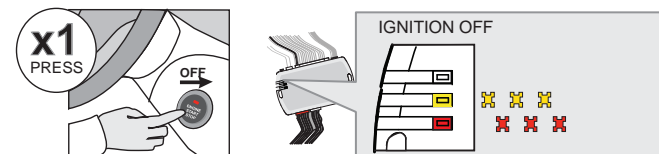

Press the Push-to-Start button once to turn off the ignition.

↳ The RED and YELLOW LEDs alternate.

KEY BYPASS PROGRAMMING PROCEDURE 2/2 |

6

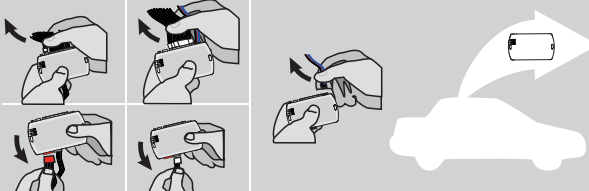

Disconnect all the connectors and after the Data-Link (4-pins) connector.

7



Microsoft Windows Computer with Internet connection*

FLASH LINK UPDATER* **FLASH LINK MANAGER***
SOFTWARE | PROGRAMME

OR

Smartphone* (Internet provider charges may apply)

VEHICLE'S OBDII CONNECTOR **FLASH LINK MOBILE***

Use the tool: FLASH LINK UPDATER or FLASH LINK MOBILE to visit the DCryptor menu.

*Parts required (not included)

8

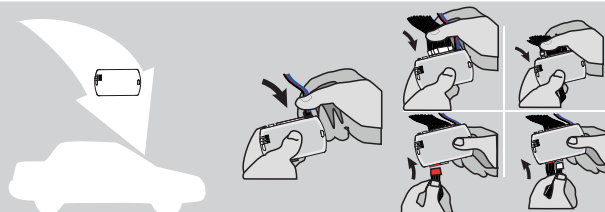

AFTER DCRYPTOR PROGRAMMING COMPLETED
Go back to the vehicle and reconnect the 4-Pin (Data-Link) connector and after, all the remaining connector.

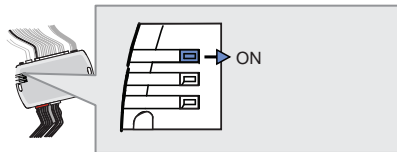

↳ The BLUE LED will turn ON.

9

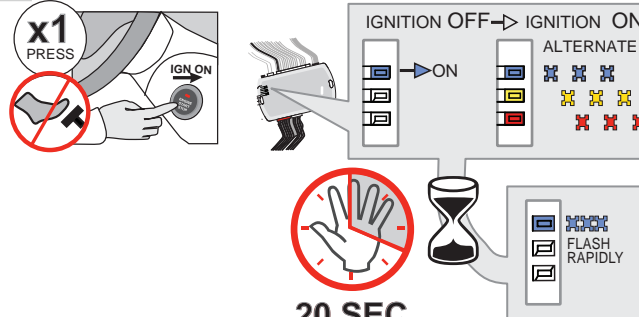

x1 PRESS (with a 'no brake pedal' symbol)

IGNITION OFF → IGNITION ON

ALTERNATE

The RED and YELLOW LEDs will turn ON.

20 SEC. (with a hand icon and an hourglass icon)

FLASH RAPIDLY

Do not press the brake pedal. Press the Push-to-Start button once to turn on the ignition.

↳ The BLUE LED will flash rapidly.

10

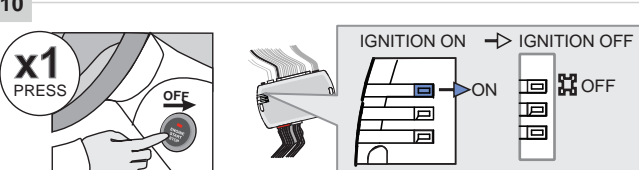

x1 PRESS (with a 'no brake pedal' symbol)

IGNITION ON → IGNITION OFF

OFF





Press the Push-to-Start button once to turn off the ignition.

↳ The BLUE will turn OFF.

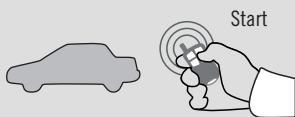

The module is now programmed.

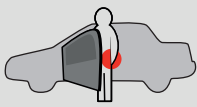
REMOTE STARTER FUNCTIONALITY |

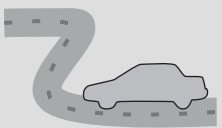
 <p>Start</p> <p>All doors must be closed.</p> <p>Remote start the vehicle.</p>	 <p>UNLOCK</p> <p>Unlock the doors with either:</p> <ul style="list-style-type: none"> • The OEM remote • The remote-starter remote • Or the proximity remote 	 <p>Enter the vehicle with the SMART-KEY.</p>	 <p>DO NOT PRESS THE BRAKE PEDAL.</p> <p>Press and release the Push-to-Start button once.</p>	 <p>Press the brake pedal. The vehicle can now be put in to gear and driven.</p> <p>If the Smart-Key is not detected the vehicle will shut down.</p>
--	---	--	---	---

REGULAR & THAR-FOR3 INSTALLATION

ADDENDUM - SUGGESTED WIRING CONFIGURATION



ONLY COMPATIBLE WITH AUTOMATIC TRANSMISSION VEHICLES.



Vehicle functions supported in this diagram (functional if equipped)

VEHICLE	YEARS	Immobilizer bypass	Lock	Unlock	Arm	Disarm	Heated Seats**	Rear Defrost**	RAP Disable	Parking Lights***	Tachometer	Door Status	Trunk Status	Hood Status*	Hand-Brake Status	Foot-Brake Status	Active OEM Remote Start
FORD																	
Ranger	key 2020	•	•	•	•	•	•	•	•	•	•	•	•	•	•	•	•

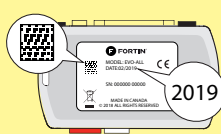

COMPATIBLE MODULE REQUIRED:

QR CODE ON THE LABEL
MANUFACTURED AFTER: 2019

FIRMWARE VERSION
58.[02]
MINIMUM

To add the firmware version and the options, use the FLASH LINK UPDATER or FLASH LINK MOBILE tool, sold separately.



Program bypass option:

UNIT OPTION

DESCRIPTION

C1

OEM Remote status (Lock/Unlock) monitoring

IF THE VEHICLE IS NOT EQUIPPED WITH FUNCTIONAL HOOD PIN:

A11

OFF

Hood trigger (Output Status).

NOTES

The vehicles OEM remote and SmartKey are still operable during remote start.

**Heated seats The heated seats and rear defrost activate automatically when it cold.

***Parking Lights The parking Lights at remote start only.



The vehicle must be equipped with the OEM remote with the door locks.

MANDATORY INSTALL

*HOOD PIN



HOOD STATUS: THE HOOD PIN SWITCH MUST BE INSTALLED IF THE VEHICLE CAN BE REMOTE STARTED WITH THE HOOD OPEN, SET FUNCTION A11 TO OFF.

A11

OFF

Notice: the installation of safety elements are mandatory. The hood pin is an essential security element and must be installed.

THIS MODULE MUST BE INSTALLED BY A QUALIFIED TECHNICIAN. A WRONG CONNECTION CAN CAUSE PERMANENT DAMAGE TO THE VEHICLE.

DESCRIPTION |

	Parts required (Not included)	PAGE
--	-------------------------------	------

WIRE TO WIRE DIAGRAM

AUTOMATIC TRANSMISSION	1x 7.5 Amp. fuse	Page 3
------------------------	------------------	--------

THARNES DIAGRAM

THARNES THAR-FOR3 AUTOMATIC TRANSMISSION	1x THAR-FOR3	Page 4
--	--------------	--------



① Gateway module, Behind OBD-II connector

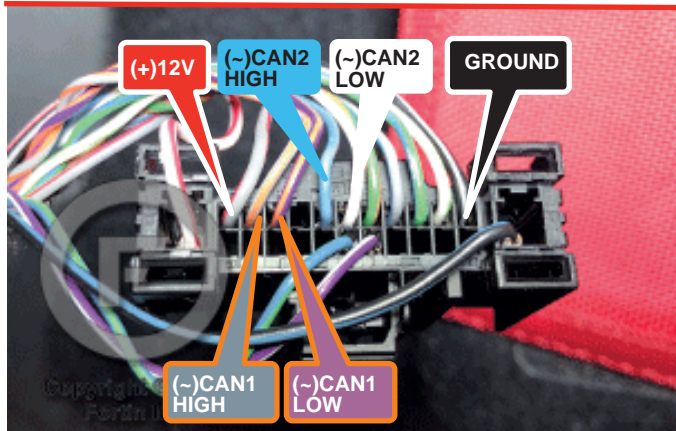

AUTOMATIC TRANSMISSION WIRING CONNECTION |

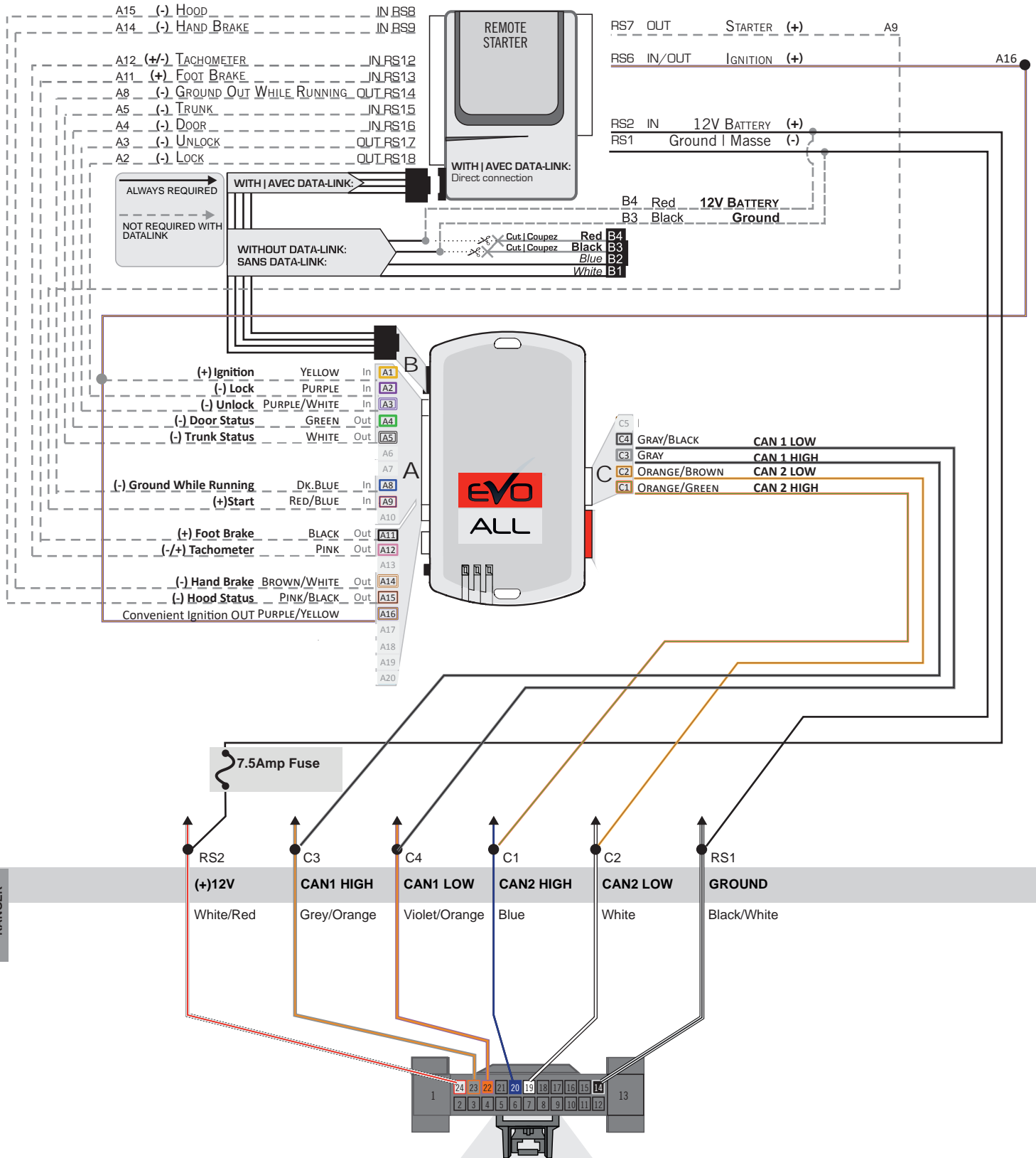

① Gateway module, Connector Behind OBD-II connector - located at dash board driver's side
Back view, 24-pin black connector.

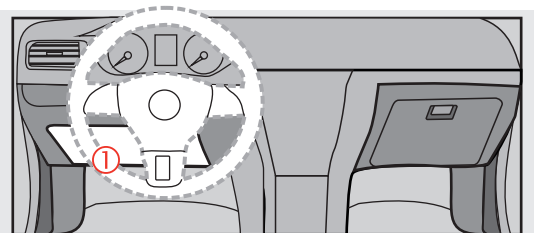

THAR-FOR3 | T-HARNESS - AUTOMATIC TRANSMISSION |

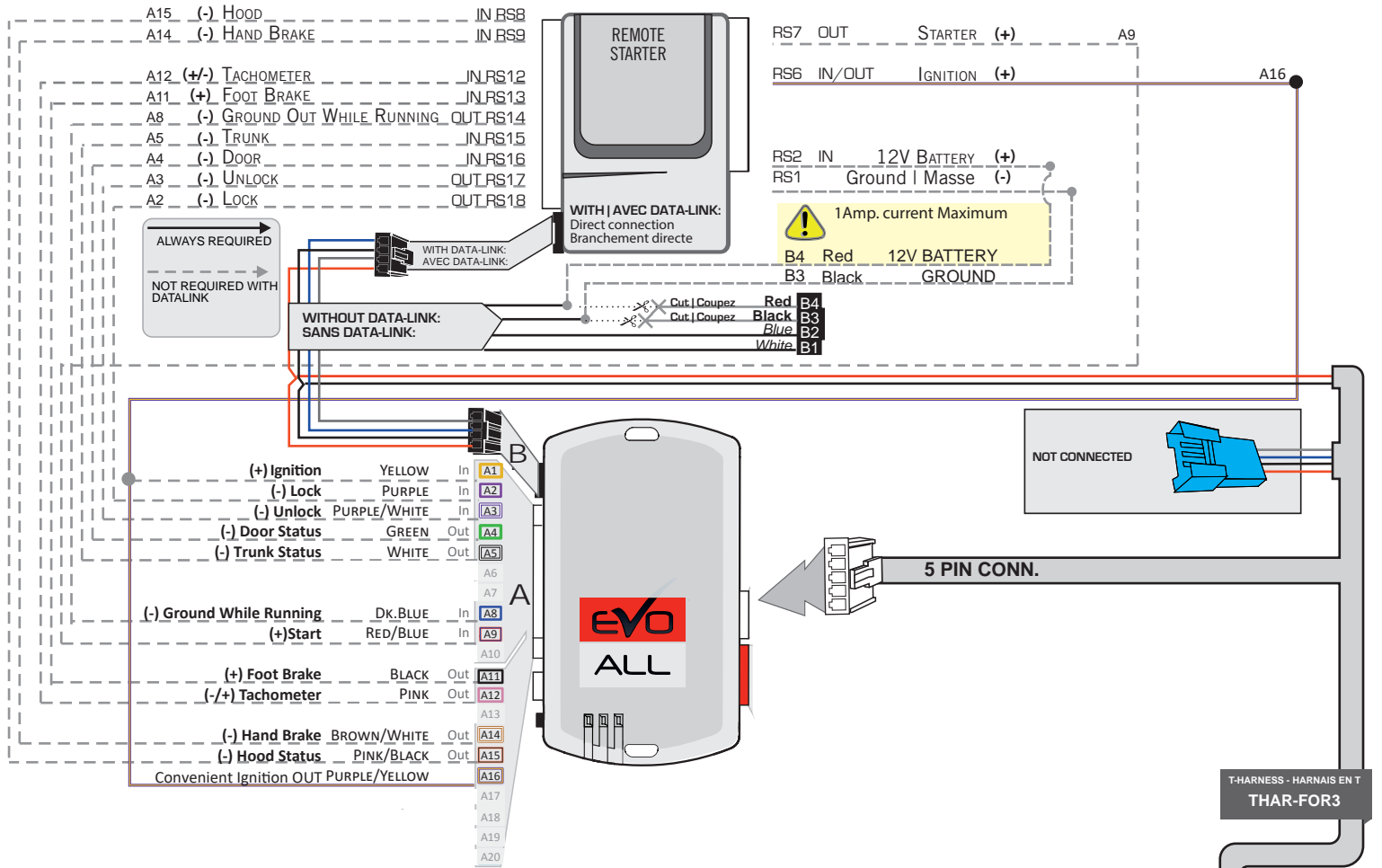

ESCAPE

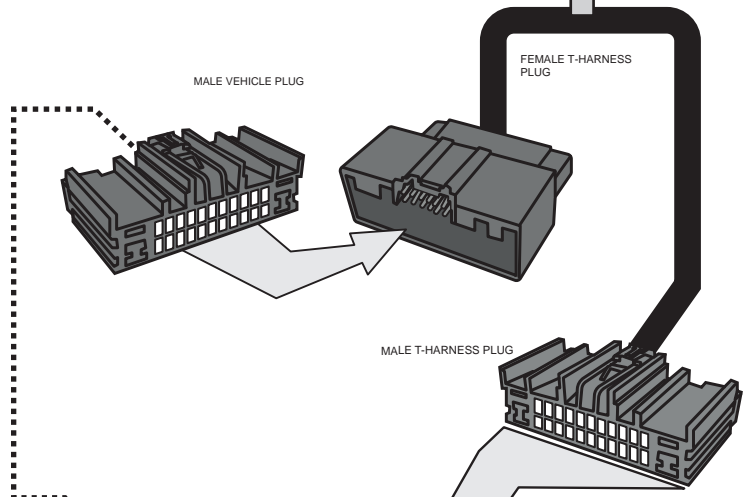

① Gateway module, Connector Behind OBD-II connector - located at dash board driver's side Back view, 24-pin black connector.

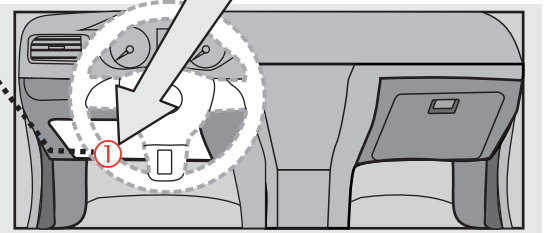



Parts required (not included)

- 1x FLASH LINK UPDATER, SOFTWARE | PROGRAMME
- 1x FLASH LINK MANAGER
- 1x Microsoft Windows Computer with Internet connection

OR

- 1x FLASH LINK MOBILE
- 1x FLASH LINK MOBILE APP
- Smartphone Android or iOS with Internet connection (Internet provider charges may apply)

BEFORE PROGRAMMING SET THE UNIT OPTIONS AND SAVE.

1

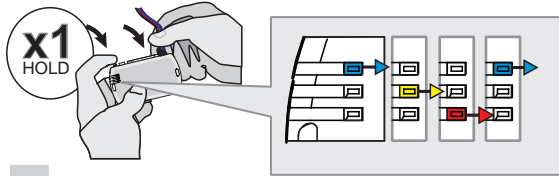

Press and hold the programming button:
Insert the 4-Pin (Data-Link) connector.

↳ The Blue, Red, Yellow and Blue & Red LEDs will alternatively illuminate.

2

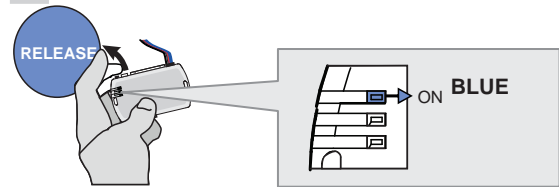

Release the programming button when the LED is BLUE.

If the LED is not solid BLUE disconnect the 4-Pin connector (Data-Link) and go back to step 1.

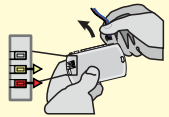

3

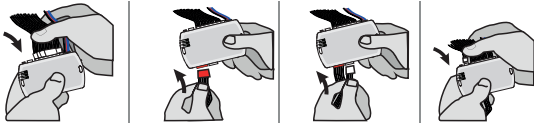

Insert the required remaining connectors.

4

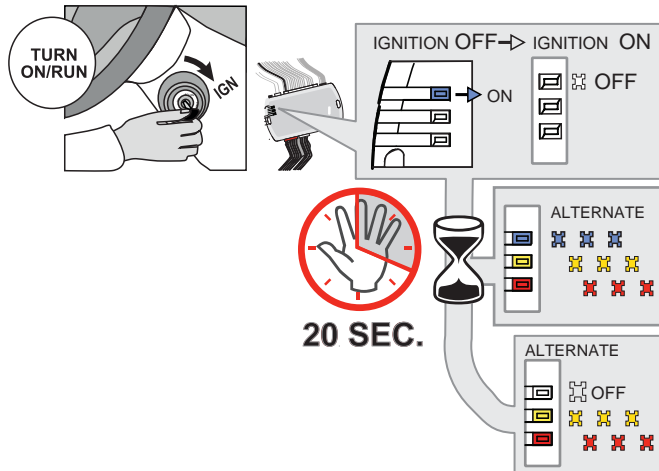

Turn the key to the Ignition ON/RUN position.

↳ The BLUE LED will turn OFF.

↳ The BLUE, YELLOW and RED LEDs will alternate.

Wait, at least 20 seconds, do not disconnect the modules or turn off the ignition.

↳ The RED and YELLOW LEDs will alternate.

Make sure that the DELs are flashing RED and YELLOW before continuing programming.

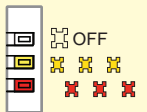

5

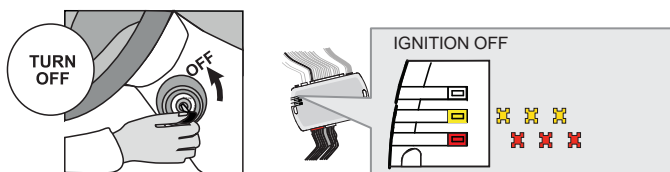

Turn the key to the OFF position.

↳ The RED and YELLOW LEDs alternate.

KEY BYPASS PROGRAMMING PROCEDURE 2/2 |

6

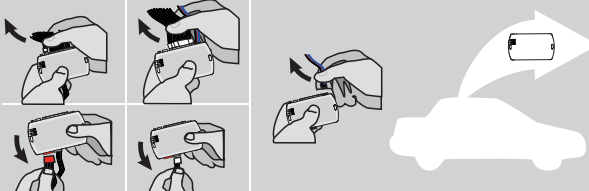

Disconnect all the connectors and after the Data-Link (4-pins) connector.

7



Microsoft Windows Computer with Internet connection*

FLASH LINK UPDATER* **FLASH LINK MANAGER***
SOFTWARE | PROGRAMME

OR

Smartphone* (Internet provider charges may apply)

VEHICLE'S OBDII CONNECTOR **FLASH LINK MOBILE***

Use the tool: FLASH LINK UPDATER or FLASH LINK MOBILE to visit the DCRYPTOR menu.

*Parts required (not included)

8

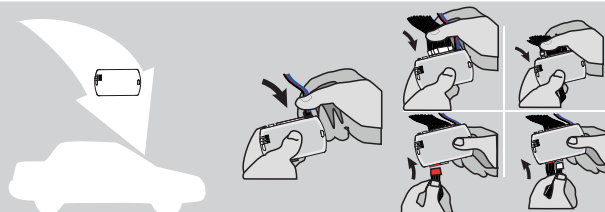

AFTER DCRYPTOR PROGRAMMING COMPLETED
Go back to the vehicle and reconnect the 4-Pin (Data-Link) connector and after, all the remaining connector.



↳ The BLUE LED will turn ON.

9

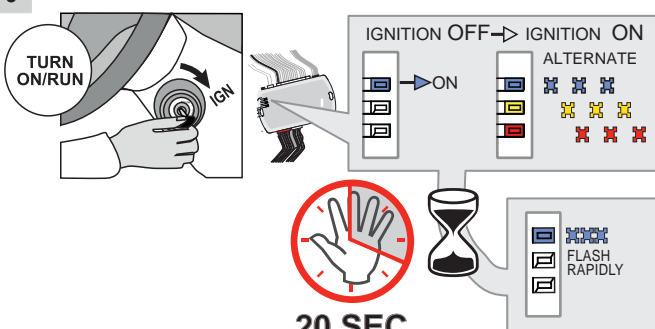

TURN ON/RUN

IGNITION OFF → IGNITION ON

ALTERNATE

↳ The RED and YELLOW LEDs will turn ON.

Wait, at least 20 seconds, do not disconnect the modules or turn off the ignition.

↳ The BLUE LED will flash rapidly.

20 SEC.

FLASH RAPIDLY

10

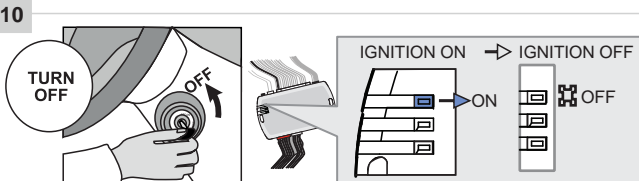

TURN OFF

IGNITION ON → IGNITION OFF

↳ The BLUE will turn OFF.



The module is now programmed.

REMOTE STARTER FUNCTIONALITY |



All doors must be closed.



Remote start the vehicle.



Unlock the doors with the remote-starter remote or the OEM remote.



Insert and Turn the key to the Ignition ON/RUN position.



Press the brake pedal.



The vehicle can now be put in to gear and driven.

REGULAR & THAR-FOR3 INSTALLATION

ADDENDUM - SUGGESTED WIRING CONFIGURATION



ONLY COMPATIBLE WITH AUTOMATIC TRANSMISSION VEHICLES.



Vehicle functions supported in this diagram (functional if equipped)

VEHICLE	YEARS	Immobilizer bypass	Lock	Unlock	Arm	Disarm	Heated Seats**	Rear Defrost**	RAP Disable	Parking Lights***	Tachometer	Door Status	Trunk Status	Hood Status*	Hand-Brake Status	Foot-Brake Status	Active OEM Remote Start
FORD Ranger	Push-to-Start 2020	•	•	•	•	•	•	•	•	•	•	•	•	•	•	•	•

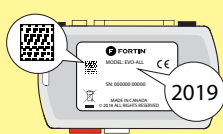

COMPATIBLE MODULE REQUIRED:

QR CODE ON THE LABEL
MANUFACTURED AFTER: 2019

FIRMWARE VERSION

58.[02]
MINIMUM

To add the firmware version and the options, use the **FLASH LINK UPDATER** or **FLASH LINK MOBILE** tool, sold separately.



Program bypass option:

UNIT OPTION

DESCRIPTION

C1

OEM Remote status (Lock/Unlock) monitoring

D6

Push-to-Start

IF THE VEHICLE IS NOT EQUIPPED WITH FUNCTIONAL HOOD PIN:

A11

OFF

Hood trigger (Output Status).

NOTES

The vehicles OEM remote and SmartKey are still operable during remote start.

**Heated seats The heated seats and rear defrost activate automatically when it cold.
**Rear Defrost

***Parking Lights The parking Lights at remote start only.

MANDATORY INSTALL

*HOOD PIN



HOOD STATUS: THE HOOD PIN SWITCH MUST BE INSTALLED IF THE VEHICLE CAN BE REMOTE STARTED WITH THE HOOD OPEN, SET FUNCTION A11 TO OFF.

A11

OFF

Notice: the installation of safety elements are mandatory. The hood pin is an essential security element and must be installed.

THIS MODULE MUST BE INSTALLED BY A QUALIFIED TECHNICIAN. A WRONG CONNECTION CAN CAUSE PERMANENT DAMAGE TO THE VEHICLE.

DESCRIPTION | DESCRIPTION

	Parts required (Not included)	PAGE
--	-------------------------------	------

WIRE TO WIRE DIAGRAM

AUTOMATIC TRANSMISSION	1x 7.5 Amp. fuse	Page 3
------------------------	------------------	--------

THARNES DIAGRAM

THARNES THAR-FOR3 AUTOMATIC TRANSMISSION	1x THAR-FOR3	Page 4
--	--------------	--------



RANGER

① Gateway module, Behind OBD-II connector

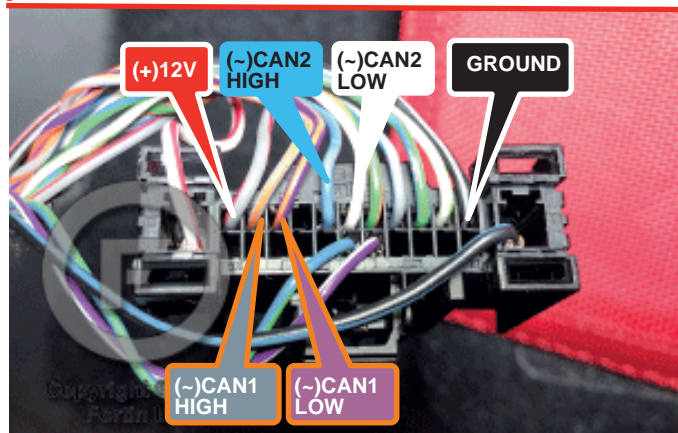

AUTOMATIC TRANSMISSION WIRING CONNECTION |

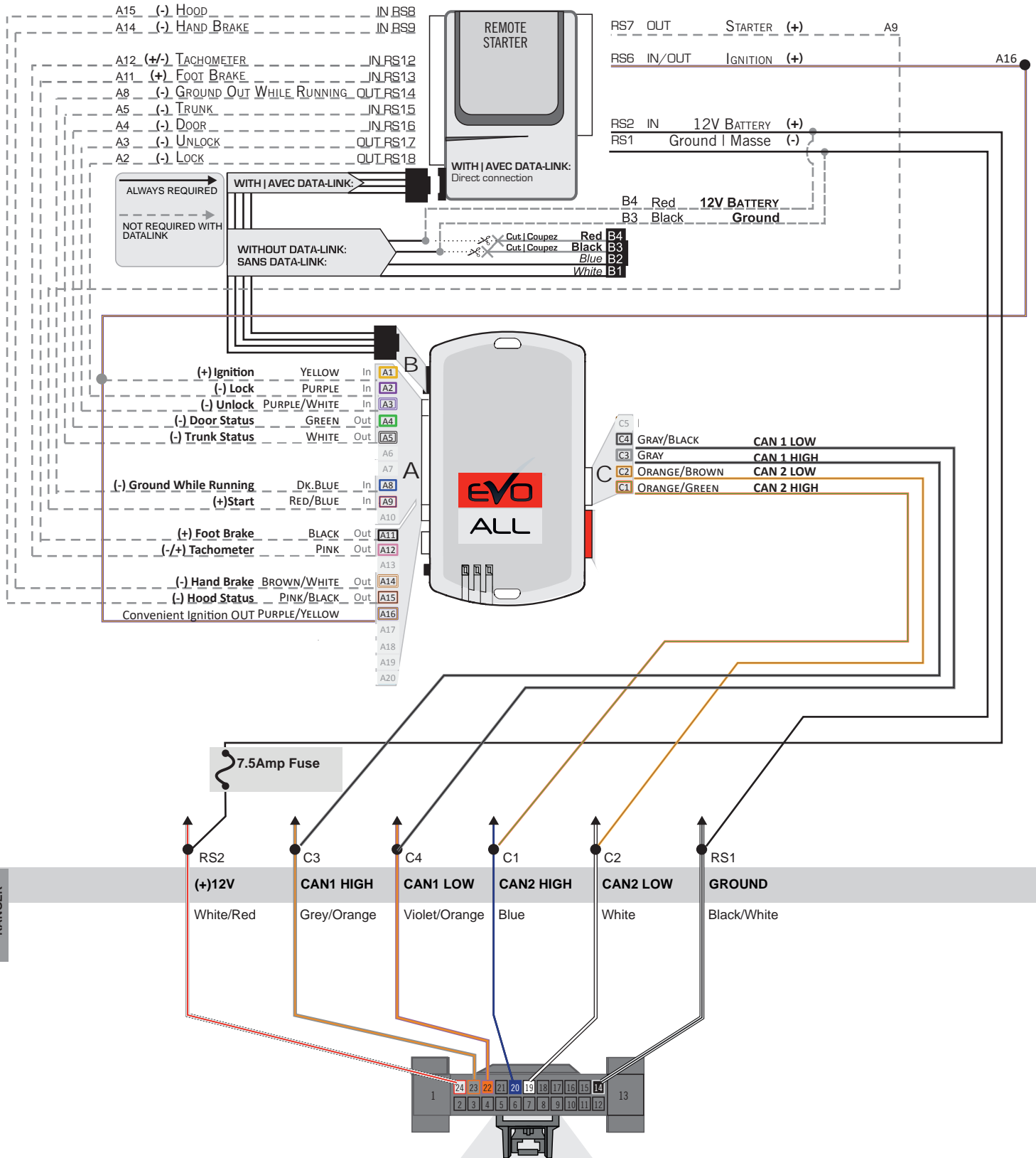

① Gateway module, Connector Behind OBD-II connector - located at dash board driver's side
 Back view, 24-pin black connector.

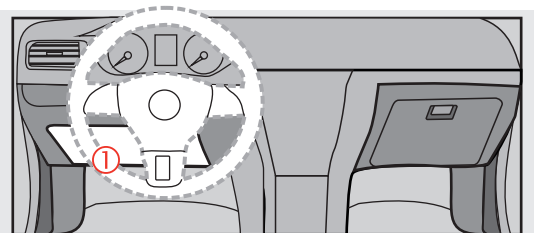

THAR-FOR3 | T-HARNESS - AUTOMATIC TRANSMISSION |

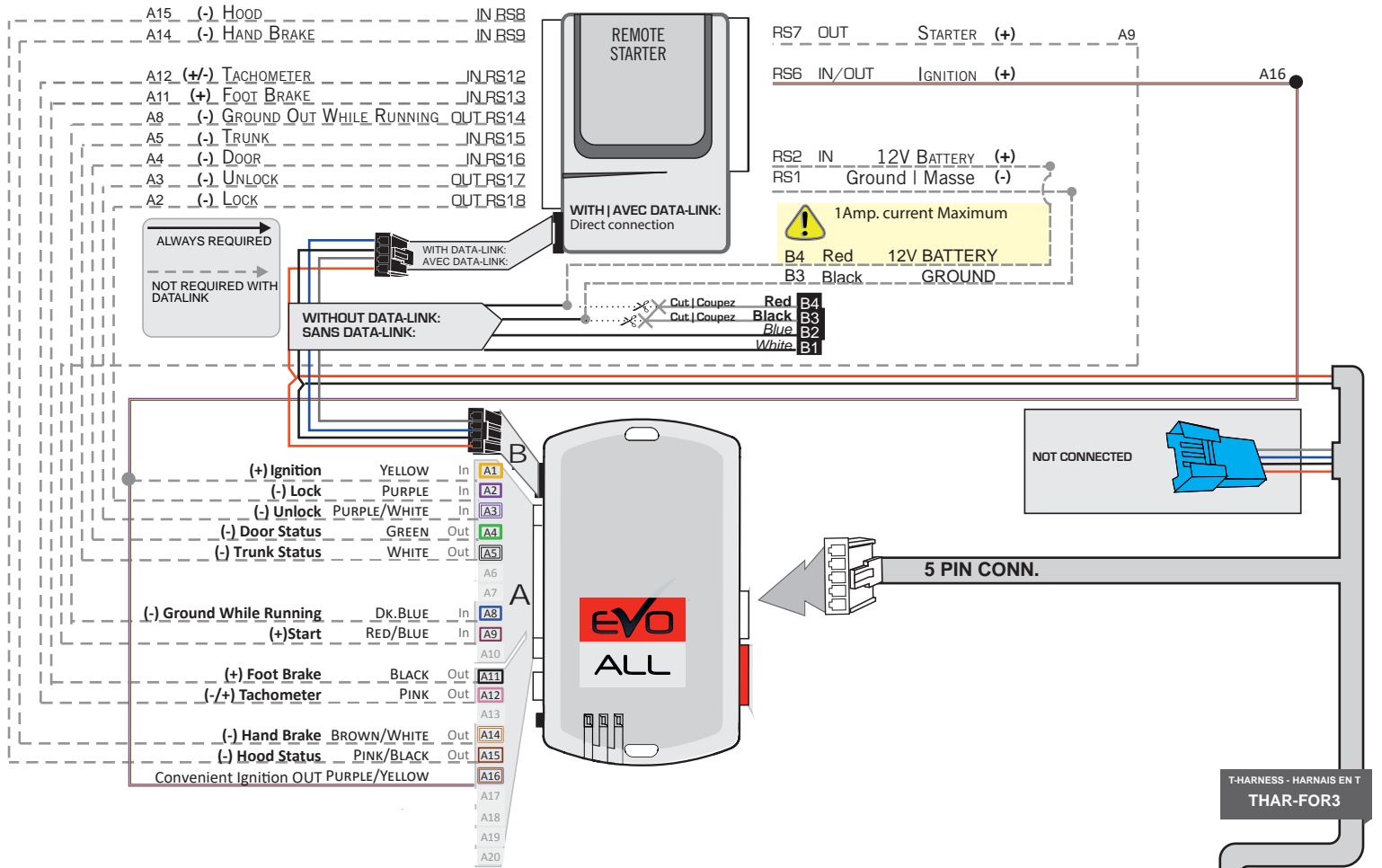

RANGER

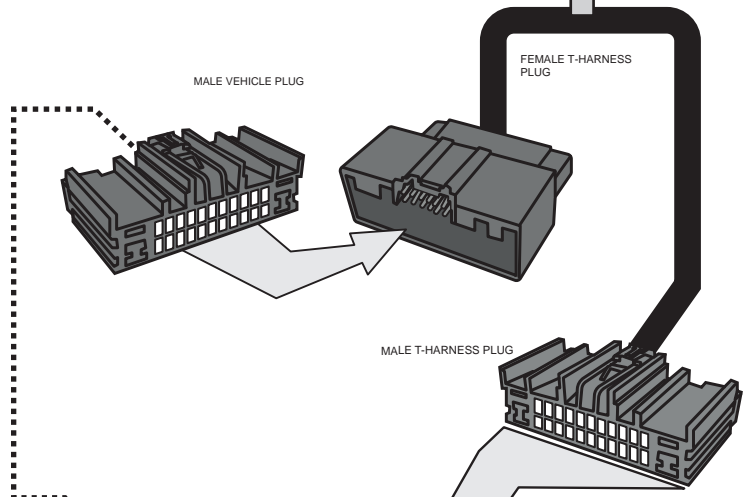

① Gateway module, Connector Behind OBD-II connector - located at dash board driver's side Back view, 24-pin black connector.

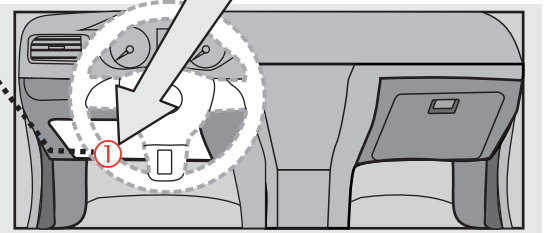



Parts required (not included)

- 1x FLASH LINK UPDATER, SOFTWARE | PROGRAMME
- 1x FLASH LINK MANAGER
- 1x Microsoft Windows Computer with Internet connection

OR

- 1x FLASH LINK MOBILE
- 1x FLASH LINK MOBILE APP
- Smartphone Android or iOS with Internet connection (Internet provider charges may apply)

BEFORE PROGRAMMING SET THE UNIT OPTIONS AND SAVE.

1

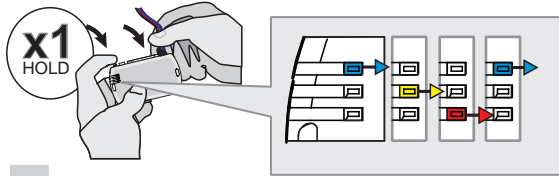

Press and hold the programming button:
Insert the 4-Pin (Data-Link) connector.

↳ The Blue, Red, Yellow and Blue & Red LEDs will alternatively illuminate.

2

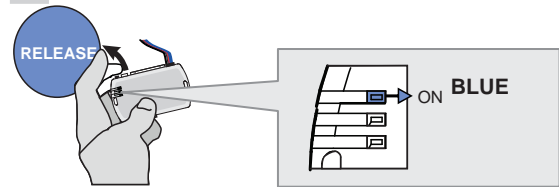

Release the programming button when the LED is BLUE.

If the LED is not solid BLUE disconnect the 4-Pin connector (Data-Link) and go back to step 1.

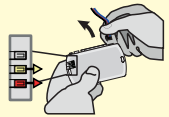

3

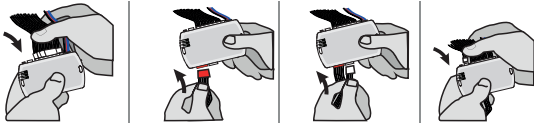

Insert the required remaining connectors.

4

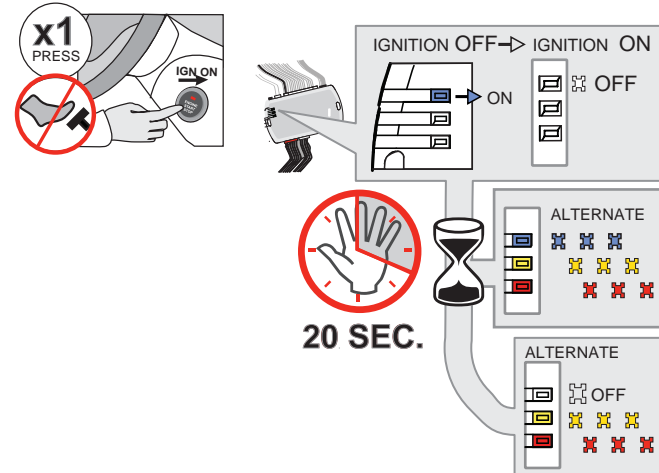

Do not press the brake pedal.
Press the Push-to-Start button once to turn on the ignition.

↳ The BLUE LED will turn OFF.

↳ The BLUE, YELLOW and RED LEDs will alternate.

Wait, at least 20 seconds, do not disconnect the modules or turn off the ignition.

↳ The RED and YELLOW LEDs will alternate.

Make sure that the DELs are flashing RED and YELLOW before continuing programming.

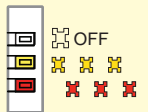

5

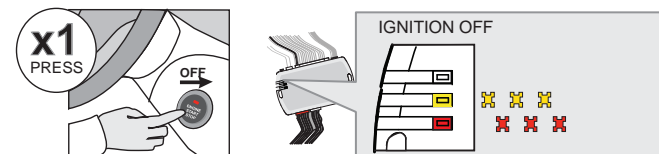

Press the Push-to-Start button once to turn off the ignition.

↳ The RED and YELLOW LEDs alternate.

KEY BYPASS PROGRAMMING PROCEDURE 2/2 |

6

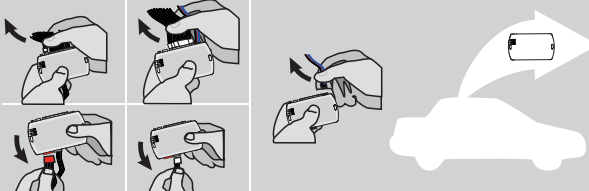

Disconnect all the connectors and after the Data-Link (4-pins) connector.

7

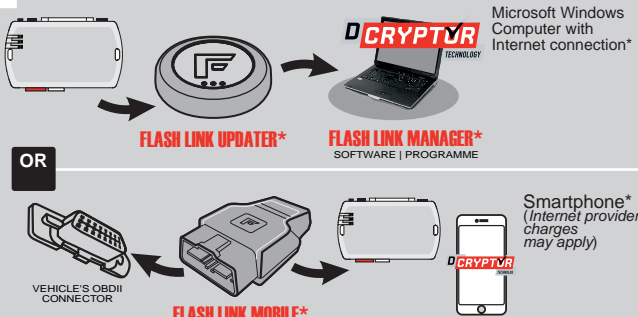

Microsoft Windows Computer with Internet connection*

the tool:
FLASH LINK UPDATER or **FLASH LINK MOBILE** to visit the DCryptor menu.

OR

Smartphone* (Internet provider charges may apply)

*Parts required (not included)

8

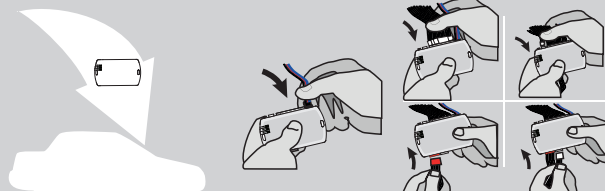

AFTER DCRYPTOR PROGRAMMING COMPLETED
Go back to the vehicle and **reconnect** the 4-Pin (Data-Link) connector and after, all the remaining connector.

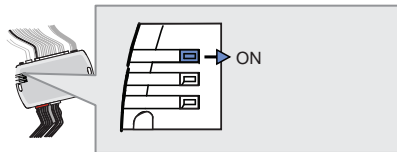

↳ The BLUE LED will turn ON.

9

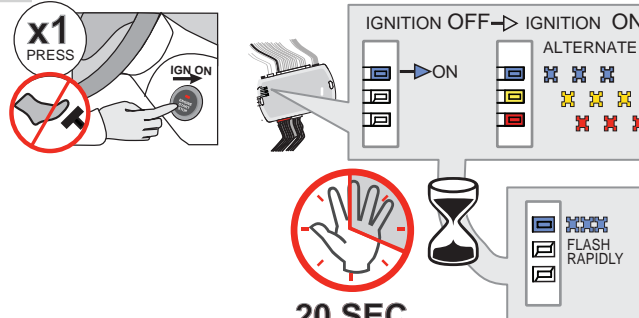

x1 PRESS

IGNITION OFF → IGNITION ON

Do not press the brake pedal. **Press** the Push-to-Start button once to turn on the ignition.

↳ The RED and YELLOW LEDs will turn ON.

Wait, at least 20 seconds, do not disconnect the modules or turn off the ignition.

↳ The BLUE LED will flash rapidly.

20 SEC.

FLASH RAPIDLY

10

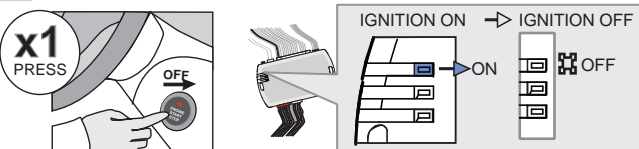

x1 PRESS

IGNITION ON → IGNITION OFF





Press the Push-to-Start button once to turn off the ignition.

↳ The BLUE will turn OFF.

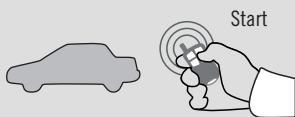

The module is now programmed.

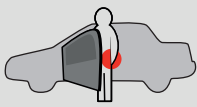
REMOTE STARTER FUNCTIONALITY |

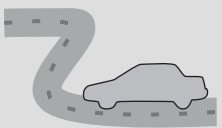
 <p>Start</p> <p>All doors must be closed.</p> <p>Remote start the vehicle.</p>	 <p>UNLOCK</p> <p>Unlock the doors with either:</p> <ul style="list-style-type: none"> • The OEM remote • The remote-starter remote • Or the proximity remote 	 <p>Enter the vehicle with the SMART-KEY.</p>	 <p>DO NOT PRESS THE BRAKE PEDAL.</p> <p>Press and release the Push-to-Start button once.</p>	 <p>Press the brake pedal. The vehicle can now be put in to gear and driven.</p> <p>If the Smart-Key is not detected the vehicle will shut down.</p>
--	---	--	---	---

REGULAR & THAR-FOR3 INSTALLATION

ADDENDUM - SUGGESTED WIRING CONFIGURATION



ONLY COMPATIBLE WITH AUTOMATIC TRANSMISSION VEHICLES.



Vehicle functions supported in this diagram (functional if equipped)

VEHICLE	YEARS	Immobilizer bypass	Lock	Unlock	Arrn	Disarm	RAP Disable	Parking Lights***	Tachometer	Heated seats**	Heated Mirrors**	Rear defrost	Door Status	Trunk Status	Hood Status*	Hand-Brake Status	Foot-Brake Status	Active OEM Remote Start	
FORD																			
Transit	Key 2020	•	•	•	•	•	•	•	•	•	•	•	•	•	•	•	•	•	•
	Diesel Key 2020	•	•	•	•	•	•	•	•	•	•	•	•	•	•	•	•	•	•

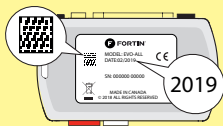

COMPATIBLE MODULE REQUIRED:

QR CODE ON THE LABEL
MANUFACTURED AFTER: 2019

FIRMWARE VERSION

58.[02]
MINIMUM

To add the firmware version and the options, use the **FLASH LINK UPDATER** or **FLASH LINK MOBILE** tool, sold separately.



Program bypass option:

UNIT OPTION

C1

DESCRIPTION

OEM Remote status (Lock/Unlock) monitoring

IF THE VEHICLE IS NOT EQUIPPED WITH FUNCTIONAL HOOD PIN:

A11

OFF

Hood trigger (Output Status).

NOTES

The vehicles OEM remote and SmartKey are still operable during remote start.

**Heated seats The heated seats and rear defrost activate automatically when it cold.

***Parking Lights The parking Lights at remote start only.



The vehicle must be equipped with the OEM remote with the door locks.

MANDATORY INSTALL

*HOOD PIN



HOOD STATUS: THE HOOD PIN SWITCH MUST BE INSTALLED IF THE VEHICLE CAN BE REMOTE STARTED WITH THE HOOD OPEN, SET FUNCTION A11 TO OFF.

A11

OFF

Notice: the installation of safety elements are mandatory. The hood pin is an essential security element and must be installed.

THIS MODULE MUST BE INSTALLED BY A QUALIFIED TECHNICIAN. A WRONG CONNECTION CAN CAUSE PERMANENT DAMAGE TO THE VEHICLE.

DESCRIPTION |

	Parts required (Not included)	PAGE
--	-------------------------------	------

WIRE TO WIRE DIAGRAM

AUTOMATIC TRANSMISSION	1x 7.5 Amp. fuse	Page 3
------------------------	------------------	--------

THARNES DIAGRAM

THARNES THAR-FOR3 AUTOMATIC TRANSMISSION	1x THAR-FOR3	Page 4
--	--------------	--------

① Gateway module, located at dash board driver's side,

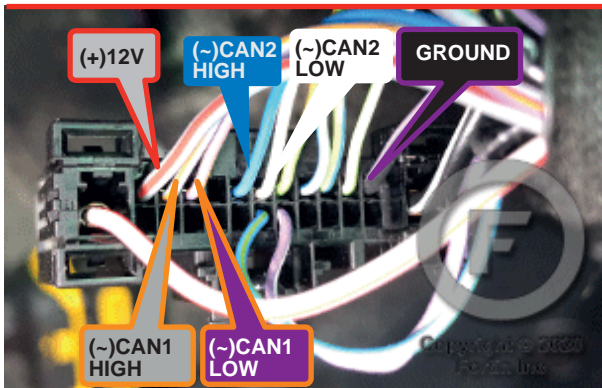

AUTOMATIC TRANSMISSION WIRING CONNECTION |

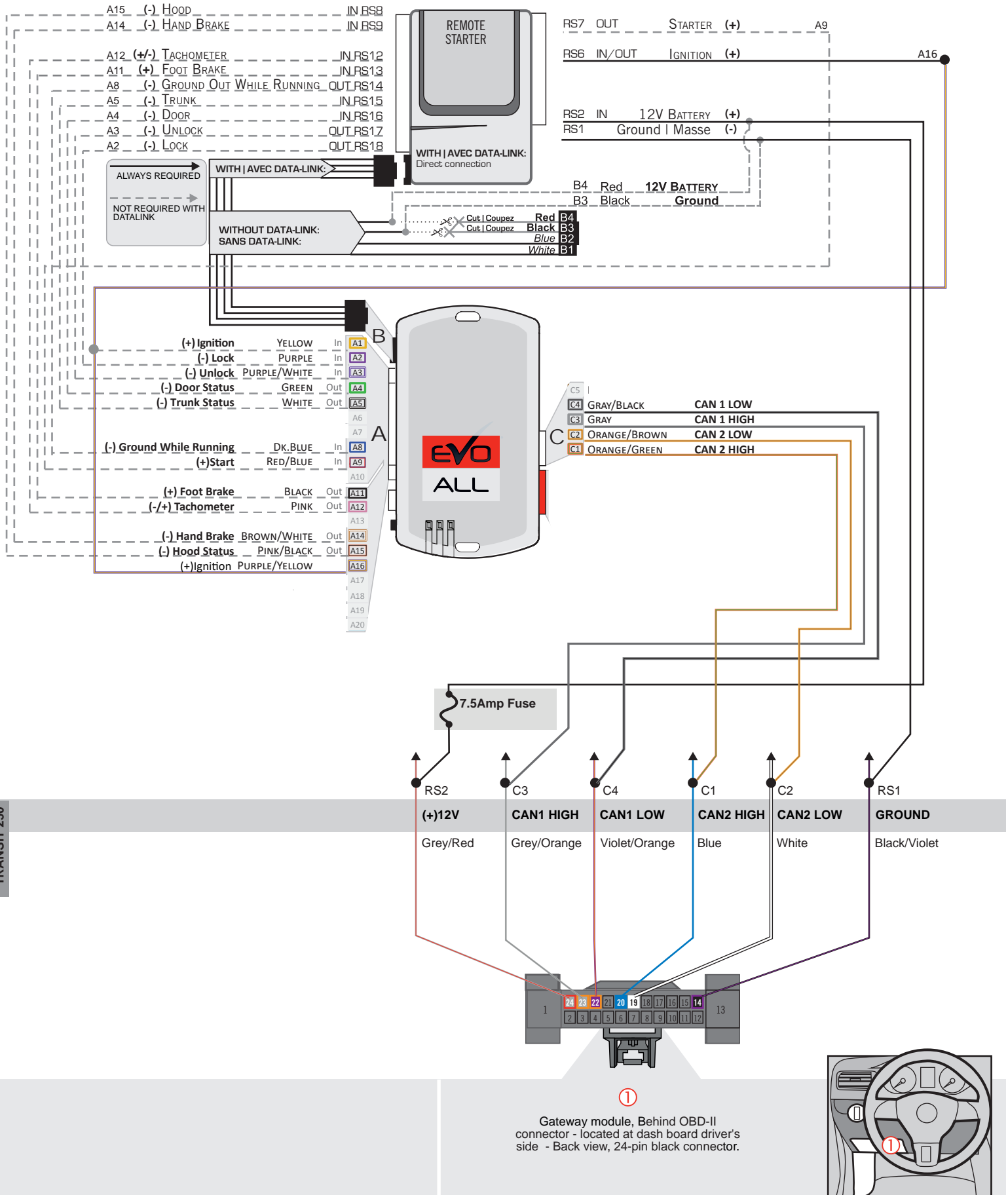

THAR-FOR3 | T-HARNESS - AUTOMATIC TRANSMISSION |

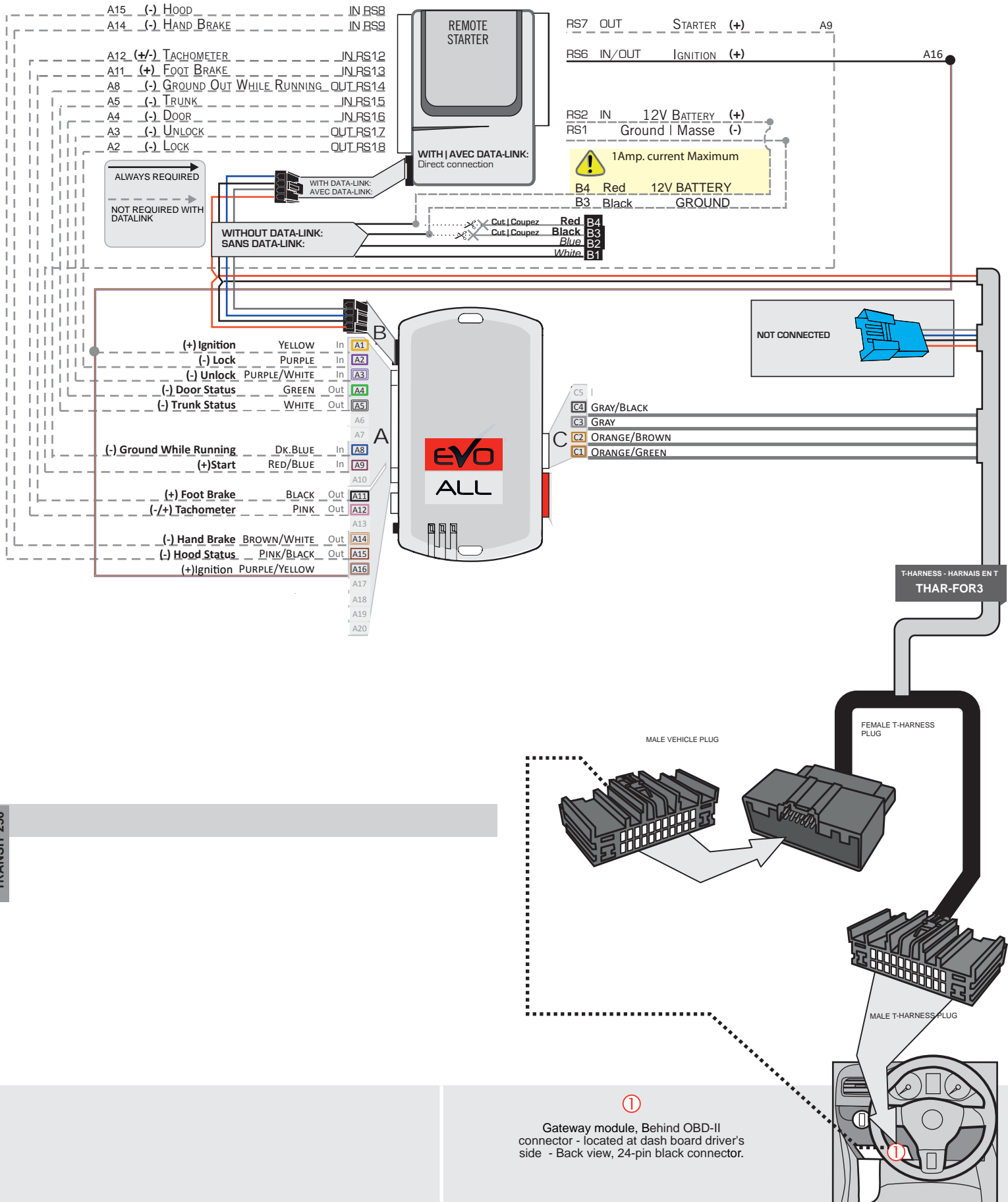

TRANSIT 250



Parts required (not included)

- 1x **FLASH LINK UPDATER,**
- 1x **FLASH LINK MANAGER**
SOFTWARE | PROGRAMME
- 1x Microsoft Windows Computer with Internet connection

OR

- 1x **FLASH LINK MOBILE**
- 1x **FLASH LINK MOBILE APP**
- Smartphone *Android* or *iOS* with Internet connection
(Internet provider charges may apply)

BEFORE PROGRAMMING SET THE UNIT OPTIONS AND SAVE.

1

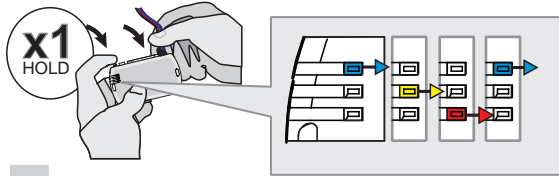

Press and hold the programming button:
Insert the 4-Pin (Data-Link) connector.

↳ The Blue, Red, Yellow and Blue & Red LEDs will alternatively illuminate.

2

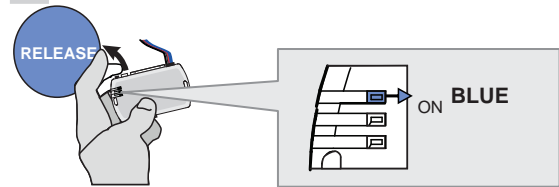

Release the programming button when the LED is BLUE.

If the LED is not solid BLUE disconnect the 4-Pin connector (Data-Link) and go back to step 1.

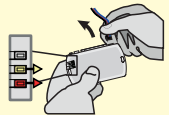

3

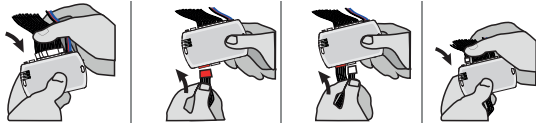

Insert the required remaining connectors.

4

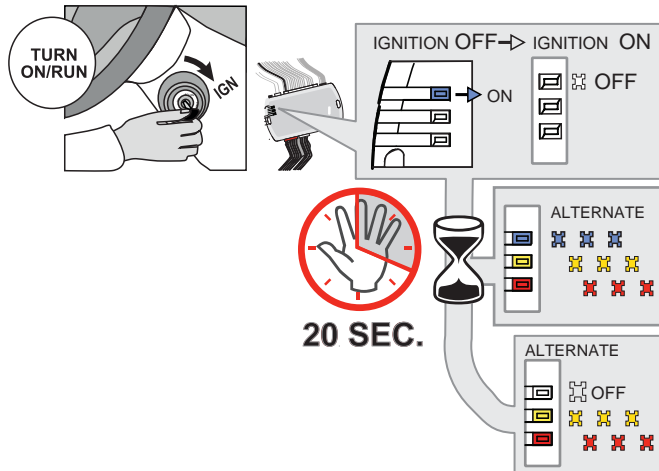

Turn the key to the Ignition ON/RUN position.

↳ The BLUE LED will turn OFF.

↳ The BLUE, YELLOW and RED LEDs will alternate.

Wait, at least 20 seconds, do not disconnect the modules or turn off the ignition.

↳ The RED and YELLOW LEDs will alternate.

Make sure that the DELs are flashing RED and YELLOW before continuing programming.

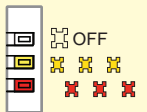

5

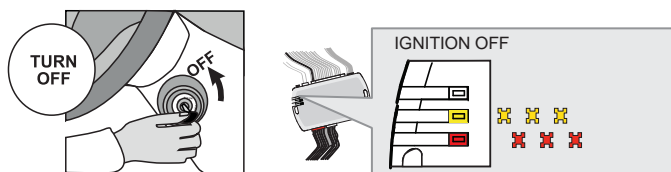

Turn the key to the OFF position.

↳ The RED and YELLOW LEDs alternate.

KEY BYPASS PROGRAMMING PROCEDURE 2/2 |

6



Disconnect all the connectors and after the Data-Link (4-pins) connector.

7



Microsoft Windows Computer with Internet connection*

FLASH LINK UPDATER* **FLASH LINK MANAGER***
SOFTWARE | PROGRAMME

OR

Smartphone* (Internet provider charges may apply)

VEHICLE'S OBDII CONNECTOR **FLASH LINK MOBILE***

Use the tool: FLASH LINK UPDATER or FLASH LINK MOBILE to visit the DCryptor menu.

*Parts required (not included)

8

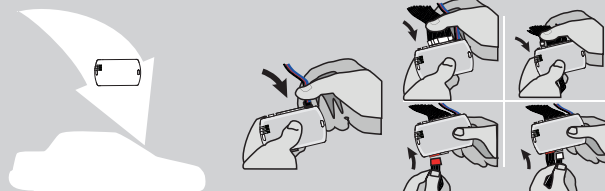

AFTER DCRYPTOR PROGRAMMING COMPLETED
Go back to the vehicle and reconnect the 4-Pin (Data-Link) connector and after, all the remaining connector.



↳ The BLUE LED will turn ON.

9

TURN ON/RUN

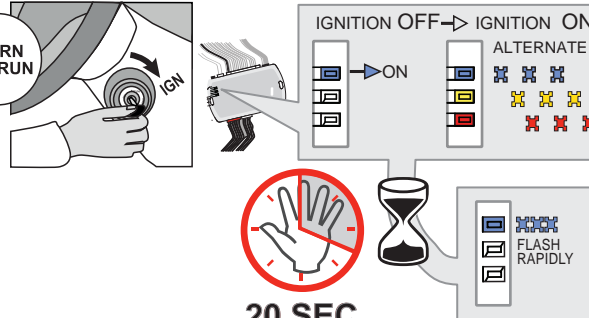

IGNITION OFF → IGNITION ON

ALTERNATE

↳ The RED and YELLOW LEDs will turn ON.

Wait, at least 20 seconds, do not disconnect the modules or turn off the ignition.

↳ The BLUE LED will flash rapidly.

20 SEC.

FLASH RAPIDLY

10

TURN OFF

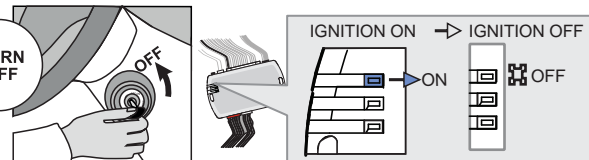

IGNITION ON → IGNITION OFF

↳ The BLUE will turn OFF.



The module is now programmed.

REMOTE STARTER FUNCTIONALITY |



All doors must be closed.



Remote start the vehicle.



Unlock the doors with the remote-starter remote or the OEM remote.



Insert and Turn the key to the Ignition ON/RUN position.



Press the brake pedal.



The vehicle can now be put in to gear and driven.

REGULAR & THAR-FOR3 INSTALLATION

ADDENDUM - SUGGESTED WIRING CONFIGURATION



ONLY COMPATIBLE WITH AUTOMATIC TRANSMISSION VEHICLES.



Vehicle functions supported in this diagram (functional if equipped)

VEHICLE	YEARS	Immobilizer bypass	T-Harness available (sold separately)	Lock	Unlock	Arm	Disarm	Heated Seats**	Rear Defrost**	RAP Disable	Parking Lights***	Tachometer	Door Status	Trunk Status	Hood Status*	Hand-Brake Status	Foot-Brake Status	Active OEM Remote Start
FORD																		
Transit Connect	2020-2022	•	•	•	•	•	•	•	•	•	•	•	•	•	•	•	•	•

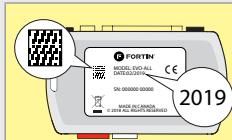

COMPATIBLE MODULE REQUIRED:

QR CODE ON THE LABEL
MANUFACTURED AFTER: 2019

FIRMWARE VERSION

58.[02]
MINIMUM

To add the firmware version and the options, use the **FLASH LINK UPDATER** or **FLASH LINK MOBILE** tool, sold separately.



Program bypass option:

UNIT OPTION

C1

DESCRIPTION

OEM Remote status (Lock/Unlock) monitoring

IF THE VEHICLE IS NOT EQUIPPED WITH FUNCTIONAL HOOD PIN:

A11

OFF

Hood trigger (Output Status).

NOTES

The vehicles OEM remote and SmartKey are still operable during remote start.

**Heated seats The heated seats and rear defrost activate automatically when it cold.

***Parking Lights The parking Lights at remote start only.



The vehicle must be equipped with the OEM remote with the door locks.

MANDATORY INSTALL

*HOOD PIN



HOOD STATUS: THE HOOD PIN SWITCH MUST BE INSTALLED IF THE VEHICLE CAN BE REMOTE STARTED WITH THE HOOD OPEN, SET FUNCTION A11 TO OFF.

A11

OFF

Notice: the installation of safety elements are mandatory. The hood pin is an essential security element and must be installed.

THIS MODULE MUST BE INSTALLED BY A QUALIFIED TECHNICIAN. A WRONG CONNECTION CAN CAUSE PERMANENT DAMAGE TO THE VEHICLE.

DESCRIPTION | DESCRIPTION

		Parts required (Not included)	PAGE
--	--	-------------------------------	------

WIRE TO WIRE DIAGRAM

AUTOMATIC TRANSMISSION	1x 7.5 Amp. fuse	Page 3
------------------------	------------------	--------

THARNESS DIAGRAM

THARNESS THAR-FOR3 AUTOMATIC TRANSMISSION	1x THAR-FOR3	Page 4
---	--------------	--------



② Parking Lights switch

① Gateway module, located at dash board driver's side,

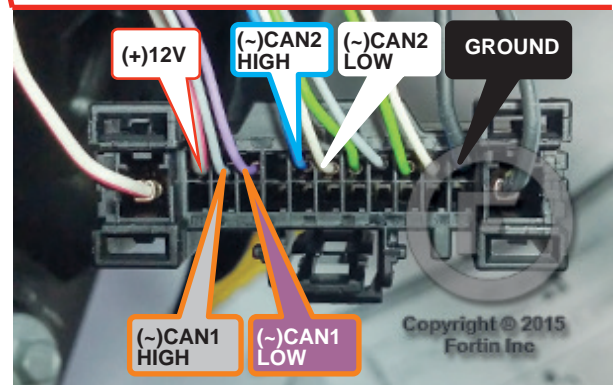
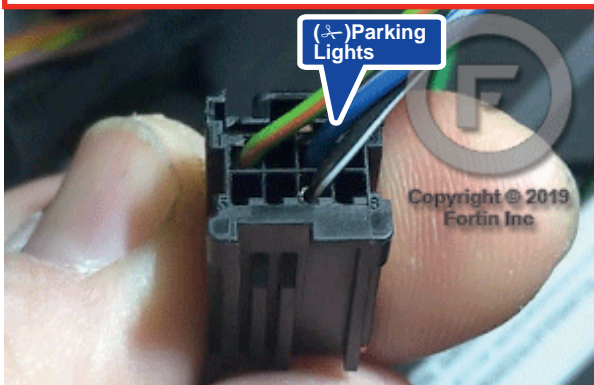

④ Under the hood If not equipped with hood pin.

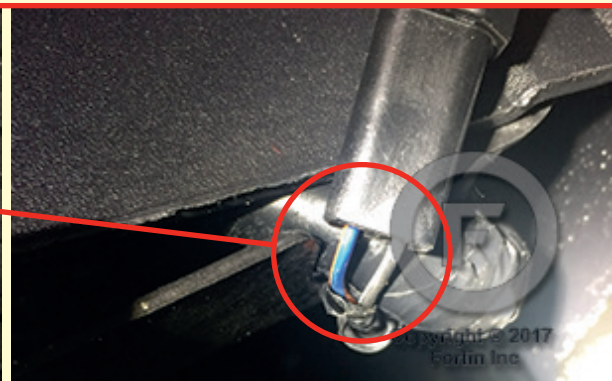

AUTOMATIC TRANSMISSION WIRING CONNECTION |

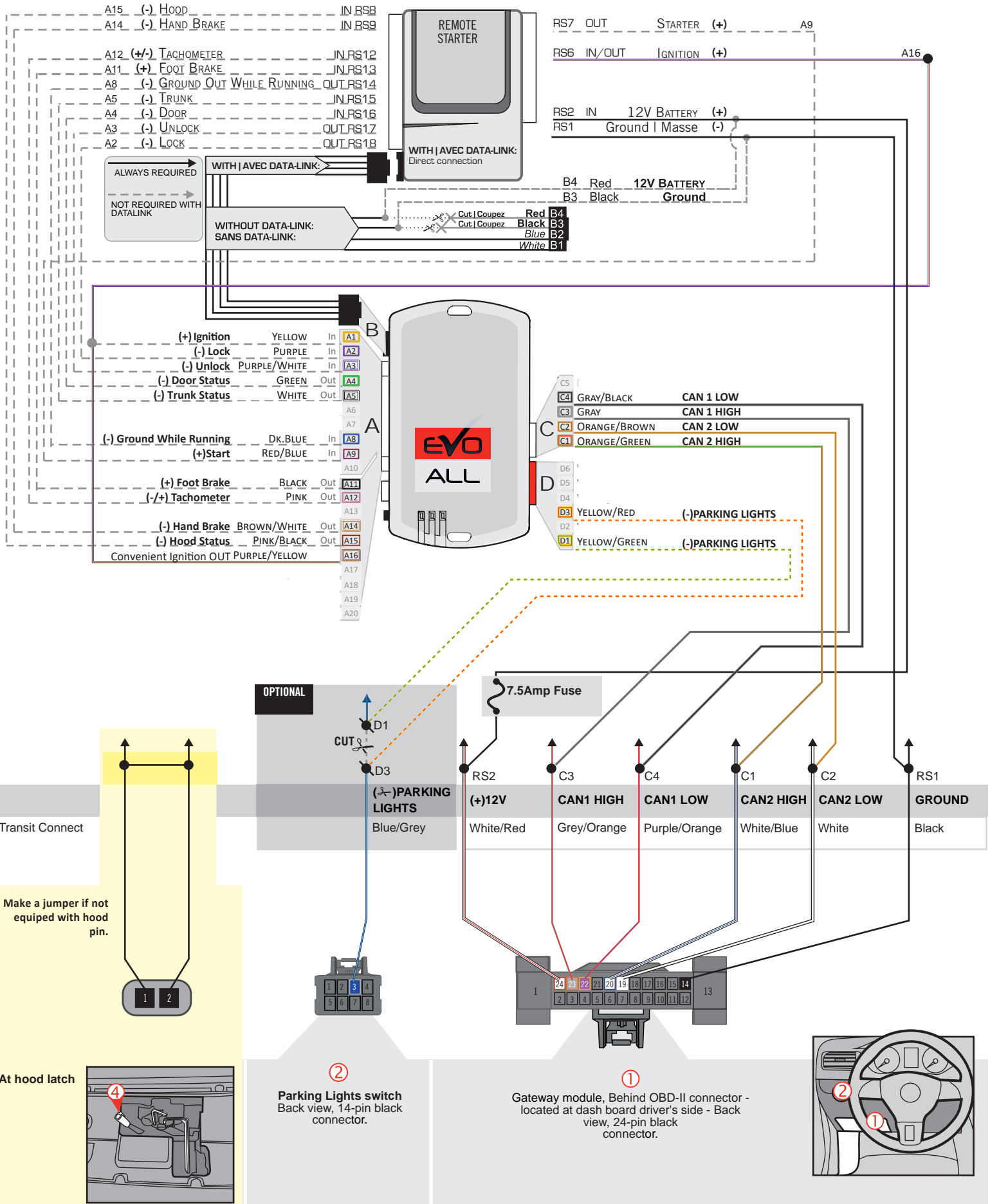

THAR-FOR3 | T-HARNESS - AUTOMATIC TRANSMISSION |

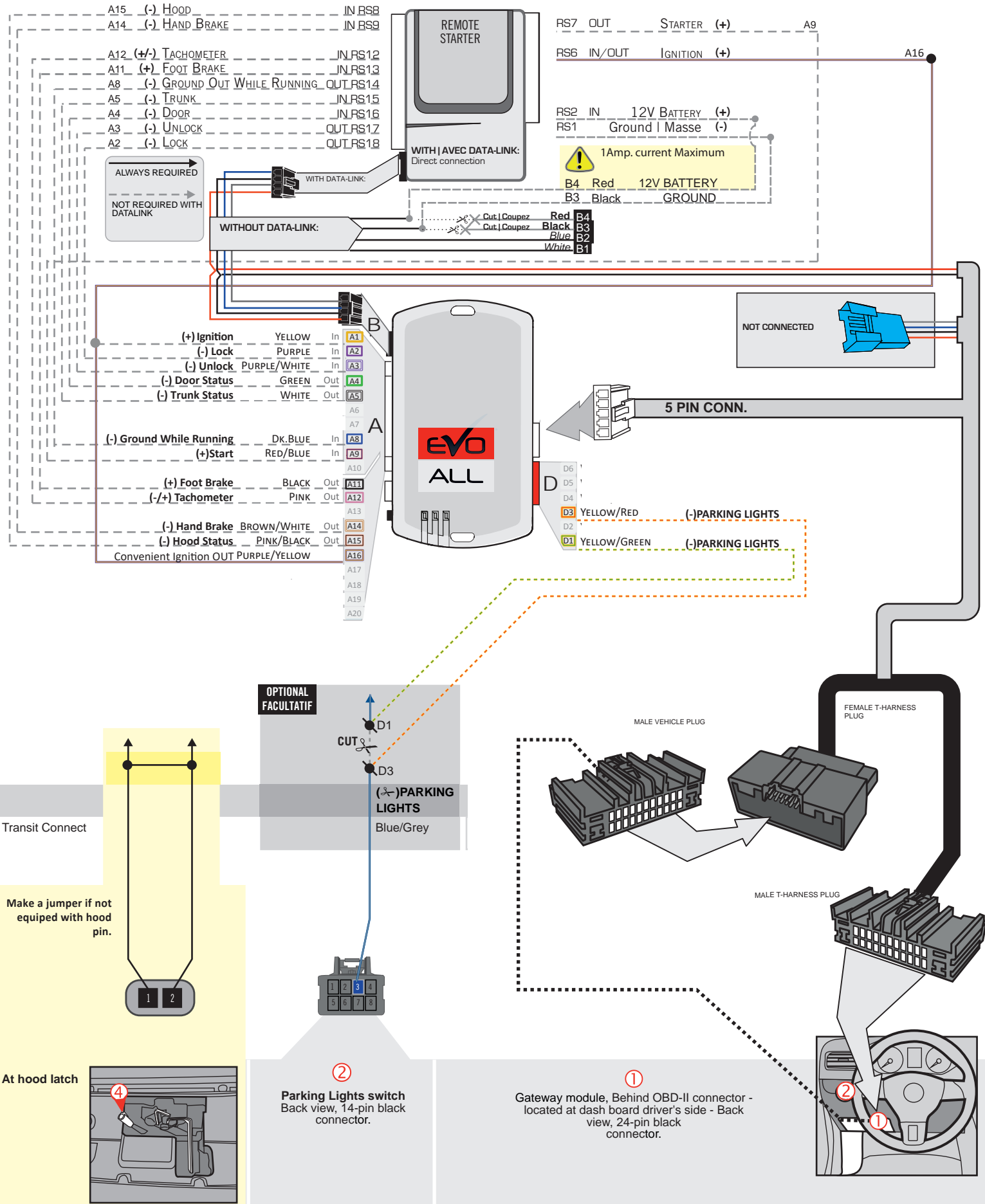



Parts required (not included)

- 1x **FLASH LINK UPDATER,**
- 1x **FLASH LINK MANAGER**
SOFTWARE | PROGRAMME
- 1x Microsoft Windows Computer with Internet connection

OR

- 1x **FLASH LINK MOBILE**
- 1x **FLASH LINK MOBILE APP**
- Smartphone *Android* or *iOS* with Internet connection
(Internet provider charges may apply)

BEFORE PROGRAMMING SET THE UNIT OPTIONS AND SAVE.

1

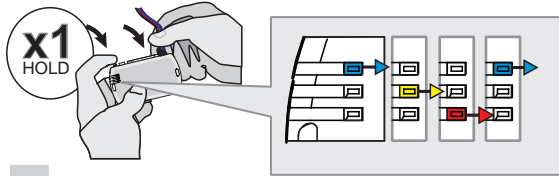

Press and hold the programming button:
Insert the 4-Pin (Data-Link) connector.

↳ The Blue, Red, Yellow and Blue & Red LEDs will alternatively illuminate.

2

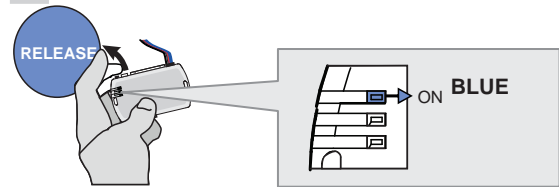

Release the programming button when the LED is BLUE.

If the LED is not solid BLUE disconnect the 4-Pin connector (Data-Link) and go back to step 1.

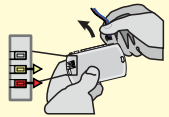

3

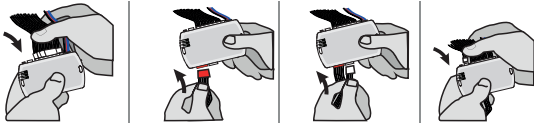

Insert the required remaining connectors.

4

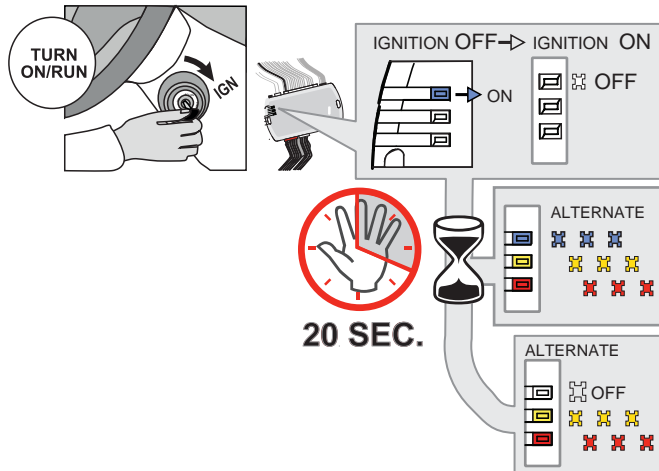

Turn the key to the Ignition ON/RUN position.

↳ The BLUE LED will turn OFF.

↳ The BLUE, YELLOW and RED LEDs will alternate.

Wait, at least 20 seconds, do not disconnect the modules or turn off the ignition.

↳ The RED and YELLOW LEDs will alternate.

Make sure that the DELs are flashing RED and YELLOW before continuing programming.

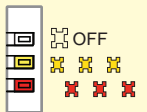

5

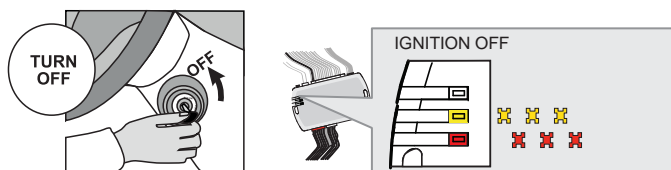

Turn the key to the OFF position.

↳ The RED and YELLOW LEDs alternate.

KEY BYPASS PROGRAMMING PROCEDURE 2/2 |

6

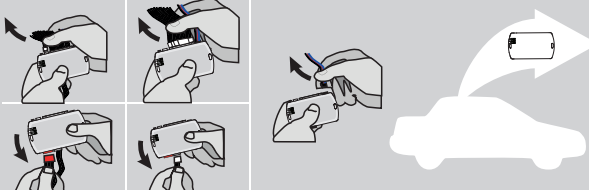

Disconnect all the connectors and after the Data-Link (4-pins) connector.

7



Microsoft Windows Computer with Internet connection*

FLASH LINK UPDATER* **FLASH LINK MANAGER***
SOFTWARE | PROGRAMME

OR

Smartphone* (Internet provider charges may apply)

FLASH LINK MOBILE*

VEHICLE'S OBDII CONNECTOR

Use the tool: FLASH LINK UPDATER or FLASH LINK MOBILE to visit the DCryptor menu.

*Parts required (not included)

8

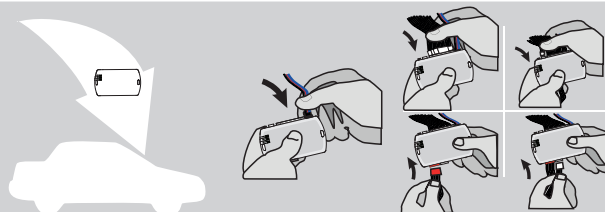

AFTER DCRYPTOR PROGRAMMING COMPLETED
Go back to the vehicle and reconnect the 4-Pin (Data-Link) connector and after, all the remaining connector.

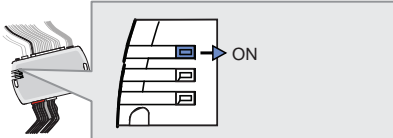

↳ The BLUE LED will turn ON.

9

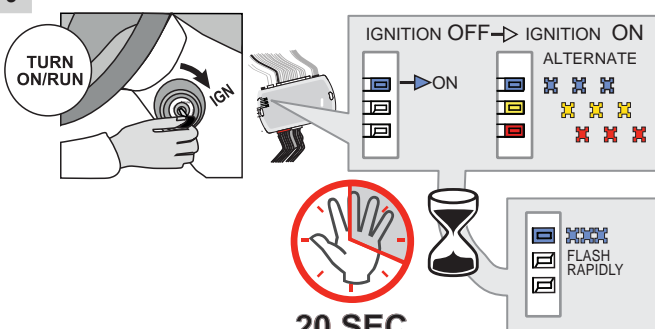

TURN ON/RUN

IGNITION OFF → IGNITION ON

ALTERNATE

↳ The RED and YELLOW LEDs will turn ON.

Wait, at least 20 seconds, do not disconnect the modules or turn off the ignition.

↳ The BLUE LED will flash rapidly.

20 SEC.

FLASH RAPIDLY

10

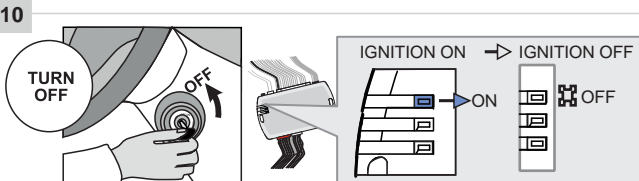

TURN OFF

IGNITION ON → IGNITION OFF

↳ The BLUE will turn OFF.



The module is now programmed.

REMOTE STARTER FUNCTIONALITY |



All doors must be closed.



Remote start the vehicle.



Unlock the doors with the remote-starter remote or the OEM remote.



Insert and Turn the key to the Ignition ON/RUN position.



Press the brake pedal.



The vehicle can now be put in to gear and driven.

REGULAR & THAR-FOR3 INSTALLATION

ADDENDUM - SUGGESTED WIRING CONFIGURATION



ONLY COMPATIBLE WITH AUTOMATIC TRANSMISSION VEHICLES.

Vehicle functions supported in this diagram (functional if equipped)

VEHICLE	YEARS	Vehicle functions supported in this diagram (functional if equipped)															
		Immobilizer bypass	Lock	Unlock	Arm	Disarm	Heated Seats**	Rear Defrost**	RAP Disable	Parking Lights***	Tachometer	Door Status	Trunk Status	Hood Status*	Hand-Brake Status	Foot-Brake Status	Active OEM Remote Start
LINCOLN Corsair	Push-to-Start 2020	•	•	•	•	•	•	•	•	•	•	•	•	•	•	•	•



COMPATIBLE MODULE REQUIRED:

QR CODE ON THE LABEL

MANUFACTURED AFTER: 2019

FIRMWARE VERSION

58.[02]

MINIMUM

To add the firmware version and the options, use the **FLASH LINK UPDATER** or **FLASH LINK MOBILE** tool, sold separately.

UNIT OPTION	DESCRIPTION
C1	OEM Remote status (Lock/Unlock) monitoring
D6	Push-to-Start
A11	OFF Hood trigger (Output Status).

NOTES

The vehicles OEM remote and SmartKey are still operable during remote start.

**Heated seats The heated seats and rear defrost activate automatically when it cold.

**Rear Defrost

***Parking Lights The parking Lights at remote start only.

MANDATORY INSTALL

*HOOD PIN

HOOD STATUS: THE HOOD PIN SWITCH MUST BE INSTALLED IF THE VEHICLE CAN BE REMOTE STARTED WITH THE HOOD OPEN, SET FUNCTION A11 TO OFF.

A11 **OFF**

Notice: the installation of safety elements are mandatory. The hood pin is an essential security element and must be installed.

THIS MODULE MUST BE INSTALLED BY A QUALIFIED TECHNICIAN. A WRONG CONNECTION CAN CAUSE PERMANENT DAMAGE TO THE VEHICLE.

DESCRIPTION |

	Parts required (Not included)	PAGE
--	-------------------------------	------

WIRE TO WIRE DIAGRAM

AUTOMATIC TRANSMISSION	1x 7.5 Amp. fuse	Page 3
------------------------	------------------	--------

THARNES DIAGRAM

THARNES THAR-FOR3 AUTOMATIC TRANSMISSION	1x THAR-FOR3	Page 4
--	--------------	--------



① Gateway module, Behind OBD-II connector

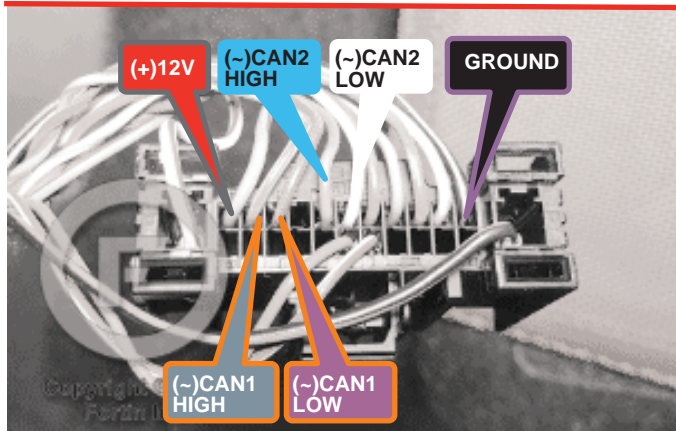

AUTOMATIC TRANSMISSION WIRING CONNECTION |

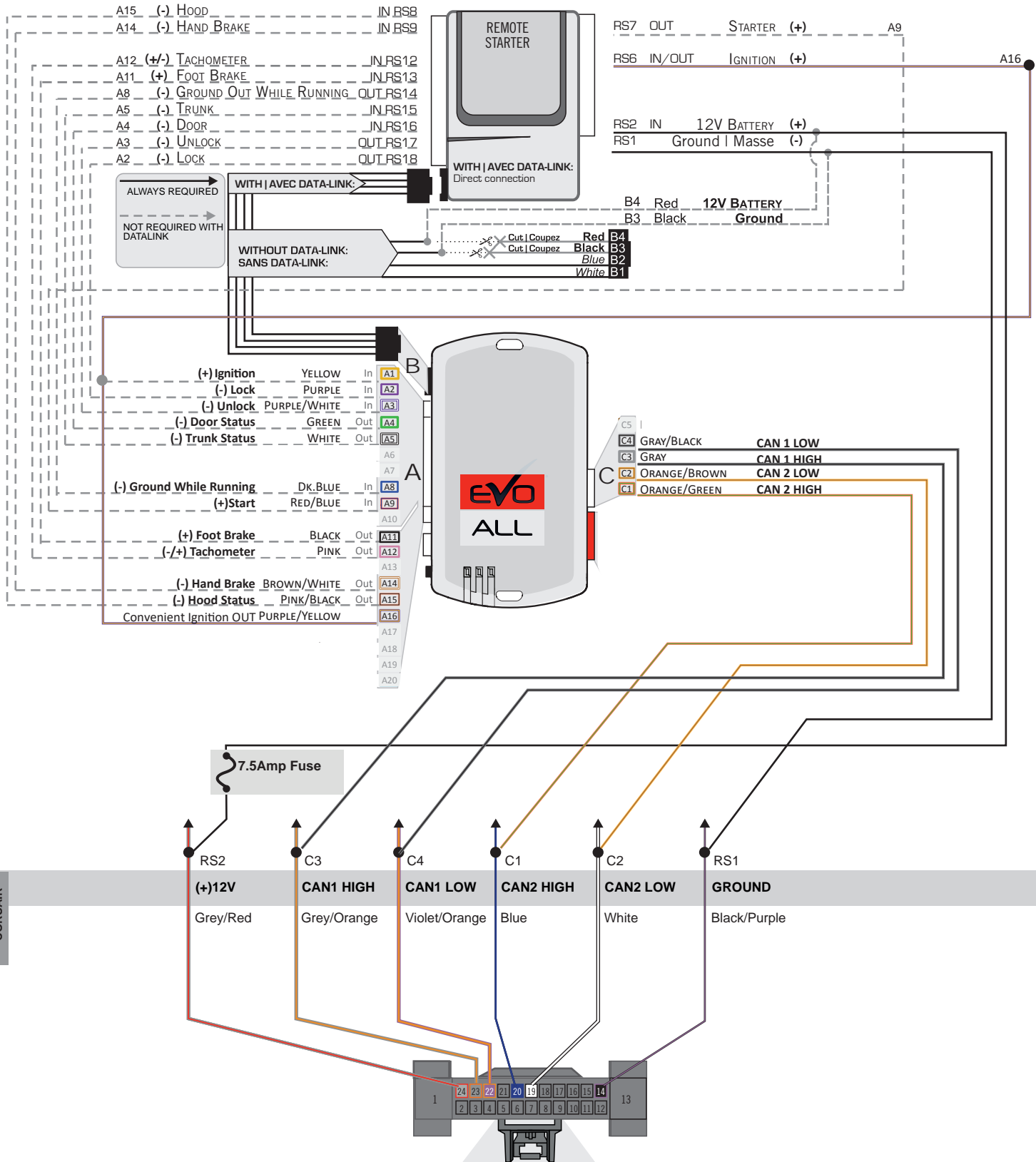

CORSAIR

① Gateway module, Connector Behind OBD-II connector - located at dash board driver's side Back view, 24-pin black connector.

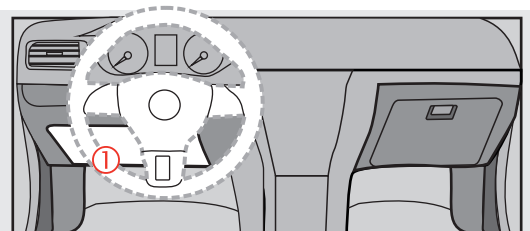

THAR-FOR3 | T-HARNESS - AUTOMATIC TRANSMISSION |

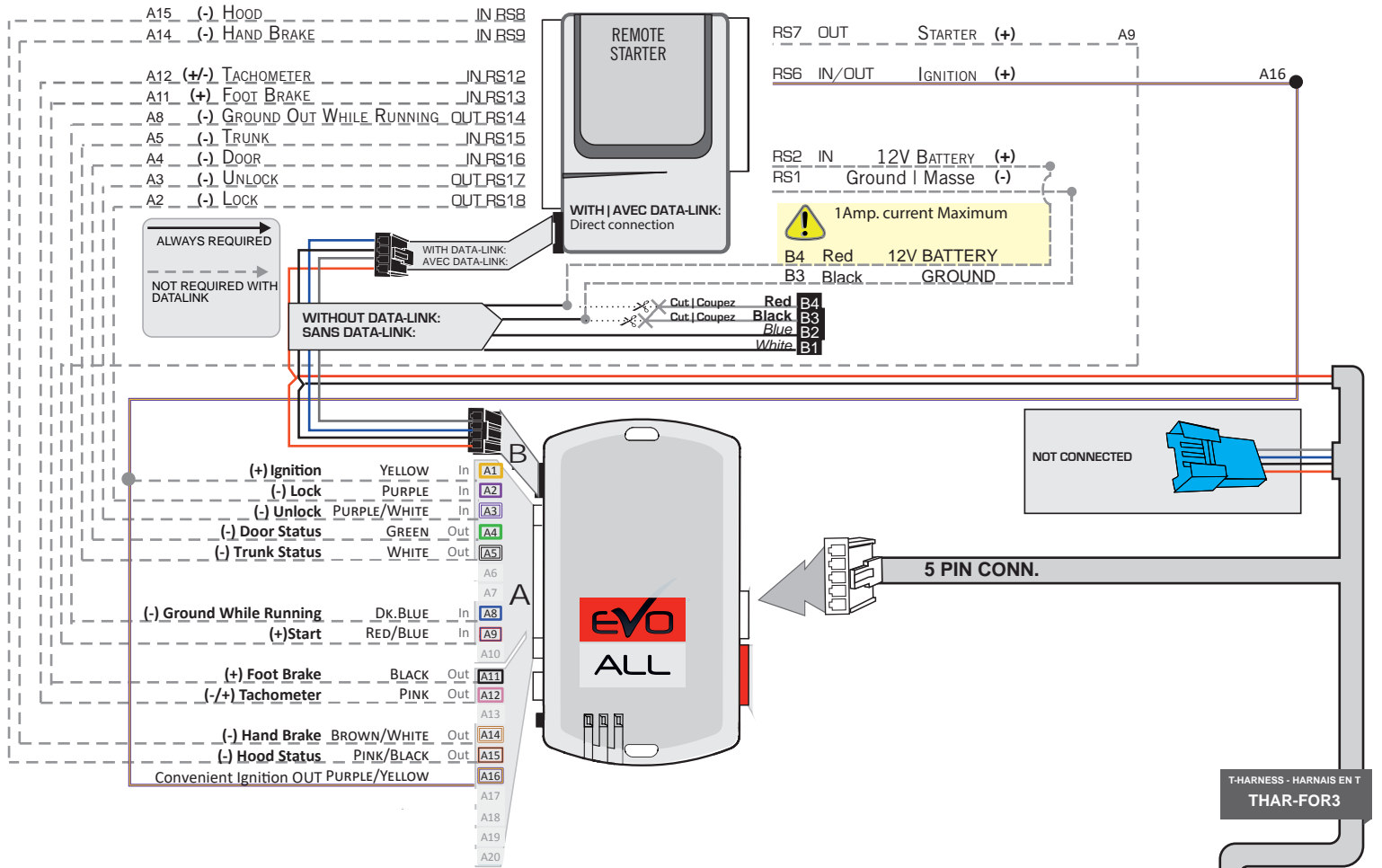

CORSAIR

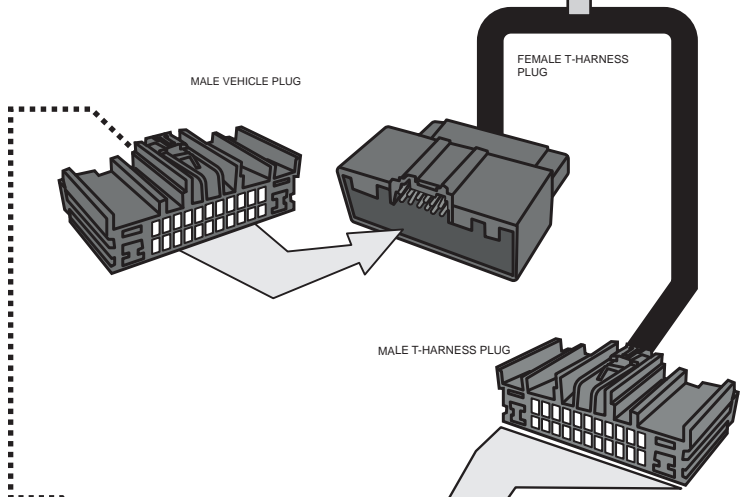

① Gateway module, Connector Behind OBD-II connector - located at dash board driver's side Back view, 24-pin black connector.

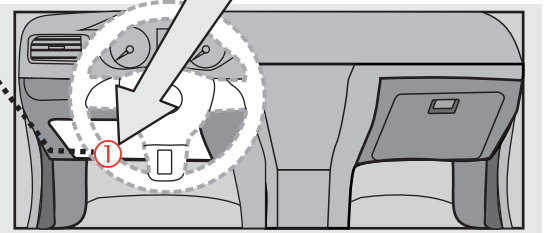



Parts required (not included)

- 1x FLASH LINK UPDATER, SOFTWARE | PROGRAMME
- 1x FLASH LINK MANAGER
- 1x Microsoft Windows Computer with Internet connection

OR

- 1x FLASH LINK MOBILE
- 1x FLASH LINK MOBILE APP
- Smartphone Android or iOS with Internet connection (Internet provider charges may apply)

BEFORE PROGRAMMING SET THE UNIT OPTIONS AND SAVE.

1

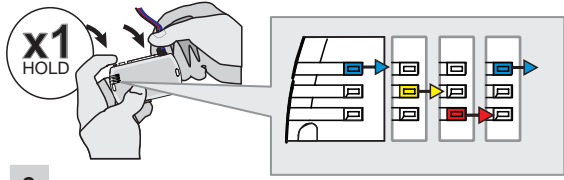

Press and hold the programming button:
Insert the 4-Pin (Data-Link) connector.

↳ The Blue, Red, Yellow and Blue & Red LEDs will alternatively illuminate.

2

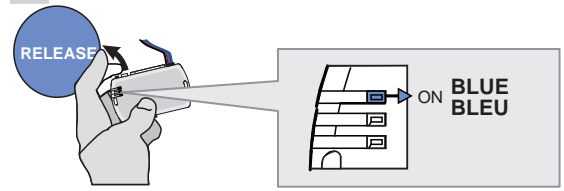

Release the programming button when the LED is BLUE.

If the LED is not solid BLUE disconnect the 4-Pin connector (Data-Link) and go back to step 1.

3

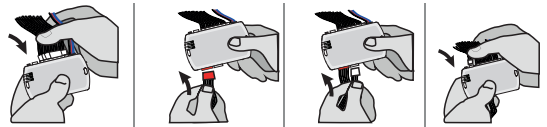

Insert the required remaining connectors.

4

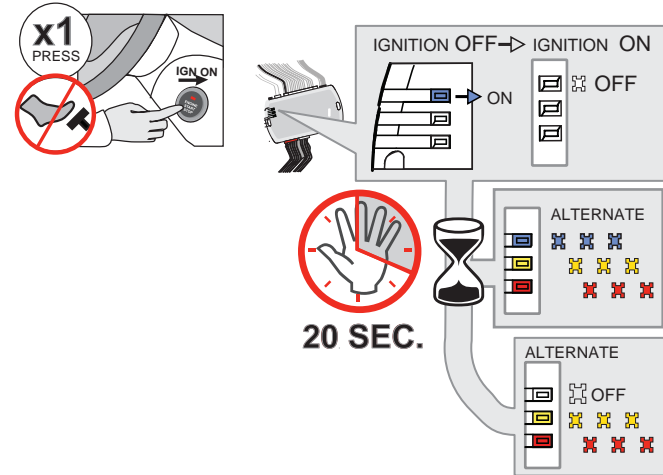

Do not press the brake pedal.
Press the Push-to-Start button once to turn on the ignition.

↳ The BLUE LED will turn OFF.

↳ The BLUE, YELLOW and RED LEDs will alternate.

Wait, at least 20 seconds, do not disconnect the modules or turn off the ignition.

↳ The RED and YELLOW LEDs will alternate.

Make sure that the DELs are flashing RED and YELLOW before continuing programming.

5

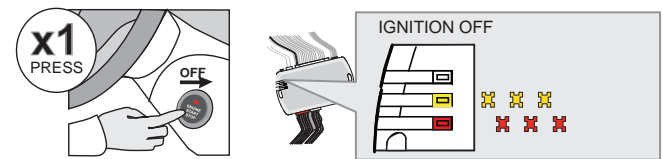

Press the Push-to-Start button once to turn off the ignition.

↳ The RED and YELLOW LEDs alternate.

KEY BYPASS PROGRAMMING PROCEDURE 2/2 |

6

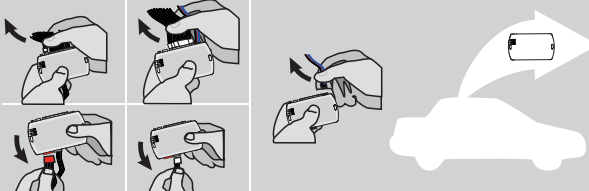

Disconnect all the connectors and after the Data-Link (4-pins) connector.

7



Microsoft Windows Computer with Internet connection*

FLASH LINK UPDATER* **FLASH LINK MANAGER***
SOFTWARE | PROGRAMME

OR

Smartphone* (Internet provider charges may apply)

VEHICLE'S OBDII CONNECTOR **FLASH LINK MOBILE***

Use the tool: FLASH LINK UPDATER or FLASH LINK MOBILE to visit the DCryptor menu.

*Parts required (not included)

8

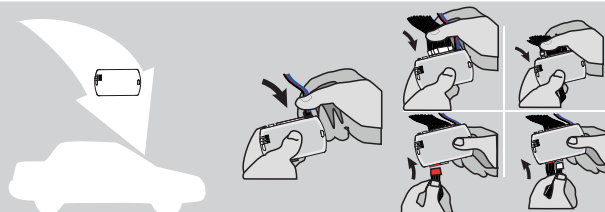

AFTER DCRYPTOR PROGRAMMING COMPLETED
Go back to the vehicle and reconnect the 4-Pin (Data-Link) connector and after, all the remaining connector.

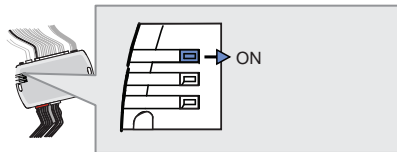

↳ The BLUE LED will turn ON.

9

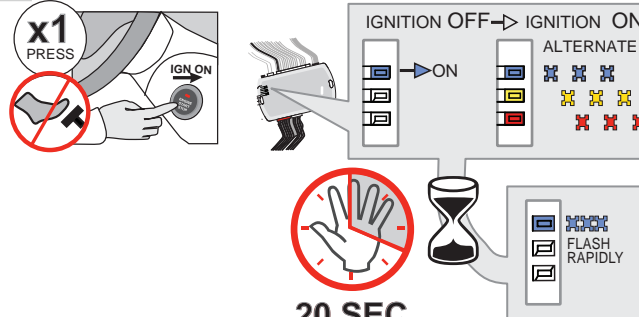

x1 PRESS (with a red 'X' over the push-to-start button)

IGNITION OFF → IGNITION ON

ALTERNATE

The RED and YELLOW LEDs will turn ON.

20 SEC. (with a hand icon and an hourglass)

FLASH RAPIDLY

Do not press the brake pedal. Press the Push-to-Start button once to turn on the ignition.

↳ The BLUE LED will flash rapidly.

10

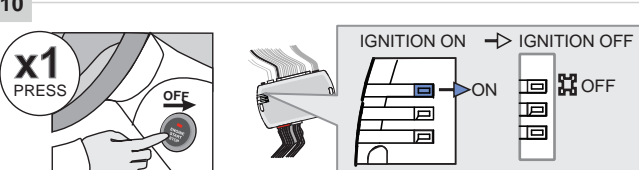

x1 PRESS (with a red 'X' over the push-to-start button)

IGNITION ON → IGNITION OFF





Press the Push-to-Start button once to turn off the ignition.

↳ The BLUE will turn OFF.

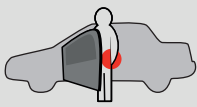

The module is now programmed.

REMOTE STARTER FUNCTIONALITY |

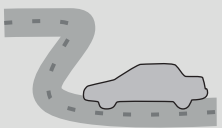
 <p>Start</p> <p>All doors must be closed. Toutes les</p> <p>Remote start the vehicle.</p>	 <p>UNLOCK</p> <p>Unlock the doors with either:</p> <ul style="list-style-type: none"> • The OEM remote • The remote-starter remote • Or the proximity remote 	 <p>Enter the vehicle with the SMART-KEY.</p>	 <p>DO NOT PRESS THE BRAKE PEDAL.</p> <p>Press and release the Push-to-Start button once.</p>	 <p>Press the brake pedal. The vehicle can now be put in to gear and driven.</p> <p>If the Smart-Key is not detected the vehicle will shut down.</p>
---	---	--	---	---

STANDALONE & THAR-FOR3 INSTALLATION

ADDENDUM - SUGGESTED WIRING CONFIGURATION



Vehicle functions supported in this diagram (functional if equipped)

VEHICLE	YEARS	Immobilizer bypass	Lock	Unlock	Arm	Disarm	Heated Seats**	Rear Defrost**	RAP Disable	Parking Lights***	Tachometer	Door Status	Trunk Status	Hood Status*	Hand-Brake Status	Foot-Brake Status	Active OEM Remote Start
FORD Bronco Sport	Push-to-Start 2021	•	•	•	•	•	•	•	•	•	•	•	•	•	•	•	•



	COMPATIBLE MODULE REQUIRED:	QR CODE ON THE LABEL MANUFACTURED AFTER: 2019	FIRMWARE VERSION 58.[02] MINIMUM	To add the firmware version and the options, use the FLASH LINK UPDATER or FLASH LINK MOBILE tool, sold separately.

UNIT OPTION	DESCRIPTION
C1	OEM Remote status (Lock/Unlock) monitoring
D6	Push-to-Start
A11	OFF Hood trigger (Output Status).

Program bypass option:

IF THE VEHICLE IS NOT EQUIPPED WITH FUNCTIONAL HOOD PIN:

NOTES

The vehicles OEM remote and SmartKey are still operable during remote start.

**Heated seats The heated seats and rear defrost will activate automatically when cold.
**Rear Defrost

***Parking Lights The parking lights will activate during remote start only.

MANDATORY INSTALL

*HOOD PIN **HOOD STATUS:** THE HOOD PIN SWITCH MUST BE INSTALLED IF THE VEHICLE CAN BE REMOTE STARTED WITH THE HOOD OPEN, SET FUNCTION A11 TO OFF.

A11 **OFF**

Notice: the installation of safety elements are mandatory. The hood pin is an essential security element and must be installed.

THIS MODULE MUST BE INSTALLED BY A QUALIFIED TECHNICIAN. A WRONG CONNECTION CAN CAUSE PERMANENT DAMAGE TO THE VEHICLE.

PARTS REQUIRED (NOT INCLUDED)

1x **FLASH LINK UPDATER,**
1x **FLASH LINK MANAGER**
SOFTWARE
1x Microsoft Windows Computer with Internet connection

OR

1x **FLASH LINK MOBILE**
1x **FLASH LINK MOBILE APP**
Smartphone Android or iOS with Internet connection (provider charges may apply).

MANDATORY

HOOD PIN



REMOTE START SAFETY OVERRIDE SWITCH

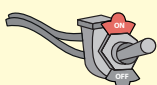







VALET SWITCH

Part #: RSPB available, Sold separately.

Notice: the installation of safety elements are mandatory. The hood pin and the valet switch are essential security elements and must be installed.

STAND ALONE CONFIGURATION

	Program bypass option	UNIT OPTION	DESCRIPTION
	OEM Remote Stand Alone Remote Starter:	D1.10 	By default, LOCK, LOCK, LOCK Par défaut, VERROUILLE, VERROUILLE, VERROUILLE
		D1.1 	
	Program bypass option with oem remote:	C1	OEM Remote Monitoring
	Program bypass option with RF KIT antenna:	H1 to H6	Supported RF Kits and select RF Kit
	Program bypass option Vehicle hybrid only:	D4	Hybrid mode (Vehicle hybrid only)

REMOTE STARTER FUNCTIONALITY



All doors must be closed.

3X 

Press the OEM remote's Lock button 3x to remote-start (or remote-stop) the vehicle.



START 

The vehicle will START.

REMOTE STARTER DIAGNOSTICS
MODULE RED LED

x2 flash :	Brake ON
x3 flash :	No tach
x4 flash :	Ignition before start
x5 flash :	Hood Open

REMOTE STARTER WARNING CARD



CUT THIS WARNING CARD AND STICK IT ON A VISIBLE PLACE:
or use the package RSPB, Sold separately.

WARNING | ATTENTION



REMOTE STARTER

THE VEHICLE CAN BE STARTED BY EITHER: PRESSING THE LOCK BUTTON ON THE OEM REMOTE 3 TIMES CONSECUTIVELY OR BY A SMARTPHONE. **TURN ON** THE SAFETY SWITCH LOCATED UNDER THE DASHBOARD BEFORE WORKING ON THE VEHICLE.

DESCRIPTION

	Parts required (Not included)	PAGE
--	-------------------------------	------

WIRE TO WIRE DIAGRAM

AUTOMATIC TRANSMISSION	1x 7.5 Amp. fuse	Page 3
------------------------	------------------	--------

THARNESS DIAGRAM

THARNESS THAR-FOR3 AUTOMATIC TRANSMISSION	1x THAR-FOR3	Page 4
---	--------------	--------

BRONCO SPORT



① Gateway module, Behind OBD-II connector

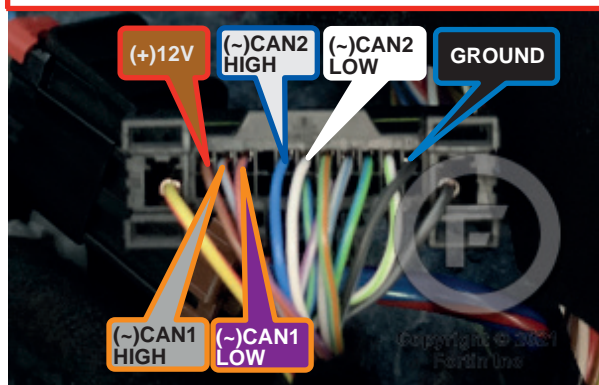

AUTOMATIC TRANSMISSION WIRING CONNECTION |

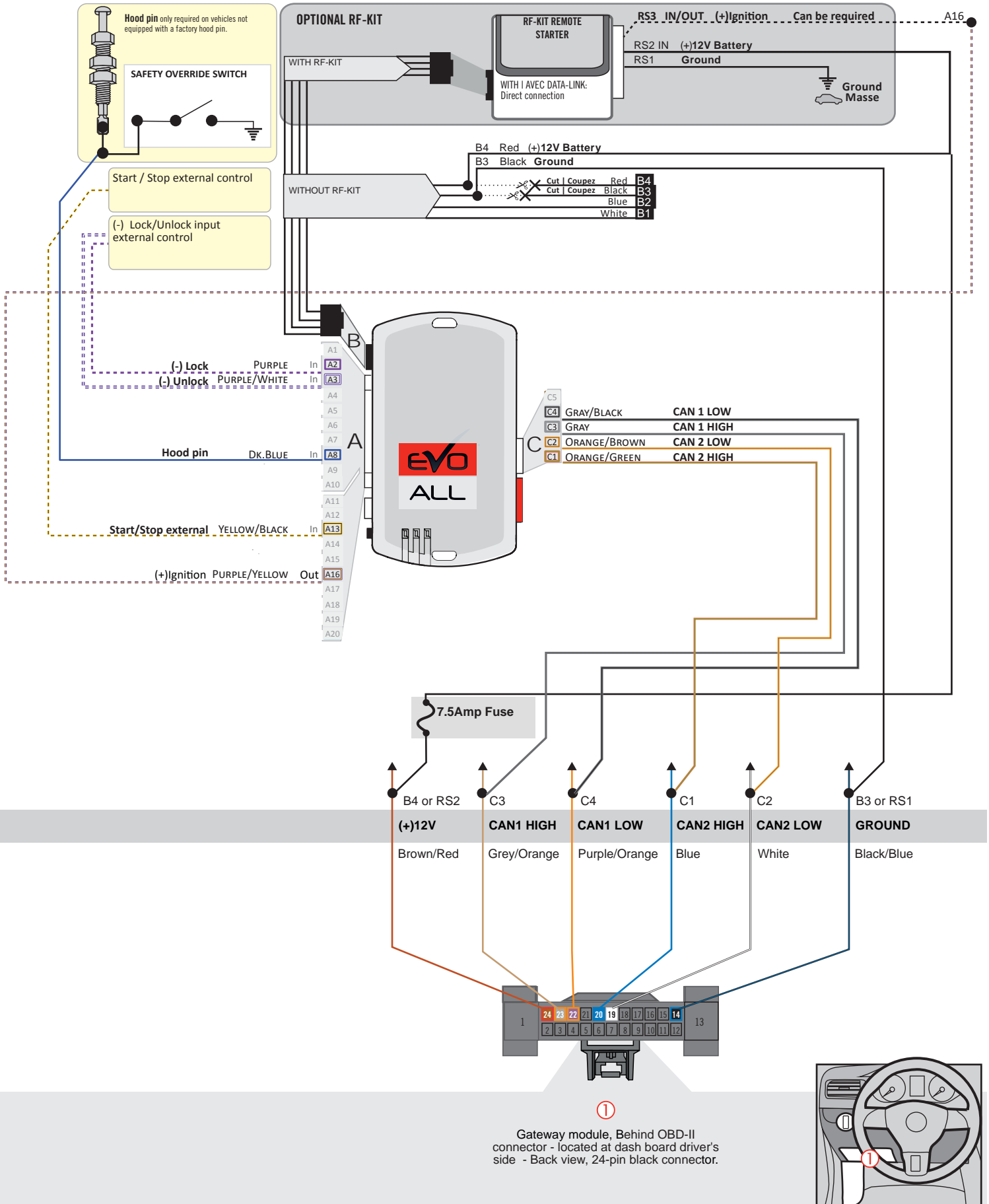

THAR-FOR3 | T-HARNESS - AUTOMATIC TRANSMISSION

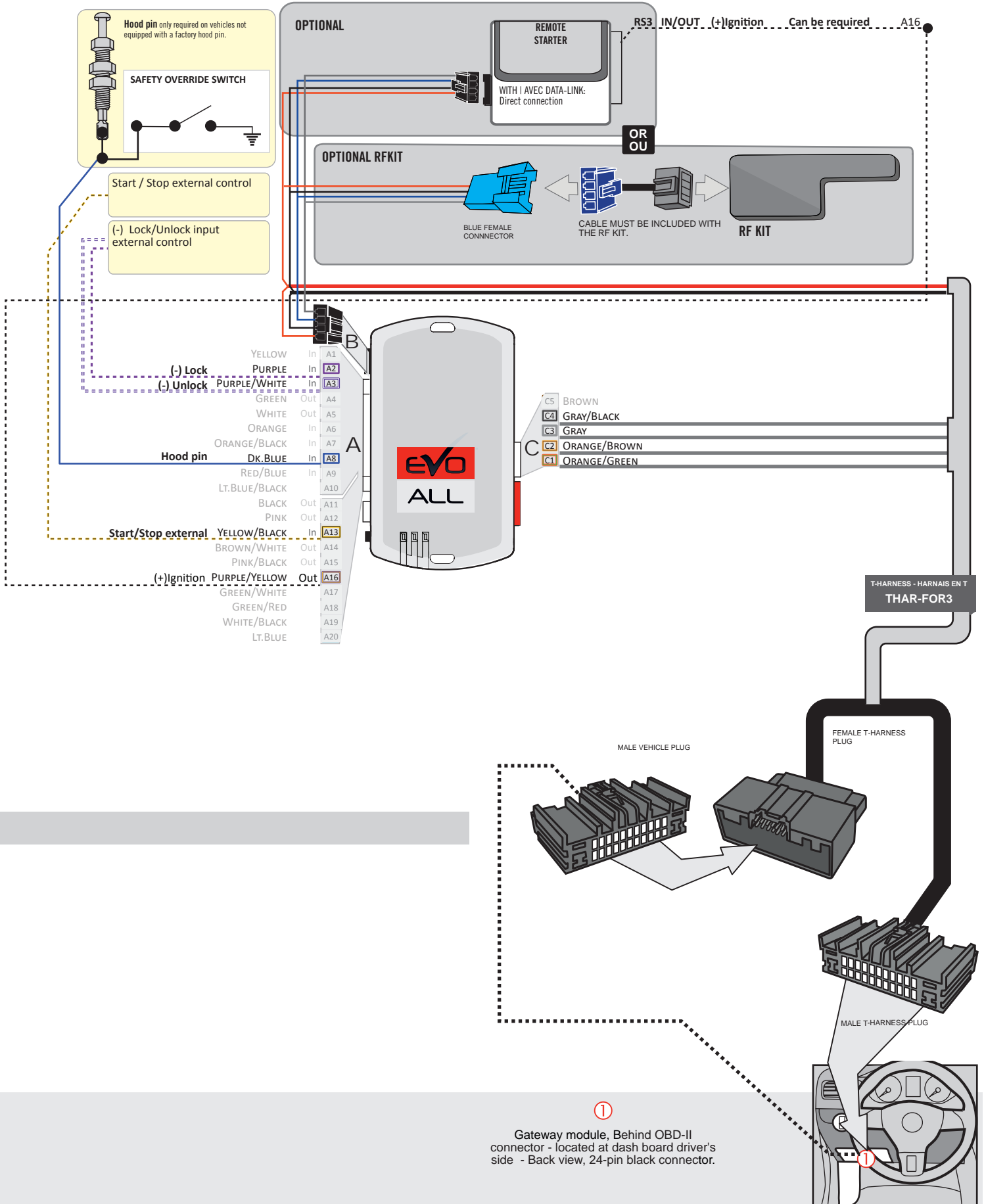

BRONCO SPORT

DCRYPTOR PROGRAMMING PROCEDURE



Parts required (not included)

- 1x **FLASH LINK UPDATER,**
- 1x **FLASH LINK MANAGER**
SOFTWARE
- 1x Microsoft Windows Computer with Internet connection

OR

- 1x **FLASH LINK MOBILE**
- 1x **FLASH LINK MOBILE APP**
- Smartphone *Android* or *iOS* with Internet connection
(Internet provider charges may apply)

BEFORE PROGRAMMING SET THE UNIT OPTIONS AND SAVE.

1

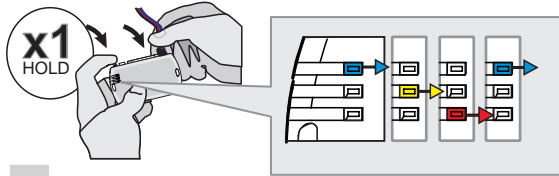

Press and hold the programming button:
Insert the 4-Pin (Data-Link) connector.

↳ The Blue, Red, Yellow and Blue & Red LEDs will alternatively illuminate.

2

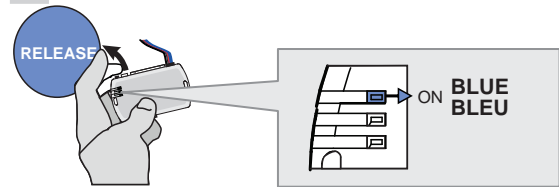

Release the programming button when the LED is BLUE.

If the LED is not solid BLUE disconnect the 4-Pin connector (Data-Link) and go back to step 1.

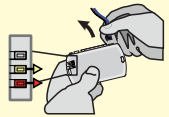

3

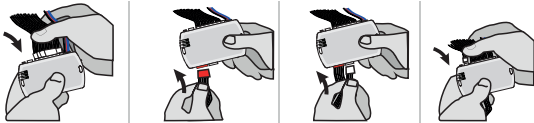

Insert the required remaining connectors.

4

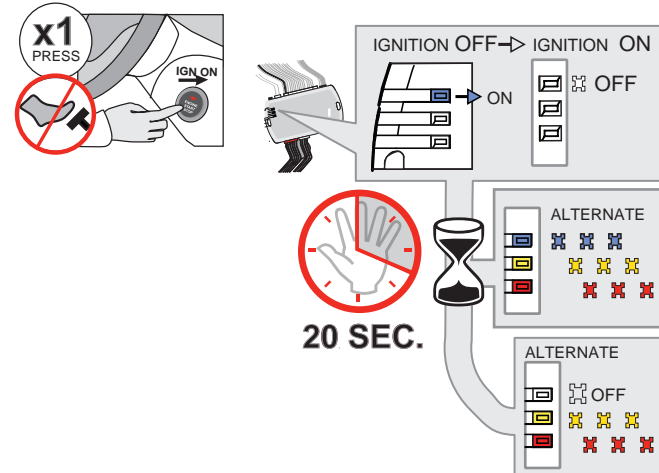

Do not press the brake pedal.
Press the Push-to-Start button once to turn on the ignition.

↳ The BLUE LED will turn OFF.

↳ The BLUE, YELLOW and RED LEDs will alternate.

Wait, at least 20 seconds, do not disconnect the modules or turn off the ignition.

↳ The RED and YELLOW LEDs will alternate.

Make sure that the DELs are flashing RED and YELLOW before continuing programming.

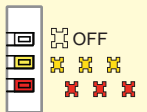

5

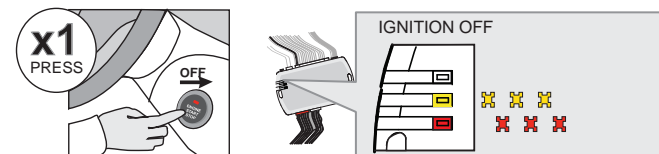

Press the Push-to-Start button once to turn off the ignition.

↳ The RED and YELLOW LEDs alternate.

KEY BYPASS PROGRAMMING PROCEDURE 2/2

6

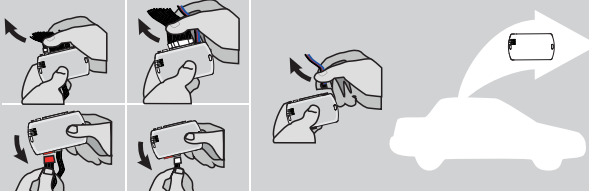

Disconnect all the connectors and after the Data-Link (4-pins) connector.

7



Microsoft Windows Computer with Internet connection*

FLASH LINK UPDATER* **FLASH LINK MANAGER*** SOFTWARE

OR

Smartphone* (Internet provider charges may apply)

FLASH LINK MOBILE*

VEHICLE'S OBDII CONNECTOR

Use the tool: FLASH LINK UPDATER or FLASH LINK MOBILE to visit the DCRYPTOR menu.

*Parts required (not included)

8

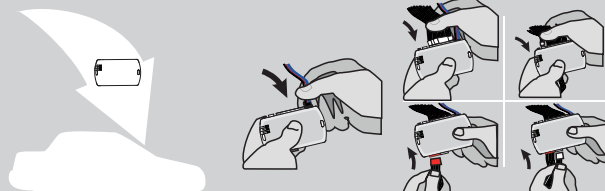

AFTER DCRYPTOR PROGRAMMING COMPLETED
Go back to the vehicle and **reconnect** the 4-Pin (Data-Link) connector and after, all the remaining connector.

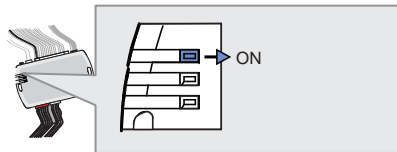

↳ The BLUE LED will turn ON.

9

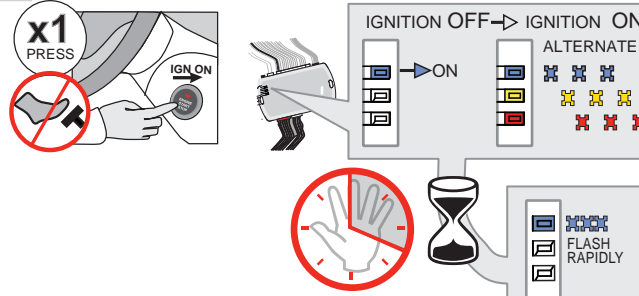

x1 PRESS (with a 'no brake pedal' symbol)

IGNITION OFF → IGNITION ON

ALTERNATE

↳ The RED and YELLOW LEDs will turn ON.

Wait, at least 20 seconds, do not disconnect the modules or turn off the ignition.

↳ The BLUE LED will flash rapidly.

20 SEC.

FLASH RAPIDLY

10

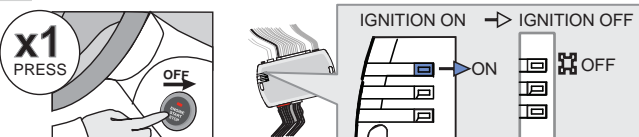

x1 PRESS

IGNITION ON → IGNITION OFF

↳ The BLUE will turn OFF.



The module is now programmed.



OPTIONAL RF-KIT PROGRAMMING

PROGRAM BYPASS OPTION







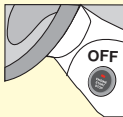



	<p>Program bypass option:</p>	<p>H2</p>	<p><input checked="" type="checkbox"/> Supported RF-KITS enable <input checked="" type="checkbox"/> H2 Fortin 2</p>
---	-------------------------------	------------------	---

OPTIONAL FORTIN RF KIT SERIES 4 OR SERIES 9 PROGRAMMING

The module must be programmed on the vehicle.

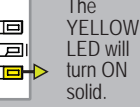
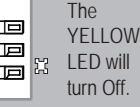
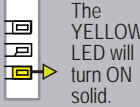
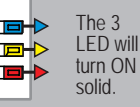

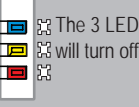
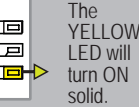
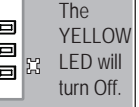
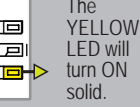
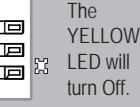
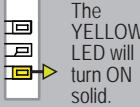
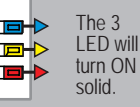

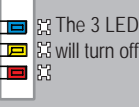
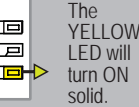
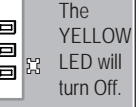

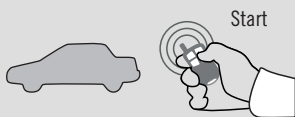

MAKE SURE THE IGNITION KEY HAS BEEN IN THE OFF POSITION FOR AT LEAST 5 SECONDS.

<p>1</p> <p>ON x1 PRESS</p>  <p>Do not press the brake pedal. Press the Push-to-Start button once to turn on the ignition.</p>	<p>2</p> <p>OFF x1 PRESS</p>  <p>Press the Push-to-Start button once to turn off the ignition.</p>	<p>3</p> <p>ON x1 PRESS</p>  <p>Do not press the brake pedal. Press the Push-to-Start button once to turn on the ignition.</p>	<p>4</p> <p>4X BRAKES</p> <p>x4 PRESS</p>  <p>Press and release the brake pedal four times. Appuyez et relâchez quatre fois la pédale de frein.</p>	<p>5</p> <p>ON EACH TRANSMITTER</p> <p>4 BUTTONS</p> <p>[-] PRESS AND RELEASE</p> <p>→ PRESS AND RELEASE</p> <p>[] 1 BUTTON</p> <p>PRESS APPROX. 12 SEC. AND WAIT FOR THE BLUE LED TO TURN OFF THEN BACK ON SOLID THEN RELEASE.</p>	<p>6</p> <p>OFF x1 PRESS</p>  <p>Press the Push-to-Start button once to turn off the ignition.</p>	<p>7</p> <p>ON x1 PRESS</p>  <p>Do not press the brake pedal. Press the Push-to-Start button once to turn on the ignition and leave it ON for 5 sec..</p>	<p>8</p> <p>OFF x1 PRESS</p>  <p>Press the Push-to-Start button once to turn off the ignition.</p>
 <p>The YELLOW LED will turn ON solid.</p>	 <p>The YELLOW LED will turn Off.</p>	 <p>The YELLOW LED will turn ON solid.</p>	 <p>The LED will flash rapidly.</p>	 <p>The LED will turn off each time.</p>	 <p>The LED will turn Off.</p>	 <p>The YELLOW LED will turn ON solid.</p>	 <p>The YELLOW LED will turn Off.</p>
 <p>The YELLOW LED will turn ON solid.</p>	 <p>The YELLOW LED will turn Off.</p>	 <p>The YELLOW LED will turn ON solid.</p>	 <p>The 3 LED will turn ON solid.</p>	 <p>The LED will flash rapidly.</p>	 <p>The 3 LED will turn off.</p>	 <p>The YELLOW LED will turn ON solid.</p>	 <p>The YELLOW LED will turn Off.</p>

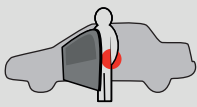

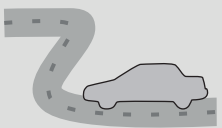
REMOTE STARTER FUNCTIONALITY

 <p>Start</p> <p>All doors must be closed.</p> <p>Remote start the vehicle.</p>	 <p>UNLOCK</p> <p>Unlock the doors with either:</p> <ul style="list-style-type: none"> • The OEM remote • The remote-starter remote • Or the proximity remote 	 <p>Enter the vehicle with the SMART-KEY.</p>	 <p>DO NOT PRESS THE BRAKE PEDAL.</p> <p>Press and release the Push-to-Start button once.</p>	 <p>Press the brake pedal. The vehicle can now be put in to gear and driven.</p> <p>If the Smart-Key is not detected the vehicle will shut down.</p>
--	---	--	---	---

STANDALONE & THAR-FOR3 INSTALLATION

ADDENDUM - SUGGESTED WIRING CONFIGURATION



ONLY COMPATIBLE WITH AUTOMATIC TRANSMISSION VEHICLES.

VEHICLE	YEARS	Vehicle functions supported in this diagram (functional if equipped)												
		T-Harness available (sold separately)	Lock	Unlock	Arm	Disarm	Parking Lights	Tachometer	Door Status	Hood Status*	Hand-Brake Status	Foot-Brake Status		
														
FORD														
E-350	2021	•	•	•	•	•	•	•	•	•	•	•	•	•
E-450	2021	•	•	•	•	•	•	•	•	•	•	•	•	•



FIRMWARE VERSION

71.[52]

MINIMUM

To add the firmware version and the options, use the **FLASH LINK UPDATER** or **FLASH LINK MOBILE** tool, sold separately.

	Program bypass option:	UNIT OPTION	DESCRIPTION
		A3	OFF
IF THE VEHICLE IS NOT EQUIPPED WITH FUNCTIONAL HOOD PIN:		A11	OFF
			Hood trigger (Output Status).

Parts required (Not included)			PAGE
WIRE TO WIRE DIAGRAM			
	2x	Diode 1Amp	Page 3
	1x	Relay (Parking lights)	
THARNESSE DIAGRAM			
	1x	THAR-FOR3	Page 4
THARNESSE THAR-FOR3	2x	Diode 1Amp	
	1x	Relay (Parking lights)	

MANDATORY INSTALL

*HOOD PIN



HOOD STATUS: THE HOOD PIN SWITCH MUST BE INSTALLED IF THE VEHICLE CAN BE REMOTE STARTED WITH THE HOOD OPEN, SET FUNCTION A11 TO OFF.

A11

OFF

Notice: the installation of safety elements are mandatory. The hood pin is an essential security element and must be installed.

THIS MODULE MUST BE INSTALLED BY A QUALIFIED TECHNICIAN. A WRONG CONNECTION CAN CAUSE PERMANENT DAMAGE TO THE VEHICLE.

PARTS REQUIRED (NOT INCLUDED)

1x **FLASH LINK UPDATER,**
1x **FLASH LINK MANAGER**
SOFTWARE | PROGRAMME
1x Microsoft Windows Computer with Internet connection

OR

1x **FLASH LINK MOBILE**
1x **FLASH LINK MOBILE APP**
Smartphone Android or iOS with Internet connection (provider charges may apply).

MANDATORY

HOOD PIN



REMOTE START SAFETY OVERRIDE SWITCH

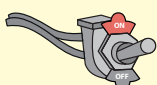







VALET SWITCH

Part #: RSPB available, Sold separately.

Notice: the installation of safety elements are mandatory. The hood pin and the valet switch are essential security elements and must be installed.

STAND ALONE CONFIGURATION

	Program bypass option	UNIT OPTION	DESCRIPTION
	OEM Remote Stand Alone Remote Starter:	D1.10 	By default, LOCK, LOCK, LOCK
		D1.1 	Par défaut, VERROUILLE, VERROUILLE, VERROUILLE
	Program bypass option with oem remote:	C1	OEM Remote Monitoring
	Program bypass option with RF KIT antenna:	H1 to H6	Supported RF Kits and select RF Kit
	Program bypass option Vehicle hybrid only:	D4	Hybrid mode (Vehicle hybrid only)

REMOTE STARTER FUNCTIONALITY



All doors must be closed.

3X 

Press the OEM remote's Lock button 3x to remote-start (or remote-stop) the vehicle.



The vehicle will START.

REMOTE STARTER DIAGNOSTICS
MODULE RED LED

x2 flash :	Brake ON
x3 flash :	No tach
x4 flash :	Ignition before start
x5 flash :	Hood Open

REMOTE STARTER WARNING CARD



CUT THIS WARNING CARD AND STICK IT ON A VISIBLE PLACE:
or use the package RSPB, Sold separately.

WARNING | ATTENTION



REMOTE STARTER

THE VEHICLE CAN BE STARTED BY EITHER: PRESSING THE LOCK BUTTON ON THE OEM REMOTE 3 TIMES CONSECUTIVELY OR BY A SMARTPHONE. **TURN ON** THE SAFETY SWITCH LOCATED UNDER THE DASHBOARD BEFORE WORKING ON THE VEHICLE.

DESCRIPTION | DESCRIPTION



② Parking Lights switch



③ Gateway module, Behind OBD-II connector

④ Passenger kick panel

① Ignition switch

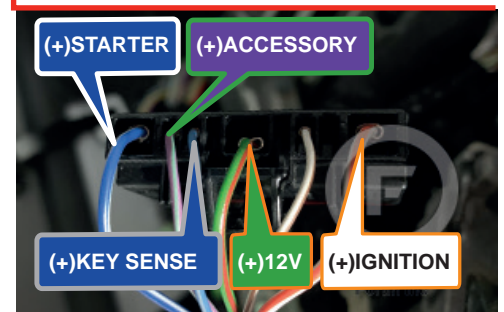
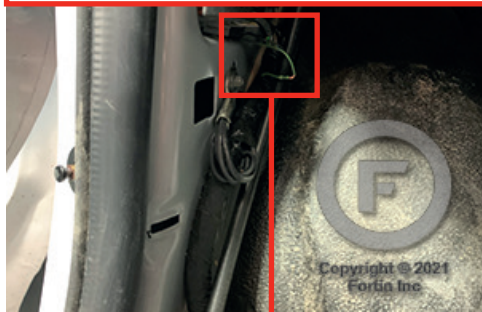
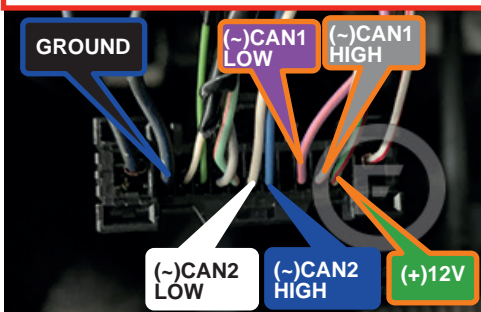

AUTOMATIC TRANSMISSION WIRING CONNECTION

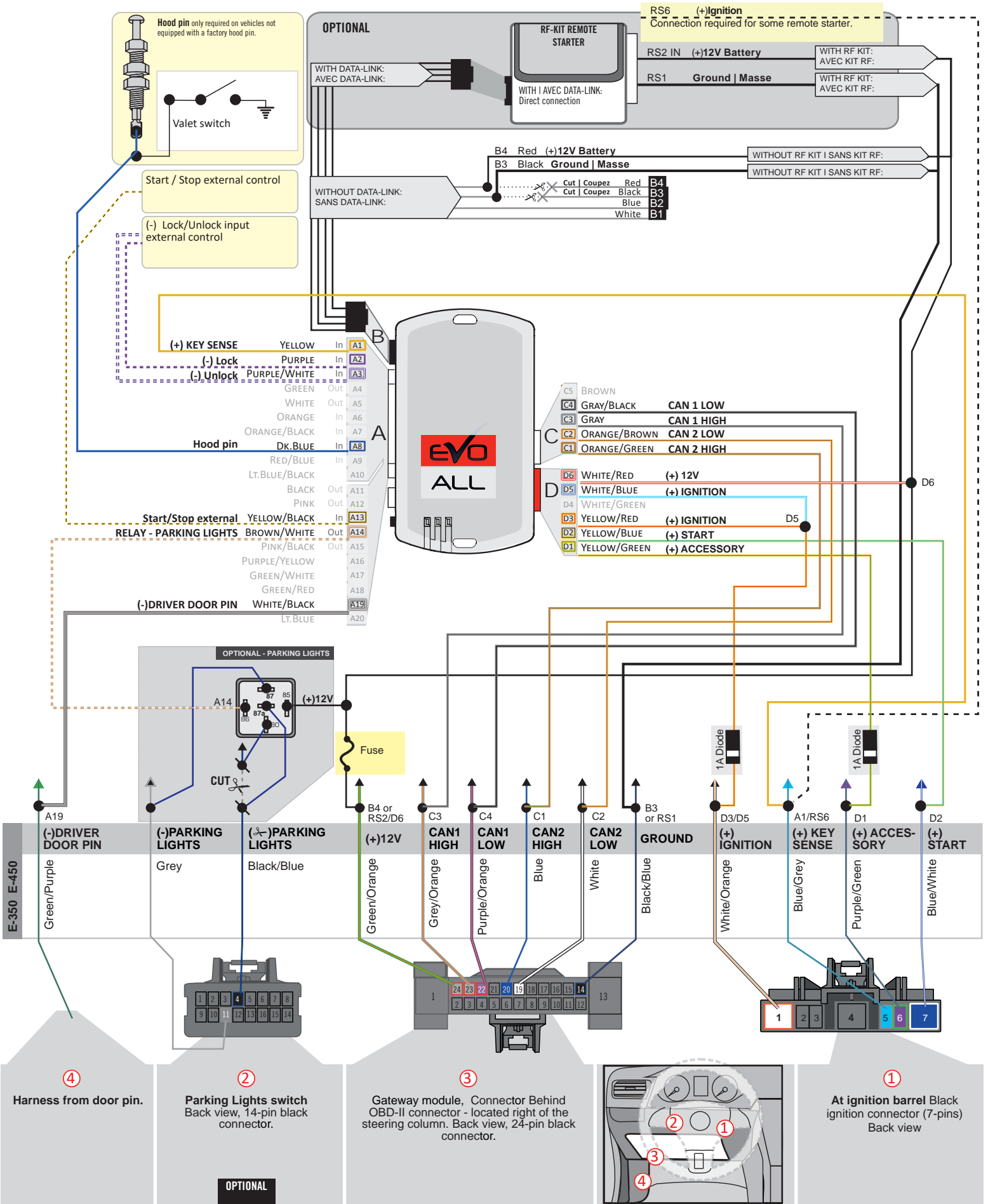

THAR-FOR3 | T-HARNESS - AUTOMATIC TRANSMISSION

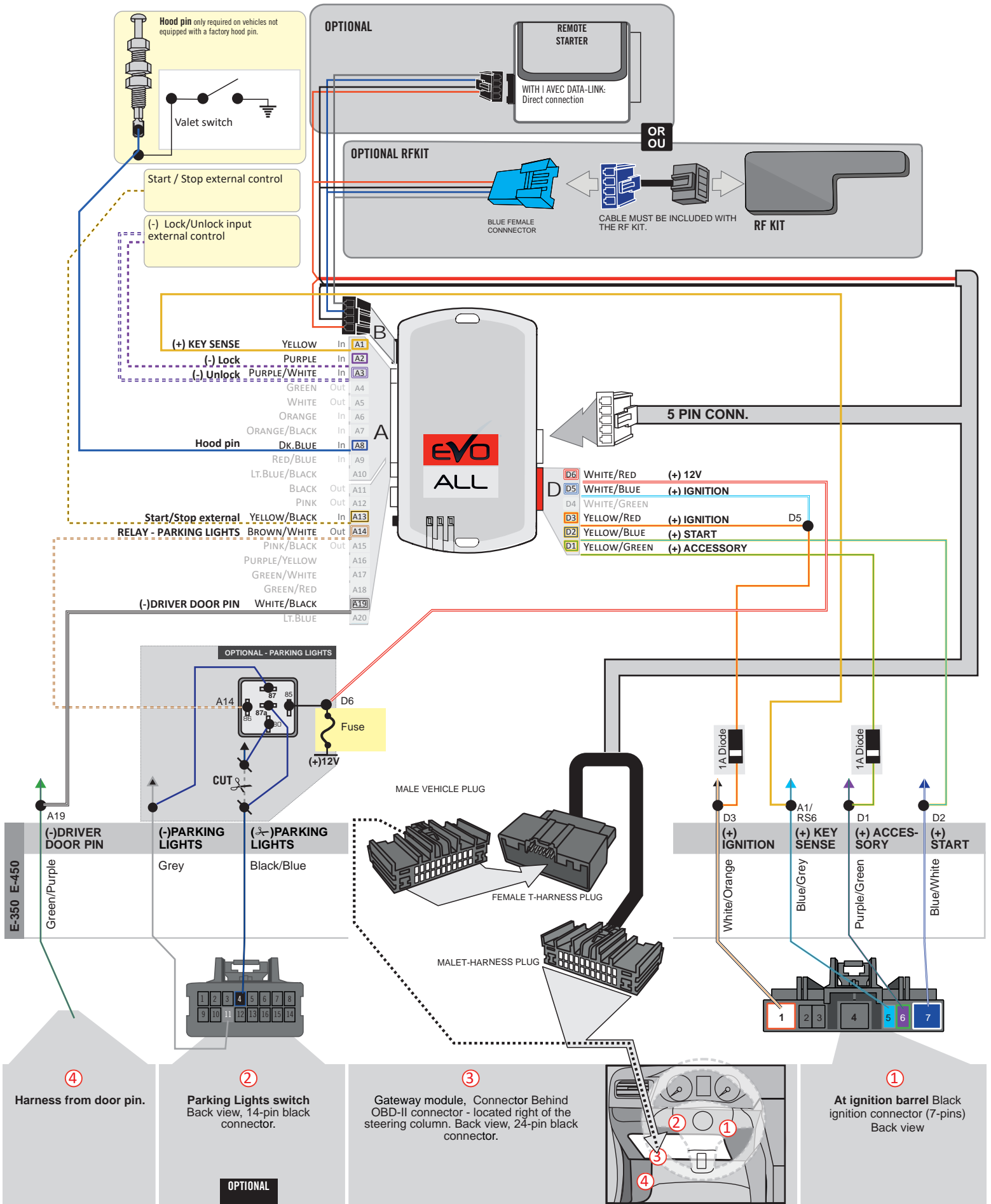

PROGRAMMING PROCEDURE

1

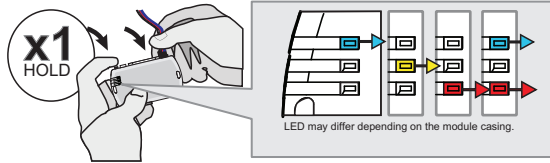

Press and hold the programming button:
Connect the 4-PIN Data-link harness (Black connector).

↳ The Blue, Red, Yellow and Blue & Red LEDs will alternatively illuminate.

2

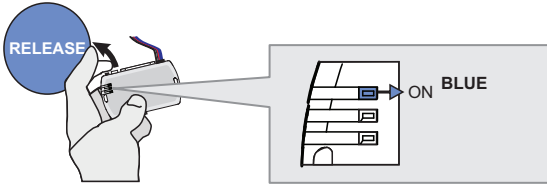

Release the programming button when the LED is BLUE.

If the LED is not solid BLUE disconnect the 4-Pin connector (Data-Link) and go back to step 1.

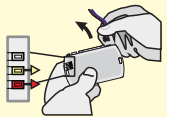

3

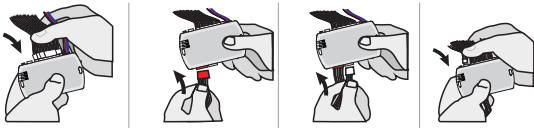

Insert the required remaining connectors.

4

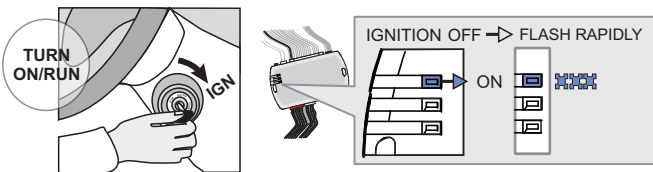

Turn the key to the Ignition ON/RUN position.

↳ The BLUE LED will flash rapidly.

5

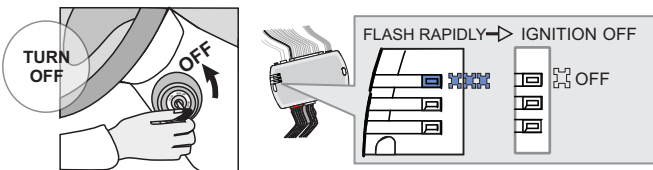

Turn the key to the OFF position.

↳ The BLUE LED will turn off.



The module is now programmed.

REMOTE STARTER FUNCTIONALITY



All doors must be closed.



Remote start the vehicle.



Unlock the doors with the remote-starter remote or the OEM remote.



Insert and Turn the key to the Ignition ON/RUN position.



Press the brake pedal.



The vehicle can now be put in to gear and driven.

STANDALONE & THAR-FOR3 INSTALLATION

ADDENDUM - SUGGESTED WIRING CONFIGURATION



Vehicle functions supported in this diagram (functional if equipped)

VEHICLE	YEARS	Immobilizer bypass	Lock	Unlock	Arm	Disarm	Heated Seats**	Rear Defrost**	RAP Disable	Parking Lights***	Tachometer	Door Status	Trunk Status	Hood Status*	Hand-Brake Status	Foot-Brake Status	Active OEM Remote Start
LINCOLN Aviator	Push-to-Start 2020	•	•	•	•	•	•	•	•	•	•	•	•	•	•	•	•

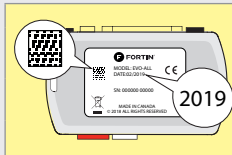

COMPATIBLE MODULE REQUIRED:

QR CODE ON THE LABEL
MANUFACTURED AFTER: 2019

FIRMWARE VERSION
58.[02]
MINIMUM

To add the firmware version and the options, use the **FLASH LINK UPDATER** or **FLASH LINK MOBILE** tool, sold separately.



Program bypass option:

UNIT OPTION

DESCRIPTION

C1

OEM Remote status (Lock/Unlock) monitoring

D6

Push-to-Start

IF THE VEHICLE IS NOT EQUIPPED WITH FUNCTIONAL HOOD PIN:

A11

OFF

Hood trigger (Output Status).

NOTES

The vehicles OEM remote and SmartKey are still operable during remote start.

**Heated seats The heated seats and rear defrost activate automatically when it cold.
**Rear Defrost

***Parking Lights The parking Lights at remote start only.

MANDATORY INSTALL

*HOOD PIN



HOOD STATUS: THE HOOD PIN SWITCH MUST BE INSTALLED IF THE VEHICLE CAN BE REMOTE STARTED WITH THE HOOD OPEN, SET FUNCTION A11 TO OFF.

A11

OFF

Notice: the installation of safety elements are mandatory. The hood pin is an essential security element and must be installed.

THIS MODULE MUST BE INSTALLED BY A QUALIFIED TECHNICIAN. A WRONG CONNECTION CAN CAUSE PERMANENT DAMAGE TO THE VEHICLE.

PARTS REQUIRED (NOT INCLUDED)

1x **FLASH LINK UPDATER**
 1x **FLASH LINK MANAGER**
 SOFTWARE | PROGRAMME
 1x Microsoft Windows Computer with Internet connection

OR

1x **FLASH LINK MOBILE**
 1x **FLASH LINK MOBILE APP**
 Smartphone Android or iOS with Internet connection (provider charges may apply).

MANDATORY

HOOD PIN



REMOTE START SAFETY OVERRIDE SWITCH

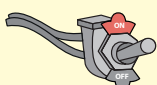







VALET SWITCH

Part #: RSPB available, Sold separately.

Notice: the installation of safety elements are mandatory. The hood pin and the valet switch are essential security elements and must be installed.

STAND ALONE CONFIGURATION

	Program bypass option	UNIT OPTION	DESCRIPTION
	OEM Remote Stand Alone Remote Starter:	D1.10 	By default, LOCK, LOCK, LOCK
		D1.1 	Par défaut, VERROUILLE, VERROUILLE, VERROUILLE
	Program bypass option with oem remote:	C1	OEM Remote Monitoring
	Program bypass option with RF KIT antenna:	H1 to H6	Supported RF Kits and select RF Kit
	Program bypass option Vehicle hybrid only:	D4	Hybrid mode (Vehicle hybrid only)

REMOTE STARTER FUNCTIONALITY



All doors must be closed.

3X 

Press the OEM remote's Lock button 3x to remote-start (or remote-stop) the vehicle.



START 

The vehicle will START.

REMOTE STARTER DIAGNOSTICS
MODULE RED LED

x2 flash :	Brake ON
x3 flash :	No tach
x4 flash :	Ignition before start
x5 flash :	Hood Open

REMOTE STARTER WARNING CARD



CUT THIS WARNING CARD AND STICK IT ON A VISIBLE PLACE:
 or use the package RSPB, Sold separately.

WARNING



REMOTE STARTER

THE VEHICLE CAN BE STARTED BY EITHER: PRESSING THE LOCK BUTTON ON THE OEM REMOTE 3 TIMES CONSECUTIVELY OR BY A SMARTPHONE. **TURN ON** THE SAFETY SWITCH LOCATED UNDER THE DASHBOARD BEFORE WORKING ON THE VEHICLE.

DESCRIPTION

	Parts required (Not included)	PAGE
--	-------------------------------	------

WIRE TO WIRE DIAGRAM

AUTOMATIC TRANSMISSION	1x 7.5 Amp. fuse	Page 3
------------------------	------------------	--------

THARNES DIAGRAM

THARNES THAR-FOR3 AUTOMATIC TRANSMISSION	1x THAR-FOR3	Page 4
--	--------------	--------

① Gateway module, located at dash board driver's side,

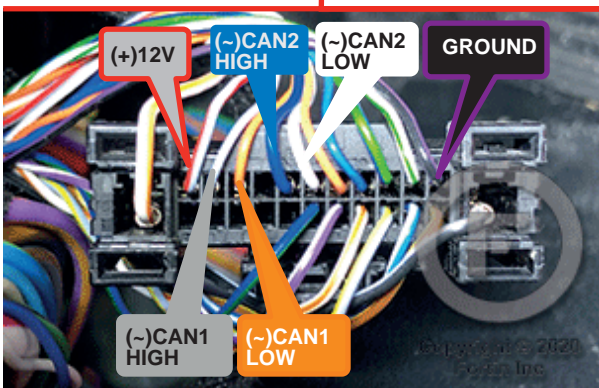

② Fuse box

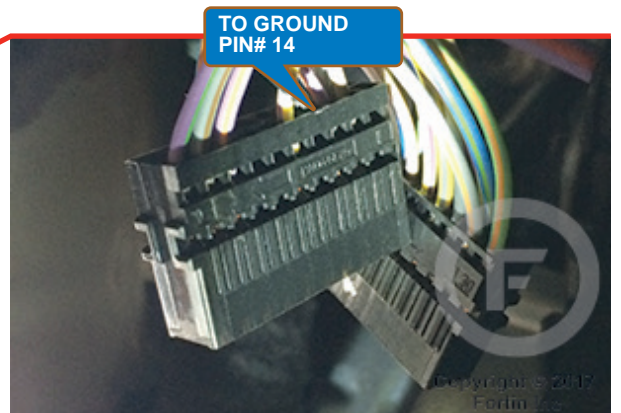
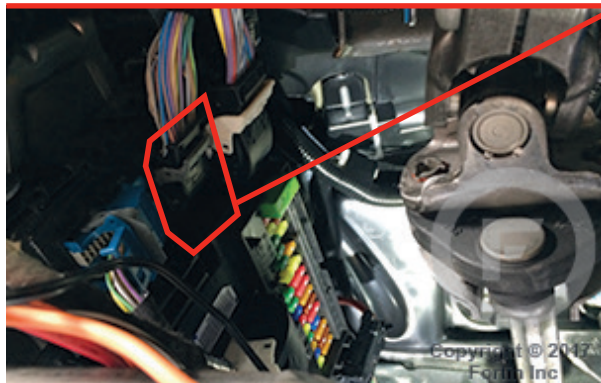

AUTOMATIC TRANSMISSION WIRING CONNECTION |

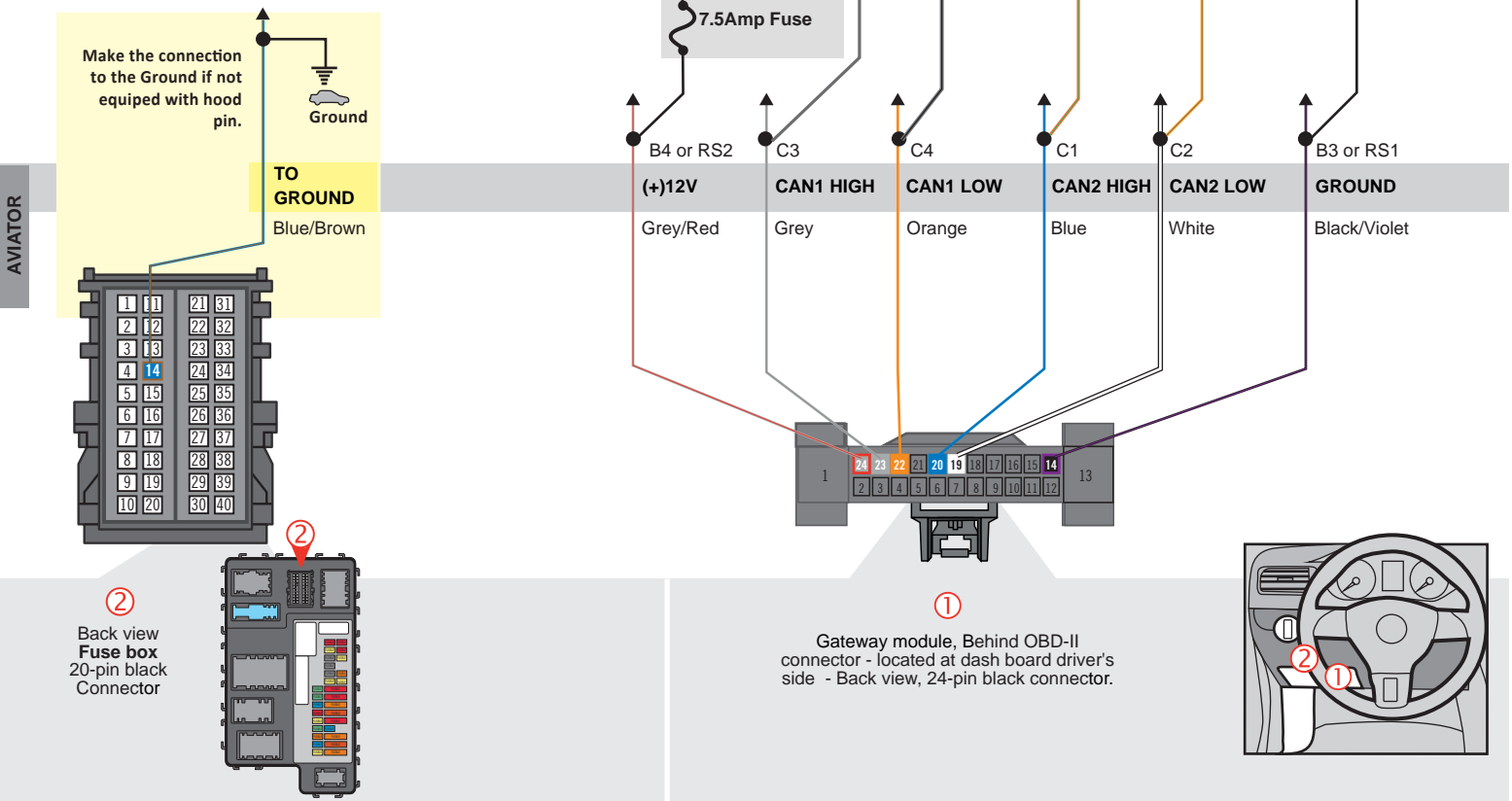
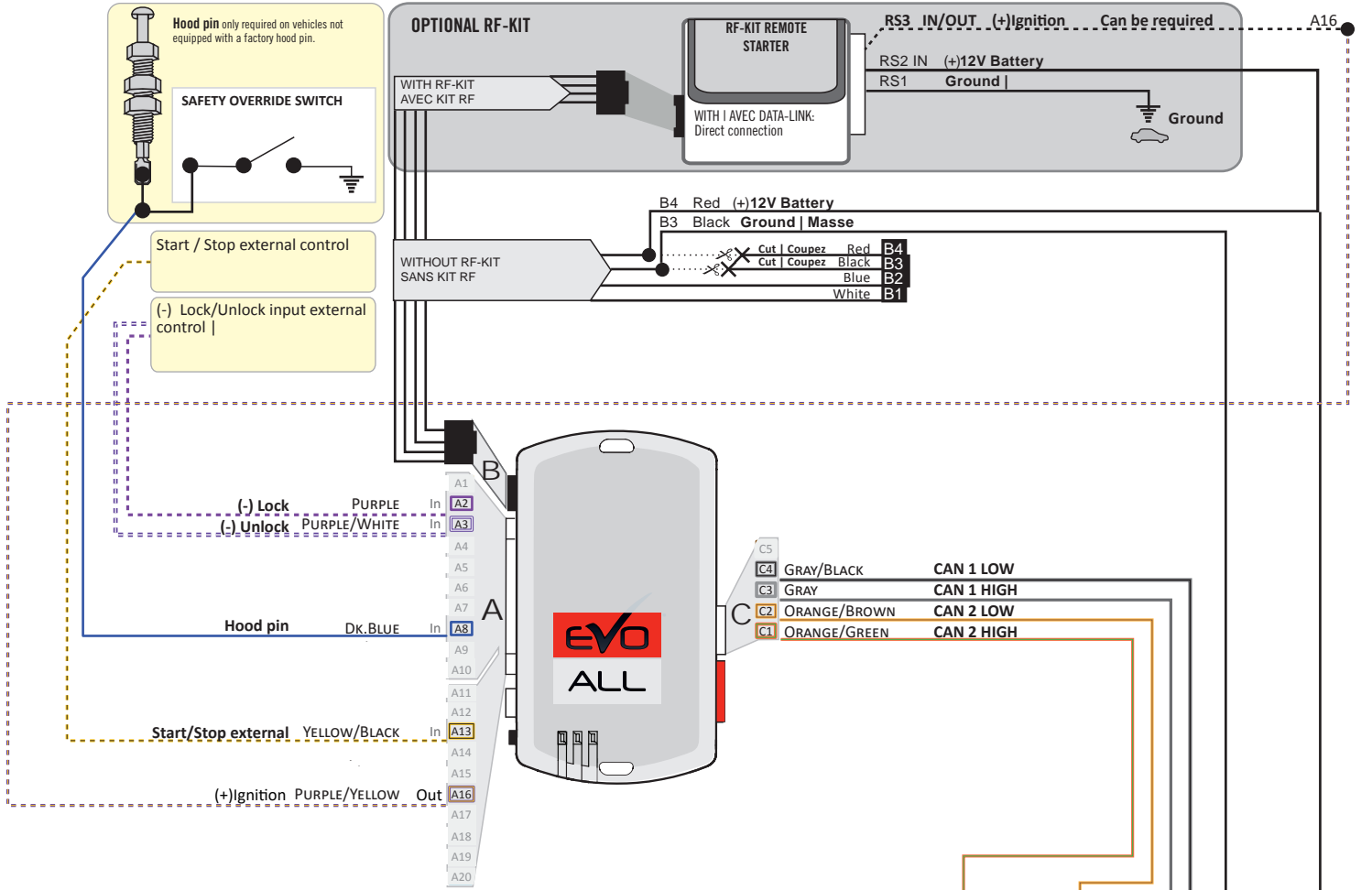

THAR-FOR3 | T-HARNESS - AUTOMATIC TRANSMISSION |

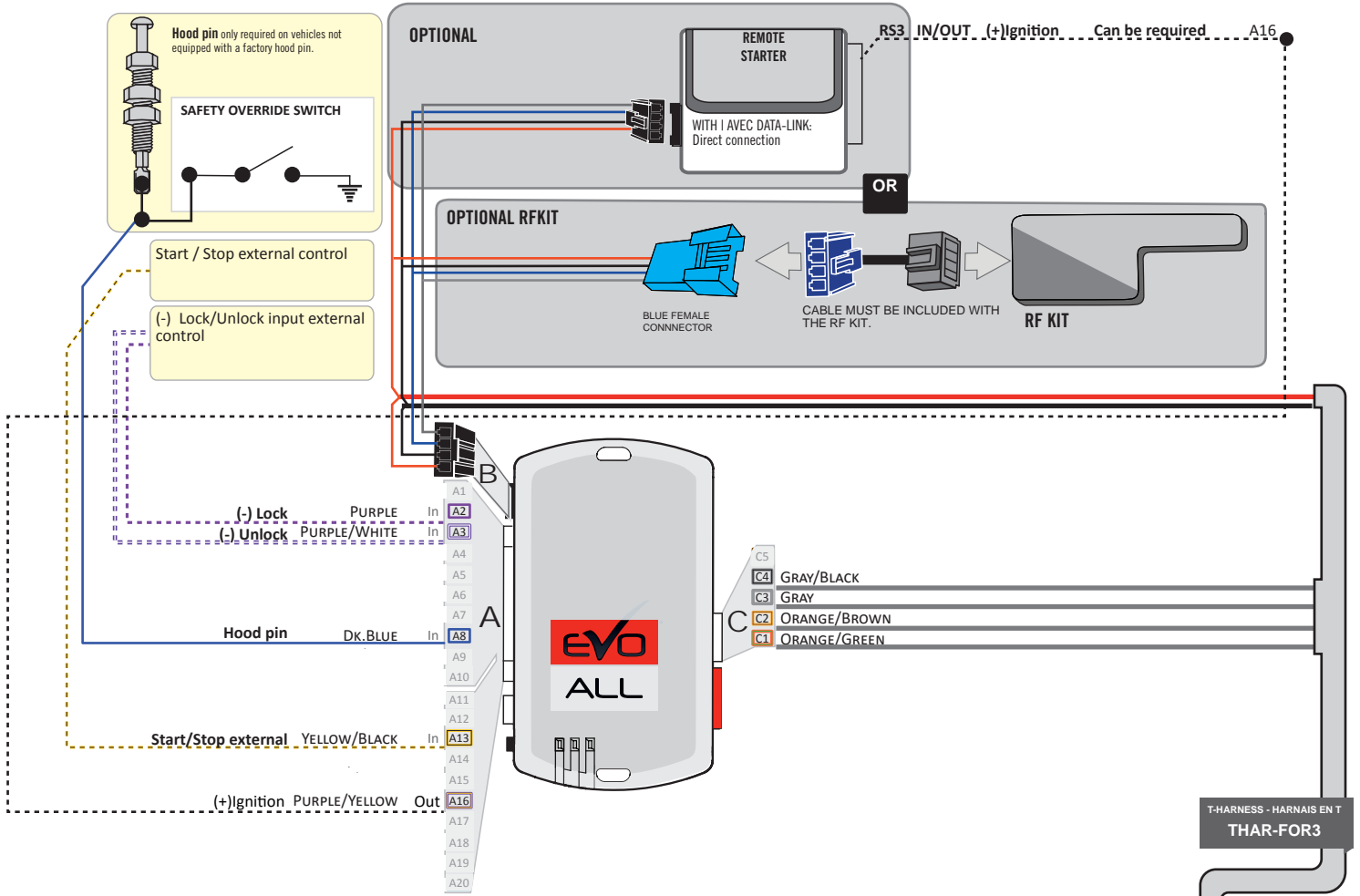

AVIATOR

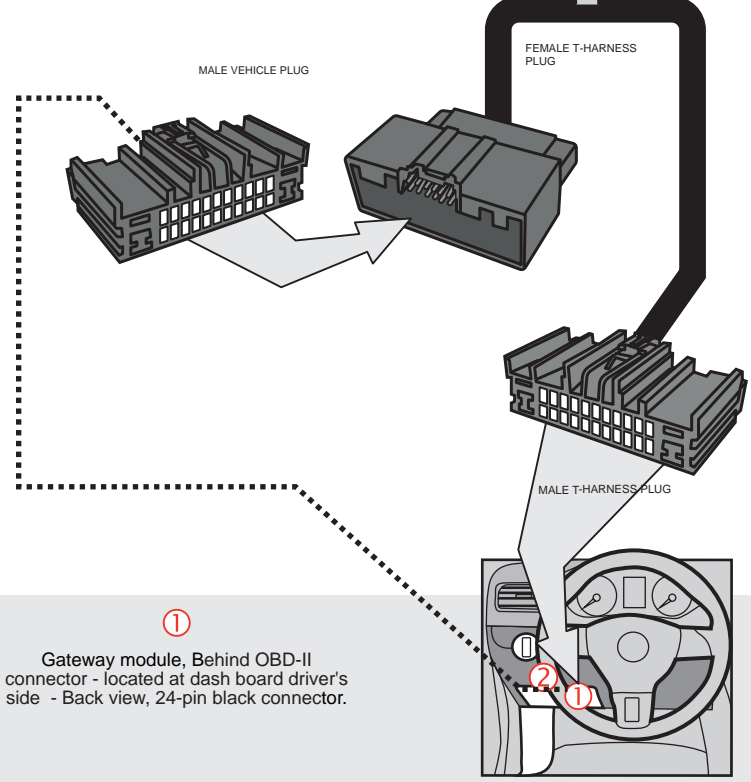
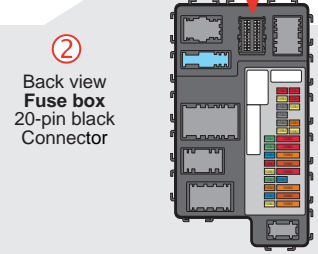
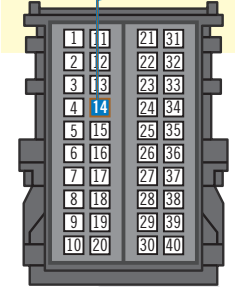
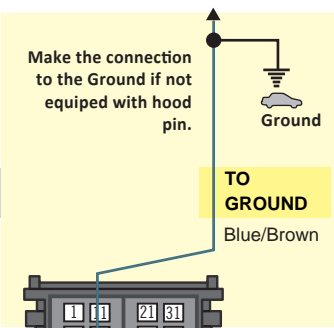

T-HARNESS - HARNAIS EN T
THAR-FOR3



Parts required (not included)

- 1x FLASH LINK UPDATER, SOFTWARE | PROGRAMME
- 1x FLASH LINK MANAGER
- 1x Microsoft Windows Computer with Internet connection

OR

- 1x FLASH LINK MOBILE
- 1x FLASH LINK MOBILE APP
- Smartphone Android or iOS with Internet connection (Internet provider charges may apply)

BEFORE PROGRAMMING SET THE UNIT OPTIONS AND SAVE.

1

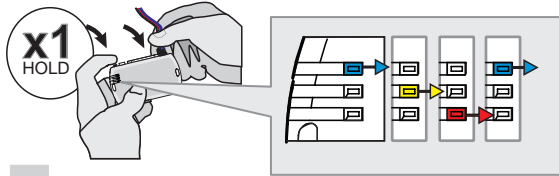

Press and hold the programming button:
Insert the 4-Pin (Data-Link) connector.

↳ The Blue, Red, Yellow and Blue & Red LEDs will alternatively illuminate.

2

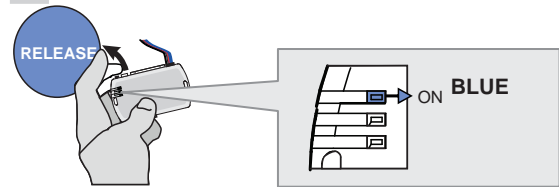

Release the programming button when the LED is BLUE.

If the LED is not solid BLUE disconnect the 4-Pin connector (Data-Link) and go back to step 1.

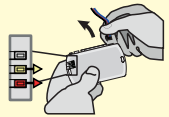

3

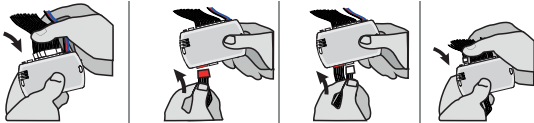

Insert the required remaining connectors.

4

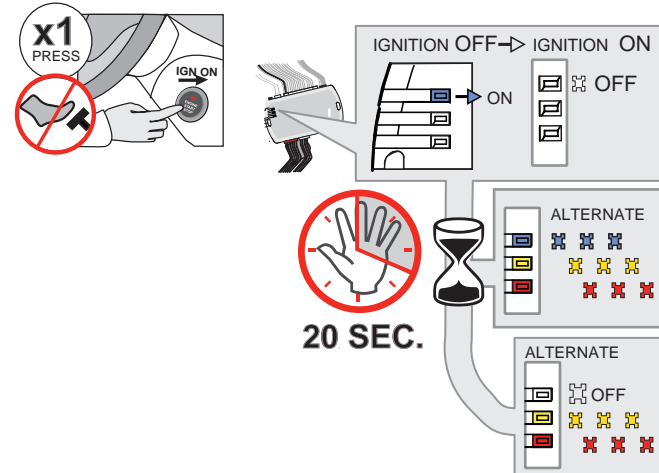

Do not press the brake pedal.
Press the Push-to-Start button once to turn on the ignition.

↳ The BLUE LED will turn OFF.

↳ The BLUE, YELLOW and RED LEDs will alternate.

Wait, at least 20 seconds, do not disconnect the modules or turn off the ignition.

↳ The RED and YELLOW LEDs will alternate.

Make sure that the DELs are flashing RED and YELLOW before continuing programming.



5

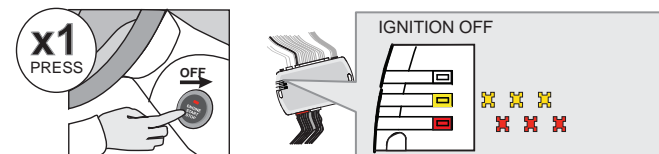

Press the Push-to-Start button once to turn off the ignition.

↳ The RED and YELLOW LEDs alternate.

KEY BYPASS PROGRAMMING PROCEDURE 2/2 |

6

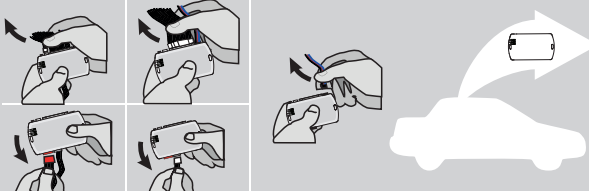

Disconnect all the connectors and after the Data-Link (4-pins) connector.

7



Microsoft Windows Computer with Internet connection*

FLASH LINK UPDATER* **FLASH LINK MANAGER***
SOFTWARE | PROGRAMME

OR

Smartphone* (Internet provider charges may apply)

VEHICLE'S OBDII CONNECTOR **FLASH LINK MOBILE***

Use the tool: FLASH LINK UPDATER or FLASH LINK MOBILE to visit the DCRYPTOR menu.

*Parts required (not included)

8

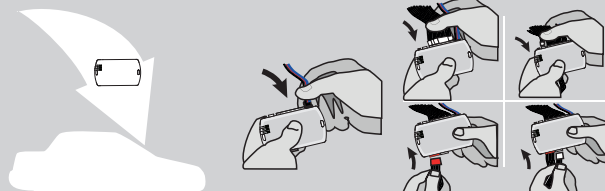

AFTER DCRYPTOR PROGRAMMING COMPLETED
Go back to the vehicle and reconnect the 4-Pin (Data-Link) connector and after, all the remaining connector.



↳ The BLUE LED will turn ON.

9

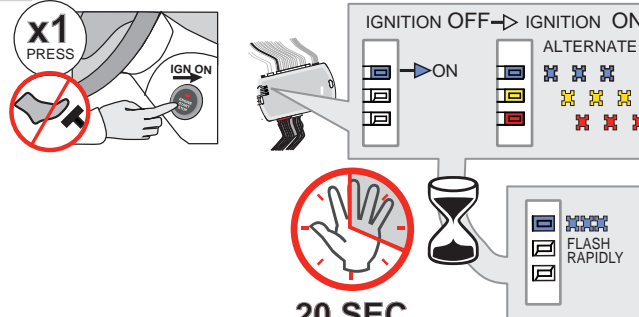

x1 PRESS (with a red 'X' over the push-to-start button)

IGNITION OFF → IGNITION ON

ALTERNATE

↳ The RED and YELLOW LEDs will turn ON.

Wait, at least 20 seconds, do not disconnect the modules or turn off the ignition.

↳ The BLUE LED will flash rapidly.

20 SEC.

FLASH RAPIDLY

10

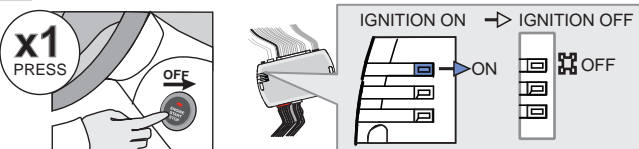

x1 PRESS (with a red 'X' over the push-to-start button)

IGNITION ON → IGNITION OFF

↳ The BLUE will turn OFF.



The module is now programmed.



OPTIONAL RF-KIT PROGRAMMING |

PROGRAM BYPASS OPTION





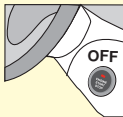

	<p>Program bypass option:</p>	<p>H2</p>	<p><input checked="" type="checkbox"/> Supported RF-KITS enable <input checked="" type="checkbox"/> H2 Fortin 2</p>
---	-------------------------------	------------------	---

OPTIONAL FORTIN RF KIT SERIES 4 OR SERIES 9 PROGRAMMING

The module must be programmed on the vehicle.





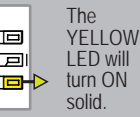
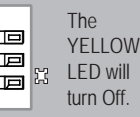
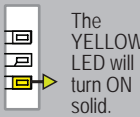
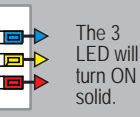
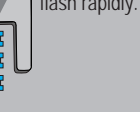
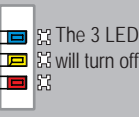
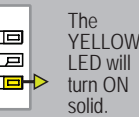
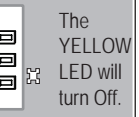



MAKE SURE THE IGNITION KEY HAS BEEN IN THE OFF POSITION FOR AT LEAST 5 SECONDS.

<p>1</p> <p>ON x1 PRESS</p>  <p>Do not press the brake pedal. Press the Push-to-Start button once to turn on the ignition.</p>	<p>2</p> <p>OFF x1 PRESS</p>  <p>Press the Push-to-Start button once to turn off the ignition.</p>	<p>3</p> <p>ON x1 PRESS</p>  <p>Do not press the brake pedal. Press the Push-to-Start button once to turn on the ignition.</p>	<p>4</p> <p>4X BRAKES</p> <p>x4 PRESS</p>  <p>Press and release the brake pedal four times.</p>	<p>5</p> <p>ON EACH TRANSMITTER</p> <p>4 BUTTONS</p> <p>[-] PRESS AND RELEASE</p> <p>→ PRESS AND RELEASE</p> <p>1 BUTTON</p> <p>PRESS APPROX. 12 SEC. AND WAIT FOR THE BLUE LED TO TURN OFF THEN BACK ON SOLID THEN RELEASE.</p>	<p>6</p> <p>OFF x1 PRESS</p>  <p>Press the Push-to-Start button once to turn off the ignition.</p>	<p>7</p> <p>ON x1 PRESS</p>  <p>Do not press the brake pedal. Press the Push-to-Start button once to turn on the ignition and leave it ON for 5 sec..</p>	<p>8</p> <p>OFF x1 PRESS</p>  <p>Press the Push-to-Start button once to turn off the ignition.</p>
 <p>The YELLOW LED will turn ON solid.</p>	 <p>The YELLOW LED will turn Off.</p>	 <p>The LED will turn ON solide.</p> <p>The YELLOW LED will turn ON solid.</p>	 <p>The LED will flash rapidly.</p> <p>The LED will turn off each time.</p> <p>The 3 LED will turn ON solid.</p>	 <p>The LED will flash rapidly.</p> <p>The LED will turn off each time.</p> <p>The 3 LED will turn off each time.</p>	 <p>The LED will turn Off.</p> <p>The 3 LED will turn off.</p>	 <p>The LED will turn Off.</p> <p>The YELLOW LED will turn ON solid.</p>	 <p>The LED will turn Off.</p> <p>The YELLOW LED will turn Off.</p>

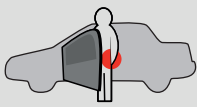

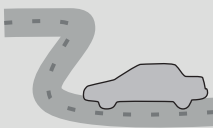
REMOTE STARTER FUNCTIONALITY |

 <p>Start</p> <p>All doors must be closed.</p> <p>Remote start the vehicle.</p>	 <p>UNLOCK</p> <p>Unlock the doors with either:</p> <ul style="list-style-type: none"> • The OEM remote • The remote-starter remote • Or the proximity remote 	 <p>Enter the vehicle with the SMART-KEY.</p>	 <p>DO NOT PRESS THE BRAKE PEDAL.</p> <p>Press and release the Push-to-Start button once.</p>	 <p>Press the brake pedal. The vehicle can now be put in to gear and driven.</p> <p>If the Smart-Key is not detected the vehicle will shut down.</p>
--	---	--	---	---

STANDALONE & THAR-FOR3 INSTALLATION

ADDENDUM - SUGGESTED WIRING CONFIGURATION



ONLY COMPATIBLE WITH AUTOMATIC TRANSMISSION VEHICLES.



Vehicle functions supported in this diagram (functional if equipped)

VEHICLE	YEARS	Immobilizer bypass	T-Harness available (sold separately)	Lock	Unlock	Arm	Disarm	Heated Seats**	Rear Defrost**	RAP Disable	Parking Lights***	Tachometer	Door Status	Trunk Status	Hood Status*	Hand-Brake Status	Foot-Brake Status	Active OEM Remote Start	
FORD																			
Edge	2020	•	•	•	•	•	•	•	•	•	•	•	•	•	•	•	•	•	•

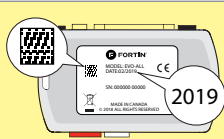

COMPATIBLE MODULE REQUIRED:

QR CODE ON THE LABEL
MANUFACTURED AFTER: 2019

FIRMWARE VERSION

58.[02]
MINIMUM

To add the firmware version and the options, use the **FLASH LINK UPDATER** or **FLASH LINK MOBILE** tool, sold separately.

UNIT OPTION	DESCRIPTION
C1	OEM Remote status (Lock/Unlock) monitoring
D6	Push-to-Start
A11	OFF Hood trigger (Output Status).

IF THE VEHICLE IS NOT EQUIPPED WITH FUNCTIONAL HOOD PIN:

NOTES

The vehicles OEM remote and SmartKey are still operable during remote start.

**Heated seats The heated seats and rear defrost activate automatically when it cold.

***Parking Lights The parking Lights at remote start only.

MANDATORY INSTALL

*HOOD PIN



HOOD STATUS: THE HOOD PIN SWITCH MUST BE INSTALLED IF THE VEHICLE CAN BE REMOTE STARTED WITH THE HOOD OPEN, SET FUNCTION A11 TO OFF.

A11

OFF

Notice: the installation of safety elements are mandatory. The hood pin is an essential security element and must be installed.

THIS MODULE MUST BE INSTALLED BY A QUALIFIED TECHNICIAN. A WRONG CONNECTION CAN CAUSE PERMANENT DAMAGE TO THE VEHICLE.

PARTS REQUIRED (NOT INCLUDED) |

1x **FLASH LINK UPDATER,**
 1x **FLASH LINK MANAGER**
SOFTWARE | PROGRAMME
 1x Microsoft Windows Computer with Internet connection

OR

1x **FLASH LINK MOBILE**
 1x **FLASH LINK MOBILE APP**
Smartphone Android or iOS with Internet connection (provider charges may apply).

MANDATORY

HOOD PIN

REMOTE START SAFETY OVERRIDE SWITCH

VALET SWITCH

Part #: RSPB available, Sold separately.

Notice: the installation of safety elements are mandatory. The hood pin and the valet switch are essential security elements and must be installed.

STAND ALONE CONFIGURATION |

	Program bypass option	UNIT OPTION	DESCRIPTION
	OEM Remote Stand Alone Remote Starter:	D1.10	By default, LOCK, LOCK, LOCK
		D1.1	Par défaut, VERROUILLE,VERROUILLE,VERROUILLE
	Program bypass option with oem remote:	C1	OEM Remote Monitoring
	Program bypass option with RF KIT antenna:	H1 to H6	Supported RF Kits and select RF Kit
	Program bypass option Vehicle hybrid only:	D4	Hybrid mode (Vehicle hybrid only)

REMOTE STARTER FUNCTIONALITY |

All doors must be closed.

3X

Press the OEM remote's Lock button 3x to remote-start (or remote-stop) the vehicle.

The vehicle will START.

REMOTE STARTER DIAGNOSTICS

MODULE RED LED
x2 flash : Brake ON
x3 flash : No tach
x4 flash : Ignition before start
x5 flash : Hood Open

REMOTE STARTER WARNING CARD |

CUT THIS WARNING CARD AND STICK IT ON A VISIBLE PLACE:
 or use the package RSPB, Sold separately.

WARNING | ATTENTION

REMOTE STARTER

THE VEHICLE CAN BE STARTED BY EITHER: PRESSING THE LOCK BUTTON ON THE OEM REMOTE 3 TIMES CONSECUTIVELY OR BY A SMARTPHONE. **TURN ON** THE SAFETY SWITCH LOCATED UNDER THE DASHBOARD BEFORE WORKING ON THE VEHICLE.

DESCRIPTION |

Parts required (Not included) **PAGE**

WIRE TO WIRE DIAGRAM

AUTOMATIC TRANSMISSION	1x 7.5 Amp. fuse	1x Fusible 7.5 Amp.	Page 3
------------------------	------------------	---------------------	--------

THARNESS DIAGRAM

THARNESS THAR-FOR3 AUTOMATIC TRANSMISSION	1x THAR-FOR3	1x THAR-FOR3	Page 4
---	--------------	--------------	--------



② Parking Lights switch

① Gateway module, located at right of steering column.

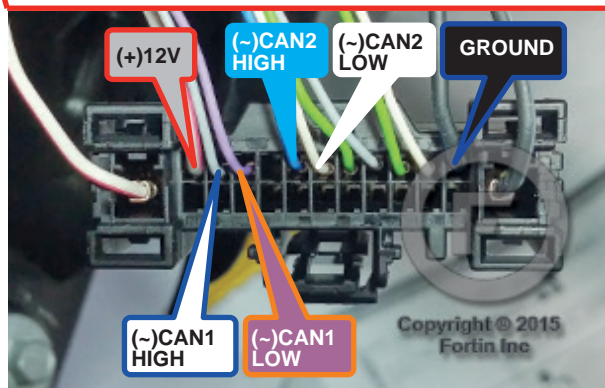
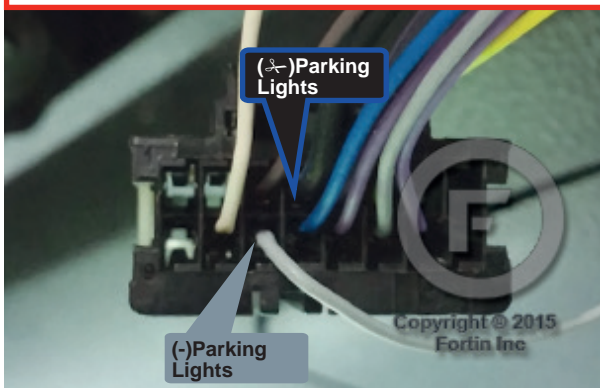

AUTOMATIC TRANSMISSION WIRING CONNECTION |

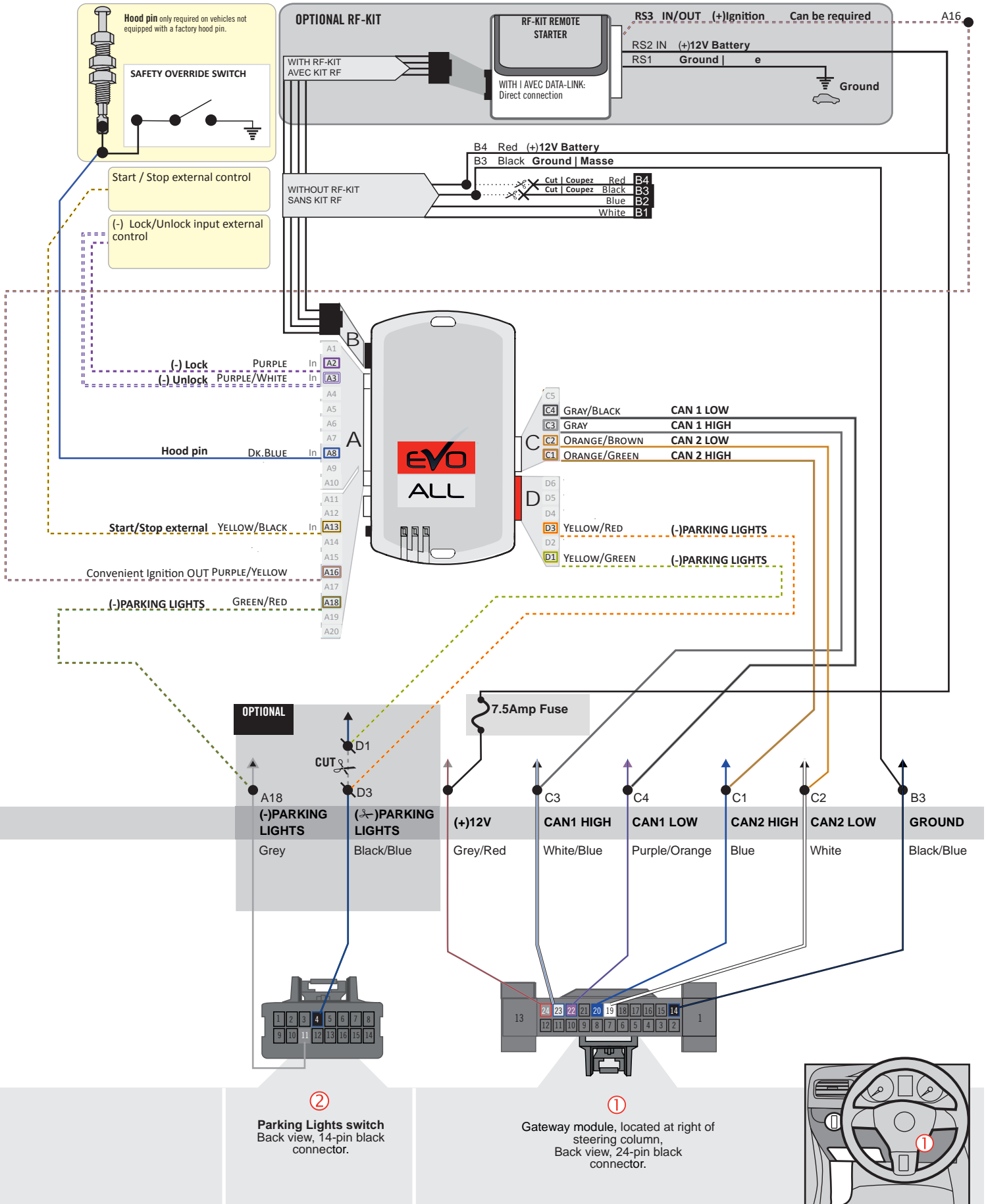

THAR-FOR3 | T-HARNESS - AUTOMATIC TRANSMISSION |

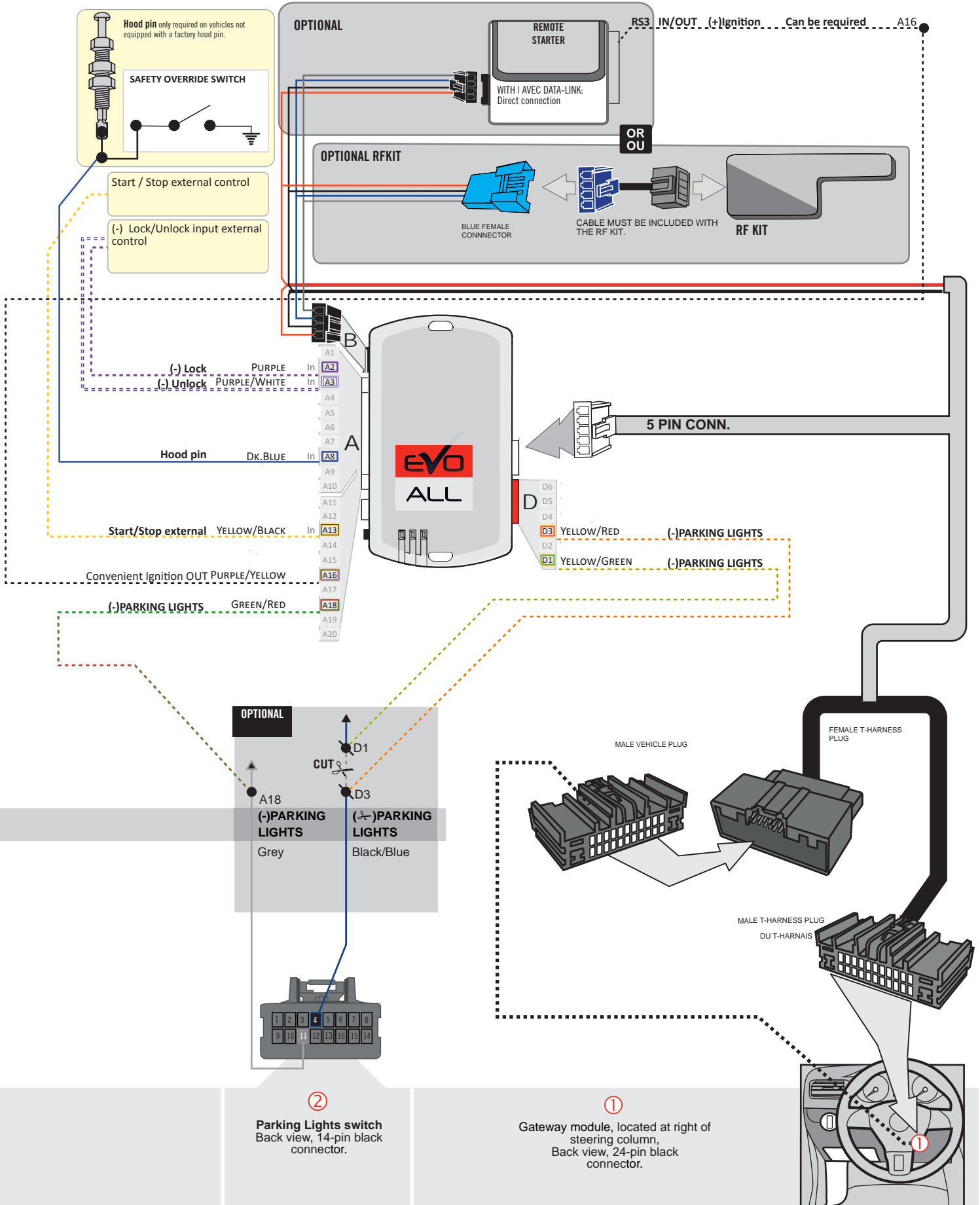



Parts required (not included)

- 1x FLASH LINK UPDATER, SOFTWARE | PROGRAMME
- 1x FLASH LINK MANAGER
- 1x Microsoft Windows Computer with Internet connection

OR

- 1x FLASH LINK MOBILE
- 1x FLASH LINK MOBILE APP
- Smartphone Android or iOS with Internet connection (Internet provider charges may apply)

BEFORE PROGRAMMING SET THE UNIT OPTIONS AND SAVE.

1

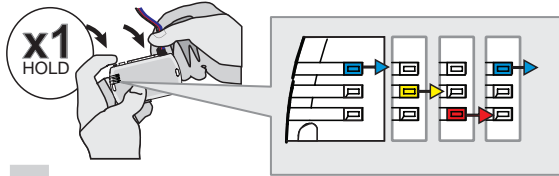

Press and hold the programming button:
Insert the 4-Pin (Data-Link) connector.

↳ The Blue, Red, Yellow and Blue & Red LEDs will alternatively illuminate.

2

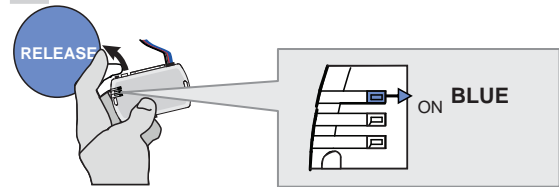

Release the programming button when the LED is BLUE.

If the LED is not solid BLUE disconnect the 4-Pin connector (Data-Link) and go back to step 1.

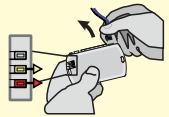

3

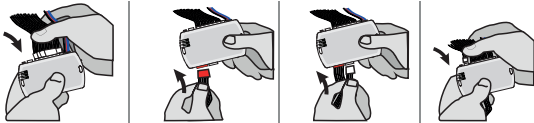

Insert the required remaining connectors.

4

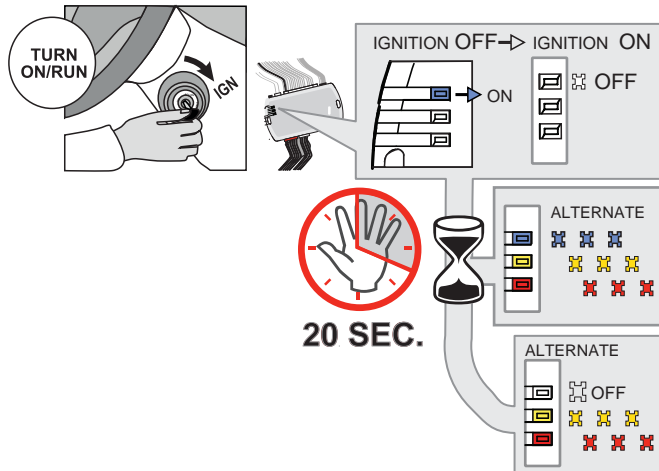

Turn the key to the Ignition ON/RUN position.

↳ The BLUE LED will turn OFF.

↳ The BLUE, YELLOW and RED LEDs will alternate.

Wait, at least 20 seconds, do not disconnect the modules or turn off the ignition.

↳ The RED and YELLOW LEDs will alternate.

Make sure that the DELs are flashing RED and YELLOW before continuing programming.

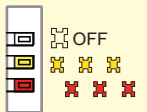

5

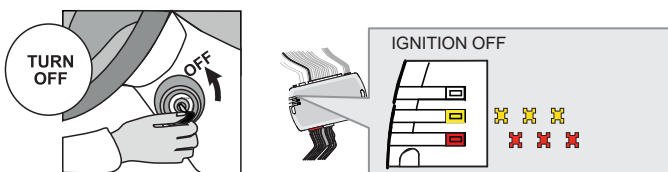

Turn the key to the OFF position.

↳ The RED and YELLOW LEDs alternate.

KEY BYPASS PROGRAMMING PROCEDURE 2/2 |

6

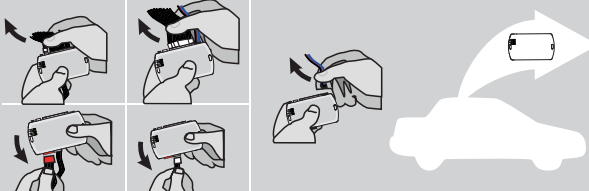

Disconnect all the connectors and after the Data-Link (4-pins) connector.

7



Microsoft Windows Computer with Internet connection*

FLASH LINK UPDATER* **FLASH LINK MANAGER***
SOFTWARE | PROGRAMME

OR

Smartphone* (Internet provider charges may apply)

VEHICLE'S OBDII CONNECTOR **FLASH LINK MOBILE***

Use the tool: FLASH LINK UPDATER or FLASH LINK MOBILE to visit the DCryptor menu.

*Parts required (not included)

8

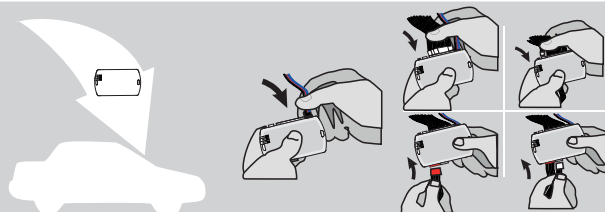

AFTER DCRYPTOR PROGRAMMING COMPLETED
Go back to the vehicle and reconnect the 4-Pin (Data-Link) connector and after, all the remaining connector.



↳ The BLUE LED will turn ON.

9

TURN ON/RUN

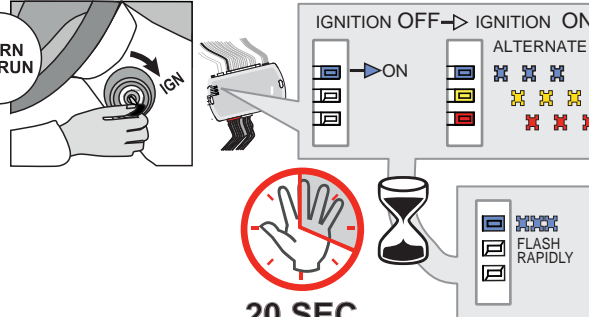

IGNITION OFF → IGNITION ON

ALTERNATE

↳ The RED and YELLOW LEDs will turn ON.

Wait, at least 20 seconds, do not disconnect the modules or turn off the ignition.

↳ The BLUE LED will flash rapidly.

20 SEC.

FLASH RAPIDLY

10

TURN OFF

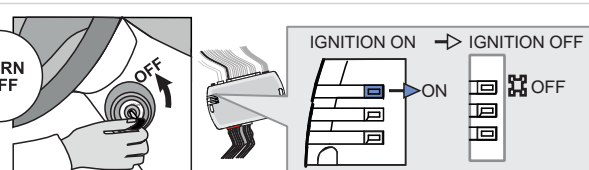

IGNITION ON → IGNITION OFF

↳ The BLUE will turn OFF.





The module is now programmed.









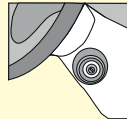



OPTIONAL RF-KIT PROGRAMMING |

PROGRAM BYPASS OPTION

	<p>Program bypass option:</p>	<p>H2</p>	<p><input checked="" type="checkbox"/> Supported RF-KITS enable <input checked="" type="checkbox"/> H2 Fortin 2</p>
---	-------------------------------	------------------	---

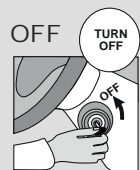
OPTIONAL FORTIN RF KIT SERIES 4 OR SERIES 9 PROGRAMMING

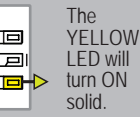
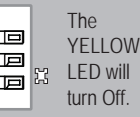
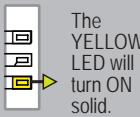
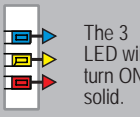
	<p>The module must be programmed on the vehicle.</p>			<p>MAKE SURE THE IGNITION KEY HAS BEEN IN THE OFF POSITION FOR AT LEAST 5 SECONDS.</p>
---	--	---	---	---

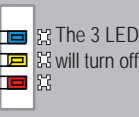
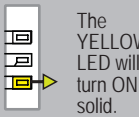
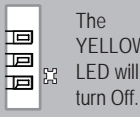
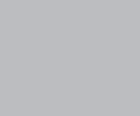
<p>1</p>  <p>ON TURN ON/RUN</p>	<p>2</p>  <p>OFF TURN OFF</p>	<p>3</p>  <p>ON TURN ON/RUN</p>	<p>4</p> <p>4X BRAKES</p>  <p>x4 PRESS</p>	<p>5</p> <p>ON EACH TRANSMITTER</p> <p>4 BUTTONS</p>  <p>PRESS AND RELEASE</p>  <p>PRESS AND RELEASE</p> <p>1 BUTTON</p>  <p>PRESS APPROX. 12 SEC. AND WAIT FOR THE BLUE LED TO TURN OFF THEN BACK ON SOLID THEN RELEASE.</p>	<p>6</p>  <p>OFF TURN OFF</p>	<p>7</p>  <p>ON TURN ON/RUN</p>	<p>8</p>  <p>OFF TURN OFF</p>
<p>Turn the key to the ON/RUN position.</p>	<p>Turn the ignition to the OFF position.</p>	<p>Turn the key to the ON/RUN position.</p>	<p>Press and release the brake pedal four times.</p>	<p>The LED will turn off each time.</p>	<p>Turn the ignition to the OFF position.</p>	<p>Turn the key to the ON/RUN position and leave it ON for 5 sec.</p> 	<p>Turn the ignition to the OFF position.</p>
 <p>The YELLOW LED will turn ON solid.</p>	 <p>The YELLOW LED will turn Off.</p>	 <p>The YELLOW LED will turn ON solid.</p>	 <p>The 3 LED will turn ON solid.</p>	 <p>The LED will flash rapidly.</p>	 <p>The 3 LED will turn off.</p>	 <p>The YELLOW LED will turn ON solid.</p>	 <p>The YELLOW LED will turn Off.</p>
 <p>The 3 LED will turn off each time.</p>							



REMOTE STARTER FUNCTIONALITY |



All doors must be closed.



Remote start the vehicle.



Unlock the doors with the remote-starter remote or the OEM remote.



Insert and Turn the key to the Ignition ON/RUN position.



Press the brake pedal.



The vehicle can now be put in to gear and driven.

STANDALONE & THAR-FOR3 INSTALLATION

ADDENDUM - SUGGESTED WIRING CONFIGURATION



ONLY COMPATIBLE WITH AUTOMATIC TRANSMISSION VEHICLES.



Vehicle functions supported in this diagram (functional if equipped)

VEHICLE	YEARS	Immobilizer bypass	T-Harness available (sold separately)	Lock	Unlock	Arm	Disarm	Heated Seats**	Rear Defrost**	RAP Disable	Parking Lights***	Tachometer	Door Status	Trunk Status	Hood Status*	Hand-Brake Status	Foot-Brake Status	Active OEM Remote Start	
FORD																			
Edge	Push-to-Start 2020	•	•	•	•	•	•	•	•	•	•	•	•	•	•	•	•	•	•

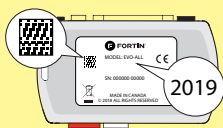

COMPATIBLE MODULE REQUIRED:

QR CODE ON THE LABEL
MANUFACTURED AFTER: 2019

FIRMWARE VERSION

58.[02]
MINIMUM

To add the firmware version and the options, use the FLASH LINK UPDATER or FLASH LINK MOBILE tool, sold separately.



Program bypass option:

UNIT OPTION

DESCRIPTION

C1

OEM Remote status (Lock/Unlock) monitoring

D6

Push-to-Start

IF THE VEHICLE IS NOT EQUIPPED WITH FUNCTIONAL HOOD PIN:

A11

OFF

Hood trigger (Output Status).

NOTES

The vehicles OEM remote and SmartKey are still operable during remote start.

**Heated seats The heated seats and rear defrost activate automatically when it cold.
**Rear Defrost

***Parking Lights The parking Lights at remote start only.

MANDATORY INSTALL

*HOOD PIN



DE CAPOT

HOOD STATUS: THE HOOD PIN SWITCH MUST BE INSTALLED IF THE VEHICLE CAN BE REMOTE STARTED WITH THE HOOD OPEN, SET FUNCTION A11 TO OFF.

A11

OFF

Notice: the installation of safety elements are mandatory. The hood pin is an essential security element and must be installed.

THIS MODULE MUST BE INSTALLED BY A QUALIFIED TECHNICIAN. A WRONG CONNECTION CAN CAUSE PERMANENT DAMAGE TO THE VEHICLE.

PARTS REQUIRED (NOT INCLUDED) |

1x **FLASH LINK UPDATER,**
 1x **FLASH LINK MANAGER**
SOFTWARE | PROGRAMME
 1x Microsoft Windows Computer with Internet connection

OR

1x **FLASH LINK MOBILE**
 1x **FLASH LINK MOBILE APP**
Smartphone Android or iOS with Internet connection (provider charges may apply).

MANDATORY

HOOD PIN



REMOTE START SAFETY OVERRIDE SWITCH

COMMUNTEUR DE SÉCURITÉ DE

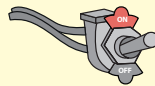

VALET SWITCH

Part #: RSPB available, Sold separately.

Notice: the installation of safety elements are mandatory. The hood pin and the valet switch are essential security elements and must be installed.

STAND ALONE CONFIGURATION |

	Program bypass option	UNIT OPTION	DESCRIPTION
	OEM Remote Stand Alone Remote Starter:	D1.10	By default, LOCK, LOCK, LOCK
		D1.1	Par défaut, VERROUILLE, VERROUILLE, VERROUILLE
	Program bypass option with oem remote:	C1	OEM Remote Monitoring
	Program bypass option with RF KIT antenna:	H1 to H6	Supported RF Kits and select RF Kit
	Program bypass option Vehicle hybrid only:	D4	Hybrid mode (Vehicle hybrid only)

REMOTE STARTER FUNCTIONALITY |

All doors must be closed.

3X

Press the OEM remote's Lock button 3x to remote-start (or remote-stop) the vehicle.

The vehicle will START.

REMOTE STARTER DIAGNOSTICS

MODULE RED LED
x2 flash : Brake ON
x3 flash : No tach
x4 flash : Ignition before start
x5 flash : Hood Open

REMOTE STARTER WARNING CARD |



CUT THIS WARNING CARD AND STICK IT ON A VISIBLE PLACE:
 or use the package RSPB, Sold separately.

WARNING

REMOTE STARTER

THE VEHICLE CAN BE STARTED BY EITHER: PRESSING THE LOCK BUTTON ON THE OEM REMOTE 3 TIMES CONSECUTIVELY OR BY A SMARTPHONE. **TURN ON** THE SAFETY SWITCH LOCATED UNDER THE DASHBOARD BEFORE WORKING ON THE VEHICLE.

DESCRIPTION |

Parts required (Not included) **PAGE**

WIRE TO WIRE DIAGRAM

AUTOMATIC TRANSMISSION	1x 7.5 Amp. fuse	1x Fusible 7.5 Amp.	Page 3
------------------------	------------------	---------------------	--------

THARNESSE DIAGRAM

THARNESSE THAR-FOR3 AUTOMATIC TRANSMISSION	1x THAR-FOR3	1x THAR-FOR3	Page 4
--	--------------	--------------	--------



② Parking Lights switch

① Gateway module, located at right of steering column.

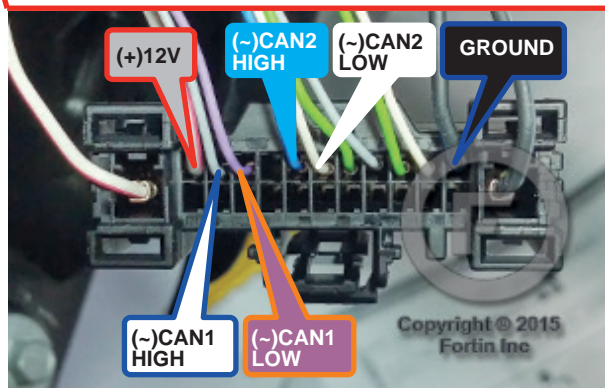
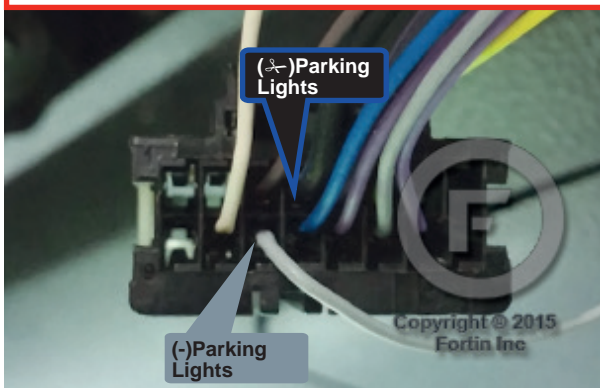

AUTOMATIC TRANSMISSION WIRING CONNECTION |

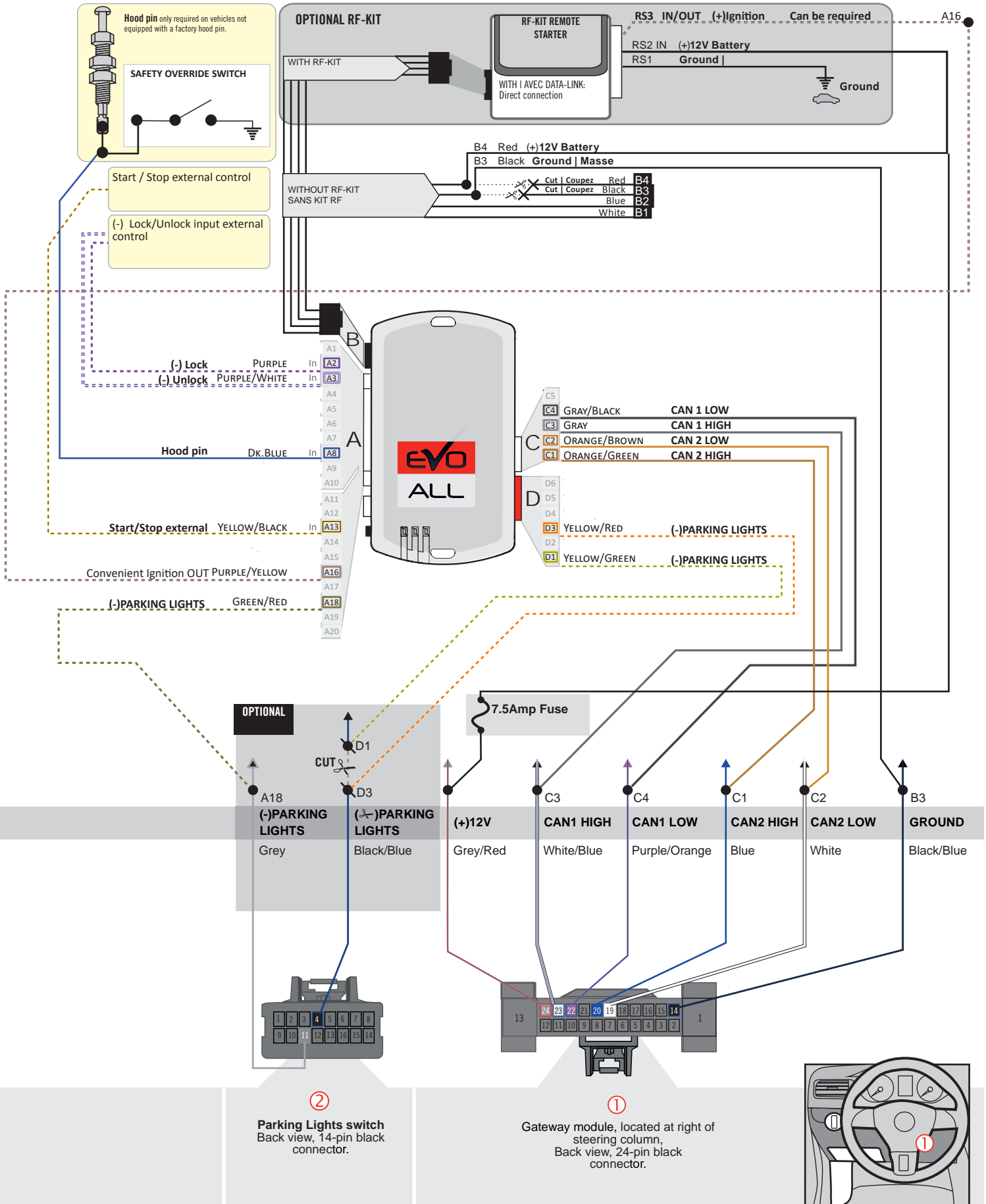

THAR-FOR3 | T-HARNESS - AUTOMATIC TRANSMISSION |

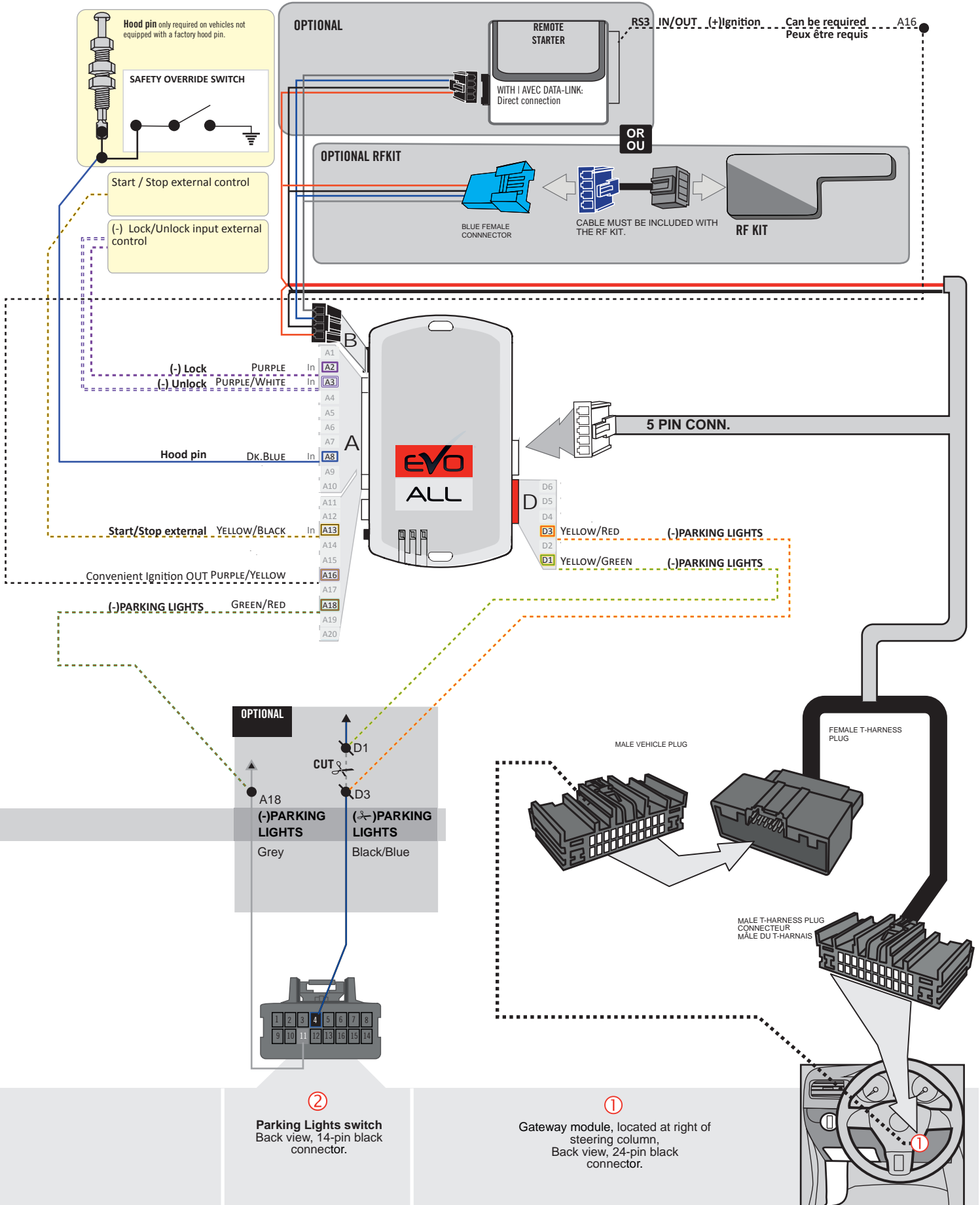



Parts required (not included)

- 1x FLASH LINK UPDATER, SOFTWARE | PROGRAMME
- 1x FLASH LINK MANAGER
- 1x Microsoft Windows Computer with Internet connection

OR

- 1x FLASH LINK MOBILE
- 1x FLASH LINK MOBILE APP
- Smartphone Android or iOS with Internet connection (Internet provider charges may apply)

BEFORE PROGRAMMING SET THE UNIT OPTIONS AND SAVE.

1

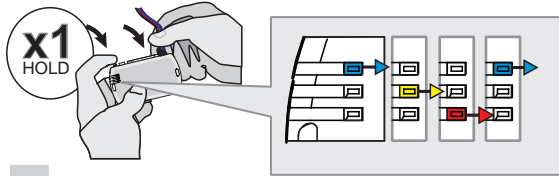

Press and hold the programming button:
Insert the 4-Pin (Data-Link) connector.

↳ The Blue, Red, Yellow and Blue & Red LEDs will alternatively illuminate.

2

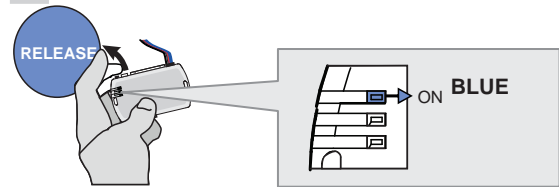

Release the programming button when the LED is BLUE.

If the LED is not solid BLUE disconnect the 4-Pin connector (Data-Link) and go back to step 1.

3

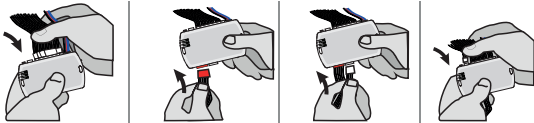

Insert the required remaining connectors.

4

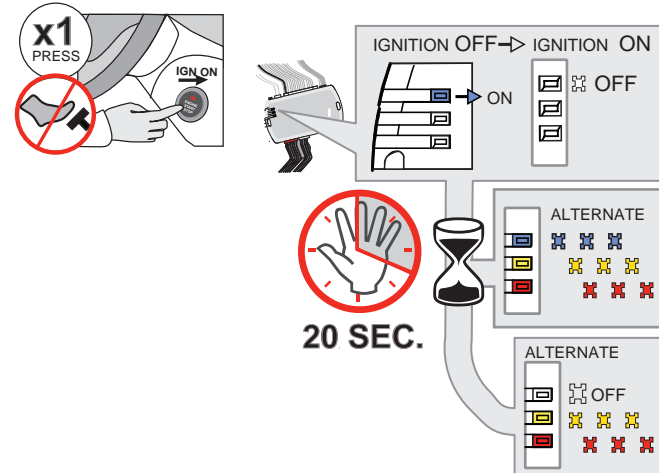

Do not press the brake pedal.
Press the Push-to-Start button once to turn on the ignition.

↳ The BLUE LED will turn OFF.

↳ The BLUE, YELLOW and RED LEDs will alternate.

Wait, at least 20 seconds, do not disconnect the modules or turn off the ignition.

↳ The RED and YELLOW LEDs will alternate.

Make sure that the DELs are flashing RED and YELLOW before continuing programming.

5

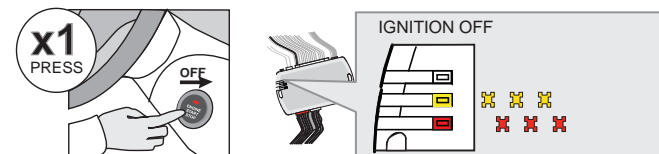

Press the Push-to-Start button once to turn off the ignition.

↳ The RED and YELLOW LEDs alternate.

KEY BYPASS PROGRAMMING PROCEDURE 2/2 |

6

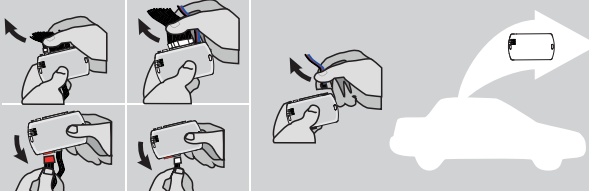

Disconnect all the connectors and after the Data-Link (4-pins) connector.

7



Microsoft Windows Computer with Internet connection*

FLASH LINK UPDATER* **FLASH LINK MANAGER***
SOFTWARE | PROGRAMME

OR

Smartphone* (Internet provider charges may apply)

VEHICLE'S OBDII CONNECTOR **FLASH LINK MOBILE***

Use the tool: FLASH LINK UPDATER or FLASH LINK MOBILE to visit the DCryptor menu.

*Parts required (not included)

8

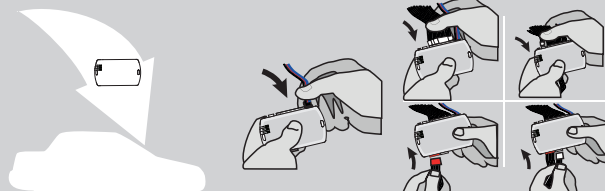

AFTER DCRYPTOR PROGRAMMING COMPLETED
Go back to the vehicle and reconnect the 4-Pin (Data-Link) connector and after, all the remaining connector.

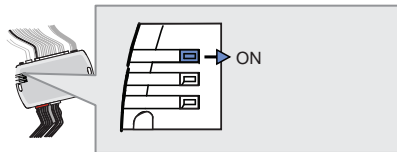

↳ The BLUE LED will turn ON.

9

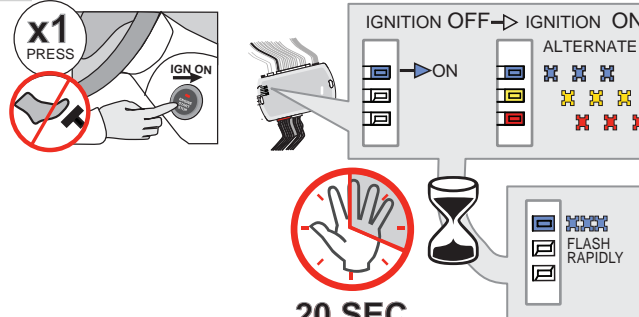

x1 PRESS (with a red 'X' over the push-to-start button)

IGNITION OFF → IGNITION ON

ALTERNATE

↳ The RED and YELLOW LEDs will turn ON.

20 SEC. (with a hand icon and an hourglass)

FLASH RAPIDLY

Wait, at least 20 seconds, do not disconnect the modules or turn off the ignition.

↳ The BLUE LED will flash rapidly.

10

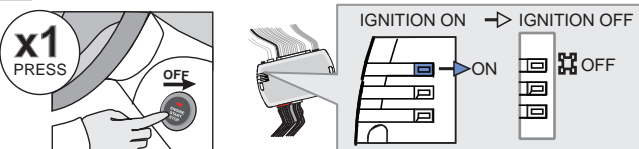

x1 PRESS (with a red 'X' over the push-to-start button)

IGNITION ON → IGNITION OFF

OFF

Press the Push-to-Start button once to turn off the ignition.

↳ The BLUE will turn OFF.



The module is now programmed.

OPTIONAL RF-KIT PROGRAMMING |

PROGRAM BYPASS OPTION



Program bypass option:

H2

Supported RF-KITS enable

H2 Fortin 2

OPTIONAL FORTIN RF KIT SERIES 4 OR SERIES 9 PROGRAMMING



The module must be programmed on the vehicle.







MAKE SURE THE IGNITION KEY HAS BEEN IN THE OFF POSITION FOR AT LEAST 5 SECONDS.

<p>1</p> <p>ON x1 PRESS</p> <p>Do not press the brake pedal. Press the Push-to-Start button once to turn on the ignition.</p>	<p>2</p> <p>OFF x1 PRESS</p> <p>Press the Push-to-Start button once to turn off the ignition.</p>	<p>3</p> <p>ON x1 PRESS</p> <p>Do not press the brake pedal. Press the Push-to-Start button once to turn on the ignition.</p>	<p>4</p> <p>4X BRAKES</p> <p>x4 PRESS</p> <p>Press and release the brake pedal four times.</p>	<p>5</p> <p>ON EACH TRANSMITTER</p> <p>4 BUTTONS</p> <p>[-] PRESS AND RELEASE</p> <p>→ PRESS AND RELEASE</p> <p>1 BUTTON 1 BOUTON</p> <p>PRESS APPROX. 12 SEC. AND WAIT FOR THE BLUE LED TO TURN OFF THEN BACK ON SOLID THEN RELEASE.</p>	<p>6</p> <p>OFF x1 PRESS</p> <p>Press the Push-to-Start button once to turn off the ignition.</p>	<p>7</p> <p>ON x1 PRESS</p> <p>Do not press the brake pedal. Press the Push-to-Start button once to turn on the ignition and leave it ON for 5 sec..</p>	<p>8</p> <p>OFF x1 PRESS</p> <p>Press the Push-to-Start button once to turn off the ignition.</p>
<p>The YELLOW LED will turn ON solid.</p>	<p>The YELLOW LED will turn Off.</p>	<p>The LED will turn ON solide.</p>	<p>The LED will flash rapidly.</p>	<p>The LED will turn off each time.</p>	<p>The LED will turn Off.</p>	<p>The LED will turn Off.</p>	<p>The LED will turn Off.</p>
<p>The YELLOW LED will turn ON solid.</p>	<p>The YELLOW LED will turn Off.</p>	<p>The YELLOW LED will turn ON solid.</p>	<p>The 3 LED will turn ON solid.</p>	<p>The LED will flash rapidly. Le témoin clignotera rapidement.</p>	<p>The 3 LED will turn off.</p>	<p>The YELLOW LED will turn ON solid.</p>	<p>The YELLOW LED will turn Off.</p>

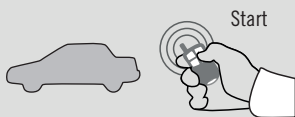

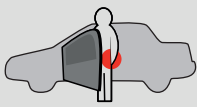
REMOTE STARTER FUNCTIONALITY |

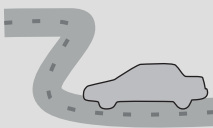
 <p>Start</p> <p>All doors must be closed.</p> <p>Remote start the vehicle.</p>	 <p>UNLOCK</p> <p>Unlock the doors with either:</p> <ul style="list-style-type: none"> • The OEM remote • The remote-starter remote • Or the proximity remote 	 <p>Enter the vehicle with the SMART-KEY.</p>	 <p>DO NOT PRESS THE BRAKE PEDAL.</p> <p>Press and release the Push-to-Start button once.</p>	 <p>Press the brake pedal. The vehicle can now be put in to gear and driven.</p> <p>If the Smart-Key is not detected the vehicle will shut down.</p>
--	---	--	---	---

STANDALONE & THAR-FOR3 INSTALLATION

ADDENDUM - SUGGESTED WIRING CONFIGURATION



ONLY COMPATIBLE WITH AUTOMATIC TRANSMISSION VEHICLES.

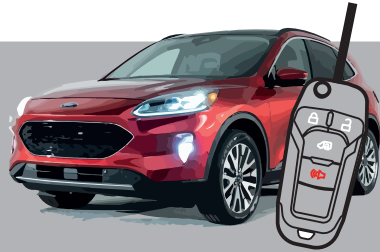

Vehicle functions supported in this diagram (functional if equipped)

VEHICLE	YEARS	Immobilizer bypass	Lock	Unlock	Arm	Disarm	Heated Seats**	Rear Defrost**	RAP Disable	Parking Lights***	Tachometer	Door Status	Trunk Status	Hood Status*	Hand-Brake Status	Foot-Brake Status	Active OEM Remote Start
FORD Escape	Key 2020	•	•	•	•	•	•	•	•	•	•	•	•	•	•	•	•

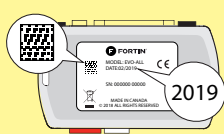

COMPATIBLE MODULE REQUIRED:

QR CODE ON THE LABEL
MANUFACTURED AFTER: 2019

FIRMWARE VERSION
58.[02]
MINIMUM

To add the firmware version and the options, use the **FLASH LINK UPDATER** or **FLASH LINK MOBILE** tool, sold separately.



Program bypass option:

UNIT OPTION

C1

DESCRIPTION

OEM Remote status (Lock/Unlock) monitoring

IF THE VEHICLE IS NOT EQUIPPED WITH FUNCTIONAL HOOD PIN:

A11

OFF

Hood trigger (Output Status).

NOTES

The vehicles OEM remote and SmartKey are still operable during remote start.

**Heated seats The heated seats and rear defrost activate automatically when it cold.

***Parking Lights The parking Lights at remote start only.



The vehicle must be equipped with the OEM remote with the door locks.

MANDATORY INSTALL

*HOOD PIN



HOOD STATUS: THE HOOD PIN SWITCH MUST BE INSTALLED IF THE VEHICLE CAN BE REMOTE STARTED WITH THE HOOD OPEN, SET FUNCTION A11 TO OFF.

A11

OFF

Notice: the installation of safety elements are mandatory. The hood pin is an essential security element and must be installed.

THIS MODULE MUST BE INSTALLED BY A QUALIFIED TECHNICIAN. A WRONG CONNECTION CAN CAUSE PERMANENT DAMAGE TO THE VEHICLE.

PARTS REQUIRED (NOT INCLUDED) |

1x **FLASH LINK UPDATER,**
1x **FLASH LINK MANAGER**
SOFTWARE | PROGRAMME
1x Microsoft Windows Computer with Internet connection

OR

1x **FLASH LINK MOBILE**
1x **FLASH LINK MOBILE APP**
Smartphone Android or iOS with Internet connection (provider charges may apply).

MANDATORY

HOOD PIN



REMOTE START SAFETY OVERRIDE SWITCH

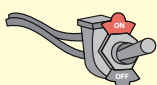







VALET SWITCH

Part #: RSPB available, Sold separately.

Notice: the installation of safety elements are mandatory. The hood pin and the valet switch are essential security elements and must be installed.

STAND ALONE CONFIGURATION |

	Program bypass option	UNIT OPTION	DESCRIPTION
	OEM Remote Stand Alone Remote Starter:	D1.10 	By default, LOCK, LOCK, LOCK
		D1.1 	Par défaut, VERROUILLE, VERROUILLE, VERROUILLE
	Program bypass option with oem remote:	C1	OEM Remote Monitoring
	Program bypass option with RF KIT antenna:	H1 to H6	Supported RF Kits and select RF Kit
	Program bypass option Vehicle hybrid only:	D4	Hybrid mode (Vehicle hybrid only)

REMOTE STARTER FUNCTIONALITY |



All doors must be closed.

3X 

Press the OEM remote's Lock button 3x to remote-start (or remote-stop) the vehicle.



START 

The vehicle will START.

REMOTE STARTER DIAGNOSTICS

MODULE RED LED

x2 flash : Brake ON

x3 flash : No tach

x4 flash : Ignition before start

x5 flash : Hood Open

REMOTE STARTER WARNING CARD |



CUT THIS WARNING CARD AND STICK IT ON A VISIBLE PLACE:
or use the package RSPB, Sold separately.

WARNING | ATTENTION



REMOTE STARTER

THE VEHICLE CAN BE STARTED BY EITHER: PRESSING THE LOCK BUTTON ON THE OEM REMOTE 3 TIMES CONSECUTIVELY OR BY A SMARTPHONE. **TURN ON** THE SAFETY SWITCH LOCATED UNDER THE DASHBOARD BEFORE WORKING ON THE VEHICLE.

DESCRIPTION | DESCRIPTION

	Parts required (Not included)	PAGE
--	-------------------------------	------

WIRE TO WIRE DIAGRAM

AUTOMATIC TRANSMISSION	1x 7.5 Amp. fuse	Page 3
------------------------	------------------	--------

THARNES DIAGRAM

THARNES THAR-FOR3 AUTOMATIC TRANSMISSION	1x THAR-FOR3	Page 4
--	--------------	--------



① Gateway module, Behind OBD-II connector

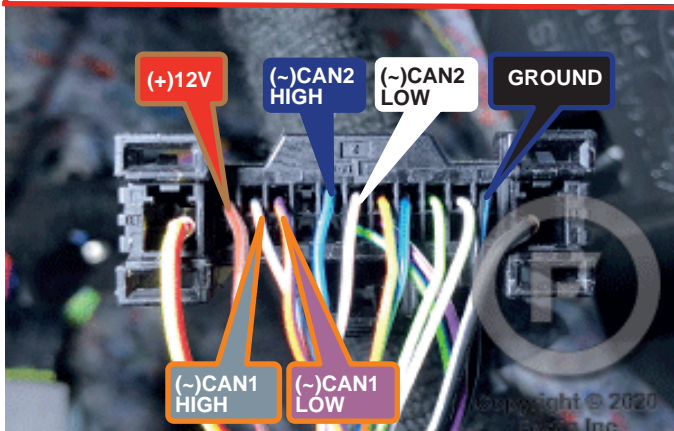

AUTOMATIC TRANSMISSION WIRING CONNECTION |

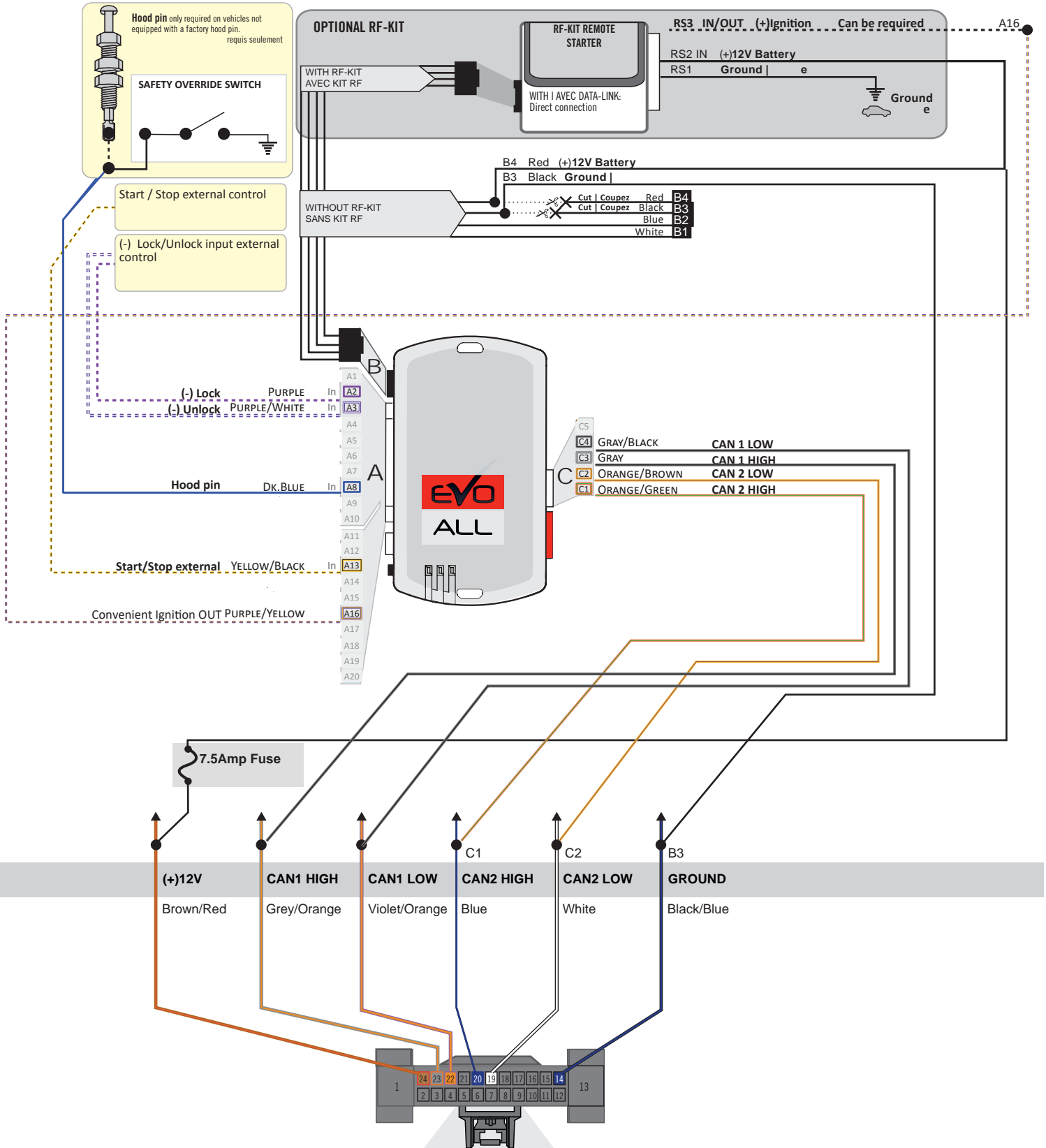

ESCAPE

① Gateway module, Connector Behind OBD-II connector - located at dash board driver's side Back view, 24-pin black connector.

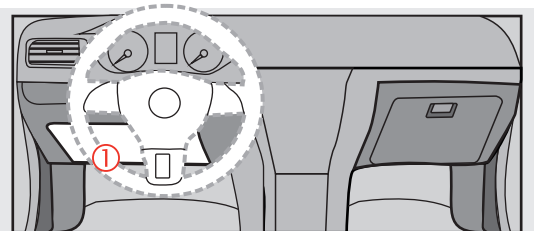

THAR-FOR3 | T-HARNESS - AUTOMATIC TRANSMISSION |

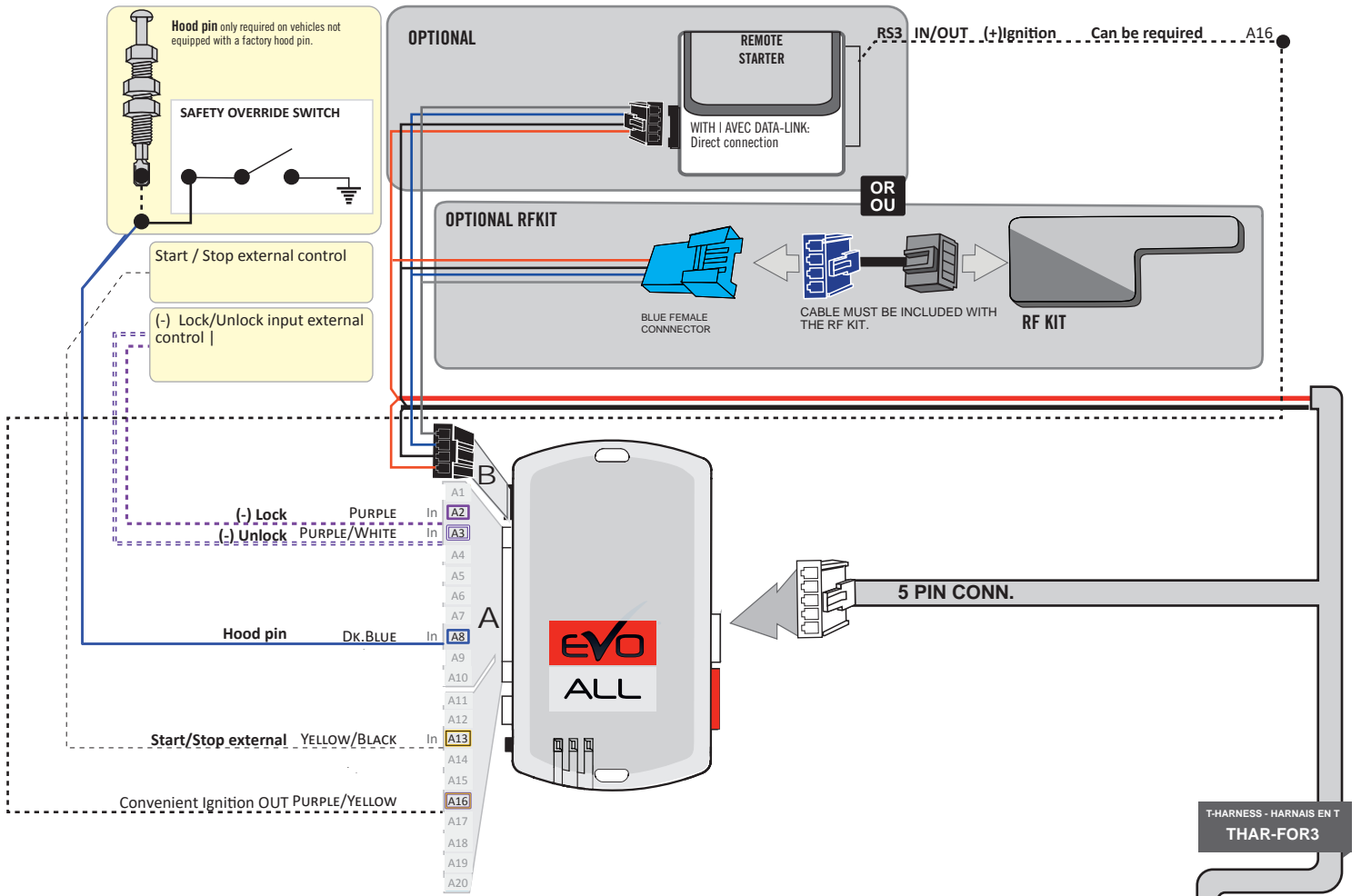

T-HARNESS - HARNAIS EN T
THAR-FOR3

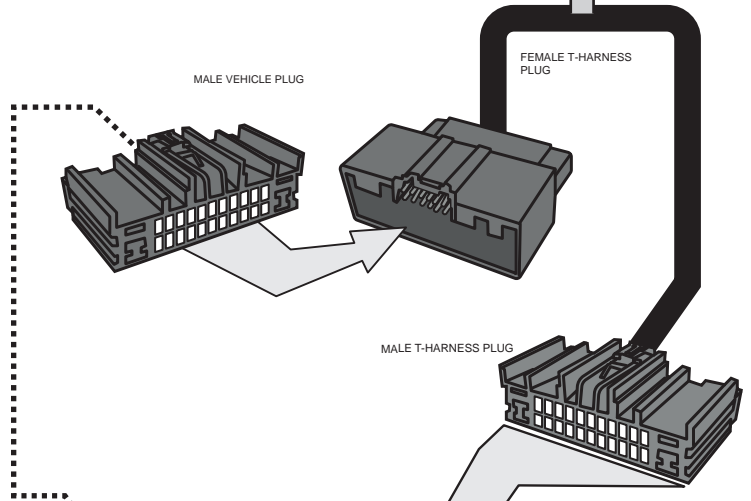

① Gateway module, Connector Behind OBD-II connector - located at dash board driver's side Back view, 24-pin black connector.

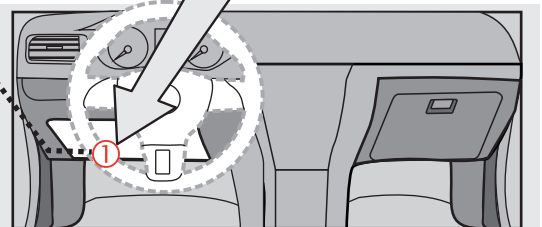



Parts required (not included)

- 1x **FLASH LINK UPDATER,**
- 1x **FLASH LINK MANAGER**
SOFTWARE | PROGRAMME
- 1x Microsoft Windows Computer with Internet connection
Ordinateur Microsoft Windows avec connection Internet

OR

- 1x **FLASH LINK MOBILE**
- 1x **FLASH LINK MOBILE APP**
- Smartphone *Android* or *iOS* with Internet connection
(Internet provider charges may apply)

BEFORE PROGRAMMING SET THE UNIT OPTIONS AND SAVE.

1

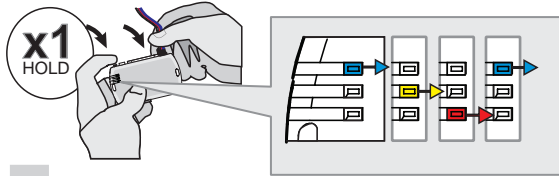

Press and hold the programming button:
Insert the 4-Pin (Data-Link) connector.

↳ The Blue, Red, Yellow and Blue & Red LEDs will alternatively illuminate.

2

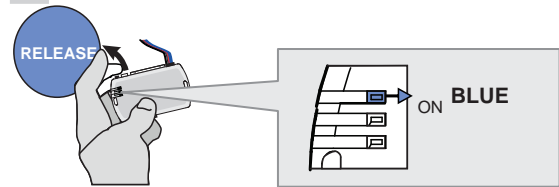

Release the programming button when the LED is BLUE.

If the LED is not solid BLUE disconnect the 4-Pin connector (Data-Link) and go back to step 1.

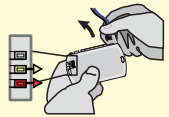

3

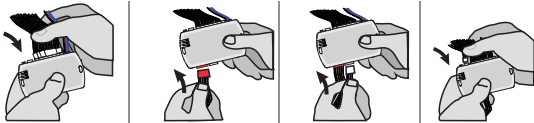

Insert the required remaining connectors.

4

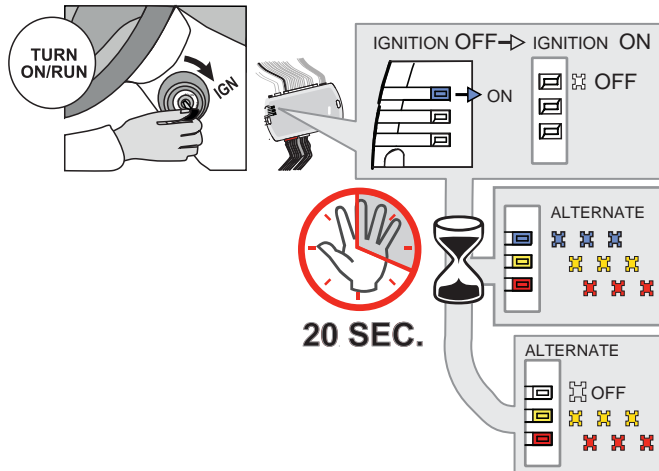

Turn the key to the Ignition ON/RUN position.

↳ The BLUE LED will turn OFF.

↳ The BLUE, YELLOW and RED LEDs will alternate.

Wait, at least 20 seconds, do not disconnect the modules or turn off the ignition.

↳ The RED and YELLOW LEDs will alternate.

Make sure that the DELs are flashing RED and YELLOW before continuing programming.

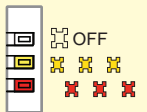

5

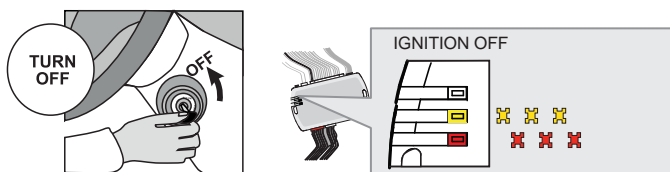

Turn the key to the OFF position.

↳ The RED and YELLOW LEDs alternate.

KEY BYPASS PROGRAMMING PROCEDURE 2/2 |

6

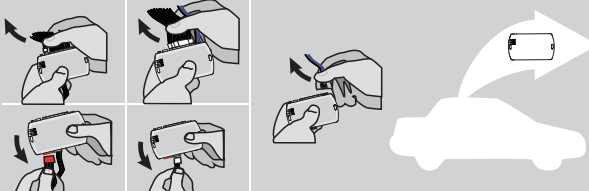

Disconnect all the connectors and after the Data-Link (4-pins) connector.

7



Microsoft Windows Computer with Internet connection*

FLASH LINK UPDATER* **FLASH LINK MANAGER***
SOFTWARE | PROGRAMME

OR

Smartphone* (Internet provider charges may apply)

FLASH LINK MOBILE*

VEHICLE'S OBDII CONNECTOR

Use the tool: FLASH LINK UPDATER or FLASH LINK MOBILE to visit the DCRYPTOR menu.

*Parts required (not included)

8

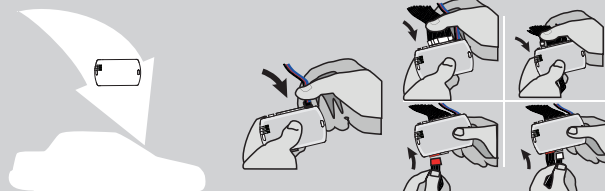

AFTER DCRYPTOR PROGRAMMING COMPLETED
Go back to the vehicle and reconnect the 4-Pin (Data-Link) connector and after, all the remaining connector.

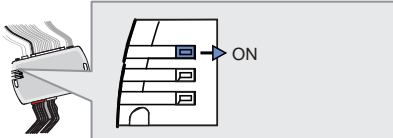

↳ The **BLUE LED** will turn ON.

9

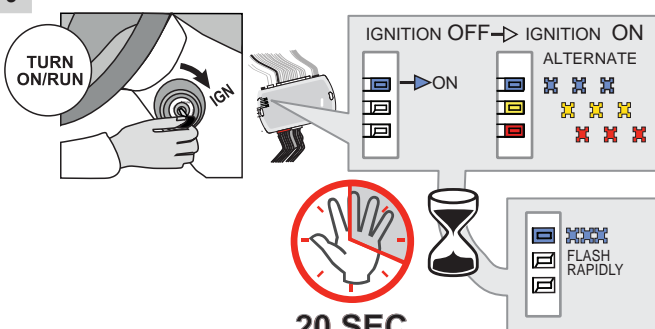

TURN ON/RUN

IGNITION OFF → IGNITION ON

ALTERNATE

↳ The **RED and YELLOW LEDs** will turn ON.

Wait, at least 20 seconds, do not disconnect the modules or turn off the ignition.

↳ The **BLUE LED** will flash rapidly.

20 SEC.

FLASH RAPIDLY

10

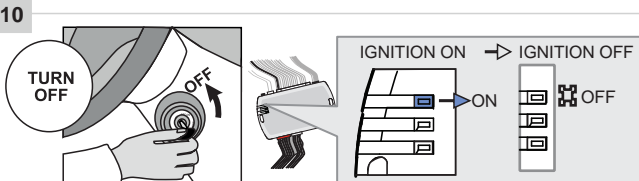

TURN OFF

IGNITION ON → IGNITION OFF

↳ The **BLUE** will turn OFF.



The module is now programmed.

OPTIONAL RF-KIT PROGRAMMING |

PROGRAM BYPASS OPTION

	Program bypass option:	H2	<input checked="" type="checkbox"/> Supported RF-KITS enable <input checked="" type="checkbox"/> H2 Fortin 2 <input checked="" type="checkbox"/>
--	------------------------	-----------	---

OPTIONAL FORTIN RF KIT SERIES 4 OR SERIES 9 PROGRAMMING



The module must be programmed on the vehicle.

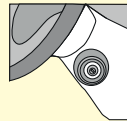

MAKE SURE THE IGNITION KEY HAS BEEN IN THE OFF POSITION FOR AT LEAST 5 SECONDS.

<p>1</p> <p>ON TURN ON/RUN</p>	<p>2</p> <p>OFF TURN OFF</p>	<p>3</p> <p>ON TURN ON/RUN</p>	<p>4</p> <p>4X BRAKES</p> <p>x4 PRESS</p>	<p>5</p> <p>ON EACH TRANSMITTER</p> <p>4 BUTTONS</p> <p>PRESS AND RELEASE</p> <p>PRESS AND RELEASE</p> <p>1 BUTTON</p> <p>PRESS APPROX. 12 SEC. AND WAIT FOR THE BLUE LED TO TURN OFF THEN BACK ON SOLID THEN RELEASE.</p>	<p>6</p> <p>OFF TURN OFF</p>	<p>7</p> <p>ON TURN ON/RUN</p>	<p>8</p> <p>OFF TURN OFF</p>
<p>Turn the key to the ON/RUN position.</p>	<p>Turn the ignition to the OFF position.</p>	<p>Turn the key to the ON/RUN position.</p>	<p>Press and release the brake pedal four times.</p>		<p>Turn the ignition to the OFF position.</p>	<p>Turn the key to the ON/RUN position and leave it ON for 5 sec.</p>	<p>Turn the ignition to the OFF position.</p>
						<p>pour 5 sec.</p>	
		<p>The LED will turn ON solide.</p>	<p>The LED will flash rapidly.</p>	<p>The LED will turn off each time.</p>	<p>The LED will turn Off.</p>		
<p>The YELLOW LED will turn ON solid.</p>	<p>The YELLOW LED will turn Off.</p>	<p>The YELLOW LED will turn ON solid.</p>	<p>The 3 LED will turn ON solid.</p>	<p>The LED will flash rapidly.</p>	<p>The 3 LED will turn off.</p>	<p>The YELLOW LED will turn ON solid.</p>	<p>The YELLOW LED will turn Off.</p>
				<p>The 3 LED will turn off each time.</p>			



REMOTE STARTER FUNCTIONALITY |



All doors must be closed.



Remote start the vehicle.



Unlock the doors with the remote-starter remote or the OEM remote.



Insert and Turn the key to the Ignition ON/RUN position.



Press the brake pedal.



The vehicle can now be put in to gear and driven.

STANDALONE & THAR-FOR3 INSTALLATION

ADDENDUM - SUGGESTED WIRING CONFIGURATION



Vehicle functions supported in this diagram (functional if equipped)

VEHICLE	YEARS	Immobilizer bypass	Lock	Unlock	Arm	Disarm	Heated Seats**	Rear Defrost**	RAP Disable	Parking Lights***	Tachometer	Door Status	Trunk Status	Hood Status*	Hand-Brake Status	Foot-Brake Status	Active OEM Remote Start
FORD																	
Escape	Push-to-Start 2020	•	•	•	•	•	•	•	•	•	•	•	•	•	•	•	•

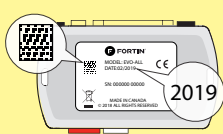

COMPATIBLE MODULE REQUIRED:

QR CODE ON THE LABEL
MANUFACTURED AFTER: 2019

FIRMWARE VERSION
58.[02]
MINIMUM

To add the firmware version and the options, use the **FLASH LINK UPDATER** or **FLASH LINK MOBILE** tool, sold separately.



Program bypass option:

UNIT OPTION

DESCRIPTION

C1

OEM Remote status (Lock/Unlock) monitoring

D6

Push-to-Start

IF THE VEHICLE IS NOT EQUIPPED WITH FUNCTIONAL HOOD PIN:

A11

OFF

Hood trigger (Output Status).

NOTES

The vehicles OEM remote and SmartKey are still operable during remote start.

**Heated seats The heated seats and rear defrost activate automatically when it cold.
**Rear Defrost

***Parking Lights The parking Lights at remote start only.

MANDATORY INSTALL

*HOOD PIN



HOOD STATUS: THE HOOD PIN SWITCH MUST BE INSTALLED IF THE VEHICLE CAN BE REMOTE STARTED WITH THE HOOD OPEN, SET FUNCTION A11 TO OFF.

A11

OFF

Notice: the installation of safety elements are mandatory. The hood pin is an essential security element and must be installed.

THIS MODULE MUST BE INSTALLED BY A QUALIFIED TECHNICIAN. A WRONG CONNECTION CAN CAUSE PERMANENT DAMAGE TO THE VEHICLE.

PARTS REQUIRED (NOT INCLUDED)

1x **FLASH LINK UPDATER,**
1x **FLASH LINK MANAGER**
SOFTWARE | PROGRAMME
1x Microsoft Windows Computer with Internet connection

OR

1x **FLASH LINK MOBILE**
1x **FLASH LINK MOBILE APP**
Smartphone *Android* or *iOS* with Internet connection (*provider charges may apply*).

MANDATORY

HOOD PIN



REMOTE START SAFETY OVERRIDE SWITCH









VALET SWITCH

Part #: RSPB available, Sold separately.

Notice: the installation of safety elements are mandatory. The hood pin and the valet switch are essential security elements and must be installed.

STAND ALONE CONFIGURATION

	Program bypass option	UNIT OPTION	DESCRIPTION
	OEM Remote Stand Alone Remote Starter:	D1.10 	By default, LOCK, LOCK, LOCK
		D1.1 	Par défaut, VERROUILLE, VERROUILLE, VERROUILLE
	Program bypass option with oem remote:	C1	OEM Remote Monitoring
	Program bypass option with RF KIT antenna:	H1 to H6	Supported RF Kits and select RF Kit
	Program bypass option Vehicle hybrid only:	D4	Hybrid mode (Vehicle hybrid only)

REMOTE STARTER FUNCTIONALITY



All doors must be closed.

3X 

Press the OEM remote's Lock button 3x to remote-start (or remote-stop) the vehicle.



START

The vehicle will START.

REMOTE STARTER DIAGNOSTICS
MODULE RED LED

x2 flash :	Brake ON
x3 flash :	No tach
x4 flash :	Ignition before start
x5 flash :	Hood Open

REMOTE STARTER WARNING CARD



CUT THIS WARNING CARD AND STICK IT ON A VISIBLE PLACE:
or use the package RSPB, Sold separately.

WARNING



REMOTE STARTER

THE VEHICLE CAN BE STARTED BY EITHER: PRESSING THE LOCK BUTTON ON THE OEM REMOTE 3 TIMES CONSECUTIVELY OR BY A SMARTPHONE. **TURN ON** THE SAFETY SWITCH LOCATED UNDER THE DASHBOARD BEFORE WORKING ON THE VEHICLE.

DESCRIPTION

	Parts required (Not included)	PAGE
--	-------------------------------	------

WIRE TO WIRE DIAGRAM

AUTOMATIC TRANSMISSION	1x 7.5 Amp. fuse	Page 3
------------------------	------------------	--------

THARNES DIAGRAM

THARNES THAR-FOR3	AUTOMATIC TRANSMISSION	1x THAR-FOR3	Page 4
-------------------	------------------------	--------------	--------



① Gateway module, Behind OBD-II connector

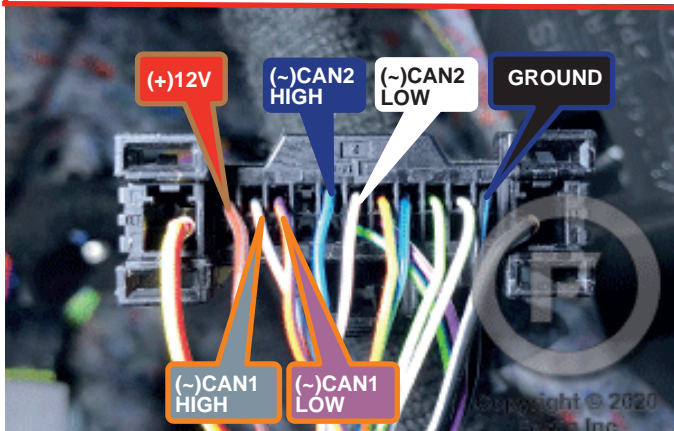

AUTOMATIC TRANSMISSION WIRING CONNECTION

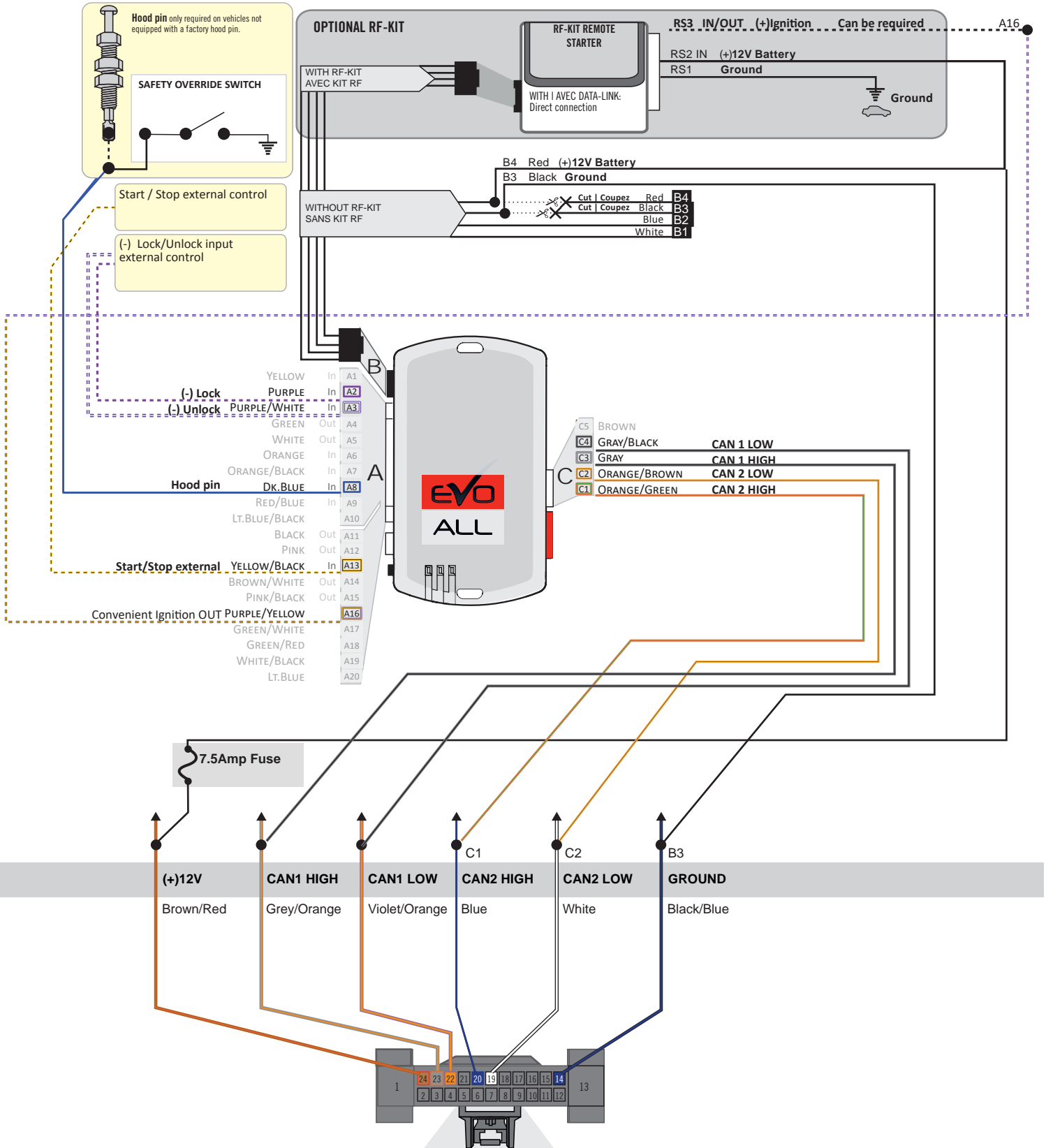

① Gateway module, Connector Behind OBD-II connector - located at dash board driver's side Back view, 24-pin black connector.

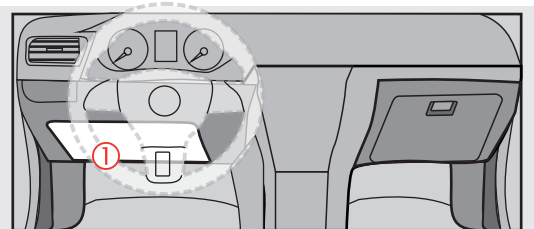

THAR-FOR3 | T-HARNESS - AUTOMATIC TRANSMISSION

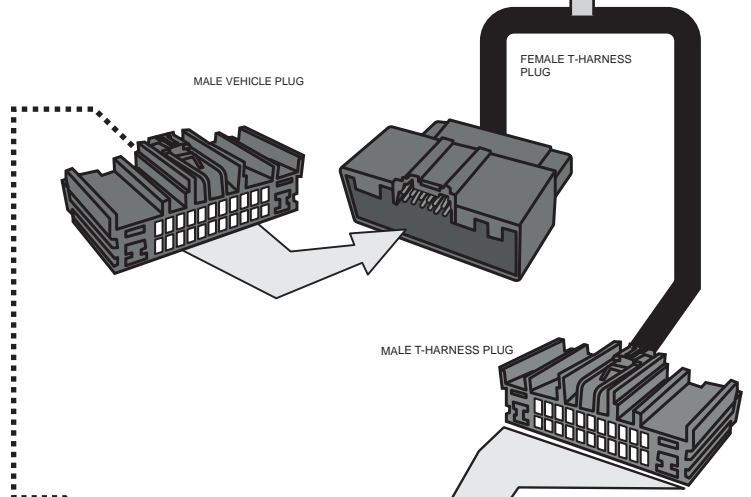
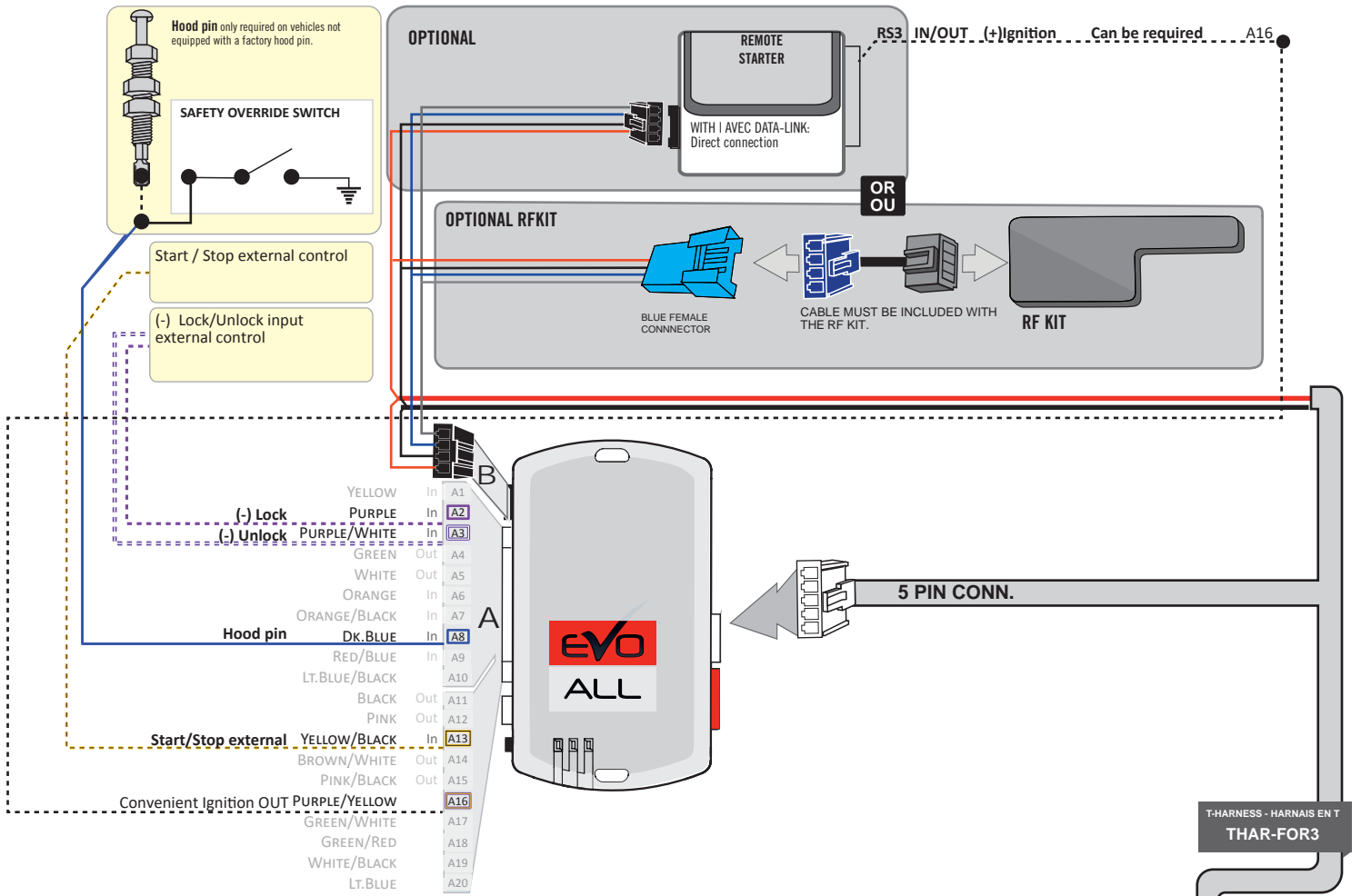

① Gateway module, Connector Behind OBD-II connector - located at dash board driver's side Back view, 24-pin black connector.

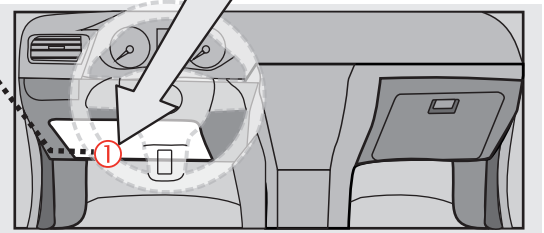

DCRYPTOR PROGRAMMING PROCEDURE



Parts required (not included)

- 1x FLASH LINK UPDATER, SOFTWARE | PROGRAMME
- 1x FLASH LINK MANAGER
- 1x Microsoft Windows Computer with Internet connection

OR

- 1x FLASH LINK MOBILE
- 1x FLASH LINK MOBILE APP
- Smartphone Android or iOS with Internet connection (Internet provider charges may apply)

BEFORE PROGRAMMING SET THE UNIT OPTIONS AND SAVE.

1

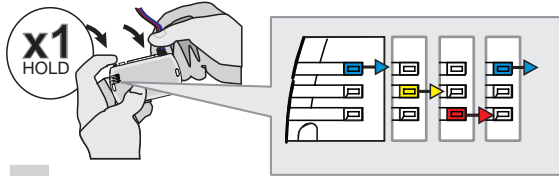

Press and hold the programming button:
Insert the 4-Pin (Data-Link) connector.

↳ The Blue, Red, Yellow and Blue & Red LEDs will alternatively illuminate.

2

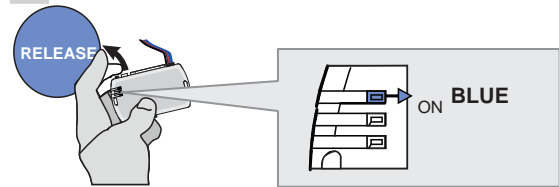

Release the programming button when the LED is BLUE.

If the LED is not solid BLUE disconnect the 4-Pin connector (Data-Link) and go back to step 1.

3

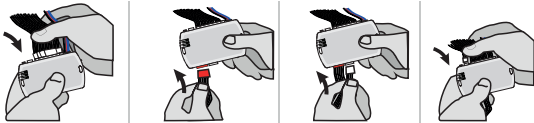

Insert the required remaining connectors.

4

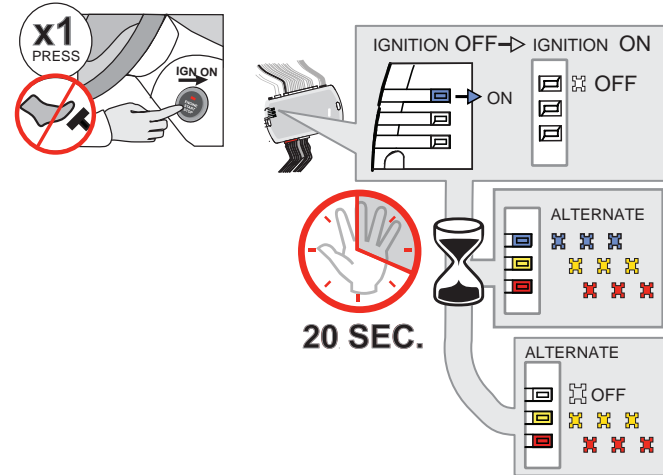

Do not press the brake pedal.
Press the Push-to-Start button once to turn on the ignition.

↳ The BLUE LED will turn OFF.

↳ The BLUE, YELLOW and RED LEDs will alternate.

Wait, at least 20 seconds, do not disconnect the modules or turn off the ignition.

↳ The RED and YELLOW LEDs will alternate.

Make sure that the DELs are flashing RED and YELLOW before continuing programming.

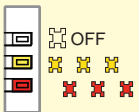

5

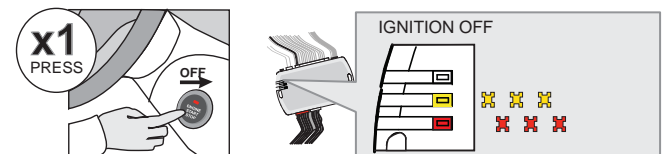

Press the Push-to-Start button once to turn off the ignition.

Appuyez 1 fois sur le bouton démarrage pour éteindre l'ignition.

↳ The RED and YELLOW LEDs alternate.

KEY BYPASS PROGRAMMING PROCEDURE 2/2

6

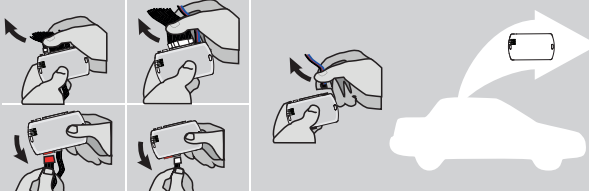

Disconnect all the connectors and after the Data-Link (4-pins) connector.

7



Microsoft Windows Computer with Internet connection*

FLASH LINK UPDATER* **FLASH LINK MANAGER***
SOFTWARE | PROGRAMME

OR

Smartphone* (Internet provider charges may apply)

VEHICLE'S OBDII CONNECTOR **FLASH LINK MOBILE***

Use the tool: FLASH LINK UPDATER or FLASH LINK MOBILE to visit the DCryptor menu.

*Parts required (not included)

8

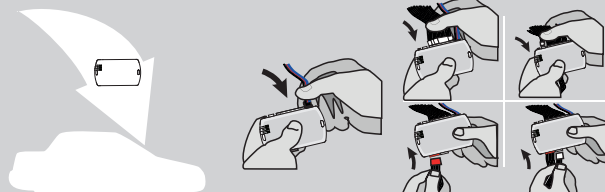

AFTER DCRYPTOR PROGRAMMING COMPLETED
Go back to the vehicle and reconnect the 4-Pin (Data-Link) connector and after, all the remaining connector.

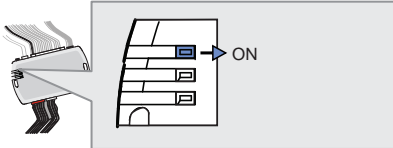

↳ The BLUE LED will turn ON.

9

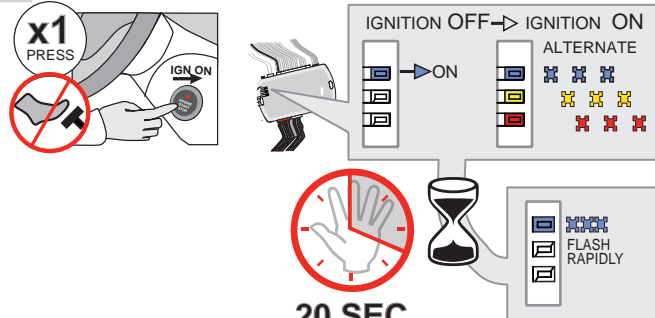

x1 PRESS (with a red 'X' over the push-to-start button)

IGNITION OFF → IGNITION ON

ALTERNATE

↳ The RED and YELLOW LEDs will turn ON.

20 SEC.

FLASH RAPIDLY

Wait, at least 20 seconds, do not disconnect the modules or turn off the ignition.

↳ The BLUE LED will flash rapidly.

10

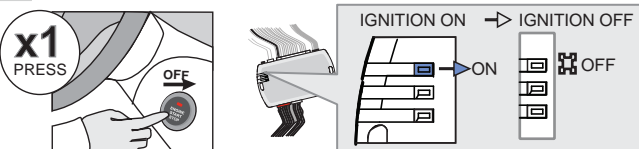

x1 PRESS (with a red 'X' over the push-to-start button)

IGNITION ON → IGNITION OFF

OFF

Press the Push-to-Start button once to turn off the ignition.

↳ The BLUE will turn OFF.



The module is now programmed.

OPTIONAL RF-KIT PROGRAMMING

PROGRAM BYPASS OPTION

	<p>Program bypass option:</p>	<p>H2</p>	<p><input checked="" type="checkbox"/> Supported RF-KITS enable <input checked="" type="checkbox"/> H2 Fortin 2</p>
---	-------------------------------	------------------	---









OPTIONAL FORTIN RF KIT SERIES 4 OR SERIES 9 PROGRAMMING



The module must be programmed on the vehicle.



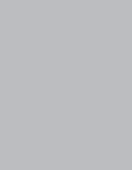
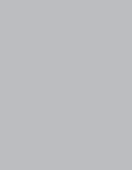
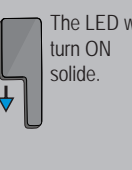
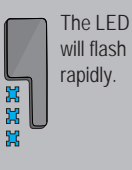
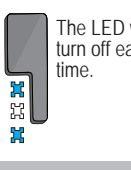
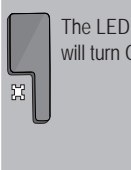

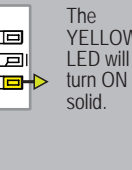
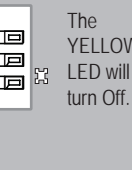
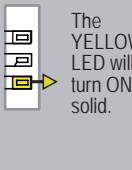
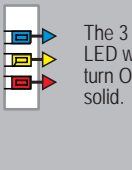
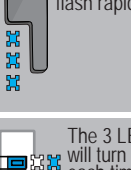
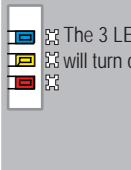
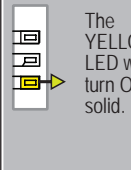
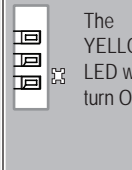

MAKE SURE THE IGNITION KEY HAS BEEN IN THE OFF POSITION FOR AT LEAST 5 SECONDS.

<p>1</p> <p>ON x1 PRESS</p>  <p>Do not press the brake pedal. Press the Push-to-Start button once to turn on the ignition.</p>	<p>2</p> <p>OFF x1 PRESS</p>  <p>Press the Push-to-Start button once to turn off the ignition.</p>	<p>3</p> <p>ON x1 PRESS</p>  <p>Do not press the brake pedal. Press the Push-to-Start button once to turn on the ignition.</p>	<p>4</p> <p>4X BRAKES</p> <p>x4 PRESS</p>  <p>Press and release the brake pedal four times. Appuyez et relâchez quatre fois la pédale de frein.</p>	<p>5</p> <p>ON EACH TRANSMITTER</p> <p>4 BUTTONS 4 BOUTONS</p> <p>[-] PRESS AND RELEASE → PRESS AND RELEASE</p> <p>1 BUTTON</p> <p>PRESS APPROX. 12 SEC. AND WAIT FOR THE BLUE LED TO TURN OFF THEN BACK ON SOLID THEN RELEASE. APPROX. 12 SEC, LA</p>	<p>6</p> <p>OFF x1 PRESS</p>  <p>Press the Push-to-Start button once to turn off the ignition.</p>	<p>7</p> <p>ON x1 PRESS</p>  <p>Do not press the brake pedal. Press the Push-to-Start button once to turn on the ignition and leave it ON for 5 sec..</p>	<p>8</p> <p>OFF x1 PRESS</p>  <p>Press the Push-to-Start button once to turn off the ignition.</p>
 <p>The LED will turn ON solid.</p>	 <p>The LED will flash rapidly.</p>	 <p>The LED will turn ON solid.</p>	 <p>The LED will flash rapidly.</p>	 <p>The LED will turn off each time.</p>	 <p>The LED will turn Off.</p>	 <p>The LED will turn Off.</p>	 <p>The LED will turn Off.</p>
 <p>The YELLOW LED will turn ON solid.</p>	 <p>The YELLOW LED will turn Off.</p>	 <p>The YELLOW LED will turn ON solid.</p>	 <p>The 3 LED will turn ON solid.</p>	 <p>The LED will flash rapidly.</p>	 <p>The 3 LED will turn off.</p>	 <p>The YELLOW LED will turn ON solid.</p>	 <p>The YELLOW LED will turn Off.</p>

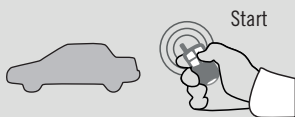

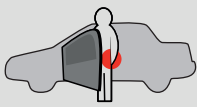
REMOTE STARTER FUNCTIONALITY

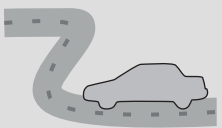
 <p>Start</p> <p>All doors must be closed.</p> <p>Remote start the vehicle.</p>	 <p>UNLOCK</p> <p>Unlock the doors with either:</p> <ul style="list-style-type: none"> • The OEM remote • The remote-starter remote • Or the proximity remote 	 <p>Enter the vehicle with the SMART-KEY.</p>	 <p>DO NOT PRESS THE BRAKE PEDAL.</p> <p>Press and release the Push-to-Start button once.</p>	 <p>Press the brake pedal. The vehicle can now be put in to gear and driven.</p> <p>If the Smart-Key is not detected the vehicle will shut down.</p>
--	---	--	---	---

STANDALONE & THAR-FOR3 INSTALLATION

ADDENDUM - SUGGESTED WIRING CONFIGURATION



ONLY COMPATIBLE WITH AUTOMATIC TRANSMISSION VEHICLES.



Vehicle functions supported in this diagram (functional if equipped)

VEHICLE	YEARS	Immobilizer bypass	T-Harness available (sold separately)	Lock	Unlock	Arm	Disarm	Heated Seats**	Rear Defrost**	RAP Disable	Parking Lights***	Tachometer	Door Status	Trunk Status	Hood Status*	Hand-Brake Status	Foot-Brake Status	Active OEM Remote Start
FORD																		
Expedition	2018-2020	•	•	•	•	•	•	•	•	•	•	•	•	•	•	•	•	•

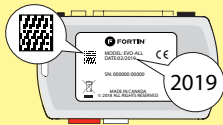

COMPATIBLE MODULE REQUIRED:

QR CODE ON THE LABEL
MANUFACTURED AFTER: 2019

FIRMWARE VERSION

58.[02]
MINIMUM

To add the firmware version and the options, use the **FLASH LINK UPDATER** or **FLASH LINK MOBILE** tool, sold separately.



Program bypass option:

UNIT OPTION OPTION UNITE

C1

DESCRIPTION

OEM Remote status (Lock/Unlock) monitoring

IF THE VEHICLE IS NOT EQUIPPED WITH FUNCTIONAL HOOD PIN:

A11

OFF

Hood trigger (Output Status).

NOTES

The vehicles OEM remote and SmartKey are still operable during remote start.

**Heated seats The heated seats and rear defrost activate automatically when it cold.

***Parking Lights The parking Lights at remote start only.



The vehicle must be equipped with the OEM remote with the door locks.

MANDATORY INSTALL

*HOOD PIN



HOOD STATUS: THE HOOD PIN SWITCH MUST BE INSTALLED IF THE VEHICLE CAN BE REMOTE STARTED WITH THE HOOD OPEN, SET FUNCTION A11 TO OFF.

A11

OFF

Notice: the installation of safety elements are mandatory. The hood pin is an essential security element and must be installed.

THIS MODULE MUST BE INSTALLED BY A QUALIFIED TECHNICIAN. A WRONG CONNECTION CAN CAUSE PERMANENT DAMAGE TO THE VEHICLE.

PARTS REQUIRED (NOT INCLUDED) |

1x **FLASH LINK UPDATER,**
1x **FLASH LINK MANAGER**
SOFTWARE | PROGRAMME
1x Microsoft Windows Computer with Internet connection

OR

1x **FLASH LINK MOBILE**
1x **FLASH LINK MOBILE APP**
Smartphone Android or iOS with Internet connection (provider charges may apply).

MANDATORY

HOOD PIN CONTACT

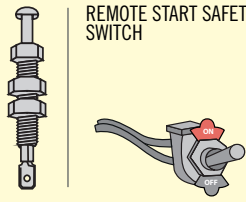







REMOTE START SAFETY OVERRIDE SWITCH

VALET SWITCH

Part #: RSPB available, Sold separately.

Notice: the installation of safety elements are mandatory. The hood pin and the valet switch are essential security elements and must be installed.

STAND ALONE CONFIGURATION |

	Program bypass option	UNIT OPTION	DESCRIPTION
	OEM Remote Stand Alone Remote Starter:	D1.10 	By default, LOCK, LOCK, LOCK
		D1.1 	Par défaut, VERROUILLE,VERROUILLE,VERROUILLE
	Program bypass option with oem remote:	C1	OEM Remote Monitoring
	Program bypass option with RF KIT antenna:	H1 to H6	Supported RF Kits and select RF Kit
	Program bypass option Vehicle hybrid only:	D4	Hybrid mode (Vehicle hybrid only)

REMOTE STARTER FUNCTIONALITY |



All doors must be closed.

3X 

Press the OEM remote's Lock button 3x to remote-start (or remote-stop) the vehicle.



START 

The vehicle will START.

REMOTE STARTER DIAGNOSTICS

MODULE RED LED

x2 flash : Brake ON

x3 flash : No tach

x4 flash : Ignition before start

x5 flash : Hood Open

REMOTE STARTER WARNING CARD |



CUT THIS WARNING CARD AND STICK IT ON A VISIBLE PLACE:
or use the package RSPB, Sold separately.

WARNING

REMOTE STARTER

THE VEHICLE CAN BE STARTED BY EITHER: PRESSING THE LOCK BUTTON ON THE OEM REMOTE 3 TIMES CONSECUTIVELY OR BY A SMARTPHONE. **TURN ON** THE SAFETY SWITCH LOCATED UNDER THE DASHBOARD BEFORE WORKING ON THE VEHICLE.

DESCRIPTION

	Parts required (Not included)	PAGE
--	-------------------------------	------

WIRE TO WIRE DIAGRAM

AUTOMATIC TRANSMISSION	1x 7.5 Amp. fuse	Page 3
------------------------	------------------	--------

THARNESSE DIAGRAM

THARNESSE THAR-FOR3 AUTOMATIC TRANSMISSION	1x THAR-FOR3	Page 4
--	--------------	--------

EXPÉDITION



② Parking Lights switch

① Gateway module, Behind OBD-II connector

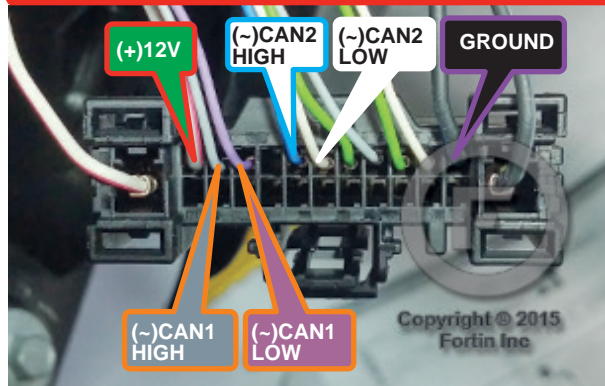
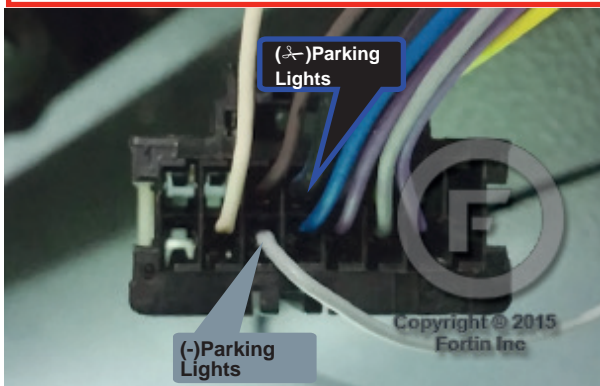

AUTOMATIC TRANSMISSION WIRING CONNECTION |

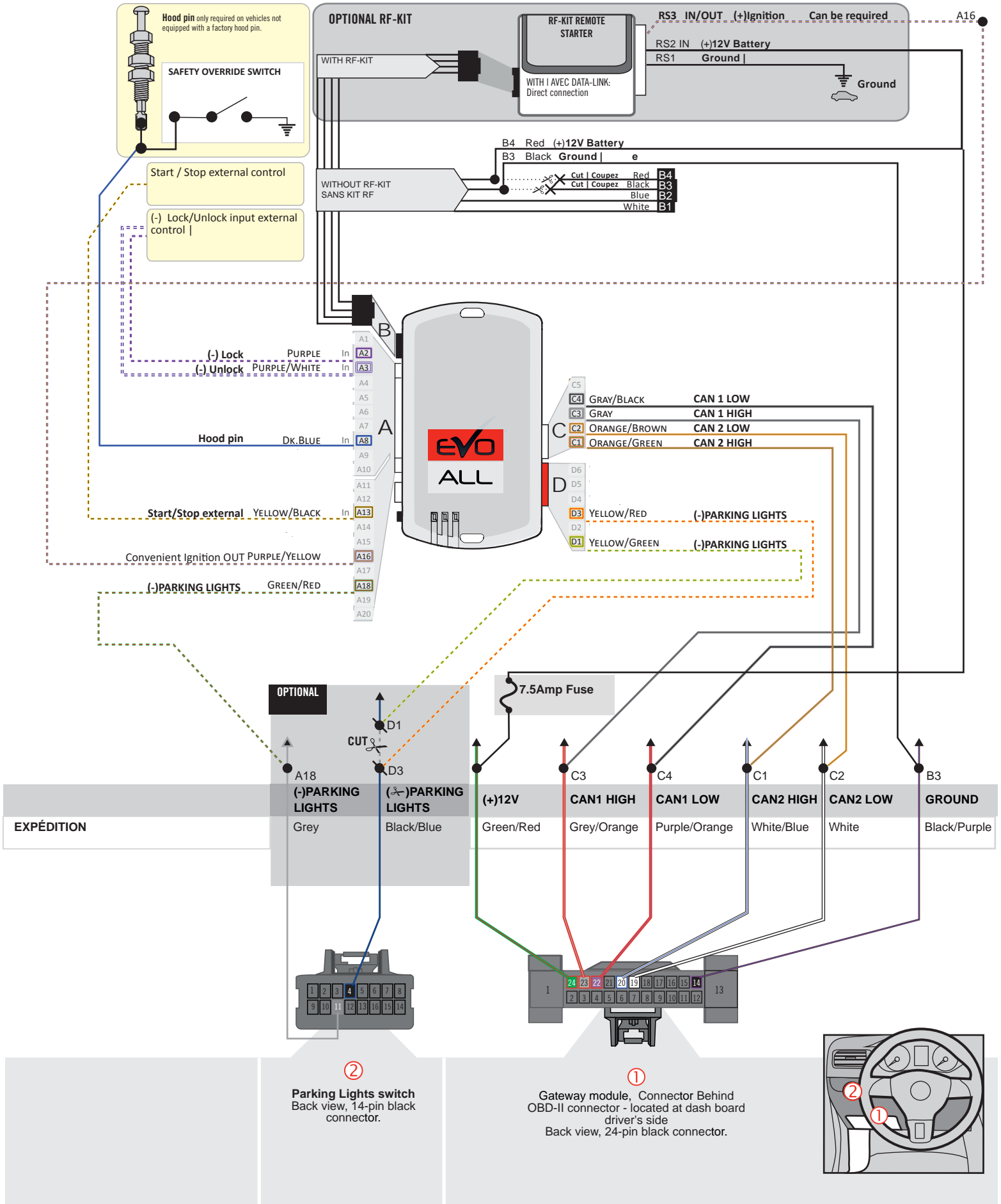

THAR-FOR3 | T-HARNESS - AUTOMATIC TRANSMISSION |

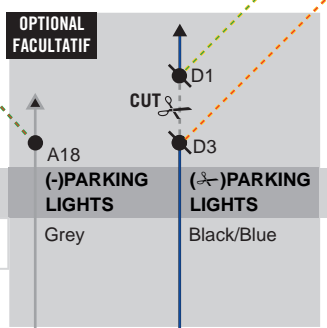
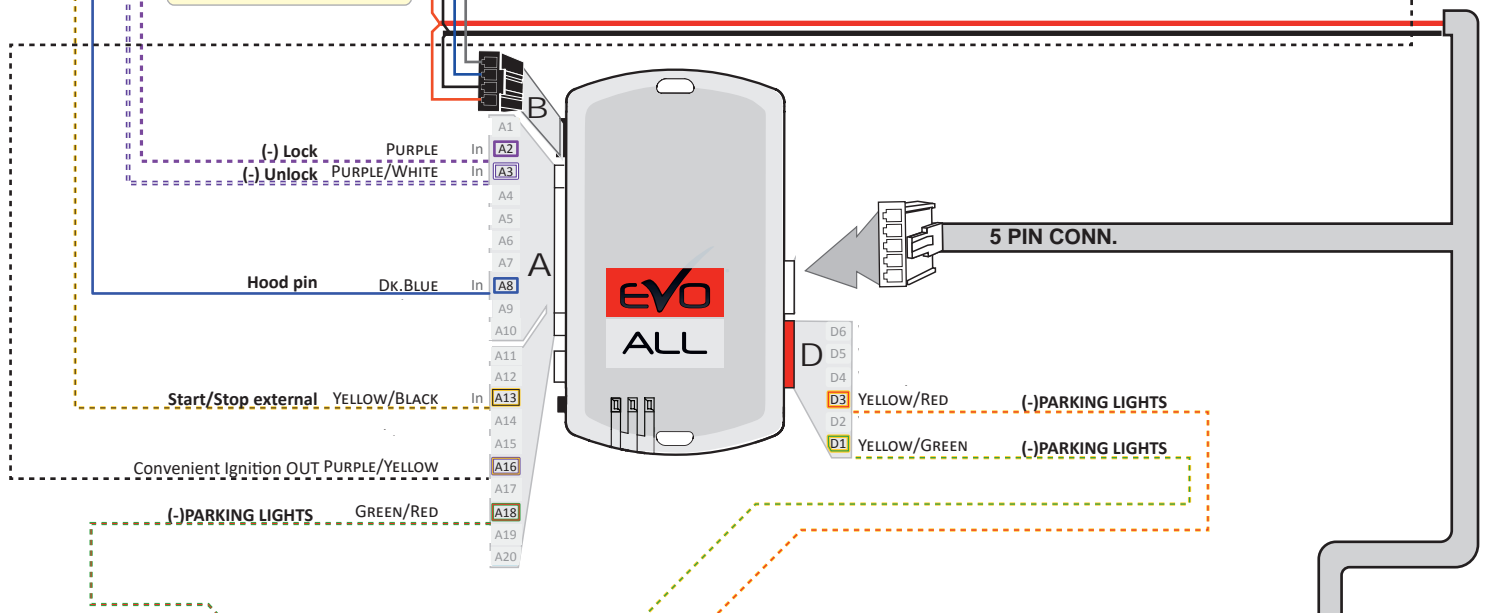
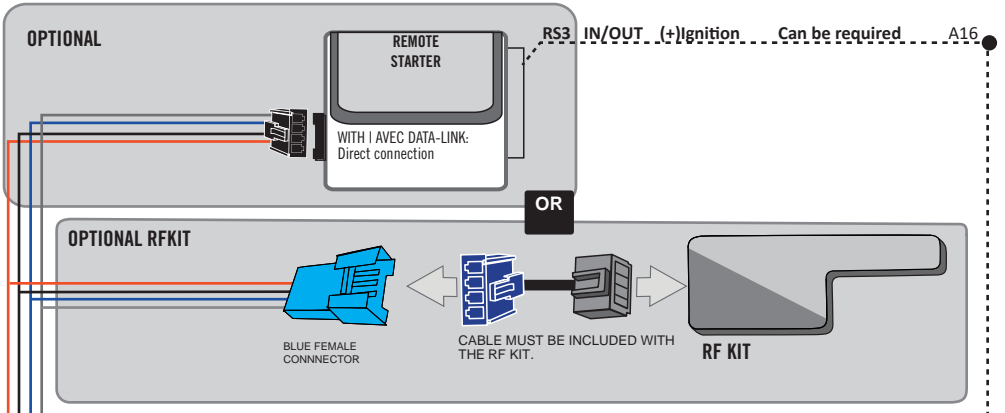
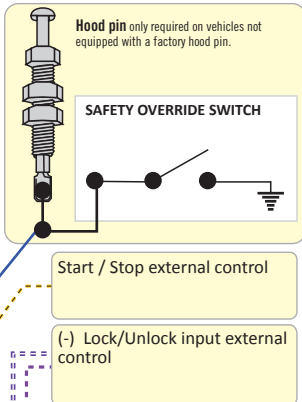

EXPÉDITION

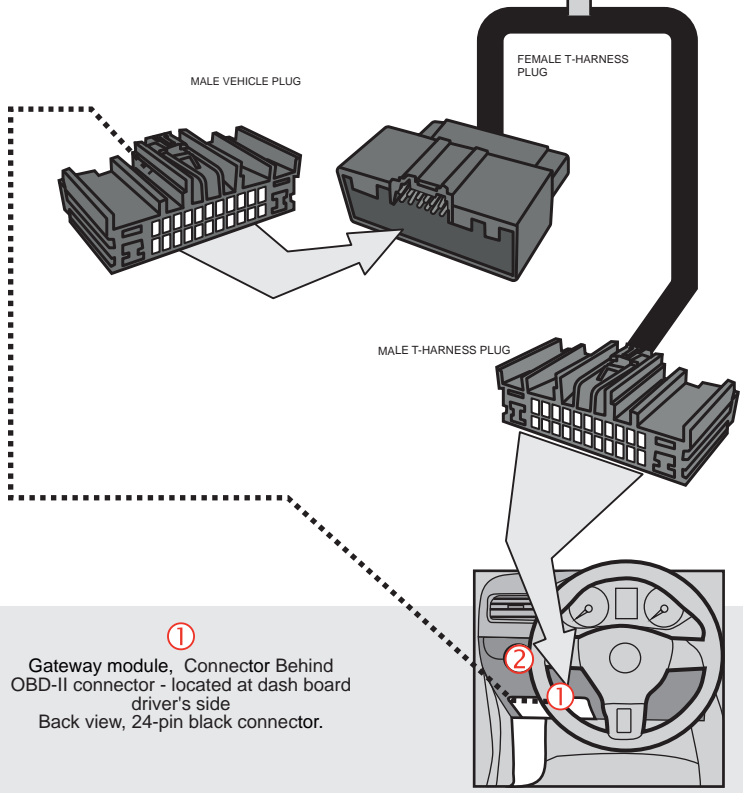

② Parking Lights switch
Back view, 14-pin black connector.

① Gateway module, Connector Behind OBD-II connector - located at dash board driver's side
Back view, 24-pin black connector.



Parts required (not included)

- 1x **FLASH LINK UPDATER,**
- 1x **FLASH LINK MANAGER**
SOFTWARE | PROGRAMME
- 1x Microsoft Windows Computer with Internet connection

OR
OU

- 1x **FLASH LINK MOBILE**
- 1x **FLASH LINK MOBILE APP**
- Smartphone *Android* or *iOS* with Internet connection
(Internet provider charges may apply)

BEFORE PROGRAMMING SET THE UNIT OPTIONS AND SAVE.

1

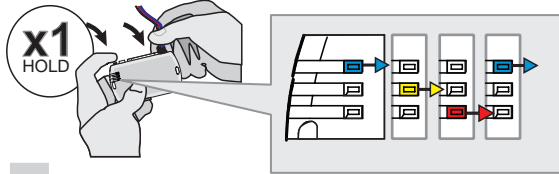

Press and hold the programming button:
Insert the 4-Pin (Data-Link) connector.

↳ The Blue, Red, Yellow and Blue & Red LEDs will alternatively illuminate.

2

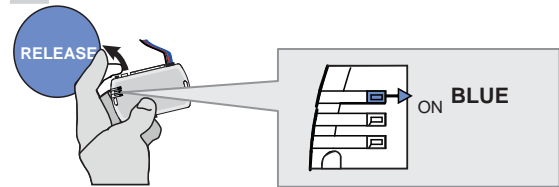

Release the programming button when the LED is BLUE.

If the LED is not solid BLUE disconnect the 4-Pin connector (Data-Link) and go back to step 1.

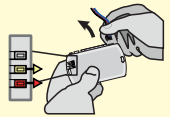

3

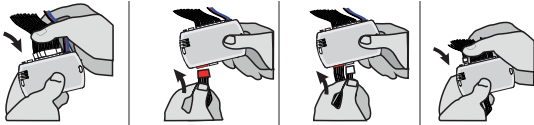

Insert the required remaining connectors.

4

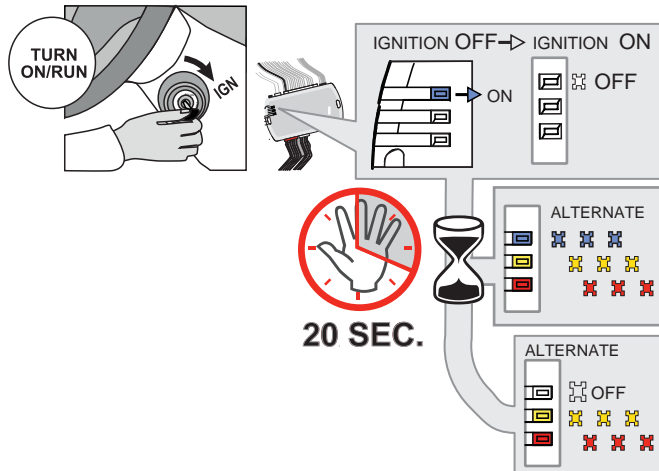

Turn the key to the Ignition ON/RUN position.

↳ The BLUE LED will turn OFF.

↳ The BLUE, YELLOW and RED LEDs will alternate.

Wait, at least 20 seconds, do not disconnect the modules or turn off the ignition.

↳ The RED and YELLOW LEDs will alternate.

Make sure that the DELs are flashing RED and YELLOW before continuing programming.

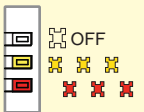

5

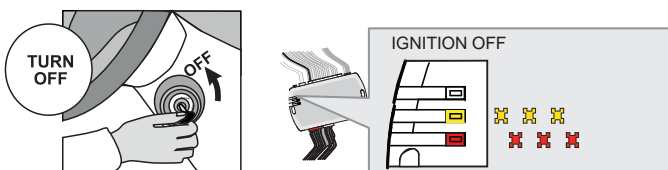

Turn the key to the OFF position.

↳ The RED and YELLOW LEDs alternate.

KEY BYPASS PROGRAMMING PROCEDURE 2/2 |

6

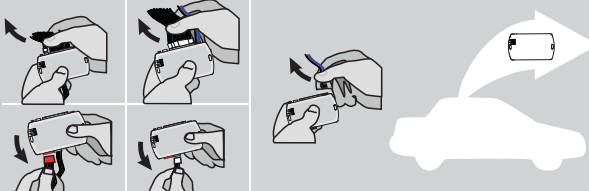

Disconnect all the connectors and after the Data-Link (4-pins) connector.

7



Microsoft Windows Computer with Internet connection*

FLASH LINK UPDATER* **FLASH LINK MANAGER***
SOFTWARE | PROGRAMME

OR

Smartphone* (Internet provider charges may apply)

VEHICLE'S OBDII CONNECTOR **FLASH LINK MOBILE***

Use the tool: FLASH LINK UPDATER or FLASH LINK MOBILE to visit the DCRYPTOR menu.

*Parts required (not included)

8

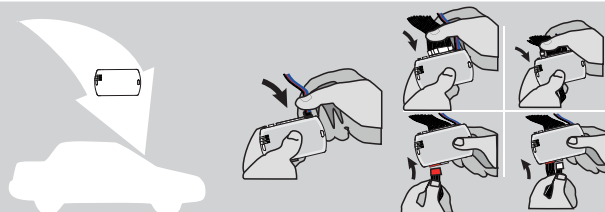

AFTER DCRYPTOR PROGRAMMING COMPLETED
Go back to the vehicle and reconnect the 4-Pin (Data-Link) connector and after, all the remaining connector.



↳ The BLUE LED will turn ON.

9

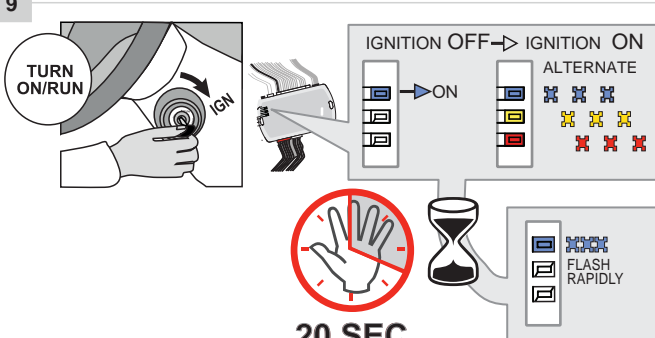

TURN ON/RUN

IGNITION OFF → IGNITION ON

ALTERNATE

↳ The RED and YELLOW LEDs will turn ON.

Wait, at least 20 seconds, do not disconnect the modules or turn off the ignition.

↳ The BLUE LED will flash rapidly.

20 SEC.

FLASH RAPIDLY

10

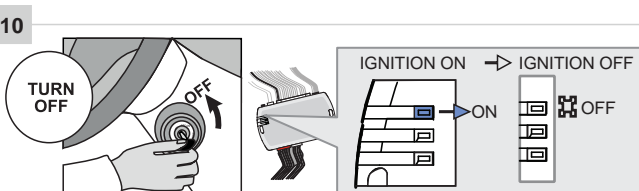

TURN OFF

IGNITION ON → IGNITION OFF

↳ The BLUE will turn OFF.



The module is now programmed.









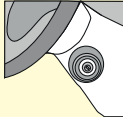

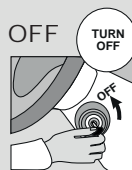
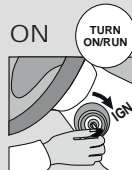

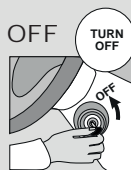

OPTIONAL RF-KIT PROGRAMMING |

PROGRAM BYPASS OPTION

	Program bypass option:	H2	<input checked="" type="checkbox"/> Supported RF-KITS enable <input checked="" type="checkbox"/> H2 Fortin 2
--	------------------------	-----------	--

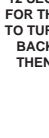
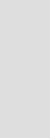
OPTIONAL FORTIN RF KIT SERIES 4 OR SERIES 9 PROGRAMMING

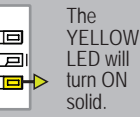
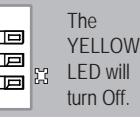
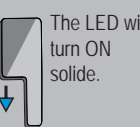
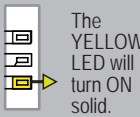
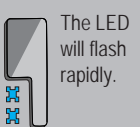
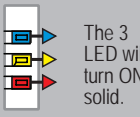
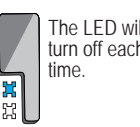
The module must be programmed on the vehicle.   **MAKE SURE THE IGNITION KEY HAS BEEN IN THE OFF POSITION FOR AT LEAST 5 SECONDS.**

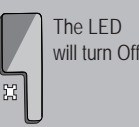
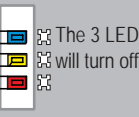
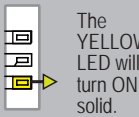
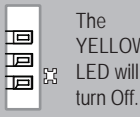
<p>1</p>  <p>ON TURN ON/RUN</p>	<p>2</p>  <p>OFF TURN OFF</p>	<p>3</p>  <p>ON TURN ON/RUN</p>	<p>4</p> <p>4X BRAKES</p>  <p>x4 PRESS</p>	<p>5</p> <p>ON EACH TRANSMITTER</p> <p>4 BUTTONS</p>  PRESS AND RELEASE  PRESS AND RELEASE  PRESS AND RELEASE <p>1 BUTTON</p>  PRESS APPROX. 12 SEC. AND WAIT FOR THE BLUE LED TO TURN OFF THEN BACK ON SOLID THEN RELEASE.	<p>6</p>  <p>OFF TURN OFF</p>	<p>7</p>  <p>ON TURN ON/RUN</p>	<p>8</p>  <p>OFF TURN OFF</p>
<p>Turn the key to the ON/RUN position.</p>	<p>Turn the ignition to the OFF position.</p>	<p>Turn the key to the ON/RUN position.</p>	<p>Press and release the brake pedal four times.</p>		<p>Turn the ignition to the OFF position.</p>	<p>Turn the key to the ON/RUN position and leave it ON for 5 sec.</p>	<p>Turn the ignition to the OFF position.</p>
			<p>The LED will turn off each time.</p> 	<p>The LED will turn off each time.</p> 	<p>The LED will turn Off.</p> 		
<p>The YELLOW LED will turn ON solid.</p> 	<p>The YELLOW LED will turn Off.</p> 	<p>The LED will turn ON solide.</p>  <p>The YELLOW LED will turn ON solid.</p> 	<p>The LED will flash rapidly.</p>  <p>The 3 LED will turn ON solid.</p> 	<p>The LED will flash rapidly.</p>  <p>The 3 LED will turn off each time.</p> 	<p>The LED will turn off each time.</p>  <p>The 3 LED will turn off.</p> 	<p>The YELLOW LED will turn ON solid.</p> 	<p>The YELLOW LED will turn Off.</p> 



REMOTE STARTER FUNCTIONALITY |



All doors must be closed.



Remote start the vehicle.



Unlock the doors with the remote-starter remote or the OEM remote.



Insert and Turn the key to the Ignition ON/RUN position.



Press the brake pedal.



The vehicle can now be put in to gear and driven.

STANDALONE & THAR-FOR3 INSTALLATION

ADDENDUM - SUGGESTED WIRING CONFIGURATION



ONLY COMPATIBLE WITH AUTOMATIC TRANSMISSION VEHICLES.



Vehicle functions supported in this diagram (functional if equipped)

VEHICLE	YEARS	Immobilizer bypass	T-Harness available (sold separately)	Lock	Unlock	Arm	Disarm	Heated Seats**	Rear Defrost**	RAP Disable	Parking Lights***	Tachometer	Door Status	Trunk Status	Hood Status*	Hand-Brake Status	Foot-Brake Status	Active OEM Remote Start	
FORD																			
Expedition	Push-to-Start 2018-2020	•	•	•	•	•	•	•	•	•	•	•	•	•	•	•	•	•	•

COMPATIBLE MODULE REQUIRED:

2019

QR CODE ON THE LABEL

MANUFACTURED AFTER: 2019

FIRMWARE VERSION

58.[02]

MINIMUM

To add the firmware version and the options, use the **FLASH LINK UPDATER** or **FLASH LINK MOBILE** tool, sold separately.

UNIT OPTION	DESCRIPTION
C1	OEM Remote status (Lock/Unlock) monitoring
D6	Push-to-Start
A11	OFF Hood trigger (Output Status).

IF THE VEHICLE IS NOT EQUIPPED WITH FUNCTIONAL HOOD PIN:

NOTES

The vehicles OEM remote and SmartKey are still operable during remote start.

**Heated seats The heated seats and rear defrost activate automatically when it cold.

**Rear Defrost

***Parking Lights The parking Lights at remote start only.

MANDATORY INSTALL

*HOOD PIN

HOOD STATUS: THE HOOD PIN SWITCH MUST BE INSTALLED IF THE VEHICLE CAN BE REMOTE STARTED WITH THE HOOD OPEN, SET FUNCTION A11 TO OFF.

A11 **OFF**

Notice: the installation of safety elements are mandatory. The hood pin is an essential security element and must be installed.

THIS MODULE MUST BE INSTALLED BY A QUALIFIED TECHNICIAN. A WRONG CONNECTION CAN CAUSE PERMANENT DAMAGE TO THE VEHICLE.

PARTS REQUIRED (NOT INCLUDED) |

1x **FLASH LINK UPDATER,**
1x **FLASH LINK MANAGER**
SOFTWARE | PROGRAMME
1x Microsoft Windows Computer with Internet connection

OR

1x **FLASH LINK MOBILE**
1x **FLASH LINK MOBILE APP**
Smartphone *Android* or *iOS* with Internet connection (*provider charges may apply*).

MANDATORY

HOOD PIN



REMOTE START SAFETY OVERRIDE SWITCH

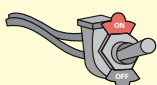







VALET SWITCH

Part #: RSPB available, Sold separately.

Notice: the installation of safety elements are mandatory. The hood pin and the valet switch are essential security elements and must be installed.

STAND ALONE CONFIGURATION |

	Program bypass option	UNIT OPTION	DESCRIPTION
	OEM Remote Stand Alone Remote Starter:	D1.10 	By default, LOCK, LOCK, LOCK
		D1.1 	Par défaut, VERROUILLE,VERROUILLE,VERROUILLE
	Program bypass option with oem remote:	C1	OEM Remote Monitoring
			télécommande d'origine
	Program bypass option with RF KIT antenna:	H1 to H6	Supported RF Kits and select RF Kit
	Program bypass option Vehicle hybrid only:	D4	Hybrid mode (Vehicle hybrid only)

REMOTE STARTER FUNCTIONALITY |



All doors must be closed.

3X 

Press the OEM remote's Lock button 3x to remote-start (or remote-stop) the vehicle.



START 

The vehicle will START.

REMOTE STARTER DIAGNOSTICS

MODULE RED LED

x2 flash : Brake ON

x3 flash : No tach

x4 flash : Ignition before start

x5 flash : Hood Open

REMOTE STARTER WARNING CARD |



CUT THIS WARNING CARD AND STICK IT ON A VISIBLE PLACE:
or use the package RSPB, Sold separately.

WARNING



REMOTE STARTER

THE VEHICLE CAN BE STARTED BY EITHER: PRESSING THE LOCK BUTTON ON THE OEM REMOTE 3 TIMES CONSECUTIVELY OR BY A SMARTPHONE. **TURN ON** THE SAFETY SWITCH LOCATED UNDER THE DASHBOARD BEFORE WORKING ON THE VEHICLE.

DESCRIPTION |

	Parts required (Not included)	PAGE
--	-------------------------------	------

WIRE TO WIRE DIAGRAM

AUTOMATIC TRANSMISSION	1x 7.5 Amp. fuse	Page 3
------------------------	------------------	--------

THARNESSE DIAGRAM

THARNESSE THAR-FOR3 AUTOMATIC TRANSMISSION	1x THAR-FOR3	Page 4
--	--------------	--------

EXPÉDITION



② Parking Lights switch

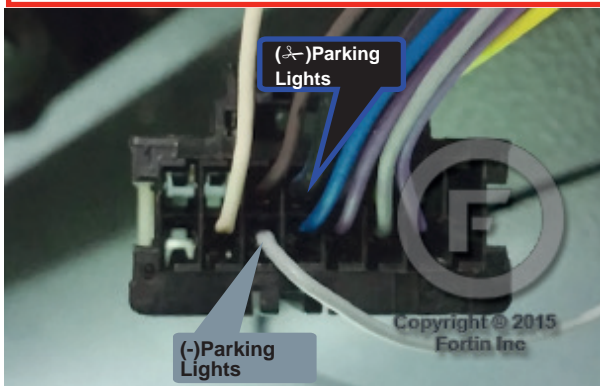

① Gateway module, Behind OBD-II connector

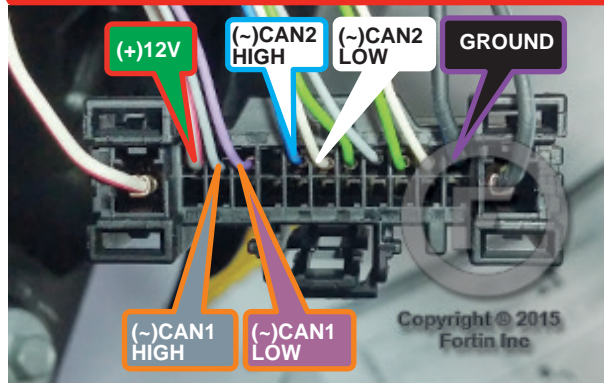

AUTOMATIC TRANSMISSION WIRING CONNECTION |

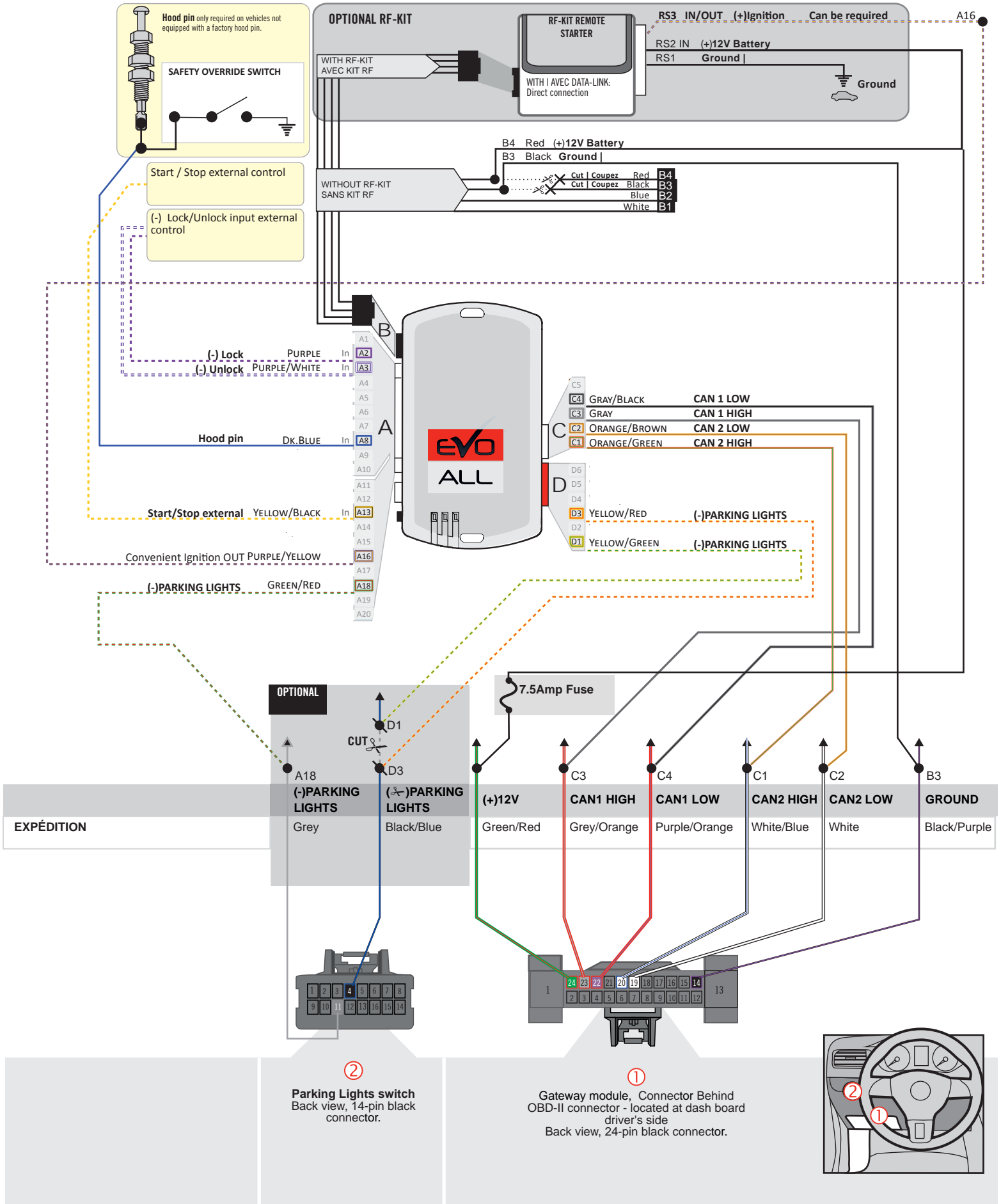

THAR-FOR3 | T-HARNESS - AUTOMATIC TRANSMISSION |

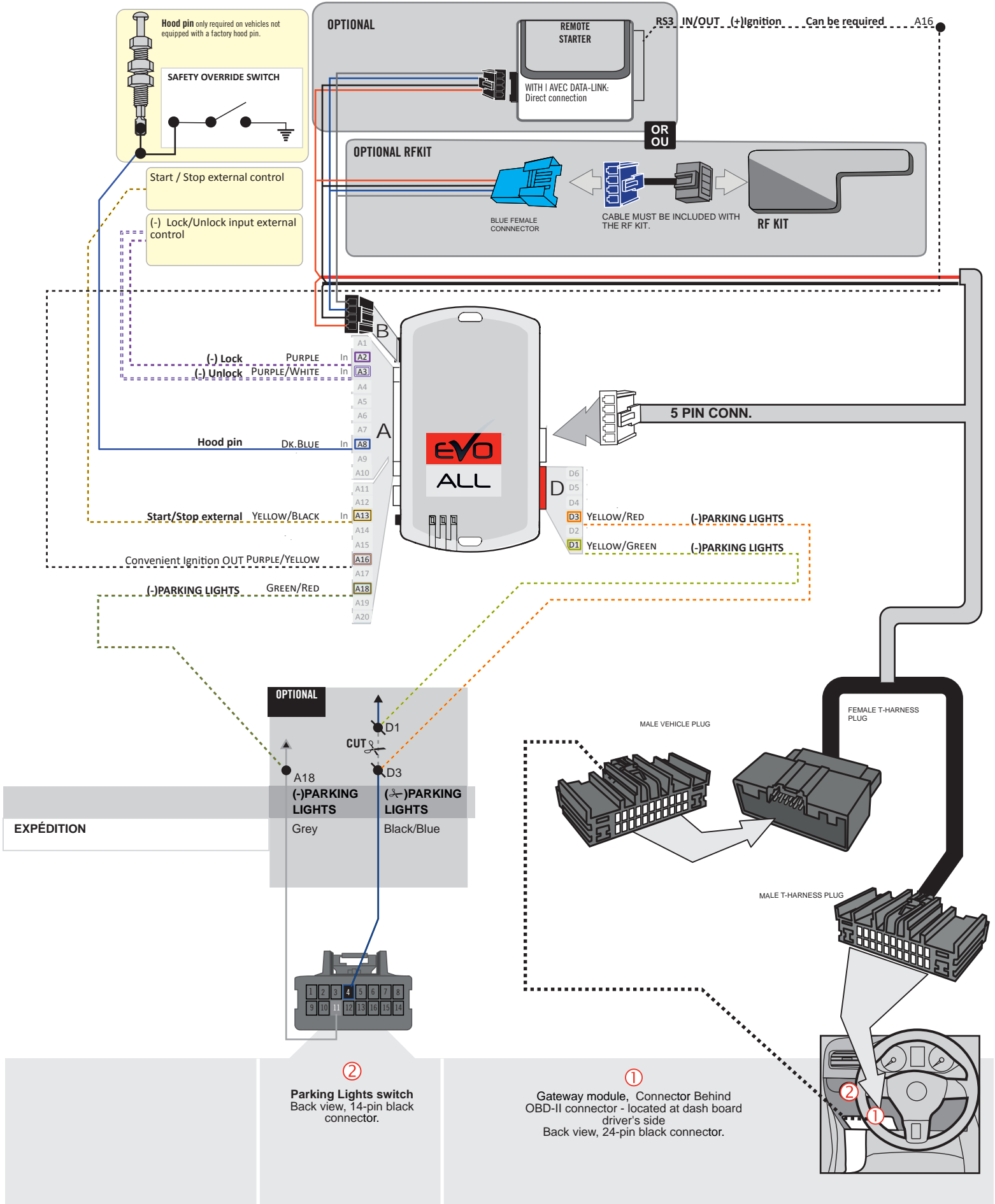



Parts required (not included)

- 1x FLASH LINK UPDATER, SOFTWARE | PROGRAMME
- 1x FLASH LINK MANAGER
- 1x Microsoft Windows Computer with Internet connection

OR

- 1x FLASH LINK MOBILE
- 1x FLASH LINK MOBILE APP
- Smartphone Android or iOS with Internet connection (Internet provider charges may apply)

BEFORE PROGRAMMING SET THE UNIT OPTIONS AND SAVE.

1

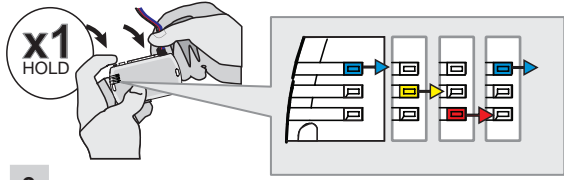

Press and hold the programming button:
Insert the 4-Pin (Data-Link) connector.

↳ The Blue, Red, Yellow and Blue & Red LEDs will alternatively illuminate.

2

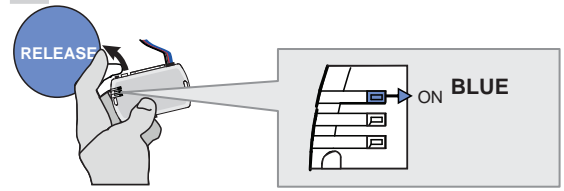

Release the programming button when the LED is BLUE.

If the LED is not solid BLUE disconnect the 4-Pin connector (Data-Link) and go back to step 1.

3

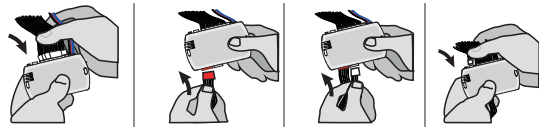

Insert the required remaining connectors.

4

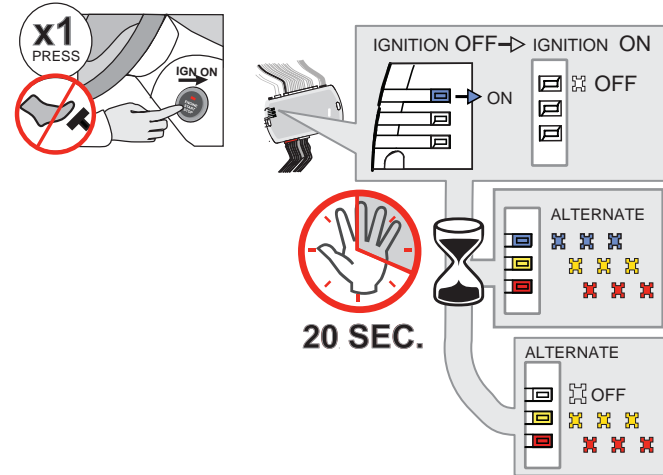

Do not press the brake pedal.
Press the Push-to-Start button once to turn on the ignition.

↳ The BLUE LED will turn OFF.

↳ The BLUE, YELLOW and RED LEDs will alternate.

Wait, at least 20 seconds, do not disconnect the modules or turn off the ignition.

↳ The RED and YELLOW LEDs will alternate.

Make sure that the DELs are flashing RED and YELLOW before continuing programming.

5

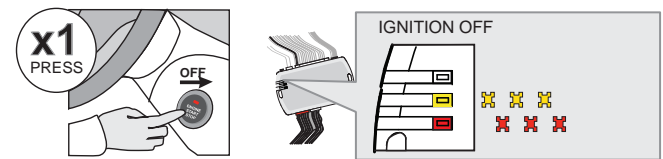

Press the Push-to-Start button once to turn off the ignition.

↳ The RED and YELLOW LEDs alternate.

KEY BYPASS PROGRAMMING PROCEDURE 2/2 |

6

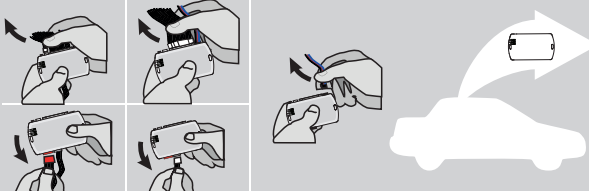

Disconnect all the connectors and after the Data-Link (4-pins) connector.

7



Microsoft Windows Computer with Internet connection*

FLASH LINK UPDATER* **FLASH LINK MANAGER***
SOFTWARE | PROGRAMME

OR

Smartphone* (Internet provider charges may apply)

VEHICLE'S OBDII CONNECTOR **FLASH LINK MOBILE***

Use the tool: FLASH LINK UPDATER or FLASH LINK MOBILE to visit the DCryptor menu.

*Parts required (not included)

8

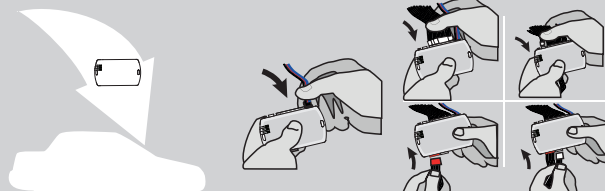

AFTER DCRYPTOR PROGRAMMING COMPLETED
Go back to the vehicle and reconnect the 4-Pin (Data-Link) connector and after, all the remaining connector.

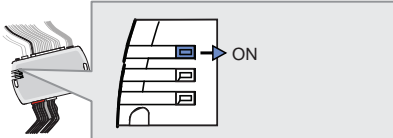

↳ The BLUE LED will turn ON.

9

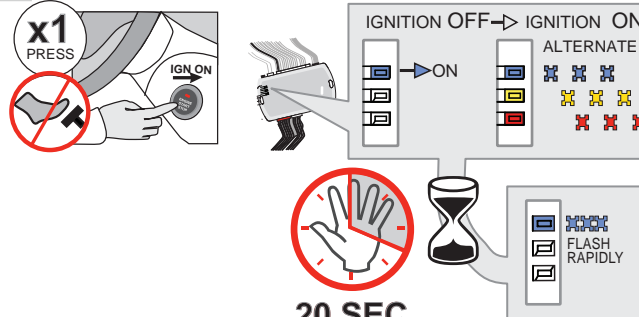

x1 PRESS (with a red 'X' over the push-to-start button)

IGNITION OFF → IGNITION ON

ALTERNATE

↳ The RED and YELLOW LEDs will turn ON.

Wait, at least 20 seconds, do not disconnect the modules or turn off the ignition.

↳ The BLUE LED will flash rapidly.

20 SEC.

FLASH RAPIDLY

10

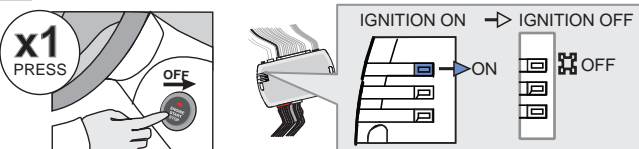

x1 PRESS (with a red 'X' over the push-to-start button)

IGNITION ON → IGNITION OFF

↳ The BLUE will turn OFF.



The module is now programmed.

OPTIONAL RF-KIT PROGRAMMING |

PROGRAM BYPASS OPTION



Program bypass option:

H2

Supported RF-KITS enable

H2 Fortin 2

OPTIONAL FORTIN RF KIT SERIES 4 OR SERIES 9 PROGRAMMING



The module must be programmed on the vehicle.







MAKE SURE THE IGNITION KEY HAS BEEN IN THE OFF POSITION FOR AT LEAST 5 SECONDS.

<p>1</p> <p>ON x1 PRESS</p> <p>Do not press the brake pedal. Press the Push-to-Start button once to turn on the ignition.</p>	<p>2</p> <p>OFF x1 PRESS</p> <p>Press the Push-to-Start button once to turn off the ignition.</p>	<p>3</p> <p>ON x1 PRESS</p> <p>Do not press the brake pedal. Press the Push-to-Start button once to turn on the ignition.</p>	<p>4</p> <p>4X BRAKES</p> <p>x4 PRESS</p> <p>Press and release the brake pedal four times.</p>	<p>5</p> <p>ON EACH TRANSMITTER</p> <p>4 BUTTONS</p> <p>[-] PRESS AND RELEASE</p> <p>→ PRESS AND RELEASE</p> <p>1 BUTTON</p> <p>PRESS APPROX. 12 SEC. AND WAIT FOR THE BLUE LED TO TURN OFF THEN BACK ON SOLID THEN RELEASE.</p>	<p>6</p> <p>OFF x1 PRESS</p> <p>Press the Push-to-Start button once to turn off the ignition.</p>	<p>7</p> <p>ON x1 PRESS</p> <p>Do not press the brake pedal. Press the Push-to-Start button once to turn on the ignition and leave it ON for 5 sec..</p>	<p>8</p> <p>OFF x1 PRESS</p> <p>Press the Push-to-Start button once to turn off the ignition.</p>
<p>The YELLOW LED will turn ON solid.</p>	<p>The YELLOW LED will turn Off.</p>	<p>The LED will turn ON solide.</p> <p>The YELLOW LED will turn ON solid.</p>	<p>The LED will flash rapidly.</p> <p>The LED will turn off each time.</p>	<p>The LED will flash rapidly.</p> <p>The LED will turn off each time.</p>	<p>The LED will turn Off.</p>	<p>The LED will turn Off.</p> <p>The YELLOW LED will turn ON solid.</p>	<p>The LED will turn Off.</p>
<p>The YELLOW LED will turn ON solid.</p>	<p>The YELLOW LED will turn Off.</p>	<p>The YELLOW LED will turn ON solid.</p>	<p>The 3 LED will turn ON solid.</p>	<p>The 3 LED will flash rapidly.</p> <p>The 3 LED will turn off each time.</p>	<p>The 3 LED will turn Off.</p>	<p>The YELLOW LED will turn ON solid.</p>	<p>The YELLOW LED will turn Off.</p>

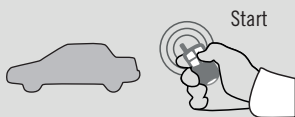

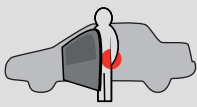
REMOTE STARTER FUNCTIONALITY |

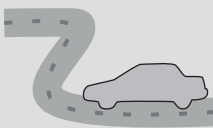
 <p>Start</p> <p>All doors must be closed.</p> <p>Remote start the vehicle.</p>	 <p>UNLOCK</p> <p>Unlock the doors with either:</p> <ul style="list-style-type: none"> • The OEM remote • The remote-starter remote • Or the proximity remote 	 <p>Enter the vehicle with the SMART-KEY.</p>	 <p>DO NOT PRESS THE BRAKE PEDAL.</p> <p>Press and release the Push-to-Start button once.</p>	 <p>Press the brake pedal. The vehicle can now be put in to gear and driven.</p> <p>If the Smart-Key is not detected the vehicle will shut down.</p>
--	---	--	---	---

STANDALONE & THAR-FOR3 INSTALLATION

ADDENDUM - SUGGESTED WIRING CONFIGURATION



ONLY COMPATIBLE WITH AUTOMATIC TRANSMISSION VEHICLES.

VEHICLE	YEARS	Vehicle functions supported in this diagram (functional if equipped)																
		Immobilizer bypass	Lock	Unlock	Armn	Disarm	RAP Disable	Parking Lights***	Tachometer	Heated seats**	Heated Mirrors**	Rear defrost	Door Status	Trunk Status	Hood Status*	Hand-Brake Status	Foot-Brake Status	Active OEM Remote Start
FORD Explorer	Key 2020	•	•	•	•	•	•	•	•	•	•	•	•	•	•	•	•	•

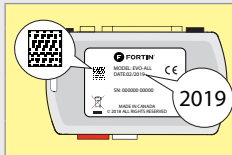

COMPATIBLE MODULE REQUIRED:

QR CODE ON THE LABEL
MANUFACTURED AFTER: 2019

FIRMWARE VERSION

58.[02]
MINIMUM

To add the firmware version and the options, use the **FLASH LINK UPDATER** or **FLASH LINK MOBILE** tool, sold separately.



Program bypass option:

UNIT OPTION

C1

DESCRIPTION

OEM Remote status (Lock/Unlock) monitoring

IF THE VEHICLE IS NOT EQUIPPED WITH FUNCTIONAL HOOD PIN:

A11

OFF

Hood trigger (Output Status).

NOTES

The vehicles OEM remote and SmartKey are still operable during remote start.

**Heated seats The heated seats and rear defrost activate automatically when it cold.

***Parking Lights The parking Lights at remote start only.



The vehicle must be equipped with the OEM remote with the door locks.

MANDATORY INSTALL

*HOOD PIN



HOOD STATUS: THE HOOD PIN SWITCH MUST BE INSTALLED IF THE VEHICLE CAN BE REMOTE STARTED WITH THE HOOD OPEN, SET FUNCTION A11 TO OFF.

A11

OFF

Notice: the installation of safety elements are mandatory. The hood pin is an essential security element and must be installed.

THIS MODULE MUST BE INSTALLED BY A QUALIFIED TECHNICIAN. A WRONG CONNECTION CAN CAUSE PERMANENT DAMAGE TO THE VEHICLE.

PARTS REQUIRED (NOT INCLUDED)

1x **FLASH LINK UPDATER,**
1x **FLASH LINK MANAGER**
SOFTWARE | PROGRAMME
1x Microsoft Windows Computer with Internet connection

OR

1x **FLASH LINK MOBILE**
1x **FLASH LINK MOBILE APP**
Smartphone *Android* or *iOS* with Internet connection (*provider charges may apply*).

MANDATORY

HOOD PIN



REMOTE START SAFETY OVERRIDE SWITCH

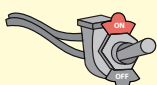







VALET SWITCH

Part #: RSPB available, Sold separately.

Notice: the installation of safety elements are mandatory. The hood pin and the valet switch are essential security elements and must be installed.

STAND ALONE CONFIGURATION

	Program bypass option	UNIT OPTION	DESCRIPTION
	OEM Remote Stand Alone Remote Starter:	D1.10 	By default, LOCK, LOCK, LOCK
		D1.1 	Par défaut, VERROUILLE,VERROUILLE,VERROUILLE
	Program bypass option with oem remote:	C1	OEM Remote Monitoring
	Program bypass option with RF KIT antenna:	H1 to H6	Supported RF Kits and select RF Kit
	Program bypass option Vehicle hybrid only:	D4	Hybrid mode (Vehicle hybrid only)

REMOTE STARTER FUNCTIONALITY



All doors must be closed.

3X 

Press the OEM remote's Lock button 3x to remote-start (or remote-stop) the vehicle.



START 

The vehicle will START.

REMOTE STARTER DIAGNOSTICS
MODULE RED LED

x2 flash :	Brake ON
x3 flash :	No tach
x4 flash :	Ignition before start
x5 flash :	Hood Open

REMOTE STARTER WARNING CARD



CUT THIS WARNING CARD AND STICK IT ON A VISIBLE PLACE:
or use the package **RSPB**, Sold separately.

WARNING | ATTENTION



REMOTE STARTER

THE VEHICLE CAN BE STARTED BY EITHER: PRESSING THE LOCK BUTTON ON THE OEM REMOTE 3 TIMES CONSECUTIVELY OR BY A SMARTPHONE. **TURN ON** THE SAFETY SWITCH LOCATED UNDER THE DASHBOARD BEFORE WORKING ON THE VEHICLE.

DESCRIPTION

	Parts required (Not included)	PAGE
--	-------------------------------	------

WIRE TO WIRE DIAGRAM

AUTOMATIC TRANSMISSION	1x 7.5 Amp. fuse	Page 3
------------------------	------------------	--------

THARNES DIAGRAM

THARNES THAR-FOR3 AUTOMATIC TRANSMISSION	1x THAR-FOR3	Page 4
--	--------------	--------

① Gateway module, located at dash board driver's side,

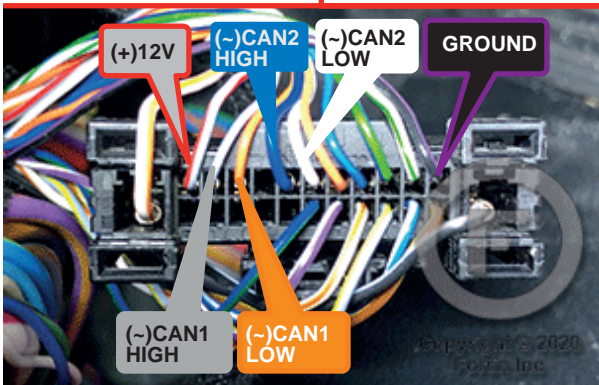

② Fuse box

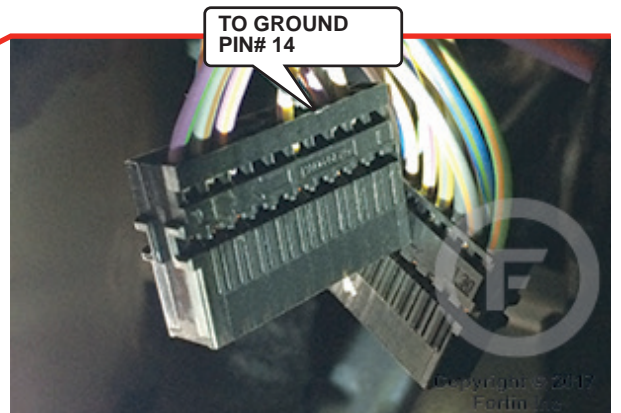
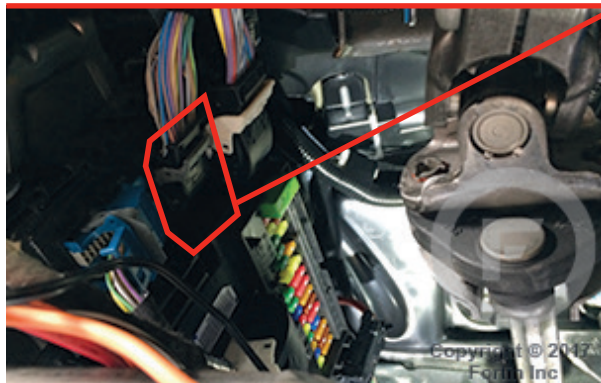

AUTOMATIC TRANSMISSION WIRING CONNECTION |

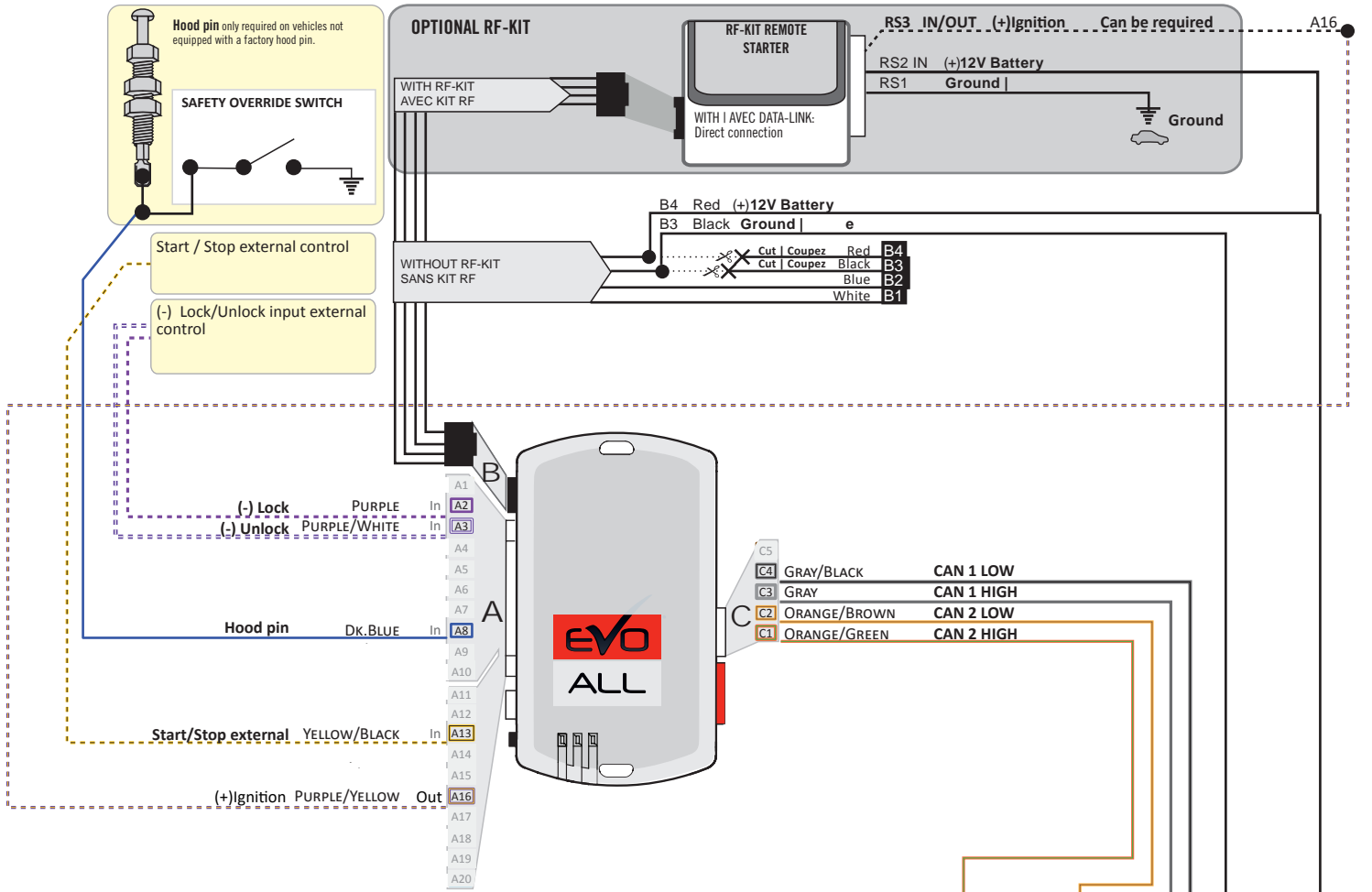

EXPLORER

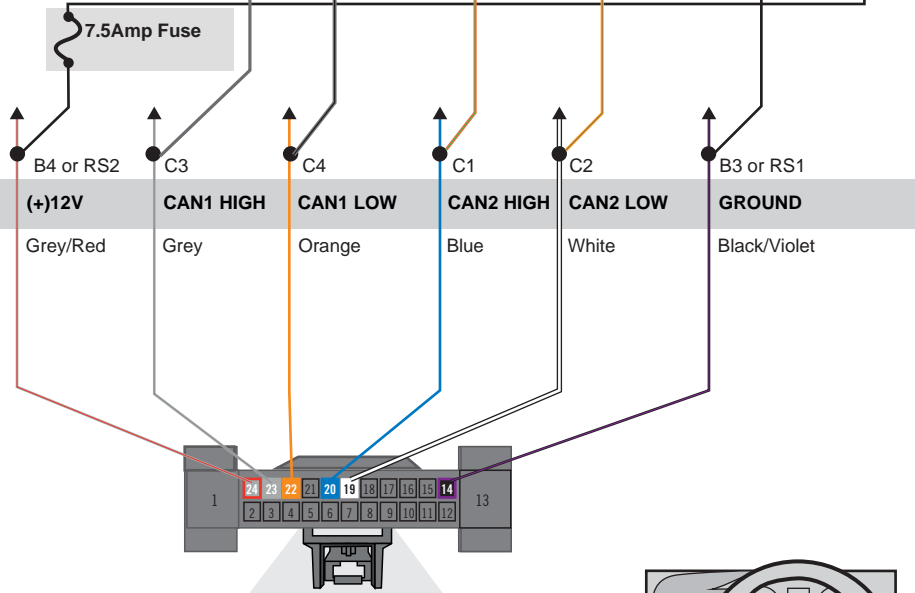
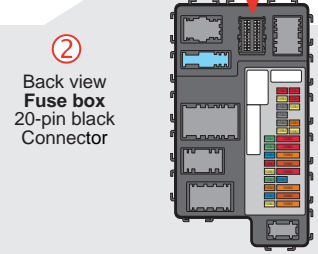
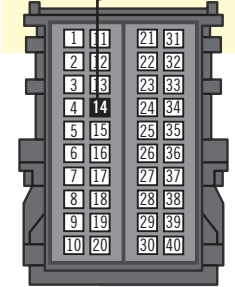
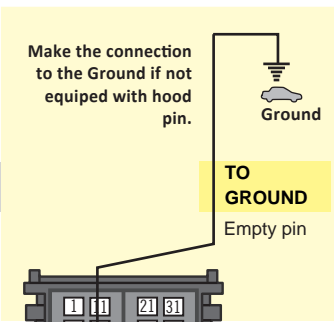

① Gateway module, Behind OBD-II connector - located at dash board driver's side - Back view, 24-pin black connector.

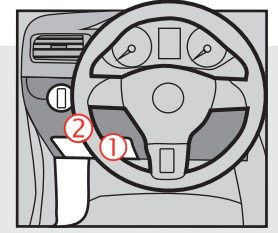

THAR-FOR3 | T-HARNESS - AUTOMATIC TRANSMISSION |

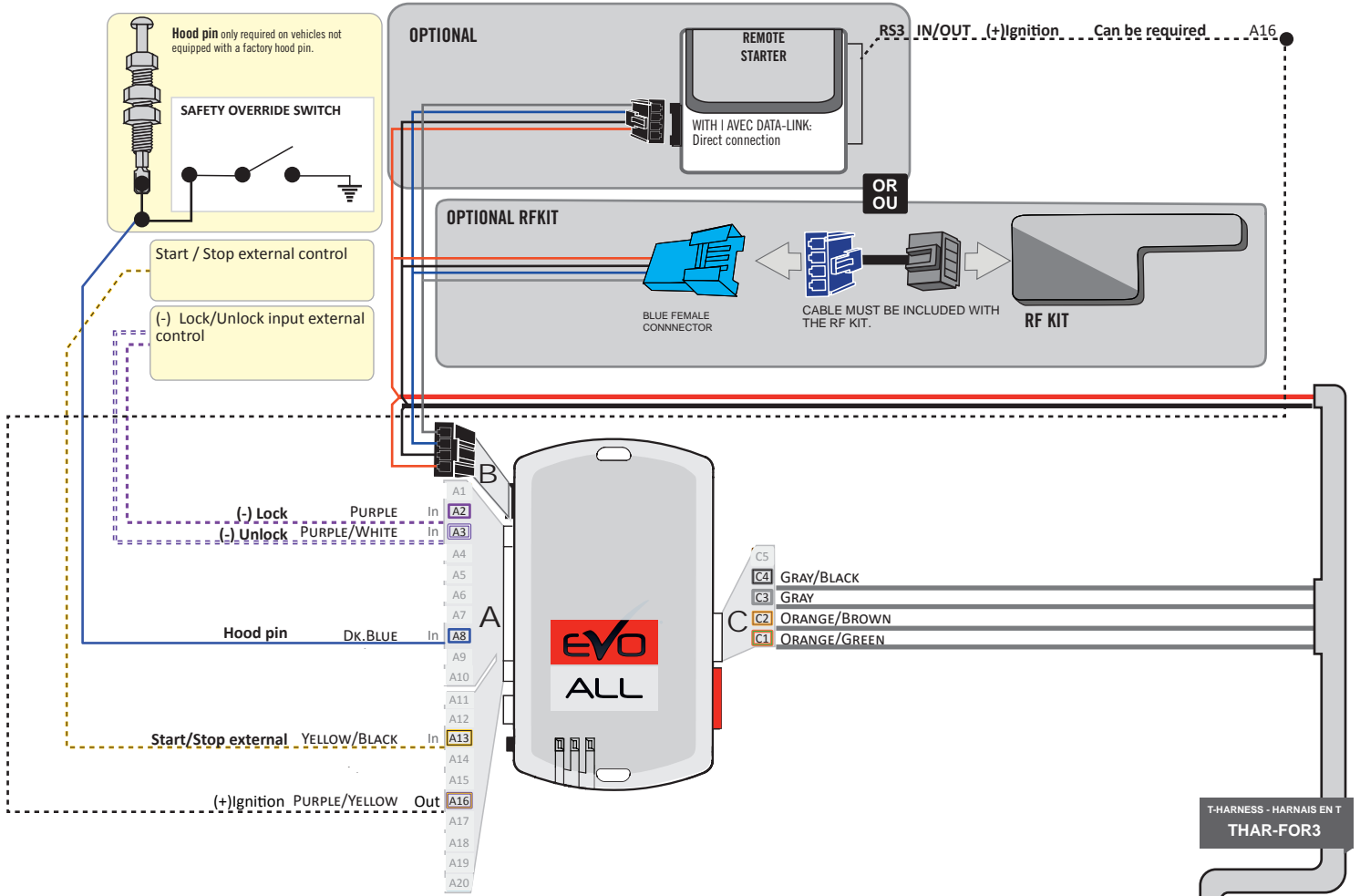

EXPLORER

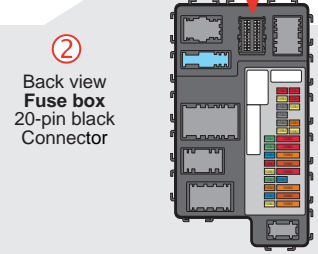
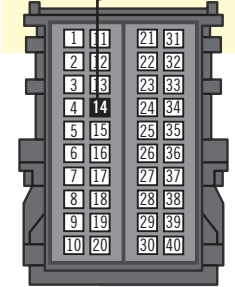
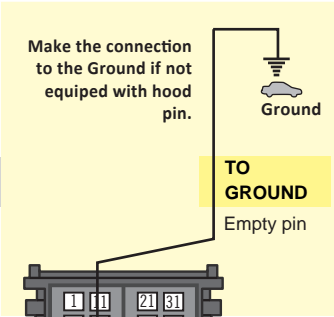

2 Back view Fuse box 20-pin black Connector

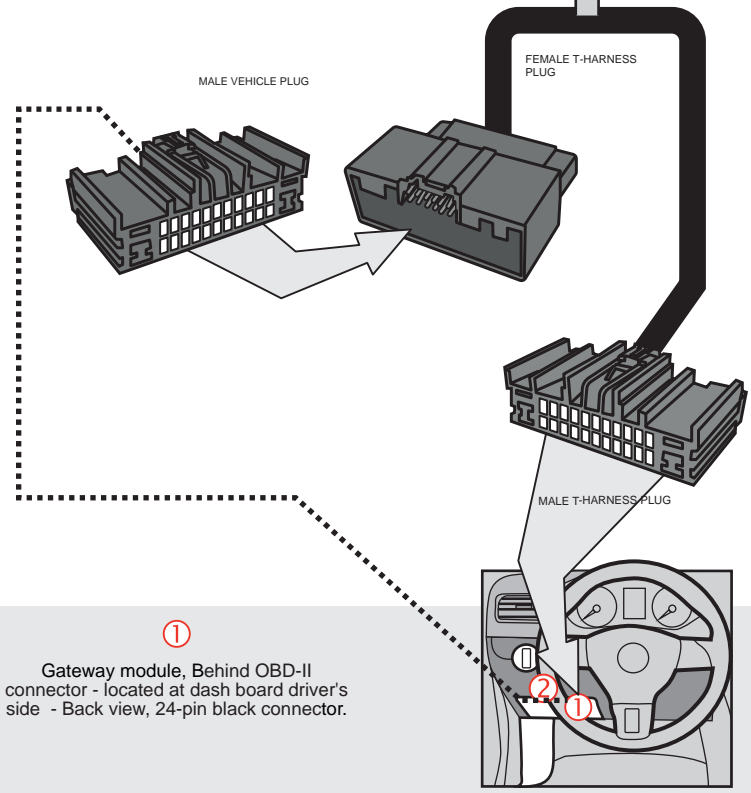

1 Gateway module, Behind OBD-II connector - located at dash board driver's side - Back view, 24-pin black connector.

T-HARNESS - HARNAIS EN T THAR-FOR3



Parts required (not included)

- 1x **FLASH LINK UPDATER,**
- 1x **FLASH LINK MANAGER**
SOFTWARE | PROGRAMME
- 1x Microsoft Windows Computer with Internet connection

OR

- 1x **FLASH LINK MOBILE**
- 1x **FLASH LINK MOBILE APP**
- Smartphone *Android* or *iOS* with Internet connection
(Internet provider charges may apply)

BEFORE PROGRAMMING SET THE UNIT OPTIONS AND SAVE.

1

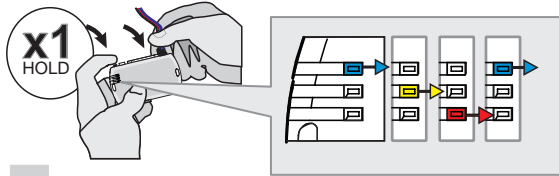

Press and hold the programming button:
Insert the 4-Pin (Data-Link) connector.

↳ The Blue, Red, Yellow and Blue & Red LEDs will alternatively illuminate.

2

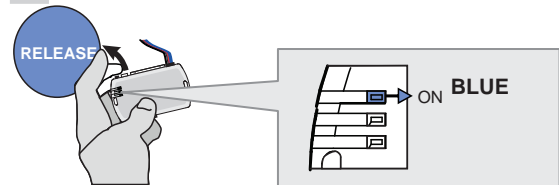

Release the programming button when the LED is BLUE.

If the LED is not solid BLUE disconnect the 4-Pin connector (Data-Link) and go back to step 1.

3

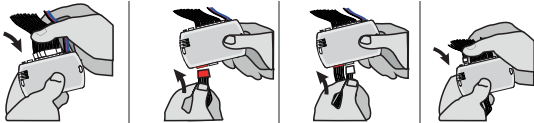

Insert the required remaining connectors.

4

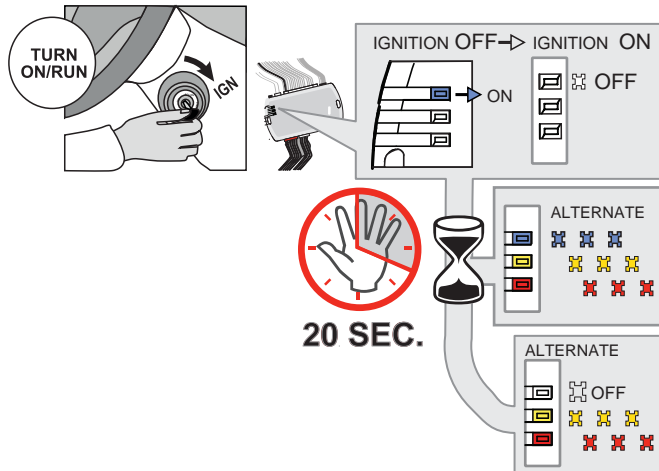

Turn the key to the Ignition ON/RUN position.

↳ The BLUE LED will turn OFF.

↳ The BLUE, YELLOW and RED LEDs will alternated.

Wait, at least 20 seconds, do not disconnect the modules or turn off the ignition.

↳ The RED and YELLOW LEDs will alternated.

Make sure that the DELs are flashing RED and YELLOW before continuing programming.

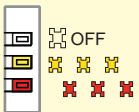

5

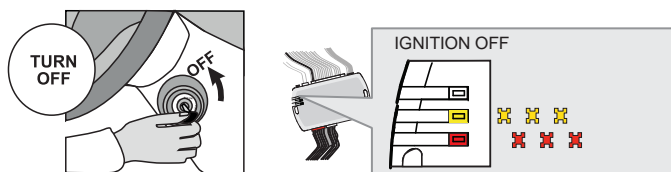

Turn the key to the OFF position.

↳ The RED and YELLOW LEDs alternate.

KEY BYPASS PROGRAMMING PROCEDURE 2/2 |

6

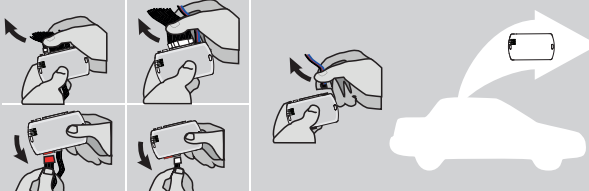

Disconnect all the connectors and after the Data-Link (4-pins) connector.

7



Microsoft Windows Computer with Internet connection*

FLASH LINK UPDATER* **FLASH LINK MANAGER***
SOFTWARE | PROGRAMME

OR

Smartphone* (Internet provider charges may apply)

VEHICLE'S OBDII CONNECTOR **FLASH LINK MOBILE***

Use the tool: FLASH LINK UPDATER or FLASH LINK MOBILE to visit the DCRYPTOR menu.

*Parts required (not included)

8

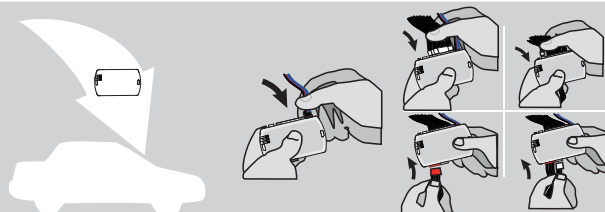

AFTER DCRYPTOR PROGRAMMING COMPLETED
Go back to the vehicle and reconnect the 4-Pin (Data-Link) connector and after, all the remaining connector.



↳ The BLUE LED will turn ON.

9

TURN ON/RUN

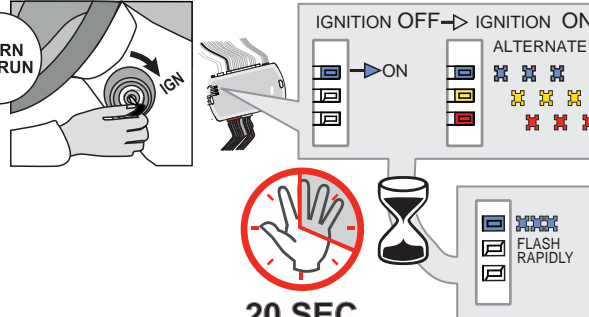

IGNITION OFF → IGNITION ON

ALTERNATE

↳ The RED and YELLOW LEDs will turn ON.

Wait, at least 20 seconds, do not disconnect the modules or turn off the ignition.

↳ The BLUE LED will flash rapidly.

20 SEC.

FLASH RAPIDLY

10

TURN OFF

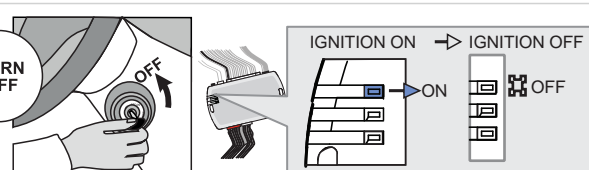

IGNITION ON → IGNITION OFF

↳ The BLUE will turn OFF.



The module is now programmed.

OPTIONAL RF-KIT PROGRAMMING |

PROGRAM BYPASS OPTION







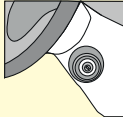











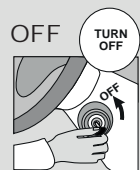

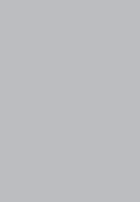
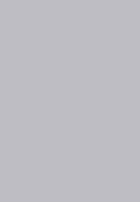
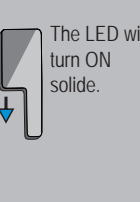
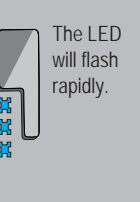
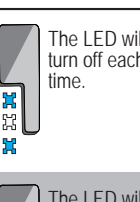
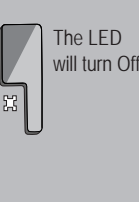
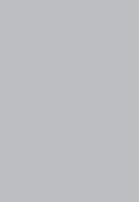
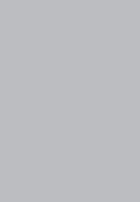
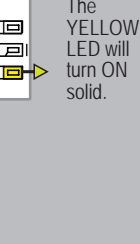
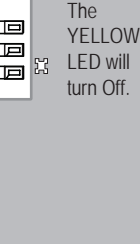
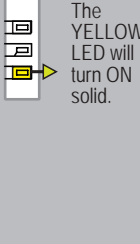
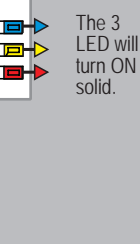
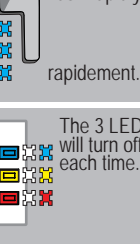
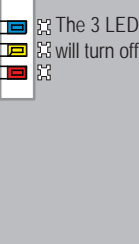
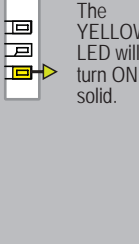
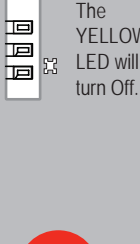





















	<p>Program bypass option:</p>	<p>H2</p>	<p><input checked="" type="checkbox"/> Supported RF-KITS enable <input checked="" type="checkbox"/> H2 Fortin 2</p>
---	-------------------------------	------------------	---

OPTIONAL FORTIN RF KIT SERIES 4 OR SERIES 9 PROGRAMMING

The module must be programmed on the vehicle.

MAKE SURE THE IGNITION KEY HAS BEEN IN THE OFF POSITION FOR AT LEAST 5 SECONDS.

<p>1</p>  <p>ON TURN ON/RUN</p>	<p>2</p>  <p>OFF TURN OFF</p>	<p>3</p>  <p>ON TURN ON/RUN</p>	<p>4</p>  <p>4X BRAKES X4 PRESS</p>	<p>5</p> <p>ON EACH TRANSMITTER</p> <p>4 BUTTONS</p>  <p>PRESS AND RELEASE</p>  <p>PRESS AND RELEASE</p> <p>1 BUTTON</p>  <p>PRESS APPROX. 12 SEC. AND WAIT FOR THE BLUE LED TO TURN OFF THEN BACK ON SOLID THEN RELEASE.</p>	<p>6</p>  <p>OFF TURN OFF</p>	<p>7</p>  <p>ON TURN ON/RUN</p>	<p>8</p>  <p>OFF TURN OFF</p>
<p>Turn the key to the ON/RUN position.</p>	<p>Turn the ignition to the OFF position.</p>	<p>Turn the key to the ON/RUN position.</p>	<p>Press and release the brake pedal four times.</p>	<p>The LED will turn off each time.</p>	<p>Turn the ignition to the OFF position.</p>	<p>Turn the key to the ON/RUN position and leave it ON for 5 sec.</p> 	<p>Turn the ignition to the OFF position.</p>
 <p>The YELLOW LED will turn ON solid.</p>	 <p>The YELLOW LED will turn Off.</p>	 <p>The LED will turn ON solide.</p>	 <p>The LED will flash rapidly.</p>	 <p>The LED will turn off each time.</p>	 <p>The LED will turn Off.</p>	 <p>The LED will turn ON solid.</p>	 <p>The LED will turn Off.</p>
 <p>The YELLOW LED will turn ON solid.</p>	 <p>The YELLOW LED will turn Off.</p>	 <p>The YELLOW LED will turn ON solid.</p>	 <p>The 3 LED will turn ON solid.</p>	 <p>The LED will flash rapidly.</p>	 <p>The LED will flash rapidly.</p>	 <p>The 3 LED will turn off.</p>	 <p>The YELLOW LED will turn ON solid.</p>
 <p>The YELLOW LED will turn ON solid.</p>	 <p>The YELLOW LED will turn Off.</p>	 <p>The YELLOW LED will turn ON solid.</p>	 <p>The 3 LED will turn ON solid.</p>	 <p>The LED will flash rapidly.</p>	 <p>The LED will flash rapidly.</p>	 <p>The 3 LED will turn off.</p>	 <p>The YELLOW LED will turn ON solid.</p>
 <p>The YELLOW LED will turn ON solid.</p>	 <p>The YELLOW LED will turn Off.</p>	 <p>The YELLOW LED will turn ON solid.</p>	 <p>The 3 LED will turn ON solid.</p>	 <p>The LED will flash rapidly.</p>	 <p>The LED will flash rapidly.</p>	 <p>The 3 LED will turn off.</p>	 <p>The YELLOW LED will turn ON solid.</p>
 <p>The YELLOW LED will turn ON solid.</p>	 <p>The YELLOW LED will turn Off.</p>	 <p>The YELLOW LED will turn ON solid.</p>	 <p>The 3 LED will turn ON solid.</p>	 <p>The LED will flash rapidly.</p>	 <p>The LED will flash rapidly.</p>	 <p>The 3 LED will turn off.</p>	 <p>The YELLOW LED will turn ON solid.</p>
 <p>The YELLOW LED will turn ON solid.</p>	 <p>The YELLOW LED will turn Off.</p>	 <p>The YELLOW LED will turn ON solid.</p>	 <p>The 3 LED will turn ON solid.</p>	 <p>The LED will flash rapidly.</p>	 <p>The LED will flash rapidly.</p>	 <p>The 3 LED will turn off.</p>	 <p>The YELLOW LED will turn ON solid.</p>



REMOTE STARTER FUNCTIONALITY |



All doors must be closed.



Remote start the vehicle.



Unlock the doors with the remote-starter remote or the OEM remote.



Insert and Turn the key to the Ignition ON/RUN position.



Press the brake pedal.



The vehicle can now be put in to gear and driven.

STANDALONE & THAR-FOR3 INSTALLATION

ADDENDUM - SUGGESTED WIRING CONFIGURATION



ONLY COMPATIBLE WITH AUTOMATIC TRANSMISSION VEHICLES.



Vehicle functions supported in this diagram (functional if equipped)

VEHICLE	YEARS	Immobilizer bypass	Lock	Unlock	Arm	Disarm	Heated Seats**	Rear Defrost**	RAP Disable	Parking Lights***	Tachometer	Door Status	Trunk Status	Hood Status*	Hand-Brake Status	Foot-Brake Status	Active OEM Remote Start
FORD Explorer	Push-to-Start 2020	•	•	•	•	•	•	•	•	•	•	•	•	•	•	•	•

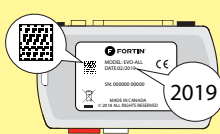

COMPATIBLE MODULE REQUIRED:

QR CODE ON THE LABEL
MANUFACTURED AFTER: 2019

FIRMWARE VERSION
58.[02]
MINIMUM

To add the firmware version and the options, use the **FLASH LINK UPDATER** or **FLASH LINK MOBILE** tool, sold separately.



Program bypass option:

UNIT OPTION

DESCRIPTION

C1

OEM Remote status (Lock/Unlock) monitoring

D6

Push-to-Start

IF THE VEHICLE IS NOT EQUIPPED WITH FUNCTIONAL HOOD PIN:

A11

OFF

Hood trigger (Output Status).

NOTES

The vehicles OEM remote and SmartKey are still operable during remote start.

**Heated seats The heated seats and rear defrost activate automatically when it cold.
**Rear Defrost

***Parking Lights The parking Lights at remote start only.

MANDATORY INSTALL

*HOOD PIN



HOOD STATUS: THE HOOD PIN SWITCH MUST BE INSTALLED IF THE VEHICLE CAN BE REMOTE STARTED WITH THE HOOD OPEN, SET FUNCTION A11 TO OFF.

A11

OFF

Notice: the installation of safety elements are mandatory. The hood pin is an essential security element and must be installed.

THIS MODULE MUST BE INSTALLED BY A QUALIFIED TECHNICIAN. A WRONG CONNECTION CAN CAUSE PERMANENT DAMAGE TO THE VEHICLE.

PARTS REQUIRED (NOT INCLUDED) |

1x **FLASH LINK UPDATER,**
 1x **FLASH LINK MANAGER**
SOFTWARE | PROGRAMME
 1x Microsoft Windows Computer with Internet connection

OR

1x **FLASH LINK MOBILE**
 1x **FLASH LINK MOBILE APP**
Smartphone Android or iOS with Internet connection (provider charges may apply).

MANDATORY

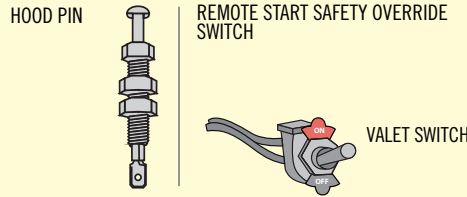

Part #: RSPB available, Sold separately.

Notice: the installation of safety elements are mandatory. The hood pin and the valet switch are essential security elements and must be installed.

STAND ALONE CONFIGURATION |

	Program bypass option	UNIT OPTION	DESCRIPTION
	OEM Remote Stand Alone Remote Starter:	D1.10	By default, LOCK, LOCK, LOCK
		D1.1	Par défaut, VERROUILLE,VERROUILLE,VERROUILLE
	Program bypass option with oem remote:	C1	OEM Remote Monitoring
	Program bypass option with RF KIT antenna:	H1 to H6	Supported RF Kits and select RF Kit
	Program bypass option Vehicle hybrid only:	D4	Hybrid mode (Vehicle hybrid only)

REMOTE STARTER FUNCTIONALITY |

All doors must be closed.

3X

Press the OEM remote's Lock button 3x to remote-start (or remote-stop) the vehicle.

The vehicle will START.

REMOTE STARTER DIAGNOSTICS

MODULE RED LED
x2 flash : Brake ON
x3 flash : No tach
x4 flash : Ignition before start
x5 flash : Hood Open

REMOTE STARTER WARNING CARD |

CUT THIS WARNING CARD AND STICK IT ON A VISIBLE PLACE:
 or use the package RSPB, Sold separately.

WARNING

REMOTE STARTER

THE VEHICLE CAN BE STARTED BY EITHER: PRESSING THE LOCK BUTTON ON THE OEM REMOTE 3 TIMES CONSECUTIVELY OR BY A SMARTPHONE. **TURN ON** THE SAFETY SWITCH LOCATED UNDER THE DASHBOARD BEFORE WORKING ON THE VEHICLE.

DESCRIPTION | DESCRIPTION

	Parts required (Not included)	PAGE
--	-------------------------------	------

WIRE TO WIRE DIAGRAM

AUTOMATIC TRANSMISSION	1x 7.5 Amp. fuse	Page 3
------------------------	------------------	--------

THARNES DIAGRAM

THARNES THAR-FOR3 AUTOMATIC TRANSMISSION	1x THAR-FOR3	Page 4
--	--------------	--------

① Gateway module, located at dash board driver's side,

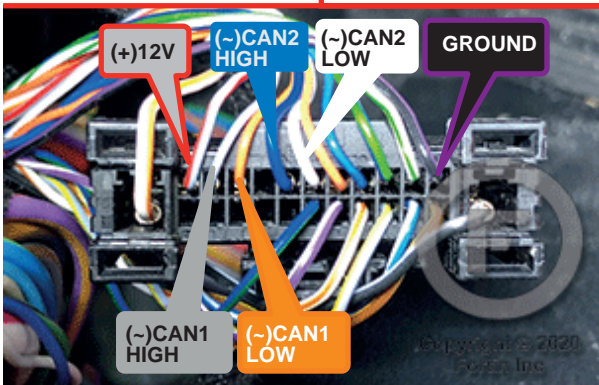

② Fuse box

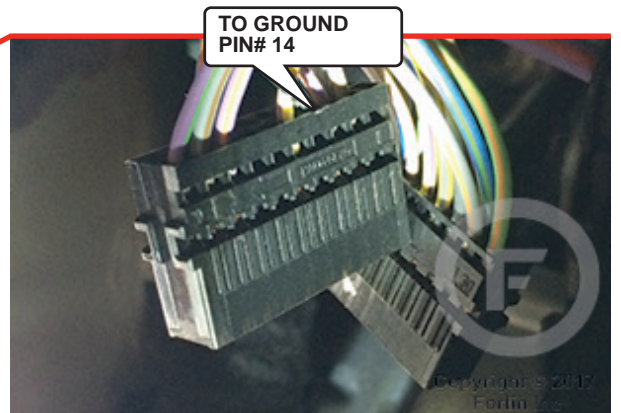
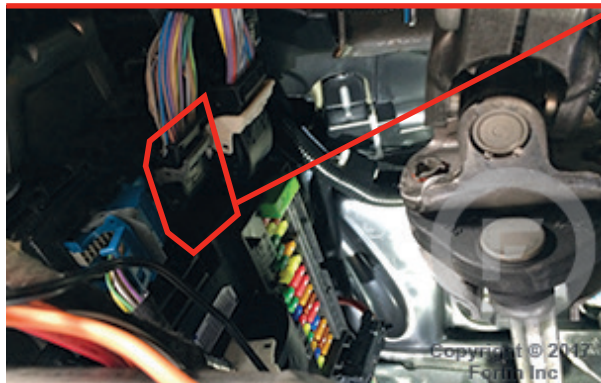

AUTOMATIC TRANSMISSION WIRING CONNECTION |

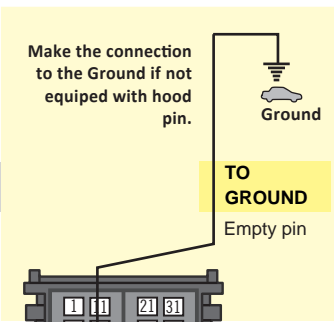
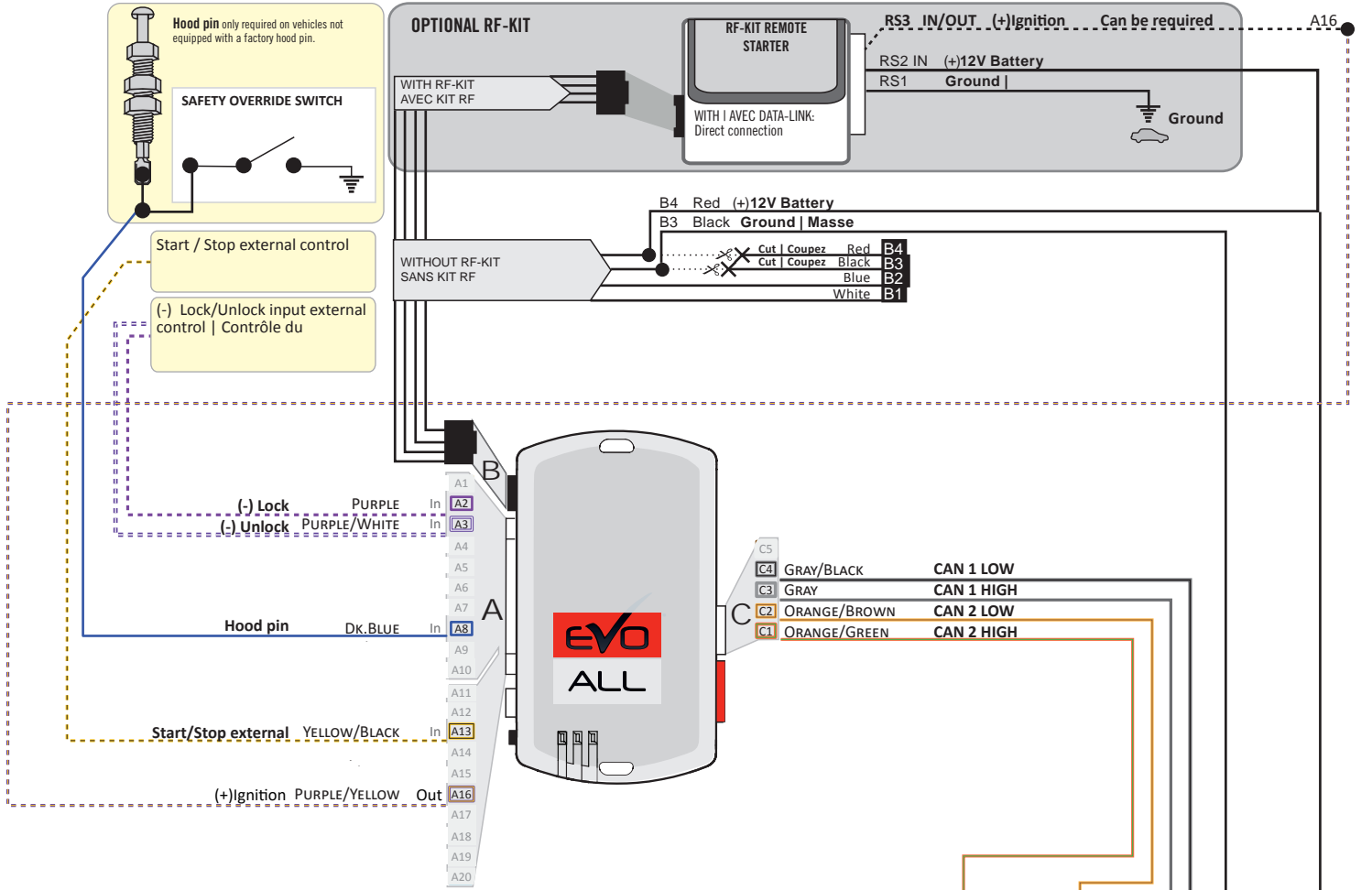

EXPLORER

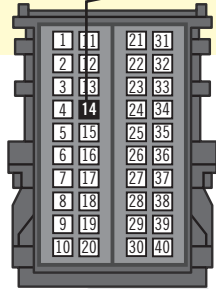

② Back view Fuse box 20-pin black Connector

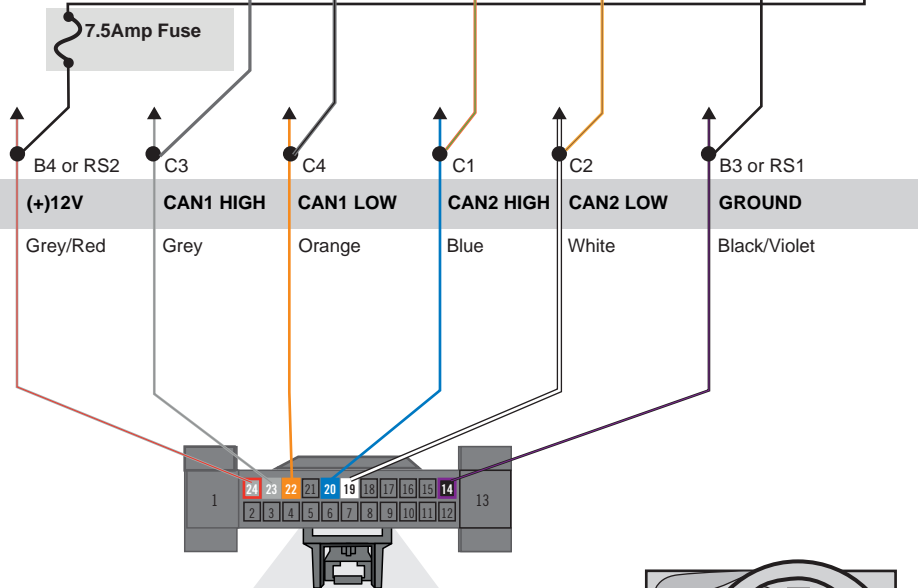
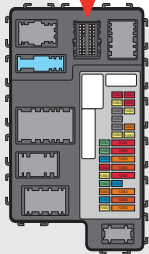

① Gateway module, Behind OBD-II connector - located at dash board driver's side - Back view, 24-pin black connector.

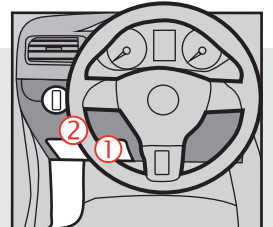

THAR-FOR3 | T-HARNESS - AUTOMATIC TRANSMISSION |

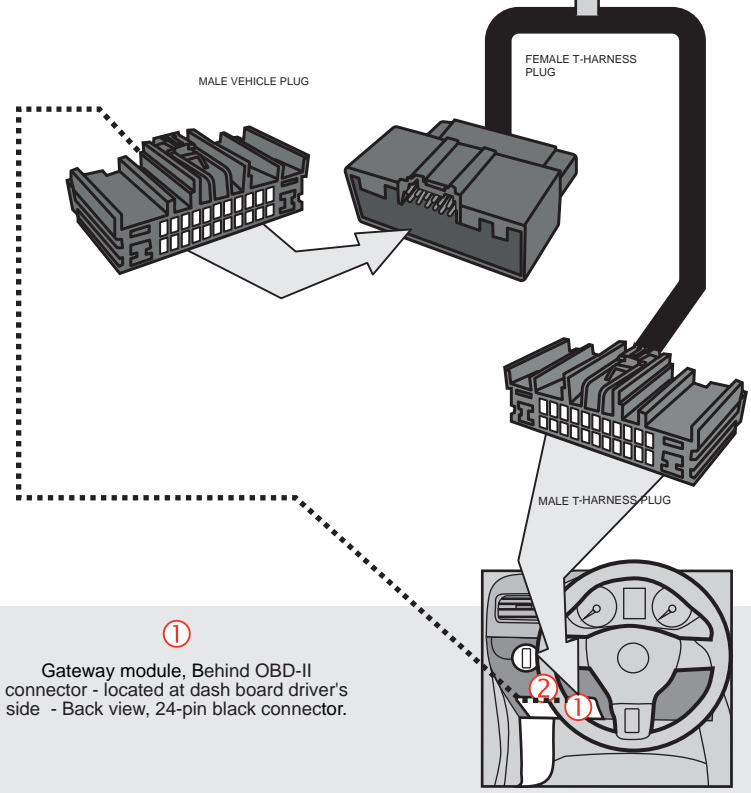
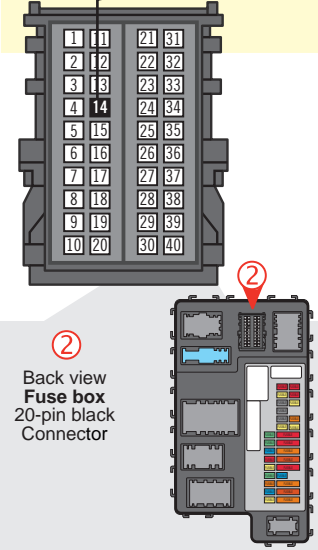
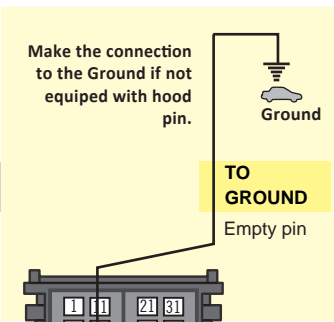
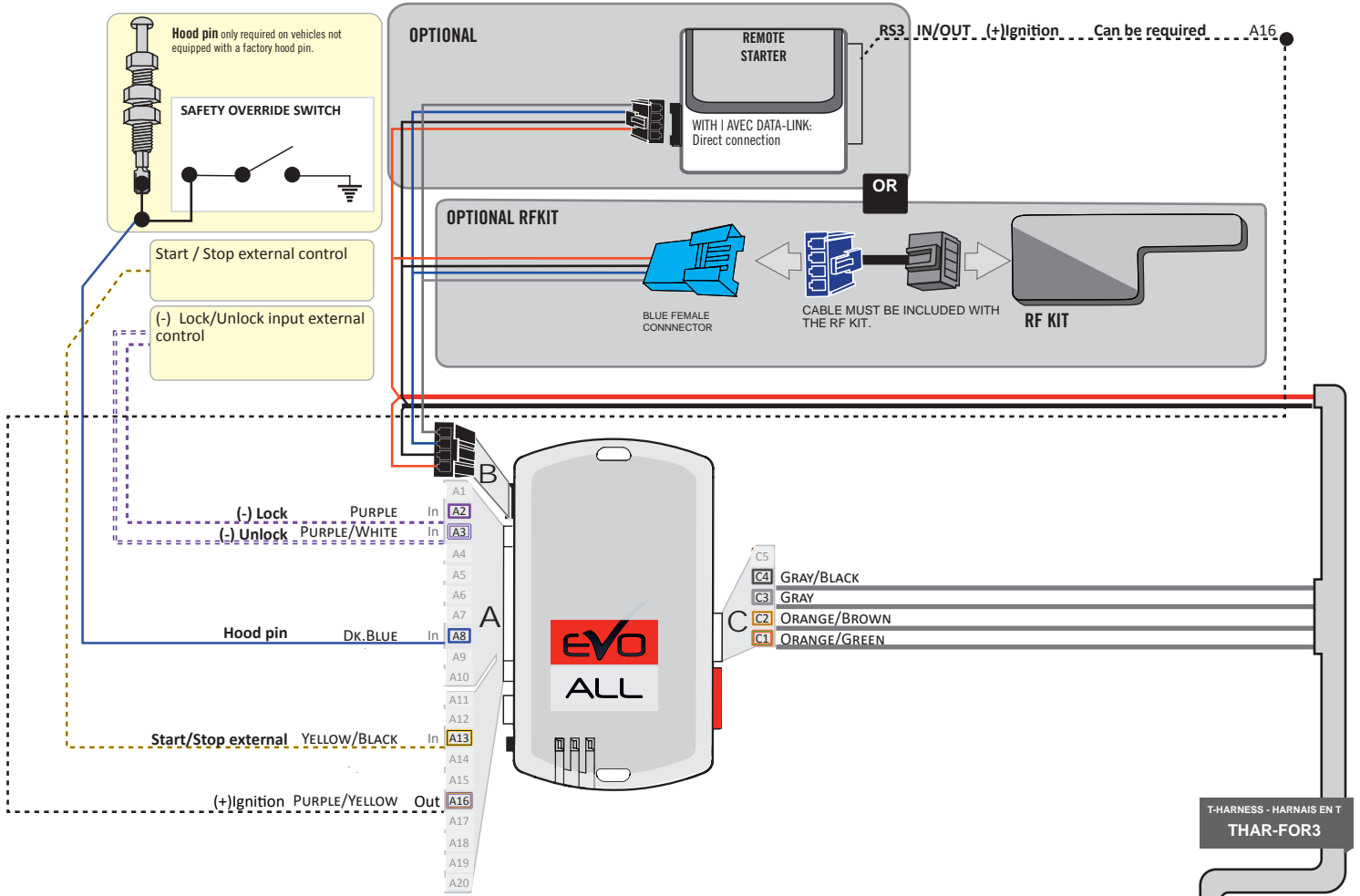



Parts required (not included)

- 1x FLASH LINK UPDATER, SOFTWARE | PROGRAMME
- 1x FLASH LINK MANAGER
- 1x Microsoft Windows Computer with Internet connection

OR

- 1x FLASH LINK MOBILE
- 1x FLASH LINK MOBILE APP
- Smartphone Android or iOS with Internet connection (Internet provider charges may apply)

BEFORE PROGRAMMING SET THE UNIT OPTIONS AND SAVE.

1

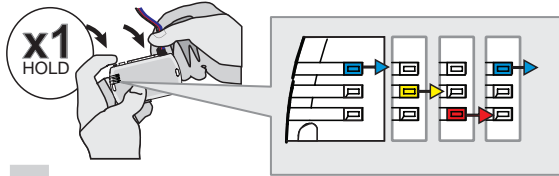

Press and hold the programming button:
Insert the 4-Pin (Data-Link) connector.

↳ The Blue, Red, Yellow and Blue & Red LEDs will alternatively illuminate.

2

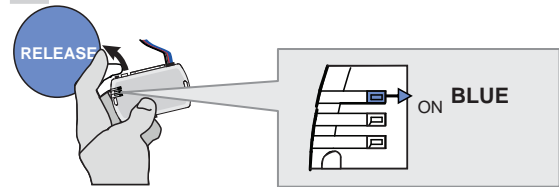

Release the programming button when the LED is BLUE.

If the LED is not solid BLUE disconnect the 4-Pin connector (Data-Link) and go back to step 1.

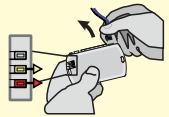

3

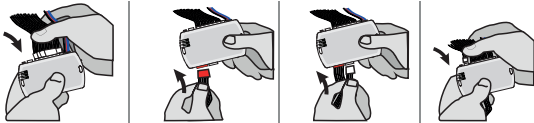

Insert the required remaining connectors.

4

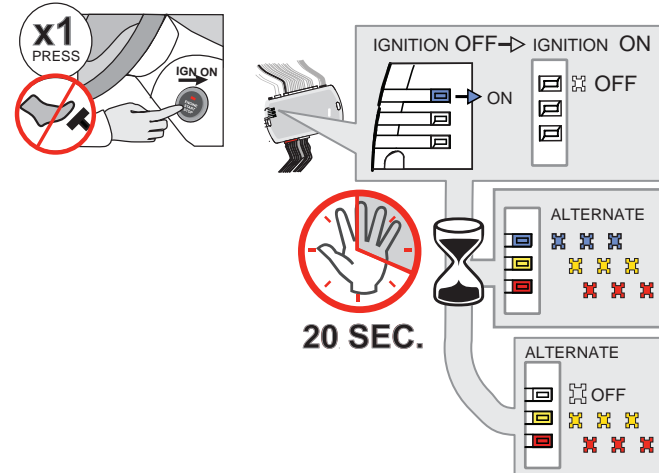

Do not press the brake pedal.
Press the Push-to-Start button once to turn on the ignition.

↳ The BLUE LED will turn OFF.

↳ The BLUE, YELLOW and RED LEDs will alternate.

Wait, at least 20 seconds, do not disconnect the modules or turn off the ignition.

↳ The RED and YELLOW LEDs will alternate.

Make sure that the DELs are flashing RED and YELLOW before continuing programming.

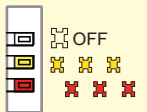

5

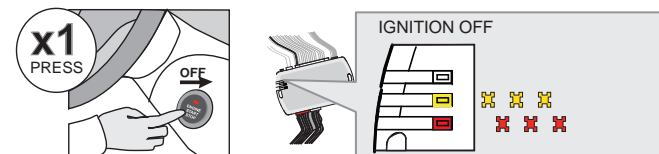

Press the Push-to-Start button once to turn off the ignition.

↳ The RED and YELLOW LEDs alternate.

KEY BYPASS PROGRAMMING PROCEDURE 2/2 |

6

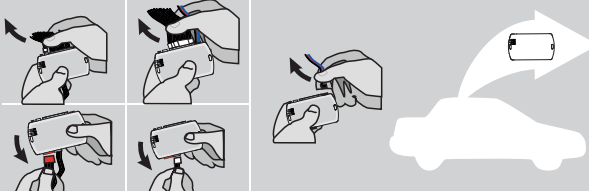

Disconnect all the connectors and after the Data-Link (4-pins) connector.

7



Microsoft Windows Computer with Internet connection*

FLASH LINK UPDATER* **FLASH LINK MANAGER***
SOFTWARE | PROGRAMME

OR

Smartphone* (Internet provider charges may apply)

VEHICLE'S OBDII CONNECTOR **FLASH LINK MOBILE***

Use the tool: FLASH LINK UPDATER or FLASH LINK MOBILE to visit the DCryptor menu.

*Parts required (not included)

8

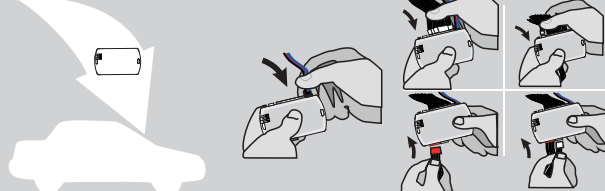

AFTER DCRYPTOR PROGRAMMING COMPLETED
Go back to the vehicle and reconnect the 4-Pin (Data-Link) connector and after, all the remaining connector.

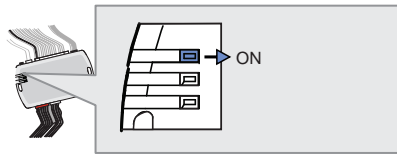

↳ The BLUE LED will turn ON.

9

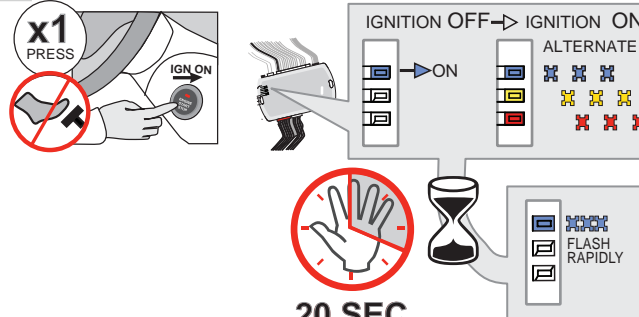

x1 PRESS (with a red 'X' over the push-to-start button)

IGNITION OFF → IGNITION ON

ALTERNATE

↳ The RED and YELLOW LEDs will turn ON.

Wait, at least 20 seconds, do not disconnect the modules or turn off the ignition.

↳ The BLUE LED will flash rapidly.

20 SEC.

FLASH RAPIDLY

10

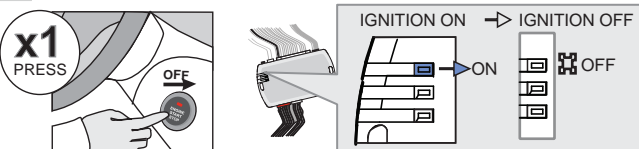

x1 PRESS (with a red 'X' over the push-to-start button)

IGNITION ON → IGNITION OFF

OFF

↳ The BLUE will turn OFF.



The module is now programmed.

OPTIONAL RF-KIT PROGRAMMING |

PROGRAM BYPASS OPTION

	<p>Program bypass option:</p>	<p>H2</p>	<p><input checked="" type="checkbox"/> Supported RF-KITS enable <input checked="" type="checkbox"/> H2 Fortin 2</p>
--	-------------------------------	------------------	---

OPTIONAL FORTIN RF KIT SERIES 4 OR SERIES 9 PROGRAMMING





The module must be programmed on the vehicle.

MAKE SURE THE IGNITION KEY HAS BEEN IN THE OFF POSITION FOR AT LEAST 5 SECONDS.

<p>1</p> <p>ON x1 PRESS</p> <p>Do not press the brake pedal. Press the Push-to-Start button once to turn on the ignition.</p>	<p>2</p> <p>OFF x1 PRESS</p> <p>Press the Push-to-Start button once to turn off the ignition.</p>	<p>3</p> <p>ON x1 PRESS</p> <p>Do not press the brake pedal. Press the Push-to-Start button once to turn on the ignition.</p>	<p>4</p> <p>4X BRAKES</p> <p>x4 PRESS</p> <p>Press and release the brake pedal four times.</p>	<p>5</p> <p>ON EACH TRANSMITTER SUR CHACUNE DES</p> <p>4 BUTTONS</p> <p>[-] PRESS AND RELEASE</p> <p>→ PRESS AND RELEASE</p> <p>1 BUTTON</p> <p>PRESS APPROX. 12 SEC. AND WAIT FOR THE BLUE LED TO TURN OFF THEN BACK ON SOLID THEN RELEASE.</p>	<p>6</p> <p>OFF x1 PRESS</p> <p>Press the Push-to-Start button once to turn off the ignition.</p>	<p>7</p> <p>ON x1 PRESS</p> <p>Do not press the brake pedal. Press the Push-to-Start button once to turn on the ignition and leave it ON for 5 sec..</p>	<p>8</p> <p>OFF x1 PRESS</p> <p>Press the Push-to-Start button once to turn off the ignition.</p>
<p>The LED will turn ON solide.</p>	<p>The LED will flash rapidly.</p>	<p>The LED will turn ON solide.</p>	<p>The LED will flash rapidly.</p>	<p>The LED will turn off each time.</p>	<p>The LED will turn Off.</p>	<p>The LED will turn Off.</p>	<p>The LED will turn Off.</p>
<p>The YELLOW LED will turn ON solid.</p>	<p>The YELLOW LED will turn Off.</p>	<p>The YELLOW LED will turn ON solid.</p>	<p>The 3 LED will turn ON solid.</p>	<p>The LED will flash rapidly.</p>	<p>The 3 LED will turn off.</p>	<p>The YELLOW LED will turn ON solid.</p>	<p>The YELLOW LED will turn Off.</p>

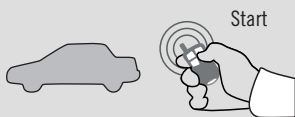

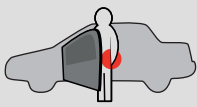
REMOTE STARTER FUNCTIONALITY |

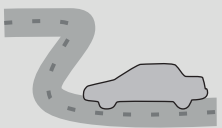
 <p>Start</p> <p>All doors must be closed.</p> <p>Remote start the vehicle.</p>	 <p>UNLOCK</p> <p>Unlock the doors with either:</p> <ul style="list-style-type: none"> • The OEM remote • The remote-starter remote • Or the proximity remote 	 <p>Enter the vehicle with the SMART-KEY.</p>	 <p>DO NOT PRESS THE BRAKE PEDAL.</p> <p>Press and release the Push-to-Start button once.</p>	 <p>Press the brake pedal. The vehicle can now be put in to gear and driven.</p> <p>If the Smart-Key is not detected the vehicle will shut down.</p>
--	---	--	---	---

STANDALONE & THAR-FOR3 INSTALLATION

ADDENDUM - SUGGESTED WIRING CONFIGURATION



ONLY COMPATIBLE WITH AUTOMATIC TRANSMISSION VEHICLES.



Vehicle functions supported in this diagram (functional if equipped)

VEHICLE	YEARS	Immobilizer bypass	T-Harness available (sold separately)	Lock	Unlock	Arm	Disarm	Tachometer	Door Status	Trunk Status	Hood Status*	Hand-Brake Status	Foot-Brake Status	Active OEM Remote Start
FORD Explorer Interceptor	2020	•	•	•	•	•	•	•	•	•	•	•	•	•

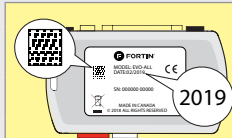

COMPATIBLE MODULE REQUIRED:

QR CODE ON THE LABEL
MANUFACTURED AFTER: 2019

FIRMWARE VERSION

58.[01]
MINIMUM

To add the firmware version and the options, use the **FLASH LINK UPDATER** or **FLASH LINK MOBILE** tool, sold separately.



Program bypass option:

UNIT OPTION

C1

DESCRIPTION

OEM Remote status (Lock/Unlock) monitoring

IF THE VEHICLE IS NOT EQUIPPED WITH FUNCTIONAL HOOD PIN:

A11

OFF

Hood trigger (Output Status).

NOTES

The vehicles OEM remote will still operable during remote start.

MANDATORY INSTALL

*HOOD PIN



HOOD STATUS: THE HOOD PIN SWITCH MUST BE INSTALLED IF THE VEHICLE CAN BE REMOTE STARTED WITH THE HOOD OPEN, SET FUNCTION A11 TO OFF.

A11

OFF

Notice: the installation of safety elements are mandatory. The hood pin is an essential security element and must be installed.

THIS MODULE MUST BE INSTALLED BY A QUALIFIED TECHNICIAN. A WRONG CONNECTION CAN CAUSE PERMANENT DAMAGE TO THE VEHICLE.

PARTS REQUIRED (NOT INCLUDED) |

1x **FLASH LINK UPDATER,**
1x **FLASH LINK MANAGER**
SOFTWARE | PROGRAMME
1x Microsoft Windows Computer with Internet connection

OR

1x **FLASH LINK MOBILE**
1x **FLASH LINK MOBILE APP**
Smartphone Android or iOS with Internet connection (provider charges may apply).

MANDATORY

HOOD PIN



REMOTE START SAFETY OVERRIDE SWITCH

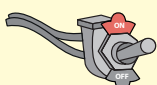







VALET SWITCH

Part #: RSPB available, Sold separately.

Notice: the installation of safety elements are mandatory. The hood pin and the valet switch are essential security elements and must be installed.

STAND ALONE CONFIGURATION |

	Program bypass option	UNIT OPTION	DESCRIPTION
	OEM Remote Stand Alone Remote Starter:	D1.10 	By default, LOCK, LOCK, LOCK
		D1.1 	Par défaut, VERROUILLE,VERROUILLE,VERROUILLE
	Program bypass option with oem remote:	C1	OEM Remote Monitoring
	Program bypass option with RF KIT antenna:	H1 to H6	Supported RF Kits and select RF Kit
	Program bypass option Vehicle hybrid only:	D4	Hybrid mode (Vehicle hybrid only)

REMOTE STARTER FUNCTIONALITY |



All doors must be closed.

3X 

Press the OEM remote's Lock button 3x to remote-start (or remote-stop) the vehicle.



START 

The vehicle will START.

REMOTE STARTER DIAGNOSTICS

MODULE RED LED

x2 flash : Brake ON

x3 flash : No tach

x4 flash : Ignition before start

x5 flash : Hood Open

REMOTE STARTER WARNING CARD |



CUT THIS WARNING CARD AND STICK IT ON A VISIBLE PLACE:
or use the package RSPB, Sold separately.

WARNING



REMOTE STARTER

THE VEHICLE CAN BE STARTED BY EITHER: PRESSING THE LOCK BUTTON ON THE OEM REMOTE 3 TIMES CONSECUTIVELY OR BY A SMARTPHONE. **TURN ON** THE SAFETY SWITCH LOCATED UNDER THE DASHBOARD BEFORE WORKING ON THE VEHICLE.

DESCRIPTION |

	Parts required (Not included)	PAGE
--	-------------------------------	------

WIRE TO WIRE DIAGRAM

AUTOMATIC TRANSMISSION	1x 7.5 Amp. fuse	Page 3
------------------------	------------------	--------

THARNESSE DIAGRAM

THARNESSE THAR-FOR3	AUTOMATIC TRANSMISSION	1x THAR-FOR3	Page 4
---------------------	------------------------	--------------	--------



①

Gateway module, Behind OBD-II connector - located behind driver side fusebox

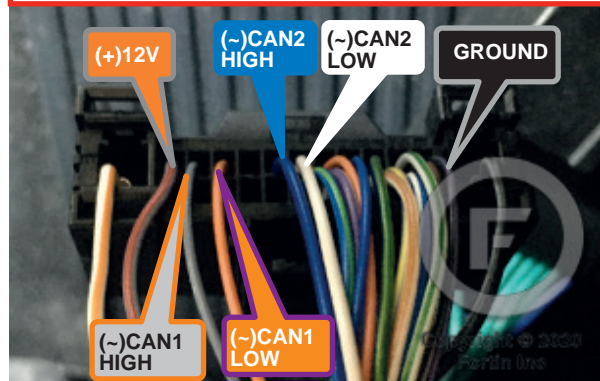

AUTOMATIC TRANSMISSION WIRING CONNECTION |

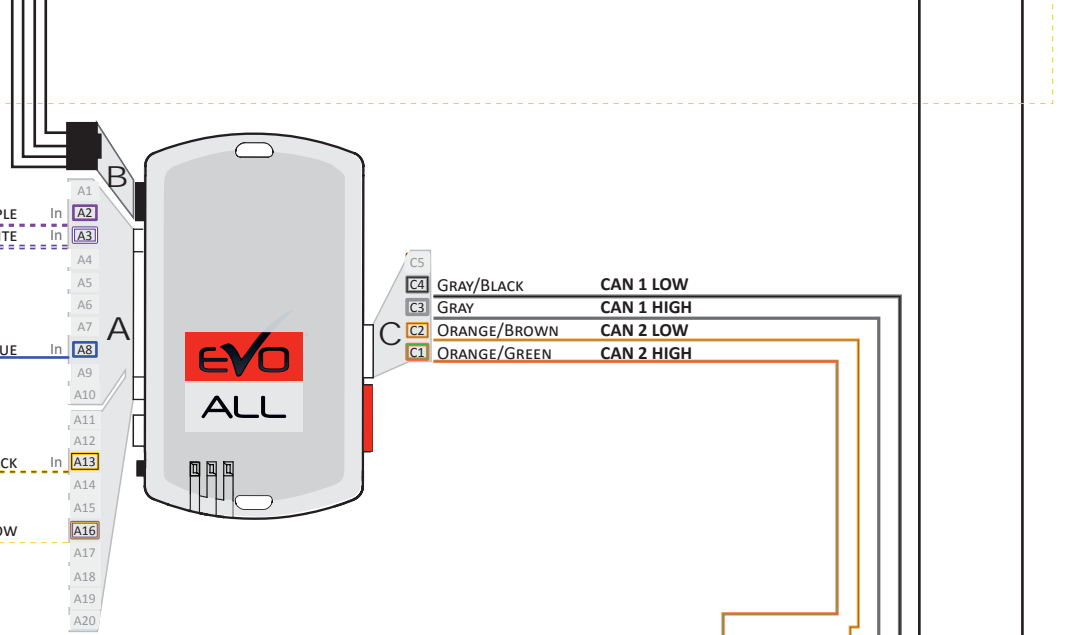
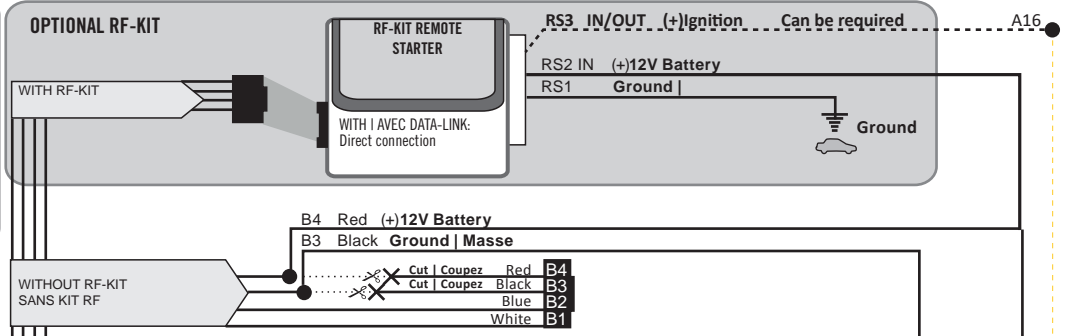
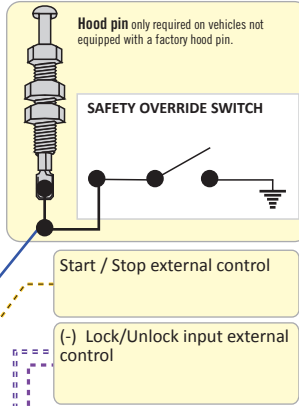

EXPLORER INTERCEPTOR

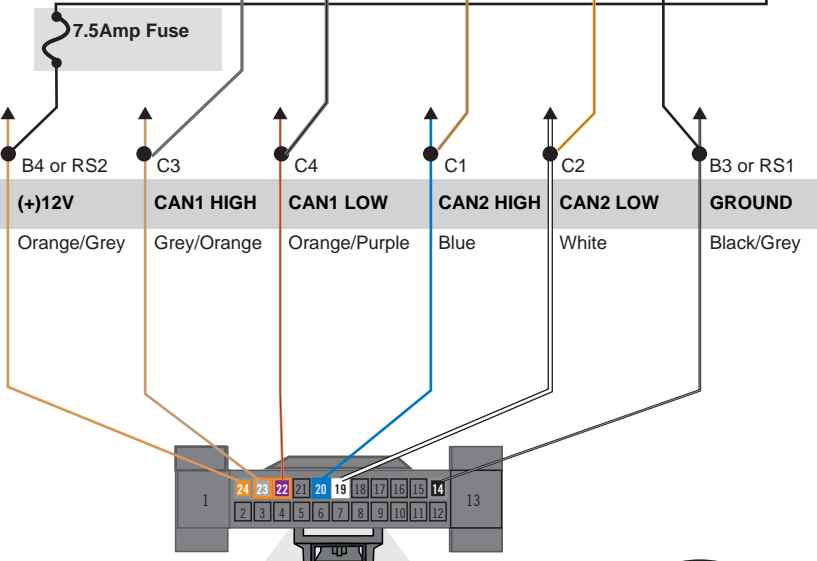

① Gateway module, Behind OBD-II connector - located behind driver side fusebox - Back view, 24-pin black connector.

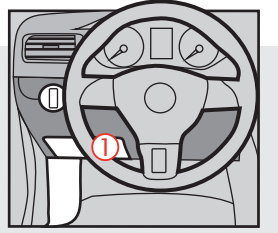

THAR-FOR3 | T-HARNESS - AUTOMATIC TRANSMISSION |

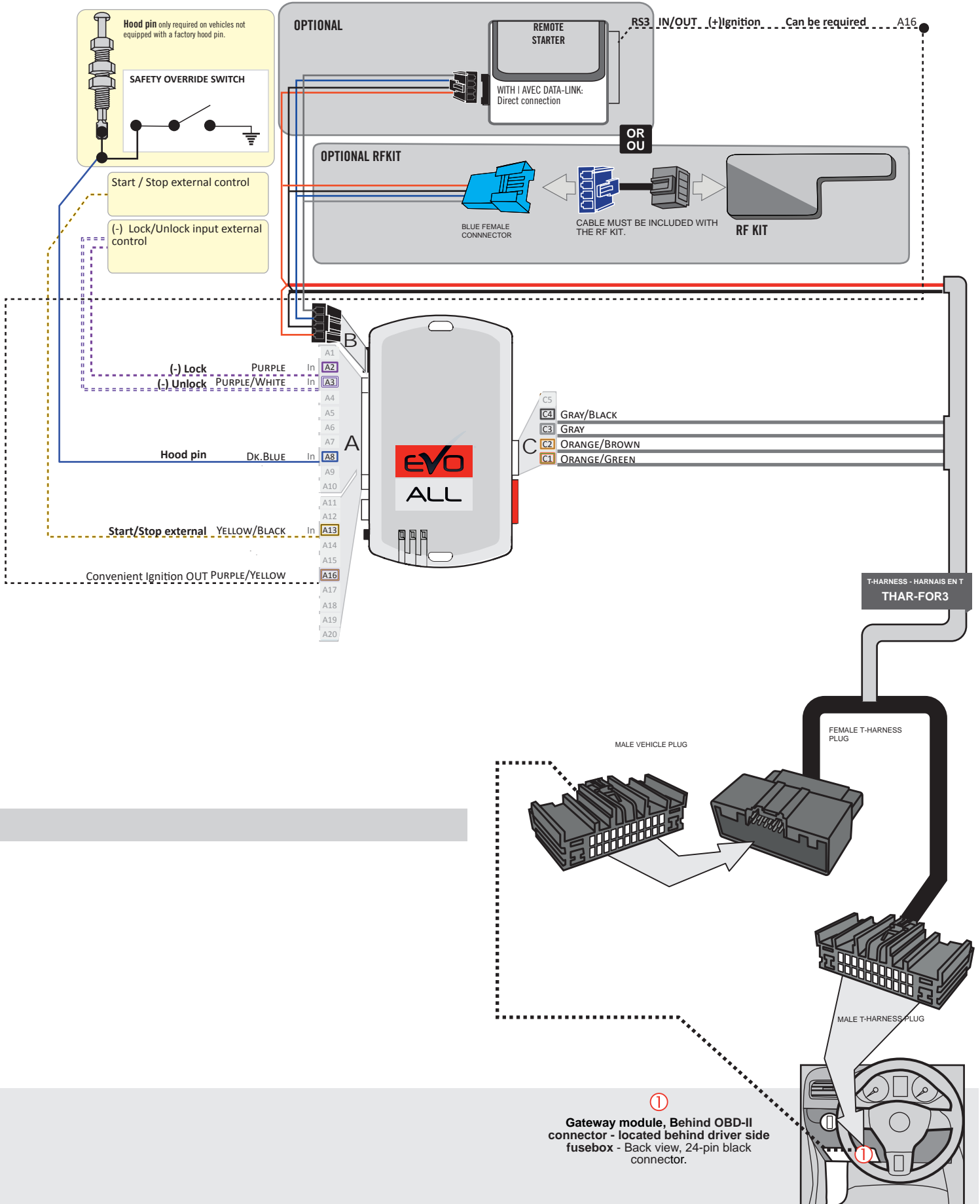

EXPLORER INTERCEPTOR



Parts required (not included)

- 1x **FLASH LINK UPDATER,**
- 1x **FLASH LINK MANAGER**
SOFTWARE | PROGRAMME
- 1x Microsoft Windows Computer with Internet connection

OR

- 1x **FLASH LINK MOBILE**
- 1x **FLASH LINK MOBILE APP**
- Smartphone *Android* or *iOS* with Internet connection
(Internet provider charges may apply)

BEFORE PROGRAMMING SET THE UNIT OPTIONS AND SAVE.

1

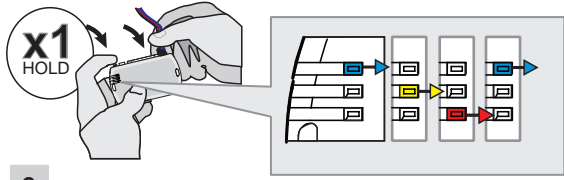

Press and hold the programming button:
Insert the 4-Pin (Data-Link) connector.

↳ The Blue, Red, Yellow and Blue & Red LEDs will alternatively illuminate.

2

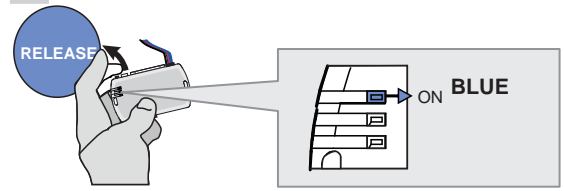

Release the programming button when the LED is BLUE.

If the LED is not solid BLUE disconnect the 4-Pin connector (Data-Link) and go back to step 1.

3

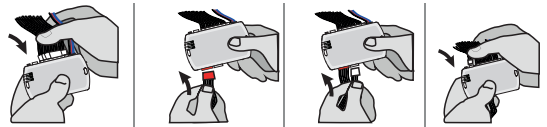

Insert the required remaining connectors.

4

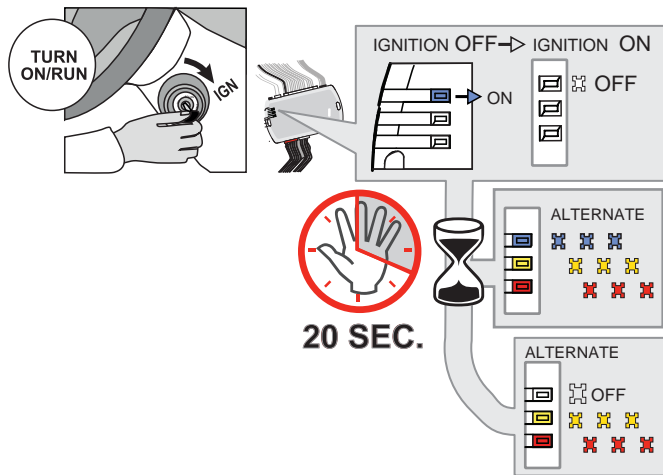

Turn the key to the Ignition ON/RUN position.

↳ The BLUE LED will turn OFF.

↳ The BLUE, YELLOW and RED LEDs will alternated.

Wait, at least 20 seconds, do not disconnect the modules or turn off the ignition.

↳ The RED and YELLOW LEDs will alternated.

Make sure that the DELs are flashing RED and YELLOW before continuing programming.

5

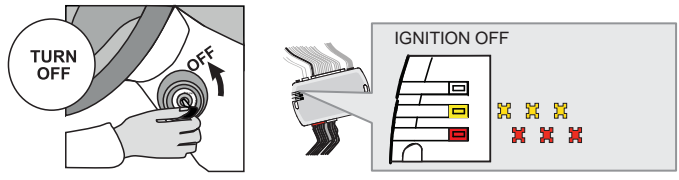

Turn the key to the OFF position.

↳ The RED and YELLOW LEDs alternate.

KEY BYPASS PROGRAMMING PROCEDURE 2/2 |

16

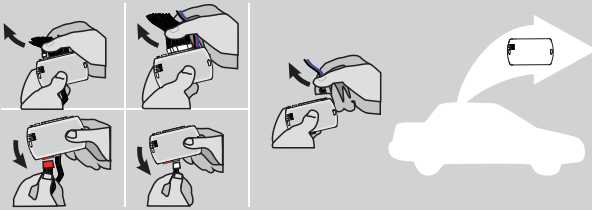

Disconnect all the connectors and after the Data-Link (4-pins) connector.

17

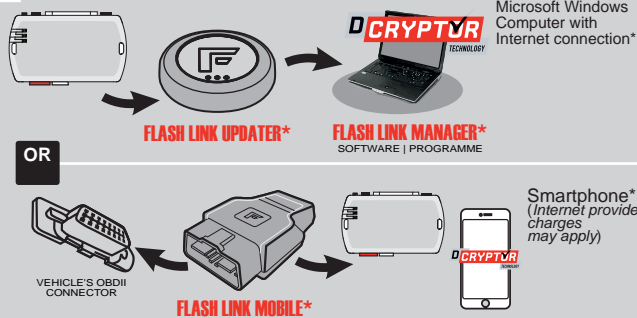

Use the tool: **FLASH LINK UPDATER** or **FLASH LINK MOBILE** to visit the DCRYPTOR menu.

*Parts required (not included)

18

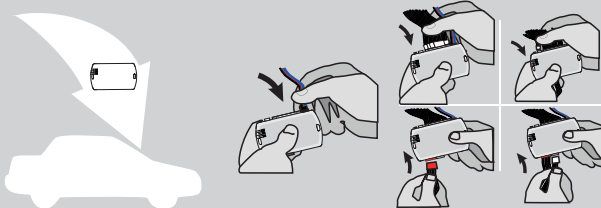

AFTER DCRYPTOR PROGRAMMING COMPLETED
Go back to the vehicle and **reconnect** the 4-Pin (Data-Link) connector and after, all the remaining connector.

9

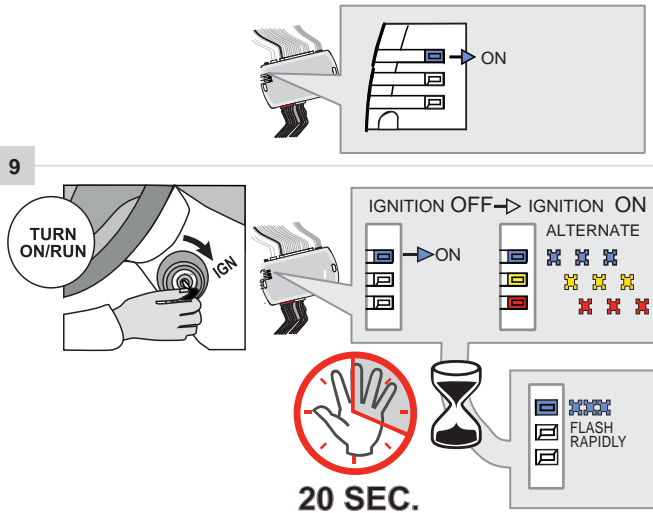

Turn the key to the Ignition ON/RUN position.

↳ The RED and YELLOW LEDs will turn ON.

Wait, at least 20 seconds, do not disconnect the modules or turn off the ignition.

↳ The BLUE LED will flash rapidly.

10

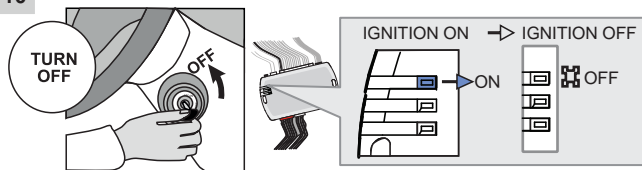

Turn the key to the OFF position.

↳ The BLUE will turn OFF.



The module is now programmed.

OPTIONAL RF-KIT PROGRAMMING |

PROGRAM BYPASS OPTION

	<p>Program bypass option:</p>	<p>H2</p>	<p><input checked="" type="checkbox"/> Supported RF-KITS enable <input checked="" type="checkbox"/> H2 Fortin 2</p>
---	-------------------------------	------------------	---







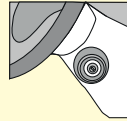





OPTIONAL FORTIN RF KIT SERIES 4 OR SERIES 9 PROGRAMMING



The module must be programmed on the vehicle.

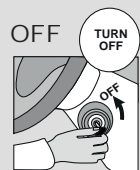
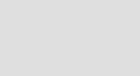
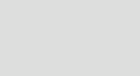
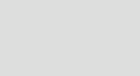
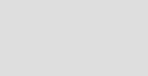

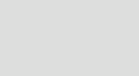
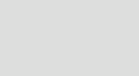
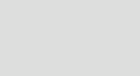
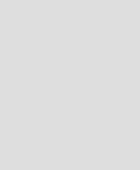
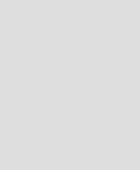
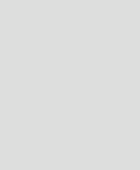
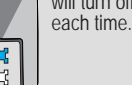
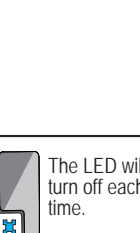
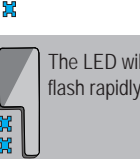
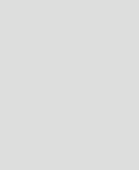
MAKE SURE THE IGNITION KEY HAS BEEN IN THE OFF POSITION FOR AT LEAST 5 SECONDS.

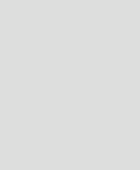
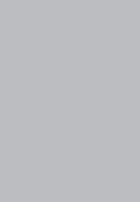
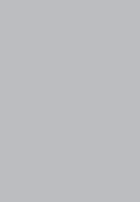
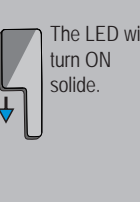
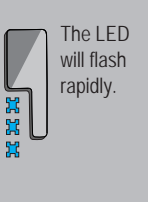
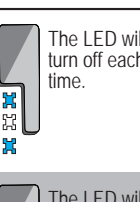
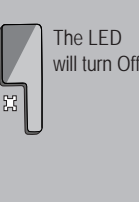
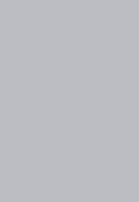
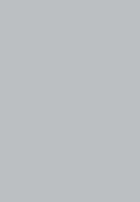
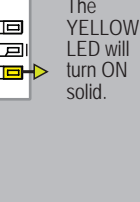
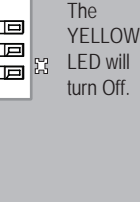
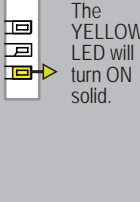
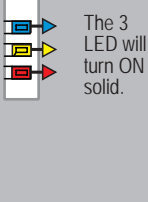
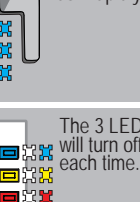
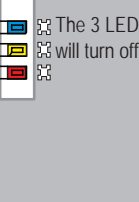
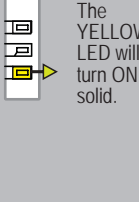
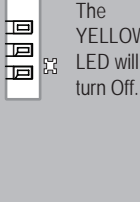
<p>1</p>  <p>ON TURN ON/RUN</p>	<p>2</p>  <p>OFF TURN OFF</p>	<p>3</p>  <p>ON TURN ON/RUN</p>	<p>4</p> <p>4X BRAKES</p>  <p>x4 PRESS</p>	<p>5</p> <p>ON EACH TRANSMITTER</p> <p>4 BUTTONS</p>  <p>1 BUTTON</p> 	<p>6</p>  <p>OFF TURN OFF</p>	<p>7</p>  <p>ON TURN ON/RUN</p>	<p>8</p>  <p>OFF TURN OFF</p>
<p>Turn the key to the ON/RUN position.</p>	<p>Turn the ignition to the OFF position.</p>	<p>Turn the key to the ON/RUN position.</p>	<p>Press and release the brake pedal four times.</p>	<p>4 BUTTONS</p> <p>PRESS AND RELEASE</p> <p>PRESS AND RELEASE</p>	<p>Turn the ignition to the OFF position.</p>	<p>Turn the key to the ON/RUN position and leave it ON for 5 sec.</p>	<p>Turn the ignition to the OFF position.</p>
 <p>The YELLOW LED will turn ON solid.</p>	 <p>The YELLOW LED will turn Off.</p>	 <p>The YELLOW LED will turn ON solid.</p>	 <p>The 3 LED will turn ON solid.</p>	 <p>The LED will turn off each time.</p>	 <p>The 3 LED will turn off.</p>	 <p>The YELLOW LED will turn ON solid.</p>	 <p>The YELLOW LED will turn Off.</p>
 <p>Turn the key to the ON/RUN position.</p>	 <p>Turn the ignition to the OFF position.</p>	 <p>Turn the key to the ON/RUN position.</p>	<p>4X BRAKES</p>  <p>x4 PRESS</p> <p>The LED will turn off each time.</p>	<p>ON EACH TRANSMITTER</p> <p>4 BUTTONS</p>  <p>1 BUTTON</p>  <p>PRESS APPROX. 12 SEC. AND WAIT FOR THE BLUE LED TO TURN OFF THEN BACK ON SOLID THEN RELEASE.</p>	 <p>Turn the ignition to the OFF position.</p>	 <p>Turn the key to the ON/RUN position and leave it ON for 5 sec.</p>	 <p>Turn the ignition to the OFF position.</p>
 <p>The LED will turn ON solide.</p>	 <p>The LED will flash rapidly.</p>	 <p>The LED will turn off each time.</p>	 <p>The LED will turn Off.</p>	 <p>The LED will flash rapidly.</p>	 <p>The 3 LED will turn off.</p>	 <p>The YELLOW LED will turn ON solid.</p>	 <p>The YELLOW LED will turn Off.</p>
 <p>The YELLOW LED will turn ON solid.</p>	 <p>The YELLOW LED will turn Off.</p>	 <p>The YELLOW LED will turn ON solid.</p>	 <p>The 3 LED will turn ON solid.</p>	 <p>The LED will turn off each time.</p>	 <p>The 3 LED will turn off.</p>	 <p>The YELLOW LED will turn ON solid.</p>	 <p>The YELLOW LED will turn Off.</p>



REMOTE STARTER FUNCTIONALITY |



All doors must be closed.



Remote start the vehicle.



Unlock the doors with the remote-starter remote or the OEM remote.



Insert and Turn the key to the Ignition ON/RUN position.



Press the brake pedal.



The vehicle can now be put in to gear and driven.

STANDALONE & THAR-FOR3 INSTALLATION

ADDENDUM - SUGGESTED WIRING CONFIGURATION



ONLY COMPATIBLE WITH AUTOMATIC TRANSMISSION VEHICLES.



Vehicle functions supported in this diagram (functional if equipped)

VEHICLE	YEARS	Immobilizer bypass	Lock	Unlock	Arm	Disarm	RAP Disable	Parking Lights	Tachometer	Heated seats	Heated Mirrors	Rear defrost	Door Status	Trunk Status	Hood Status*	Hand-Brake Status	Foot-Brake Status	Active OEM Remote Start	
FORD																			
F-150	Key 2020	•	•	•	•	•	•	•	•	•	•	•	•	•	•	•	•	•	•
F-250	Key 2020	•	•	•	•	•	•	•	•	•	•	•	•	•	•	•	•	•	•
F-350	Key 2020	•	•	•	•	•	•	•	•	•	•	•	•	•	•	•	•	•	•
F-450	Key 2020	•	•	•	•	•	•	•	•	•	•	•	•	•	•	•	•	•	•

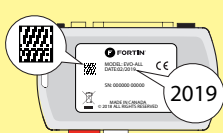

COMPATIBLE MODULE REQUIRED:

QR CODE ON THE LABEL
MANUFACTURED AFTER: 2019

FIRMWARE VERSION

58.[02]
MINIMUM

To add the firmware version and the options, use the **FLASH LINK UPDATER** or **FLASH LINK MOBILE** tool, sold separately.



Program bypass option:

UNIT OPTION

DESCRIPTION

C1

OEM Remote status (Lock/Unlock) monitoring

IF THE VEHICLE IS NOT EQUIPPED WITH FUNCTIONAL HOOD PIN:

A11

OFF

Hood trigger (Output Status).

NOTES

The vehicles OEM remote and SmartKey are still operable during remote start.

**Heated seats The heated seats and rear defrost activate automatically when it cold.

***Parking Lights The parking Lights at remote start only.



The vehicle must be equipped with the OEM remote with the door locks.

MANDATORY INSTALL

*HOOD PIN



HOOD STATUS: THE HOOD PIN SWITCH MUST BE INSTALLED IF THE VEHICLE CAN BE REMOTE STARTED WITH THE HOOD OPEN, SET FUNCTION A11 TO OFF.

A11

OFF

Notice: the installation of safety elements are mandatory. The hood pin is an essential security element and must be installed.

THIS MODULE MUST BE INSTALLED BY A QUALIFIED TECHNICIAN. A WRONG CONNECTION CAN CAUSE PERMANENT DAMAGE TO THE VEHICLE.

PARTS REQUIRED (NOT INCLUDED)

1x **FLASH LINK UPDATER,**
1x **FLASH LINK MANAGER**
SOFTWARE | PROGRAMME
1x Microsoft Windows Computer with Internet connection

OR

1x **FLASH LINK MOBILE**
1x **FLASH LINK MOBILE APP**
Smartphone Android or iOS with Internet connection (provider charges may apply).

MANDATORY

HOOD PIN



REMOTE START SAFETY OVERRIDE SWITCH

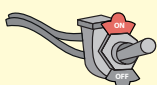







VALET SWITCH

Part #: RSPB available, Sold separately.

Notice: the installation of safety elements are mandatory. The hood pin and the valet switch are essential security elements and must be installed.

STAND ALONE CONFIGURATION

	Program bypass option	UNIT OPTION	DESCRIPTION
	OEM Remote Stand Alone Remote Starter:	D1.10 	By default, LOCK, LOCK, LOCK
		D1.1 	Par défaut, VERROUILLE, VERROUILLE, VERROUILLE
	Program bypass option with oem remote:	C1	OEM Remote Monitoring
	Program bypass option with RF KIT antenna:	H1 to H6	Supported RF Kits and select RF Kit
	Program bypass option Vehicle hybrid only:	D4	Hybrid mode (Vehicle hybrid only)

REMOTE STARTER FUNCTIONALITY



All doors must be closed.

3X 

Press the OEM remote's Lock button 3x to remote-start (or remote-stop) the vehicle.



START 

The vehicle will START.

REMOTE STARTER DIAGNOSTICS
MODULE RED LED

x2 flash :	Brake ON
x3 flash :	No tach
x4 flash :	Ignition before start
x5 flash :	Hood Open

REMOTE STARTER WARNING CARD



CUT THIS WARNING CARD AND STICK IT ON A VISIBLE PLACE:
or use the package RSPB, Sold separately.

WARNING



REMOTE STARTER

THE VEHICLE CAN BE STARTED BY EITHER: PRESSING THE LOCK BUTTON ON THE OEM REMOTE 3 TIMES CONSECUTIVELY OR BY A SMARTPHONE. **TURN ON** THE SAFETY SWITCH LOCATED UNDER THE DASHBOARD BEFORE WORKING ON THE VEHICLE.

DESCRIPTION

	Parts required (Not included)	PAGE
--	-------------------------------	------

WIRE TO WIRE DIAGRAM

AUTOMATIC TRANSMISSION	1x 7.5 Amp. fuse	Page 3
------------------------	------------------	--------

THARNES DIAGRAM

THARNES THAR-FOR3 AUTOMATIC TRANSMISSION	1x THAR-FOR3	Page 4
--	--------------	--------



① Gateway module, located at dash board driver's side,

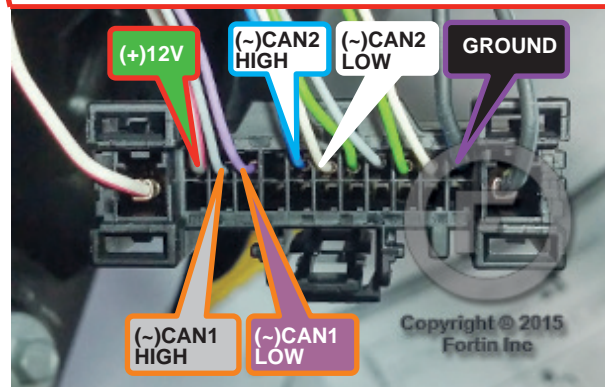

② Under the hood If not equipped with hood pin.

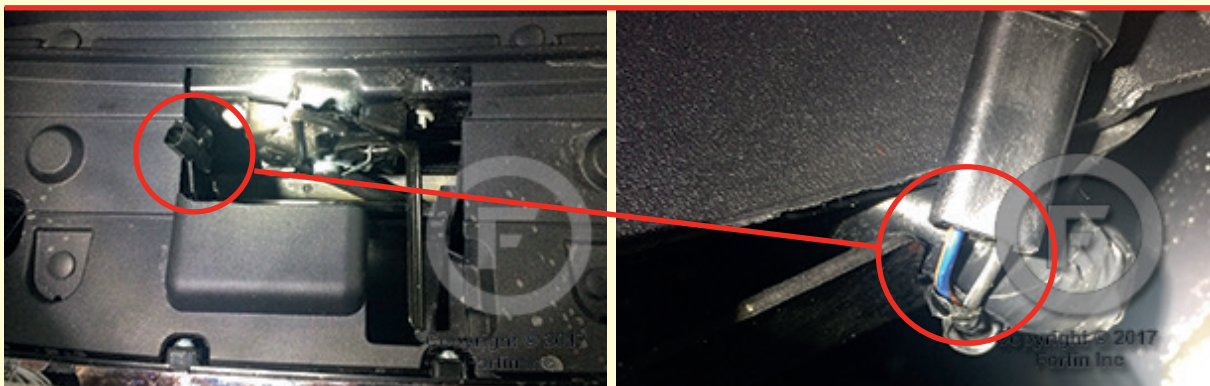

AUTOMATIC TRANSMISSION WIRING CONNECTION |

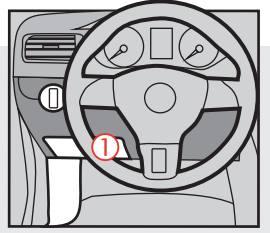
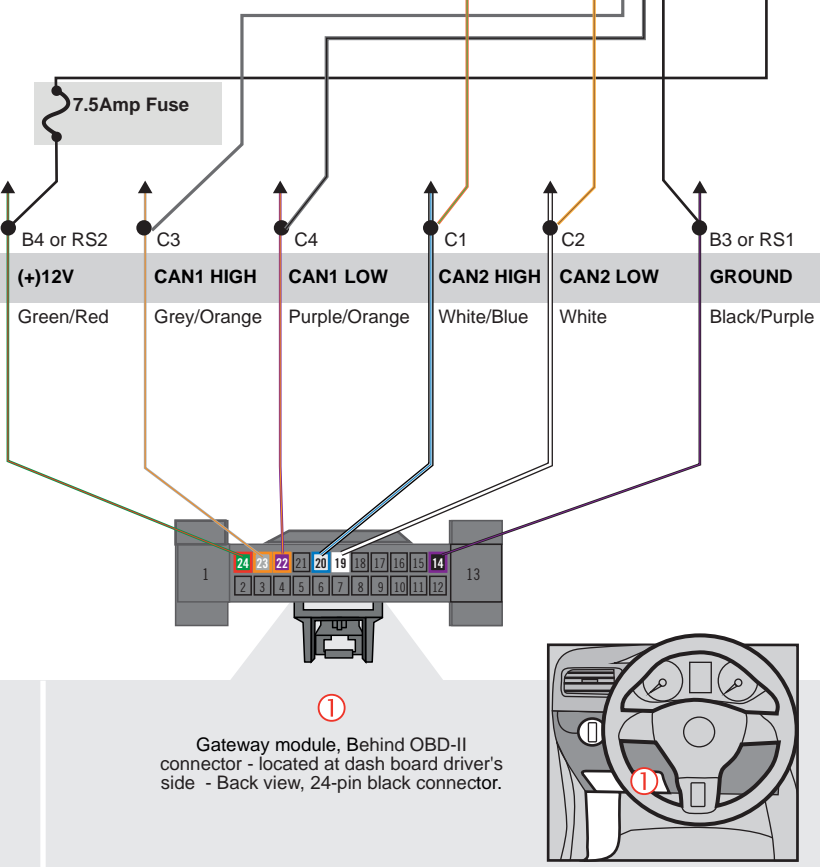
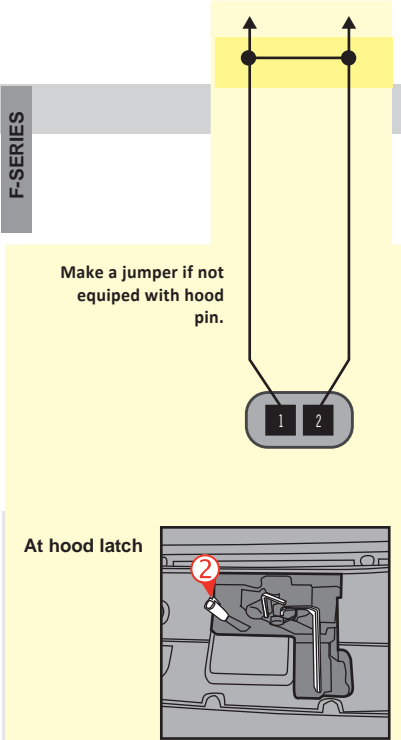
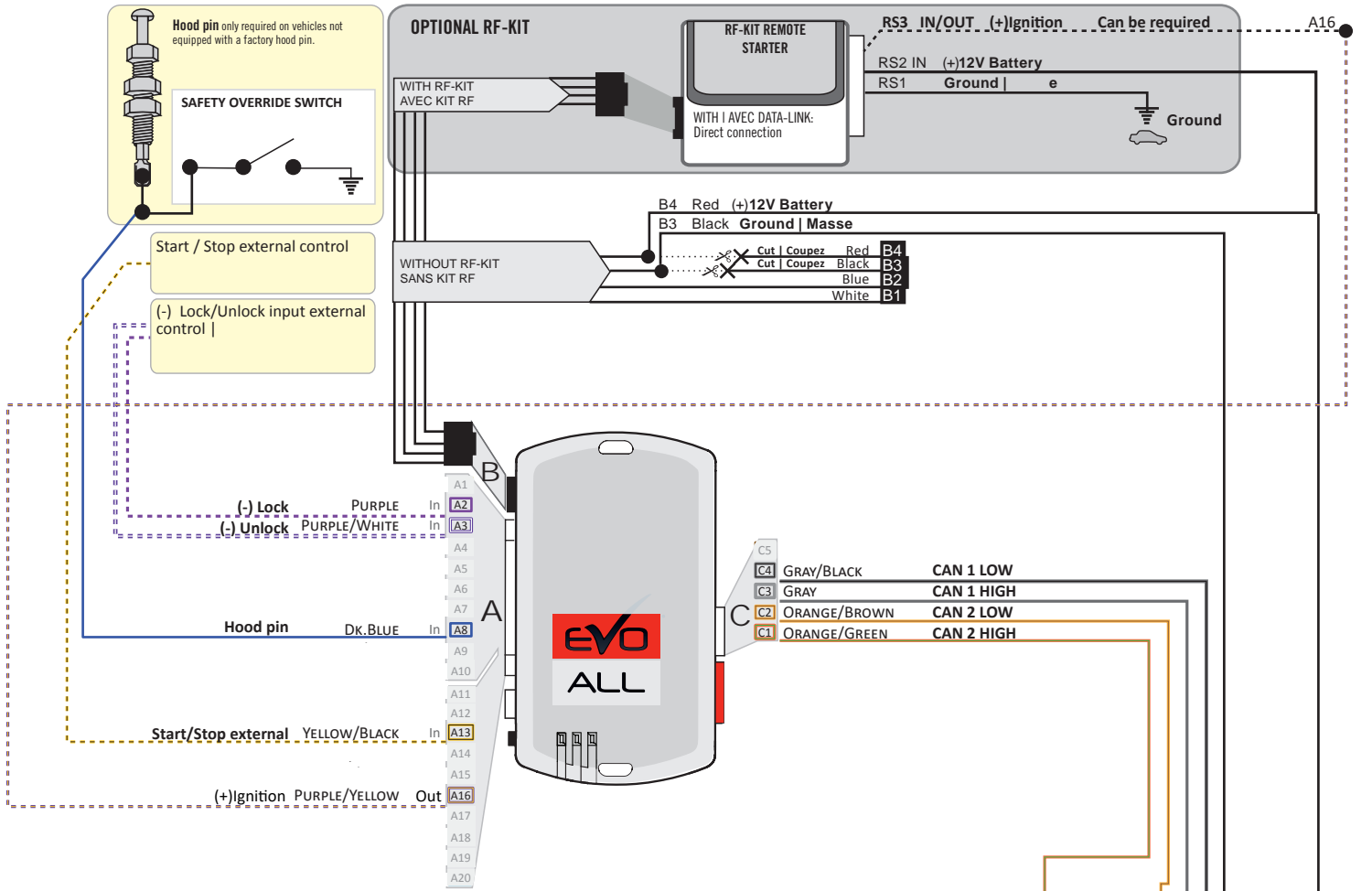

THAR-FOR3 | T-HARNESS - AUTOMATIC TRANSMISSION |

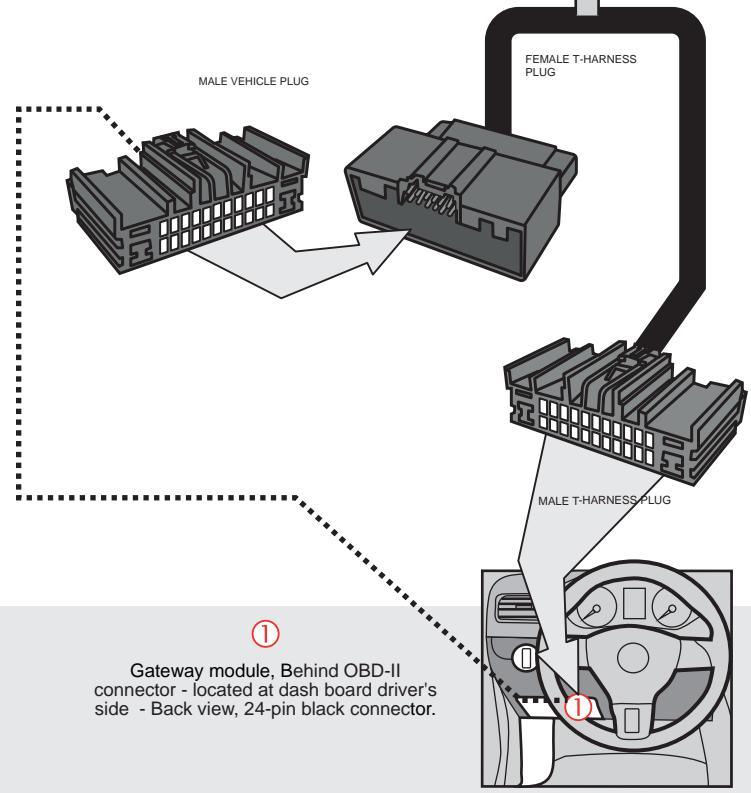
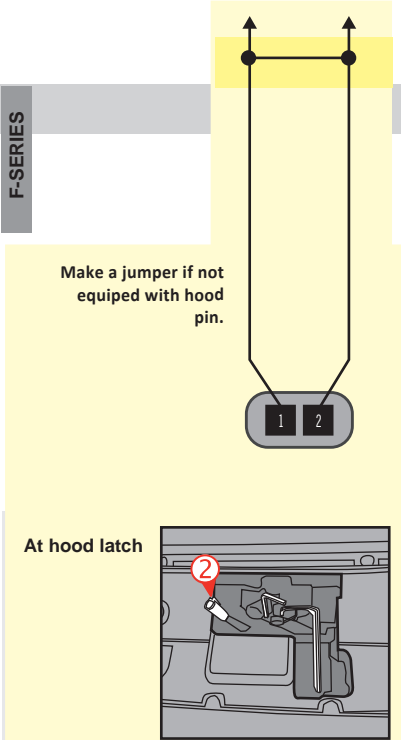
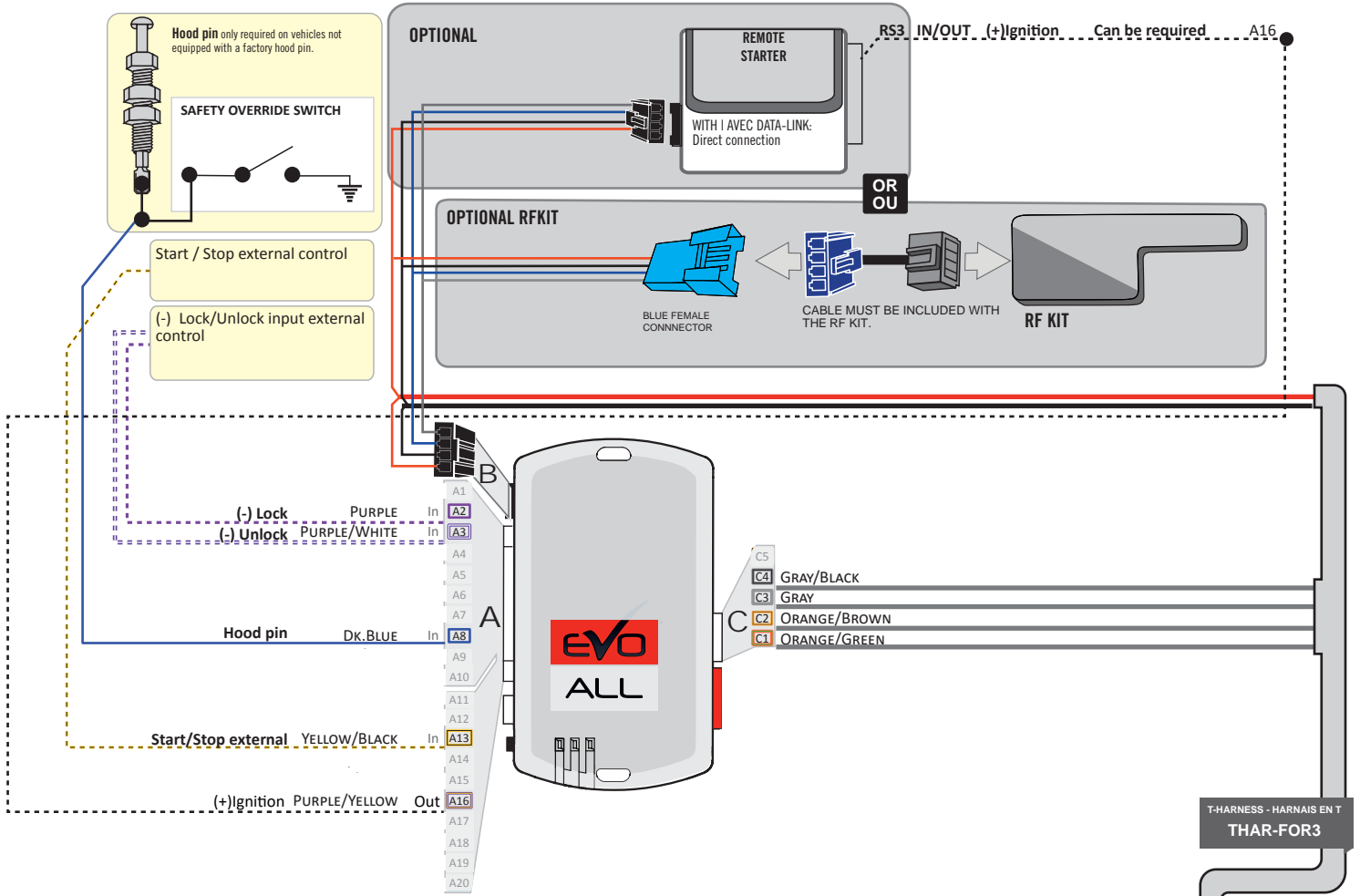



Parts required (not included)

- 1x FLASH LINK UPDATER, SOFTWARE | PROGRAMME
- 1x FLASH LINK MANAGER
- 1x Microsoft Windows Computer with Internet connection

OR

- 1x FLASH LINK MOBILE
- 1x FLASH LINK MOBILE APP
- Smartphone Android or iOS with Internet connection (Internet provider charges may apply)

BEFORE PROGRAMMING SET THE UNIT OPTIONS AND SAVE.

1

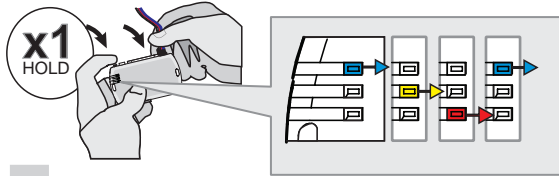

Press and hold the programming button:
Insert the 4-Pin (Data-Link) connector.

↳ The Blue, Red, Yellow and Blue & Red LEDs will alternatively illuminate.

2

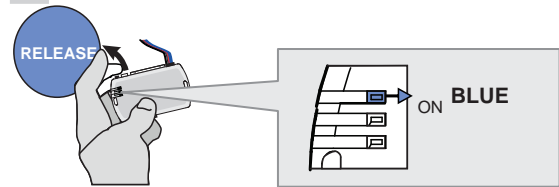

Release the programming button when the LED is BLUE.

If the LED is not solid BLUE disconnect the 4-Pin connector (Data-Link) and go back to step 1.

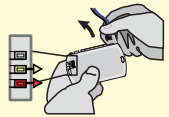

3

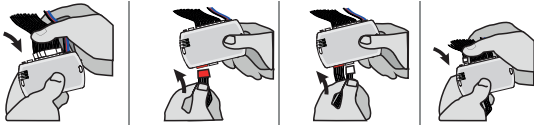

Insert the required remaining connectors.

4

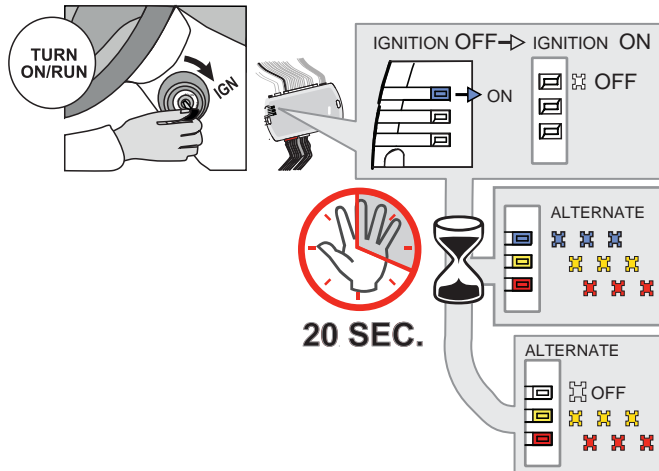

Turn the key to the Ignition ON/RUN position.

↳ The BLUE LED will turn OFF.

↳ The BLUE, YELLOW and RED LEDs will alternate.

Wait, at least 20 seconds, do not disconnect the modules or turn off the ignition.

↳ The RED and YELLOW LEDs will alternate.

Make sure that the DELs are flashing RED and YELLOW before continuing programming.

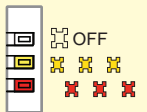

5

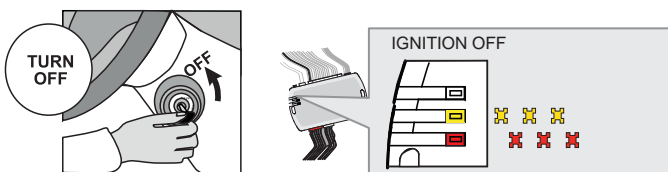

Turn the key to the OFF position.

↳ The RED and YELLOW LEDs alternate.

KEY BYPASS PROGRAMMING PROCEDURE 2/2 |

6

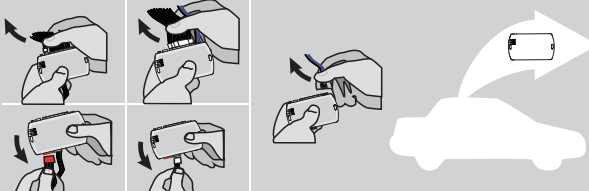

Disconnect all the connectors and after the Data-Link (4-pins) connector.

7



Microsoft Windows Computer with Internet connection*

FLASH LINK UPDATER* **FLASH LINK MANAGER***
SOFTWARE | PROGRAMME

OR

Smartphone* (Internet provider charges may apply)

VEHICLE'S OBDII CONNECTOR **FLASH LINK MOBILE***

Use the tool: FLASH LINK UPDATER or FLASH LINK MOBILE to visit the DCRYPTOR menu.

*Parts required (not included)

8

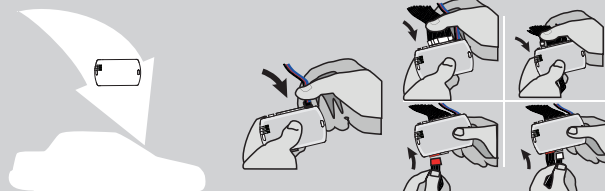

AFTER DCRYPTOR PROGRAMMING COMPLETED
Go back to the vehicle and reconnect the 4-Pin (Data-Link) connector and after, all the remaining connector.

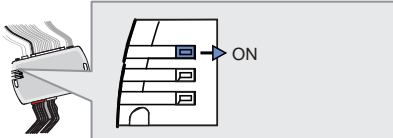

↳ The BLUE LED will turn ON.

9

TURN ON/RUN

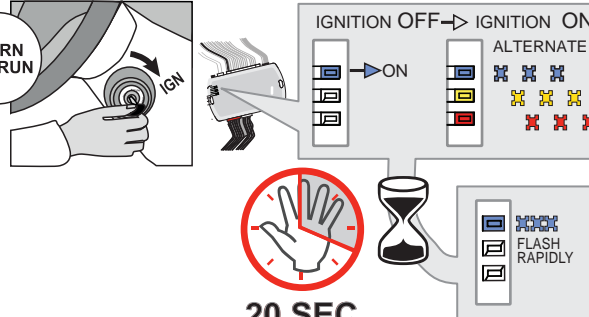

IGNITION OFF → IGNITION ON

ALTERNATE

↳ The RED and YELLOW LEDs will turn ON.

Wait, at least 20 seconds, do not disconnect the modules or turn off the ignition.

↳ The BLUE LED will flash rapidly.

20 SEC.

FLASH RAPIDLY

10

TURN OFF

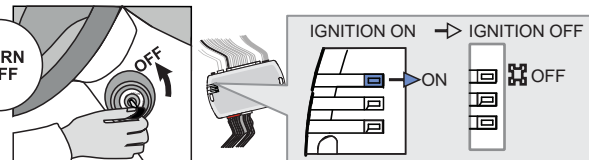

IGNITION ON → IGNITION OFF

↳ The BLUE will turn OFF.



The module is now programmed.



OPTIONAL RF-KIT PROGRAMMING |

PROGRAM BYPASS OPTION







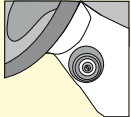







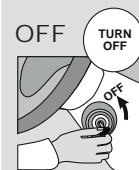

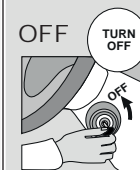
	<p>Program bypass option:</p>	<p>H2</p>	<p><input checked="" type="checkbox"/> Supported RF-KITS enable</p> <p><input checked="" type="checkbox"/> H2 Fortin 2</p> <p><input checked="" type="checkbox"/></p>
---	-------------------------------	------------------	---

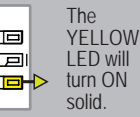
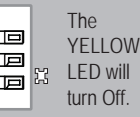
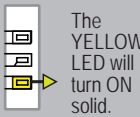
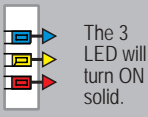
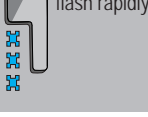
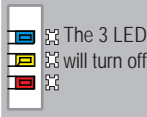
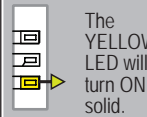
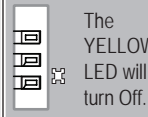
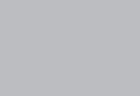
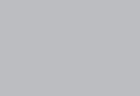
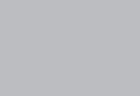
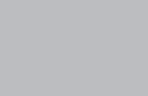
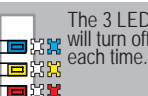
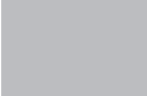
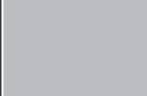
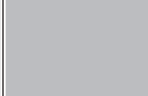
OPTIONAL FORTIN RF KIT SERIES 4 OR SERIES 9 PROGRAMMING

The module must be programmed on the vehicle.

MAKE SURE THE IGNITION KEY HAS BEEN IN THE OFF POSITION FOR AT LEAST 5 SECONDS.

<p>1</p>  <p>ON TURN ON/RUN</p>	<p>2</p>  <p>OFF TURN OFF</p>	<p>3</p>  <p>ON TURN ON/RUN</p>	<p>4</p> <p>4X BRAKES</p>  <p>x4 PRESS</p>	<p>5</p> <p>ON EACH TRANSMITTER</p> <p>4 BUTTONS</p> <p>[-] PRESS AND RELEASE</p> <p>➔ PRESS AND RELEASE APPUYEZ ET RELÂCHEZ</p> <p>1 BUTTON</p> <p>PRESS APPROX. 12 SEC. AND WAIT FOR THE BLUE LED TO TURN OFF THEN BACK ON SOLID THEN RELEASE.</p>	<p>6</p>  <p>OFF TURN OFF</p>	<p>7</p>  <p>ON TURN ON/RUN</p>	<p>8</p>  <p>OFF TURN OFF</p>
<p>Turn the key to the ON/RUN position.</p>	<p>Turn the ignition to the OFF position.</p>	<p>Turn the key to the ON/RUN position.</p>	<p>Press and release the brake pedal four times.</p>	<p>The LED will turn off each time.</p>	<p>Turn the ignition to the OFF position.</p>	<p>Turn the key to the ON/RUN position and leave it ON for 5 sec.</p> 	<p>Turn the ignition to the OFF position.</p>
 <p>The YELLOW LED will turn ON solid.</p>	 <p>The YELLOW LED will turn Off.</p>	 <p>The LED will turn ON solide.</p>	 <p>The LED will flash rapidly.</p>	 <p>The LED will turn off each time.</p>	 <p>The LED will turn Off.</p>	 <p>The LED will turn ON solid.</p>	 <p>The LED will turn Off.</p>
 <p>The 3 LED will turn ON solid.</p>	 <p>The 3 LED will turn ON solid.</p>	 <p>The 3 LED will turn ON solid.</p>	 <p>The 3 LED will turn ON solid.</p>	 <p>The LED will flash rapidly.</p>	 <p>The 3 LED will turn off.</p>	 <p>The YELLOW LED will turn ON solid.</p>	 <p>The YELLOW LED will turn Off.</p>
 <p>The 3 LED will turn off each time.</p>	 <p>The 3 LED will turn off each time.</p>	 <p>The 3 LED will turn off each time.</p>	 <p>The 3 LED will turn off each time.</p>	 <p>The 3 LED will turn off each time.</p>	 <p>The 3 LED will turn off each time.</p>	 <p>The 3 LED will turn off each time.</p>	 <p>The 3 LED will turn off each time.</p>



REMOTE STARTER FUNCTIONALITY |



All doors must be closed.



Remote start the vehicle.



Unlock the doors with the remote-starter remote or the OEM remote.



Insert and Turn the key to the Ignition ON/RUN position.



Press the brake pedal.



The vehicle can now be put in to gear and driven.

STANDALONE & THAR-FOR3 INSTALLATION

ADDENDUM - SUGGESTED WIRING CONFIGURATION



ONLY COMPATIBLE WITH AUTOMATIC TRANSMISSION VEHICLES.



Vehicle functions supported in this diagram (functional if equipped)

VEHICLE	YEARS	Immobilizer bypass	Lock	Unlock	Arm	Disarm	RAP Disable	Parking Lights	Tachometer	Heated seats	Heated Mirrors	Rear defrost	Door Status	Trunk Status	Hood Status*	Hand-Brake Status	Foot-Brake Status	Active OEM Remote Start
FORD																		
F-150	Push-to-start 2020	•	•	•	•	•	•	•	•	•	•	•	•	•	•	•	•	•
F-250	Push-to-start 2020	•	•	•	•	•	•	•	•	•	•	•	•	•	•	•	•	•
F-350	Push-to-start 2020	•	•	•	•	•	•	•	•	•	•	•	•	•	•	•	•	•
F-450	Push-to-start 2020	•	•	•	•	•	•	•	•	•	•	•	•	•	•	•	•	•

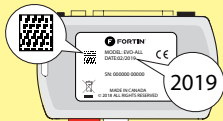

COMPATIBLE MODULE REQUIRED:

QR CODE ON THE LABEL
MANUFACTURED AFTER: 2019

FIRMWARE VERSION

58.[02]
MINIMUM

To add the firmware version and the options, use the **FLASH LINK UPDATER** or **FLASH LINK MOBILE** tool, sold separately.



Program bypass option:

UNIT OPTION

DESCRIPTION

C1

OEM Remote status (Lock/Unlock) monitoring

D6

Push-to-Start

IF THE VEHICLE IS NOT EQUIPPED WITH FUNCTIONAL HOOD PIN:

A11

OFF

Hood trigger (Output Status).

NOTES

The vehicles OEM remote and SmartKey are still operable during remote start.

**Heated seats The heated seats and rear defrost activate automatically when it cold.

***Parking Lights The parking Lights at remote start only.

MANDATORY INSTALL

*HOOD PIN



HOOD STATUS: THE HOOD PIN SWITCH MUST BE INSTALLED IF THE VEHICLE CAN BE REMOTE STARTED WITH THE HOOD OPEN, SET FUNCTION A11 TO OFF.

A11

OFF

Notice: the installation of safety elements are mandatory. The hood pin is an essential security element and must be installed.

THIS MODULE MUST BE INSTALLED BY A QUALIFIED TECHNICIAN. A WRONG CONNECTION CAN CAUSE PERMANENT DAMAGE TO THE VEHICLE.

PARTS REQUIRED (NOT INCLUDED)

1x **FLASH LINK UPDATER,**
1x **FLASH LINK MANAGER**
SOFTWARE | PROGRAMME
1x Microsoft Windows Computer with Internet connection

OR

1x **FLASH LINK MOBILE**
1x **FLASH LINK MOBILE APP**
Smartphone Android or iOS with Internet connection (provider charges may apply).

MANDATORY

HOOD PIN



REMOTE START SAFETY OVERRIDE SWITCH

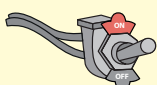







VALET SWITCH

Part #: RSPB available, Sold separately.

Notice: the installation of safety elements are mandatory. The hood pin and the valet switch are essential security elements and must be installed.

STAND ALONE CONFIGURATION

	Program bypass option	UNIT OPTION	DESCRIPTION
	OEM Remote Stand Alone Remote Starter:	D1.10 	By default, LOCK, LOCK, LOCK
		D1.1 	Par défaut, VERROUILLE, VERROUILLE, VERROUILLE
	Program bypass option with oem remote:	C1	OEM Remote Monitoring
	Program bypass option with RF KIT antenna:	H1 to H6	Supported RF Kits and select RF Kit
	Program bypass option Vehicle hybrid only:	D4	Hybrid mode (Vehicle hybrid only)

REMOTE STARTER FUNCTIONALITY



All doors must be closed.

3X 

Press the OEM remote's Lock button 3x to remote-start (or remote-stop) the vehicle.



START

The vehicle will START.

REMOTE STARTER DIAGNOSTICS
MODULE RED LED

x2 flash :	Brake ON
x3 flash :	No tach
x4 flash :	Ignition before start
x5 flash :	Hood Open

REMOTE STARTER WARNING CARD



CUT THIS WARNING CARD AND STICK IT ON A VISIBLE PLACE:
or use the package RSPB, Sold separately.

WARNING | ATTENTION



REMOTE STARTER

THE VEHICLE CAN BE STARTED BY EITHER: PRESSING THE LOCK BUTTON ON THE OEM REMOTE 3 TIMES CONSECUTIVELY OR BY A SMARTPHONE. **TURN ON** THE SAFETY SWITCH LOCATED UNDER THE DASHBOARD BEFORE WORKING ON THE VEHICLE.

DESCRIPTION

	Parts required (Not included)	PAGE
--	-------------------------------	------

WIRE TO WIRE DIAGRAM

AUTOMATIC TRANSMISSION	1x 7.5 Amp. fuse	Page 3
------------------------	------------------	--------

THARNES DIAGRAM

THARNES THAR-FOR3 AUTOMATIC TRANSMISSION	1x THAR-FOR3	Page 4
--	--------------	--------



① Gateway module, located at dash board driver's side,

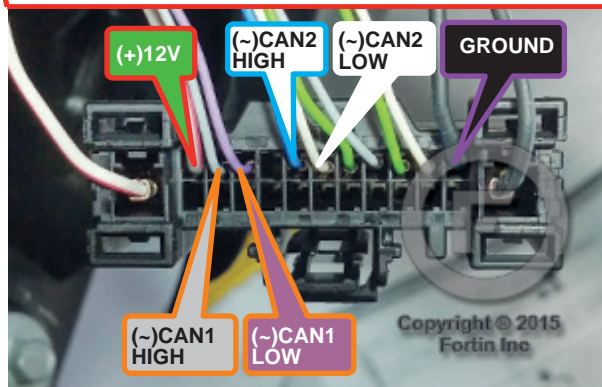

② Under the hood If not equipped with hood pin.

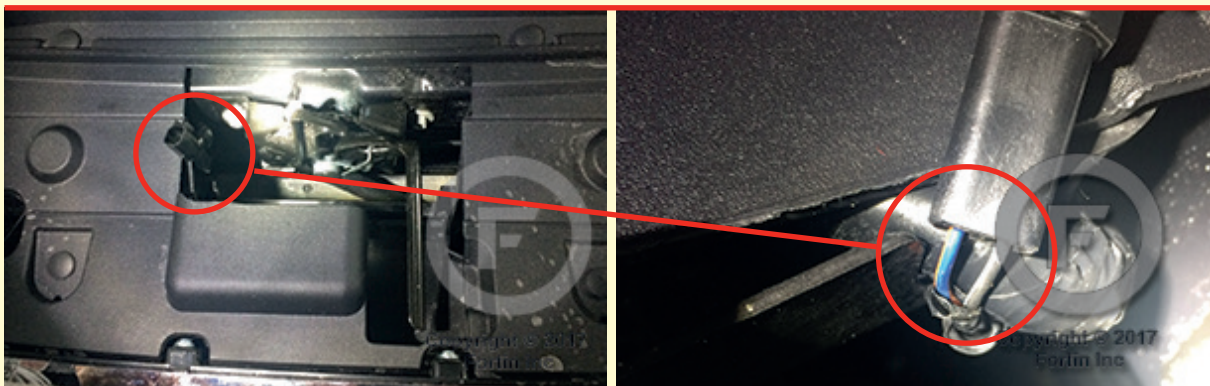

AUTOMATIC TRANSMISSION WIRING CONNECTION |

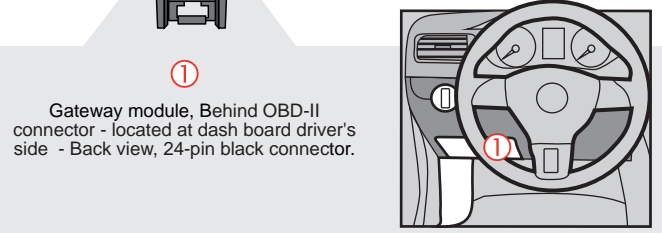
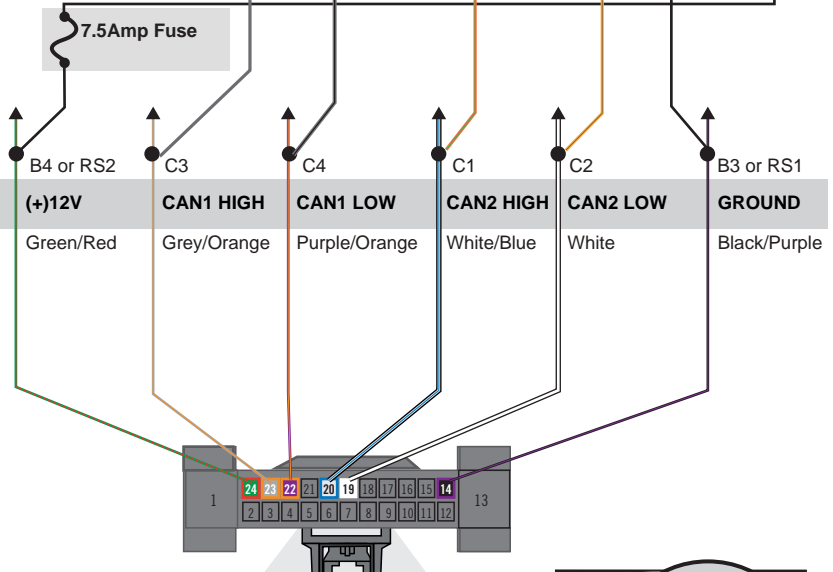
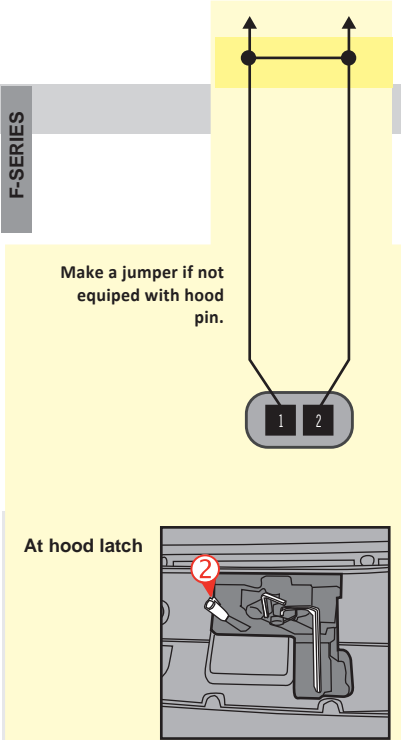
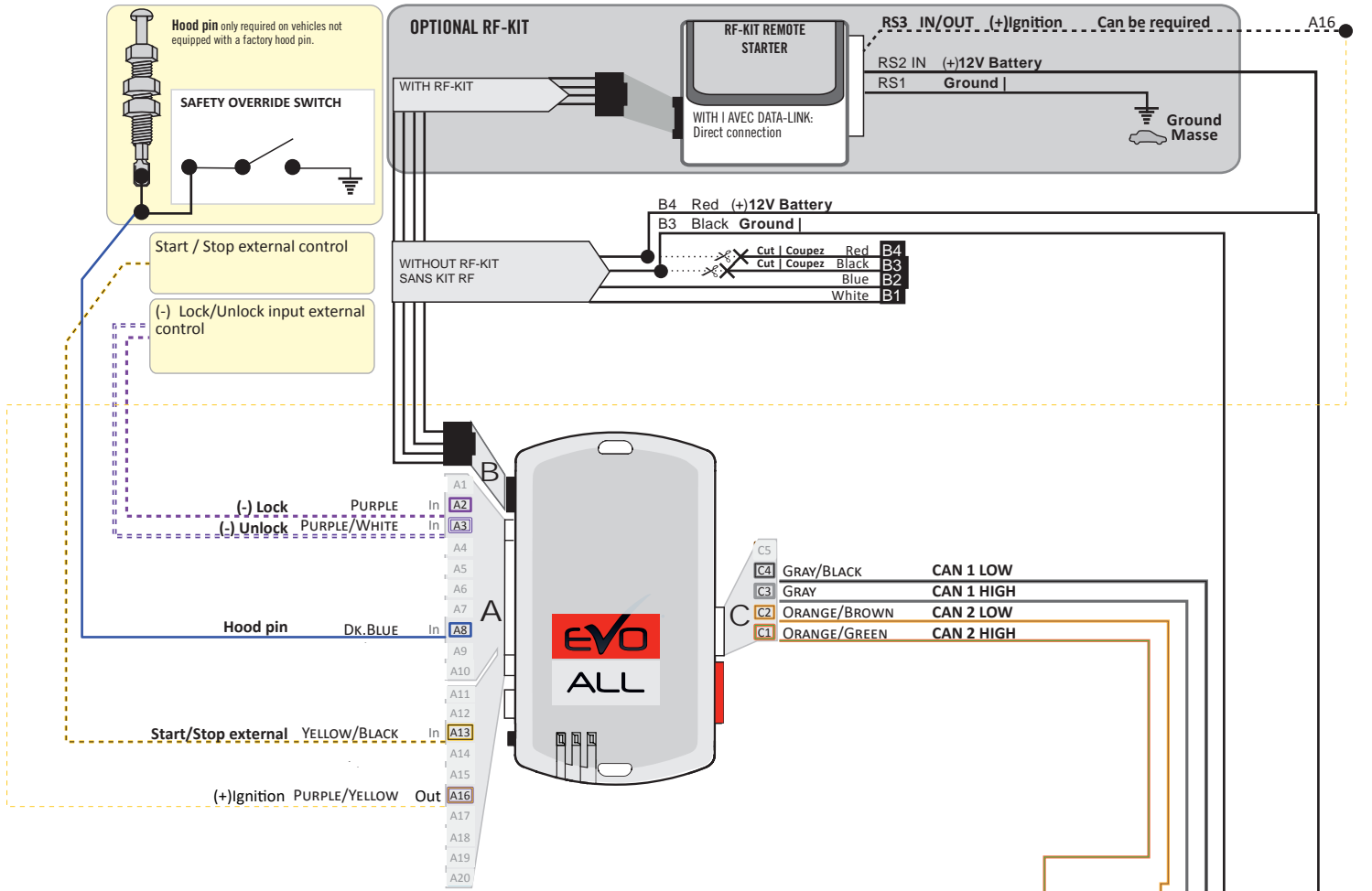

THAR-FOR3 | T-HARNESS - AUTOMATIC TRANSMISSION |

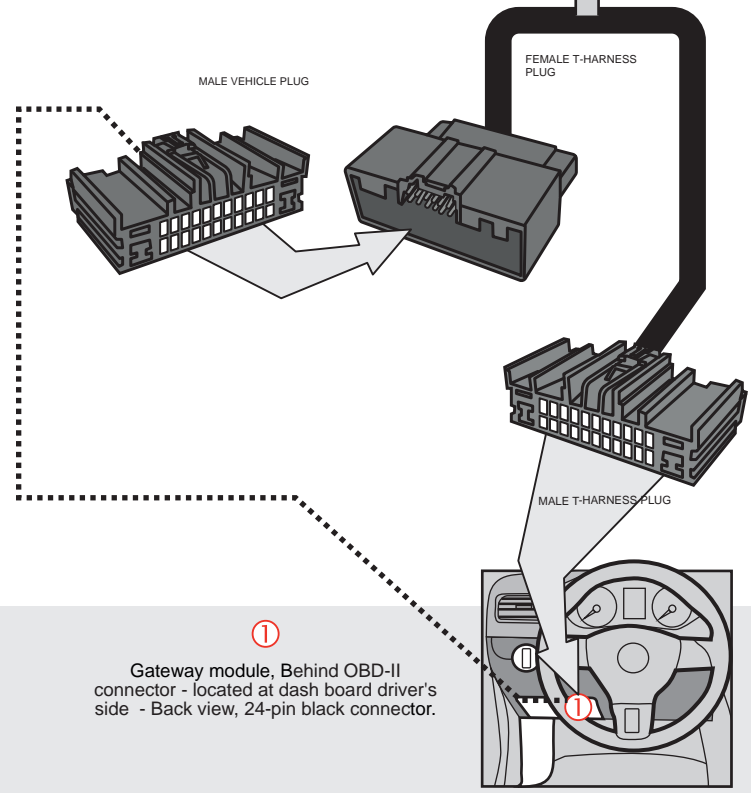
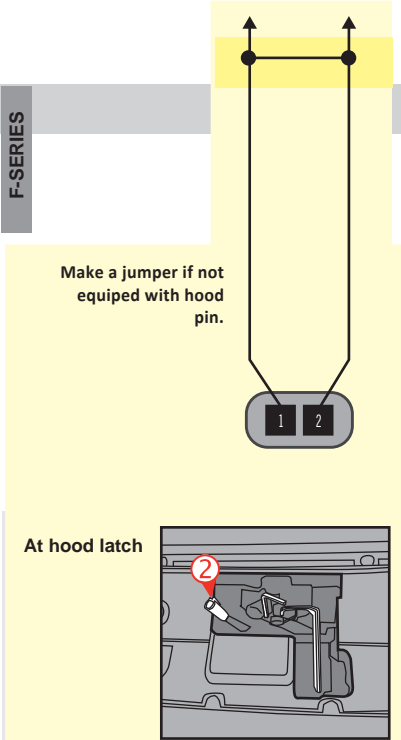
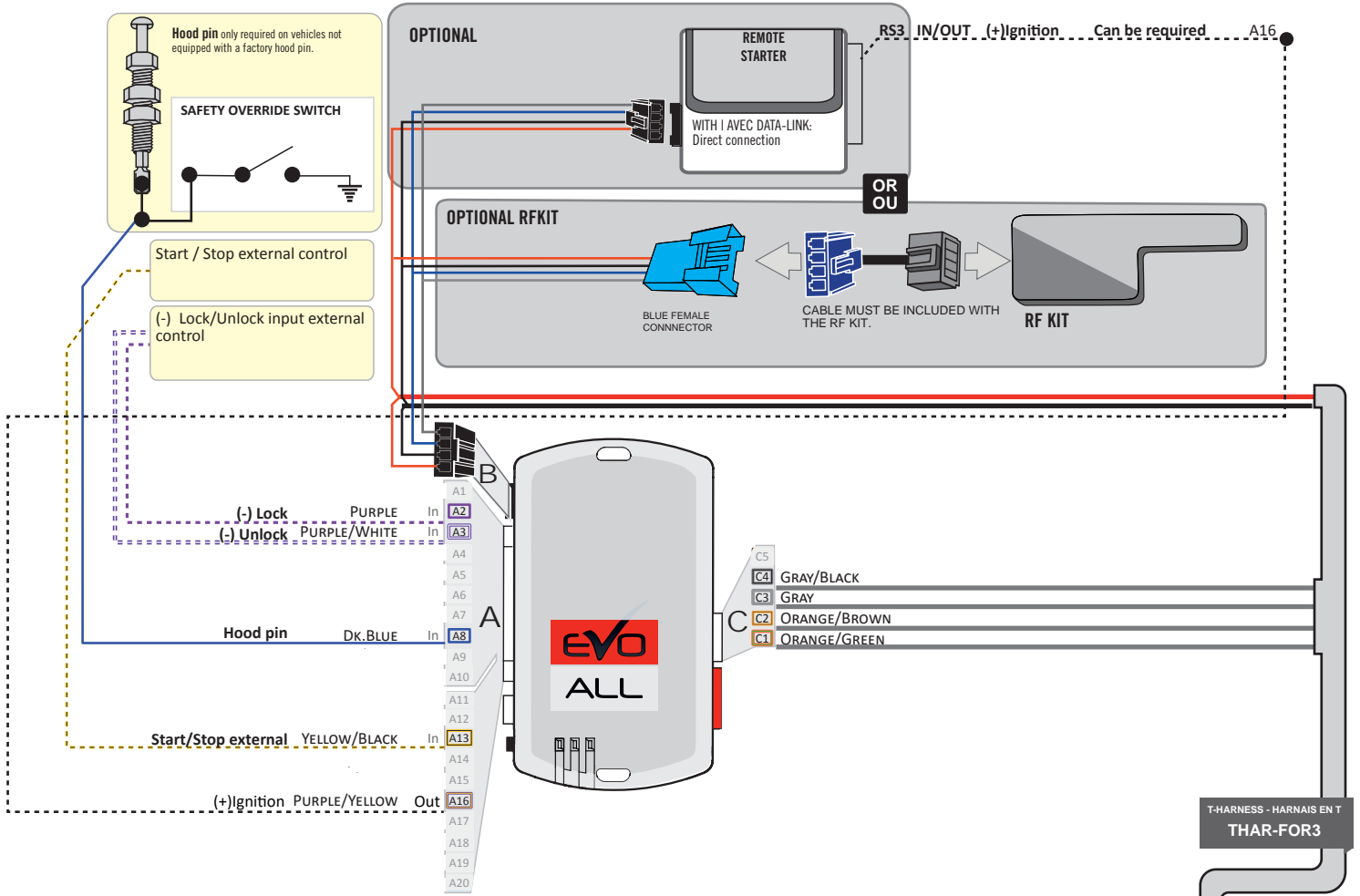



Parts required (not included)

- 1x FLASH LINK UPDATER, SOFTWARE | PROGRAMME
- 1x FLASH LINK MANAGER
- 1x Microsoft Windows Computer with Internet connection

OR

- 1x FLASH LINK MOBILE
- 1x FLASH LINK MOBILE APP
- 1x Smartphone Android or iOS with Internet connection (Internet provider charges may apply)

BEFORE PROGRAMMING SET THE UNIT OPTIONS AND SAVE.

1

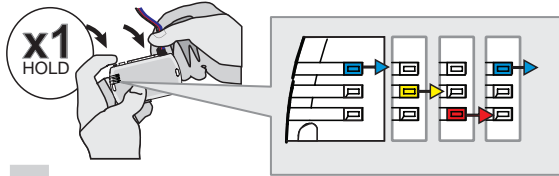

Press and hold the programming button:
Insert the 4-Pin (Data-Link) connector.

↳ The Blue, Red, Yellow and Blue & Red LEDs will alternatively illuminate.

2

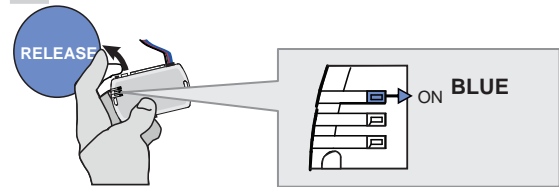

Release the programming button when the LED is BLUE.

If the LED is not solid BLUE disconnect the 4-Pin connector (Data-Link) and go back to step 1.

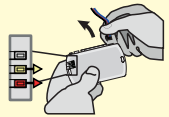

3

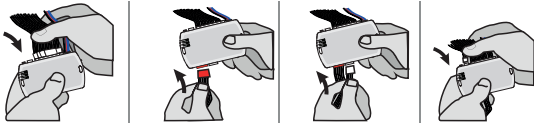

Insert the required remaining connectors.

4

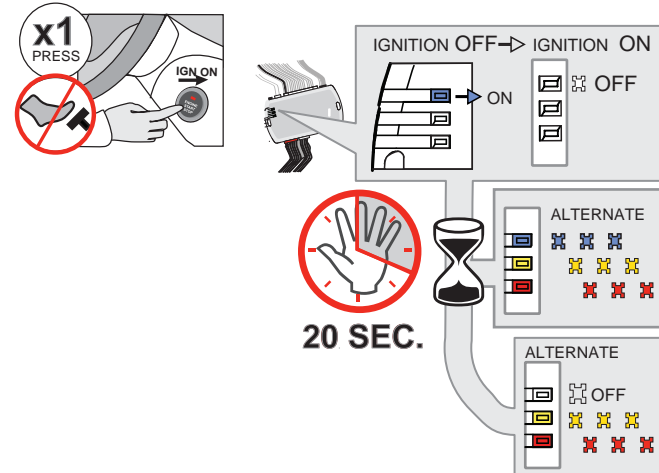

Do not press the brake pedal.
Press the Push-to-Start button once to turn on the ignition.

↳ The BLUE LED will turn OFF.

↳ The BLUE, YELLOW and RED LEDs will alternate.

Wait, at least 20 seconds, do not disconnect the modules or turn off the ignition.

↳ The RED and YELLOW LEDs will alternate.

Make sure that the DELs are flashing RED and YELLOW before continuing programming.

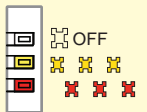

5

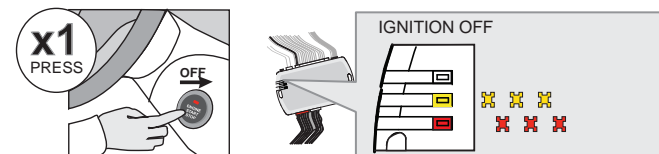

Press the Push-to-Start button once to turn off the ignition.

↳ The RED and YELLOW LEDs alternate.

KEY BYPASS PROGRAMMING PROCEDURE 2/2 |

6

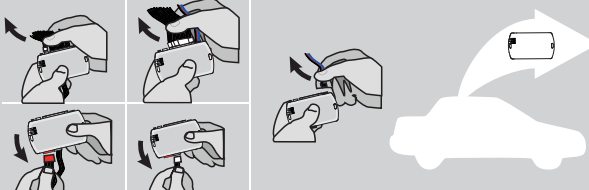

Disconnect all the connectors and after the Data-Link (4-pins) connector.

7



Microsoft Windows Computer with Internet connection*

FLASH LINK UPDATER* **FLASH LINK MANAGER***
SOFTWARE | PROGRAMME

OR

Smartphone* (Internet provider charges may apply)

VEHICLE'S OBDII CONNECTOR **FLASH LINK MOBILE***

Use the tool: FLASH LINK UPDATER or FLASH LINK MOBILE to visit the DCRYPTOR menu.

*Parts required (not included)

8

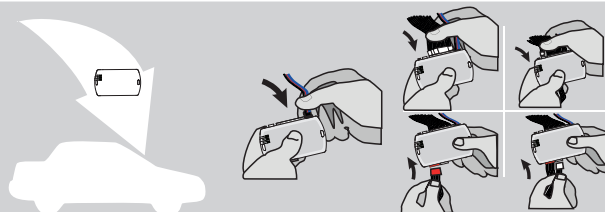

AFTER DCRYPTOR PROGRAMMING COMPLETED
Go back to the vehicle and reconnect the 4-Pin (Data-Link) connector and after, all the remaining connector.

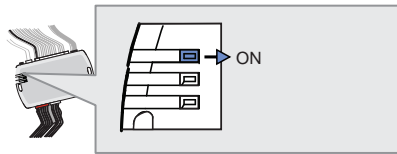

↳ The BLUE LED will turn ON.

9



x1 PRESS

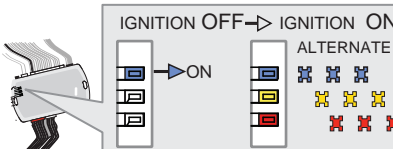

IGNITION OFF → IGNITION ON

ALTERNATE

ON

↳ The RED and YELLOW LEDs will turn ON.



20 SEC.

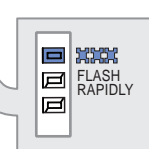

FLASH RAPIDLY

Do not press the brake pedal. **Press** the Push-to-Start button once to turn on the ignition.

↳ The RED and YELLOW LEDs will turn ON.

Wait, at least 20 seconds, do not disconnect the modules or turn off the ignition.

↳ The BLUE LED will flash rapidly.

10

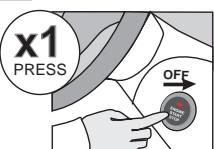

x1 PRESS

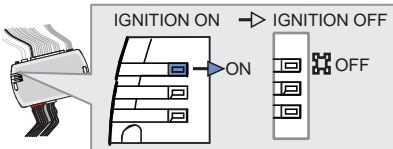

IGNITION ON → IGNITION OFF

ON

OFF

Press the Push-to-Start button once to turn off the ignition.

↳ The BLUE will turn OFF.



The module is now programmed.



OPTIONAL RF-KIT PROGRAMMING |

PROGRAM BYPASS OPTION I







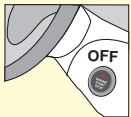

	<p>Program bypass option:</p>	<p>H2</p>	<p><input checked="" type="checkbox"/> Supported RF-KITS enable <input checked="" type="checkbox"/> H2 Fortin 2</p>
---	-------------------------------	------------------	---

OPTIONAL FORTIN RF KIT SERIES 4 OR SERIES 9 PROGRAMMING

The module must be programmed on the vehicle.



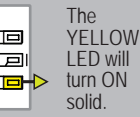
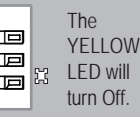
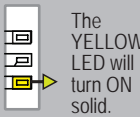
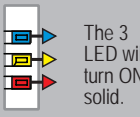
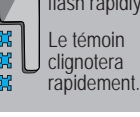
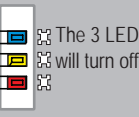
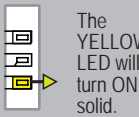
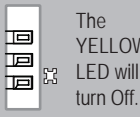



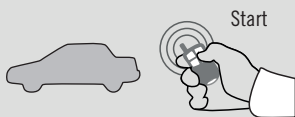

MAKE SURE THE IGNITION KEY HAS BEEN IN THE OFF POSITION FOR AT LEAST 5 SECONDS.

<p>1</p> <p>ON x1 PRESS</p>  <p>Do not press the brake pedal. Press the Push-to-Start button once to turn on the ignition.</p>	<p>2</p> <p>OFF x1 PRESS</p>  <p>Press the Push-to-Start button once to turn off the ignition.</p>	<p>3</p> <p>ON x1 PRESS</p>  <p>Do not press the brake pedal. Press the Push-to-Start button once to turn on the ignition.</p>	<p>4</p> <p>4X BRAKES</p> <p>x4 PRESS</p>  <p>Press and release the brake pedal four times.</p>	<p>5</p> <p>ON EACH TRANSMITTER</p> <p>4 BUTTONS</p> <p>[-] PRESS AND RELEASE</p> <p>→ PRESS AND RELEASE</p> <p>1 BUTTON</p> <p>PRESS APPROX. 12 SEC. AND WAIT FOR THE BLUE LED TO TURN OFF THEN BACK ON SOLID THEN RELEASE.</p>	<p>6</p> <p>OFF x1 PRESS</p>  <p>Press the Push-to-Start button once to turn off the ignition.</p>	<p>7</p> <p>ON x1 PRESS</p>  <p>Do not press the brake pedal. Press the Push-to-Start button once to turn on the ignition and leave it ON for 5 sec..</p>	<p>8</p> <p>OFF x1 PRESS</p>  <p>Press the Push-to-Start button once to turn off the ignition.</p>
 <p>The YELLOW LED will turn ON solid.</p>	 <p>The YELLOW LED will turn Off.</p>	 <p>The LED will turn ON solide.</p> <p>The YELLOW LED will turn ON solid.</p>	 <p>The LED will flash rapidly.</p> <p>The 3 LED will turn ON solid.</p>	 <p>The LED will turn off each time.</p> <p>The LED will flash rapidly.</p> <p>Le témoin clignotera rapidement.</p>	 <p>The LED will turn Off.</p> <p>The 3 LED will turn off.</p>	 <p>The YELLOW LED will turn ON solid.</p>	 <p>The LED will turn Off.</p> <p>The YELLOW LED will turn Off.</p>
 <p>The 3 LED will turn off each time.</p>							

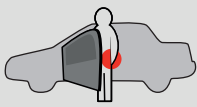

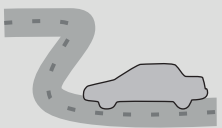
REMOTE STARTER FUNCTIONALITY |

 <p>Start</p> <p>All doors must be closed.</p> <p>Remote start the vehicle.</p>	 <p>UNLOCK</p> <p>Unlock the doors with either:</p> <ul style="list-style-type: none"> • The OEM remote • The remote-starter remote • Or the proximity remote 	 <p>Enter the vehicle with the SMART-KEY.</p>	 <p>DO NOT PRESS THE BRAKE PEDAL.</p> <p>Press and release the Push-to-Start button once.</p>	 <p>Press the brake pedal. The vehicle can now be put in to gear and driven.</p> <p>If the Smart-Key is not detected the vehicle will shut down.</p>
--	---	--	---	---

STANDALONE & THAR-FOR3 INSTALLATION

ADDENDUM - SUGGESTED WIRING CONFIGURATION



ONLY COMPATIBLE WITH AUTOMATIC TRANSMISSION VEHICLES.



Vehicle functions supported in this diagram (functional if equipped)

VEHICLE	YEARS	Immobilizer bypass Contournement	T-Harness available (sold separately)	Lock	Unlock	Arm	Disarm	Heated Seats**	Rear Defrost**	RAP Disable	Parking Lights***	Tachometer	Door Status	Trunk Status	Hood Status*	Hand-Brake Status	Foot-Brake Status	Active OEM Remote Start	
FORD																			
Fusion	Key 2020	•	•	•	•	•	•	•	•	•	•	•	•	•	•	•	•	•	•
	Hybrid Key 2020	•	•	•	•	•	•	•	•	•	•	•	•	•	•	•	•	•	•

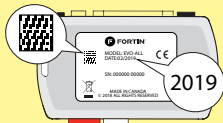

COMPATIBLE MODULE REQUIRED:

QR CODE ON THE LABEL
MANUFACTURED AFTER: 2019

FIRMWARE VERSION

58.[02]
MINIMUM

To add the firmware version and the options, use the **FLASH LINK UPDATER** or **FLASH LINK MOBILE** tool, sold separately.

UNIT OPTION	DESCRIPTION
C1	OEM Remote status (Lock/Unlock) monitoring
A11 OFF	Hood trigger (Output Status).
D4	Hybrid mode (Vehicle hybrid only)

NOTES

The vehicles OEM remote and SmartKey are still operable during remote start.

**Heated seats The heated seats and rear defrost activate automatically when it cold.

***Parking Lights The parking Lights at remote start only.



The vehicle must be equipped with the OEM remote with the door locks.

MANDATORY INSTALL

*HOOD PIN



HOOD STATUS: THE HOOD PIN SWITCH MUST BE INSTALLED IF THE VEHICLE CAN BE REMOTE STARTED WITH THE HOOD OPEN, SET FUNCTION A11 TO OFF.

A11

OFF

Notice: the installation of safety elements are mandatory. The hood pin is an essential security element and must be installed.

THIS MODULE MUST BE INSTALLED BY A QUALIFIED TECHNICIAN. A WRONG CONNECTION CAN CAUSE PERMANENT DAMAGE TO THE VEHICLE.

PARTS REQUIRED (NOT INCLUDED) |

1x **FLASH LINK UPDATER,**
1x **FLASH LINK MANAGER**
SOFTWARE | PROGRAMME
1x Microsoft Windows Computer with Internet connection

OR

1x **FLASH LINK MOBILE**
1x **FLASH LINK MOBILE APP**
Smartphone *Android* or *iOS* with Internet connection (*provider charges may apply*).

MANDATORY

HOOD PIN



REMOTE START SAFETY OVERRIDE SWITCH

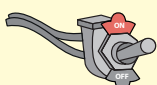







VALET SWITCH

Part #: RSPB available, Sold separately.

Notice: the installation of safety elements are mandatory. The hood pin and the valet switch are essential security elements and must be installed.

STAND ALONE CONFIGURATION |

	Program bypass option	UNIT OPTION	DESCRIPTION
	OEM Remote Stand Alone Remote Starter:	D1.10 	By default, LOCK, LOCK, LOCK
		D1.1 	Par défaut, VERROUILLE, VERROUILLE, VERROUILLE
	Program bypass option with oem remote:	C1	OEM Remote Monitoring
	Program bypass option with RF KIT antenna:	H1 to H6	Supported RF Kits and select RF Kit
	Program bypass option Vehicle hybrid only:	D4	Hybrid mode (Vehicle hybrid only)

REMOTE STARTER FUNCTIONALITY |



All doors must be closed.

3X 

Press the OEM remote's Lock button 3x to remote-start (or remote-stop) the vehicle.



START 

The vehicle will START.

REMOTE STARTER DIAGNOSTICS

MODULE RED LED

x2 flash : Brake ON

x3 flash : No tach

x4 flash : Ignition before start

x5 flash : Hood Open

REMOTE STARTER WARNING CARD |



CUT THIS WARNING CARD AND STICK IT ON A VISIBLE PLACE:
or use the package RSPB, Sold separately.

WARNING



REMOTE STARTER

THE VEHICLE CAN BE STARTED BY EITHER: PRESSING THE LOCK BUTTON ON THE OEM REMOTE 3 TIMES CONSECUTIVELY OR BY A SMARTPHONE. **TURN ON** THE SAFETY SWITCH LOCATED UNDER THE DASHBOARD BEFORE WORKING ON THE VEHICLE.

DESCRIPTION |

Parts required (Not included) **PAGE**

WIRE TO WIRE DIAGRAM

AUTOMATIC TRANSMISSION	1x 7.5 Amp. fuse	Page 3
------------------------	------------------	--------

THARNESSE DIAGRAM

THARNESSE THAR-FOR3 AUTOMATIC TRANSMISSION	1x THAR-FOR3	Page 4
--	--------------	--------



② Parking Lights switch

① Gateway module, Behind OBD-II connector

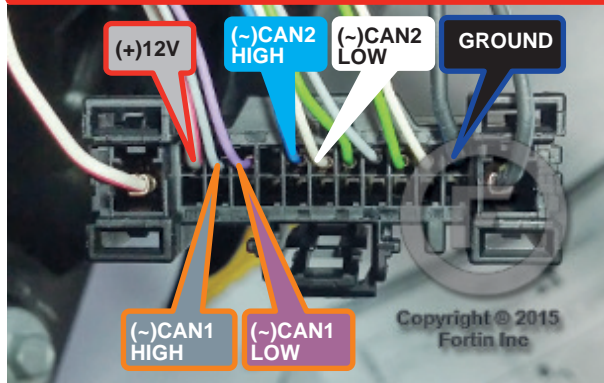
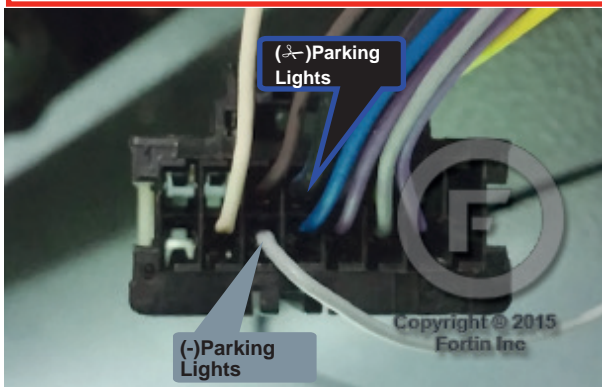

AUTOMATIC TRANSMISSION WIRING |

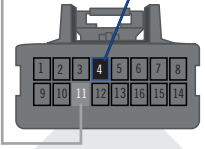
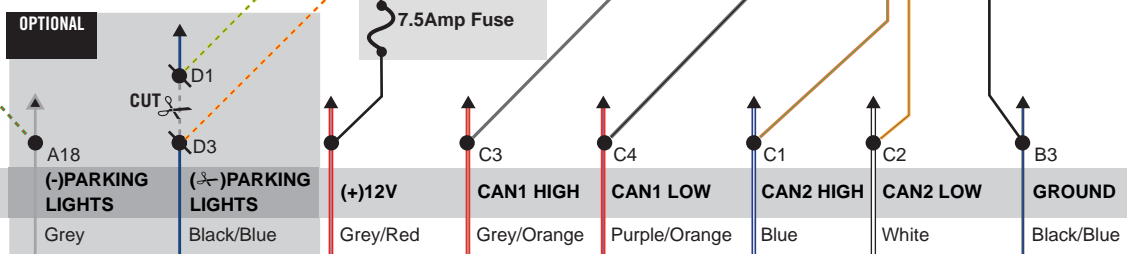
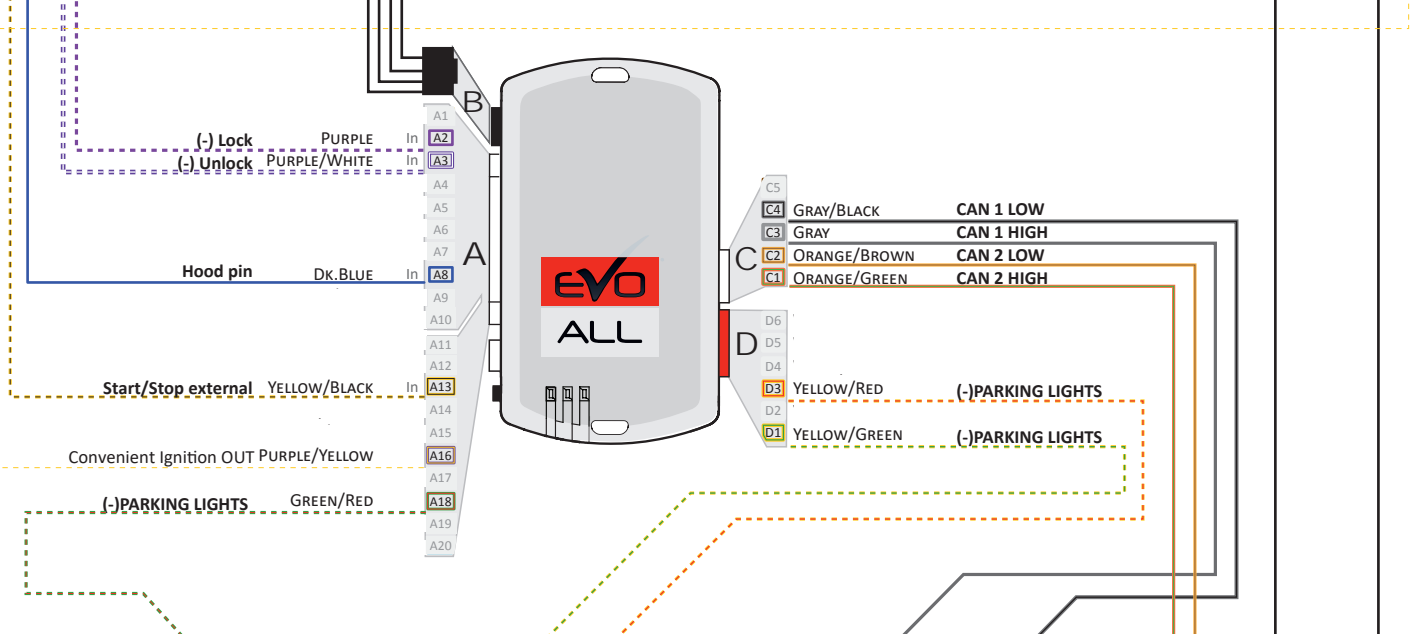
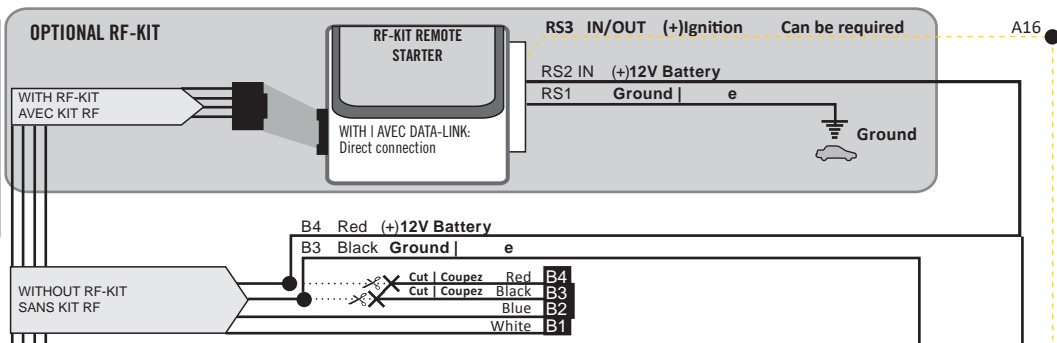
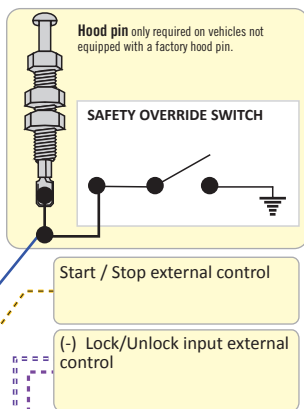

② Parking Lights switch
Back view, 14-pin black connector.

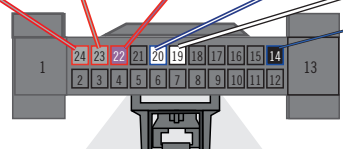

① Gateway module, Connector Behind OBD-II connector - located at dash board driver's side
Back view, 24-pin black connector.

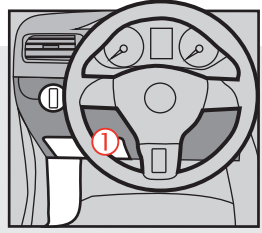



Parts required (not included)

- 1x **FLASH LINK UPDATER,**
- 1x **FLASH LINK MANAGER**
SOFTWARE | PROGRAMME
- 1x Microsoft Windows Computer with Internet connection

OR

- 1x **FLASH LINK MOBILE**
- 1x **FLASH LINK MOBILE APP**
- Smartphone *Android* or *iOS* with Internet connection
(Internet provider charges may apply)

BEFORE PROGRAMMING SET THE UNIT OPTIONS AND SAVE.

1

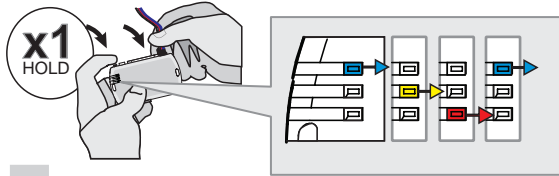

Press and hold the programming button:
Insert the 4-Pin (Data-Link) connector.

↳ The Blue, Red, Yellow and Blue & Red LEDs will alternatively illuminate.

2

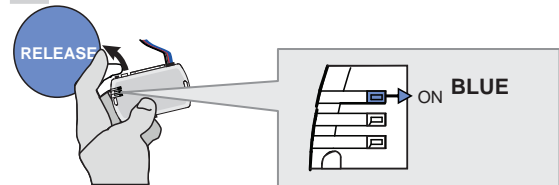

Release the programming button when the LED is BLUE.

If the LED is not solid BLUE disconnect the 4-Pin connector (Data-Link) and go back to step 1.

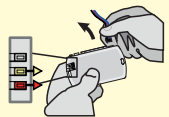

3

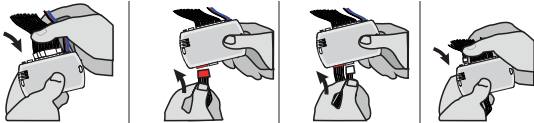

Insert the required remaining connectors.

4

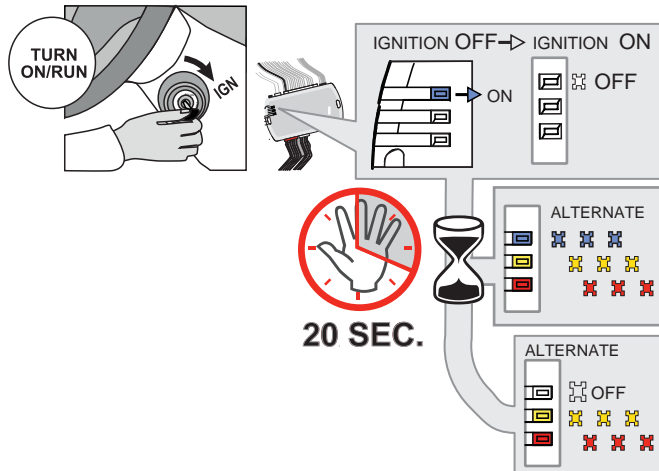

Turn the key to the Ignition ON/RUN position.

↳ The BLUE LED will turn OFF.

↳ The BLUE, YELLOW and RED LEDs will alternated.

Wait, at least 20 seconds, do not disconnect the modules or turn off the ignition.

↳ The RED and YELLOW LEDs will alternated.

Make sure that the DELs are flashing RED and YELLOW before continuing programming.

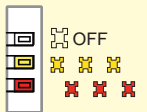

5

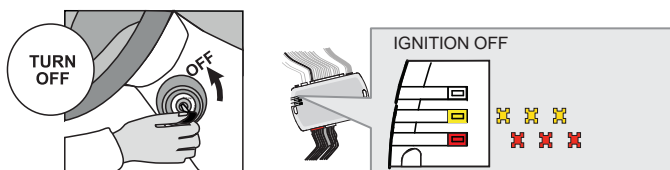

Turn the key to the OFF position.

↳ The RED and YELLOW LEDs alternate.

KEY BYPASS PROGRAMMING PROCEDURE 2/2 |

6

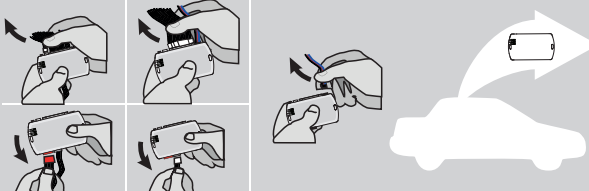

Disconnect all the connectors and after the Data-Link (4-pins) connector.

7



Microsoft Windows Computer with Internet connection*

FLASH LINK UPDATER* **FLASH LINK MANAGER***
SOFTWARE | PROGRAMME

OR

Smartphone* (Internet provider charges may apply)

VEHICLE'S OBDII CONNECTOR **FLASH LINK MOBILE***

Use the tool: FLASH LINK UPDATER or FLASH LINK MOBILE to visit the DCRYPTOR menu.

*Parts required (not included)

8

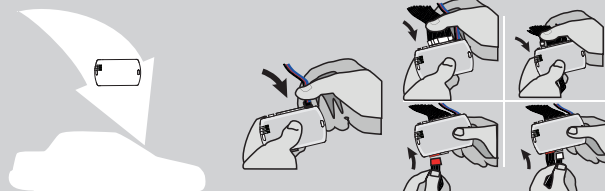

AFTER DCRYPTOR PROGRAMMING COMPLETED
Go back to the vehicle and reconnect the 4-Pin (Data-Link) connector and after, all the remaining connector.



↳ The BLUE LED will turn ON.

9

TURN ON/RUN

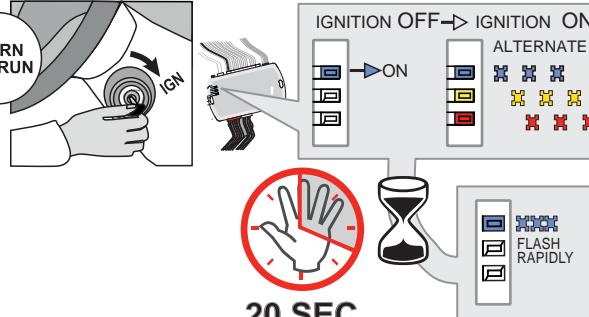

IGNITION OFF → IGNITION ON

ALTERNATE

↳ The RED and YELLOW LEDs will turn ON.

Wait, at least 20 seconds, do not disconnect the modules or turn off the ignition.

↳ The BLUE LED will flash rapidly.

20 SEC.

FLASH RAPIDLY

10

TURN OFF

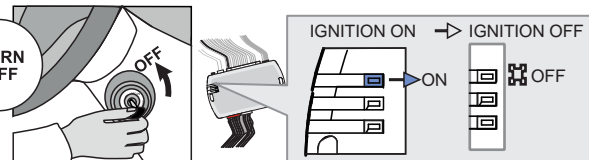

IGNITION ON → IGNITION OFF

↳ The BLUE will turn OFF.



The module is now programmed.









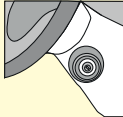

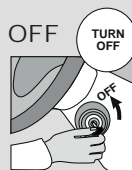
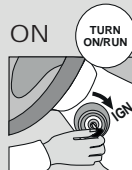

OPTIONAL RF-KIT PROGRAMMING |

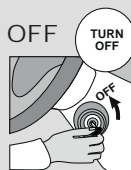
PROGRAM BYPASS OPTION

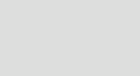
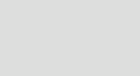
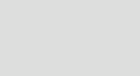
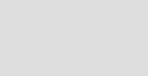
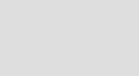
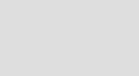
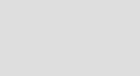
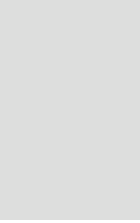
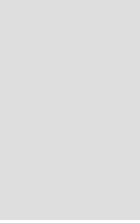
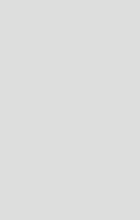
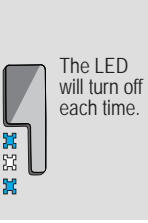
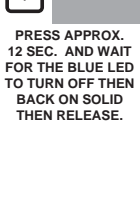
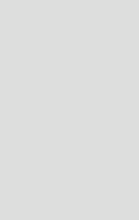
	Program bypass option:	H2	<input checked="" type="checkbox"/> Supported RF-KITS enable <input checked="" type="checkbox"/> H2 Fortin 2 <input checked="" type="checkbox"/>
--	------------------------	-----------	---

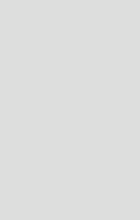
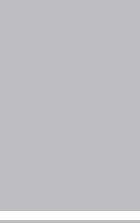
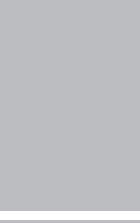
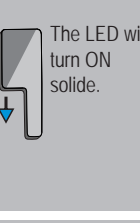
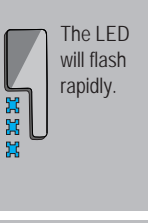
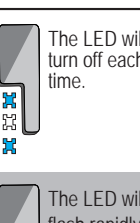
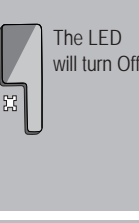
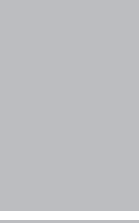
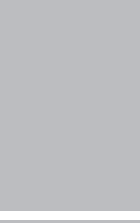
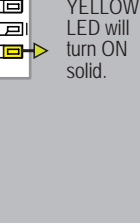
OPTIONAL FORTIN RF KIT SERIES 4 OR SERIES 9 PROGRAMMING

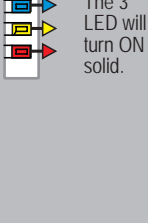
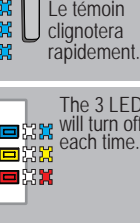
The module must be programmed on the vehicle.   **MAKE SURE THE IGNITION KEY HAS BEEN IN THE OFF POSITION FOR AT LEAST 5 SECONDS.**

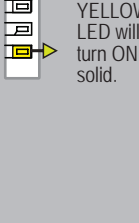
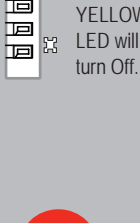
<p>1</p>  <p>ON TURN ON/RUN</p>	<p>2</p>  <p>OFF TURN OFF</p>	<p>3</p>  <p>ON TURN ON/RUN</p>	<p>4</p> <p>4X BRAKES</p>  <p>x4 PRESS</p>	<p>5</p> <p>ON EACH TRANSMITTER</p> <p>4 BUTTONS</p>  PRESS AND RELEASE  PRESS AND RELEASE 	<p>6</p>  <p>OFF TURN OFF</p>	<p>7</p>  <p>ON TURN ON/RUN</p>	<p>8</p>  <p>OFF TURN OFF</p>
<p>Turn the key to the ON/RUN position.</p>	<p>Turn the ignition to the OFF position.</p>	<p>Turn the key to the ON/RUN position.</p>	<p>Press and release the brake pedal four times.</p>	<p>4 BUTTONS</p> <p>[-] PRESS AND RELEASE</p> <p>→ PRESS AND RELEASE</p> <p>🔒</p>	<p>Turn the ignition to the OFF position.</p>	<p>Turn the key to the ON/RUN position and leave it ON for 5 sec.</p>	<p>Turn the ignition to the OFF position.</p>
 <p>The YELLOW LED will turn ON solid.</p>	 <p>The YELLOW LED will turn Off.</p>	 <p>The YELLOW LED will turn ON solid.</p>	 <p>The LED will turn off each time.</p>	<p>1 BUTTON</p> <p>PRESS APPROX. 12 SEC. AND WAIT FOR THE BLUE LED TO TURN OFF THEN BACK ON SOLID THEN RELEASE.</p>	 <p>The LED will turn Off.</p>	 <p>The YELLOW LED will turn ON solid.</p>	 <p>The YELLOW LED will turn Off.</p>
 <p>The LED will turn ON solide.</p>	 <p>The LED will flash rapidly.</p>	 <p>The LED will flash rapidly.</p>	 <p>The LED will turn off each time.</p>	 <p>The LED will turn off each time.</p>	 <p>The LED will turn Off.</p>	 <p>The LED will turn ON solid.</p>	 <p>The LED will turn Off.</p>
 <p>The 3 LED will turn ON solid.</p>	 <p>The 3 LED will turn ON solid.</p>	 <p>The 3 LED will turn ON solid.</p>	 <p>The LED will flash rapidly.</p>	 <p>The LED will flash rapidly.</p>	 <p>The LED will turn Off.</p>	 <p>The 3 LED will turn off.</p>	 <p>The 3 LED will turn off.</p>
 <p>The 3 LED will turn off each time.</p>	 <p>The 3 LED will turn off each time.</p>	 <p>The 3 LED will turn off each time.</p>	 <p>The LED will flash rapidly.</p>	 <p>The LED will flash rapidly.</p>	 <p>The LED will turn Off.</p>	 <p>The 3 LED will turn off.</p>	 <p>The 3 LED will turn off.</p>



REMOTE STARTER FUNCTIONALITY |



All doors must be closed.



Remote start the vehicle.



Unlock the doors with the remote-starter remote or the OEM remote.



Insert and Turn the key to the Ignition ON/RUN position.



Press the brake pedal.



The vehicle can now be put in to gear and driven.

STANDALONE & THAR-FOR3 INSTALLATION

ADDENDUM - SUGGESTED WIRING CONFIGURATION



ONLY COMPATIBLE WITH AUTOMATIC TRANSMISSION VEHICLES.



VEHICLE

YEARS

Vehicle functions supported in this diagram (functional if equipped)

VEHICLE	YEARS	Immobilizer bypass Contourment	T-Harness available (sold separately)	Lock	Unlock	Arm	Disarm	Heated Seats**	Rear Defrost**	RAP Disable	Parking Lights***	Tachometer	Door Status	Trunk Status	Hood Status*	Hand-Brake Status	Foot-Brake Status	Active OEM Remote Start	
FORD																			
Fusion	Push-to-Start 2020	•	•	•	•	•	•	•	•	•	•	•	•	•	•	•	•	•	•
	Hybrid Push-to-Start 2020	•	•	•	•	•	•	•	•	•	•	•	•	•	•	•	•	•	•
LINCOLN																			
Continental	Push-to-Start 2020	•	•	•	•	•	•	•	•	•	•	•	•	•	•	•	•	•	•

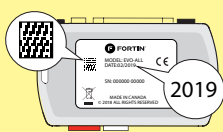

COMPATIBLE MODULE REQUIRED:

QR CODE ON THE LABEL
MANUFACTURED AFTER: 2019

FIRMWARE VERSION

58.[02]
MINIMUM

To add the firmware version and the options, use the **FLASH LINK UPDATER** or **FLASH LINK MOBILE** tool, sold separately.



Program bypass option:

UNIT OPTION

DESCRIPTION

C1

OEM Remote status (Lock/Unlock) monitoring

D6

Push-to-Start

IF THE VEHICLE IS NOT EQUIPPED WITH FUNCTIONAL HOOD PIN:

A11

OFF

Hood trigger (Output Status).

Program bypass option (Vehicle hybrid only):

D4

Hybrid mode (Vehicle hybrid only)

NOTES

The vehicles OEM remote and SmartKey are still operable during remote start.

**Heated seats The heated seats and rear defrost activate automatically when it cold.

***Parking Lights The parking Lights at remote start only.

MANDATORY INSTALL

*HOOD PIN



HOOD STATUS: THE HOOD PIN SWITCH MUST BE INSTALLED IF THE VEHICLE CAN BE REMOTE STARTED WITH THE HOOD OPEN, SET FUNCTION A11 TO OFF.

A11

OFF

Notice: the installation of safety elements are mandatory. The hood pin is an essential security element and must be installed.

THIS MODULE MUST BE INSTALLED BY A QUALIFIED TECHNICIAN. A WRONG CONNECTION CAN CAUSE PERMANENT DAMAGE TO THE VEHICLE.

PARTS REQUIRED (NOT INCLUDED) |

1x **FLASH LINK UPDATER,**
1x **FLASH LINK MANAGER**
SOFTWARE | PROGRAMME
1x Microsoft Windows Computer with Internet connection

OR

1x **FLASH LINK MOBILE**
1x **FLASH LINK MOBILE APP**
Smartphone *Android* or *iOS* with Internet connection (*provider charges may apply*).

MANDATORY

HOOD PIN



REMOTE START SAFETY OVERRIDE SWITCH

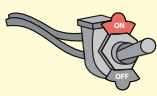







VALET SWITCH

Part #: RSPB available, Sold separately.

Notice: the installation of safety elements are mandatory. The hood pin and the valet switch are essential security elements and must be installed.

STAND ALONE CONFIGURATION |

	Program bypass option	UNIT OPTION	DESCRIPTION
	OEM Remote Stand Alone Remote Starter:	D1.10  D1.1 	By default, LOCK, LOCK, LOCK Par défaut, VERROUILLE, VERROUILLE, VERROUILLE
	Program bypass option with oem remote:	C1	OEM Remote Monitoring
	Program bypass option with RF KIT antenna:	H1 to H6	Supported RF Kits and select RF Kit
	Program bypass option Vehicle hybrid only:	D4	Hybrid mode (Vehicle hybrid only)

REMOTE STARTER FUNCTIONALITY |



All doors must be closed.

3X 

Press the OEM remote's Lock button 3x to remote-start (or remote-stop) the vehicle.



START 

The vehicle will START.

REMOTE STARTER DIAGNOSTICS

MODULE RED LED

x2 flash : Brake ON

x3 flash : No tach

x4 flash : Ignition before start

x5 flash : Hood Open

REMOTE STARTER WARNING CARD |



CUT THIS WARNING CARD AND STICK IT ON A VISIBLE PLACE:
or use the package RSPB, Sold separately.

WARNING



REMOTE STARTER

THE VEHICLE CAN BE STARTED BY EITHER: PRESSING THE LOCK BUTTON ON THE OEM REMOTE 3 TIMES CONSECUTIVELY OR BY A SMARTPHONE. **TURN ON** THE SAFETY SWITCH LOCATED UNDER THE DASHBOARD BEFORE WORKING ON THE VEHICLE.

DESCRIPTION |

Parts required (Not included) **PAGE**

WIRE TO WIRE DIAGRAM

AUTOMATIC TRANSMISSION	1x 7.5 Amp. fuse	Page 3
------------------------	------------------	--------

THARNESS DIAGRAM

THARNESS THAR-FOR3 AUTOMATIC TRANSMISSION	1x THAR-FOR3	Page 4
---	--------------	--------



② Parking Lights switch

① Gateway module, Behind OBD-II connector

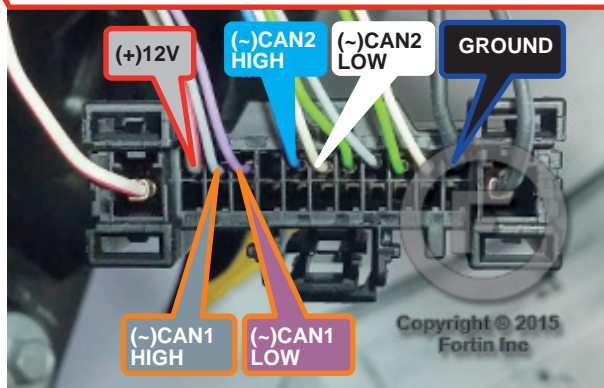
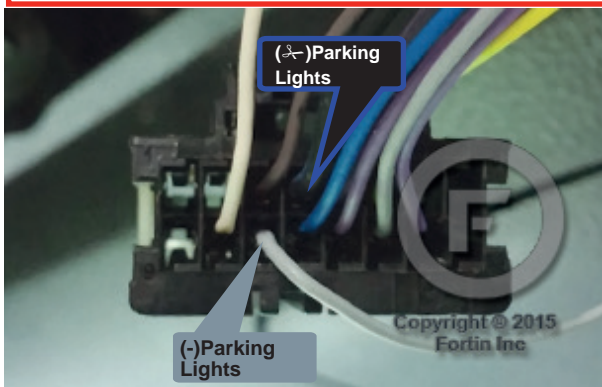

THAR-FOR3 | T-HARNESS - AUTOMATIC TRANSMISSION |

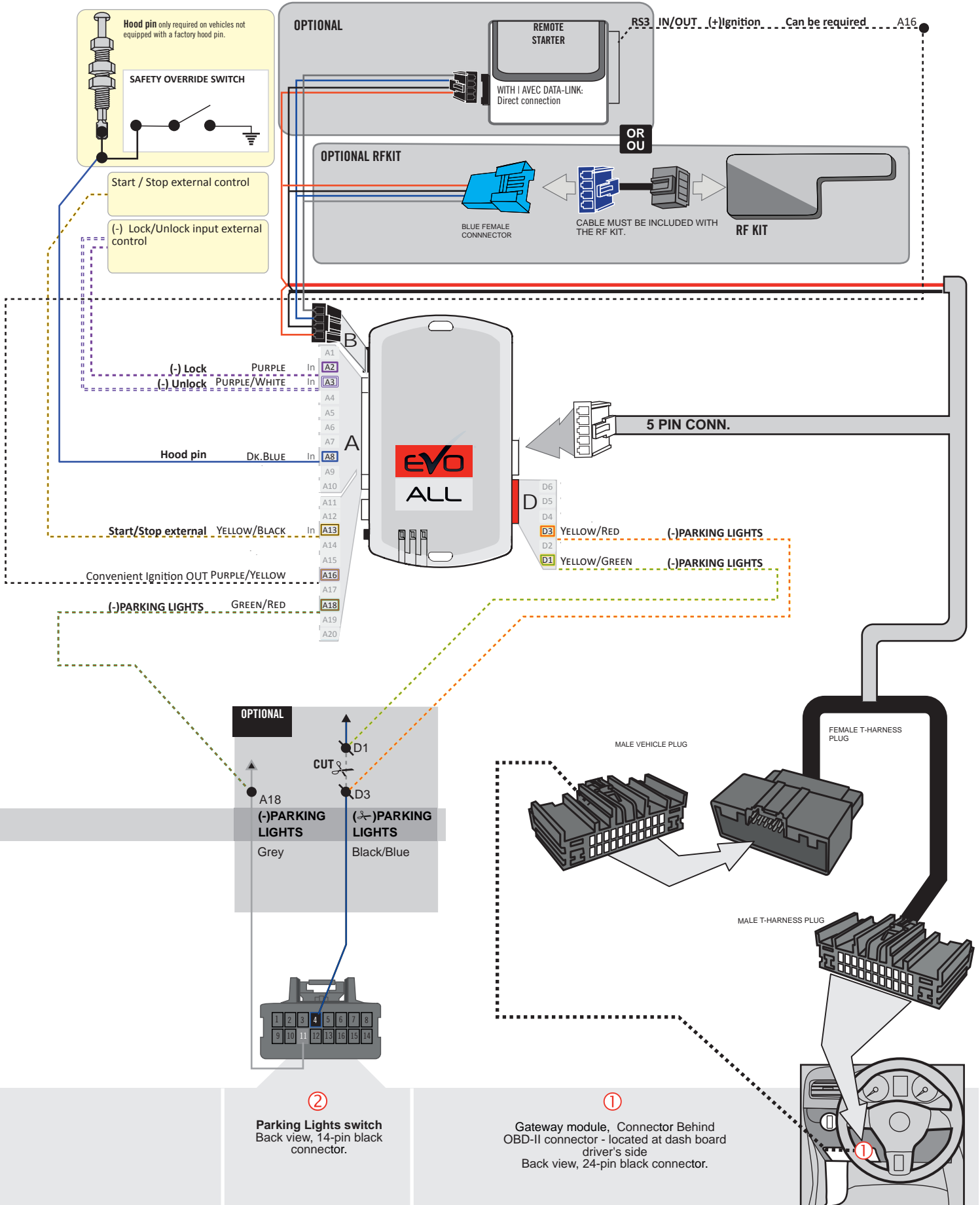



Parts required (not included)

- 1x FLASH LINK UPDATER, SOFTWARE | PROGRAMME
- 1x FLASH LINK MANAGER
- 1x Microsoft Windows Computer with Internet connection

OR

- 1x FLASH LINK MOBILE
- 1x FLASH LINK MOBILE APP
- Smartphone Android or iOS with Internet connection (Internet provider charges may apply)

BEFORE PROGRAMMING SET THE UNIT OPTIONS AND SAVE.

1

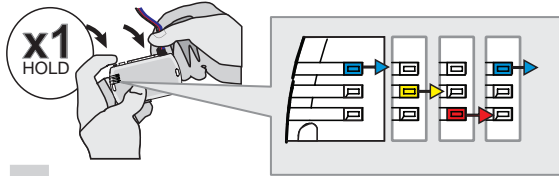

Press and hold the programming button:
Insert the 4-Pin (Data-Link) connector.

↳ The Blue, Red, Yellow and Blue & Red LEDs will alternatively illuminate.

2

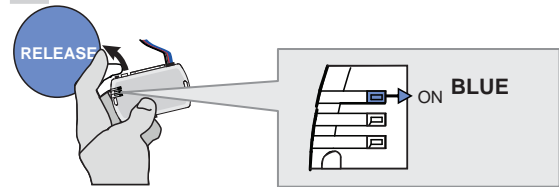

Release the programming button when the LED is BLUE.

If the LED is not solid BLUE disconnect the 4-Pin connector (Data-Link) and go back to step 1.

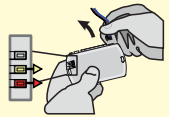

3

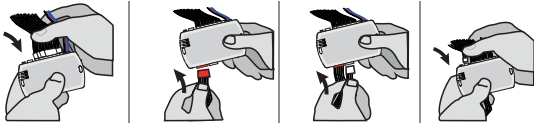

Insert the required remaining connectors.

4

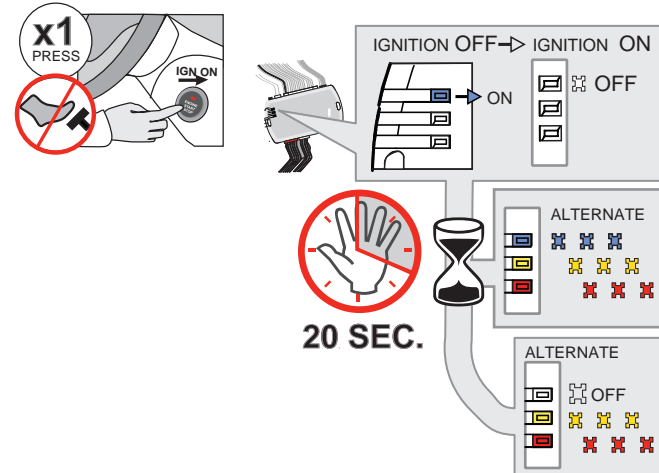

Do not press the brake pedal.
Press the Push-to-Start button once to turn on the ignition.

↳ The BLUE LED will turn OFF.

↳ The BLUE, YELLOW and RED LEDs will alternate.

Wait, at least 20 seconds, do not disconnect the modules or turn off the ignition.

↳ The RED and YELLOW LEDs will alternate.

Make sure that the DELs are flashing RED and YELLOW before continuing programming.

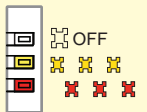

5

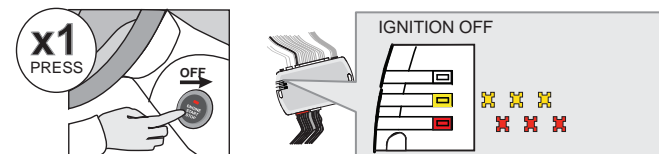

Press the Push-to-Start button once to turn off the ignition.

↳ The RED and YELLOW LEDs alternate.

KEY BYPASS PROGRAMMING PROCEDURE 2/2 |

6

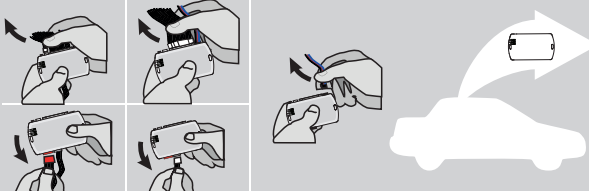

Disconnect all the connectors and after the Data-Link (4-pins) connector.

7



Microsoft Windows Computer with Internet connection*

FLASH LINK UPDATER* **FLASH LINK MANAGER***
SOFTWARE | PROGRAMME

OR

Smartphone* (Internet provider charges may apply)

VEHICLE'S OBDII CONNECTOR **FLASH LINK MOBILE***

Use the tool: FLASH LINK UPDATER or FLASH LINK MOBILE to visit the DCRYPTOR menu.

*Parts required (not included)

8

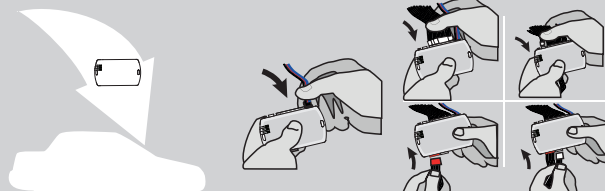

AFTER DCRYPTOR PROGRAMMING COMPLETED
Go back to the vehicle and reconnect the 4-Pin (Data-Link) connector and after, all the remaining connector.

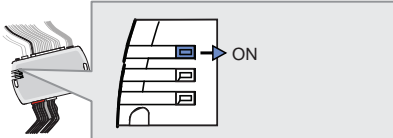

↳ The BLUE LED will turn ON.

9

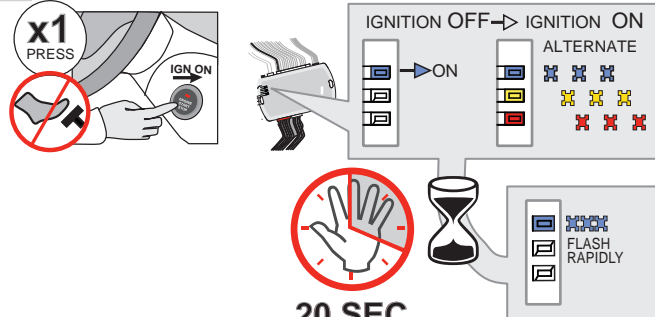

x1 PRESS (with a red 'X' over the push-to-start button)

IGNITION OFF → IGNITION ON

ALTERNATE

↳ The RED and YELLOW LEDs will turn ON.

Wait, at least 20 seconds, do not disconnect the modules or turn off the ignition.

↳ The BLUE LED will flash rapidly.

20 SEC.

FLASH RAPIDLY

10

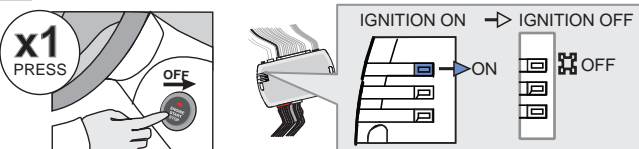

x1 PRESS (with a red 'X' over the push-to-start button)

IGNITION ON → IGNITION OFF

OFF

Press the Push-to-Start button once to turn off the ignition.

↳ The BLUE will turn OFF.



The module is now programmed.



OPTIONAL RF-KIT PROGRAMMING |

PROGRAM BYPASS OPTION







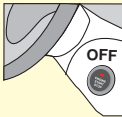



	<p>Program bypass option:</p>	<p>H2</p>	<input checked="" type="checkbox"/> Supported RF-KITS enable
			<input checked="" type="checkbox"/> H2 Fortin 2
			<input checked="" type="checkbox"/>

OPTIONAL FORTIN RF KIT SERIES 4 OR SERIES 9 PROGRAMMING

The module must be programmed on the vehicle.

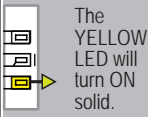
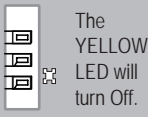
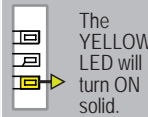
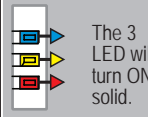
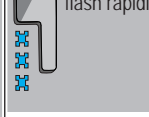
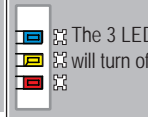
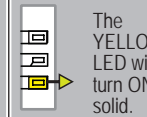
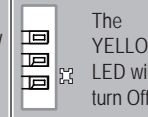
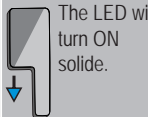
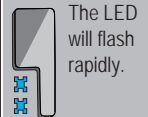
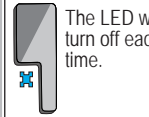
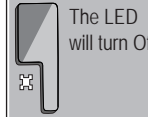

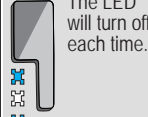

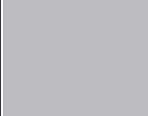

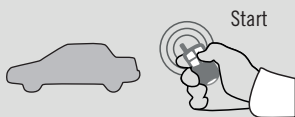

MAKE SURE THE IGNITION KEY HAS BEEN IN THE OFF POSITION FOR AT LEAST 5 SECONDS.

<p>1</p> <p>ON x1 PRESS</p>  <p>Do not press the brake pedal. Press the Push-to-Start button once to turn on the ignition.</p>	<p>2</p> <p>OFF x1 PRESS</p>  <p>Press the Push-to-Start button once to turn off the ignition.</p>	<p>3</p> <p>ON x1 PRESS</p>  <p>Do not press the brake pedal. Press the Push-to-Start button once to turn on the ignition.</p>	<p>4</p> <p>4X BRAKES</p> <p>x4 PRESS</p>  <p>Press and release the brake pedal four times.</p>	<p>5</p> <p>ON EACH TRANSMITTER</p> <p>4 BUTTONS</p> <p>[-] PRESS AND RELEASE</p> <p>→ PRESS AND RELEASE</p> <p>1 BUTTON</p> <p>PRESS APPROX. 12 SEC. AND WAIT FOR THE BLUE LED TO TURN OFF THEN BACK ON SOLID THEN RELEASE.</p>	<p>6</p> <p>OFF x1 PRESS</p>  <p>Press the Push-to-Start button once to turn off the ignition.</p>	<p>7</p> <p>ON x1 PRESS</p>  <p>Do not press the brake pedal. Press the Push-to-Start button once to turn on the ignition and leave it ON for 5 sec..</p>	<p>8</p> <p>OFF x1 PRESS</p>  <p>Press the Push-to-Start button once to turn off the ignition.</p>
 <p>The YELLOW LED will turn ON solid.</p>	 <p>The YELLOW LED will turn Off.</p>	 <p>The YELLOW LED will turn ON solid.</p>	 <p>The 3 LED will turn ON solid.</p>	 <p>The LED will flash rapidly.</p>	 <p>The 3 LED will turn Off.</p>	 <p>The YELLOW LED will turn ON solid.</p>	 <p>The YELLOW LED will turn Off.</p>
		 <p>The LED will turn ON solide.</p>	 <p>The LED will flash rapidly.</p>	 <p>The LED will turn off each time.</p>	 <p>The LED will turn Off.</p>		
			 <p>The LED will turn off each time.</p>	 <p>The LED will turn off each time.</p>			
			 <p>The 3 LED will turn off each time.</p>				

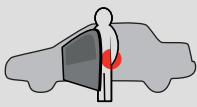

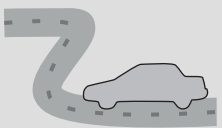
REMOTE STARTER FUNCTIONALITY |

 <p>Start</p> <p>All doors must be closed.</p> <p>Remote start the vehicle.</p>	 <p>UNLOCK</p> <p>Unlock the doors with either:</p> <ul style="list-style-type: none"> • The OEM remote • The remote-starter remote • Or the proximity remote 	 <p>Enter the vehicle with the SMART-KEY.</p>	 <p>DO NOT PRESS THE BRAKE PEDAL.</p> <p>Press and release the Push-to-Start button once.</p>	 <p>Press the brake pedal. The vehicle can now be put in to gear and driven.</p> <p>If the Smart-Key is not detected the vehicle will shut down.</p>
--	---	--	---	---

STANDALONE & THAR-FOR3 INSTALLATION

ADDENDUM - SUGGESTED WIRING CONFIGURATION



ONLY COMPATIBLE WITH AUTOMATIC TRANSMISSION VEHICLES.



Vehicle functions supported in this diagram (functional if equipped)

VEHICLE	YEARS	Immobilizer bypass	T-Harness available (sold separately)	Lock	Unlock	Arm	Disarm	Heated Seats**	Rear Defrost**	RAP Disable	Parking Lights***	Tachometer	Door Status	Trunk Status	Hood Status*	Hand-Brake Status	Foot-Brake Status	Active OEM Remote Start	
LINCOLN																			
Nautilus	Push-to-Start 2020	•	•	•	•	•	•	•	•	•	•	•	•	•	•	•	•	•	•

COMPATIBLE MODULE REQUIRED:

2019

QR CODE ON THE LABEL

MANUFACTURED AFTER: 2019

FIRMWARE VERSION

58.[02]

MINIMUM

To add the firmware version and the options, use the **FLASH LINK UPDATER** or **FLASH LINK MOBILE** tool, sold separately.

UNIT OPTION	DESCRIPTION
C1	OEM Remote status (Lock/Unlock) monitoring
D6	Push-to-Start
A11	<p>IF THE VEHICLE IS NOT EQUIPPED WITH FUNCTIONAL HOOD PIN:</p> <p>OFF Hood trigger (Output Status).</p>

- NOTES**
- The vehicles OEM remote and SmartKey are still operable during remote start.
 - **Heated seats The heated seats and rear defrost activate automatically when it cold.
 - **Rear Defrost
 - ***Parking Lights The parking Lights at remote start only.

MANDATORY INSTALL

*HOOD PIN **HOOD STATUS:** THE HOOD PIN SWITCH MUST BE INSTALLED IF THE VEHICLE CAN BE REMOTE STARTED WITH THE HOOD OPEN, SET FUNCTION A11 TO OFF.

A11 **OFF**

Notice: the installation of safety elements are mandatory. The hood pin is an essential security element and must be installed.

THIS MODULE MUST BE INSTALLED BY A QUALIFIED TECHNICIAN. A WRONG CONNECTION CAN CAUSE PERMANENT DAMAGE TO THE VEHICLE.

PARTS REQUIRED (NOT INCLUDED) |

1x **FLASH LINK UPDATER,**
1x **FLASH LINK MANAGER**
SOFTWARE | PROGRAMME
1x Microsoft Windows Computer with Internet connection

OR

1x **FLASH LINK MOBILE**
1x **FLASH LINK MOBILE APP**
Smartphone Android or iOS with Internet connection (provider charges may apply).

MANDATORY

HOOD PIN



REMOTE START SAFETY OVERRIDE SWITCH

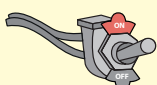







VALET SWITCH

Part #: RSPB available, Sold separately.

Notice: the installation of safety elements are mandatory. The hood pin and the valet switch are essential security elements and must be installed.

STAND ALONE CONFIGURATION |

	Program bypass option	UNIT OPTION	DESCRIPTION
	OEM Remote Stand Alone Remote Starter:	D1.10 	By default, LOCK, LOCK, LOCK
		D1.1 	Par défaut, VERROUILLE, VERROUILLE, VERROUILLE
	Program bypass option with oem remote:	C1	OEM Remote Monitoring
	Program bypass option with RF KIT antenna:	H1 to H6	Supported RF Kits and select RF Kit
	Program bypass option Vehicle hybrid only:	D4	Hybrid mode (Vehicle hybrid only)

REMOTE STARTER FUNCTIONALITY |



All doors must be closed.

3X 

Press the OEM remote's Lock button 3x to remote-start (or remote-stop) the vehicle.



START 

The vehicle will START.

REMOTE STARTER DIAGNOSTICS

MODULE RED LED

x2 flash : Brake ON

x3 flash : No tach

x4 flash : Ignition before start

x5 flash : Hood Open

REMOTE STARTER WARNING CARD |



CUT THIS WARNING CARD AND STICK IT ON A VISIBLE PLACE:
or use the package RSPB, Sold separately.

WARNING



REMOTE STARTER

THE VEHICLE CAN BE STARTED BY EITHER: PRESSING THE LOCK BUTTON ON THE OEM REMOTE 3 TIMES CONSECUTIVELY OR BY A SMARTPHONE. **TURN ON** THE SAFETY SWITCH LOCATED UNDER THE DASHBOARD BEFORE WORKING ON THE VEHICLE.

DESCRIPTION |

	Parts required (Not included)	PAGE
--	-------------------------------	------

WIRE TO WIRE DIAGRAM

AUTOMATIC TRANSMISSION	1x 7.5 Amp. fuse	Page 3
------------------------	------------------	--------

THARNESSE DIAGRAM

THARNESSE THAR-FOR3 AUTOMATIC TRANSMISSION	1x THAR-FOR3	Page 4
--	--------------	--------



② Parking Lights switch

① Gateway module, Behind OBD-II connector

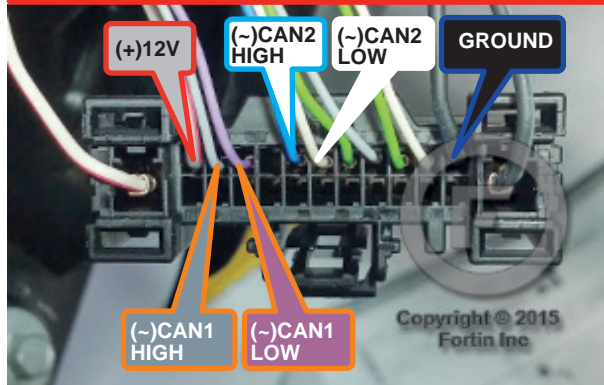
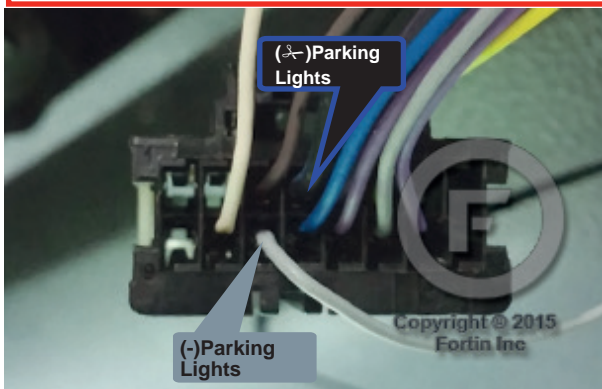

AUTOMATIC TRANSMISSION WIRING CONNECTION |

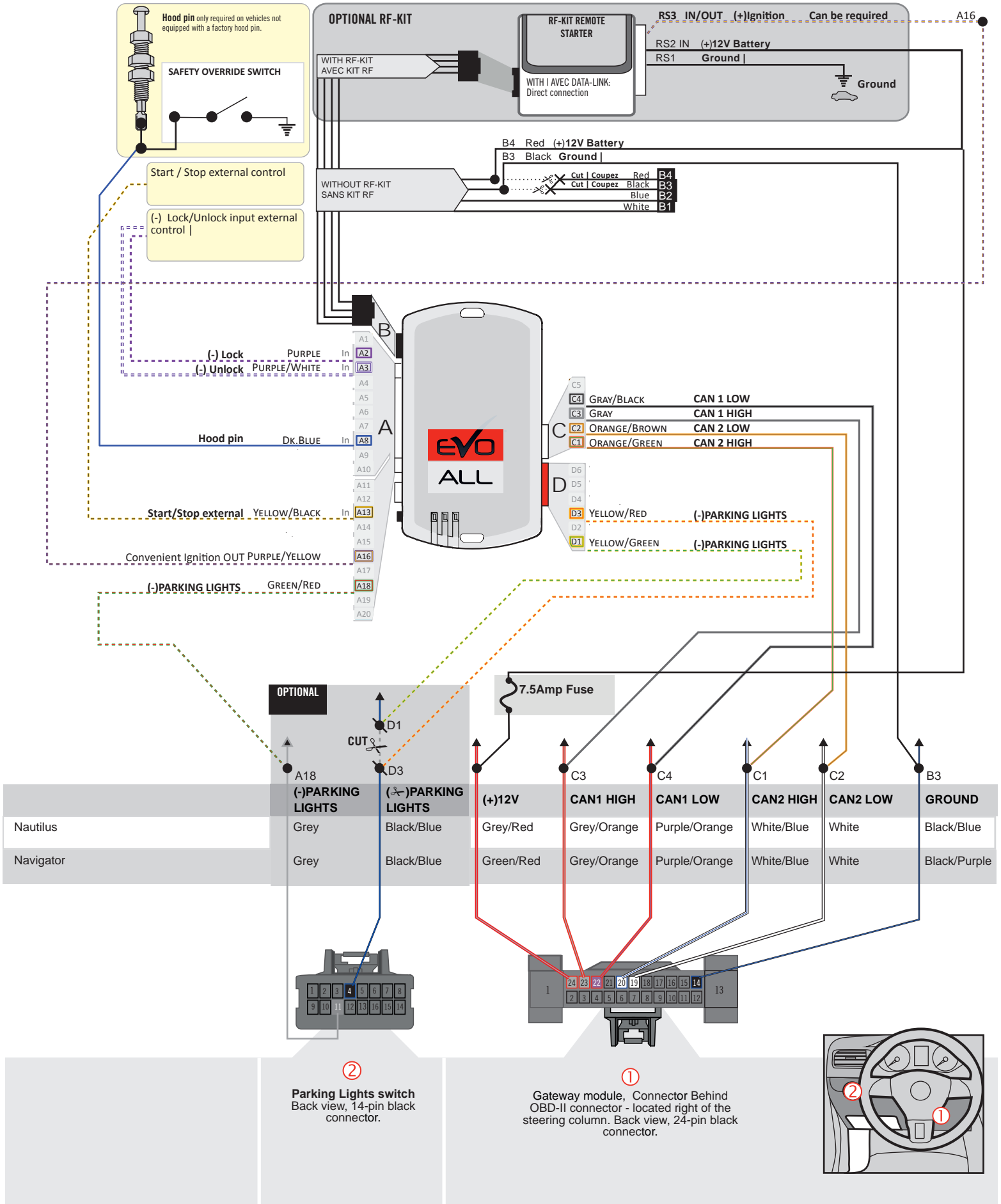

THAR-FOR3 | T-HARNESS - AUTOMATIC TRANSMISSION |

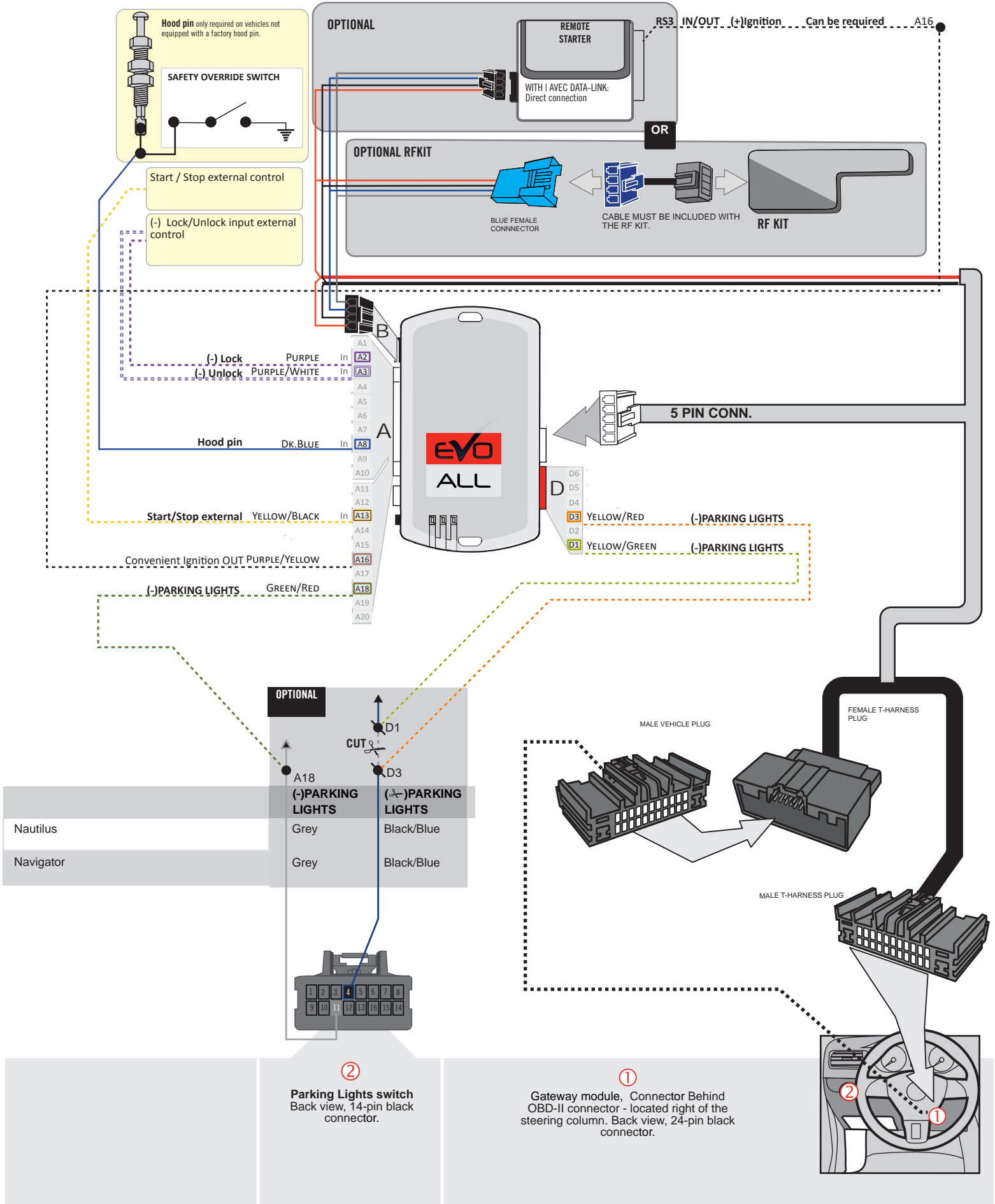



Parts required (not included)

- 1x FLASH LINK UPDATER, SOFTWARE | PROGRAMME
- 1x FLASH LINK MANAGER
- 1x Microsoft Windows Computer with Internet connection

OR

- 1x FLASH LINK MOBILE
- 1x FLASH LINK MOBILE APP
- Smartphone Android or iOS with Internet connection (Internet provider charges may apply)

BEFORE PROGRAMMING SET THE UNIT OPTIONS AND SAVE.

1

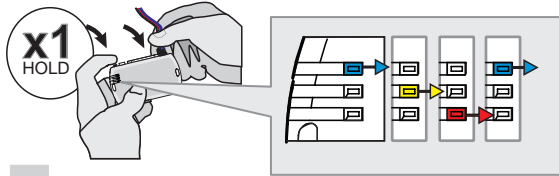

Press and hold the programming button:
Insert the 4-Pin (Data-Link) connector.

↳ The Blue, Red, Yellow and Blue & Red LEDs will alternatively illuminate.

2

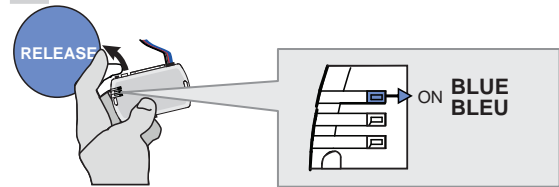

Release the programming button when the LED is BLUE.

If the LED is not solid BLUE disconnect the 4-Pin connector (Data-Link) and go back to step 1.

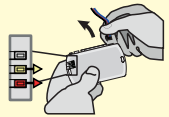

3

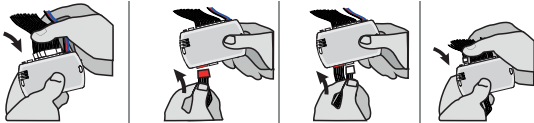

Insert the required remaining connectors.

4

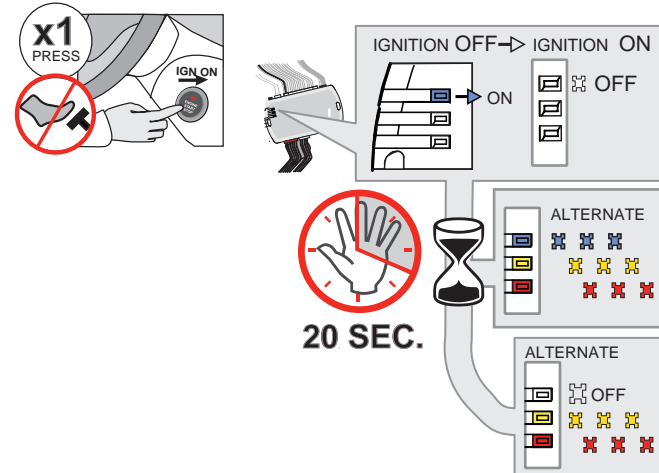

Do not press the brake pedal.
Press the Push-to-Start button once to turn on the ignition.

↳ The BLUE LED will turn OFF.

↳ The BLUE, YELLOW and RED LEDs will alternate.

Wait, at least 20 seconds, do not disconnect the modules or turn off the ignition.

↳ The RED and YELLOW LEDs will alternate.

Make sure that the DELs are flashing RED and YELLOW before continuing programming.

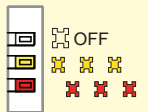

5

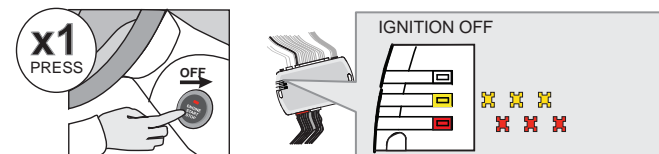

Press the Push-to-Start button once to turn off the ignition.

↳ The RED and YELLOW LEDs alternate.

KEY BYPASS PROGRAMMING PROCEDURE 2/2 |

6

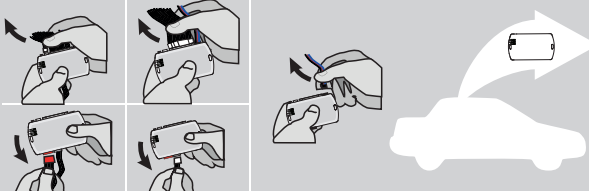

Disconnect all the connectors and after the Data-Link (4-pins) connector.

7



Microsoft Windows Computer with Internet connection*

FLASH LINK UPDATER* **FLASH LINK MANAGER***
SOFTWARE | PROGRAMME

OR

Smartphone* (Internet provider charges may apply)

VEHICLE'S OBDII CONNECTOR **FLASH LINK MOBILE***

Use the tool: FLASH LINK UPDATER or FLASH LINK MOBILE to visit the DCRYPTOR menu.

*Parts required (not included)

8

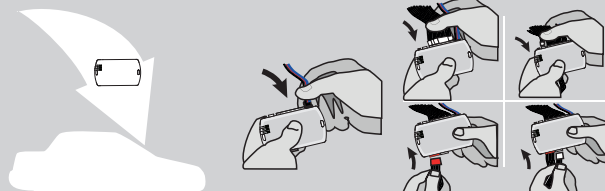

AFTER DCRYPTOR PROGRAMMING COMPLETED
Go back to the vehicle and reconnect the 4-Pin (Data-Link) connector and after, all the remaining connector.



↳ The BLUE LED will turn ON.

9

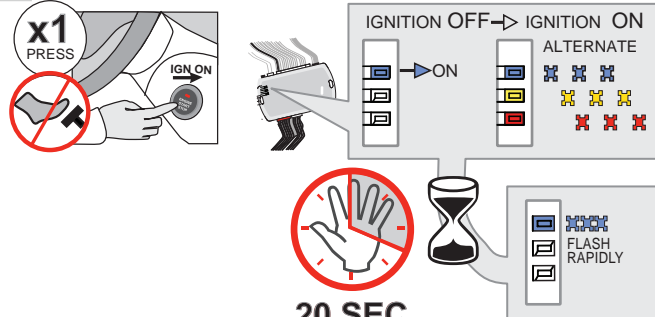

x1 PRESS (with a red 'X' over the push-to-start button)

IGNITION OFF → IGNITION ON

ALTERNATE

↳ The RED and YELLOW LEDs will turn ON.

Wait, at least 20 seconds, do not disconnect the modules or turn off the ignition.

↳ The BLUE LED will flash rapidly.

20 SEC.

FLASH RAPIDLY

10

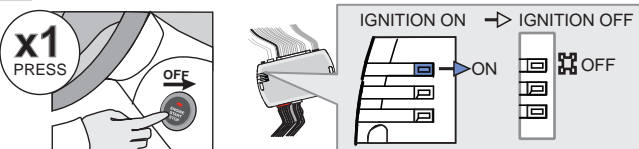

x1 PRESS (with a red 'X' over the push-to-start button)

IGNITION ON → IGNITION OFF

↳ The BLUE will turn OFF.



The module is now programmed.

OPTIONAL RF-KIT PROGRAMMING |

PROGRAM BYPASS OPTION

	<p>Program bypass option:</p>	<p>H2</p>	<p><input checked="" type="checkbox"/> Supported RF-KITS enable <input checked="" type="checkbox"/> H2 Fortin 2</p>
--	-------------------------------	------------------	---

OPTIONAL FORTIN RF KIT SERIES 4 OR SERIES 9 PROGRAMMING





The module must be programmed on the vehicle.

MAKE SURE THE IGNITION KEY HAS BEEN IN THE OFF POSITION FOR AT LEAST 5 SECONDS.

<p>1</p> <p>ON x1 PRESS</p> <p>Do not press the brake pedal. Press the Push-to-Start button once to turn on the ignition.</p>	<p>2</p> <p>OFF x1 PRESS</p> <p>Press the Push-to-Start button once to turn off the ignition.</p>	<p>3</p> <p>ON x1 PRESS</p> <p>Do not press the brake pedal. Press the Push-to-Start button once to turn on the ignition.</p>	<p>4</p> <p>4X BRAKES</p> <p>x4 PRESS</p> <p>Press and release the brake pedal four times.</p>	<p>5</p> <p>ON EACH TRANSMITTER</p> <p>4 BUTTONS</p> <p>[-] PRESS AND RELEASE</p> <p>→ PRESS AND RELEASE</p> <p>1 BUTTON</p> <p>PRESS APPROX. 12 SEC. AND WAIT FOR THE BLUE LED TO TURN OFF THEN BACK ON SOLID THEN RELEASE.</p>	<p>6</p> <p>OFF x1 PRESS</p> <p>Press the Push-to-Start button once to turn off the ignition.</p>	<p>7</p> <p>ON x1 PRESS</p> <p>Do not press the brake pedal. Press the Push-to-Start button once to turn on the ignition and leave it ON for 5 sec..</p>	<p>8</p> <p>OFF x1 PRESS</p> <p>Press the Push-to-Start button once to turn off the ignition.</p>
<p>The YELLOW LED will turn ON solid.</p>	<p>The YELLOW LED will turn Off.</p>	<p>The LED will turn ON solide.</p>	<p>The LED will flash rapidly.</p>	<p>The LED will turn off each time.</p>	<p>The LED will turn Off.</p>	<p>The LED will flash rapidly.</p>	<p>The LED will turn Off.</p>
<p>The YELLOW LED will turn ON solid.</p>	<p>The YELLOW LED will turn Off.</p>	<p>The YELLOW LED will turn ON solid.</p>	<p>The 3 LED will turn ON solid.</p>	<p>The LED will flash rapidly.</p>	<p>The 3 LED will turn off.</p>	<p>The YELLOW LED will turn ON solid.</p>	<p>The YELLOW LED will turn Off.</p>

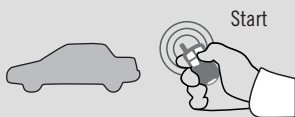

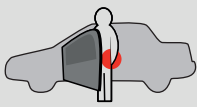
REMOTE STARTER FUNCTIONALITY |

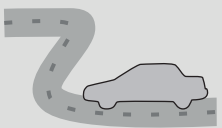
 <p>Start</p> <p>All doors must be closed.</p> <p>Remote start the vehicle.</p>	 <p>UNLOCK</p> <p>Unlock the doors with either:</p> <ul style="list-style-type: none"> • The OEM remote • The remote-starter remote • Or the proximity remote 	 <p>Enter the vehicle with the SMART-KEY.</p>	 <p>DO NOT PRESS THE BRAKE PEDAL.</p> <p>Press and release the Push-to-Start button once.</p>	 <p>Press the brake pedal. The vehicle can now be put in to gear and driven.</p> <p>If the Smart-Key is not detected the vehicle will shut down.</p>
--	---	--	---	---

STANDALONE & THAR-FOR3 INSTALLATION

ADDENDUM - SUGGESTED WIRING CONFIGURATION



ONLY COMPATIBLE WITH AUTOMATIC TRANSMISSION VEHICLES.



Vehicle functions supported in this diagram (functional if equipped)

VEHICLE	YEARS	Immobilizer bypass	Lock	Unlock	Arm	Disarm	Heated Seats**	Rear Defrost**	RAP Disable	Parking Lights***	Tachometer	Door Status	Trunk Status	Hood Status*	Hand-Brake Status	Foot-Brake Status	Active OEM Remote Start
FORD Ranger	key 2020	•	•	•	•	•	•	•	•	•	•	•	•	•	•	•	•

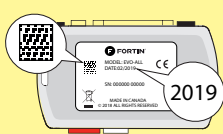

COMPATIBLE MODULE REQUIRED:

QR CODE ON THE LABEL
MANUFACTURED AFTER: 2019

FIRMWARE VERSION
58.[02]
MINIMUM

To add the firmware version and the options, use the **FLASH LINK UPDATER** or **FLASH LINK MOBILE** tool, sold separately.



Program bypass option:

UNIT OPTION

C1

DESCRIPTION

OEM Remote status (Lock/Unlock) monitoring

IF THE VEHICLE IS NOT EQUIPPED WITH FUNCTIONAL HOOD PIN:

A11

OFF

Hood trigger (Output Status).

NOTES

The vehicles OEM remote and SmartKey are still operable during remote start.

**Heated seats The heated seats and rear defrost activate automatically when it cold.

***Parking Lights The parking Lights at remote start only.



The vehicle must be equipped with the OEM remote with the door locks.

MANDATORY INSTALL

*HOOD PIN



HOOD STATUS: THE HOOD PIN SWITCH MUST BE INSTALLED IF THE VEHICLE CAN BE REMOTE STARTED WITH THE HOOD OPEN, SET FUNCTION A11 TO OFF.

A11

OFF

Notice: the installation of safety elements are mandatory. The hood pin is an essential security element and must be installed.

THIS MODULE MUST BE INSTALLED BY A QUALIFIED TECHNICIAN. A WRONG CONNECTION CAN CAUSE PERMANENT DAMAGE TO THE VEHICLE.

PARTS REQUIRED (NOT INCLUDED) |

1x **FLASH LINK UPDATER,**
1x **FLASH LINK MANAGER**
SOFTWARE | PROGRAMME
1x Microsoft Windows Computer with Internet connection

OR

1x **FLASH LINK MOBILE**
1x **FLASH LINK MOBILE APP**
Smartphone *Android* or *iOS* with Internet connection (*provider charges may apply*).

MANDATORY

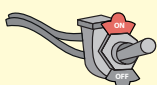





HOOD PIN  REMOTE START SAFETY OVERRIDE SWITCH 

VALET SWITCH

Part #: RSPB available, Sold separately.

Notice: the installation of safety elements are mandatory. The hood pin and the valet switch are essential security elements and must be installed.

STAND ALONE CONFIGURATION | CONFIGURATION EN DÉMARREUR AUTONOME

	Program bypass option	UNIT OPTION	DESCRIPTION
	OEM Remote Stand Alone Remote Starter:	D1.10 	By default, LOCK, LOCK, LOCK
		D1.1 	Par défaut, VERROUILLE, VERROUILLE, VERROUILLE
	Program bypass option with oem remote:	C1	OEM Remote Monitoring
	Program bypass option with RF KIT antenna:	H1 to H6	Supported RF Kits and select RF Kit
	Program bypass option Vehicle hybrid only:	D4	Hybrid mode (Vehicle hybrid only)

REMOTE STARTER FUNCTIONALITY |



All doors must be closed.

3X 

Press the OEM remote's Lock button 3x to remote-start (or remote-stop) the vehicle.



START 

The vehicle will START.

REMOTE STARTER DIAGNOSTICS

MODULE RED LED
x2 flash : Brake ON
x3 flash : No tach
x4 flash : Ignition before start
x5 flash : Hood Open

REMOTE STARTER WARNING CARD |



CUT THIS WARNING CARD AND STICK IT ON A VISIBLE PLACE:
or use the package RSPB, Sold separately.

WARNING | ATTENTION



REMOTE STARTER

THE VEHICLE CAN BE STARTED BY EITHER: PRESSING THE LOCK BUTTON ON THE OEM REMOTE 3 TIMES CONSECUTIVELY OR BY A SMARTPHONE. **TURN ON** THE SAFETY SWITCH LOCATED UNDER THE DASHBOARD BEFORE WORKING ON THE VEHICLE.

DESCRIPTION | DESCRIPTION

	Parts required (Not included)	PAGE
--	-------------------------------	------

WIRE TO WIRE DIAGRAM

AUTOMATIC TRANSMISSION	1x 7.5 Amp. fuse	Page 3
------------------------	------------------	--------

THARNES DIAGRAM

THARNES THAR-FOR3 AUTOMATIC TRANSMISSION	1x THAR-FOR3	Page 4
--	--------------	--------



① Gateway module, Behind OBD-II connector

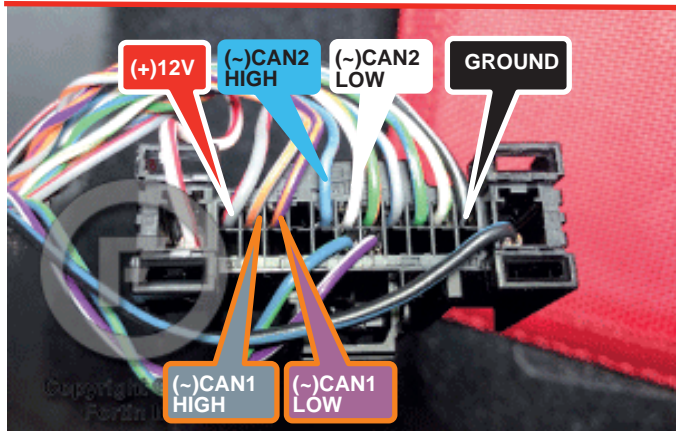

AUTOMATIC TRANSMISSION WIRING CONNECTION |

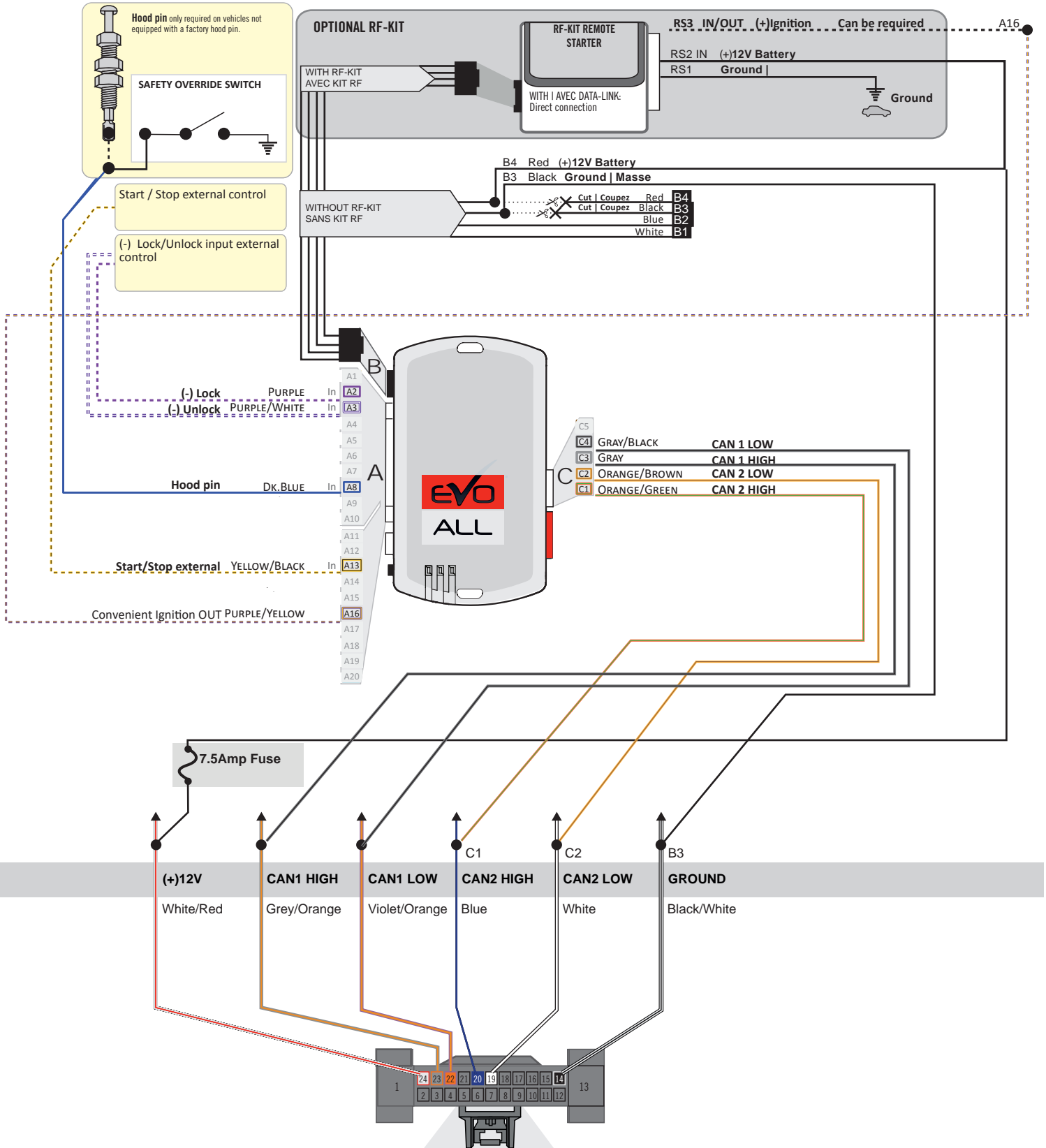

① Gateway module, Connector Behind OBD-II connector - located at dash board driver's side Back view, 24-pin black connector.

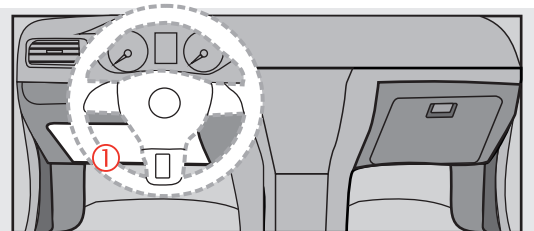

THAR-FOR3 | T-HARNESS - AUTOMATIC TRANSMISSION |

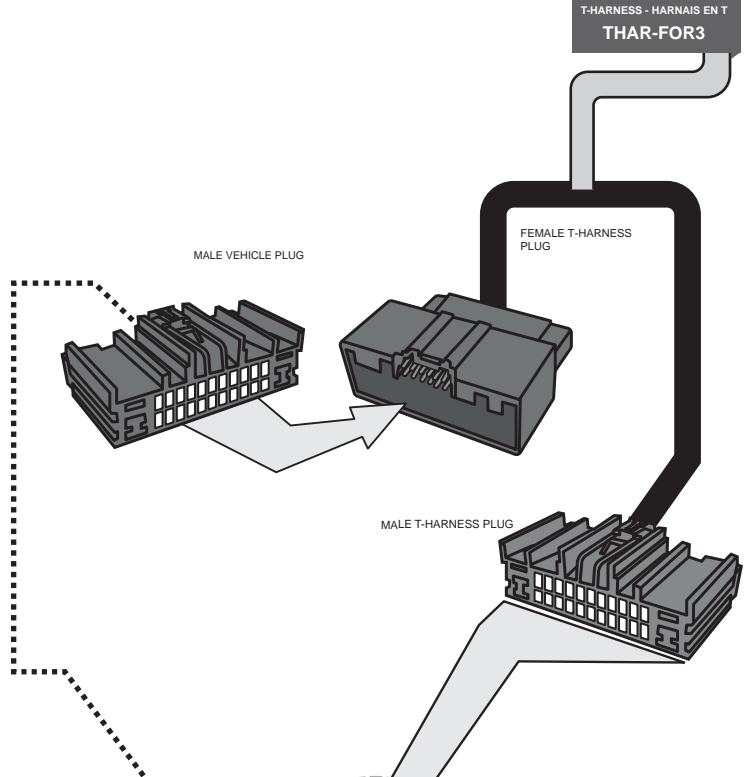
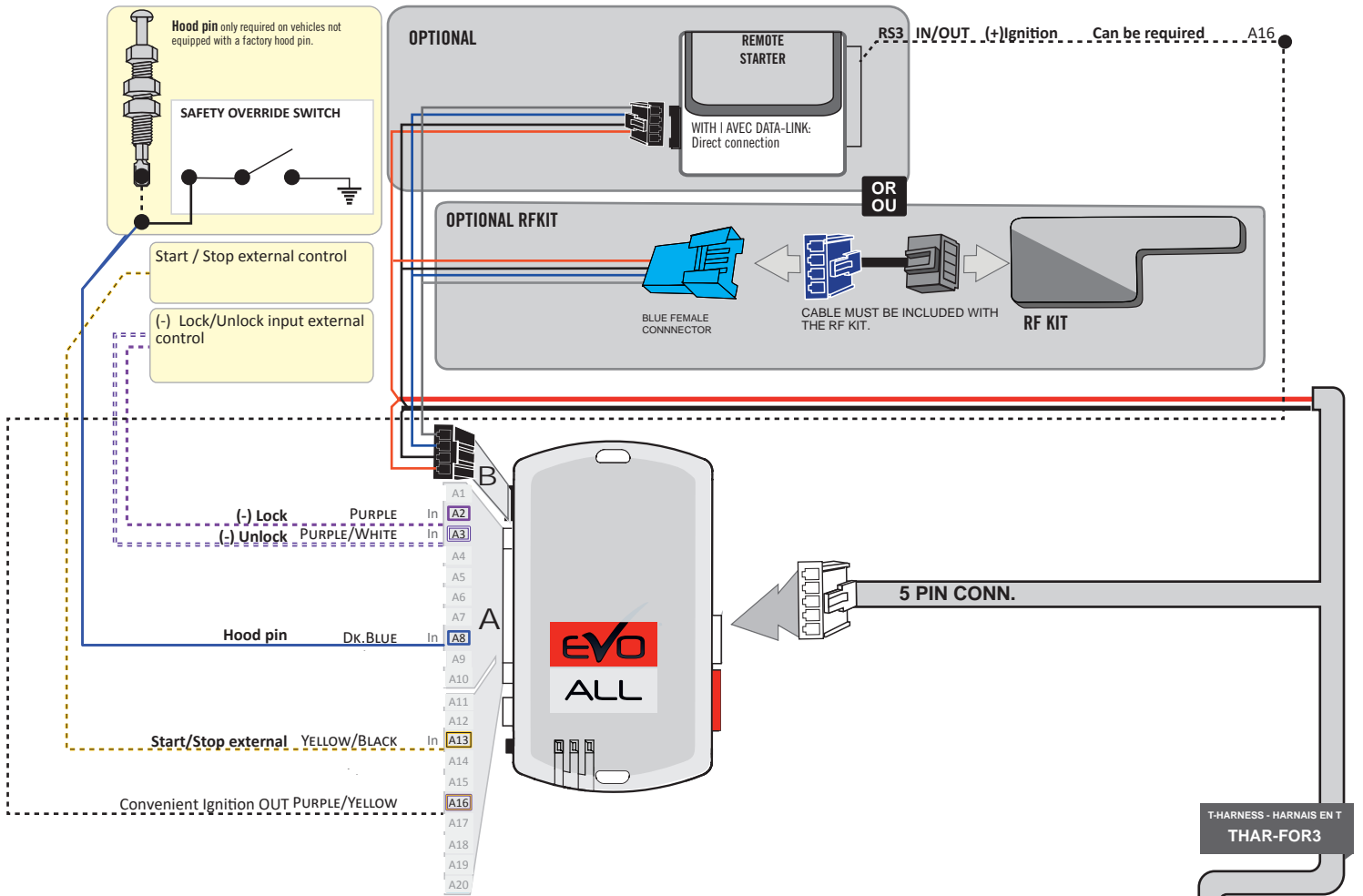

① Gateway module, Connector Behind OBD-II connector - located at dash board driver's side Back view, 24-pin black connector.

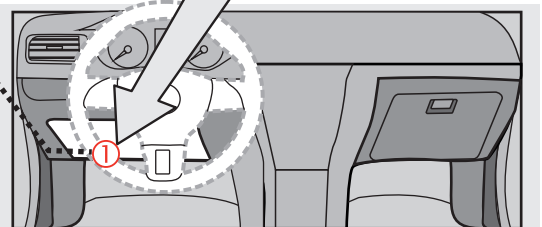



Parts required (not included)

- 1x **FLASH LINK UPDATER,**
- 1x **FLASH LINK MANAGER**
SOFTWARE | PROGRAMME
- 1x Microsoft Windows Computer with Internet connection

OR
OU

- 1x **FLASH LINK MOBILE**
- 1x **FLASH LINK MOBILE APP**
- Smartphone *Android* or *iOS* with Internet connection
(Internet provider charges may apply)

BEFORE PROGRAMMING SET THE UNIT OPTIONS AND SAVE.

1

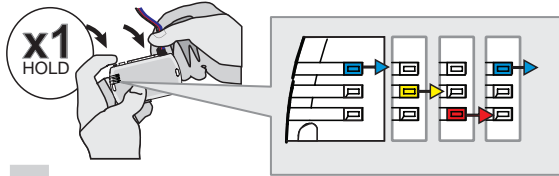

Press and hold the programming button:
Insert the 4-Pin (Data-Link) connector.

↳ The Blue, Red, Yellow and Blue & Red LEDs will alternatively illuminate.

2

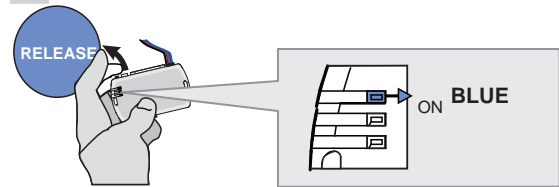

Release the programming button when the LED is BLUE.

If the LED is not solid BLUE disconnect the 4-Pin connector (Data-Link) and go back to step 1.

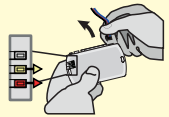

3

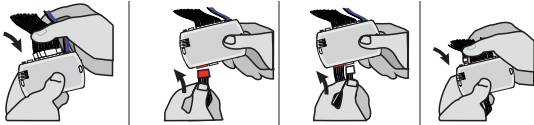

Insert the required remaining connectors.

4

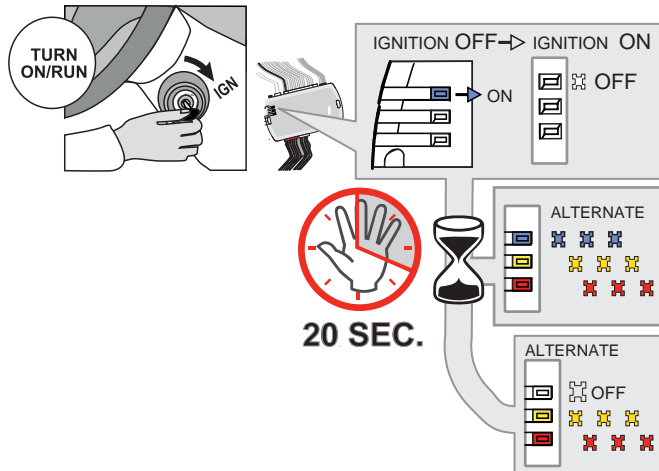

Turn the key to the Ignition ON/RUN position.

↳ The BLUE LED will turn OFF.

↳ The BLUE, YELLOW and RED LEDs will alternate.

Wait, at least 20 seconds, do not disconnect the modules or turn off the ignition.

↳ The RED and YELLOW LEDs will alternate.

Make sure that the DELs are flashing RED and YELLOW before continuing programming.

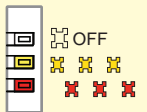

5

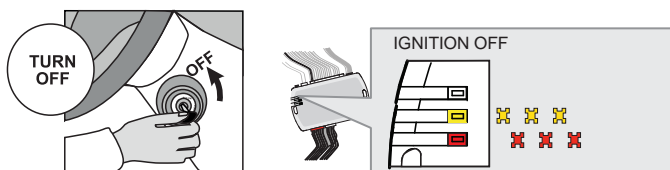

Turn the key to the OFF position.

↳ The RED and YELLOW LEDs alternate.

KEY BYPASS PROGRAMMING PROCEDURE 2/2 |

6

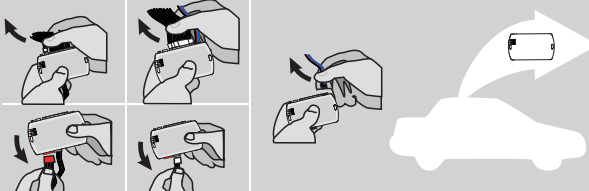

Disconnect all the connectors and after the Data-Link (4-pins) connector.

7



Microsoft Windows Computer with Internet connection*

FLASH LINK UPDATER* **FLASH LINK MANAGER***
SOFTWARE | PROGRAMME

OR

Smartphone* (Internet provider charges may apply)

VEHICLE'S OBDII CONNECTOR **FLASH LINK MOBILE***

Use the tool: FLASH LINK UPDATER or FLASH LINK MOBILE to visit the DCryptor menu.

*Parts required (not included)

8

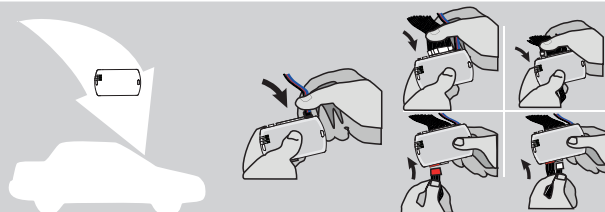

AFTER DCRYPTOR PROGRAMMING COMPLETED
Go back to the vehicle and reconnect the 4-Pin (Data-Link) connector and after, all the remaining connector.



↳ The **BLUE LED** will turn ON.

9

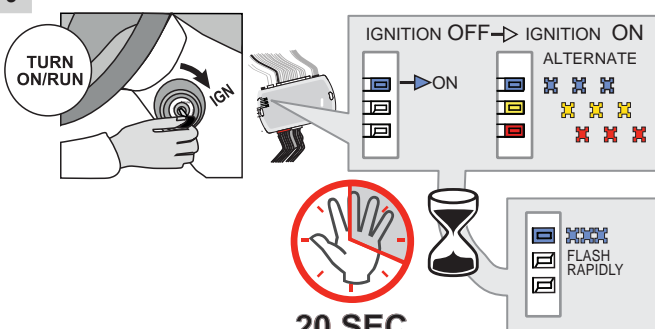

TURN ON/RUN

IGNITION OFF → IGNITION ON

ALTERNATE

↳ The **RED** and **YELLOW LEDs** will turn ON.

Wait, at least 20 seconds, do not disconnect the modules or turn off the ignition.

↳ The **BLUE LED** will flash rapidly.

20 SEC.

FLASH RAPIDLY

10

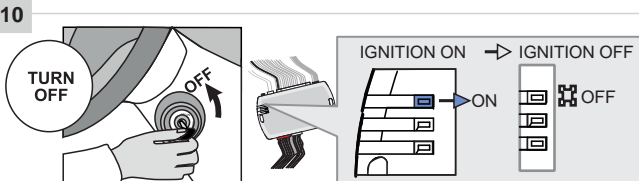

TURN OFF

IGNITION ON → IGNITION OFF

↳ The **BLUE** will turn OFF.





The module is now programmed.









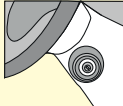

OPTIONAL RF-KIT PROGRAMMING |

PROGRAM BYPASS OPTION

	<p>Program bypass option:</p>	<p>H2</p>	<p><input checked="" type="checkbox"/> Supported RF-KITS enable <input checked="" type="checkbox"/> H2 Fortin 2</p>
---	-------------------------------	------------------	---

OPTIONAL FORTIN RF KIT SERIES 4 OR SERIES 9 PROGRAMMING

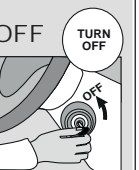
	<p>The module must be programmed on the vehicle.</p>			<p>MAKE SURE THE IGNITION KEY HAS BEEN IN THE OFF POSITION FOR AT LEAST 5 SECONDS.</p>
---	--	---	---	---

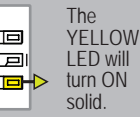
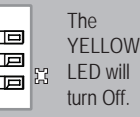
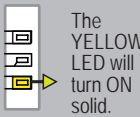
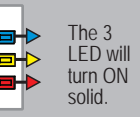
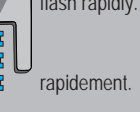
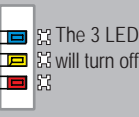
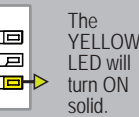
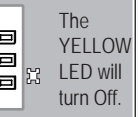
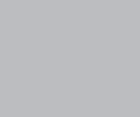
<p>1</p>  <p>ON TURN ON/RUN</p>	<p>2</p>  <p>OFF TURN OFF</p>	<p>3</p>  <p>ON TURN ON/RUN</p>	<p>4</p> <p>4X BRAKES</p>  <p>x4 PRESS</p>	<p>5</p> <p>ON EACH TRANSMITTER</p> <p>4 BUTTONS</p>  <p>PRESS AND RELEASE</p>  <p>PRESS AND RELEASE</p> <p>1 BUTTON</p>  <p>PRESS APPROX. 12 SEC. AND WAIT FOR THE BLUE LED TO TURN OFF THEN BACK ON SOLID THEN RELEASE.</p>	<p>6</p>  <p>OFF TURN OFF</p>	<p>7</p>  <p>ON TURN ON/RUN</p>	<p>8</p>  <p>OFF TURN OFF</p>
<p>Turn the key to the ON/RUN position.</p>	<p>Turn the ignition to the OFF position.</p>	<p>Turn the key to the ON/RUN position.</p>	<p>Press and release the brake pedal four times.</p>	<p>The LED will turn off each time.</p>	<p>Turn the ignition to the OFF position.</p>	<p>Turn the key to the ON/RUN position and leave it ON for 5 sec.</p> 	<p>Turn the ignition to the OFF position.</p>
 <p>The YELLOW LED will turn ON solid.</p>	 <p>The YELLOW LED will turn Off.</p>	 <p>The YELLOW LED will turn ON solid.</p>	 <p>The 3 LED will turn ON solid.</p>	 <p>The LED will flash rapidly.</p>	 <p>The 3 LED will turn off.</p>	 <p>The YELLOW LED will turn ON solid.</p>	 <p>The YELLOW LED will turn Off.</p>
 <p>The 3 LED will turn off each time.</p>							



REMOTE STARTER FUNCTIONALITY |



All doors must be closed.



Remote start the vehicle.



Unlock the doors with the remote-starter remote or the OEM remote.



Insert and Turn the key to the Ignition ON/RUN position.



Press the brake pedal.



The vehicle can now be put in to gear and driven.

STANDALONE & THAR-FOR3 INSTALLATION

ADDENDUM - SUGGESTED WIRING CONFIGURATION



ONLY COMPATIBLE WITH AUTOMATIC TRANSMISSION VEHICLES.



Vehicle functions supported in this diagram (functional if equipped)

VEHICLE	YEARS	Immobilizer bypass	Lock	Unlock	Arm	Disarm	Heated Seats**	Rear Defrost**	RAP Disable	Parking Lights***	Tachometer	Door Status	Trunk Status	Hood Status*	Hand-Brake Status	Foot-Brake Status	Active OEM Remote Start
FORD Ranger	Push-to-Start 2020	•	•	•	•	•	•	•	•	•	•	•	•	•	•	•	•

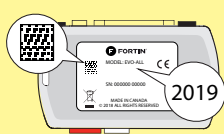

COMPATIBLE MODULE REQUIRED:

QR CODE ON THE LABEL
MANUFACTURED AFTER: 2019

FIRMWARE VERSION

58.[02]
MINIMUM

To add the firmware version and the options, use the **FLASH LINK UPDATER** or **FLASH LINK MOBILE** tool, sold separately.



Program bypass option:

UNIT OPTION

DESCRIPTION

C1

OEM Remote status (Lock/Unlock) monitoring

D6

Push-to-Start

IF THE VEHICLE IS NOT EQUIPPED WITH FUNCTIONAL HOOD PIN:

A11

OFF

Hood trigger (Output Status).

NOTES

The vehicles OEM remote and SmartKey are still operable during remote start.

**Heated seats The heated seats and rear defrost activate automatically when it cold.
**Rear Defrost

***Parking Lights The parking Lights at remote start only.

MANDATORY INSTALL

*HOOD PIN



HOOD STATUS: THE HOOD PIN SWITCH MUST BE INSTALLED IF THE VEHICLE CAN BE REMOTE STARTED WITH THE HOOD OPEN, SET FUNCTION A11 TO OFF.

A11

OFF

Notice: the installation of safety elements are mandatory. The hood pin is an essential security element and must be installed.

THIS MODULE MUST BE INSTALLED BY A QUALIFIED TECHNICIAN. A WRONG CONNECTION CAN CAUSE PERMANENT DAMAGE TO THE VEHICLE.

PARTS REQUIRED (NOT INCLUDED) |

1x **FLASH LINK UPDATER,**
1x **FLASH LINK MANAGER**
SOFTWARE | PROGRAMME
1x Microsoft Windows Computer with Internet connection

OR

1x **FLASH LINK MOBILE**
1x **FLASH LINK MOBILE APP**
Smartphone Android or iOS with Internet connection (provider charges may apply).

MANDATORY

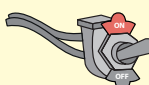





HOOD PIN  REMOTE START SAFETY OVERRIDE SWITCH 

VALET SWITCH

Part #: RSPB available, Sold separately.

Notice: the installation of safety elements are mandatory. The hood pin and the valet switch are essential security elements and must be installed.



STAND ALONE CONFIGURATION

	Program bypass option	UNIT OPTION	DESCRIPTION
	OEM Remote Stand Alone Remote Starter:	D1.10  D1.1 	By default, LOCK, LOCK, LOCK Par défaut, VERROUILLE,VERROUILLE,VERROUILLE
	Program bypass option with oem remote:	C1	OEM Remote Monitoring
	Program bypass option with RF KIT antenna:	H1 to H6	Supported RF Kits and select RF Kit
	Program bypass option Vehicle hybrid only:	D4	Hybrid mode (Vehicle hybrid only)

REMOTE STARTER FUNCTIONALITY |



All doors must be closed.

3X  

Press the OEM remote's Lock button 3x to remote-start (or remote-stop) the vehicle.



The vehicle will START.

REMOTE STARTER DIAGNOSTICS

MODULE RED LED

x2 flash : Brake ON

x3 flash : No tach

x4 flash : Ignition before start

x5 flash : Hood Open

REMOTE STARTER WARNING CARD |



CUT THIS WARNING CARD AND STICK IT ON A VISIBLE PLACE:
or use the package RSPB, Sold separately.

WARNING



REMOTE STARTER

THE VEHICLE CAN BE STARTED BY EITHER: PRESSING THE LOCK BUTTON ON THE OEM REMOTE 3 TIMES CONSECUTIVELY OR BY A SMARTPHONE. **TURN ON** THE SAFETY SWITCH LOCATED UNDER THE DASHBOARD BEFORE WORKING ON THE VEHICLE.

DESCRIPTION

	Parts required (Not included)	PAGE
--	-------------------------------	------

WIRE TO WIRE DIAGRAM

AUTOMATIC TRANSMISSION	1x 7.5 Amp. fuse	Page 3
------------------------	------------------	--------

THARNES DIAGRAM

THARNES THAR-FOR3 AUTOMATIC TRANSMISSION	1x THAR-FOR3	Page 4
--	--------------	--------



RANGER

① Gateway module, Behind OBD-II connector

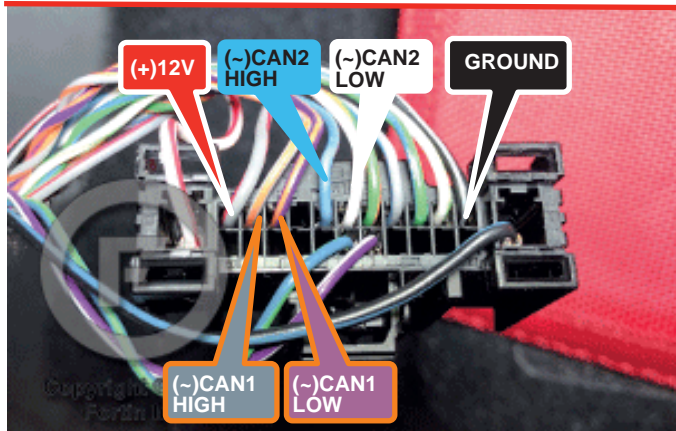

AUTOMATIC TRANSMISSION WIRING CONNECTION |

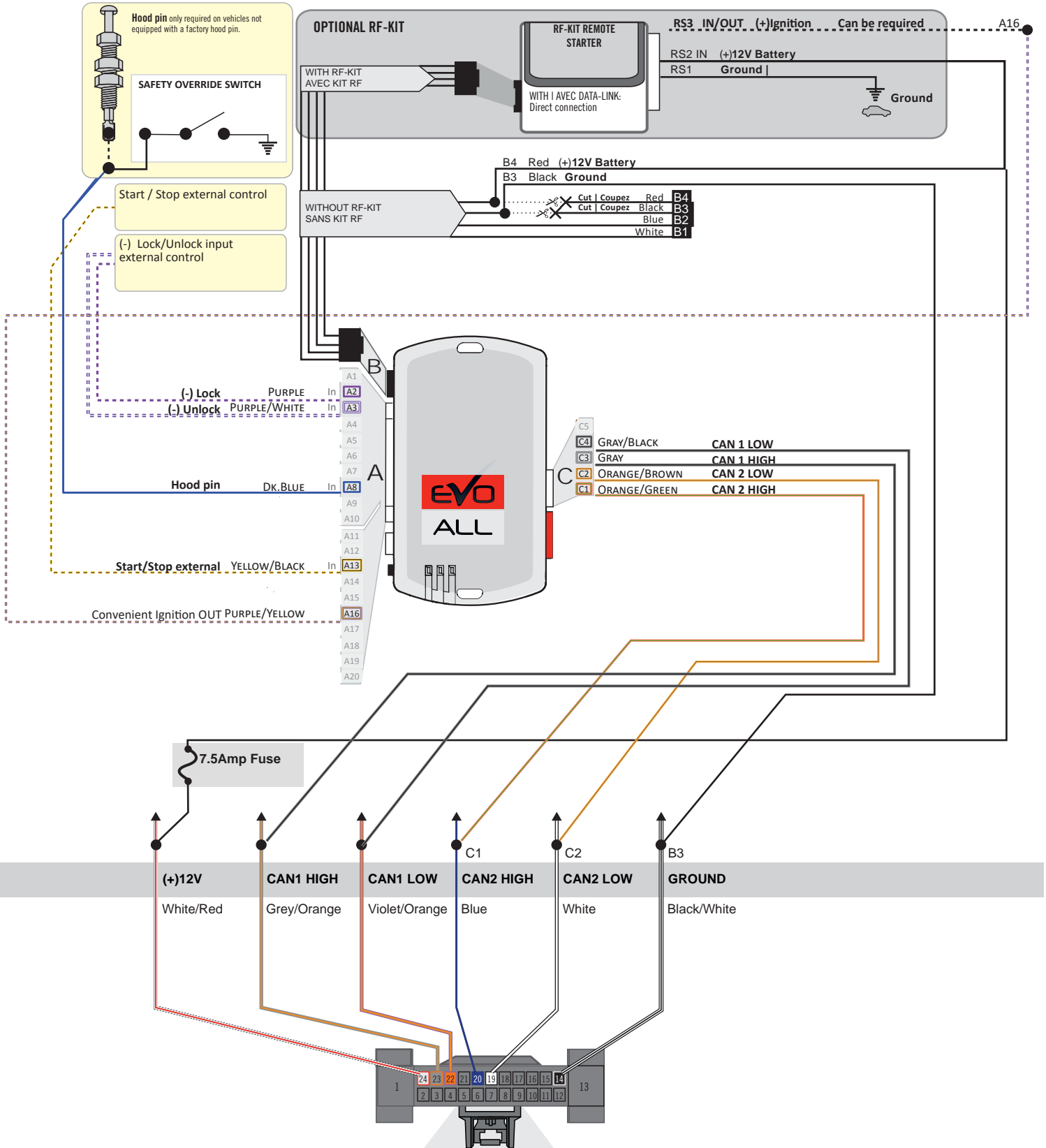

RANGER

① Gateway module, Connector Behind OBD-II connector - located at dash board driver's side Back view, 24-pin black connector.

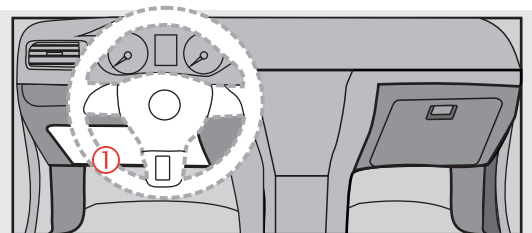

THAR-FOR3 | T-HARNESS - AUTOMATIC TRANSMISSION |

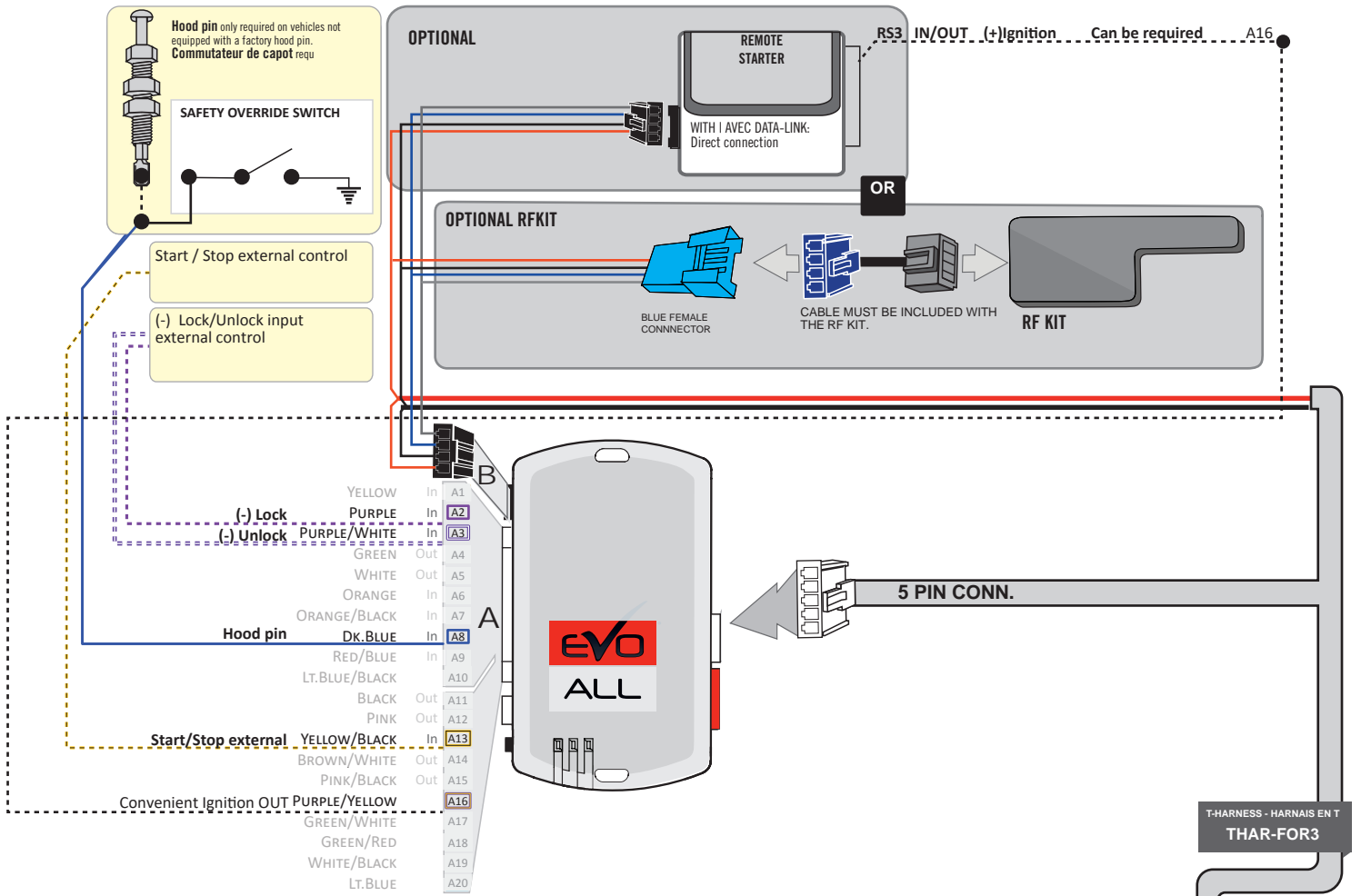

RANGER

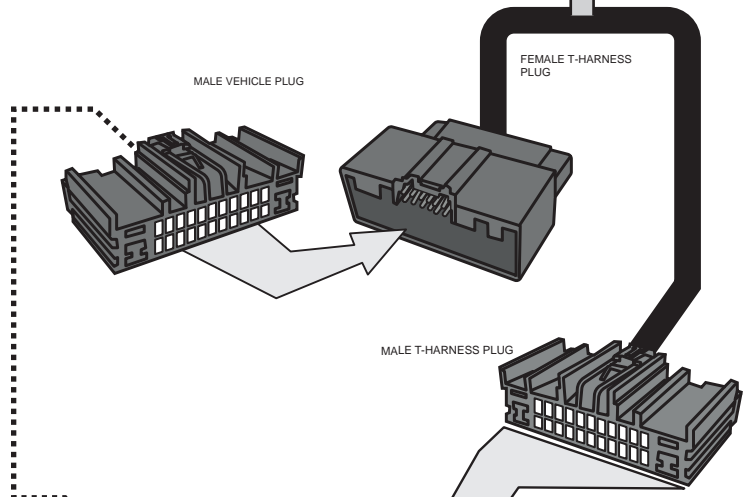

① Gateway module, Connector Behind OBD-II connector - located at dash board driver's side Back view, 24-pin black connector.

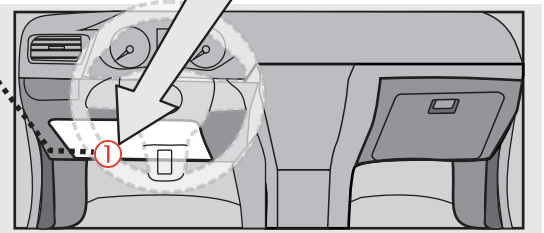

DCRYPTOR PROGRAMMING PROCEDURE



Parts required (not included)

- 1x **FLASH LINK UPDATER,**
- 1x **FLASH LINK MANAGER**
SOFTWARE | PROGRAMME
- 1x Microsoft Windows Computer with Internet connection

OR

- 1x **FLASH LINK MOBILE**
- 1x **FLASH LINK MOBILE APP**
- Smartphone *Android* or *iOS* with Internet connection
(Internet provider charges may apply)

BEFORE PROGRAMMING SET THE UNIT OPTIONS AND SAVE.

1

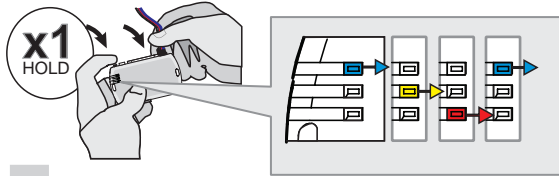

Press and hold the programming button:
Insert the 4-Pin (Data-Link) connector.

↳ The Blue, Red, Yellow and Blue & Red LEDs will alternatively illuminate.

2

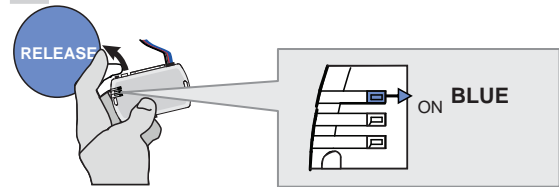

Release the programming button when the LED is BLUE.

If the LED is not solid BLUE disconnect the 4-Pin connector (Data-Link) and go back to step 1.

3

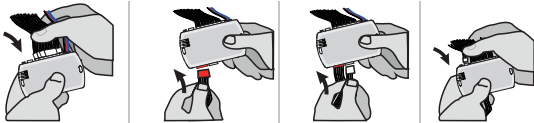

Insert the required remaining connectors.

4

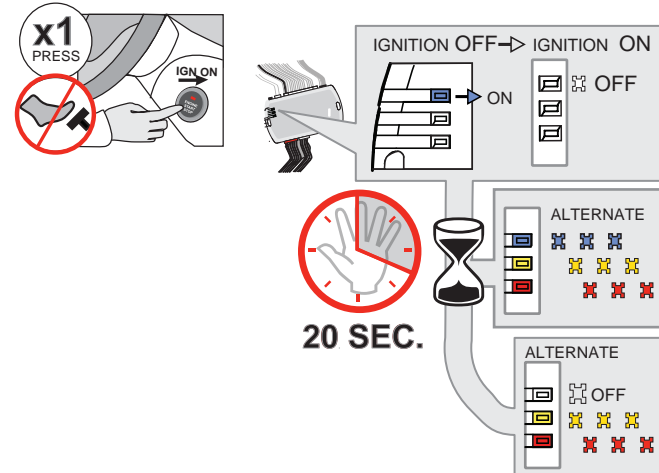

Do not press the brake pedal.
Press the Push-to-Start button once to turn on the ignition.

↳ The BLUE LED will turn OFF.

↳ The BLUE, YELLOW and RED LEDs will alternate.

Wait, at least 20 seconds, do not disconnect the modules or turn off the ignition.

↳ The RED and YELLOW LEDs will alternate.

Make sure that the DELs are flashing RED and YELLOW before continuing programming.

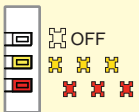

5

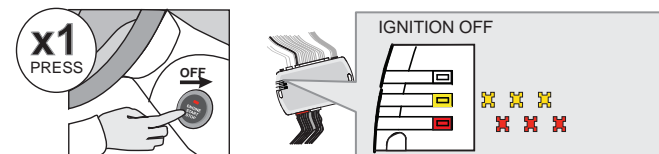

Press the Push-to-Start button once to turn off the ignition.

↳ The RED and YELLOW LEDs alternate.

KEY BYPASS PROGRAMMING PROCEDURE 2/2

6

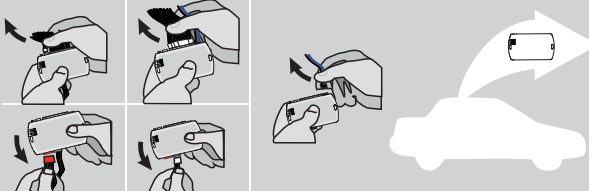

Disconnect all the connectors and after the Data-Link (4-pins) connector.

7



Microsoft Windows Computer with Internet connection*

FLASH LINK UPDATER* **FLASH LINK MANAGER***
SOFTWARE | PROGRAMME

OR

Smartphone* (Internet provider charges may apply)

VEHICLE'S OBDII CONNECTOR **FLASH LINK MOBILE***

Use the tool: FLASH LINK UPDATER or FLASH LINK MOBILE to visit the DCryptor menu.

*Parts required (not included)

8

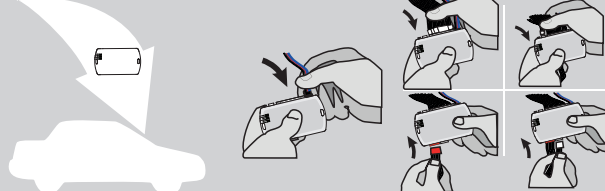

AFTER DCRYPTOR PROGRAMMING COMPLETED
Go back to the vehicle and reconnect the 4-Pin (Data-Link) connector and after, all the remaining connector.

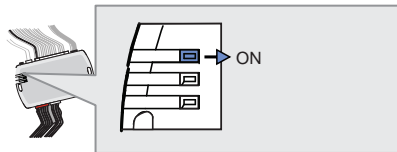

↳ The BLUE LED will turn ON.

9

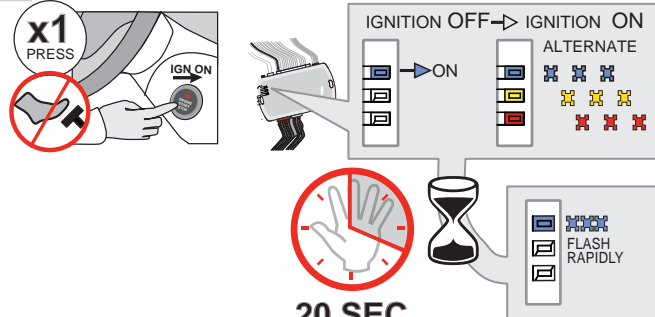

x1 PRESS (with a red 'X' over the push-to-start button)

IGNITION OFF → IGNITION ON

ALTERNATE

↳ The RED and YELLOW LEDs will turn ON.

Wait, at least 20 seconds, do not disconnect the modules or turn off the ignition.

↳ The BLUE LED will flash rapidly.

20 SEC.

FLASH RAPIDLY

10

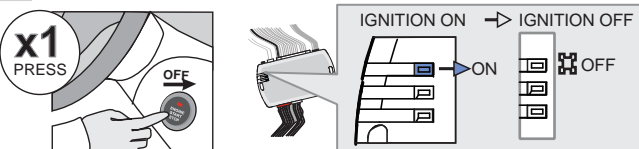

x1 PRESS (with a red 'X' over the push-to-start button)

IGNITION ON → IGNITION OFF

↳ The BLUE will turn OFF.



The module is now programmed.



OPTIONAL RF-KIT PROGRAMMING

PROGRAM BYPASS OPTION







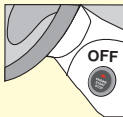



	<p>Program bypass option:</p>	<p>H2</p>	<p><input checked="" type="checkbox"/> Supported RF-KITS enable <input checked="" type="checkbox"/> H2 Fortin 2</p>
---	-------------------------------	------------------	---

OPTIONAL FORTIN RF KIT SERIES 4 OR SERIES 9 PROGRAMMING

The module must be programmed on the vehicle.

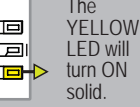
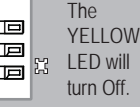
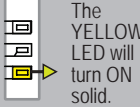
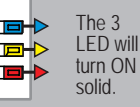

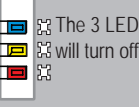
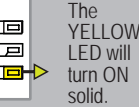
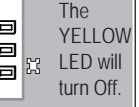
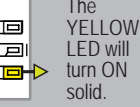
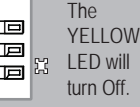
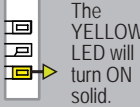
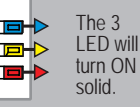

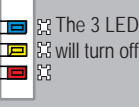
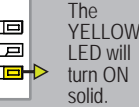
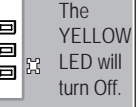

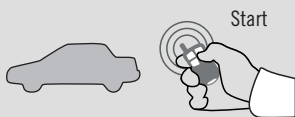

MAKE SURE THE IGNITION KEY HAS BEEN IN THE OFF POSITION FOR AT LEAST 5 SECONDS.

<p>1</p> <p>ON x1 PRESS</p>  <p>Do not press the brake pedal. Press the Push-to-Start button once to turn on the ignition.</p>	<p>2</p> <p>OFF x1 PRESS</p>  <p>Press the Push-to-Start button once to turn off the ignition.</p>	<p>3</p> <p>ON x1 PRESS</p>  <p>Do not press the brake pedal. Press the Push-to-Start button once to turn on the ignition.</p>	<p>4</p> <p>4X BRAKES</p> <p>x4 PRESS</p>  <p>Press and release the brake pedal four times. Appuyez et relâchez quatre fois la pédale de frein.</p>	<p>5</p> <p>ON EACH TRANSMITTER</p> <p>4 BUTTONS</p> <p>[-] PRESS AND RELEASE</p> <p>→ PRESS AND RELEASE</p> <p>[] 1 BUTTON</p> <p>PRESS APPROX. 12 SEC. AND WAIT FOR THE BLUE LED TO TURN OFF THEN BACK ON SOLID THEN RELEASE.</p>	<p>6</p> <p>OFF x1 PRESS</p>  <p>Press the Push-to-Start button once to turn off the ignition.</p>	<p>7</p> <p>ON x1 PRESS</p>  <p>Do not press the brake pedal. Press the Push-to-Start button once to turn on the ignition and leave it ON for 5 sec..</p>	<p>8</p> <p>OFF x1 PRESS</p>  <p>Press the Push-to-Start button once to turn off the ignition.</p>
 <p>The YELLOW LED will turn ON solid.</p>	 <p>The YELLOW LED will turn Off.</p>	 <p>The YELLOW LED will turn ON solid.</p>	 <p>The LED will flash rapidly.</p>	 <p>The LED will turn off each time.</p>	 <p>The LED will turn Off.</p>	 <p>The YELLOW LED will turn ON solid.</p>	 <p>The YELLOW LED will turn Off.</p>
 <p>The YELLOW LED will turn ON solid.</p>	 <p>The YELLOW LED will turn Off.</p>	 <p>The YELLOW LED will turn ON solid.</p>	 <p>The 3 LED will turn ON solid.</p>	 <p>The LED will flash rapidly.</p>	 <p>The 3 LED will turn off.</p>	 <p>The YELLOW LED will turn ON solid.</p>	 <p>The YELLOW LED will turn Off.</p>

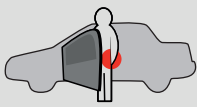

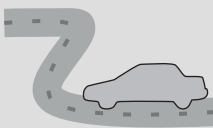
REMOTE STARTER FUNCTIONALITY

 <p>Start</p> <p>All doors must be closed.</p> <p>Remote start the vehicle.</p>	 <p>UNLOCK</p> <p>Unlock the doors with either:</p> <ul style="list-style-type: none"> • The OEM remote • The remote-starter remote • Or the proximity remote 	 <p>Enter the vehicle with the SMART-KEY.</p>	 <p>DO NOT PRESS THE BRAKE PEDAL.</p> <p>Press and release the Push-to-Start button once.</p>	 <p>Press the brake pedal. The vehicle can now be put in to gear and driven.</p> <p>If the Smart-Key is not detected the vehicle will shut down.</p>
--	---	--	---	---

STANDALONE & THAR-FOR3 INSTALLATION

ADDENDUM - SUGGESTED WIRING CONFIGURATION



ONLY COMPATIBLE WITH AUTOMATIC TRANSMISSION VEHICLES.



Vehicle functions supported in this diagram (functional if equipped)

VEHICLE	YEARS	Immobilizer bypass	Lock	Unlock	Arrn	Disarm	RAP Disable	Parking Lights***	Tachometer	Heated seats**	Heated Mirrors**	Rear defrost	Door Status	Trunk Status	Hood Status*	Hand-Brake Status	Foot-Brake Status	Active OEM Remote Start	
FORD	Transit	Key 2020	•	•	•	•	•	•	•	•	•	•	•	•	•	•	•	•	•
		Diesel Key 2020	•	•	•	•	•	•	•	•	•	•	•	•	•	•	•	•	•

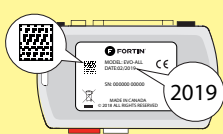

COMPATIBLE MODULE REQUIRED:

QR CODE ON THE LABEL
MANUFACTURED AFTER: 2019

FIRMWARE VERSION

58.[02]
MINIMUM

To add the firmware version and the options, use the **FLASH LINK UPDATER** or **FLASH LINK MOBILE** tool, sold separately.



Program bypass option:

UNIT OPTION

C1

DESCRIPTION

OEM Remote status (Lock/Unlock) monitoring

IF THE VEHICLE IS NOT EQUIPPED WITH FUNCTIONAL HOOD PIN:

A11

OFF

Hood trigger (Output Status).

NOTES

The vehicles OEM remote and SmartKey are still operable during remote start.

**Heated seats The heated seats and rear defrost activate automatically when it cold.

***Parking Lights The parking Lights at remote start only.



The vehicle must be equipped with the OEM remote with the door locks.

MANDATORY INSTALL

*HOOD PIN



HOOD STATUS: THE HOOD PIN SWITCH MUST BE INSTALLED IF THE VEHICLE CAN BE REMOTE STARTED WITH THE HOOD OPEN, SET FUNCTION A11 TO OFF.

A11

OFF

Notice: the installation of safety elements are mandatory. The hood pin is an essential security element and must be installed.

THIS MODULE MUST BE INSTALLED BY A QUALIFIED TECHNICIAN. A WRONG CONNECTION CAN CAUSE PERMANENT DAMAGE TO THE VEHICLE.

PARTS REQUIRED (NOT INCLUDED) |

1x **FLASH LINK UPDATER,**
1x **FLASH LINK MANAGER**
SOFTWARE | PROGRAMME
1x Microsoft Windows Computer with Internet connection

OR

1x **FLASH LINK MOBILE**
1x **FLASH LINK MOBILE APP**
Smartphone *Android* or *iOS* with Internet connection (*provider charges may apply*).

MANDATORY

HOOD PIN



REMOTE START SAFETY OVERRIDE SWITCH

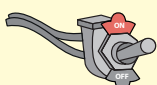







VALET SWITCH

Part #: RSPB available, Sold separately.

Notice: the installation of safety elements are mandatory. The hood pin and the valet switch are essential security elements and must be installed.

STAND ALONE CONFIGURATION |

	Program bypass option	UNIT OPTION	DESCRIPTION
	OEM Remote Stand Alone Remote Starter:	D1.10 	By default, LOCK, LOCK, LOCK
		D1.1 	Par défaut, VERROUILLE, VERROUILLE, VERROUILLE
	Program bypass option with oem remote:	C1	OEM Remote Monitoring
	Program bypass option with RF KIT antenna:	H1 to H6	Supported RF Kits and select RF Kit
	Program bypass option Vehicle hybrid only:	D4	Hybrid mode (Vehicle hybrid only)

REMOTE STARTER FUNCTIONALITY |



All doors must be closed.

3X 

Press the OEM remote's Lock button 3x to remote-start (or remote-stop) the vehicle.



START 

The vehicle will START.

REMOTE STARTER DIAGNOSTICS

MODULE RED LED

x2 flash : Brake ON

x3 flash : No tach

x4 flash : Ignition before start

x5 flash : Hood Open

REMOTE STARTER WARNING CARD |



CUT THIS WARNING CARD AND STICK IT ON A VISIBLE PLACE:
or use the package RSPB, Sold separately.

WARNING



REMOTE STARTER

THE VEHICLE CAN BE STARTED BY EITHER: PRESSING THE LOCK BUTTON ON THE OEM REMOTE 3 TIMES CONSECUTIVELY OR BY A SMARTPHONE. **TURN ON** THE SAFETY SWITCH LOCATED UNDER THE DASHBOARD BEFORE WORKING ON THE VEHICLE.

DESCRIPTION |

	Parts required (Not included)	PAGE
--	-------------------------------	------

WIRE TO WIRE DIAGRAM

AUTOMATIC TRANSMISSION	1x 7.5 Amp. fuse	Page 3
------------------------	------------------	--------

THARNES DIAGRAM

THARNES THAR-FOR3 AUTOMATIC TRANSMISSION	1x THAR-FOR3	Page 4
--	--------------	--------

① Gateway module, located at dash board driver's side,

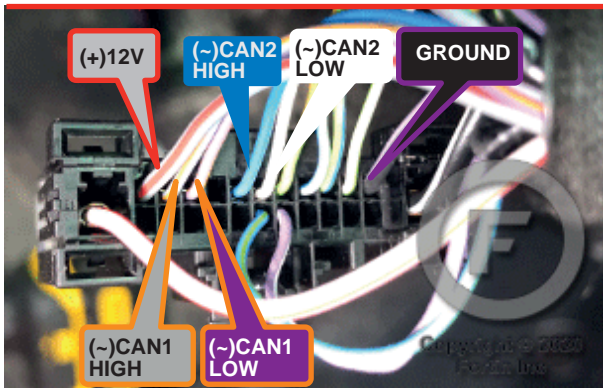

AUTOMATIC TRANSMISSION WIRING CONNECTION |

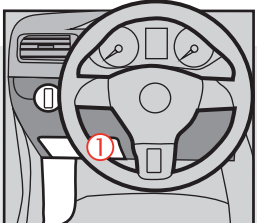
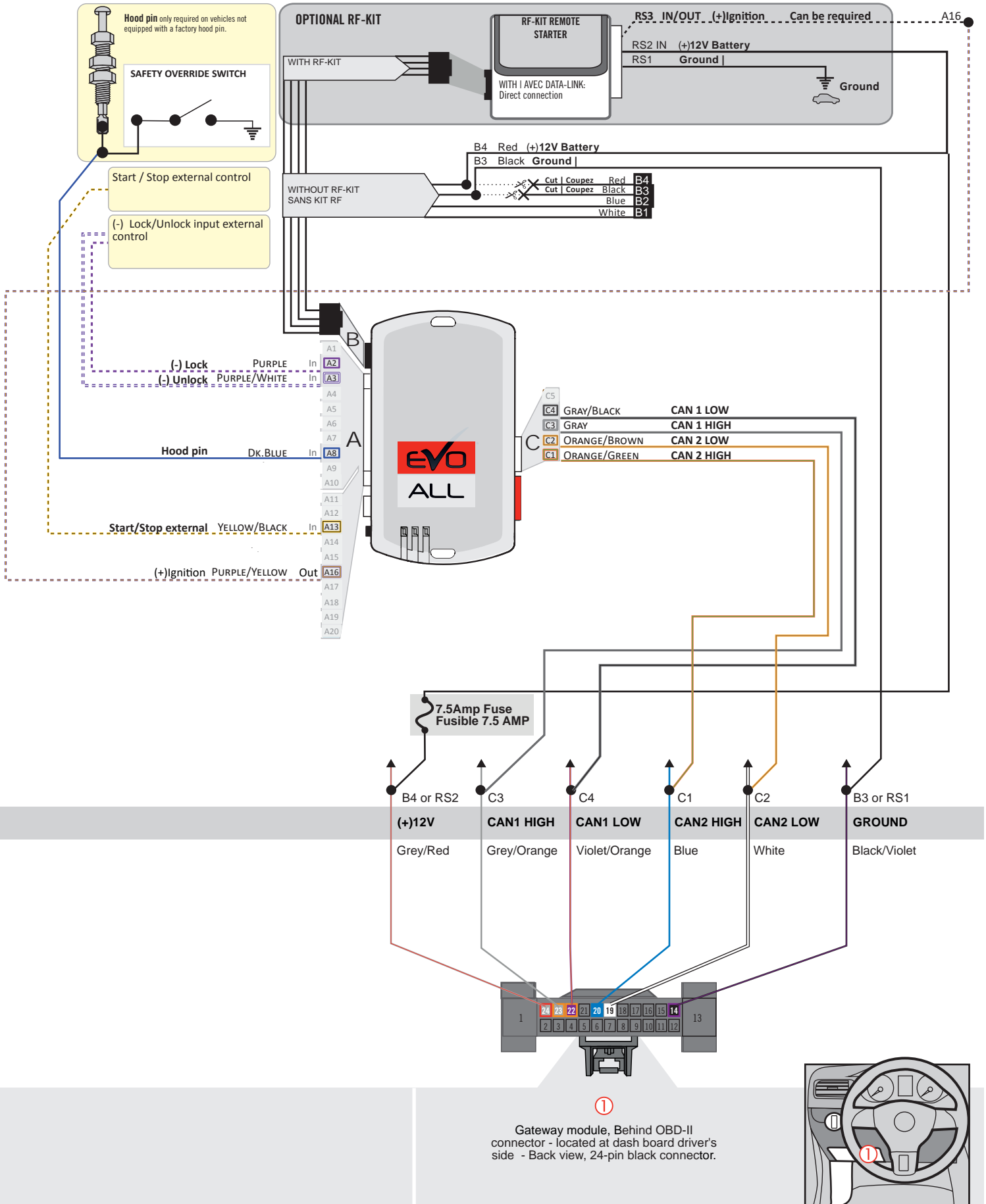

THAR-FOR3 | T-HARNESS - AUTOMATIC TRANSMISSION |

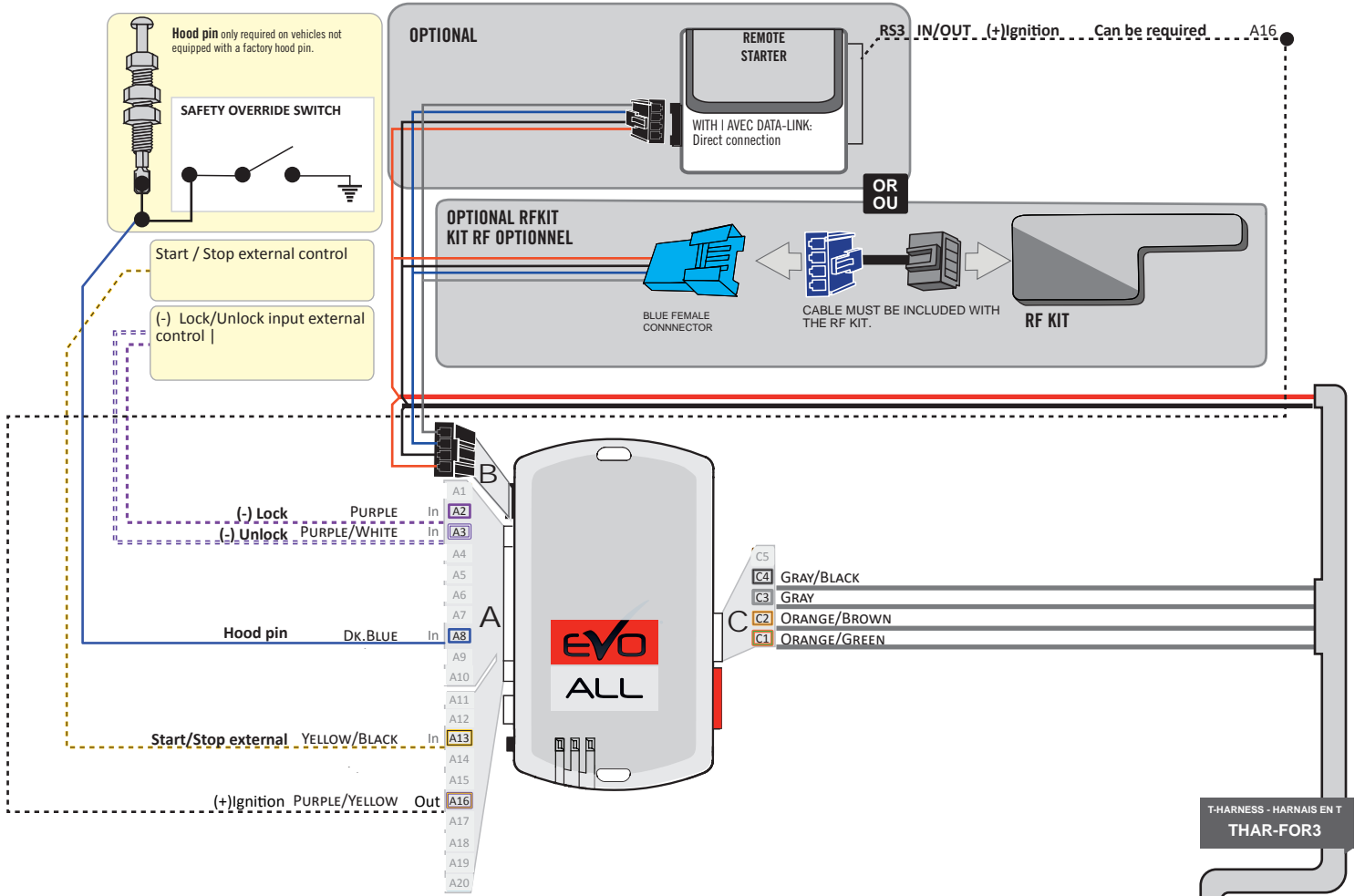

TRANSIT 250

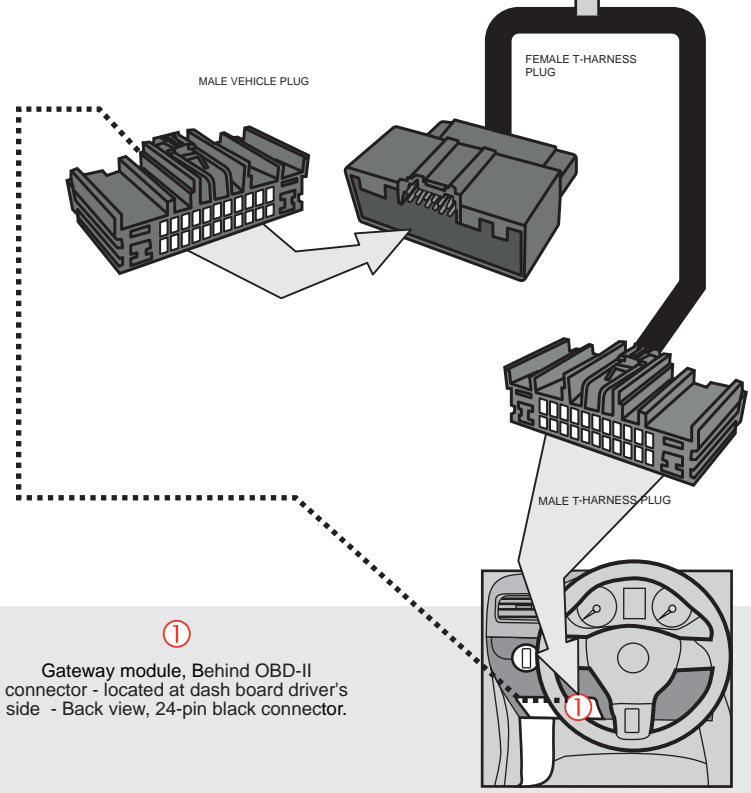



Parts required (not included)

- 1x FLASH LINK UPDATER, SOFTWARE | PROGRAMME
- 1x FLASH LINK MANAGER
- 1x Microsoft Windows Computer with Internet connection

OR

- 1x FLASH LINK MOBILE
- 1x FLASH LINK MOBILE APP
- Smartphone Android or iOS with Internet connection (Internet provider charges may apply)

BEFORE PROGRAMMING SET THE UNIT OPTIONS AND SAVE.

1

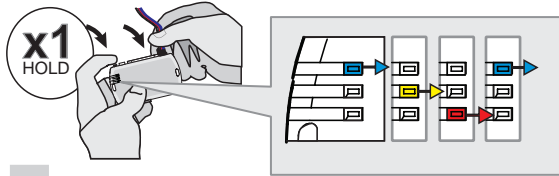

Press and hold the programming button:
Insert the 4-Pin (Data-Link) connector.

↳ The Blue, Red, Yellow and Blue & Red LEDs will alternatively illuminate.

2

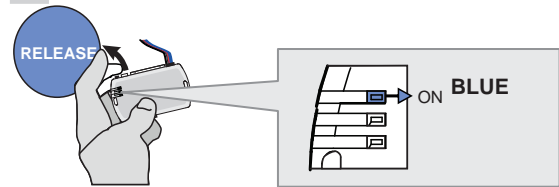

Release the programming button when the LED is BLUE.

If the LED is not solid BLUE disconnect the 4-Pin connector (Data-Link) and go back to step 1.

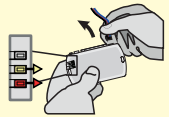

3

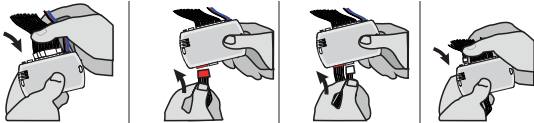

Insert the required remaining connectors.

4

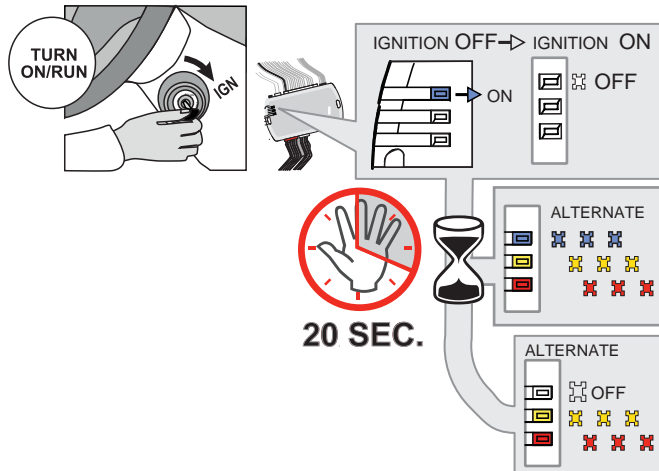

Turn the key to the Ignition ON/RUN position.

↳ The BLUE LED will turn OFF.

↳ The BLUE, YELLOW and RED LEDs will alternate.

Wait, at least 20 seconds, do not disconnect the modules or turn off the ignition.

↳ The RED and YELLOW LEDs will alternate.

Make sure that the DELs are flashing RED and YELLOW before continuing programming.

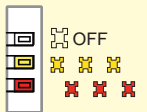

5

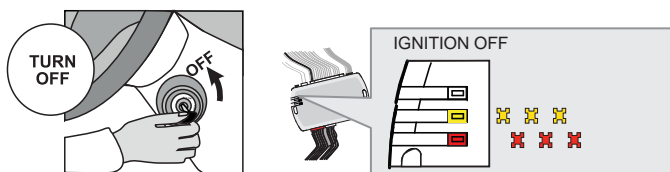

Turn the key to the OFF position.

↳ The RED and YELLOW LEDs alternate.

KEY BYPASS PROGRAMMING PROCEDURE 2/2 |

6

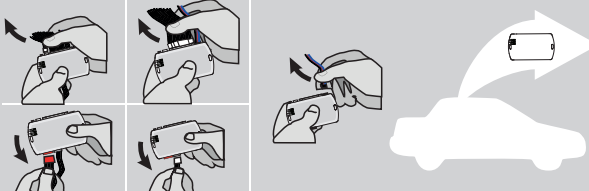

Disconnect all the connectors and after the Data-Link (4-pins) connector.

7



Microsoft Windows Computer with Internet connection*

FLASH LINK UPDATER* **FLASH LINK MANAGER***
SOFTWARE | PROGRAMME

OR

Smartphone* (Internet provider charges may apply)

VEHICLE'S OBDII CONNECTOR **FLASH LINK MOBILE***

Use the tool: FLASH LINK UPDATER or FLASH LINK MOBILE to visit the DCRYPTOR menu.

*Parts required (not included)

8

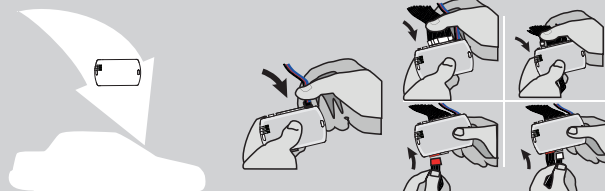

AFTER DCRYPTOR PROGRAMMING COMPLETED
Go back to the vehicle and reconnect the 4-Pin (Data-Link) connector and after, all the remaining connector.



↳ The BLUE LED will turn ON.

9

TURN ON/RUN

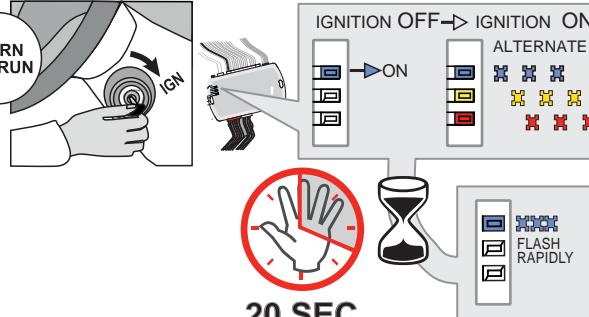

IGNITION OFF → IGNITION ON

ALTERNATE

↳ The RED and YELLOW LEDs will turn ON.

Wait, at least 20 seconds, do not disconnect the modules or turn off the ignition.

↳ The BLUE LED will flash rapidly.

20 SEC.

FLASH RAPIDLY

10

TURN OFF

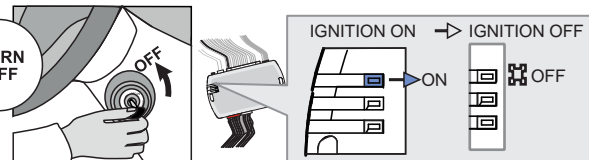

IGNITION ON → IGNITION OFF

↳ The BLUE will turn OFF.



The module is now programmed.

OPTIONAL RF-KIT PROGRAMMING |

PROGRAM BYPASS OPTION I

	Program bypass option:	H2	<input checked="" type="checkbox"/> Supported RF-KITS enable <input checked="" type="checkbox"/> H2 Fortin 2 <input checked="" type="checkbox"/>
--	------------------------	-----------	---

OPTIONAL FORTIN RF KIT SERIES 4 OR SERIES 9 PROGRAMMING

The module must be programmed on the vehicle. **MAKE SURE THE IGNITION KEY HAS BEEN IN THE OFF POSITION FOR AT LEAST 5 SECONDS.**

<p>1</p> <p>ON TURN ON/RUN</p>	<p>2</p> <p>OFF TURN OFF</p>	<p>3</p> <p>ON TURN ON/RUN</p>	<p>4</p> <p>4X BRAKES</p> <p>x4 PRESS</p>	<p>5</p> <p>ON EACH TRANSMITTER</p> <p>4 BUTTONS</p> <p>PRESS AND RELEASE</p> <p>PRESS AND RELEASE</p> <p>1 BUTTON</p> <p>PRESS APPROX. 12 SEC. AND WAIT FOR THE BLUE LED TO TURN OFF THEN BACK ON SOLID THEN RELEASE.</p>	<p>6</p> <p>OFF TURN OFF</p>	<p>7</p> <p>ON TURN ON/RUN</p>	<p>8</p> <p>OFF TURN OFF</p>
<p>Turn the key to the ON/RUN position.</p>	<p>Turn the ignition to the OFF position.</p>	<p>Turn the key to the ON/RUN position.</p>	<p>Press and release the brake pedal four times.</p>	<p>The LED will turn off each time.</p>	<p>Turn the ignition to the OFF position.</p>	<p>Turn the key to the ON/RUN position and leave it ON for 5 sec.</p>	<p>Turn the ignition to the OFF position.</p>
<p>The YELLOW LED will turn ON solid.</p>	<p>The YELLOW LED will turn Off.</p>	<p>The LED will turn ON solide.</p>	<p>The LED will flash rapidly.</p>	<p>The LED will flash rapidly.</p>	<p>The LED will turn Off.</p>	<p>The LED will turn Off.</p>	<p>The LED will turn Off.</p>
<p>The YELLOW LED will turn ON solid.</p>	<p>The YELLOW LED will turn Off.</p>	<p>The YELLOW LED will turn ON solid.</p>	<p>The 3 LED will turn ON solid.</p>	<p>The 3 LED will turn off each time.</p>	<p>The 3 LED will turn off.</p>	<p>The YELLOW LED will turn ON solid.</p>	<p>The YELLOW LED will turn Off.</p>



REMOTE STARTER FUNCTIONALITY |



All doors must be closed.



Remote start the vehicle.



Unlock the doors with the remote-starter remote or the OEM remote.



Insert and Turn the key to the Ignition ON/RUN position.



Press the brake pedal.



The vehicle can now be put in to gear and driven.

STANDALONE & THAR-FOR3 INSTALLATION

ADDENDUM - SUGGESTED WIRING CONFIGURATION



ONLY COMPATIBLE WITH AUTOMATIC TRANSMISSION VEHICLES.



Vehicle functions supported in this diagram (functional if equipped)

VEHICLE	YEARS	Immobilizer bypass	T-Harness available (sold separately)	Lock	Unlock	Arm	Disarm	Heated Seats**	Rear Defrost**	RAP Disable	Parking Lights***	Tachometer	Door Status	Trunk Status	Hood Status*	Hand-Brake Status	Foot-Brake Status	Active OEM Remote Start	
FORD																			
Transit Connect	2020-2022	•	•	•	•	•	•	•	•	•	•	•	•	•	•	•	•	•	•

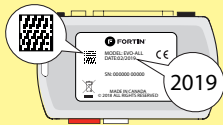

COMPATIBLE MODULE REQUIRED:

QR CODE ON THE LABEL
MANUFACTURED AFTER: 2019

FIRMWARE VERSION

58.[02]
MINIMUM

To add the firmware version and the options, use the **FLASH LINK UPDATER** or **FLASH LINK MOBILE** tool, sold separately.



Program bypass option:

UNIT OPTION

C1

DESCRIPTION

OEM Remote status (Lock/Unlock) monitoring

**IF THE VEHICLE IS NOT EQUIPPED WITH FUNCTIONAL HOOD PIN:
SI LE VÉHICULE N'EST PAS ÉQUIPÉ**

A11

OFF

Hood trigger (Output Status).

NOTES

The vehicles OEM remote and SmartKey are still operable during remote start.

**Heated seats The heated seats and rear defrost activate automatically when it cold.

***Parking Lights The parking Lights at remote start only.



The vehicle must be equipped with the OEM remote with the door locks.

MANDATORY INSTALL

*HOOD PIN



HOOD STATUS: THE HOOD PIN SWITCH MUST BE INSTALLED IF THE VEHICLE CAN BE REMOTE STARTED WITH THE HOOD OPEN, SET FUNCTION A11 TO OFF.

A11

OFF

Notice: the installation of safety elements are mandatory. The hood pin is an essential security element and must be installed.

THIS MODULE MUST BE INSTALLED BY A QUALIFIED TECHNICIAN. A WRONG CONNECTION CAN CAUSE PERMANENT DAMAGE TO THE VEHICLE.

PARTS REQUIRED (NOT INCLUDED) |

1x **FLASH LINK UPDATER,**
1x **FLASH LINK MANAGER**
SOFTWARE | PROGRAMME
1x Microsoft Windows Computer with Internet connection

OR

1x **FLASH LINK MOBILE**
1x **FLASH LINK MOBILE APP**
Smartphone *Android* or *iOS* with Internet connection (*provider charges may apply*).

MANDATORY

HOOD PIN



REMOTE START SAFETY OVERRIDE SWITCH

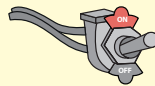

VALET SWITCH

Part #: RSPB available, Sold separately.

Notice: the installation of safety elements are mandatory. The hood pin and the valet switch are essential security elements and must be installed.

STAND ALONE CONFIGURATION |

	Program bypass option	UNIT OPTION	DESCRIPTION
	OEM Remote Stand Alone Remote Starter:	D1.10	By default, LOCK, LOCK, LOCK
		D1.1	Par défaut, VERROUILLE,VERROUILLE,VERROUILLE
	Program bypass option with oem remote:	C1	OEM Remote Monitoring
	Program bypass option with RF KIT antenna:	H1 to H6	Supported RF Kits and select RF Kit
	Program bypass option Vehicle hybrid only:	D4	Hybrid mode (Vehicle hybrid only)

REMOTE STARTER FUNCTIONALITY |

All doors must be closed.

3X

Press the OEM remote's Lock button 3x to remote-start (or remote-stop) the vehicle.

START

The vehicle will START.

REMOTE STARTER DIAGNOSTICS

MODULE RED LED

x2 flash : Brake ON

x3 flash : No tach

x4 flash : Ignition before start

x5 flash : Hood Open

REMOTE STARTER WARNING CARD |



CUT THIS WARNING CARD AND STICK IT ON A VISIBLE PLACE:
or use the package RSPB, Sold separately.

WARNING

REMOTE STARTER

THE VEHICLE CAN BE STARTED BY EITHER: PRESSING THE LOCK BUTTON ON THE OEM REMOTE 3 TIMES CONSECUTIVELY OR BY A SMARTPHONE. **TURN ON** THE SAFETY SWITCH LOCATED UNDER THE DASHBOARD BEFORE WORKING ON THE VEHICLE.

DESCRIPTION |

Parts required (Not included) **PAGE**

WIRE TO WIRE DIAGRAM

AUTOMATIC TRANSMISSION	1x 7.5 Amp. fuse	Page 3
------------------------	------------------	--------

THARNESSE DIAGRAM

THARNESSE THAR-FOR3 AUTOMATIC TRANSMISSION	1x THAR-FOR3	Page 4
--	--------------	--------



② Parking Lights switch

① Gateway module, located at dash board driver's side,

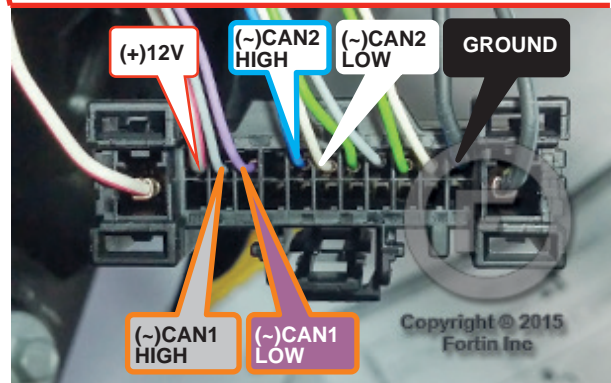
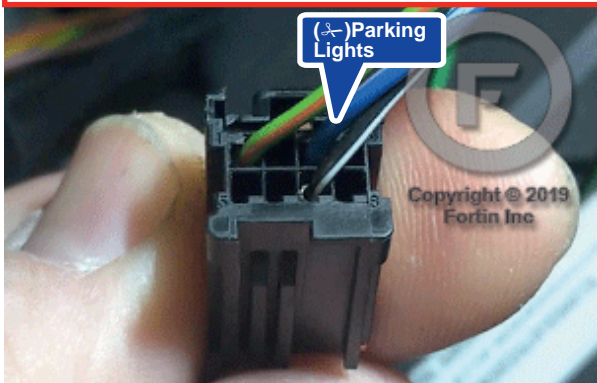

④ Under the hood If not equipped with hood pin.

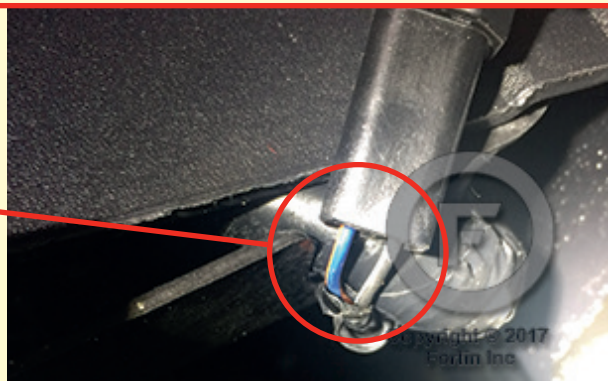

AUTOMATIC TRANSMISSION WIRING CONNECTION |

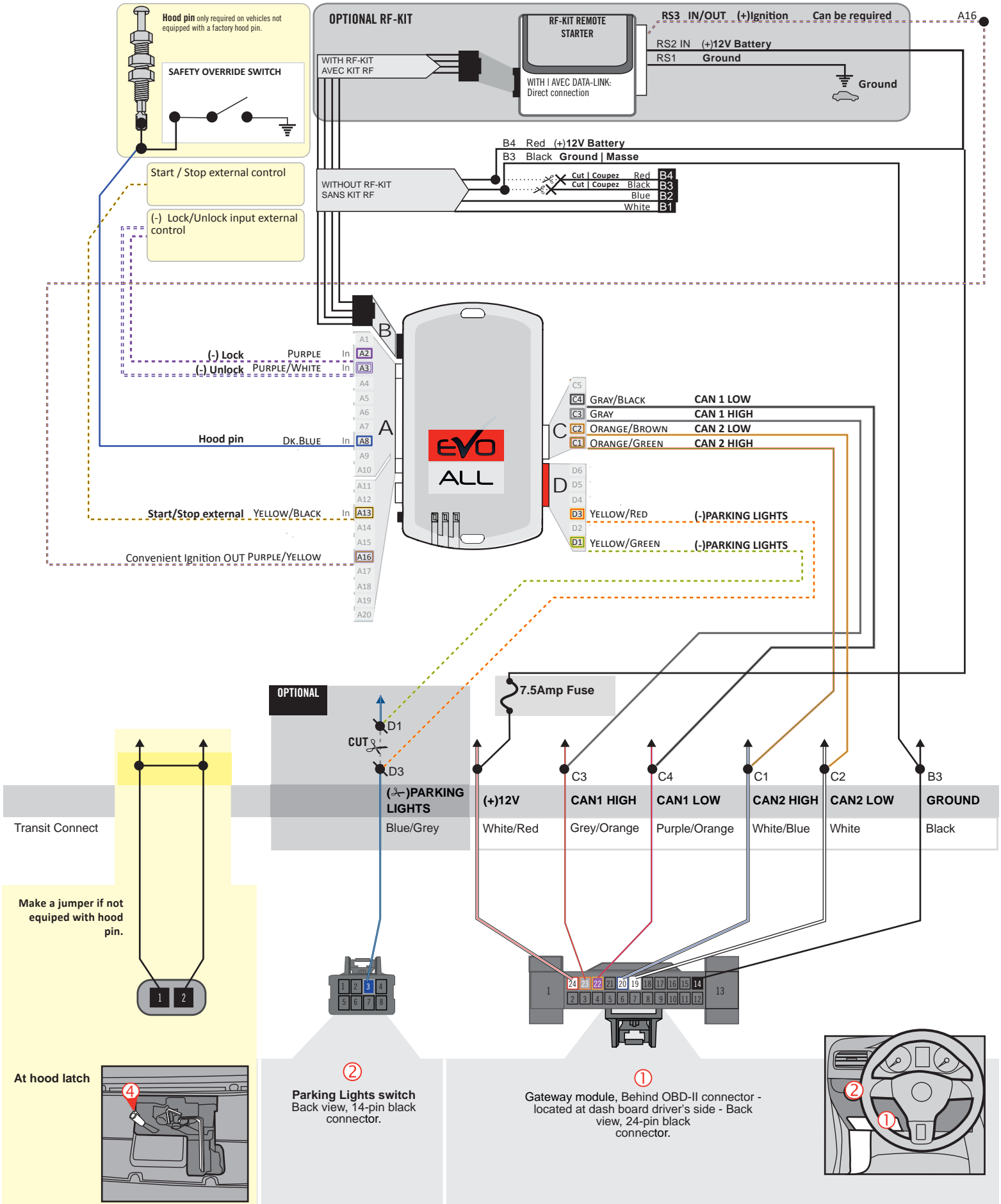

THAR-FOR3 | T-HARNESS - AUTOMATIC TRANSMISSION |

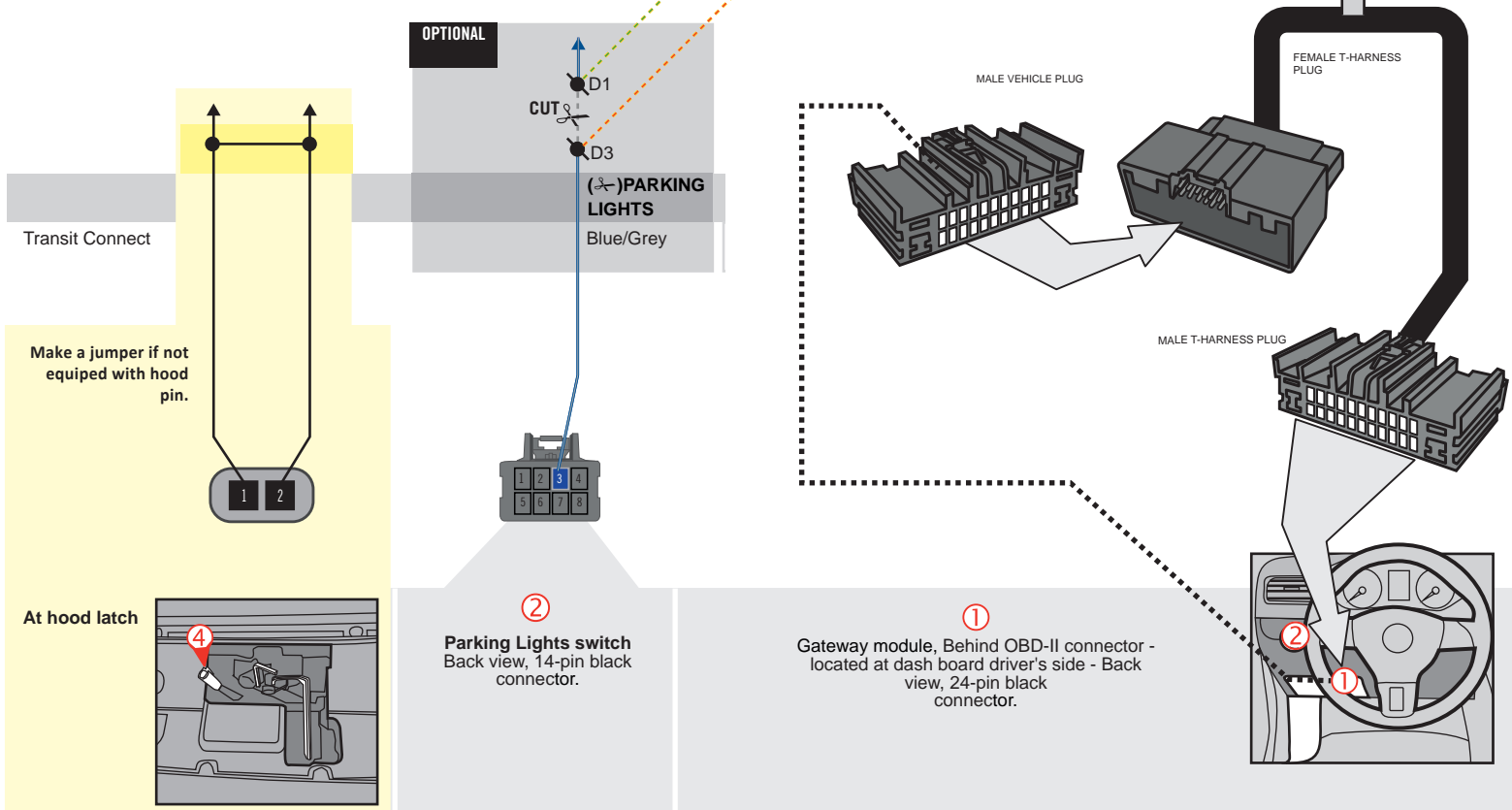
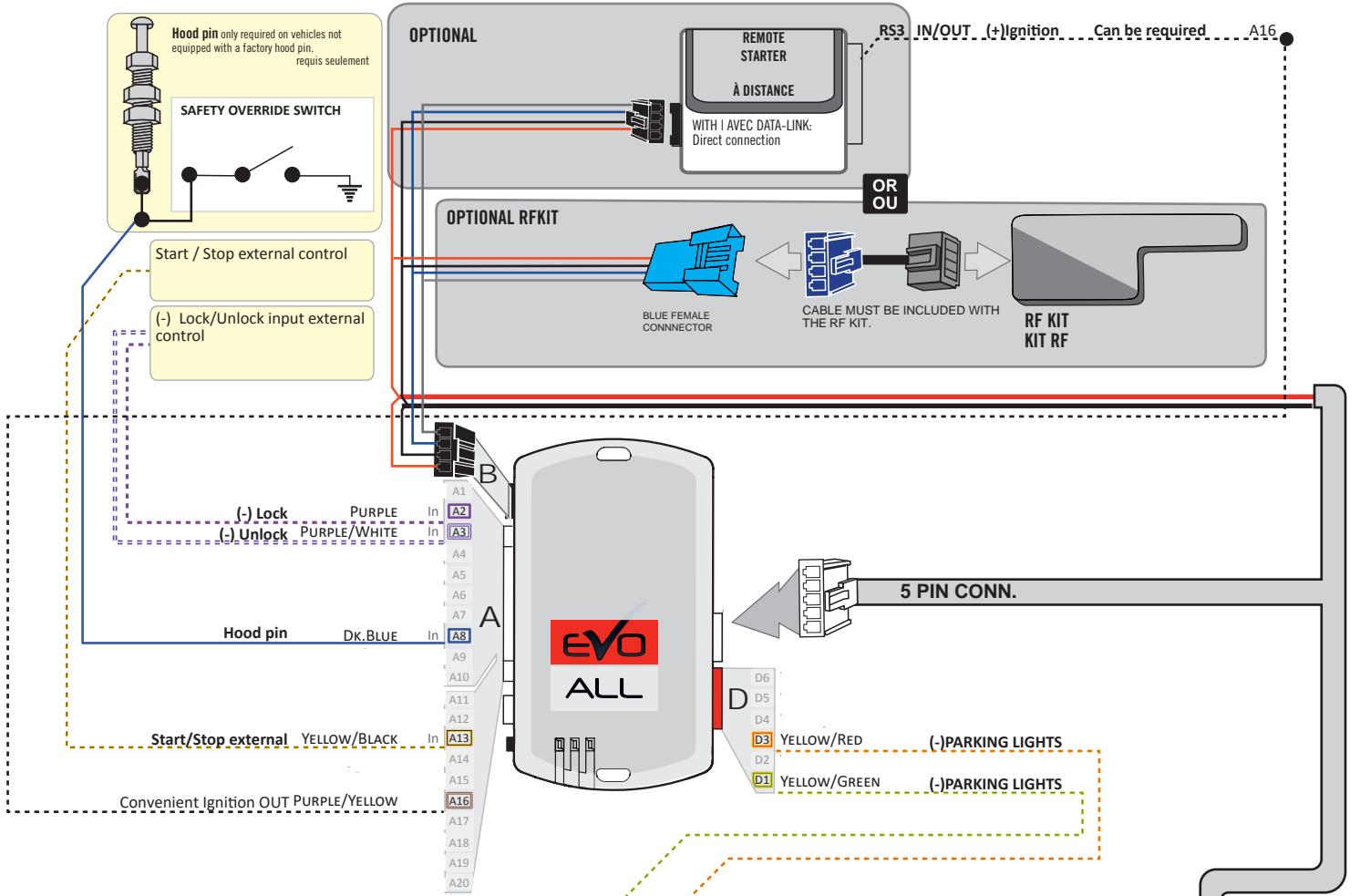



Parts required (not included)

- 1x FLASH LINK UPDATER, SOFTWARE | PROGRAMME
- 1x FLASH LINK MANAGER
- 1x Microsoft Windows Computer with Internet connection

OR

- 1x FLASH LINK MOBILE
- 1x FLASH LINK MOBILE APP
- Smartphone Android or iOS with Internet connection (Internet provider charges may apply)

BEFORE PROGRAMMING SET THE UNIT OPTIONS AND SAVE.

1

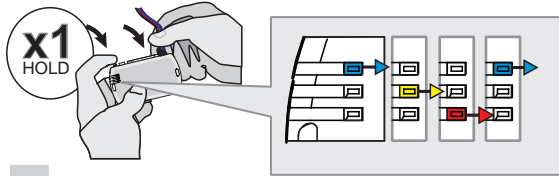

Press and hold the programming button:
Insert the 4-Pin (Data-Link) connector.

↳ The Blue, Red, Yellow and Blue & Red LEDs will alternatively illuminate.

2

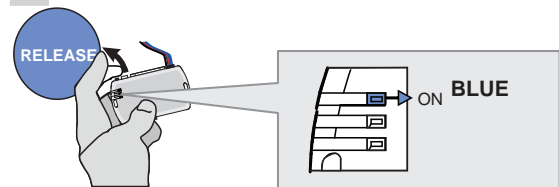

Release the programming button when the LED is BLUE.

If the LED is not solid BLUE disconnect the 4-Pin connector (Data-Link) and go back to step 1.

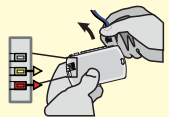

3

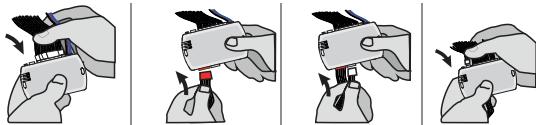

Insert the required remaining connectors.

4

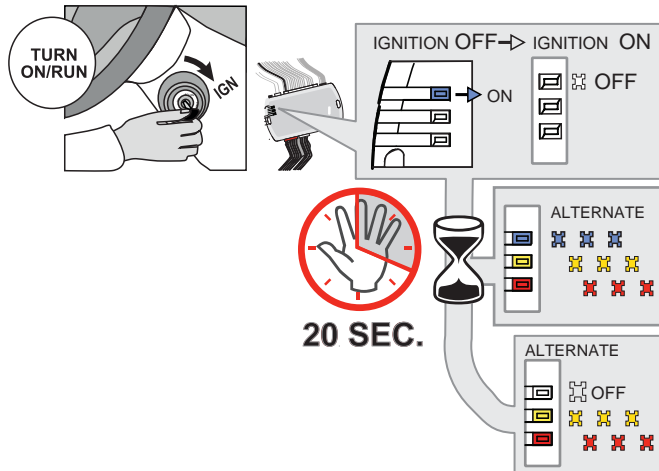

Turn the key to the Ignition ON/RUN position.

↳ The BLUE LED will turn OFF.

↳ The BLUE, YELLOW and RED LEDs will alternate.

Wait, at least 20 seconds, do not disconnect the modules or turn off the ignition.

↳ The RED and YELLOW LEDs will alternate.

Make sure that the DELs are flashing RED and YELLOW before continuing programming.

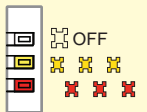

5

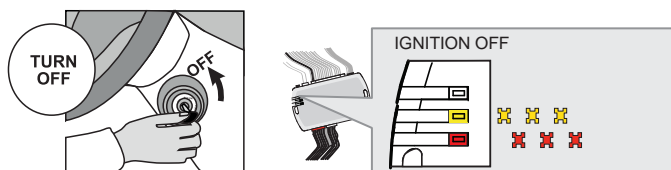

Turn the key to the OFF position.

↳ The RED and YELLOW LEDs alternate.

KEY BYPASS PROGRAMMING PROCEDURE 2/2 |

6

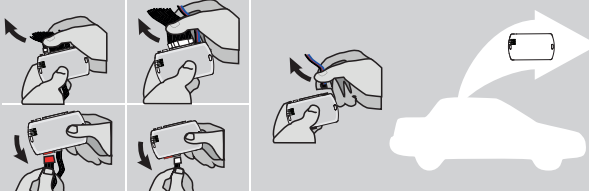

Disconnect all the connectors and after the Data-Link (4-pins) connector.

7



Microsoft Windows Computer with Internet connection*

FLASH LINK UPDATER* **FLASH LINK MANAGER***
SOFTWARE | PROGRAMME

OR

Smartphone* (Internet provider charges may apply)

VEHICLE'S OBDII CONNECTOR **FLASH LINK MOBILE***

Use the tool: FLASH LINK UPDATER or FLASH LINK MOBILE to visit the DCRYPTOR menu.

*Parts required (not included)

8

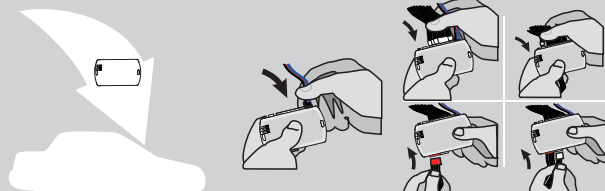

AFTER DCRYPTOR PROGRAMMING COMPLETED
Go back to the vehicle and reconnect the 4-Pin (Data-Link) connector and after, all the remaining connector.



↳ The BLUE LED will turn ON.

9

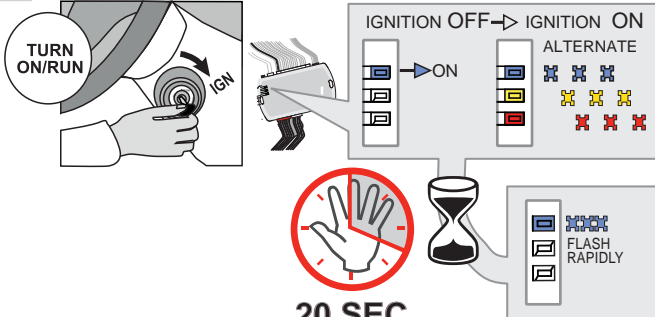

TURN ON/RUN

IGNITION OFF → IGNITION ON

ALTERNATE

↳ The RED and YELLOW LEDs will turn ON.

Wait, at least 20 seconds, do not disconnect the modules or turn off the ignition.

↳ The BLUE LED will flash rapidly.

20 SEC.

FLASH RAPIDLY

10

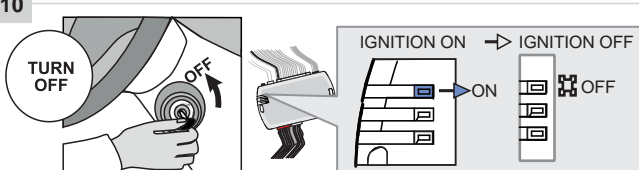

TURN OFF

IGNITION ON → IGNITION OFF

↳ The BLUE will turn OFF.



The module is now programmed.

OPTIONAL RF-KIT PROGRAMMING |

PROGRAM BYPASS OPTION



Program bypass option:

H2

Supported RF-KITS enable

H2 Fortin 2

OPTIONAL FORTIN RF KIT SERIES 4 OR SERIES 9 PROGRAMMING



The module must be programmed on the vehicle.

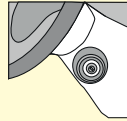

MAKE SURE THE IGNITION KEY HAS BEEN IN THE OFF POSITION FOR AT LEAST 5 SECONDS.

<p>1</p> <p>ON TURN ON/RUN</p> <p>Turn the key to the ON/RUN position.</p>	<p>2</p> <p>OFF TURN OFF</p> <p>Turn the ignition to the OFF position.</p>	<p>3</p> <p>ON TURN ON/RUN</p> <p>Turn the key to the ON/RUN position.</p>	<p>4</p> <p>4X BRAKES</p> <p>x4 PRESS</p> <p>Press and release the brake pedal four times.</p>	<p>5</p> <p>ON EACH TRANSMITTER</p> <p>4 BUTTONS</p> <p>PRESS AND RELEASE</p> <p>PRESS AND RELEASE</p> <p>1 BUTTON</p> <p>PRESS APPROX. 12 SEC. AND WAIT FOR THE BLUE LED TO TURN OFF THEN BACK ON SOLID THEN RELEASE.</p>	<p>6</p> <p>OFF TURN OFF</p> <p>Turn the ignition to the OFF position.</p>	<p>7</p> <p>ON TURN ON/RUN</p> <p>Turn the key to the ON/RUN position and leave it ON for 5 sec.</p>	<p>8</p> <p>OFF TURN OFF</p> <p>Turn the ignition to the OFF position.</p>
<p>The YELLOW LED will turn ON solid.</p>	<p>The YELLOW LED will turn Off.</p>	<p>The LED will turn ON solide.</p> <p>The YELLOW LED will turn ON solid.</p>	<p>The LED will flash rapidly.</p> <p>The LED will turn off each time.</p>	<p>The LED will turn off each time.</p> <p>The LED will flash rapidly.</p>	<p>The LED will turn Off.</p>	<p>The LED will turn Off.</p>	<p>The LED will turn Off.</p>
<p>The 3 LED will turn ON solid.</p>	<p>The 3 LED will turn ON solid.</p>	<p>The 3 LED will turn ON solid.</p>	<p>The 3 LED will turn off each time.</p>	<p>The 3 LED will turn off each time.</p>	<p>The 3 LED will turn off.</p>	<p>The YELLOW LED will turn ON solid.</p>	<p>The YELLOW LED will turn Off.</p>



REMOTE STARTER FUNCTIONALITY |



All doors must be closed.



Remote start the vehicle.



Unlock the doors with the remote-starter remote or the OEM remote.



Insert and Turn the key to the Ignition ON/RUN position.



Press the brake pedal.



The vehicle can now be put in to gear and driven.

STANDALONE & THAR-FOR3 INSTALLATION

ADDENDUM - SUGGESTED WIRING CONFIGURATION



ONLY COMPATIBLE WITH AUTOMATIC TRANSMISSION VEHICLES.

Vehicle functions supported in this diagram (functional if equipped)

VEHICLE	YEARS	Vehicle functions supported in this diagram (functional if equipped)															
		Immobilizer bypass	Lock	Unlock	Arm	Disarm	Heated Seats**	Rear Defrost**	RAP Disable	Parking Lights***	Tachometer	Door Status	Trunk Status	Hood Status*	Hand-Brake Status	Foot-Brake Status	Active OEM Remote Start
LINCOLN																	
Corsair	Push-to-Start 2020	•	•	•	•	•	•	•	•	•	•	•	•	•	•	•	•



	COMPATIBLE MODULE REQUIRED:	QR CODE ON THE LABEL MANUFACTURED AFTER: 2019	FIRMWARE VERSION 58.[02] MINIMUM	To add the firmware version and the options, use the FLASH LINK UPDATER or FLASH LINK MOBILE tool, sold separately.

	Program bypass option:	UNIT OPTION	DESCRIPTION
		C1	OEM Remote status (Lock/Unlock) monitoring
D6	Push-to-Start		
IF THE VEHICLE IS NOT EQUIPPED WITH FUNCTIONAL HOOD PIN:		A11	OFF Hood trigger (Output Status).

NOTES

The vehicles OEM remote and SmartKey are still operable during remote start.

**Heated seats The heated seats and rear defrost activate automatically when it cold.

**Rear Defrost

***Parking Lights The parking Lights at remote start only.

MANDATORY INSTALL

*HOOD PIN **HOOD STATUS: THE HOOD PIN SWITCH MUST BE INSTALLED IF THE VEHICLE CAN BE REMOTE STARTED WITH THE HOOD OPEN, SET FUNCTION A11 TO OFF.**

A11 **OFF**

Notice: the installation of safety elements are mandatory. The hood pin is an essential security element and must be installed.

THIS MODULE MUST BE INSTALLED BY A QUALIFIED TECHNICIAN. A WRONG CONNECTION CAN CAUSE PERMANENT DAMAGE TO THE VEHICLE.

PARTS REQUIRED (NOT INCLUDED) |

1x **FLASH LINK UPDATER,**
1x **FLASH LINK MANAGER**
SOFTWARE | PROGRAMME
1x Microsoft Windows Computer with Internet connection

OR

1x **FLASH LINK MOBILE**
1x **FLASH LINK MOBILE APP**
Smartphone *Android* or *iOS* with Internet connection (*provider charges may apply*).

MANDATORY

HOOD PIN



REMOTE START SAFETY OVERRIDE SWITCH

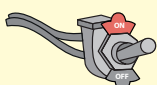







VALET SWITCH

Part #: RSPB available, Sold separately.

Notice: the installation of safety elements are mandatory. The hood pin and the valet switch are essential security elements and must be installed.

STAND ALONE CONFIGURATION |

	Program bypass option	UNIT OPTION	DESCRIPTION
	OEM Remote Stand Alone Remote Starter:	D1.10 	By default, LOCK, LOCK, LOCK Par défaut, VERROUILLE,VERROUILLE,VERROUILLE
		D1.1 	
	Program bypass option with oem remote:	C1	OEM Remote Monitoring
	Program bypass option with RF KIT antenna:	H1 to H6	Supported RF Kits and select RF Kit
	Program bypass option Vehicle hybrid only:	D4	Hybrid mode (Vehicle hybrid only)

REMOTE STARTER FUNCTIONALITY |



All doors must be closed.

3X 

Press the OEM remote's Lock button 3x to remote-start (or remote-stop) the vehicle.



START 

The vehicle will START.

REMOTE STARTER DIAGNOSTICS

MODULE RED LED

x2 flash : Brake ON

x3 flash : No tach

x4 flash : Ignition before start

x5 flash : Hood Open

REMOTE STARTER WARNING CARD |



CUT THIS WARNING CARD AND STICK IT ON A VISIBLE PLACE:
or use the package **RSPB**, Sold separately.

WARNING



REMOTE STARTER

THE VEHICLE CAN BE STARTED BY EITHER: PRESSING THE LOCK BUTTON ON THE OEM REMOTE 3 TIMES CONSECUTIVELY OR BY A SMARTPHONE. **TURN ON** THE SAFETY SWITCH LOCATED UNDER THE DASHBOARD BEFORE WORKING ON THE VEHICLE.

DESCRIPTION | DESCRIPTION

	Parts required (Not included)	PAGE
--	-------------------------------	------

WIRE TO WIRE DIAGRAM

AUTOMATIC TRANSMISSION	1x 7.5 Amp. fuse	Page 3
------------------------	------------------	--------

THARNES DIAGRAM

THARNES THAR-FOR3 AUTOMATIC TRANSMISSION	1x THAR-FOR3	Page 4
--	--------------	--------



CORSAIR

① Gateway module, Behind OBD-II connector

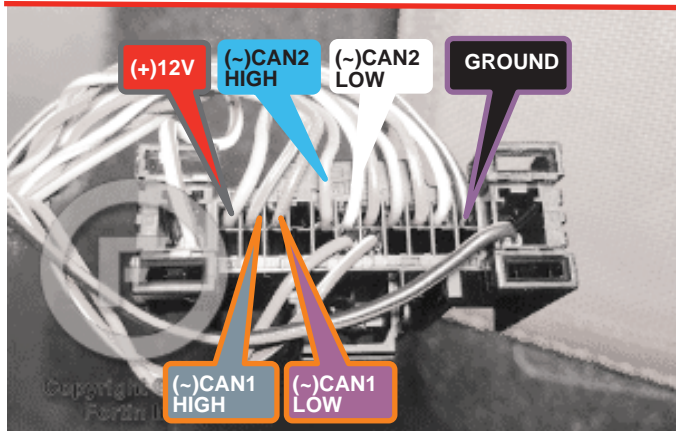

AUTOMATIC TRANSMISSION WIRING CONNECTION

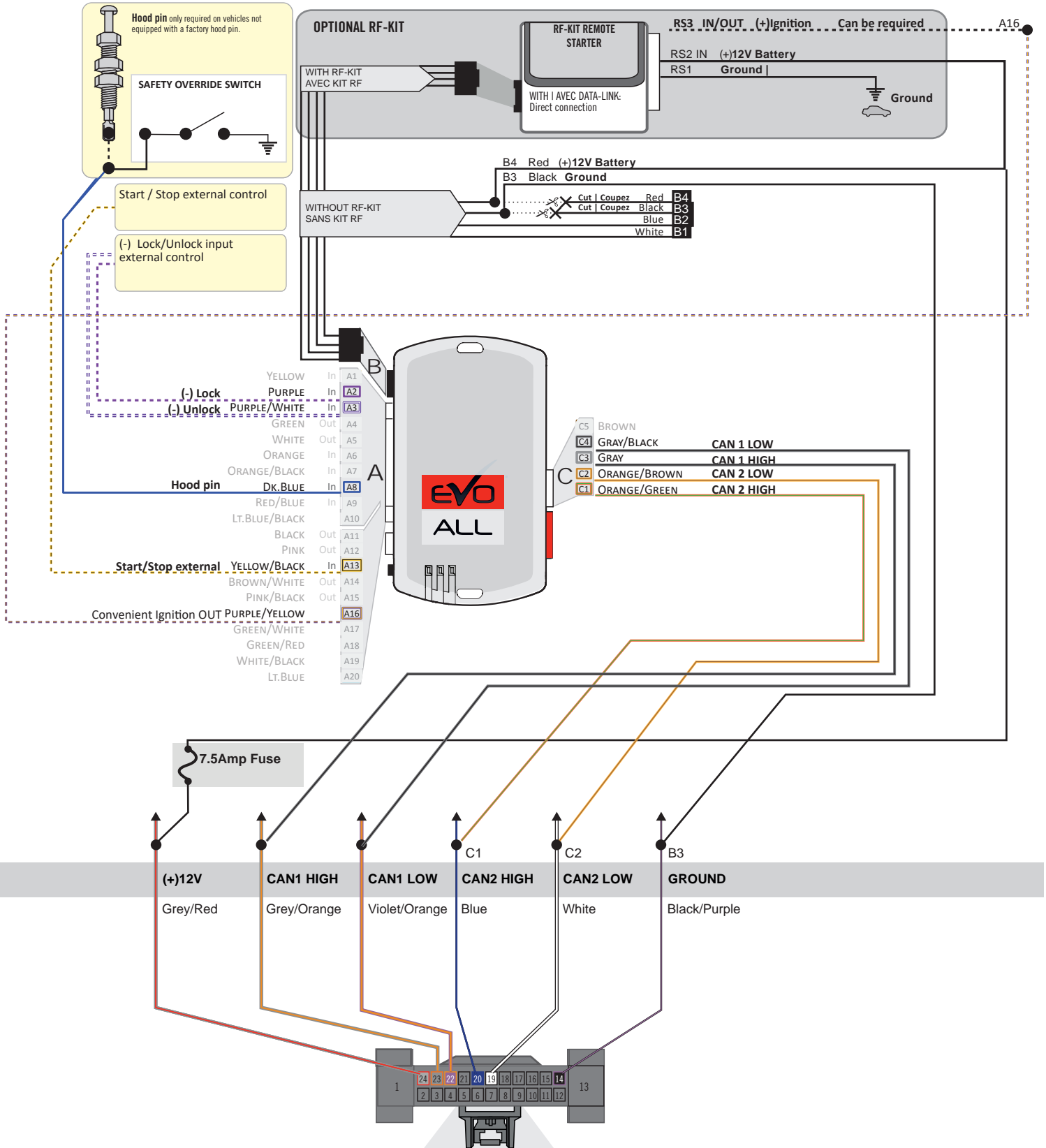

CORSAIR

① Gateway module, Connector Behind OBD-II connector - located at dash board driver's side Back view, 24-pin black connector.

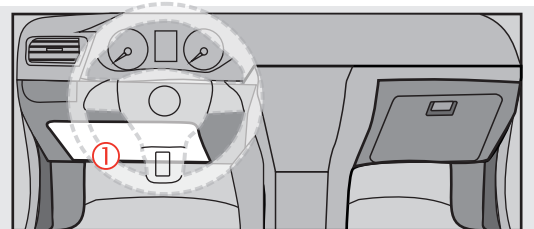

THAR-FOR3 | T-HARNESS - AUTOMATIC TRANSMISSION

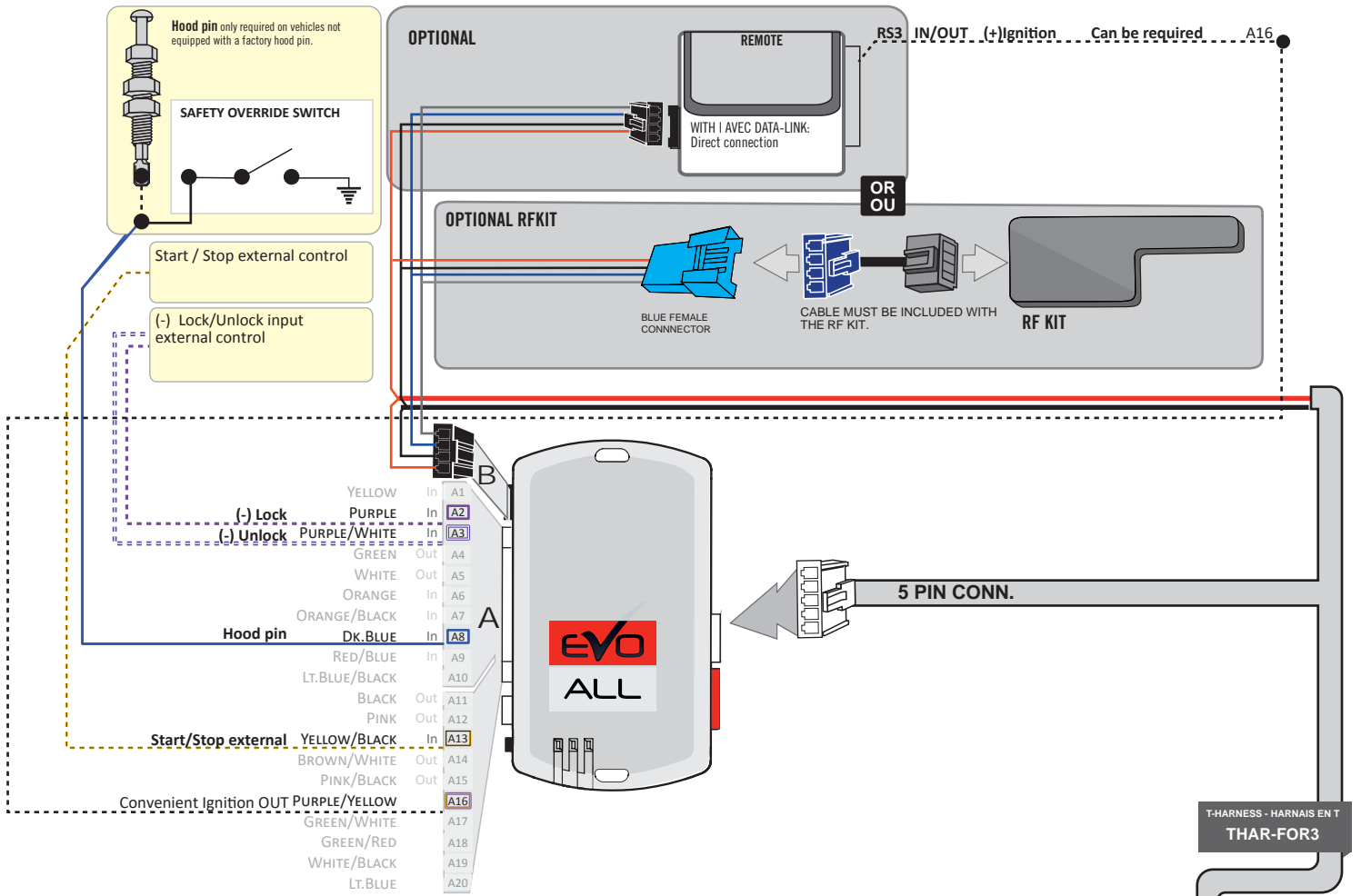

CORSAIR

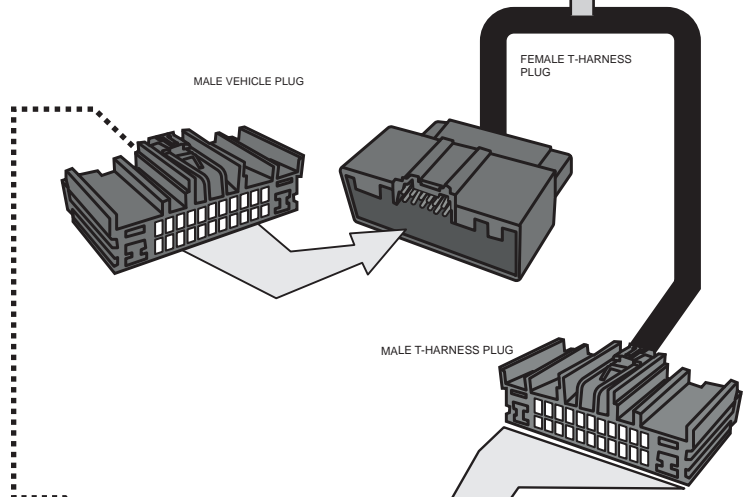

① Gateway module, Connector Behind OBD-II connector - located at dash board driver's side Back view, 24-pin black connector.

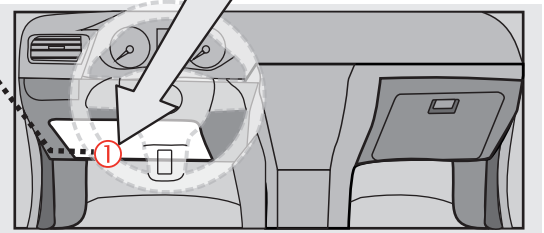

DCRYPTOR PROGRAMMING PROCEDURE



Parts required (not included)

- 1x FLASH LINK UPDATER, SOFTWARE | PROGRAMME
- 1x FLASH LINK MANAGER
- 1x Microsoft Windows Computer with Internet connection

OR

- 1x FLASH LINK MOBILE
- 1x FLASH LINK MOBILE APP
- Smartphone Android or iOS with Internet connection (Internet provider charges may apply)

BEFORE PROGRAMMING SET THE UNIT OPTIONS AND SAVE.

1

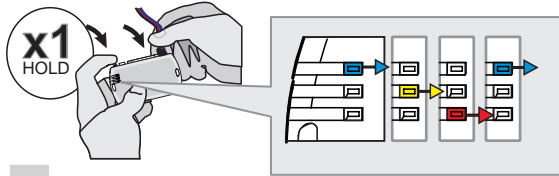

Press and hold the programming button:
Insert the 4-Pin (Data-Link) connector.

↳ The Blue, Red, Yellow and Blue & Red LEDs will alternatively illuminate.

2

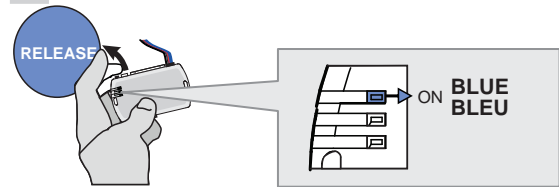

Release the programming button when the LED is BLUE.

If the LED is not solid BLUE disconnect the 4-Pin connector (Data-Link) and go back to step 1.

3

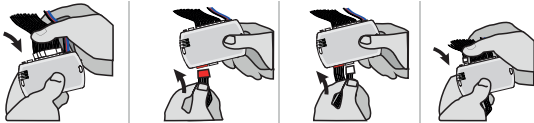

Insert the required remaining connectors.

4

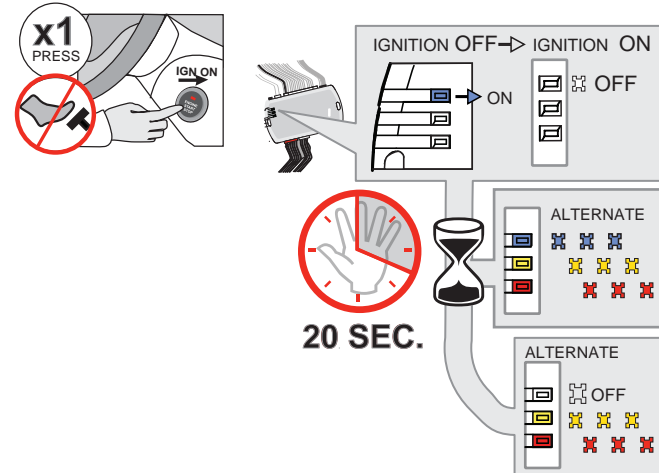

Do not press the brake pedal.
Press the Push-to-Start button once to turn on the ignition.

↳ The BLUE LED will turn OFF.

↳ The BLUE, YELLOW and RED LEDs will alternate.

Wait, at least 20 seconds, do not disconnect the modules or turn off the ignition.

↳ The RED and YELLOW LEDs will alternate.

Make sure that the DELs are flashing RED and YELLOW before continuing programming.

5

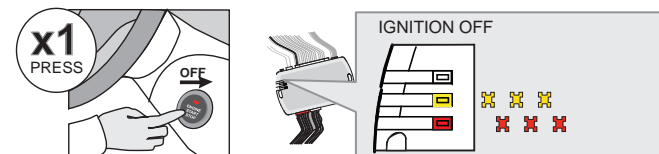

Press the Push-to-Start button once to turn off the ignition.

↳ The RED and YELLOW LEDs alternate.

KEY BYPASS PROGRAMMING PROCEDURE 2/2

6

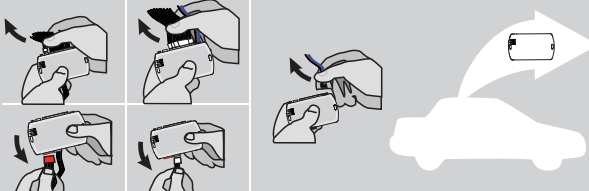

Disconnect all the connectors and after the Data-Link (4-pins) connector.

7



Microsoft Windows Computer with Internet connection*

FLASH LINK UPDATER* **FLASH LINK MANAGER***
SOFTWARE | PROGRAMME

OR

Smartphone* (Internet provider charges may apply)

VEHICLE'S OBDII CONNECTOR **FLASH LINK MOBILE***

Use the tool: FLASH LINK UPDATER or FLASH LINK MOBILE to visit the DCryptor menu.

*Parts required (not included)

8

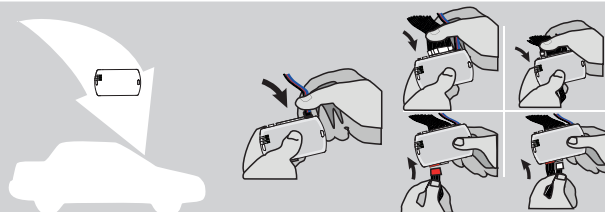

AFTER DCRYPTOR PROGRAMMING COMPLETED
Go back to the vehicle and reconnect the 4-Pin (Data-Link) connector and after, all the remaining connector.

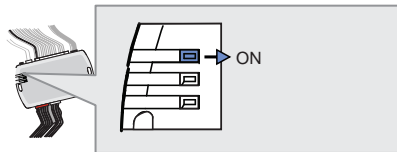

↳ The BLUE LED will turn ON.

9

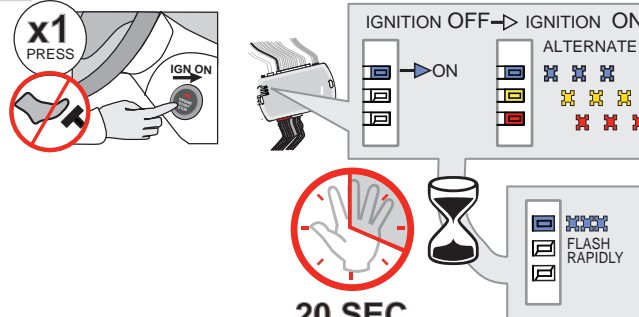

x1 PRESS (with a red 'X' over the brake pedal)

IGNITION OFF → IGNITION ON

ALTERNATE

ON

↳ The RED and YELLOW LEDs will turn ON.

20 SEC.

FLASH RAPIDLY

Wait, at least 20 seconds, do not disconnect the modules or turn off the ignition.

↳ The BLUE LED will flash rapidly.

10

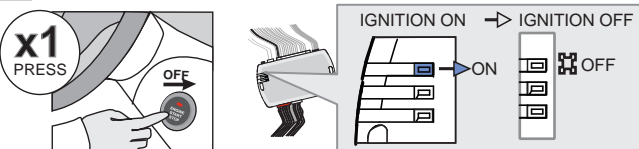

x1 PRESS

IGNITION ON → IGNITION OFF

ON

OFF

Press the Push-to-Start button once to turn off the ignition.

↳ The BLUE will turn OFF.



The module is now programmed.

OPTIONAL RF-KIT PROGRAMMING

PROGRAM BYPASS OPTION







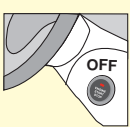



	<p>Program bypass option:</p>	<p>H2</p>	<p><input checked="" type="checkbox"/> Supported RF-KITS enable <input checked="" type="checkbox"/> H2 Fortin 2</p>
---	-------------------------------	------------------	---

OPTIONAL FORTIN RF KIT SERIES 4 OR SERIES 9 PROGRAMMING

The module must be programmed on the vehicle.

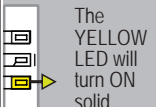

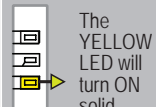
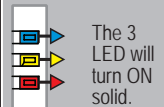

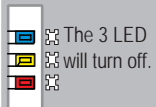
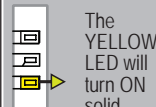
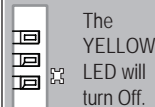
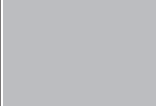
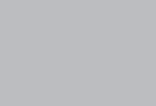

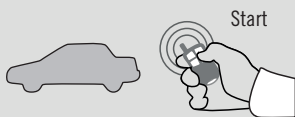

MAKE SURE THE IGNITION KEY HAS BEEN IN THE OFF POSITION FOR AT LEAST 5 SECONDS.

<p>1</p> <p>ON x1 PRESS</p>  <p>Do not press the brake pedal. Press the Push-to-Start button once to turn on the ignition.</p>	<p>2</p> <p>OFF x1 PRESS</p>  <p>Press the Push-to-Start button once to turn off the ignition.</p>	<p>3</p> <p>ON x1 PRESS</p>  <p>Do not press the brake pedal. Press the Push-to-Start button once to turn on the ignition.</p>	<p>4</p> <p>4X BRAKES</p> <p>x4 PRESS</p>  <p>Press and release the brake pedal four times.</p>	<p>5</p> <p>ON EACH TRANSMITTER</p> <p>4 BUTTONS</p> <p>[-] PRESS AND RELEASE</p> <p>→ PRESS AND RELEASE</p> <p>1 BUTTON</p> <p>PRESS APPROX. 12 SEC. AND WAIT FOR THE BLUE LED TO TURN OFF THEN BACK ON SOLID THEN RELEASE.</p>	<p>6</p> <p>OFF x1 PRESS</p>  <p>Press the Push-to-Start button once to turn off the ignition.</p>	<p>7</p> <p>ON x1 PRESS</p>  <p>Do not press the brake pedal. Press the Push-to-Start button once to turn on the ignition and leave it ON for 5 sec..</p>	<p>8</p> <p>OFF x1 PRESS</p>  <p>Press the Push-to-Start button once to turn off the ignition.</p>
 <p>The YELLOW LED will turn ON solid.</p>	 <p>The YELLOW LED will turn Off.</p>	 <p>The YELLOW LED will turn ON solid.</p>	 <p>The LED will turn off each time.</p> <p>The LED will flash rapidly.</p>	 <p>The LED will turn off each time.</p> <p>The LED will flash rapidly.</p>	 <p>The LED will turn Off.</p>	 <p>The YELLOW LED will turn ON solid.</p>	 <p>The YELLOW LED will turn Off.</p>
 <p>The 3 LED will turn ON solid.</p>  <p>The 3 LED will turn off each time.</p>							

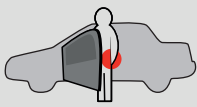

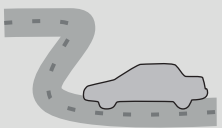
REMOTE STARTER FUNCTIONALITY

 <p>Start</p> <p>All doors must be closed.</p> <p>Remote start the vehicle.</p>	 <p>UNLOCK</p> <p>Unlock the doors with either:</p> <ul style="list-style-type: none"> • The OEM remote • The remote-starter remote • Or the proximity remote 	 <p>Enter the vehicle with the SMART-KEY.</p>	 <p>DO NOT PRESS THE BRAKE PEDAL.</p> <p>Press and release the Push-to-Start button once.</p>	 <p>Press the brake pedal. The vehicle can now be put in to gear and driven.</p> <p>If the Smart-Key is not detected the vehicle will shut down.</p>
--	---	--	---	---

THAR-FOR3 THARNNESS INSTALLATION

ADDENDUM - SUGGESTED WIRING CONFIGURATION



ONLY COMPATIBLE WITH AUTOMATIC TRANSMISSION VEHICLES.



Vehicle functions supported in this diagram (functional if equipped)

VEHICLE	YEARS	Immobilizer bypass	T-Harness	Lock	Unlock	Arm	Disarm	RAP Disable	Parking Lights	Tachometer	Door Status	Trunk Status	Hood Status*	Hand-Brake Status	Foot-Brake Status	Active OEM Remote Start
FORD EcoSport	Key 2018-2020	•	•	•	•	•	•	•	•	•	•	•	•	•	•	•



FIRMWARE VERSION

4.02

ONLY - SEULEMENT

To add the firmware version and the options, use the **FLASH LINK UPDATER** or **FLASH LINK MOBILE** tool, sold separately.



Program bypass option:

UNIT OPTION

C1

DESCRIPTION

OEM Remote status (Lock/Unlock) monitoring

IF THE VEHICLE IS NOT EQUIPPED WITH FUNCTIONAL HOOD PIN:

A11

OFF

Hood trigger (Output Status).



Parts required (Not included)

1x THAR-FOR3

NOTES

The vehicles OEM remote and SmartKey are still operable during remote start.



The vehicle must be equipped with the OEM remote with the door locks.

MANDATORY INSTALL

*HOOD PIN



HOOD STATUS: THE HOOD PIN SWITCH MUST BE INSTALLED IF THE VEHICLE CAN BE REMOTE STARTED WITH THE HOOD OPEN, SET FUNCTION **A11** TO OFF.

A11

OFF

Notice: the installation of safety elements are mandatory. The hood pin is an essential security element and must be installed.

THIS MODULE MUST BE INSTALLED BY A QUALIFIED TECHNICIAN. A WRONG CONNECTION CAN CAUSE PERMANENT DAMAGE TO THE VEHICLE.

DESCRIPTION

③ Behind glove box

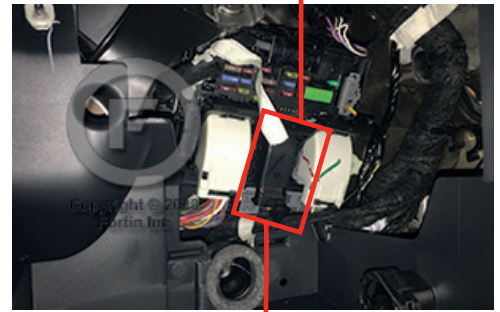
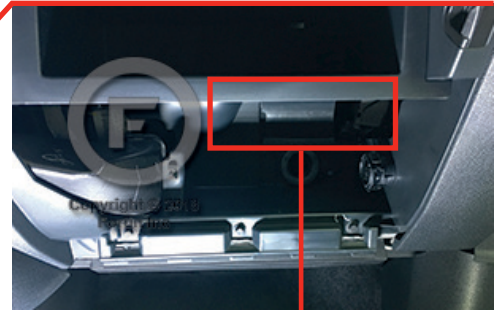

① Gateway module, Behind OBD-II connector

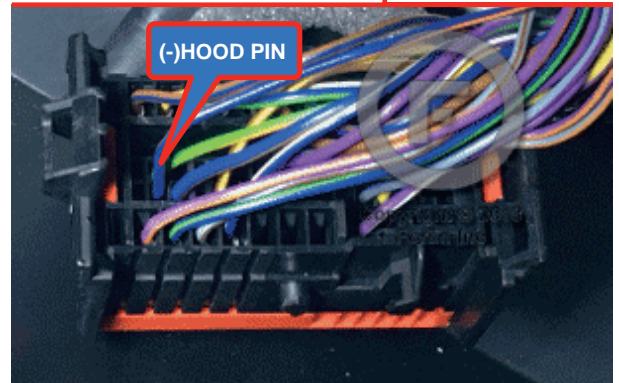
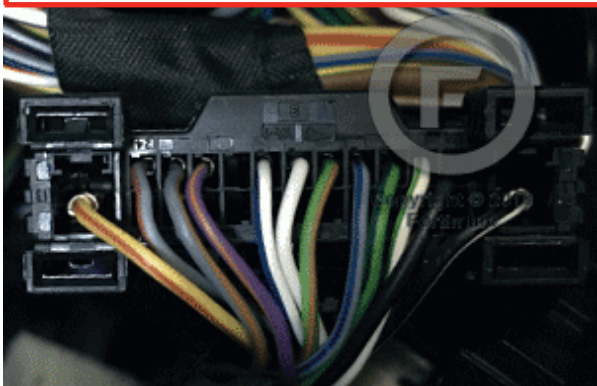

AUTOMATIC TRANSMISSION WIRING CONNECTION

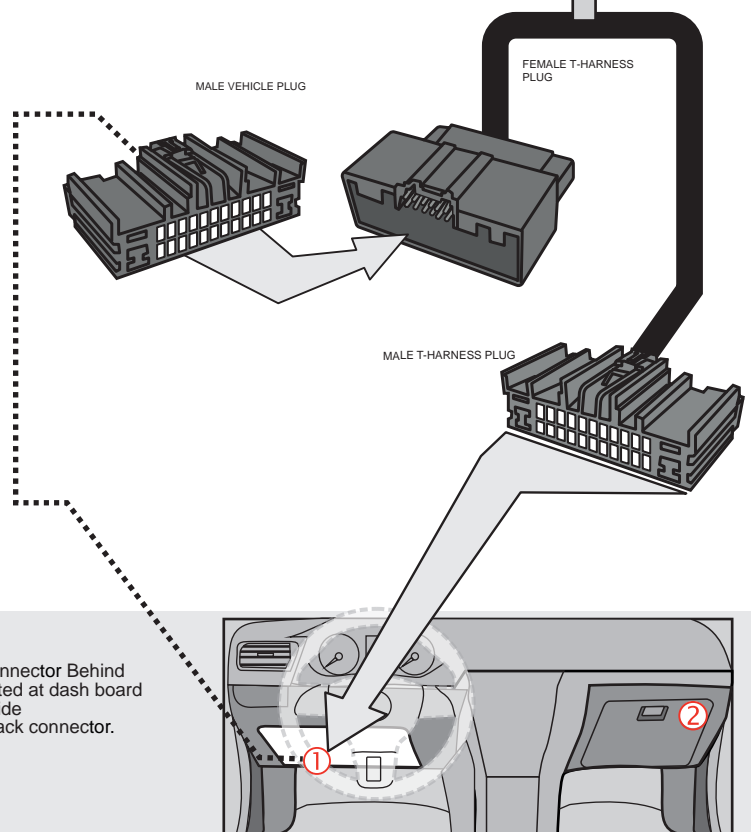
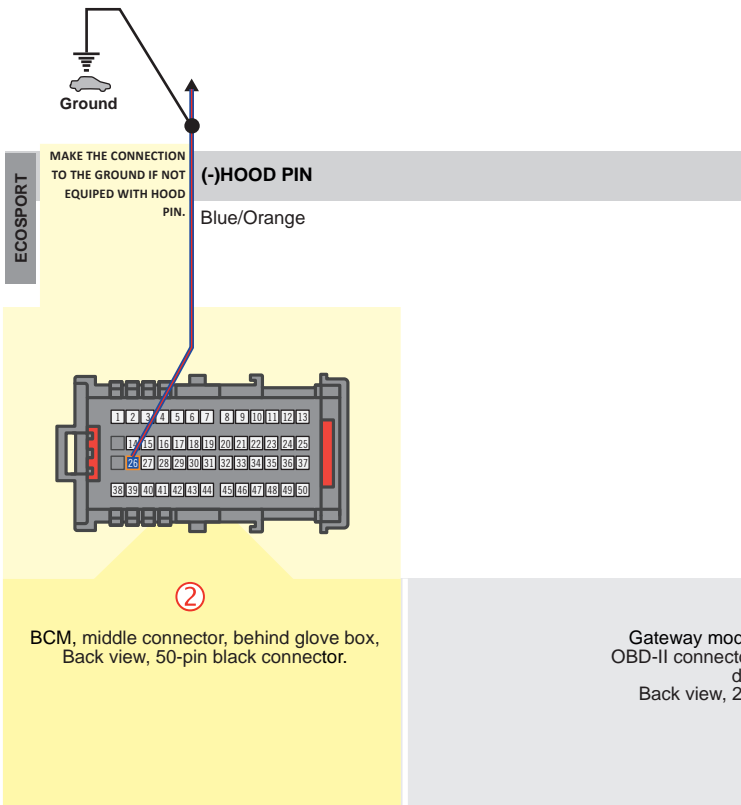
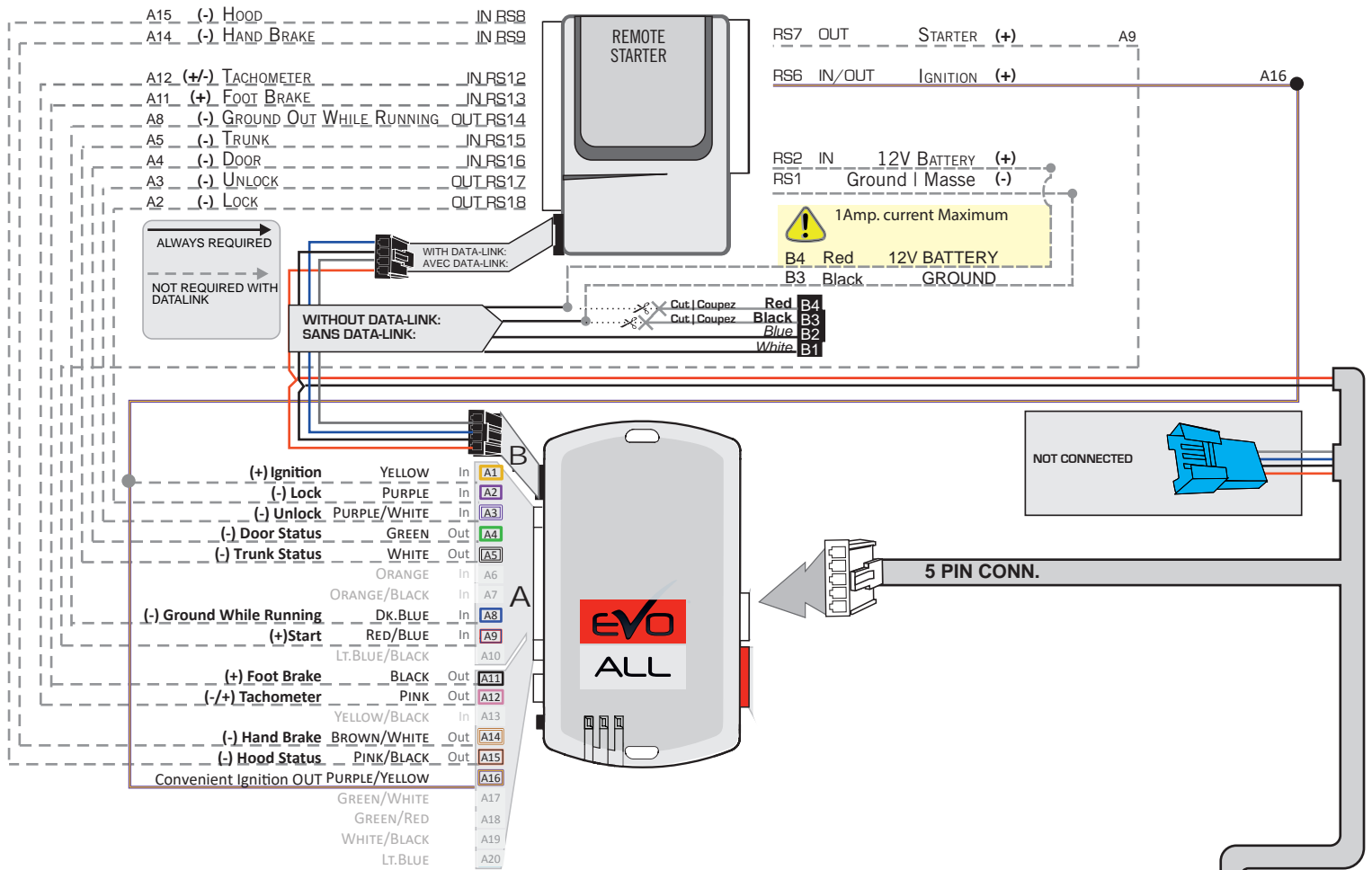

KEY BYPASS PROGRAMMING PROCEDURE 1/2

1

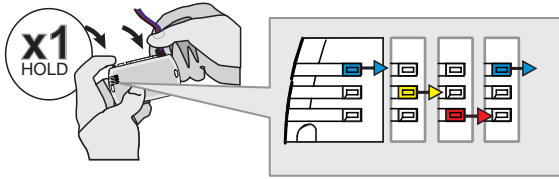

Press and hold the programming button:
Insert the 4-Pin (Data-Link) connector.

↳ The Blue, Red, Yellow and Blue & Red LEDs will alternatively illuminate.

2

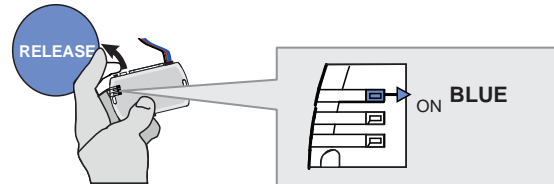

Release the programming button when the LED is BLUE.

If the LED is not solid BLUE disconnect the 4-Pin connector (Data-Link) and go back to step 1.

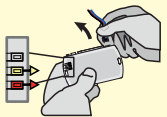

3

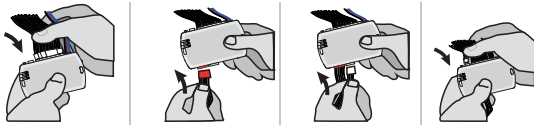

Insert the required remaining connectors.

4

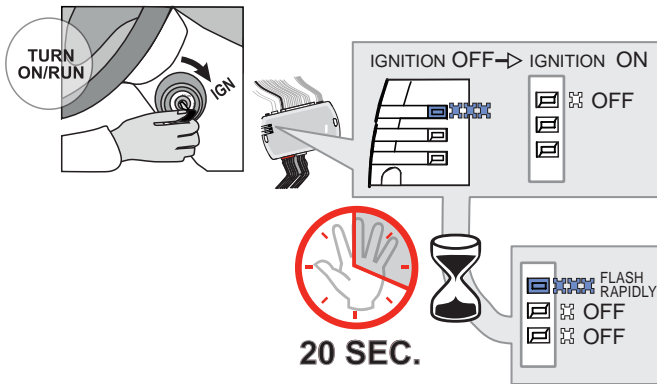

Turn the key to the Ignition ON/RUN position.

↳ The BLUE LED will turn OFF.

↳ The BLUE LED will flash rapidly.

5

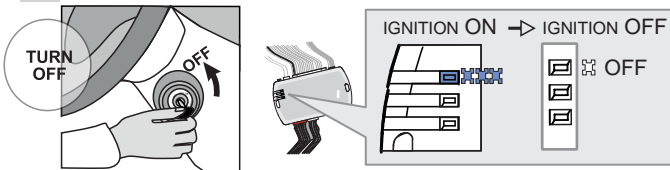

Turn the key to the OFF position.

↳ The BLUE LED will turn off.

6

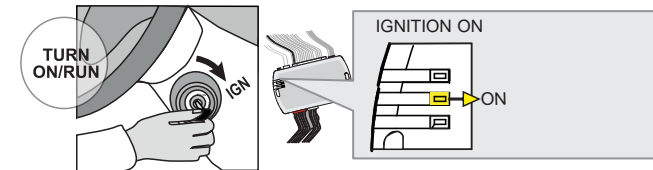

Turn the key to the Ignition ON/RUN position.

↳ The YELLOW LED will turn ON.

7



Wait 5 seconds.

KEY BYPASS PROGRAMMING PROCEDURE 2/2

8

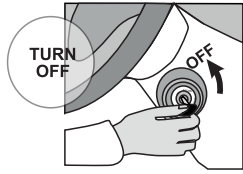

Turn the key to the OFF position.



The module is now programmed.

REMOTE STARTER FUNCTIONALITY



All doors must be closed.



Remote start the vehicle.



Unlock the doors with the remote-starter remote or the OEM remote.

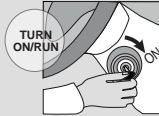

Insert and Turn the key to the Ignition ON/RUN position.



Press the brake pedal.



The vehicle can now be put in to gear and driven.

THAR-FOR3 THARNESSE INSTALLATION

ADDENDUM - SUGGESTED WIRING CONFIGURATION

ONLY COMPATIBLE WITH AUTOMATIC TRANSMISSION VEHICLES.

Vehicle functions supported in this diagram (functional if equipped)

VEHICLE	YEARS	Immobilizer bypass	T-Harness	Lock	Unlock	Arm	Disarm	RAP Disable	Parking Lights	Tachometer	Door Status	Trunk Status	Hood Status*	Hand-Brake Status	Foot-Brake Status	Active OEM Remote Start
FORD EcoSport	<i>Push-to-Start</i> 2018-2020	•	•	•	•	•	•	•	•	•	•	•	•	•	•	•



FIRMWARE VERSION

4.02

ONLY - SEULEMENT

 To add the firmware version and the options, use the **FLASH LINK UPDATER** or **FLASH LINK MOBILE** tool, sold separately.

Program bypass option:
UNIT OPTION
DESCRIPTION
C1

OEM Remote status (Lock/Unlock) monitoring

D6

Push-to-Start

**IF THE VEHICLE IS NOT EQUIPPED
WITH FUNCTIONAL HOOD PIN:**
A11
OFF

Hood trigger (Output Status).

Parts required (Not included)

1x THAR-FOR3

NOTES

The vehicles OEM remote and SmartKey are still operable during remote start.

MANDATORY INSTALL
***HOOD PIN**

HOOD STATUS: THE HOOD PIN SWITCH MUST BE INSTALLED IF THE VEHICLE CAN BE REMOTE STARTED WITH THE HOOD OPEN, SET FUNCTION **A11** TO OFF.

A11
OFF
Notice: the installation of safety elements are mandatory. The hood pin is an essential security element and must be installed.

THIS MODULE MUST BE INSTALLED BY A QUALIFIED TECHNICIAN. A WRONG CONNECTION CAN CAUSE PERMANENT DAMAGE TO THE VEHICLE.

DESCRIPTION



① Gateway module, Behind OBD-II connector

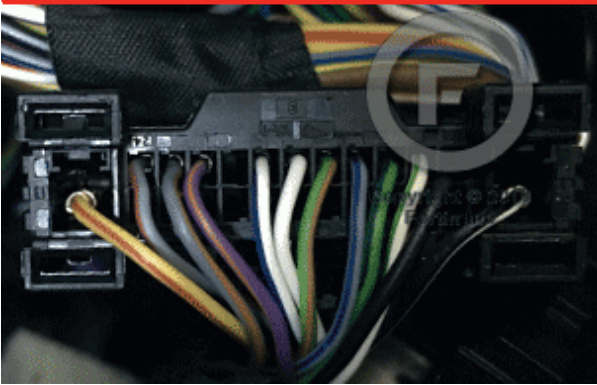

③ Behind glove box

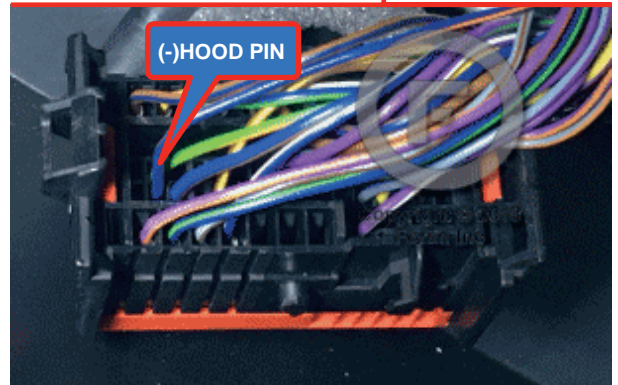
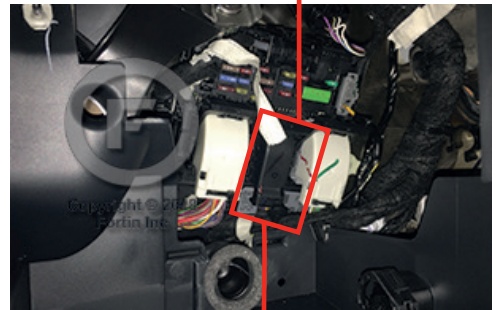
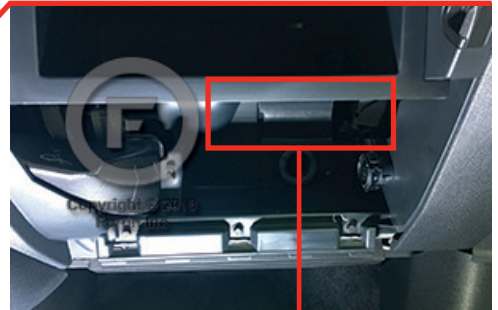

AUTOMATIC TRANSMISSION WIRING CONNECTION

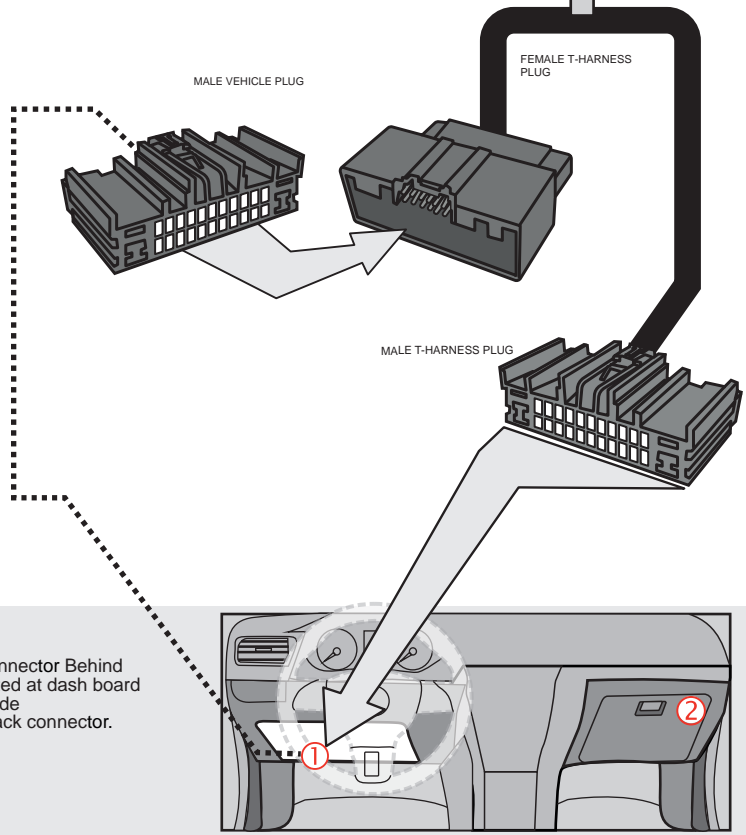
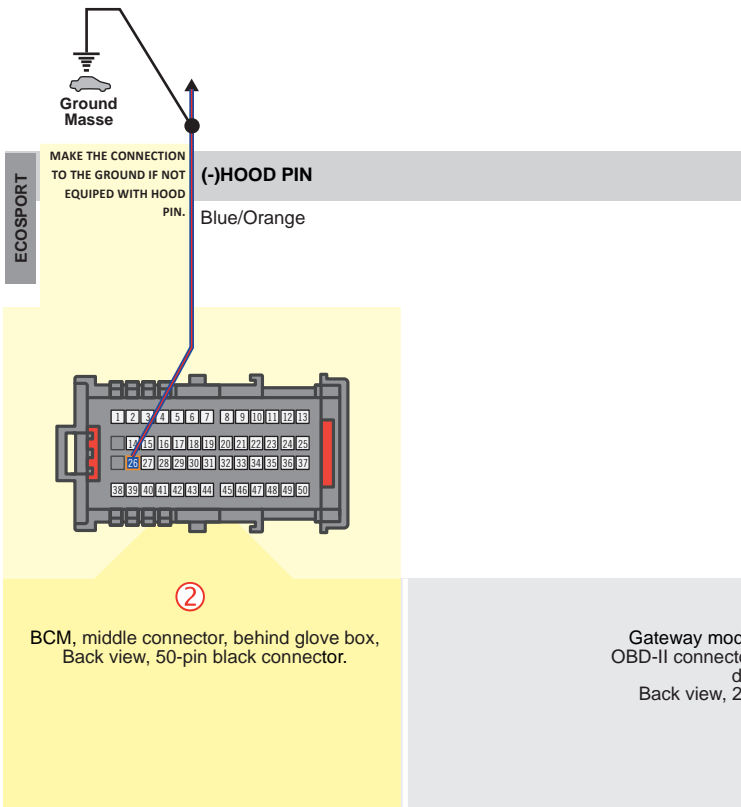
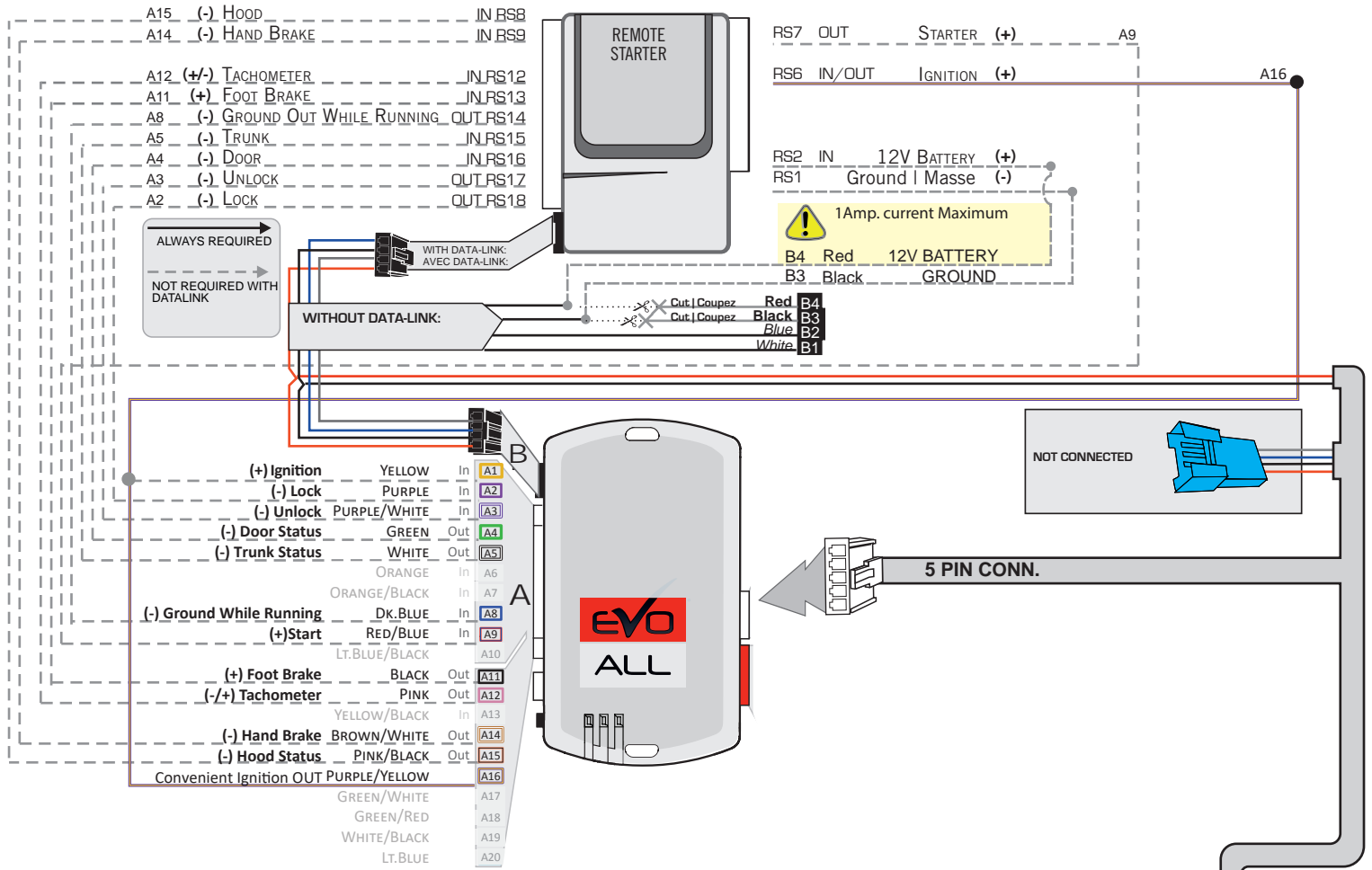

KEY BYPASS PROGRAMMING PROCEDURE 1/2

1

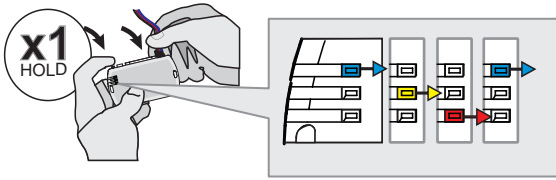

Press and hold the programming button:
Insert the 4-Pin (Data-Link) connector.

↳ The Blue, Red, Yellow and Blue & Red LEDs will alternatively illuminate.

2

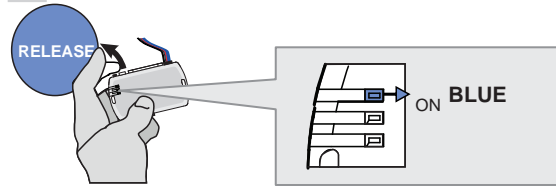

Release the programming button when the LED is BLUE.

If the LED is not solid BLUE disconnect the 4-Pin connector (Data-Link) and go back to step 1.

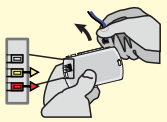

3

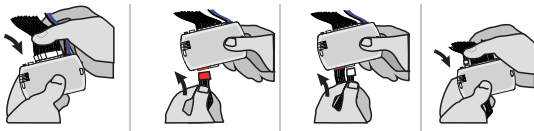

Insert the required remaining connectors.

4

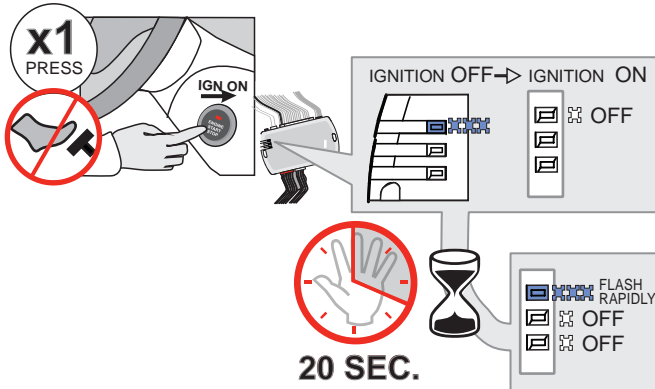

Do not press the brake pedal.
Press the Push-to-Start button once to turn on the ignition.

↳ The BLUE LED will turn OFF.

↳ The BLUE LED will flash rapidly.

5

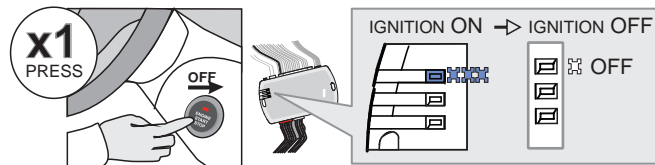

Press the Push-to-Start button once to turn off the ignition.

↳ The BLUE LED will turn off.

6

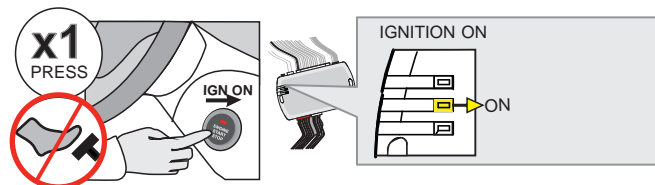

Do not press the brake pedal.
Press the Push-to-Start button once to turn on the ignition.

↳ The YELLOW LED will turn ON.

KEY BYPASS PROGRAMMING PROCEDURE 2/2

7



Wait 5 seconds.



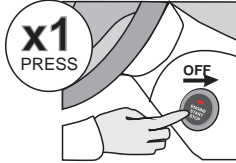

8

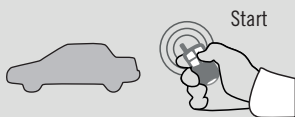

Press the Push-to-Start button once to turn off the ignition.

The module is now programmed.

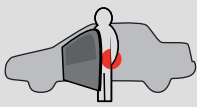
REMOTE STARTER FUNCTIONALITY

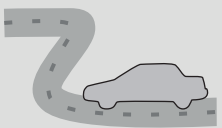
 <p>Start</p> <p>All doors must be closed.</p> <p>Remote start the vehicle.</p>	 <p>UNLOCK</p> <p>Unlock the doors with either:</p> <ul style="list-style-type: none"> • The OEM remote • The remote-starter remote • Or the proximity remote 	 <p>Enter the vehicle with the SMART-KEY.</p>	 <p>DO NOT PRESS THE BRAKE PEDAL.</p> <p>Press and release the Push-to-Start button once.</p>	 <p>Press the brake pedal. The vehicle can now be put in to gear and driven.</p> <p>If the Smart-Key is not detected the vehicle will shut down.</p>
--	---	--	---	---

THAR-FOR3 THARNNESS INSTALLATION

ADDENDUM - SUGGESTED WIRING CONFIGURATION

ONLY COMPATIBLE WITH AUTOMATIC TRANSMISSION VEHICLES.

Vehicle functions supported in this diagram (functional if equipped)

VEHICLE	YEARS	Immobilizer bypass	Lock	Unlock	Arm	Disarm	RAP Disable	Parking Lights	Tachometer	Heated seats	Heated Mirrors	Rear defrost	Door Status	Trunk Status	Hood Status*	Hand-Brake Status	Foot-Brake Status	Active OEM Remote Start	
FORD																			
Edge	Push-to-Start 2015-2019	•	•	•	•	•	•	•	•	•	•	•	•	•	•	•	•	•	•
LINCOLN																			
MKX	Push-to-Start 2017	•	•	•	•	•	•	•	•	•	•	•	•	•	•	•	•	•	•



FIRMWARE VERSION

4.01

ONLY - SEULEMENT

 To add the firmware version and the options, use the **FLASH LINK UPDATER** or **FLASH LINK MOBILE** tool, sold separately.

Program bypass option:

UNIT OPTION

DESCRIPTION

C1

OEM Remote status (Lock/Unlock) monitoring

D6

Push-to-Start

IF THE VEHICLE IS NOT EQUIPPED WITH FUNCTIONAL HOOD PIN:
A11
OFF

Hood trigger (Output Status).

Parts required (Not included)

1x THAR-FOR3

MANDATORY INSTALL
***HOOD PIN**

HOOD STATUS: THE HOOD PIN SWITCH MUST BE INSTALLED IF THE VEHICLE CAN BE REMOTE STARTED WITH THE HOOD OPEN, SET FUNCTION **A11** TO OFF.

A11
OFF
Notice: the installation of safety elements are mandatory. The hood pin is an essential security element and must be installed.

THIS MODULE MUST BE INSTALLED BY A QUALIFIED TECHNICIAN. A WRONG CONNECTION CAN CAUSE PERMANENT DAMAGE TO THE VEHICLE.

DESCRIPTION



② Parking Lights switch

① Gateway module, located at right of steering column.

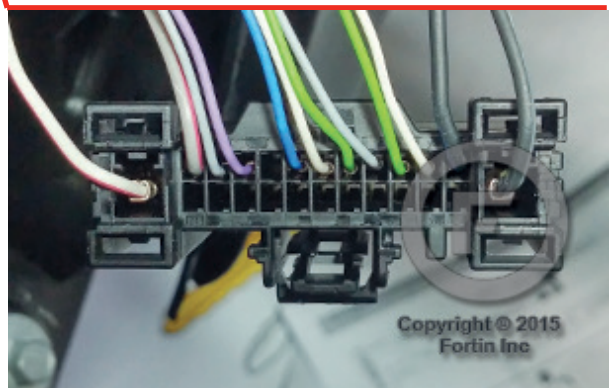
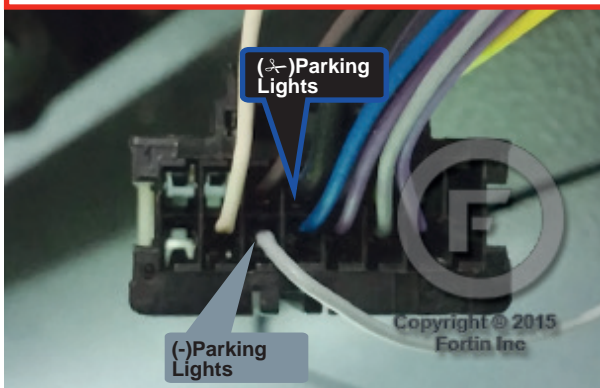

AUTOMATIC TRANSMISSION WIRING CONNECTION

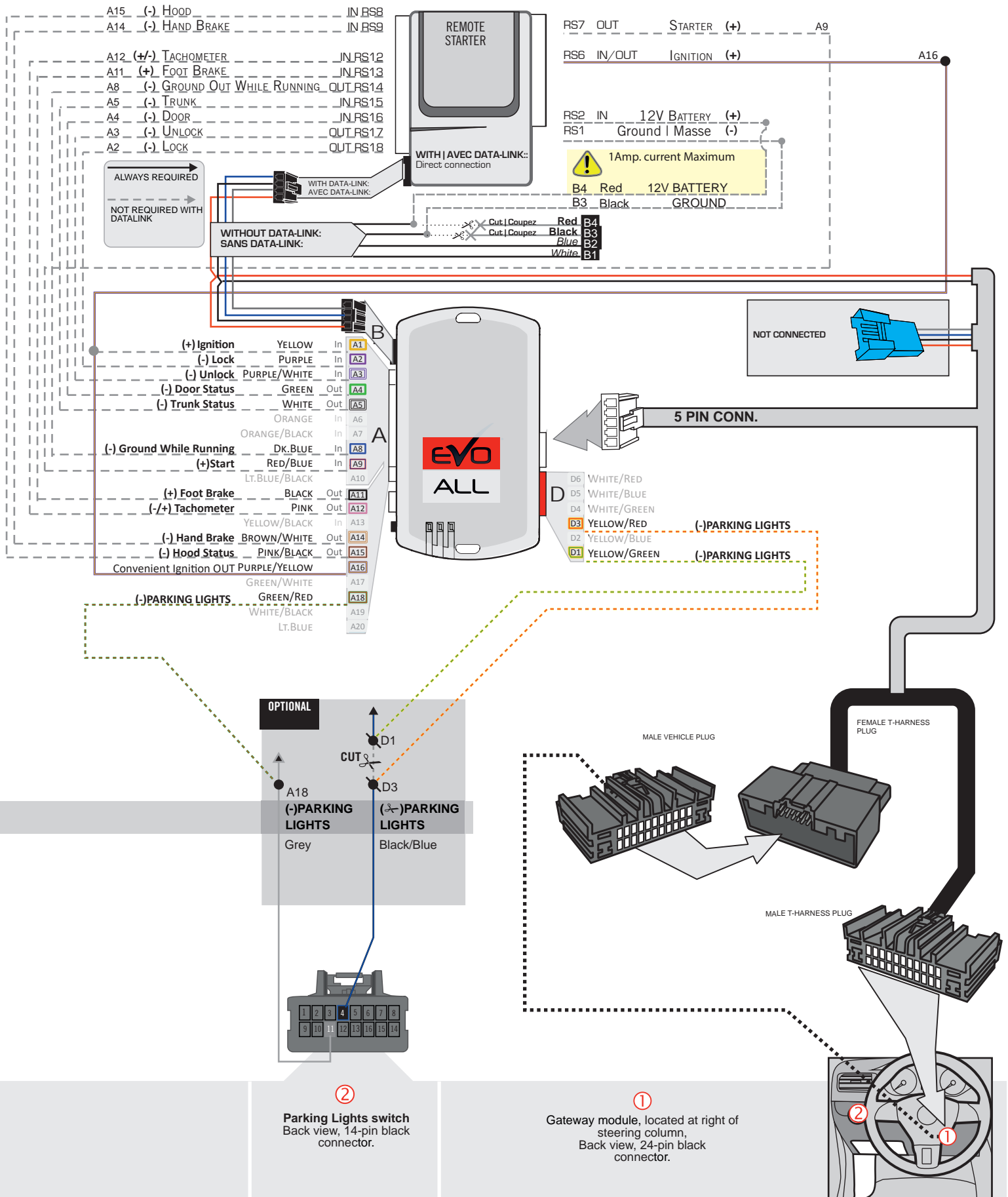

PROGRAMMING PROCEDURE

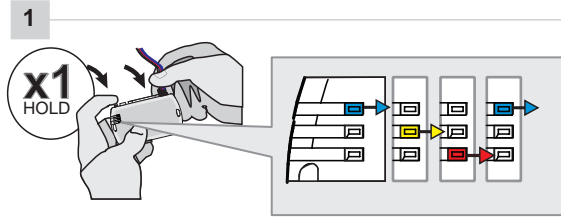

Press and hold the programming button:
Insert the 4-Pin (Data-Link) connector.

↳ The Blue, Red, Yellow and Blue & Red LEDs will alternatively illuminate.

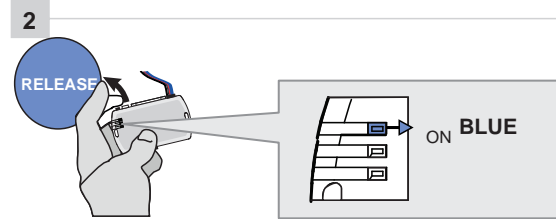

Release the programming button when the LED is BLUE.

If the LED is not solid BLUE disconnect the 4-Pin connector (Data-Link) and go back to step 1.

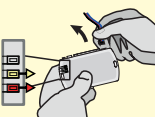
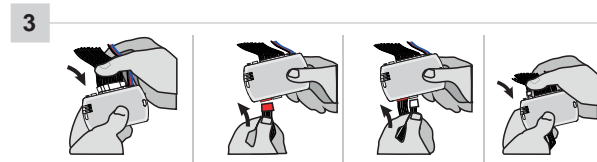

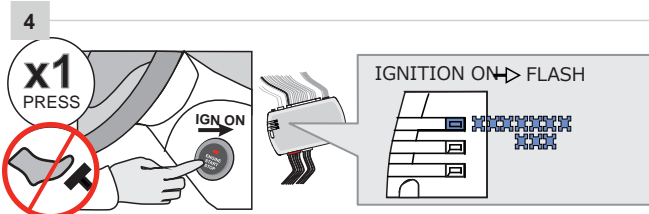

Insert the required remaining connectors.

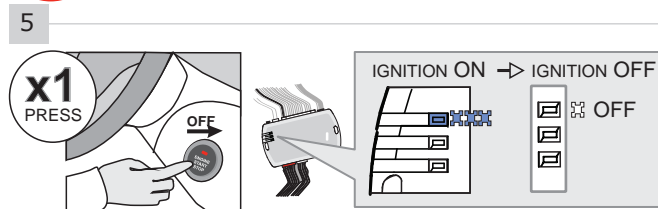

Do not press the brake pedal.
Press the Push-to-Start button once to turn on the ignition.

↳ The BLUE LED will flash rapidly.



Press the Push-to-Start button once to turn off the ignition.

↳ The BLUE LED will turn off.

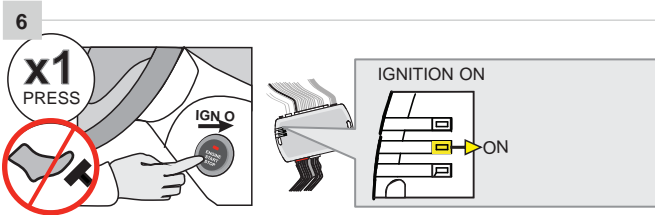

Do not press the brake pedal.
Press the Push-to-Start button once to turn on the ignition.

↳ The YELLOW LED will turn ON.



Wait 5 seconds.

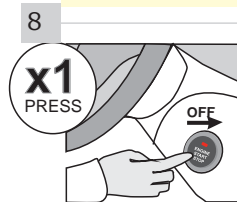





Press the Push-to-Start button once to turn off the ignition.

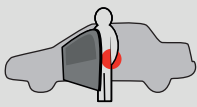

The module is now programmed.

REMOTE STARTER FUNCTIONALITY

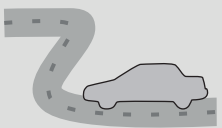
 <p>Start</p> <p>All doors must be closed.</p> <p>Remote start the vehicle.</p>	 <p>UNLOCK</p> <p>Unlock the doors with either:</p> <ul style="list-style-type: none"> • The OEM remote • The remote-starter remote • Or the proximity remote 	 <p>Enter the vehicle with the SMART-KEY.</p>	 <p>DO NOT PRESS THE BRAKE PEDAL.</p> <p>Press and release the Push-to-Start button once.</p>	 <p>Press the brake pedal. The vehicle can now be put in to gear and driven.</p> <p>If the Smart-Key is not detected the vehicle will shut down.</p>
--	---	--	---	---

THAR-FOR3 THARNESSE INSTALLATION

ADDENDUM - SUGGESTED WIRING CONFIGURATION

ONLY COMPATIBLE WITH AUTOMATIC TRANSMISSION VEHICLES.

Vehicle functions supported in this diagram (functional if equipped)

VEHICLE
YEARS

Immobilizer bypass	Lock	Unlock	Arm	Disarm	RAP Disable	Parking Lights	Tachometer	Heated seats	Heated Mirrors	Rear defrost	Door Status	Trunk Status	Hood Status*	Hand-Brake Status	Foot-Brake Status	Active OEM Remote Start
--------------------	------	--------	-----	--------	-------------	----------------	------------	--------------	----------------	--------------	-------------	--------------	--------------	-------------------	-------------------	-------------------------

FORD

Edge	Key 2015-2019	•	•	•	•	•	•	•	•	•	•	•	•	•	•	•
------	---------------	---	---	---	---	---	---	---	---	---	---	---	---	---	---	---

FIRMWARE VERSION
4.01

ONLY - SEULEMENT

 To add the firmware version and the options, use the **FLASH LINK UPDATER** or **FLASH LINK MOBILE** tool, sold separately.

Program bypass option:
UNIT OPTION
DESCRIPTION
C1

OEM Remote status (Lock/Unlock) monitoring

IF THE VEHICLE IS NOT EQUIPPED WITH FUNCTIONAL HOOD PIN:
A11
OFF

Hood trigger (Output Status).

Parts required (Not included)

1x THAR-FOR3



The vehicle must be equipped with the OEM remote with the door locks.

MANDATORY INSTALL
***HOOD PIN**

HOOD STATUS: THE HOOD PIN SWITCH MUST BE INSTALLED IF THE VEHICLE CAN BE REMOTE STARTED WITH THE HOOD OPEN, SET FUNCTION **A11** TO OFF.

A11
OFF
Notice: the installation of safety elements are mandatory. The hood pin is an essential security element and must be installed.

THIS MODULE MUST BE INSTALLED BY A QUALIFIED TECHNICIAN. A WRONG CONNECTION CAN CAUSE PERMANENT DAMAGE TO THE VEHICLE.

DESCRIPTION



② Parking Lights switch

① Gateway module, located at right of steering column.

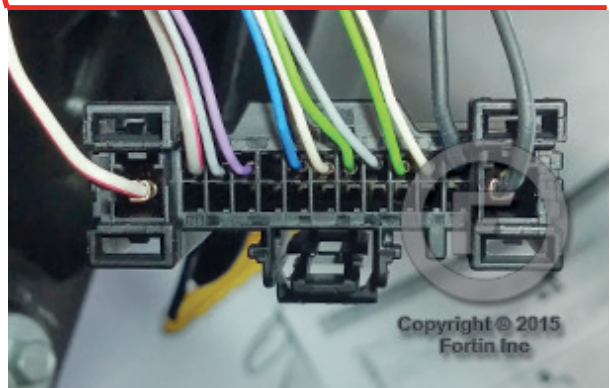
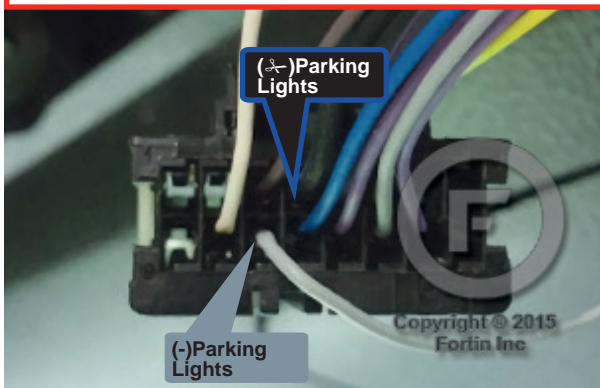

AUTOMATIC TRANSMISSION WIRING CONNECTION

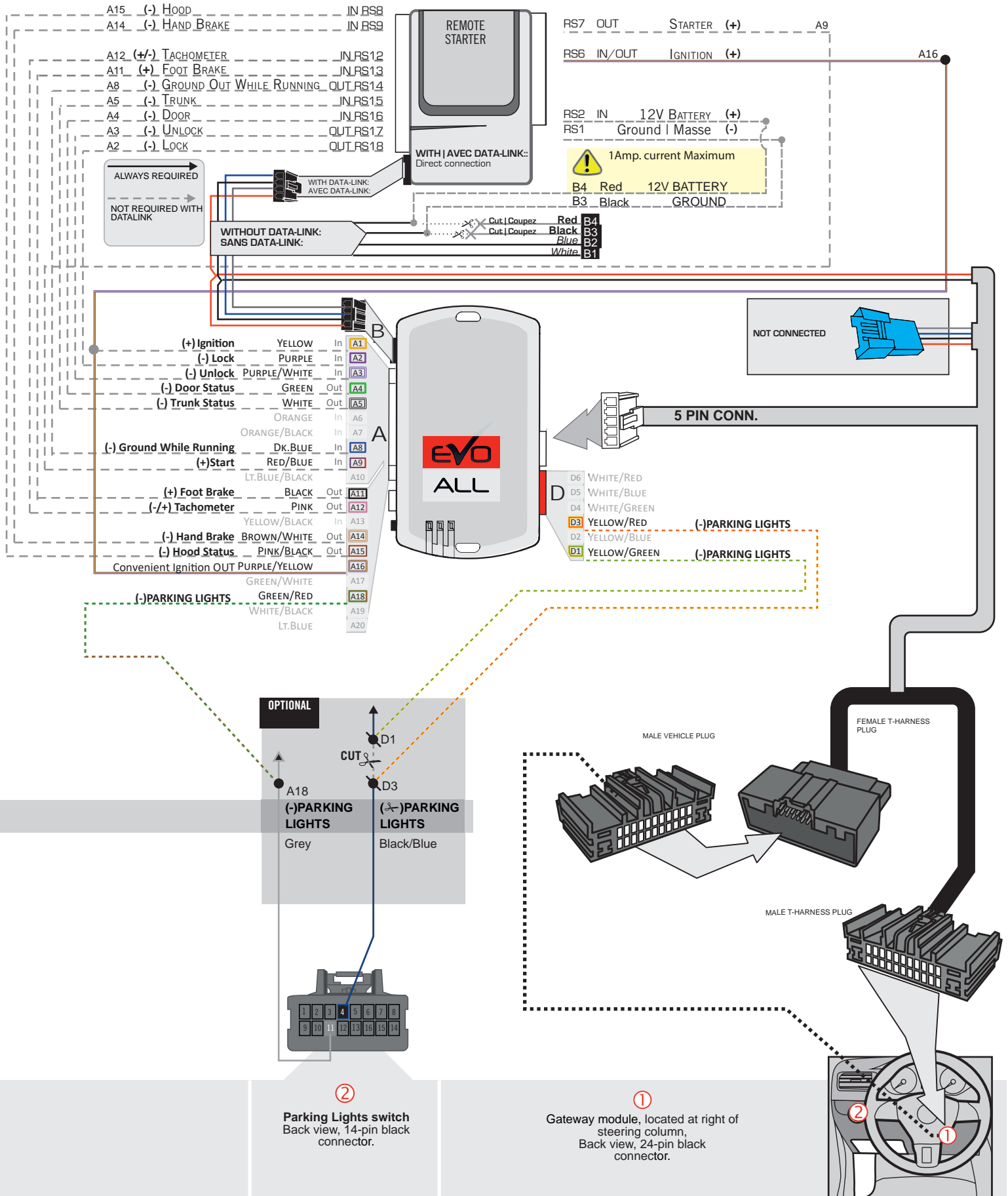

PROGRAMMING PROCEDURE

1

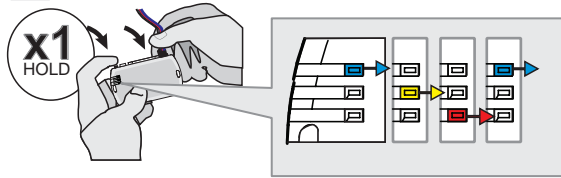

Press and hold the programming button:
Insert the 4-Pin (Data-Link) connector.

↳ The Blue, Red, Yellow and Blue & Red LEDs will alternatively illuminate.

2

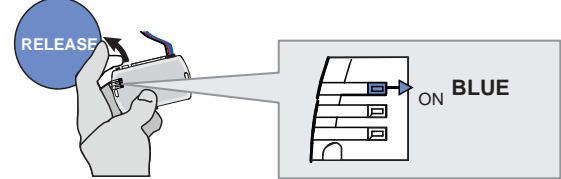

Release the programming button when the LED is BLUE.

If the LED is not solid BLUE disconnect the 4-Pin connector (Data-Link) and go back to step 1.



3

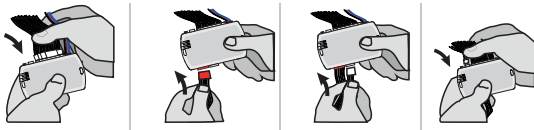

Insert the required remaining connectors.

4

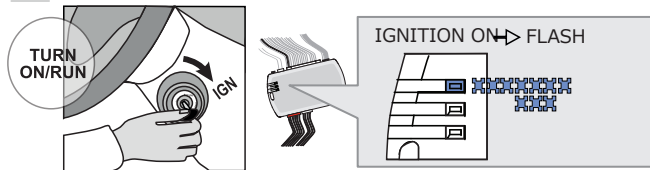

Turn the key to the Ignition ON/RUN position.

↳ The BLUE LED will flash rapidly.

5

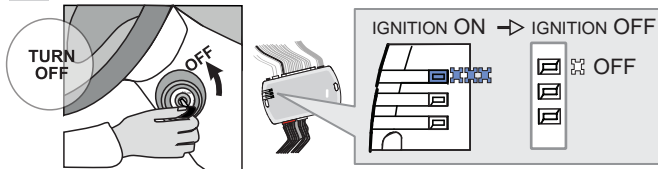

Turn the key to the OFF position.

↳ The BLUE LED will turn off.

6

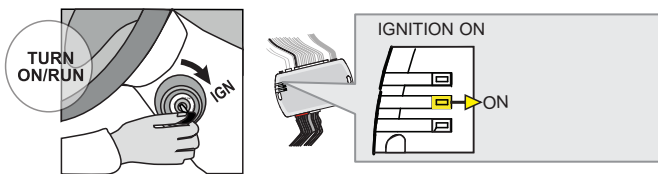

Turn the key to the Ignition ON/RUN position.

↳ The YELLOW LED will turn ON.

7



Wait 5 seconds.

8

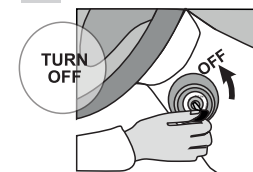

Turn the key to the OFF position.



The module is now programmed.

REMOTE STARTER FUNCTIONALITY



All doors must be closed.



Remote start the vehicle.



Unlock the doors with the remote-starter remote or the OEM remote.

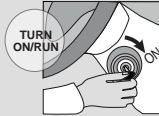

Insert and Turn the key to the Ignition ON/RUN position.



Press the brake pedal.



The vehicle can now be put in to gear and driven.

**THAR-FOR3 THARNESSE
INSTALLATION**

ADDENDUM - SUGGESTED WIRING CONFIGURATION



ONLY COMPATIBLE WITH AUTOMATIC TRANSMISSION VEHICLES.



Vehicle functions supported in this diagram (functional if equipped)

VEHICLE	YEARS	Immobilizer bypass	Lock	Unlock	Arm	Disarm	RAP Disable	Parking Lights	Tachometer	Heated seats	Heated Mirrors	Rear defrost	Door Status	Trunk Status	Hood Status*	Hand-Brake Status	Foot-Brake Status	Active OEM Remote Start
FORD																		
Explorer	Key 2016-2019	•	•	•	•	•	•	•	•	•	•	•	•	•	•	•	•	•

FIRMWARE VERSION

4.01

ONLY - SEULEMENT

To add the firmware version and the options, use the **FLASH LINK UPDATER** or **FLASH LINK MOBILE** tool, sold separately.

	Program bypass option:	UNIT OPTION	DESCRIPTION
		C1	OEM Remote status (Lock/Unlock) monitoring

IF THE VEHICLE IS NOT EQUIPPED WITH FUNCTIONAL HOOD PIN:	A11	OFF	Hood trigger (Output Status).
---	------------	-----	-------------------------------



Parts required (Not included)

1x THAR-FOR3

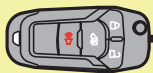

The vehicle must be equipped with the OEM remote with the door locks.

MANDATORY INSTALL

*HOOD PIN



HOOD STATUS: THE HOOD PIN SWITCH MUST BE INSTALLED IF THE VEHICLE CAN BE REMOTE STARTED WITH THE HOOD OPEN, SET FUNCTION **A11** TO OFF.

A11

OFF

Notice: the installation of safety elements are mandatory. The hood pin is an essential security element and must be installed.

THIS MODULE MUST BE INSTALLED BY A QUALIFIED TECHNICIAN. A WRONG CONNECTION CAN CAUSE PERMANENT DAMAGE TO THE VEHICLE.

DESCRIPTION

② Parking Lights switch

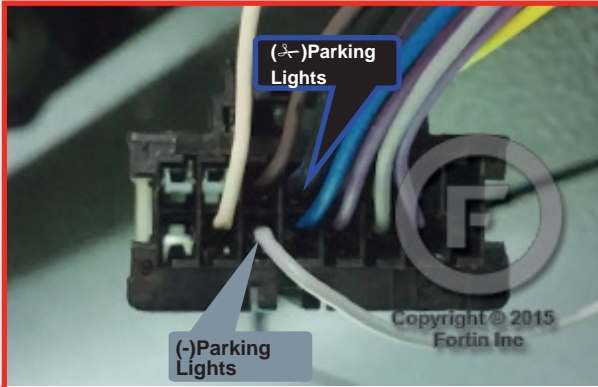

③ Fuse box

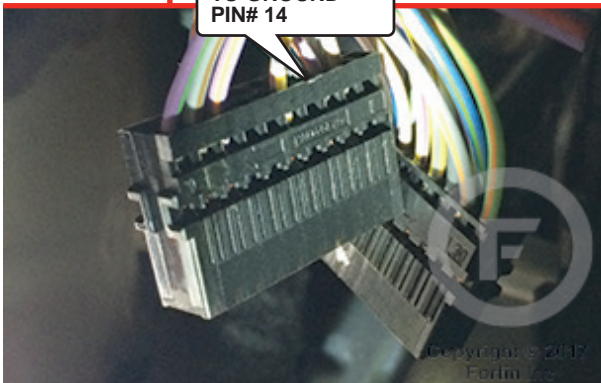
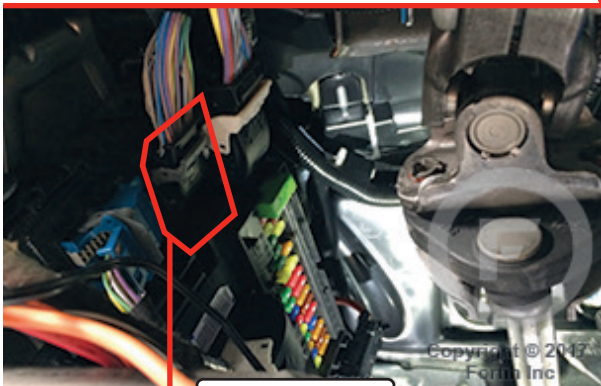

AUTOMATIC TRANSMISSION WIRING CONNECTION

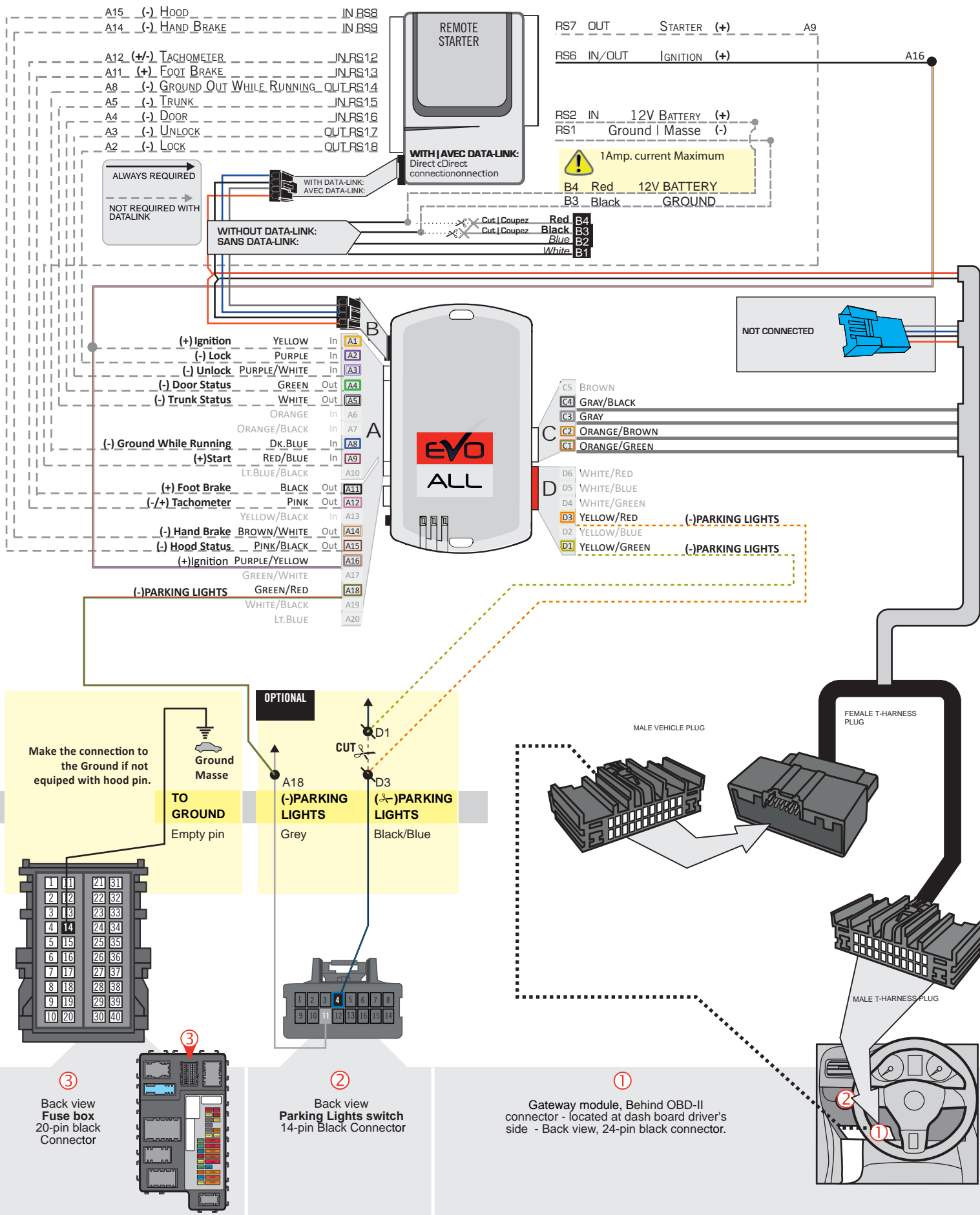

PROGRAMMING PROCEDURE

1

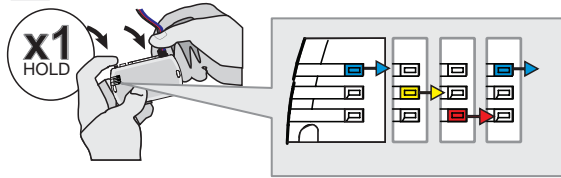

Press and hold the programming button:
Insert the 4-Pin (Data-Link) connector.

↳ The Blue, Red, Yellow and Blue & Red LEDs will alternatively illuminate.

2

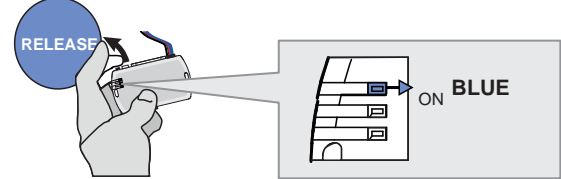

Release the programming button when the LED is BLUE.

If the LED is not solid BLUE disconnect the 4-Pin connector (Data-Link) and go back to step 1.

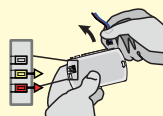

3

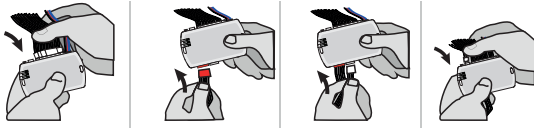

Insert the required remaining connectors.

4

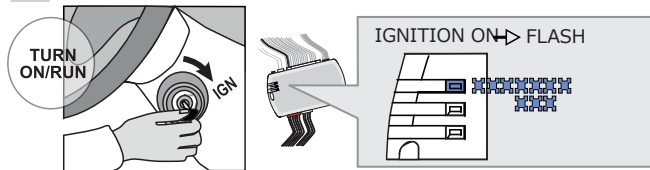

Turn the key to the Ignition ON/RUN position.

↳ The BLUE LED will flash rapidly.

5

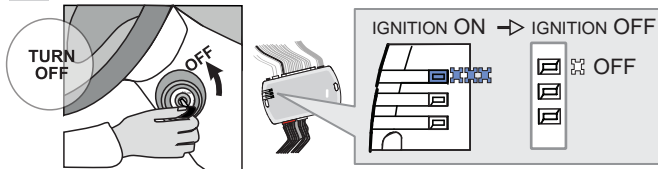

Turn the key to the OFF position.

↳ The BLUE LED will turn off.

6

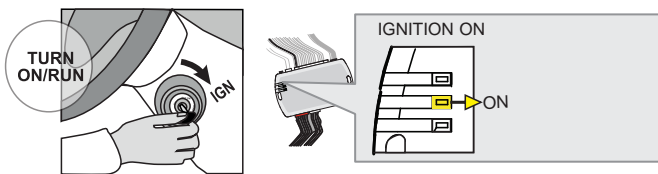

Turn the key to the Ignition ON/RUN position.

↳ The YELLOW LED will turn ON.

7



Wait 5 seconds.

8

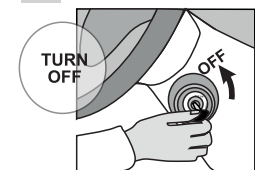

Turn the key to the OFF position.



The module is now programmed.

REMOTE STARTER FUNCTIONALITY



All doors must be closed.



Remote start the vehicle.



Unlock the doors with the remote-starter remote or the OEM remote.



Insert and Turn the key to the Ignition ON/RUN position.



Press the brake pedal.



The vehicle can now be put in to gear and driven.

**THAR-FOR3 THARNESSE
INSTALLATION**

ADDENDUM - SUGGESTED WIRING CONFIGURATION



ONLY COMPATIBLE WITH AUTOMATIC TRANSMISSION VEHICLES.



Vehicle functions supported in this diagram (functional if equipped)

VEHICLE

YEARS

Immobilizer bypass

Lock

Unlock

Arm

Disarm

RAP Disable

Tachometer

Heated seats

Heated Mirrors

Rear defrost

Door Status

Trunk Status

Hood Status*

Hand-Brake Status

Foot-Brake Status

Active OEM Remote Start

FORD

Explorer

Push-to-Start 2016-2019

•	•	•	•	•	•	•	•	•	•	•	•	•	•	•	•	•	•	•	•
---	---	---	---	---	---	---	---	---	---	---	---	---	---	---	---	---	---	---	---



FIRMWARE VERSION

4.01

ONLY - SEULEMENT

To add the firmware version and the options, use the **FLASH LINK UPDATER** or **FLASH LINK MOBILE** tool, sold separately.



Program bypass option:

UNIT OPTION

DESCRIPTION

C1

OEM Remote status (Lock/Unlock) monitoring

D6

Push-to-Start

IF THE VEHICLE IS NOT EQUIPPED WITH FUNCTIONAL HOOD PIN:

A11

OFF

Hood trigger (Output Status).



Parts required (Not included)

1x THAR-FOR3

MANDATORY INSTALL

*HOOD PIN



HOOD STATUS: THE HOOD PIN SWITCH MUST BE INSTALLED IF THE VEHICLE CAN BE REMOTE STARTED WITH THE HOOD OPEN, SET FUNCTION **A11** TO OFF.

A11

OFF

Notice: the installation of safety elements are mandatory. The hood pin is an essential security element and must be installed.

THIS MODULE MUST BE INSTALLED BY A QUALIFIED TECHNICIAN. A WRONG CONNECTION CAN CAUSE PERMANENT DAMAGE TO THE VEHICLE.

DESCRIPTION

① Gateway module left side of dash

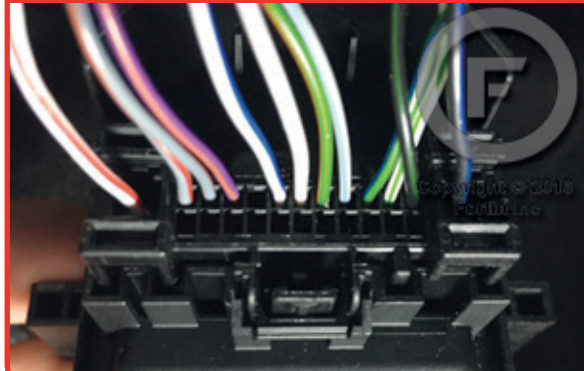

② Parking Lights switch

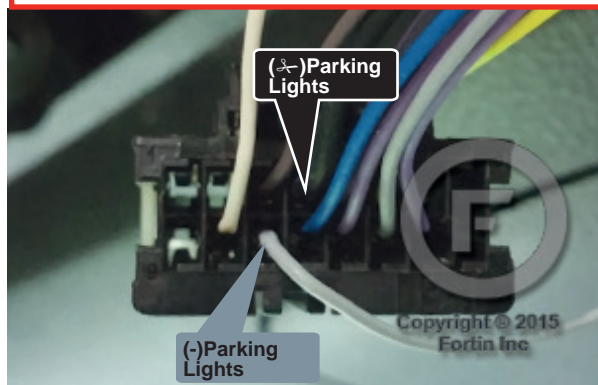

AUTOMATIC TRANSMISSION WIRING CONNECTION

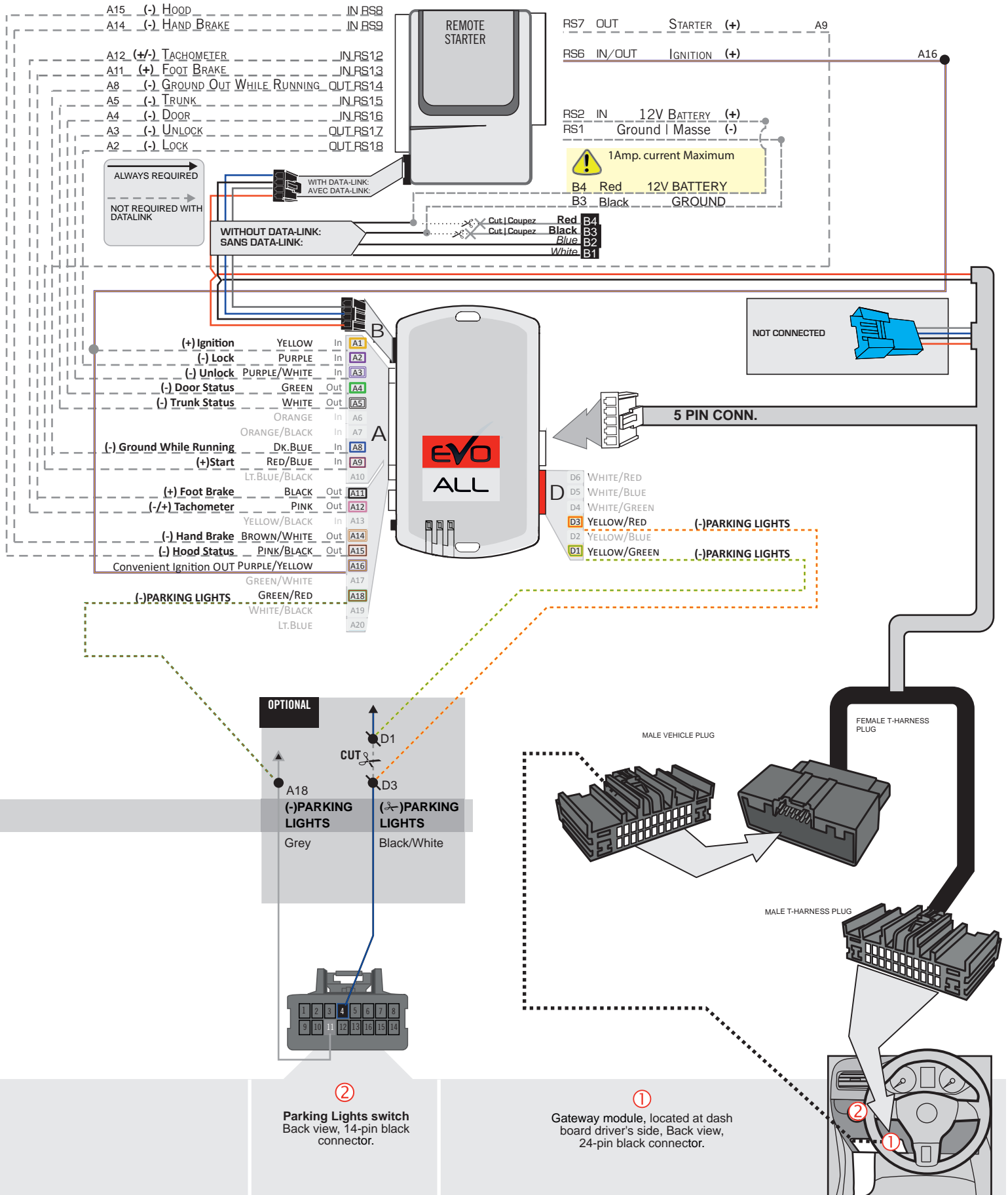

PROGRAMMING PROCEDURE

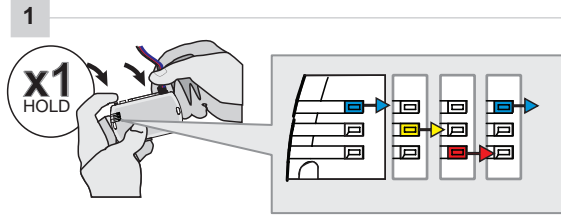

Press and hold the programming button:
Insert the 4-Pin (Data-Link) connector.

↳ The Blue, Red, Yellow and Blue & Red LEDs will alternatively illuminate.

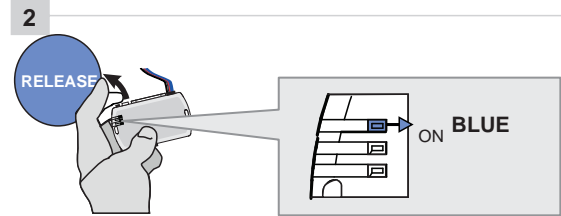

Release the programming button when the LED is BLUE.

If the LED is not solid BLUE disconnect the 4-Pin connector (Data-Link) and go back to step 1.

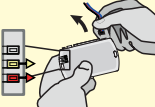
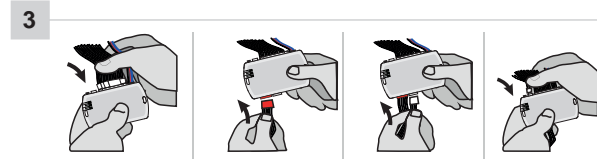

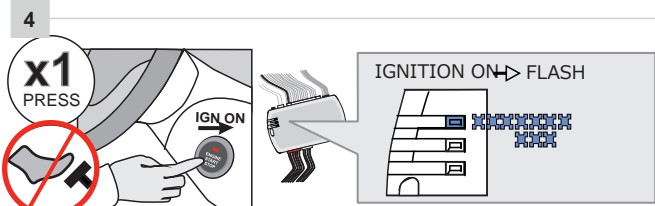

Insert the required remaining connectors.

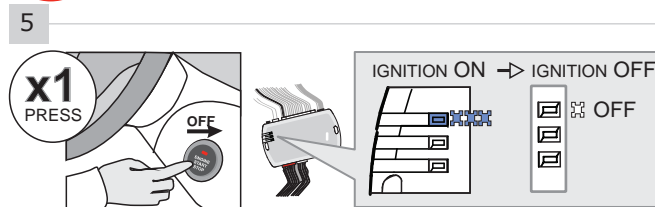

Do not press the brake pedal.
Press the Push-to-Start button once to turn on the ignition.

↳ The BLUE LED will flash rapidly.



Press the Push-to-Start button once to turn off the ignition.

↳ The BLUE LED will turn off.

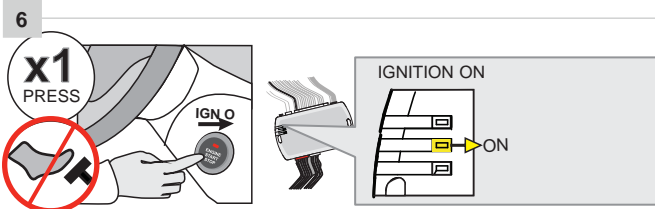

Do not press the brake pedal.
Press the Push-to-Start button once to turn on the ignition.



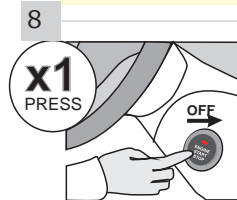
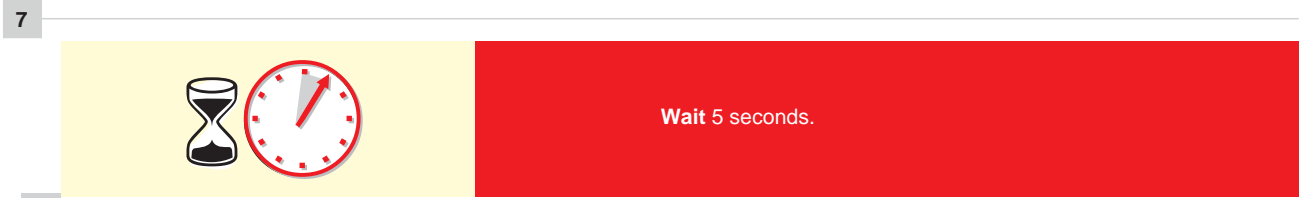

↳ The YELLOW LED will turn ON.

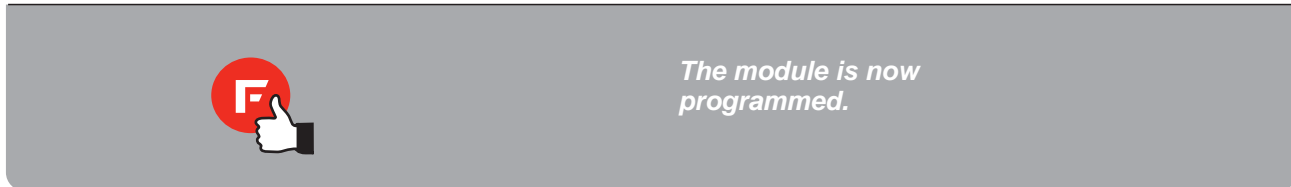

Press the Push-to-Start button once to turn off the ignition.

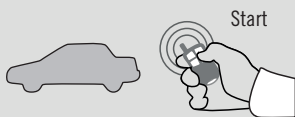

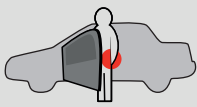
REMOTE STARTER FUNCTIONALITY

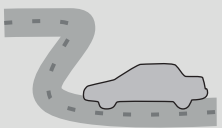
 <p>Start</p> <p>All doors must be closed.</p> <p>Remote start the vehicle.</p>	 <p>UNLOCK</p> <p>Unlock the doors with either:</p> <ul style="list-style-type: none"> • The OEM remote • The remote-starter remote • Or the proximity remote 	 <p>Enter the vehicle with the SMART-KEY.</p>	 <p>DO NOT PRESS THE BRAKE PEDAL.</p> <p>Press and release the Push-to-Start button once.</p>	 <p>Press the brake pedal. The vehicle can now be put in to gear and driven.</p> <p>If the Smart-Key is not detected the vehicle will shut down.</p>
--	---	--	---	---

THAR-FOR3 THARNNESS INSTALLATION

ADDENDUM - SUGGESTED WIRING CONFIGURATION



ONLY COMPATIBLE WITH AUTOMATIC TRANSMISSION VEHICLES.



Vehicle functions supported in this diagram (functional if equipped)

VEHICLE	YEARS	Immobilizer bypass	Lock	Unlock	Arm	Disarm	RAP Disable	Parking Lights	Tachometer	Heated seats	Heated Mirrors	Rear defrost	Door Status	Trunk Status	Hood Status*	Hand-Brake Status	Foot-Brake Status	Active OEM Remote Start	
FORD																			
F-150	Push-to-Start 2015-2018	•	•	•	•	•	•	•	•	•	•	•	•	•	•	•	•	•	•
F-250	Push-to-Start 2017	•	•	•	•	•	•	•	•	•	•	•	•	•	•	•	•	•	•
F-350	Push-to-Start 2017	•	•	•	•	•	•	•	•	•	•	•	•	•	•	•	•	•	•
F-450	Push-to-Start 2017	•	•	•	•	•	•	•	•	•	•	•	•	•	•	•	•	•	•
LINCOLN																			
MKC	Push-to-Start 2015-2019	•	•	•	•	•	•	•	•	•	•	•	•	•	•	•	•	•	•

FIRMWARE VERSION

4.01

ONLY - SEULEMENT

To add the firmware version and the options, use the **FLASH LINK UPDATER** or **FLASH LINK MOBILE** tool, sold separately.

	Program bypass option	UNIT OPTION	DESCRIPTION
	IF THE VEHICLE IS NOT EQUIPPED WITH FUNCTIONAL HOOD PIN:	A11	OFF
			Hood trigger (Output Status).
	Program bypass option:	C1	
			OEM Remote status (Lock/Unlock) monitoring



Parts required (Not included)

1x THAR-FOR3

MANDATORY INSTALL

*HOOD PIN



HOOD STATUS: THE HOOD PIN SWITCH MUST BE INSTALLED IF THE VEHICLE CAN BE REMOTE STARTED WITH THE HOOD OPEN, SET FUNCTION A11 TO OFF.

A11

OFF

Notice: the installation of safety elements are mandatory. The hood pin is an essential security element and must be installed.

THIS MODULE MUST BE INSTALLED BY A QUALIFIED TECHNICIAN. A WRONG CONNECTION CAN CAUSE PERMANENT DAMAGE TO THE VEHICLE.

DESCRIPTION



② Parking Lights switch

① Gateway module, located at dash board driver's side,

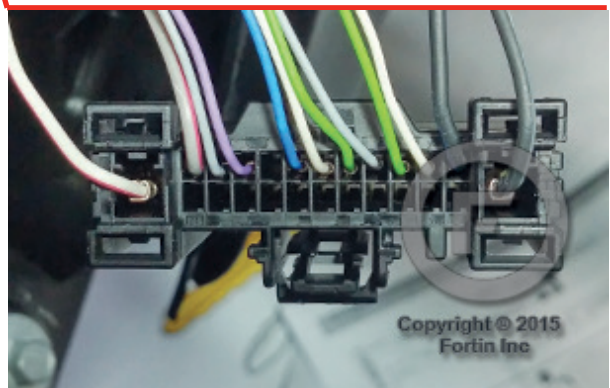
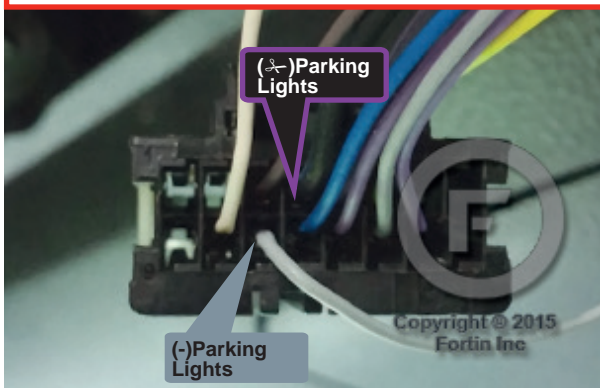

④ Under the hood If not equipped with hood pin.



AUTOMATIC TRANSMISSION WIRING CONNECTION

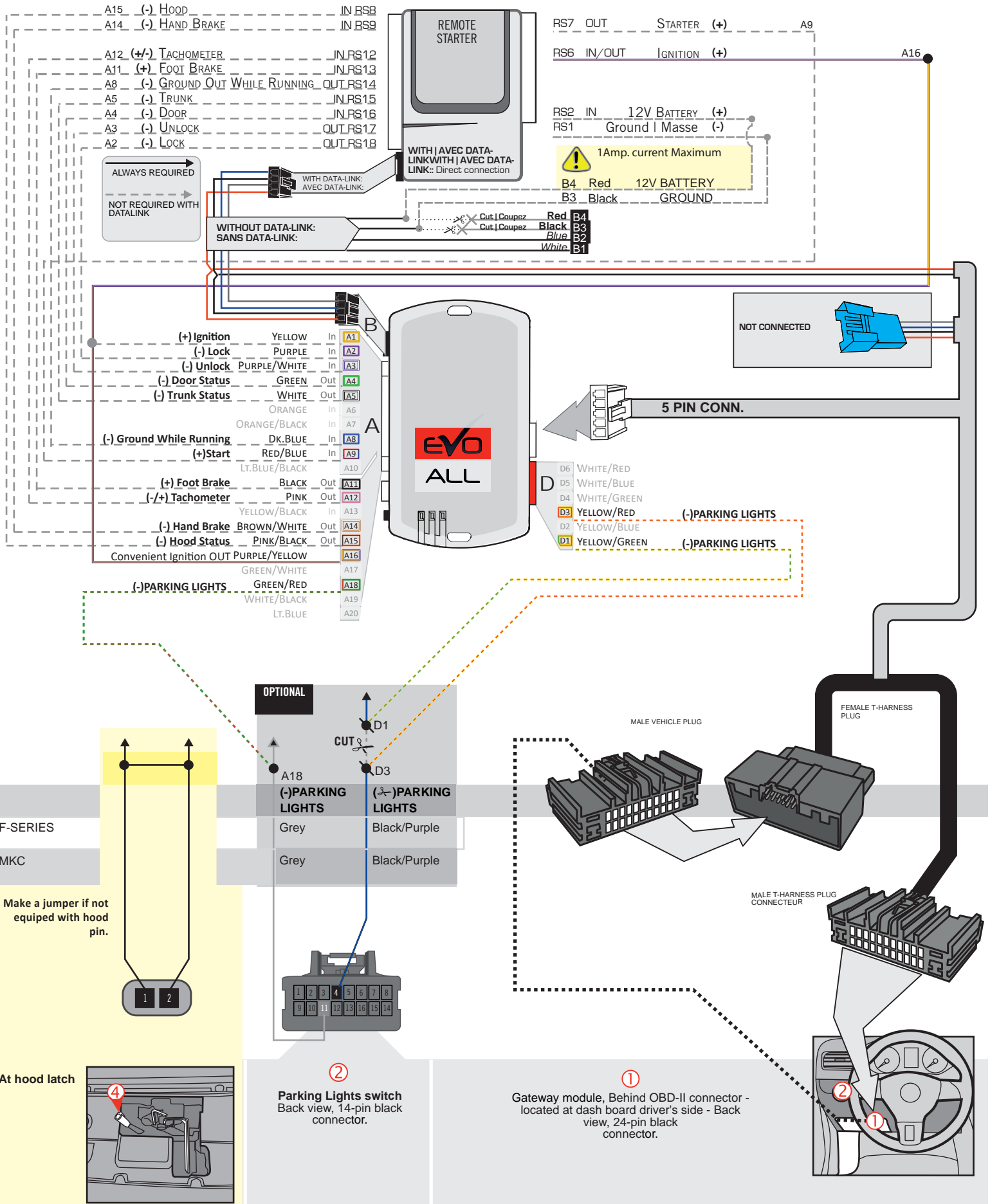

PROGRAMMING PROCEDURE

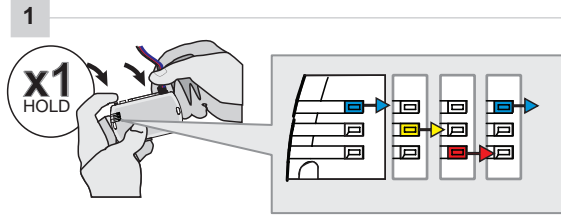

Press and hold the programming button:
Insert the 4-Pin (Data-Link) connector.

↳ The Blue, Red, Yellow and Blue & Red LEDs will alternatively illuminate.

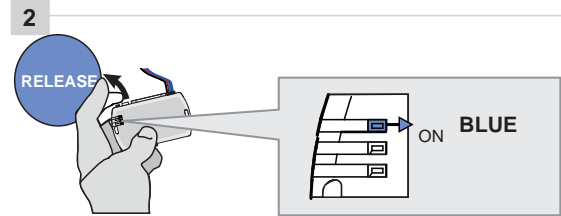

Release the programming button when the LED is BLUE.

If the LED is not solid BLUE disconnect the 4-Pin connector (Data-Link) and go back to step 1.

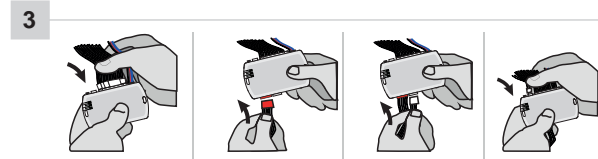

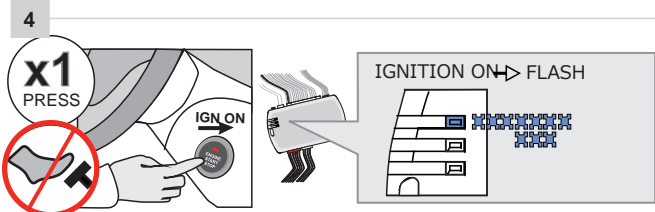

Insert the required remaining connectors.

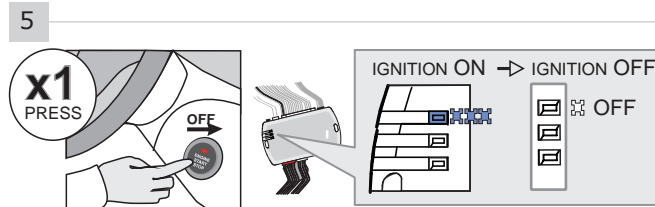

Do not press the brake pedal.
Press the Push-to-Start button once to turn on the ignition.

↳ The BLUE LED will flash rapidly.



Press the Push-to-Start button once to turn off the ignition.

↳ The BLUE LED will turn off.

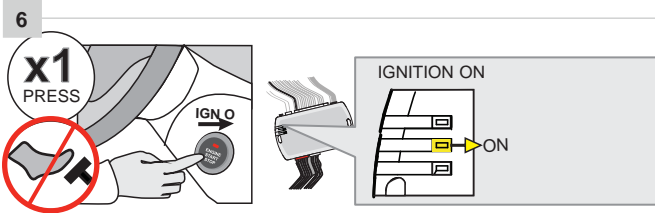

Do not press the brake pedal.
Press the Push-to-Start button once to turn on the ignition.



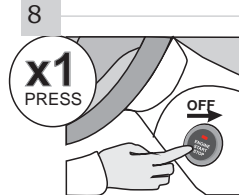
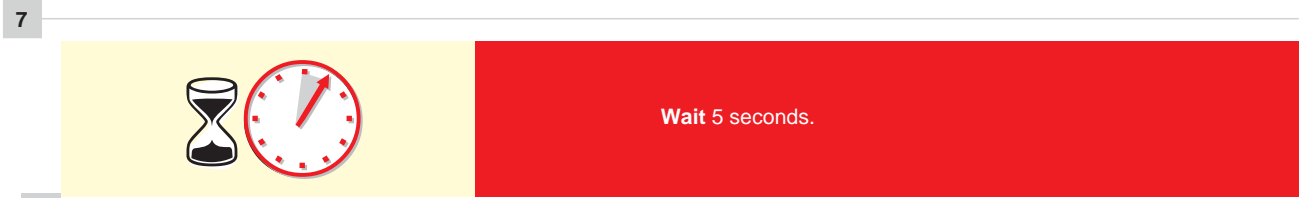

↳ The YELLOW LED will turn ON.

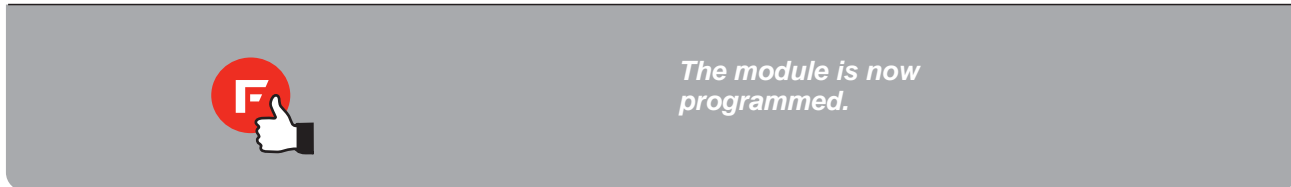

Press the Push-to-Start button once to turn off the ignition.

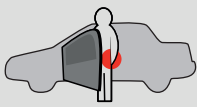

REMOTE STARTER FUNCTIONALITY

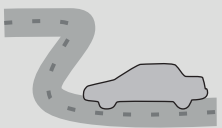
 <p>Start</p> <p>All doors must be closed.</p> <p>Remote start the vehicle.</p>	 <p>UNLOCK</p> <p>Unlock the doors with either:</p> <ul style="list-style-type: none"> • The OEM remote • The remote-starter remote • Or the proximity remote 	 <p>Enter the vehicle with the SMART-KEY.</p>	 <p>DO NOT PRESS THE BRAKE PEDAL.</p> <p>Press and release the Push-to-Start button once.</p>	 <p>Press the brake pedal. The vehicle can now be put in to gear and driven.</p> <p>If the Smart-Key is not detected the vehicle will shut down.</p>
--	---	--	---	---

THAR-FOR3 THARNESSE INSTALLATION

ADDENDUM - SUGGESTED WIRING CONFIGURATION



ONLY COMPATIBLE WITH AUTOMATIC TRANSMISSION VEHICLES.



Vehicle functions supported in this diagram (functional if equipped)

VEHICLE	YEARS	Immobilizer bypass	Lock	Unlock	Arm	Disarm	RAP Disable	Parking Lights	Tachometer	Heated seats	Heated Mirrors	Rear defrost	Door Status	Trunk Status	Hood Status*	Hand-Brake Status	Foot-Brake Status	Active OEM Remote Start
FORD																		
F-150	Key 2015-2019	•	•	•	•	•	•	•	•	•	•	•	•	•	•	•	•	•
F-250	Key 2017-2019	•	•	•	•	•	•	•	•	•	•	•	•	•	•	•	•	•
F-350	Key 2017-2019	•	•	•	•	•	•	•	•	•	•	•	•	•	•	•	•	•
F-450	Key 2017-2019	•	•	•	•	•	•	•	•	•	•	•	•	•	•	•	•	•
F-550	Key 2017	•	•	•	•	•	•	•	•	•	•	•	•	•	•	•	•	•

FIRMWARE VERSION

4.01

ONLY - SEULEMENT

To add the firmware version and the options, use the **FLASH LINK UPDATER** or **FLASH LINK MOBILE** tool, sold separately.

		UNIT OPTION	DESCRIPTION
	<p>Program bypass option IF THE VEHICLE IS NOT EQUIPPED WITH FUNCTIONAL HOOD PIN:</p>	<p>A11</p>	<p>OFF</p> <p>Hood trigger (Output Status).</p>

		UNIT OPTION	DESCRIPTION
	<p>Program bypass option:</p>	<p>C1</p>	<p>OEM Remote status (Lock/Unlock) monitoring</p>



Parts required (Not included)

1x THAR-FOR3

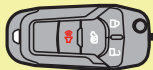

The vehicle must be equipped with the OEM remote with the door locks.

MANDATORY INSTALL

*HOOD PIN



HOOD STATUS: THE HOOD PIN SWITCH MUST BE INSTALLED IF THE VEHICLE CAN BE REMOTE STARTED WITH THE HOOD OPEN, SET FUNCTION **A11** TO OFF.

A11

OFF

Notice: the installation of safety elements are mandatory. The hood pin is an essential security element and must be installed.

THIS MODULE MUST BE INSTALLED BY A QUALIFIED TECHNICIAN. A WRONG CONNECTION CAN CAUSE PERMANENT DAMAGE TO THE VEHICLE.

DESCRIPTION



② Parking Lights switch

① Gateway module, located at dash board driver's side,

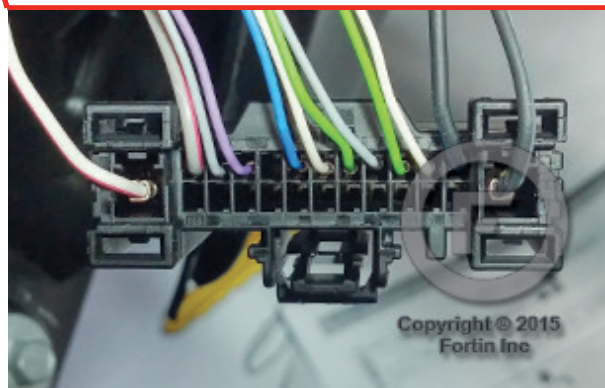
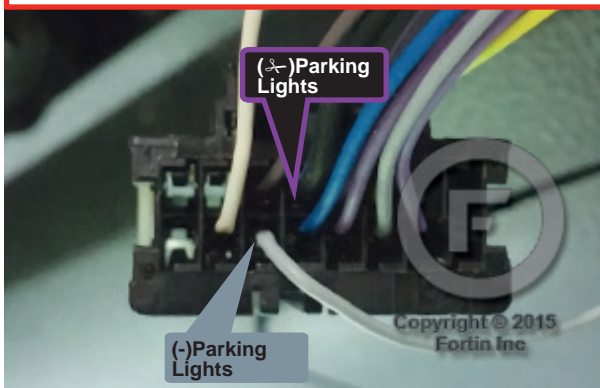

④ Under the hood If not equipped with hood pin.

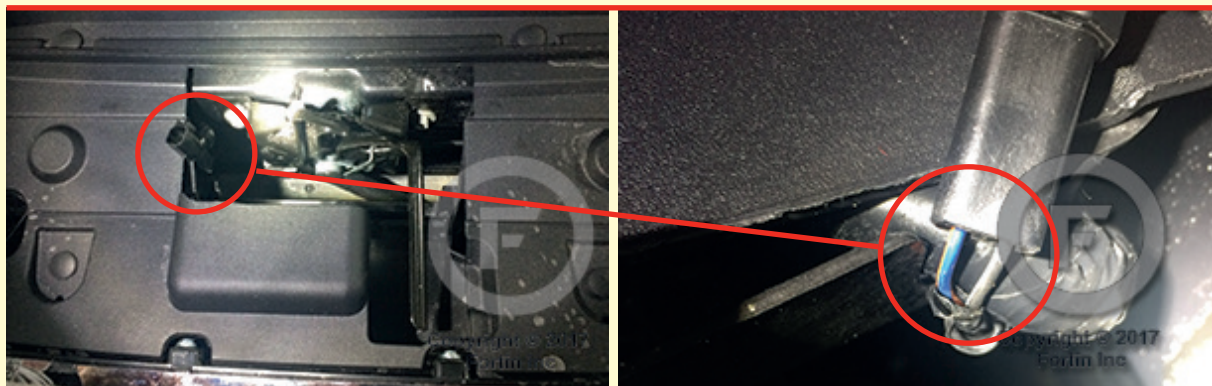

AUTOMATIC TRANSMISSION WIRING CONNECTION

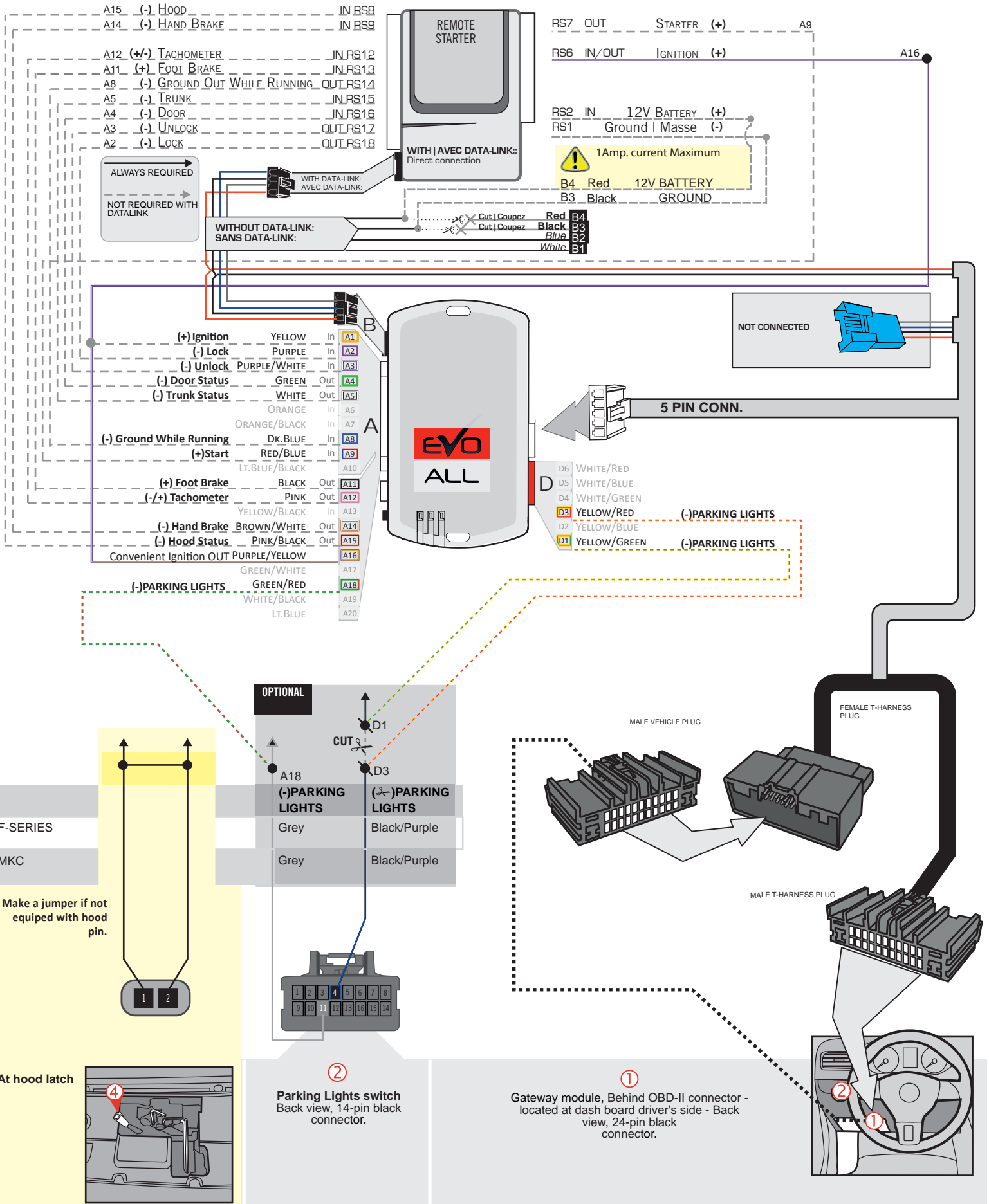

PROGRAMMING PROCEDURE

1

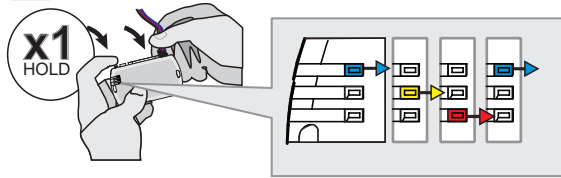

Press and hold the programming button:
Insert the 4-Pin (Data-Link) connector.

↳ The Blue, Red, Yellow and Blue & Red LEDs will alternatively illuminate.

2

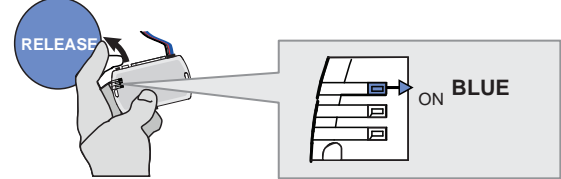

Release the programming button when the LED is BLUE.

If the LED is not solid BLUE disconnect the 4-Pin connector (Data-Link) and go back to step 1.

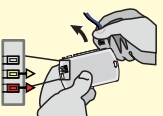

3

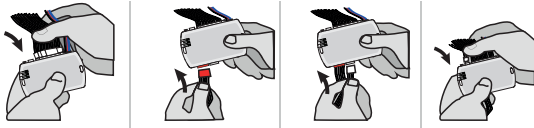

Insert the required remaining connectors.

4

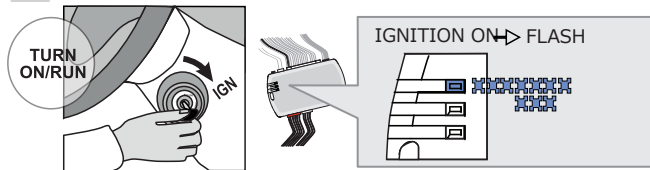

Turn the key to the Ignition ON/RUN position.

↳ The BLUE LED will flash rapidly.

5

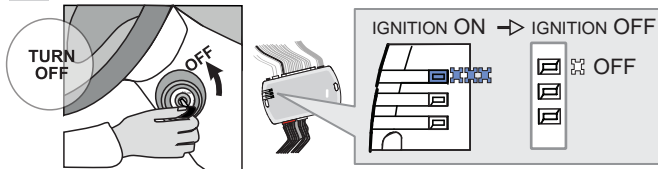

Turn the key to the OFF position.

↳ The BLUE LED will turn off.

6

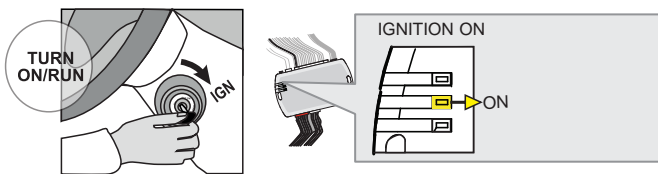

Turn the key to the Ignition ON/RUN position.

↳ The YELLOW LED will turn ON.

7



Wait 5 seconds.

8

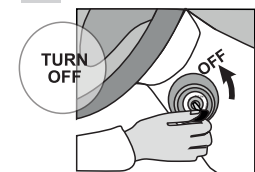

Turn the key to the OFF position.



The module is now programmed.

REMOTE STARTER FUNCTIONALITY



All doors must be closed.



Remote start the vehicle.



Unlock the doors with the remote-starter remote or the OEM remote.



Insert and Turn the key to the Ignition ON/RUN position.



Press the brake pedal.



The vehicle can now be put in to gear and driven.

THAR-FOR3 THARNNESS INSTALLATION

ADDENDUM - SUGGESTED WIRING CONFIGURATION



ONLY COMPATIBLE WITH AUTOMATIC TRANSMISSION VEHICLES.

VEHICLE	YEARS	Vehicle functions supported in this diagram (functional if equipped)																
		Immobilizer bypass	Lock	Unlock	Arm	Disarm	RAP Disable	Parking Lights	Tachometer	Heated seats	Heated Mirrors	Rear defrost	Door Status	Trunk Status	Hood Status*	Hand-Brake Status	Foot-Brake Status	Active OEM Remote Start
FORD																		
Fusion	Push-to-Start 2014-2019	•	•	•	•	•	•	•	•	•	•	•	•	•	•	•	•	•
	Hybrid Push-to-Start 2014-2019	•	•	•	•	•	•	•	•	•	•	•	•	•	•	•	•	•
LINCOLN																		
Continental	Push-to-Start 2017-2019	•	•	•	•	•	•	•	•	•	•	•	•	•	•	•	•	•
MKZ	Push-to-Start 2013-2019	•	•	•	•	•	•	•	•	•	•	•	•	•	•	•	•	•
	Hybrid Push-to-Start 2013-2019	•	•	•	•	•	•	•	•	•	•	•	•	•	•	•	•	•



4.01

ONLY - SEULEMENT

To add the firmware version and the options, use the **FLASH LINK UPDATER** or **FLASH LINK MOBILE** tool, sold separately.

UNIT OPTION	DESCRIPTION

Program bypass option IF THE VEHICLE IS NOT EQUIPPED WITH FUNCTIONAL HOOD PIN:

UNIT OPTION	DESCRIPTION
C1	OEM Remote status (Lock/Unlock) monitoring

Program bypass option: (Vehicle hybrid only):

UNIT OPTION	DESCRIPTION
D4	Hybrid mode (Vehicle hybrid only)



Parts required (Not included)

1x THAR-FOR3

MANDATORY INSTALL

*HOOD PIN



HOOD STATUS: THE HOOD PIN SWITCH MUST BE INSTALLED IF THE VEHICLE CAN BE REMOTE STARTED WITH THE HOOD OPEN, SET FUNCTION A11 TO OFF.

A11

OFF

Notice: the installation of safety elements are mandatory. The hood pin is an essential security element and must be installed.

THIS MODULE MUST BE INSTALLED BY A QUALIFIED TECHNICIAN. A WRONG CONNECTION CAN CAUSE PERMANENT DAMAGE TO THE VEHICLE.

DESCRIPTION



② Parking Lights switch

① Gateway module, Behind OBD-II connector

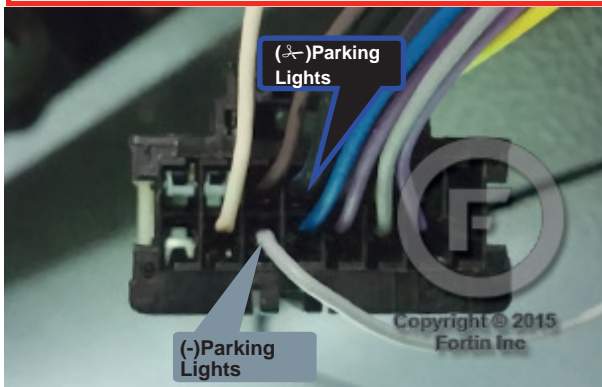

AUTOMATIC TRANSMISSION WIRING CONNECTION

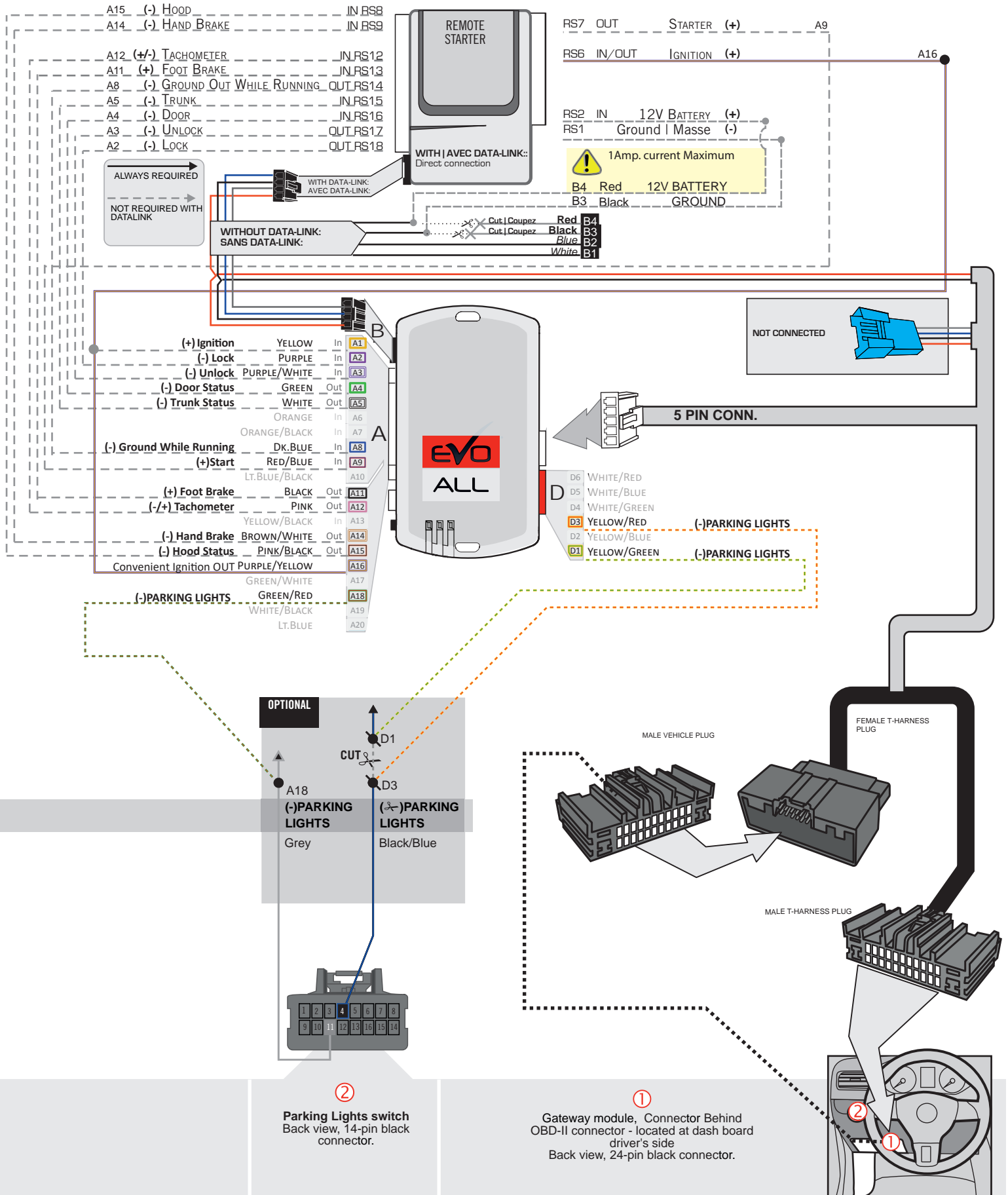

PROGRAMMING PROCEDURE

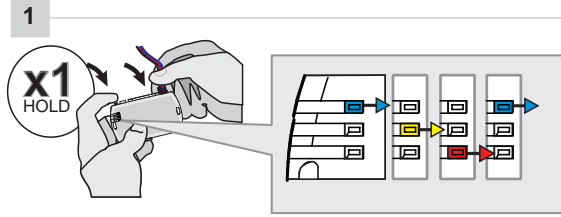

Press and hold the programming button:
Insert the 4-Pin (Data-Link) connector.

↳ The Blue, Red, Yellow and Blue & Red LEDs will alternatively illuminate.

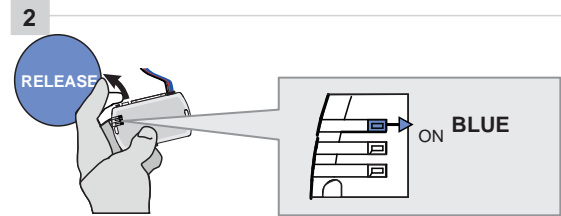

Release the programming button when the LED is BLUE.

If the LED is not solid BLUE disconnect the 4-Pin connector (Data-Link) and go back to step 1.

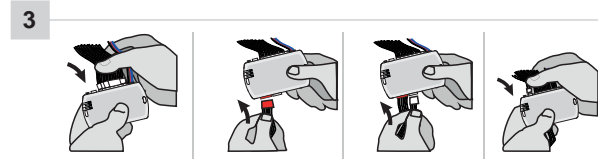

Insert the required remaining connectors.

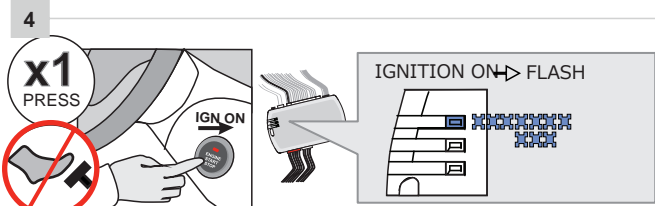

Do not press the brake pedal.
Press the Push-to-Start button once to turn on the ignition.

↳ The BLUE LED will flash rapidly.

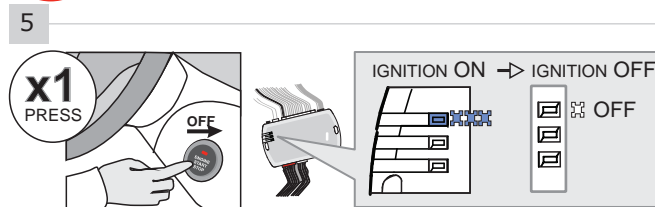

Press the Push-to-Start button once to turn off the ignition.

↳ The BLUE LED will turn off.

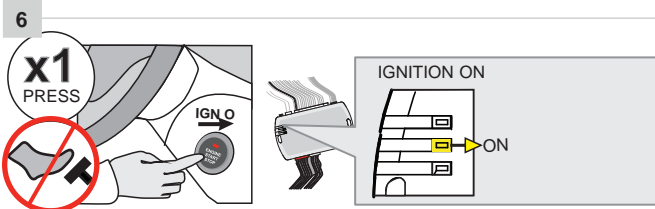

Do not press the brake pedal.
Press the Push-to-Start button once to turn on the ignition.



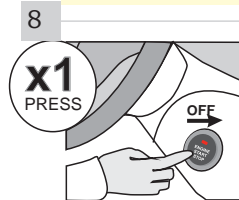
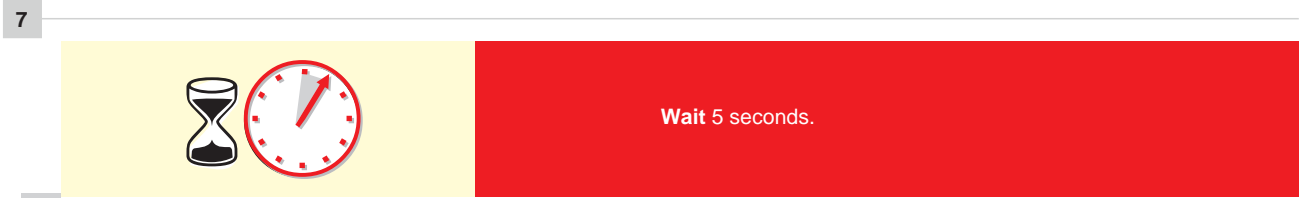

↳ The YELLOW LED will turn ON.

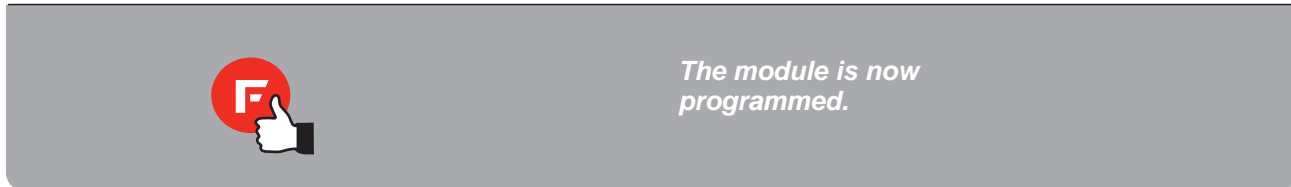

Press the Push-to-Start button once to turn off the ignition.

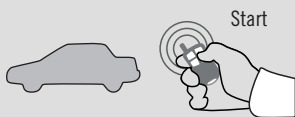

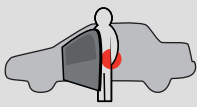
REMOTE STARTER FUNCTIONALITY

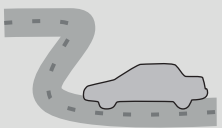
 <p>Start</p> <p>All doors must be closed.</p> <p>Remote start the vehicle.</p>	 <p>UNLOCK</p> <p>Unlock the doors with either:</p> <ul style="list-style-type: none"> • The OEM remote • The remote-starter remote • Or the proximity remote 	 <p>Enter the vehicle with the SMART-KEY.</p>	 <p>DO NOT PRESS THE BRAKE PEDAL.</p> <p>Press and release the Push-to-Start button once.</p>	 <p>Press the brake pedal. The vehicle can now be put in to gear and driven.</p> <p>If the Smart-Key is not detected the vehicle will shut down.</p>
--	---	--	---	---

**THAR-FOR3 THARNESSE
INSTALLATION**

ADDENDUM - SUGGESTED WIRING CONFIGURATION



ONLY COMPATIBLE WITH AUTOMATIC TRANSMISSION VEHICLES.

VEHICLE	YEARS	Vehicle functions supported in this diagram (functional if equipped)																
		Immobilizer bypass	Lock	Unlock	Armn	Disarm	RAP Disable	Parking Lights	Tachometer	Heated seats	Heated Mirrors	Rear defrost	Door Status	Trunk Status	Hood Status*	Hand-Brake Status	Foot-Brake Status	Active OEM Remote Start
FORD Fusion	Key 2014-2019	•	•	•	•	•	•	•	•	•	•	•	•	•	•	•	•	•
	Hybrid Key 2014-2019	•	•	•	•	•	•	•	•	•	•	•	•	•	•	•	•	•

FIRMWARE VERSION

4.01

ONLY - SEULEMENT

To add the firmware version and the options, use the **FLASH LINK UPDATER** or **FLASH LINK MOBILE** tool, sold separately.

evo ALL	Program bypass option IF THE VEHICLE IS NOT EQUIPPED WITH FUNCTIONAL HOOD PIN:	UNIT OPTION	DESCRIPTION
		A11	OFF
evo ALL	Program bypass option:	UNIT OPTION	DESCRIPTION
		C1	OEM Remote status (Lock/Unlock) monitoring
evo ALL	Program bypass option (Vehicle hybrid only):	UNIT OPTION	DESCRIPTION
		D4	Hybrid mode (Vehicle hybrid only)



Parts required (Not included)

1x THAR-FOR3



The vehicle must be equipped with the OEM remote with the door locks.

MANDATORY INSTALL

*HOOD PIN



HOOD STATUS: THE HOOD PIN SWITCH MUST BE INSTALLED IF THE VEHICLE CAN BE REMOTE STARTED WITH THE HOOD OPEN, SET FUNCTION **A11** TO OFF.

A11

OFF

Notice: the installation of safety elements are mandatory. The hood pin is an essential security element and must be installed.

THIS MODULE MUST BE INSTALLED BY A QUALIFIED TECHNICIAN. A WRONG CONNECTION CAN CAUSE PERMANENT DAMAGE TO THE VEHICLE.

DESCRIPTION



② Parking Lights switch

① Gateway module, Behind OBD-II connector

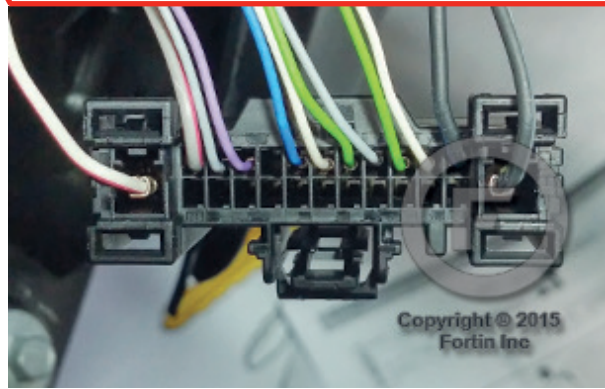
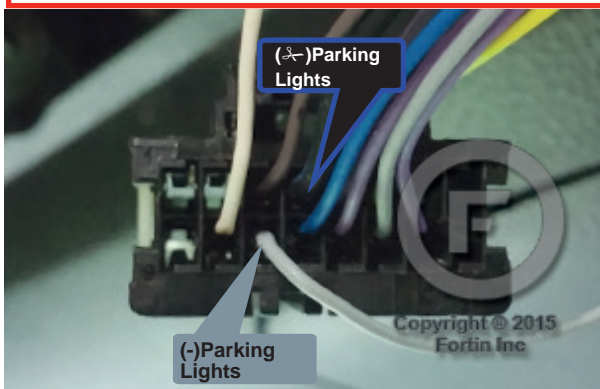

AUTOMATIC TRANSMISSION WIRING CONNECTION

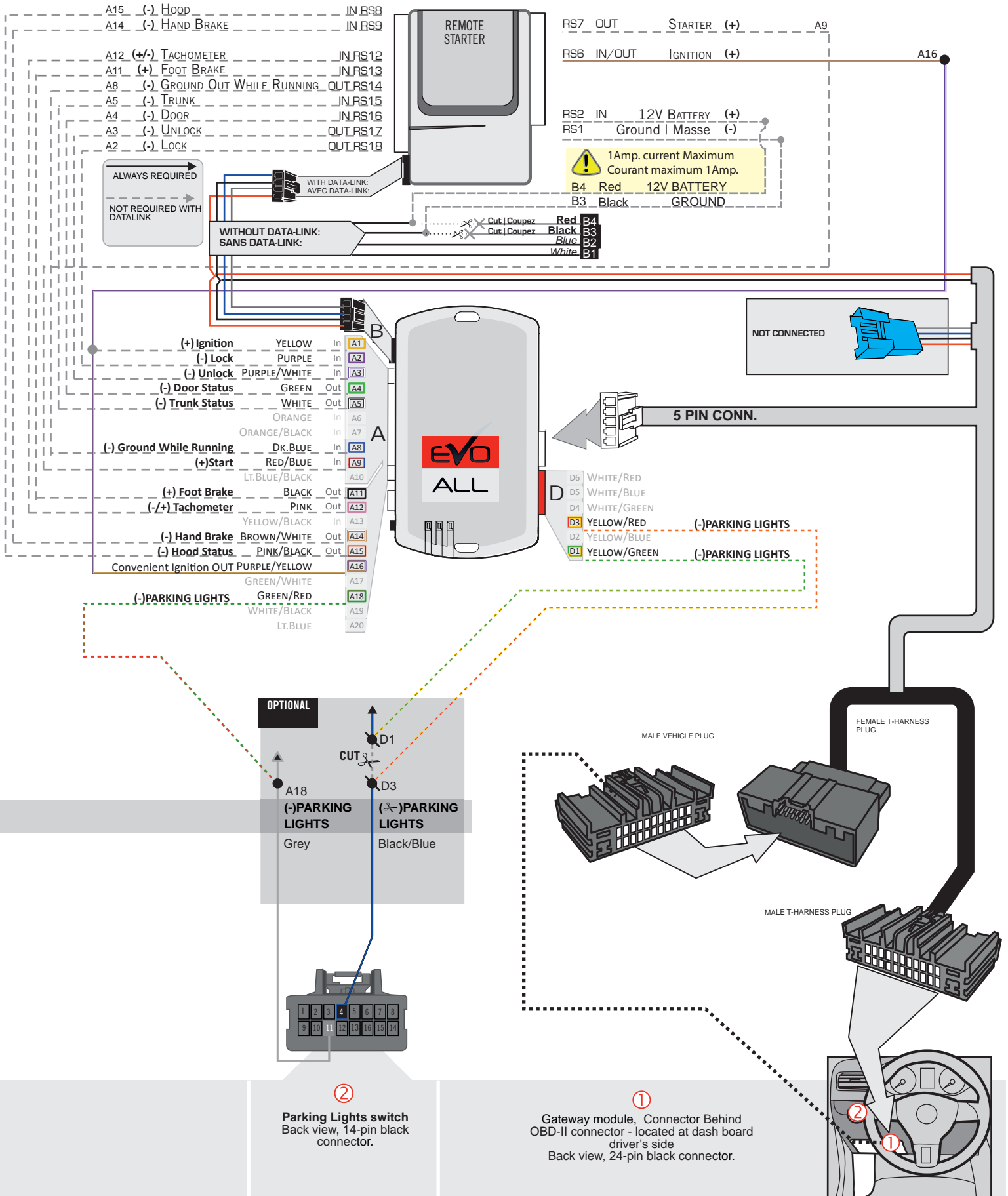

PROGRAMMING PROCEDURE

1

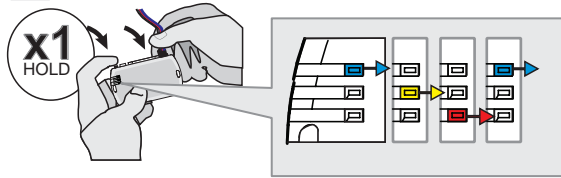

Press and hold the programming button:
Insert the 4-Pin (Data-Link) connector.

↳ The Blue, Red, Yellow and Blue & Red LEDs will alternatively illuminate.

2

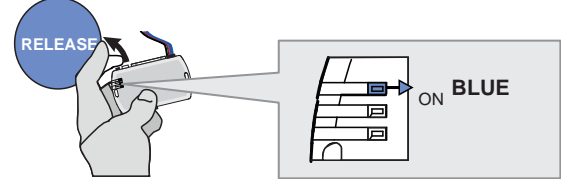

Release the programming button when the LED is BLUE.

If the LED is not solid BLUE disconnect the 4-Pin connector (Data-Link) and go back to step 1.



3

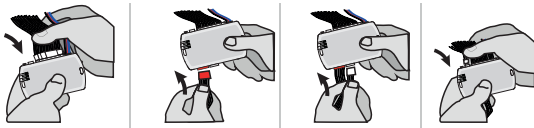

Insert the required remaining connectors.

4

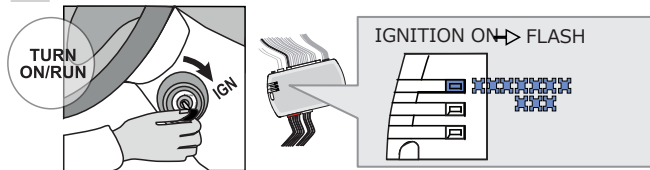

Turn the key to the Ignition ON/RUN position.

↳ The BLUE LED will flash rapidly.

5

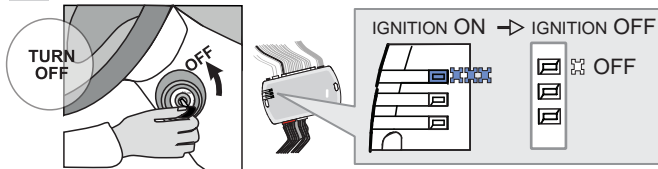

Turn the key to the OFF position.

↳ The BLUE LED will turn off.

6

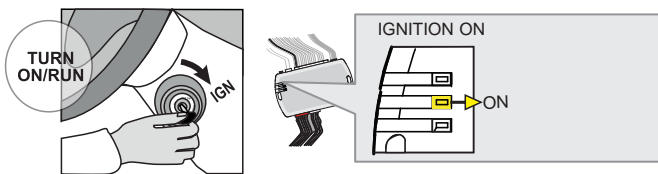

Turn the key to the Ignition ON/RUN position.

↳ The YELLOW LED will turn ON.

7



Wait 5 seconds.

8

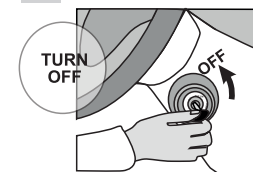

Turn the key to the OFF position.



The module is now programmed.

REMOTE STARTER FUNCTIONALITY



All doors must be closed.



Remote start the vehicle.



Unlock the doors with the remote-starter remote or the OEM remote.



Insert and Turn the key to the Ignition ON/RUN position.



Press the brake pedal.



The vehicle can now be put in to gear and driven.

**THAR-FOR3 THARNNESS
INSTALLATION**

ADDENDUM - SUGGESTED WIRING CONFIGURATION



ONLY COMPATIBLE WITH AUTOMATIC TRANSMISSION VEHICLES.



Vehicle functions supported in this diagram (functional if equipped)

VEHICLE	YEARS	Immobilizer bypass	Lock	Unlock	Arm	Disarm	RAP Disable	Parking Lights	Tachometer	Heated seats	Heated Mirrors	Rear defrost	Door Status	Trunk Status	Hood Status*	Hand-Brake Status	Foot-Brake Status	Active OEM Remote Start
FORD																		
Mondeo	Key 2013-2015	•	•	•	•	•	•	•	•	•	•	•	•	•	•	•	•	•



FIRMWARE VERSION

4.01

ONLY - SEULEMENT

To add the firmware version and the options, use the **FLASH LINK UPDATER** or **FLASH LINK MOBILE** tool, sold separately.



Program bypass option:

UNIT OPTION

C1

DESCRIPTION

OEM Remote status (Lock/Unlock) monitoring

IF THE VEHICLE IS NOT EQUIPPED WITH FUNCTIONAL HOOD PIN:

A11

OFF

Hood trigger (Output Status).



Parts required (Not included)

1x THAR-FOR3

NOTES



The vehicle must be equipped with the OEM remote with the door locks.

MANDATORY INSTALL

*HOOD PIN



HOOD STATUS: THE HOOD PIN SWITCH MUST BE INSTALLED IF THE VEHICLE CAN BE REMOTE STARTED WITH THE HOOD OPEN, SET FUNCTION **A11** TO OFF.

A11

OFF

Notice: the installation of safety elements are mandatory. The hood pin is an essential security element and must be installed.

THIS MODULE MUST BE INSTALLED BY A QUALIFIED TECHNICIAN. A WRONG CONNECTION CAN CAUSE PERMANENT DAMAGE TO THE VEHICLE.

DESCRIPTION

① Gateway module, located at dash board driver's side,



② Parking Lights switch

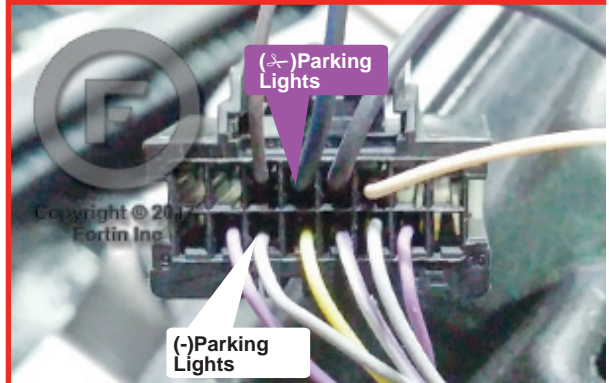

AUTOMATIC TRANSMISSION WIRING CONNECTION

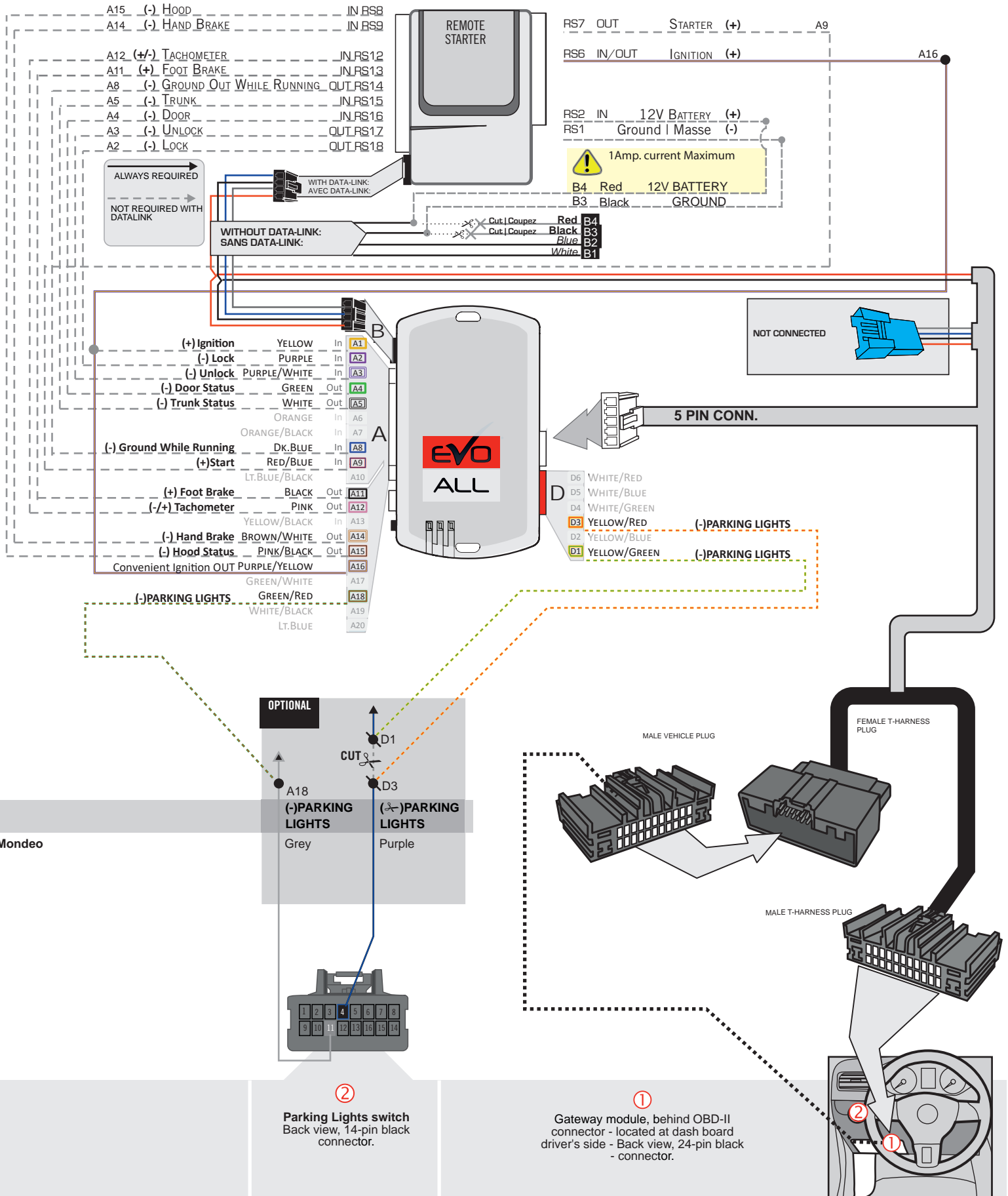

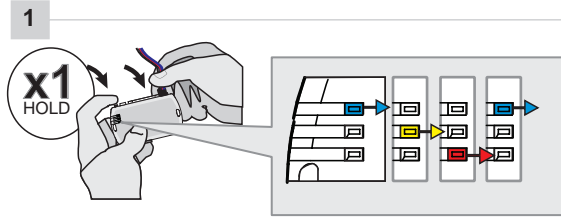

Press and hold the programming button:
Insert the 4-Pin (Data-Link) connector.

↳ The Blue, Red, Yellow and Blue & Red LEDs will alternatively illuminate.

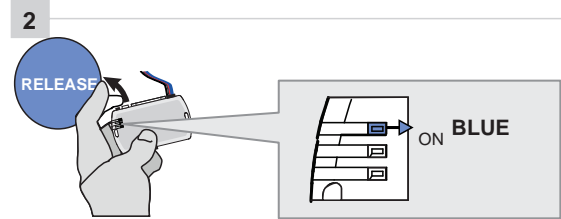

Release the programming button when the LED is BLUE.

If the LED is not solid BLUE disconnect the 4-Pin connector (Data-Link) and go back to step 1.

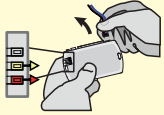
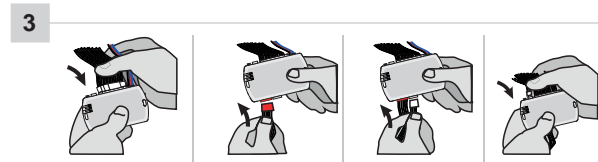

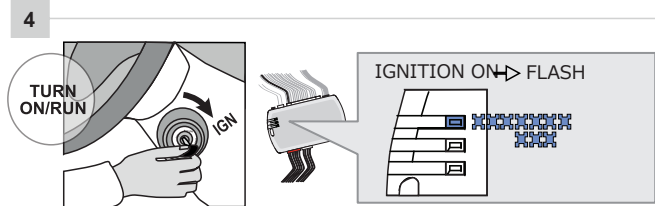

Insert the required remaining connectors.

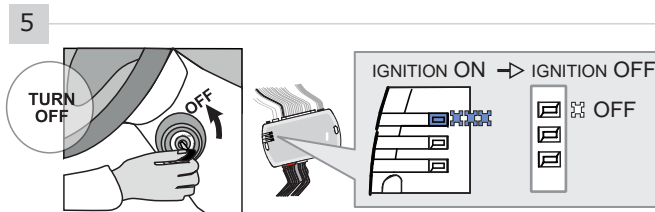

Turn the key to the Ignition ON/RUN position.

↳ The BLUE LED will flash rapidly.



Turn the key to the OFF position.

↳ The BLUE LED will turn off.

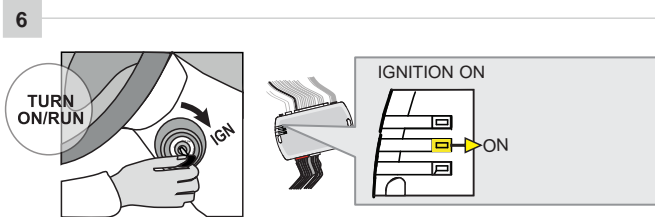

Turn the key to the Ignition ON/RUN position.

↳ The YELLOW LED will turn ON.



Wait 5 seconds.

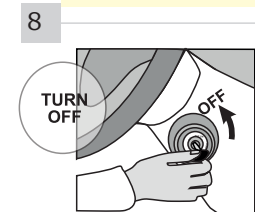

Turn the key to the OFF position.



The module is now programmed.

REMOTE STARTER FUNCTIONALITY



All doors must be closed.



Remote start the vehicle.



Unlock the doors with the remote-starter remote or the OEM remote.



Insert and Turn the key to the Ignition ON/RUN position.



Press the brake pedal.



The vehicle can now be put in to gear and driven.

THAR-FOR3 THARNNESS INSTALLATION

ADDENDUM - SUGGESTED WIRING CONFIGURATION

VEHICLE	YEARS	Vehicle functions supported in this diagram (functional if equipped)														
		KEY CONTROL	T-Harness	Lock	Unlock	Arm	Disarm	RAP Disable	Parking Lights	Tachometer	Door Status	Trunk Status	Hood Status*	Hand-Brake Status	Foot-Brake Status	OEM Remote monitoring
FORD																
Mustang	PTS 2015-2018	•	•	•	•	•	•	•	•	•	•	•	•	•	•	•



	HARDWARE VERSION	FIRMWARE VERSION	To add the firmware version and the options, use the FLASH LINK UPDATER or FLASH LINK MOBILE tool, sold separately.
	MINIMUM 6	4.05 <small>ONLY - SEULEMENT</small>	

	Program bypass option IF THE VEHICLE IS NOT EQUIPPED WITH FUNCTIONAL HOOD PIN:	UNIT OPTION	DESCRIPTION
		A11	OFF

	Program bypass option:	UNIT OPTION	DESCRIPTION
		C1	OEM Remote status (Lock/Unlock) monitoring
		D6	Push-to-Start

Parts required (Not included)	
1X	Vehicle key
1X	7.5 Amp. Fuse
1X	Relay
1X	Diode

MANDATORY INSTALL

***HOOD PIN**

HOOD STATUS: THE HOOD PIN SWITCH MUST BE INSTALLED IF THE VEHICLE CAN BE REMOTE STARTED WITH THE HOOD OPEN, SET FUNCTION **A11** TO OFF.

A11	OFF
------------	------------

Notice: the installation of safety elements are mandatory. The hood pin is an essential security element and must be installed.

THIS MODULE MUST BE INSTALLED BY A QUALIFIED TECHNICIAN. A WRONG CONNECTION CAN CAUSE PERMANENT DAMAGE TO THE VEHICLE.

DESCRIPTION

③ ④ BCM, Passenger kick panel

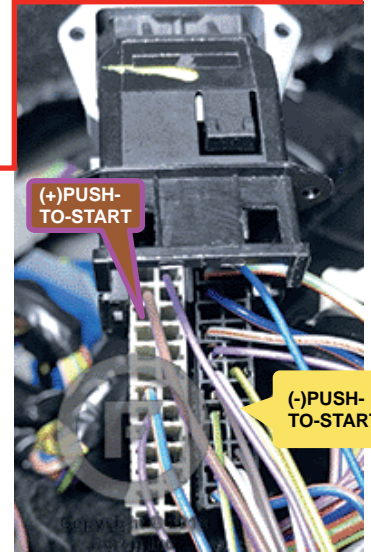
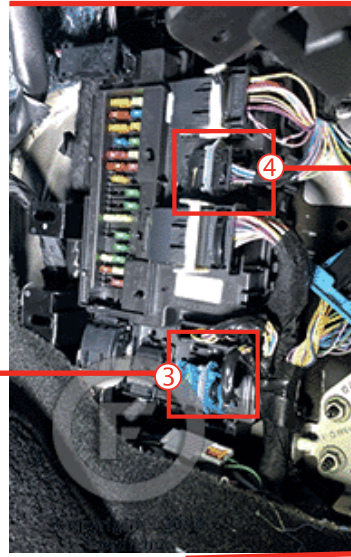
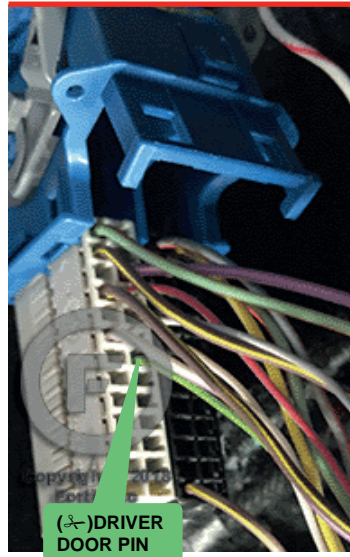

② Parking Lights switch

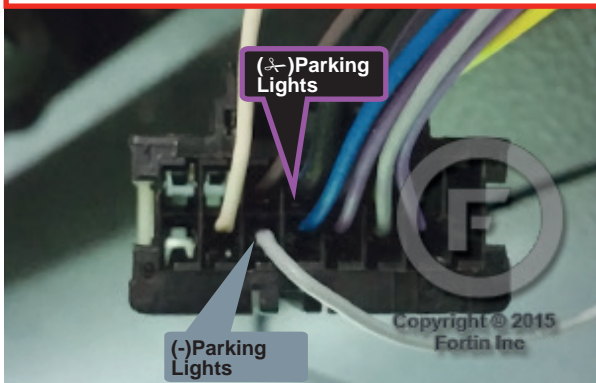

① Gateway module, located at right of steering column.

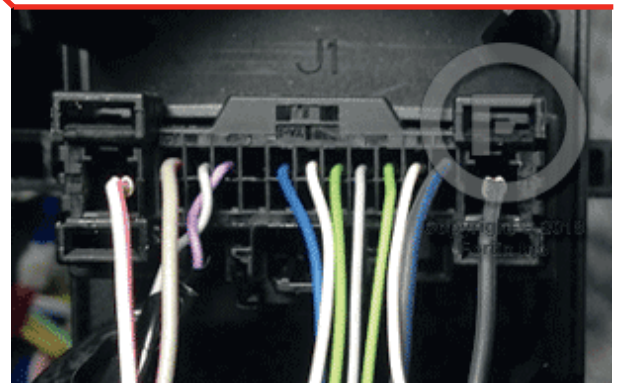

AUTOMATIC TRANSMISSION WIRING CONNECTION

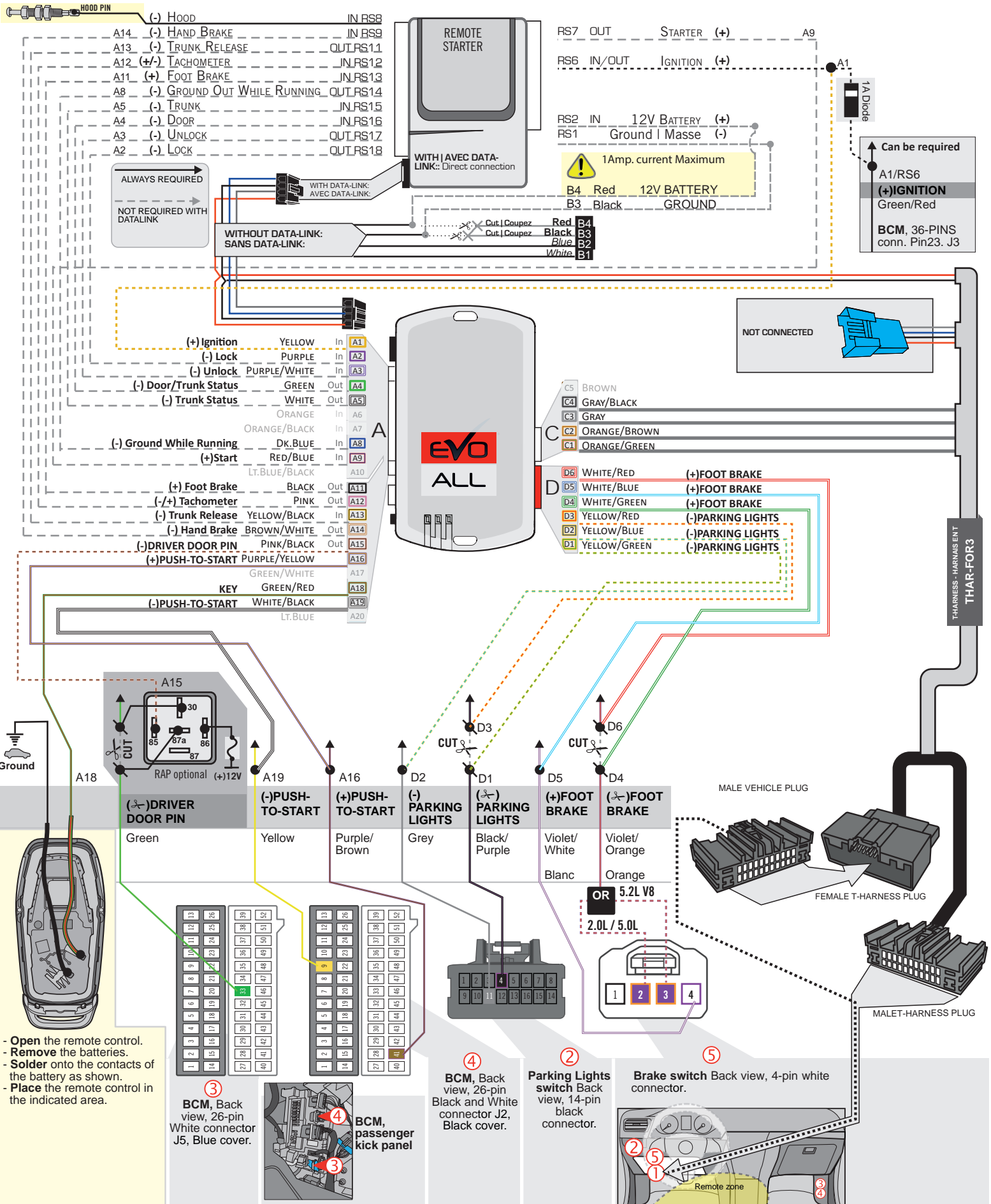

PROGRAMMING PROCEDURE

1

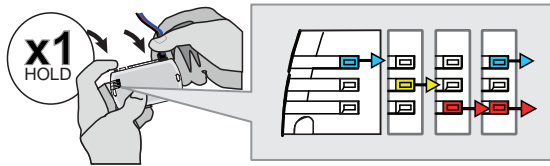

Press and hold the programming button:
Connect the 4-Pin Data-link connector.

↳ The BLUE, RED, YELLOW and BLUE & RED LEDs will alternatively illuminate.

2

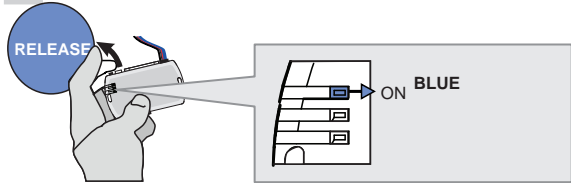

Release the programming button when the LED is BLUE.

Relâchez le bouton de programmation quand la DEL est BLEU.

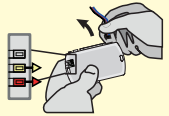

3

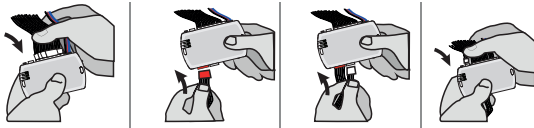

Insert the required remaining connectors.

4

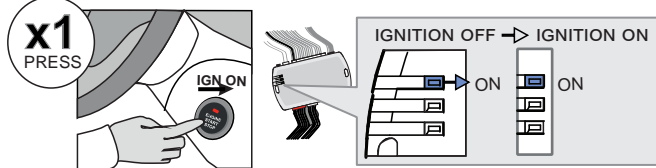

Press the Push-to-Start button to turn ON the ignition.

5

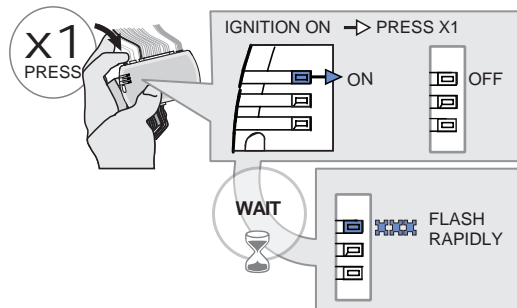

Press and release the programming button once (1x).

↳ The BLUE LED will turn off.

Wait,

↳ The BLUE LED will flash rapidly.

6

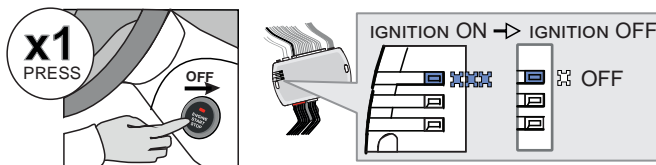

Press the Push-to-Start button once to turn off the ignition.

↳ The BLUE LED will turn off.



The module is now programmed.

REMOTE STARTER FUNCTIONALITY



All doors must be closed.



Remote start the vehicle.



Unlock the doors with either:

- The OEM remote
- The remote-starter remote
- Or the proximity remote



Enter the vehicle with the Intelligent Key.



The vehicle can now be put in to gear and driven.

If the vehicle is not unlocked with one of these conditions the remote-starter will shut down as soon as any door is opened.



THAR-FOR3 THARNESSE INSTALLATION HARNAIS THAR-FOR3

ADDENDUM - SUGGESTED WIRING CONFIGURATION

ONLY COMPATIBLE WITH AUTOMATIC TRANSMISSION VEHICLES.

VEHICLE
YEARS

Vehicle functions supported in this diagram (functional if equipped)

VEHICLE	YEARS	Immobilizer bypass	Lock	Unlock	Armn	Disarm	RAP Disable	Parking Lights	Tachometer	Heated seats	Heated Mirrors	Rear defrost	Door Status	Trunk Status	Hood Status*	Hand-Brake Status	Foot-Brake Status	Active OEM Remote Start	
LINCOLN																			
Nautilus	Push-to-Start 2019	•	•	•	•	•	•	•	•	•	•	•	•	•	•	•	•	•	•
Navigator	Push-to-Start 2018-2019	•	•	•	•	•	•	•	•	•	•	•	•	•	•	•	•	•	•

FIRMWARE VERSION
4.01

ONLY - SEULEMENT

 To add the firmware version and the options, use the **FLASH LINK UPDATER** or **FLASH LINK MOBILE** tool, sold separately.

Program bypass option:
UNIT OPTION
DESCRIPTION
C1

OEM Remote status (Lock/Unlock) monitoring

D6

Push-to-Start

IF THE VEHICLE IS NOT EQUIPPED WITH FUNCTIONAL HOOD PIN:
A11
OFF

Hood trigger (Output Status).

Parts required (Not included)

1x THAR-FOR3

MANDATORY INSTALL
***HOOD PIN**

HOOD STATUS: THE HOOD PIN SWITCH MUST BE INSTALLED IF THE VEHICLE CAN BE REMOTE STARTED WITH THE HOOD OPEN, SET FUNCTION **A11** TO OFF.

A11
OFF
Notice: the installation of safety elements are mandatory. The hood pin is an essential security element and must be installed.

THIS MODULE MUST BE INSTALLED BY A QUALIFIED TECHNICIAN. A WRONG CONNECTION CAN CAUSE PERMANENT DAMAGE TO THE VEHICLE.

DESCRIPTION



②

Parking Lights switch

①

Gateway module, Behind
OBD-II connector
II

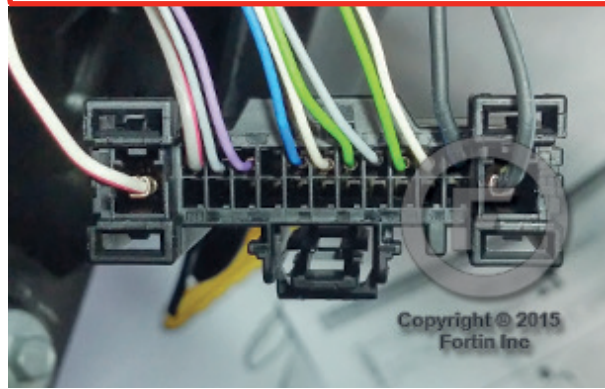
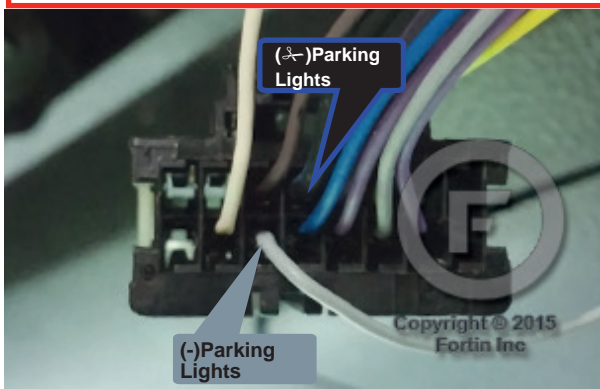

AUTOMATIC TRANSMISSION WIRING CONNECTION

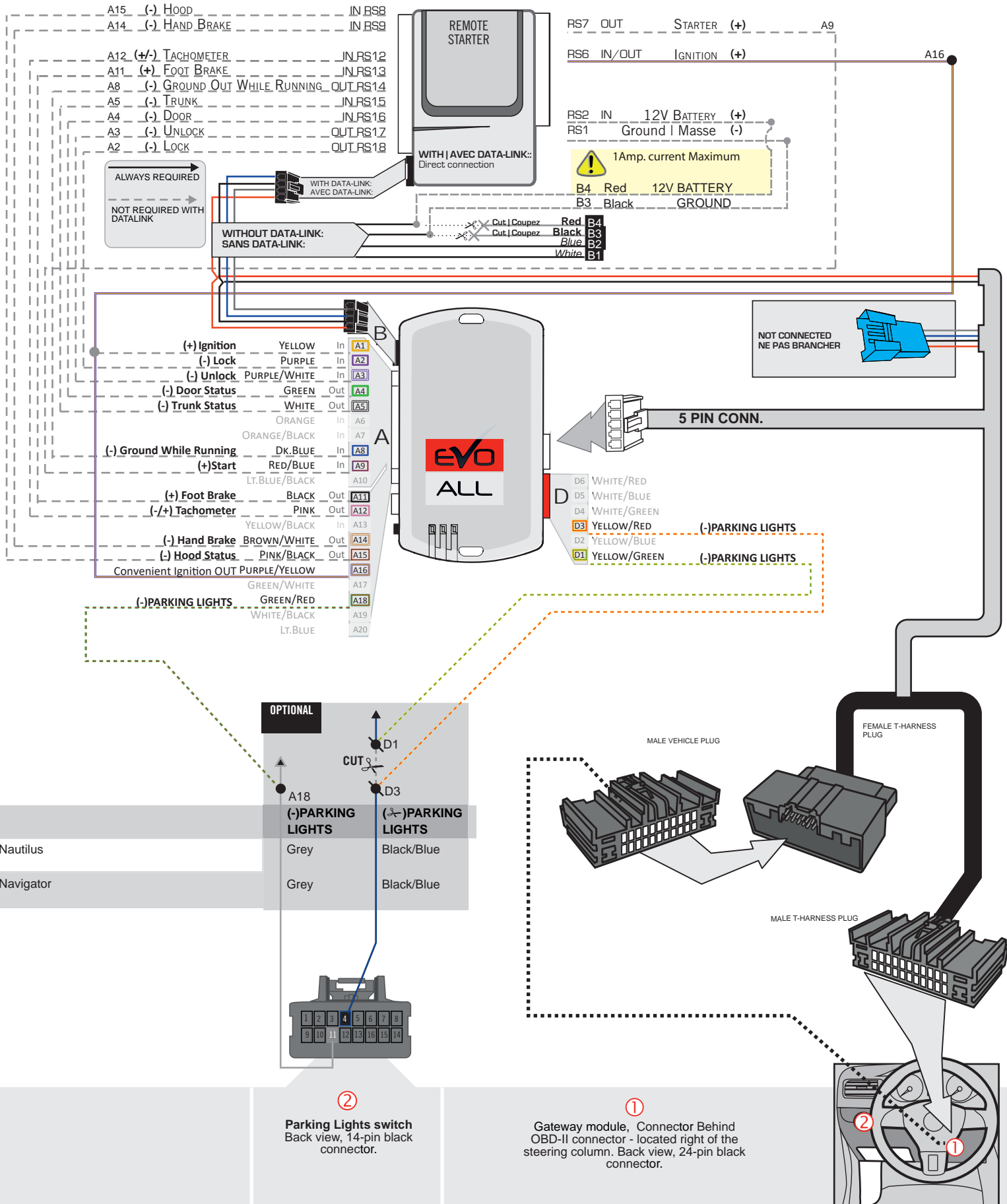

PROGRAMMING PROCEDURE

1

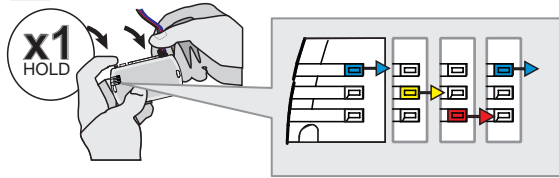

Press and hold the programming button:
Insert the 4-Pin (Data-Link) connector.

↳ The Blue, Red, Yellow and Blue & Red LEDs will alternatively illuminate.

2

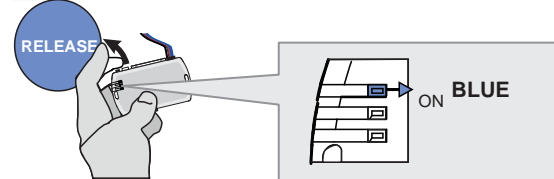

Release the programming button when the LED is BLUE.

If the LED is not solid BLUE disconnect the 4-Pin connector (Data-Link) and go back to step 1.

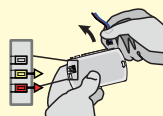

3

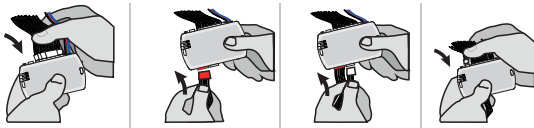

Insert the required remaining connectors.

4

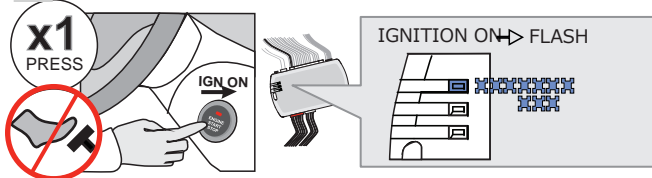

Do not press the brake pedal.
Press the Push-to-Start button once to turn on the ignition.

↳ The BLUE LED will flash rapidly.

5

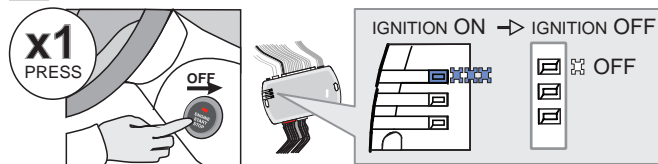

Press the Push-to-Start button once to turn off the ignition.

↳ The BLUE LED will turn off.

6

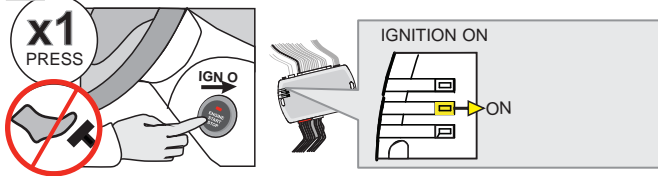

Do not press the brake pedal.
Press the Push-to-Start button once to turn on the ignition.

↳ The YELLOW LED will turn ON.

7



Wait 5 seconds.

8

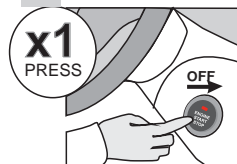





Press the Push-to-Start button once to turn off the ignition.

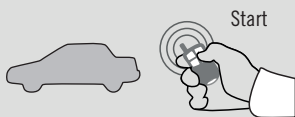

The module is now programmed.

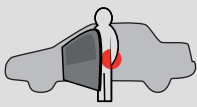
REMOTE STARTER FUNCTIONALITY

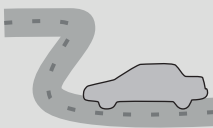
 <p>Start</p> <p>All doors must be closed.</p> <p>Remote start the vehicle.</p>	 <p>UNLOCK</p> <p>Unlock the doors with either:</p> <ul style="list-style-type: none"> • The OEM remote • The remote-starter remote • Or the proximity remote 	 <p>Enter the vehicle with the SMART-KEY.</p>	 <p>DO NOT PRESS THE BRAKE PEDAL.</p> <p>Press and release the Push-to-Start button once.</p>	 <p>Press the brake pedal. The vehicle can now be put in to gear and driven.</p> <p>If the Smart-Key is not detected the vehicle will shut down.</p>
--	---	--	---	---

THAR-FOR3 THARNNESS INSTALLATION

ADDENDUM - SUGGESTED WIRING CONFIGURATION

ONLY COMPATIBLE WITH AUTOMATIC TRANSMISSION VEHICLES.

		Vehicle functions supported in this diagram (functional if equipped)																			
VEHICLE	YEARS	Immobilizer bypass	T-Harness available (sold separately)	Lock	Unlock	Arm	Disarm	RAP Disable	Horn	Parking Lights	Tachometer	Heated seats	Heated Mirrors	Rear defrost	Door Status	Trunk Status	Hood Status*	Hand-Brake Status	Foot-Brake Status	Active OEM Remote Start	
FORD																					
Ranger	Push-to-Start 2019	•	•	•	•	•	•	•	•	•	•	•	•	•	•	•	•	•	•	•	•

FIRMWARE VERSION

4.01

ONLY - SEULEMENT

To add the firmware version and the options, use the **FLASH LINK UPDATER** or **FLASH LINK MOBILE** tool, sold separately.

	Program bypass option IF THE VEHICLE IS NOT EQUIPPED WITH FUNCTIONAL HOOD PIN:	UNIT OPTION	DESCRIPTION	
		A11	<div style="background-color: #dc3545; color: white; padding: 2px 5px; font-weight: bold;">OFF</div>	Hood trigger (Output Status).
	Program bypass option:	C1		OEM Remote status (Lock/Unlock) monitoring

Parts required (Not included)

1x 7.5Amp. Fuse

MANDATORY INSTALL

***HOOD PIN** **HOOD STATUS:** THE HOOD PIN SWITCH MUST BE INSTALLED IF THE VEHICLE CAN BE REMOTE STARTED WITH THE HOOD OPEN, SET FUNCTION A11 TO OFF.

A11

OFF

Notice: the installation of safety elements are mandatory. The hood pin is an essential security element and must be installed.

THIS MODULE MUST BE INSTALLED BY A QUALIFIED TECHNICIAN. A WRONG CONNECTION CAN CAUSE PERMANENT DAMAGE TO THE VEHICLE.

DESCRIPTION |



① Gateway module, located at dash board driver's side,



WIRING CONNECTION |

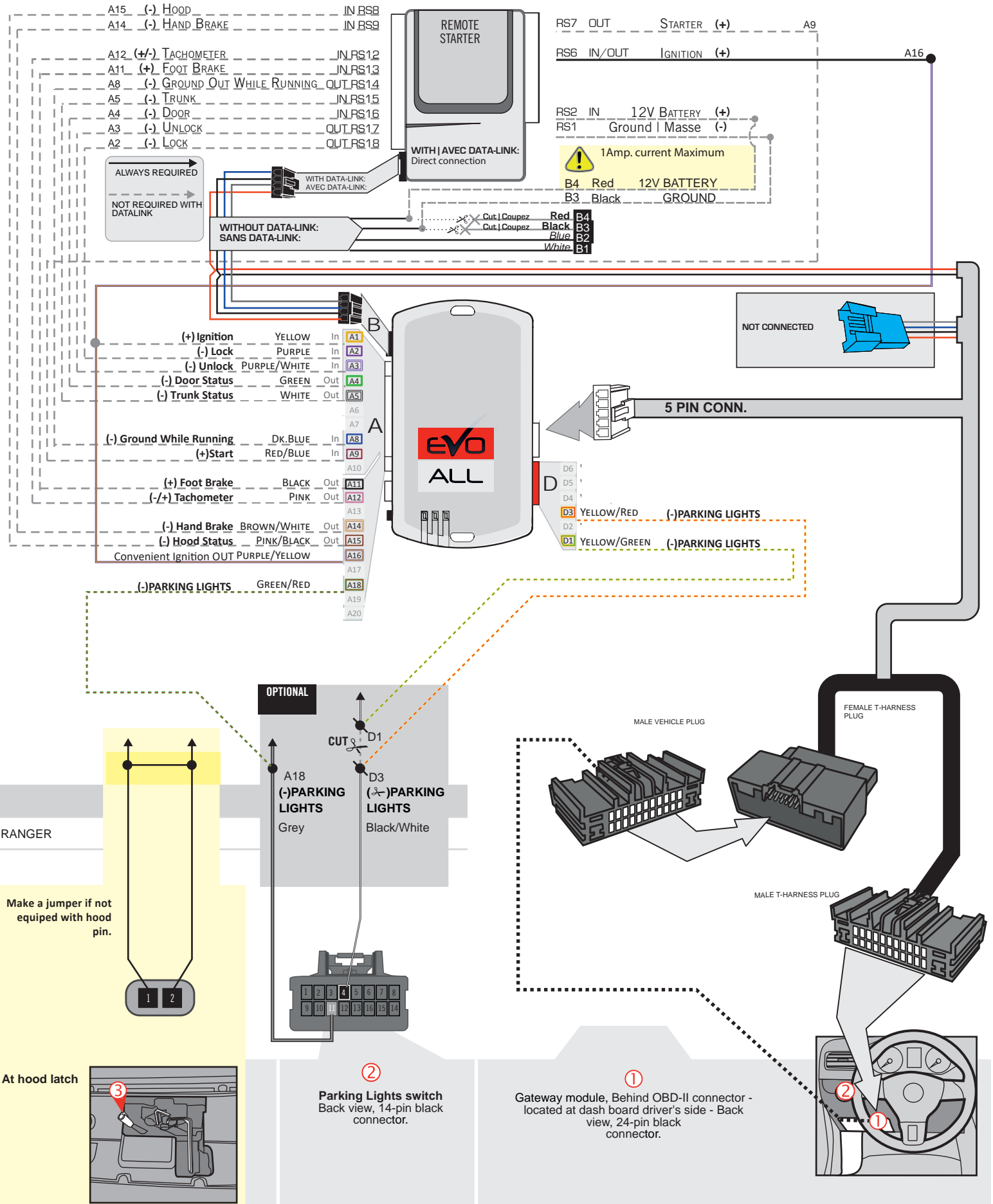

PROGRAMMING PROCEDURE |

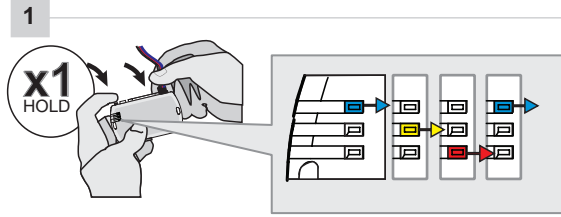

Press and hold the programming button:
Insert the 4-Pin (Data-Link) connector.

↳ The Blue, Red, Yellow and Blue & Red LEDs will alternatively illuminate.

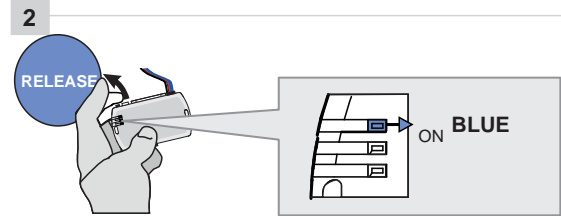

Release the programming button when the LED is BLUE.

If the LED is not solid BLUE disconnect the 4-Pin connector (Data-Link) and go back to step 1.

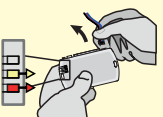
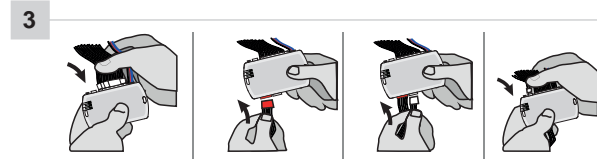

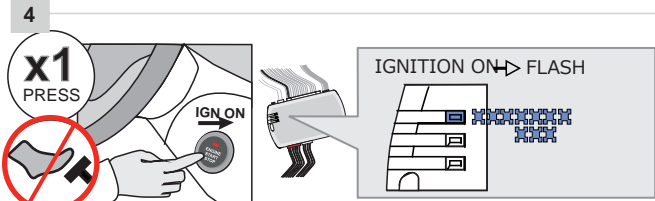

Insert the required remaining connectors.

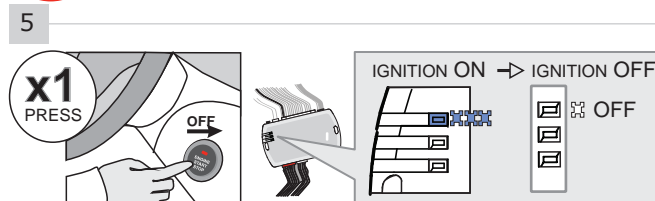

Do not press the brake pedal.
Press the Push-to-Start button once to turn on the ignition.

↳ The BLUE LED will flash rapidly.



Press the Push-to-Start button once to turn off the ignition.

↳ The BLUE LED will turn off.

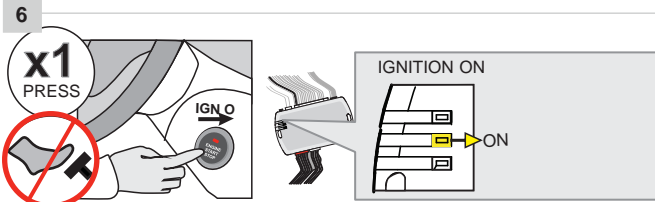

Do not press the brake pedal.
Press the Push-to-Start button once to turn on the ignition.

↳ The YELLOW LED will turn ON.



Wait 5 seconds.

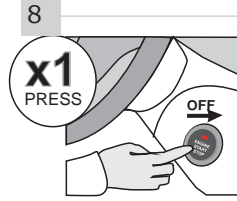





Press the Push-to-Start button once to turn off the ignition.

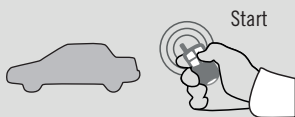

The module is now programmed.

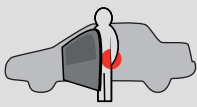
REMOTE STARTER FUNCTIONALITY |

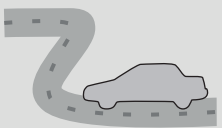
 <p>Start</p> <p>All doors must be closed.</p> <p>Remote start the vehicle.</p>	 <p>UNLOCK</p> <p>Unlock the doors with either:</p> <ul style="list-style-type: none"> • The OEM remote • The remote-starter remote • Or the proximity remote 	 <p>Enter the vehicle with the SMART-KEY.</p>	 <p>x1 PRESS</p> <p>DO NOT PRESS THE BRAKE PEDAL.</p> <p>Press and release the Push-to-Start button once.</p>	 <p>Press the brake pedal. The vehicle can now be put in to gear and driven.</p> <p>If the Smart-Key is not detected the vehicle will shut down.</p>
--	---	--	--	---

THAR-FOR3 THARNESSE INSTALLATION

ADDENDUM - SUGGESTED WIRING CONFIGURATION



ONLY COMPATIBLE WITH AUTOMATIC TRANSMISSION VEHICLES.



Vehicle functions supported in this diagram (functional if equipped)

VEHICLE	YEARS	Immobilizer bypass	Lock	Unlock	Arm	Disarm	RAP Disable	Parking Lights	Tachometer	Heated seats	Heated Mirrors	Rear defrost	Door Status	Trunk Status	Hood Status*	Hand-Brake Status	Foot-Brake Status	Active OEM Remote Start	
FORD Transit Connect	Key 2019	•	•	•	•	•	•	•	•	•	•	•	•	•	•	•	•	•	•



FIRMWARE VERSION

4.02

ONLY - SEULEMENT

To add the firmware version and the options, use the **FLASH LINK UPDATER** or **FLASH LINK MOBILE** tool, sold separately.



Program bypass option:

UNIT OPTION

C1

DESCRIPTION

OEM Remote status (Lock/Unlock) monitoring

IF THE VEHICLE IS NOT EQUIPPED WITH FUNCTIONAL HOOD PIN:

A11

OFF

Hood trigger (Output Status).



Parts required (Not included)

1x THAR-FOR3

NOTES



The vehicle must be equipped with the OEM remote with the door locks.

MANDATORY INSTALL

***HOOD PIN**



HOOD STATUS: THE HOOD PIN SWITCH MUST BE INSTALLED IF THE VEHICLE CAN BE REMOTE STARTED WITH THE HOOD OPEN, SET FUNCTION **A11** TO OFF.

A11

OFF

Notice: the installation of safety elements are mandatory. The hood pin is an essential security element and must be installed.

THIS MODULE MUST BE INSTALLED BY A QUALIFIED TECHNICIAN. A WRONG CONNECTION CAN CAUSE PERMANENT DAMAGE TO THE VEHICLE.

DESCRIPTION



② Parking Lights switch

① Gateway module, located at dash board driver's side,

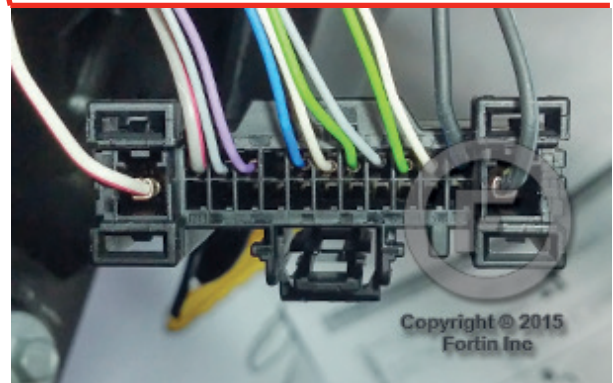
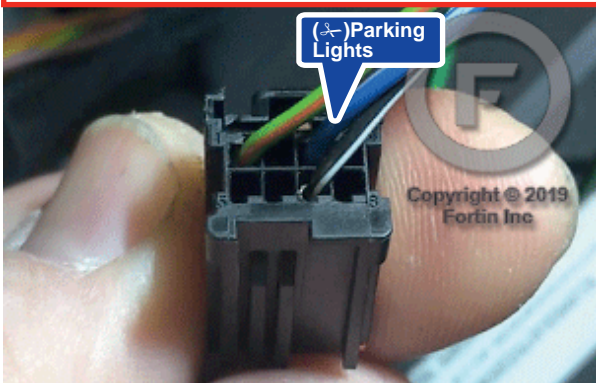

④ Under the hood If not equipped with hood pin.

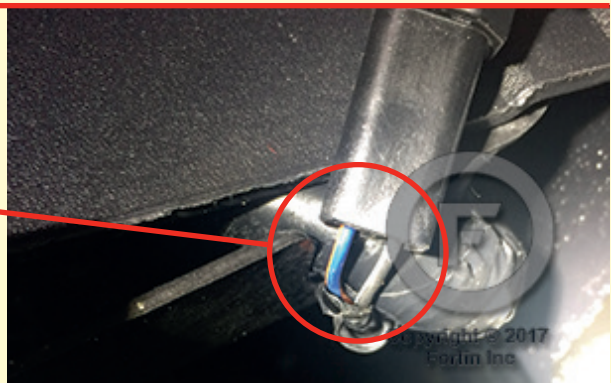

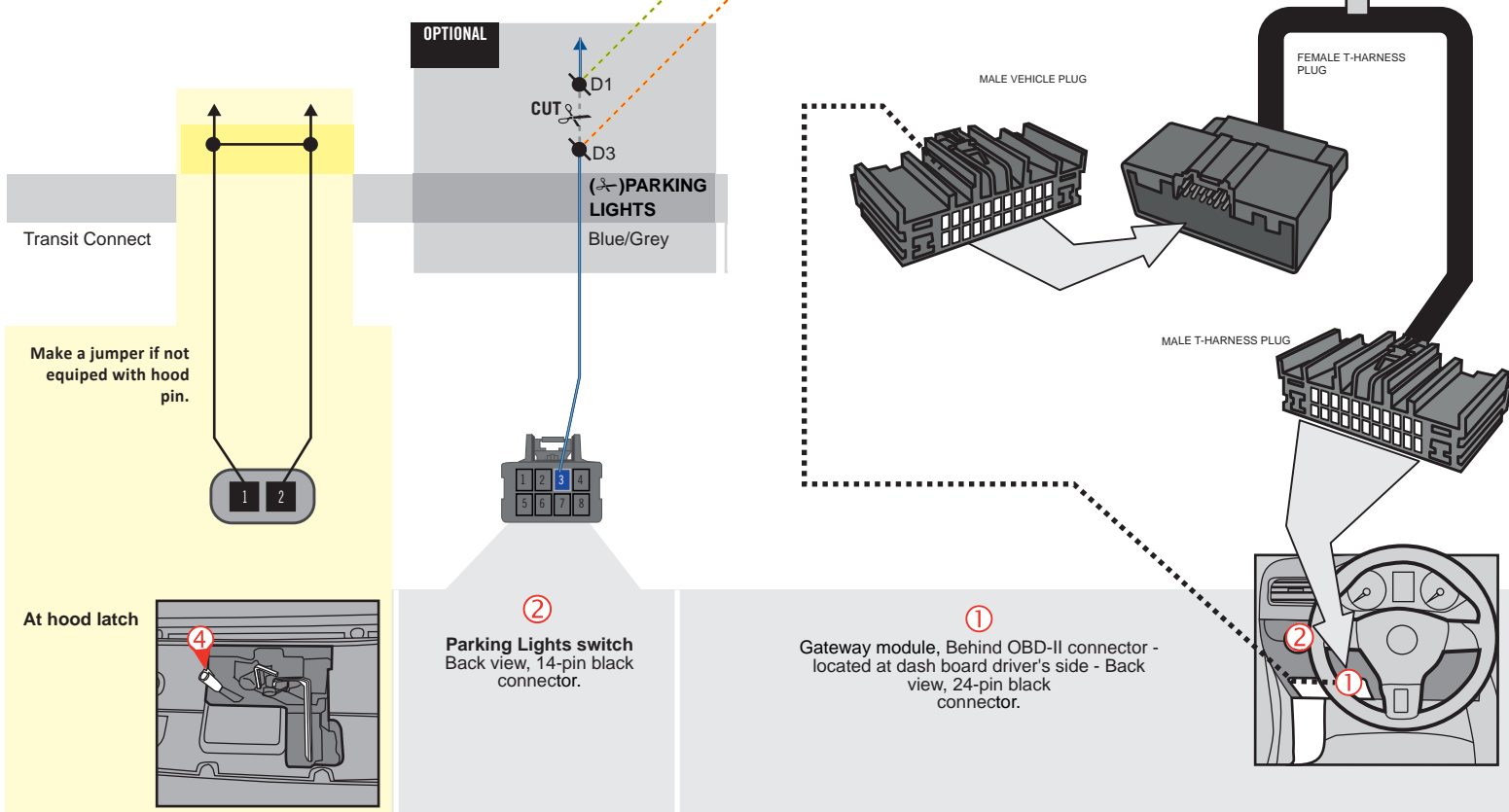
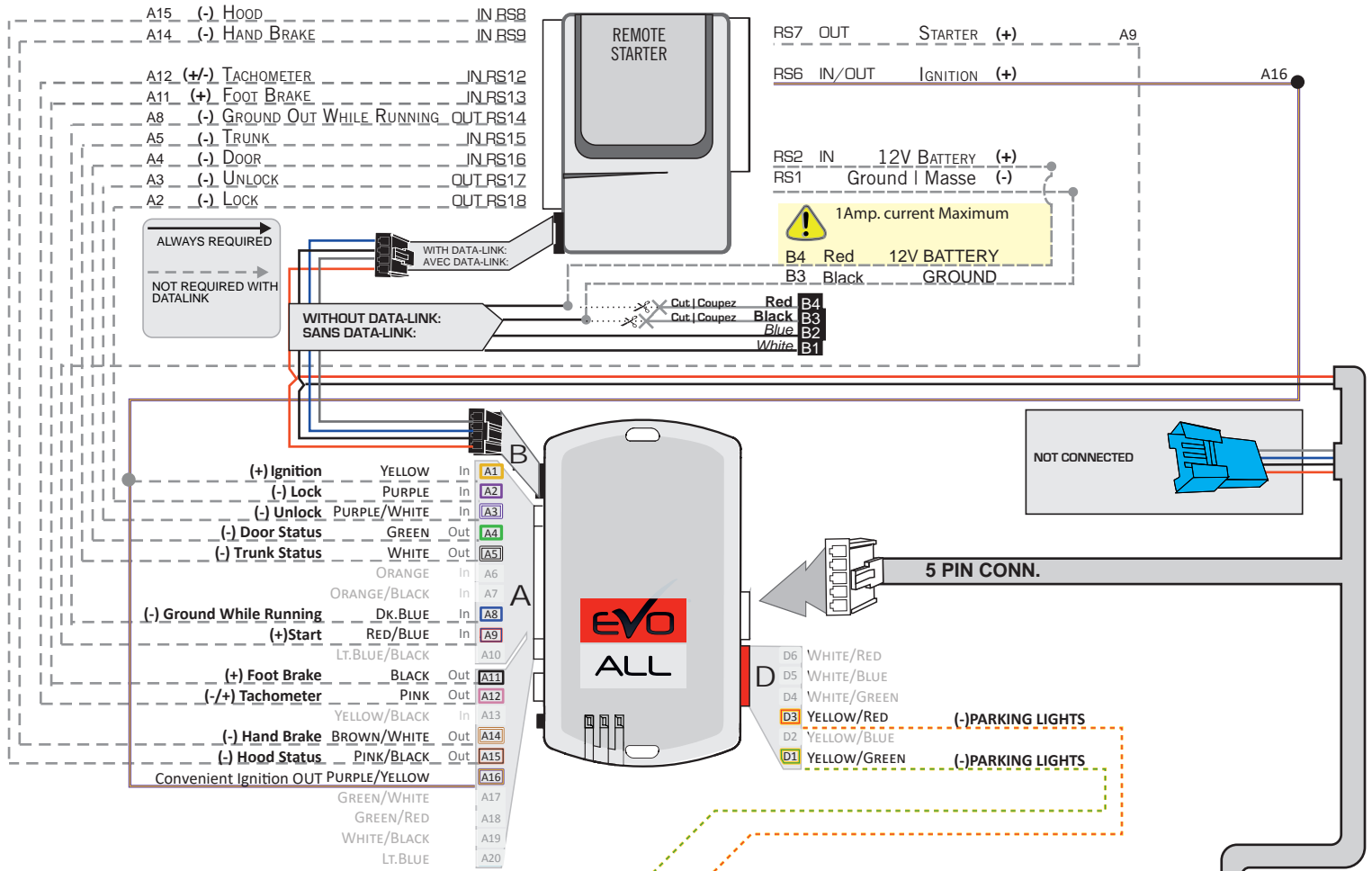

KEY BYPASS PROGRAMMING PROCEDURE 1/2

1

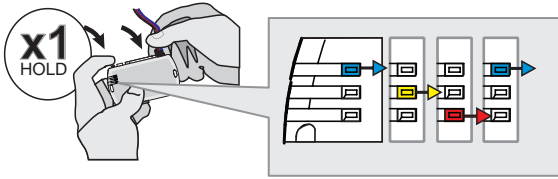

Press and hold the programming button:
Insert the 4-Pin (Data-Link) connector.

↳ The Blue, Red, Yellow and Blue & Red LEDs will alternatively illuminate.

2

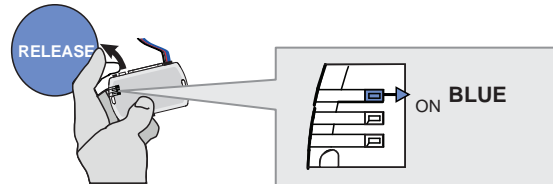

Release the programming button when the LED is BLUE.

If the LED is not solid BLUE disconnect the 4-Pin connector (Data-Link) and go back to step 1.

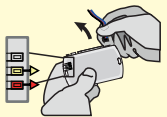

3

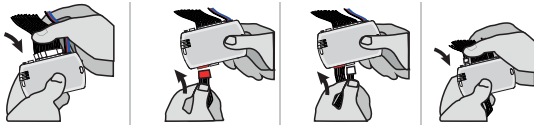

Insert the required remaining connectors.

4

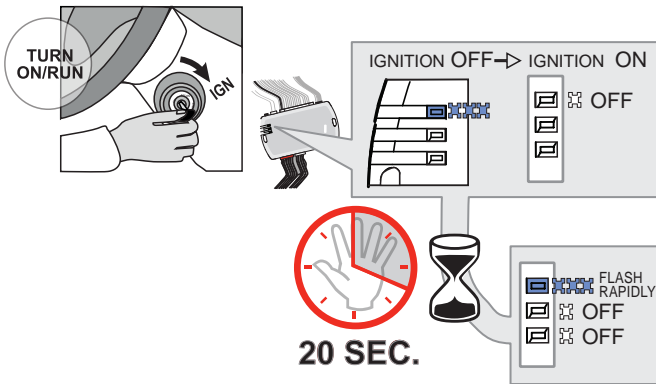

Turn the key to the Ignition ON/RUN position.

↳ The BLUE LED will turn OFF.

↳ The BLUE LED will flash rapidly.

5

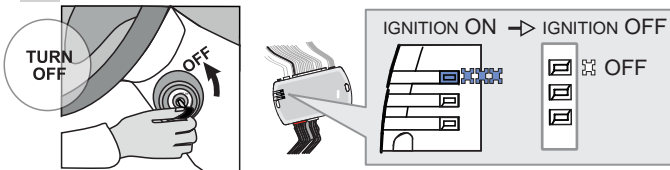

Turn the key to the OFF position.

↳ The BLUE LED will turn off.

6

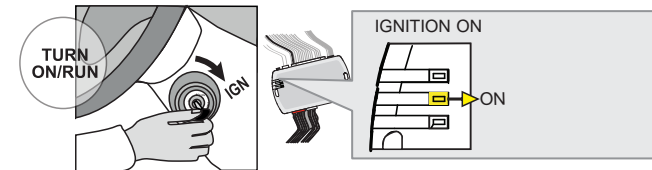

Turn the key to the Ignition ON/RUN position.

↳ The YELLOW LED will turn ON.

7



Wait 5 seconds.

KEY BYPASS PROGRAMMING PROCEDURE 2/2

8

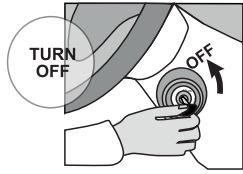

Turn the key to the OFF position.



The module is now programmed.

REMOTE STARTER FUNCTIONALITY



All doors must be closed.



Remote start the vehicle.



Unlock the doors with the remote-starter remote or the OEM remote.

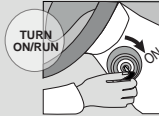

Insert and Turn the key to the Ignition ON/RUN position.



Press the brake pedal.



The vehicle can now be put in to gear and driven.

THAR-FOR3 THARNNESS STAND ALONE INSTALLATION

ADDENDUM - SUGGESTED WIRING CONFIGURATION



ONLY COMPATIBLE WITH AUTOMATIC TRANSMISSION VEHICLES.



Vehicle functions supported in this diagram (functional if equipped)

VEHICLE	YEARS	Immobilizer bypass	T-Harness	Lock	Unlock	Arm	Disarm	RAP Disable	Parking Lights	Tachometer	Door Status	Trunk Status	Hood Status*	Hand-Brake Status	Foot-Brake Status	Active OEM Remote Start
FORD EcoSport	key 2018-2020	•	•	•	•	•	•	•	•	•	•	•	•	•	•	•



FIRMWARE VERSION

4.02

ONLY - SEULEMENT

To add the firmware version and the options, use the **FLASH LINK UPDATER** or **FLASH LINK MOBILE** tool, sold separately.



Program bypass option:

UNIT OPTION

C1

DESCRIPTION

OEM Remote status (Lock/Unlock) monitoring

IF THE VEHICLE IS NOT EQUIPPED WITH FUNCTIONAL HOOD PIN:

A11

OFF

Hood trigger (Output Status).



Parts required (Not included)

1x THAR-FOR3

NOTES

The vehicles OEM remote and SmartKey are still operable during remote start.



The vehicle must be equipped with the OEM remote with the door locks.

MANDATORY INSTALL

***HOOD PIN**



HOOD STATUS: THE HOOD PIN SWITCH MUST BE INSTALLED IF THE VEHICLE CAN BE REMOTE STARTED WITH THE HOOD OPEN, SET FUNCTION A11 TO OFF.

A11

OFF

Notice: the installation of safety elements are mandatory. The hood pin is an essential security element and must be installed.

THIS MODULE MUST BE INSTALLED BY A QUALIFIED TECHNICIAN. A WRONG CONNECTION CAN CAUSE PERMANENT DAMAGE TO THE VEHICLE.

PARTS REQUIRED (NOT INCLUDED)

1x **FLASH LINK UPDATER,**
1x **FLASH LINK MANAGER**
SOFTWARE | PROGRAMME
1x Microsoft Windows Computer with Internet connection

OR

1x **FLASH LINK MOBILE**
1x **FLASH LINK MOBILE APP**
Smartphone Android or iOS with Internet connection (provider charges may apply).

MANDATORY

HOOD PIN



REMOTE START SAFETY OVERRIDE SWITCH

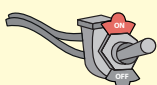







VALET SWITCH

Part #: RSPB available, Sold separately.

Notice: the installation of safety elements are mandatory. The hood pin and the valet switch are essential security elements and must be installed.

STAND ALONE CONFIGURATION

	Program bypass option	UNIT OPTION	DESCRIPTION
	OEM Remote Stand Alone Remote Starter:	D1.10 	By default, LOCK, LOCK, LOCK Par défaut, VERROUILLE, VERROUILLE, VERROUILLE
		D1.1 	
	Program bypass option with oem remote:	C1	OEM Remote Monitoring
	Program bypass option with RF KIT antenna:	H1 to H6	Supported RF Kits and select RF Kit
	Program bypass option Vehicle hybrid only:	D4	Hybrid mode (Vehicle hybrid only)

REMOTE STARTER FUNCTIONALITY



All doors must be closed.

3X 

Press the OEM remote's Lock button 3x to remote-start (or remote-stop) the vehicle.



START 

The vehicle will START.

REMOTE STARTER DIAGNOSTICS
MODULE RED LED

x2 flash :	Brake ON
x3 flash :	No tach
x4 flash :	Ignition before start
x5 flash :	Hood Open

REMOTE STARTER WARNING CARD



CUT THIS WARNING CARD AND STICK IT ON A VISIBLE PLACE:
or use the package RSPB, Sold separately.

WARNING



REMOTE STARTER

THE VEHICLE CAN BE STARTED BY EITHER: PRESSING THE LOCK BUTTON ON THE OEM REMOTE 3 TIMES CONSECUTIVELY OR BY A SMARTPHONE. **TURN ON** THE SAFETY SWITCH LOCATED UNDER THE DASHBOARD BEFORE WORKING ON THE VEHICLE.

DESCRIPTION

③ Behind glove box



① Gateway module, Behind OBD-II connector

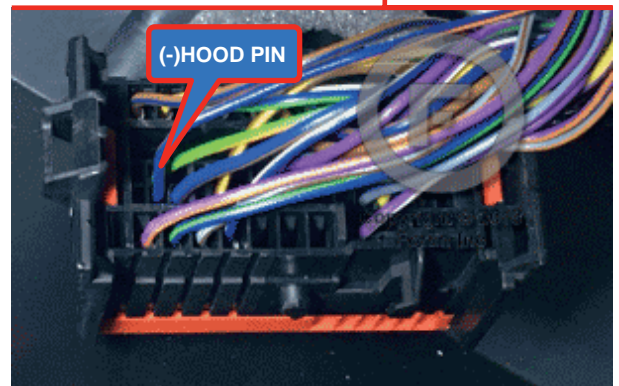
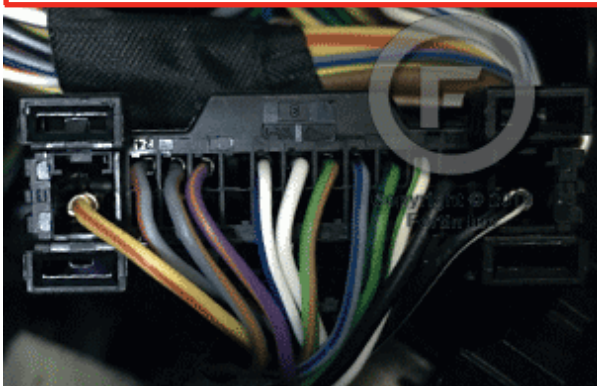
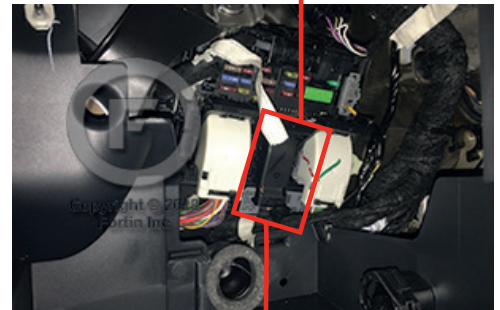
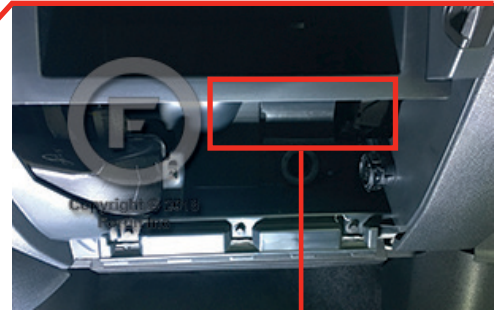

AUTOMATIC TRANSMISSION WIRING CONNECTION

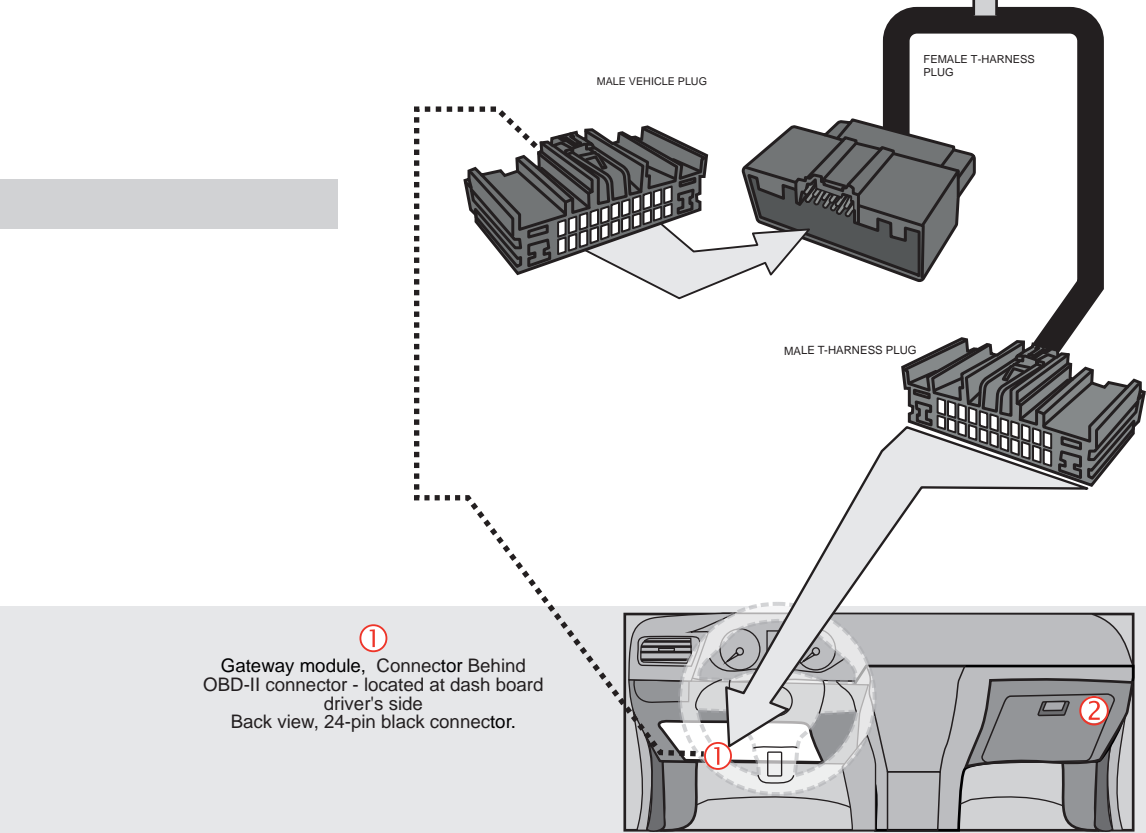
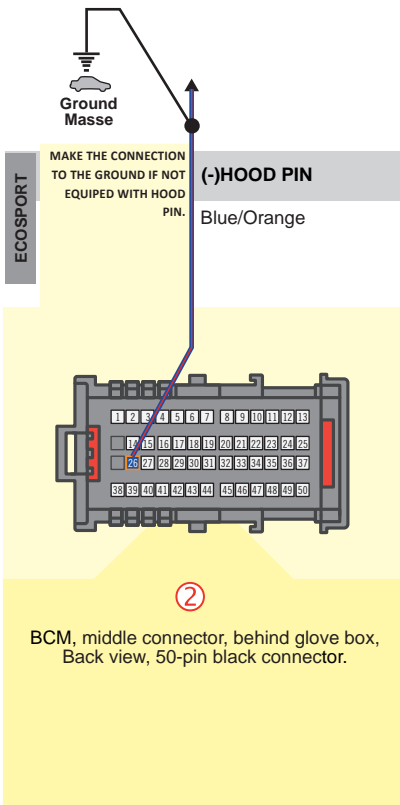
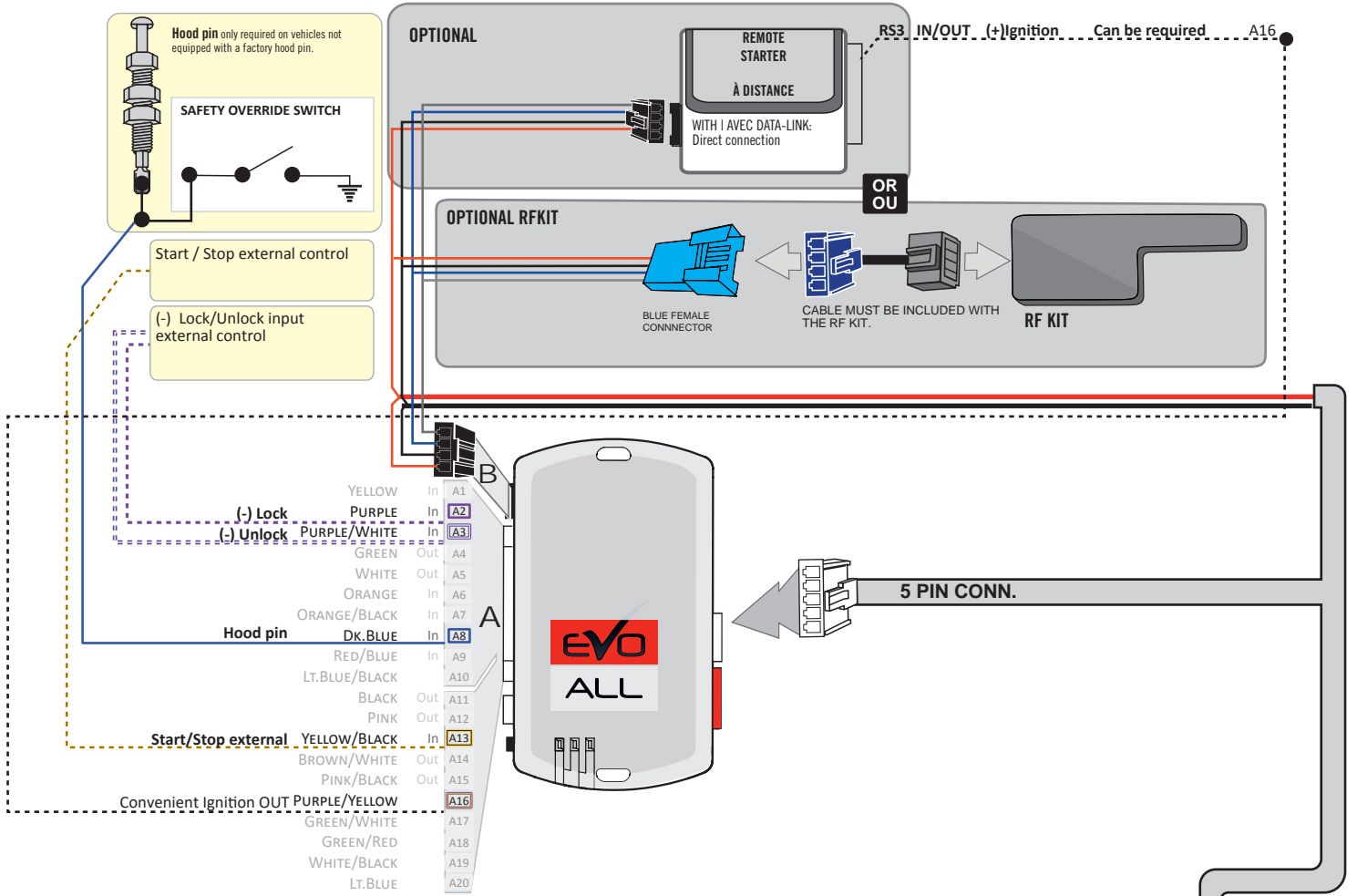

KEY BYPASS PROGRAMMING PROCEDURE 1/2

1

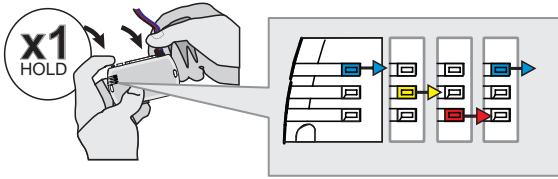

Press and hold the programming button:
Insert the 4-Pin (Data-Link) connector.

↳ The Blue, Red, Yellow and Blue & Red LEDs will alternatively illuminate.

2

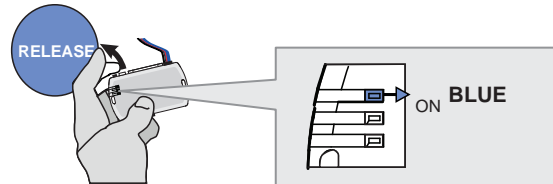

Release the programming button when the LED is BLUE.

If the LED is not solid BLUE disconnect the 4-Pin connector (Data-Link) and go back to step 1.

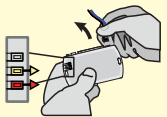

3

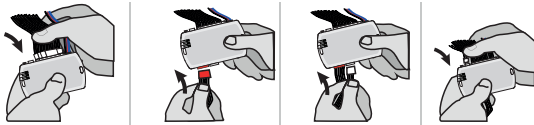

Insert the required remaining connectors.

4

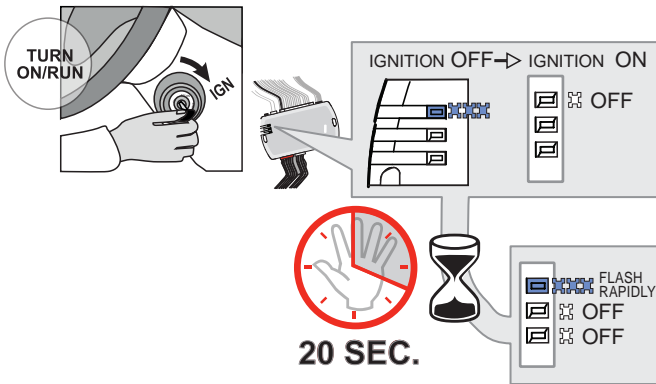

Turn the key to the Ignition ON/RUN position.

↳ The BLUE LED will turn OFF.

↳ The BLUE LED will flash rapidly.

5

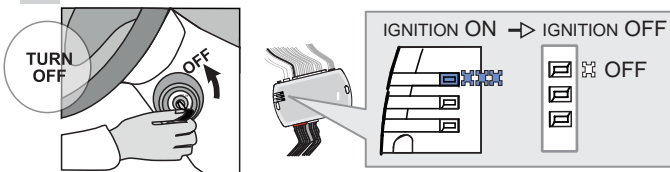

Turn the key to the OFF position.

↳ The BLUE LED will turn off.

6

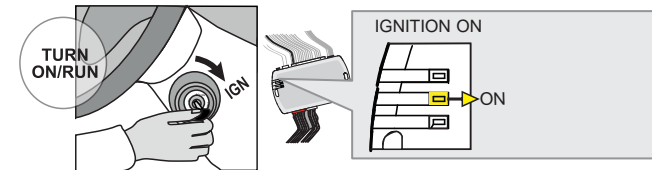

Turn the key to the Ignition ON/RUN position.

↳ The YELLOW LED will turn ON.

7



Wait 5 seconds.

KEY BYPASS PROGRAMMING PROCEDURE 2/2

8

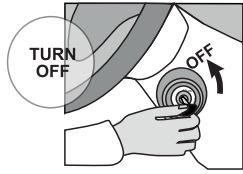

Turn the key to the OFF position.



The module is now programmed.

OPTIONAL RF-KIT PROGRAMMING

PROGRAM BYPASS OPTION

	<p>Program bypass option:</p>	<p>H2</p>	<p>Supported RF-KITS enable H2 Fortin 2</p>
---	-------------------------------	------------------	--

OPTIONAL FORTIN RF KIT SERIES 4 OR SERIES 9 PROGRAMMING

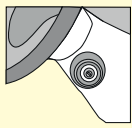

The module must be programmed on the vehicle.

MAKE SURE THE IGNITION KEY HAS BEEN IN THE OFF POSITION FOR AT LEAST 5 SECONDS.

1

ON **TURN ON/RUN**

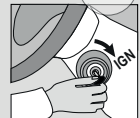

Turn the key to the ON/RUN position.

2

OFF **TURN OFF**



Turn the ignition to the OFF position.

3

ON **TURN ON/RUN**



Turn the key to the ON/RUN position.

4

4X BRAKES

x4 PRESS



Press and release the brake pedal four times.

5

ON EACH TRANSMITTER

4 BUTTONS

[-] PRESS AND RELEASE

→ PRESS AND RELEASE

1 BUTTON

PRESS APPROX. 12 SEC. AND WAIT FOR THE BLUE LED TO TURN OFF THEN BACK ON SOLID THEN RELEASE.

6

OFF **TURN OFF**



Turn the ignition to the OFF position.

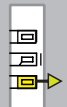

The YELLOW LED will turn ON solid.



The YELLOW LED will turn Off.



The YELLOW LED will turn ON solid.

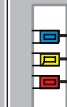

The 3 LED will turn ON solid.



The LED will flash rapidly.

Le témoin clignotera rapidement.



The 3 LED will turn off.



REMOTE STARTER FUNCTIONALITY



All doors must be closed.



Remote start the vehicle.



Unlock the doors with the remote-starter remote or the OEM remote.



Insert and Turn the key to the Ignition ON/RUN position.



Press the brake pedal.



The vehicle can now be put in to gear and driven.

THAR-FOR3 THARNESSTAND ALONE INSTALLATION

ADDENDUM - SUGGESTED WIRING CONFIGURATION



ONLY COMPATIBLE WITH AUTOMATIC TRANSMISSION VEHICLES.



Vehicle functions supported in this diagram (functional if equipped)

VEHICLE	YEARS	Immobilizer bypass	T-Harness	Lock	Unlock	Arm	Disarm	RAP Disable	Parking Lights	Tachometer	Door Status	Trunk Status	Hood Status*	Hand-Brake Status	Foot-Brake Status	Active OEM Remote Start
FORD EcoSport	<i>Push-to-Start</i> 2018-2020	•	•	•	•	•	•	•	•	•	•	•	•	•	•	•

FIRMWARE VERSION

4.02

ONLY - SEULEMENT

To add the firmware version and the options, use the **FLASH LINK UPDATER** or **FLASH LINK MOBILE** tool, sold separately.

	UNIT OPTION	DESCRIPTION
<p>Program bypass option:</p>	C1	OEM Remote status (Lock/Unlock) monitoring
	D6	Push-to-Start
<p>IF THE VEHICLE IS NOT EQUIPPED WITH FUNCTIONAL HOOD PIN:</p>	A11	OFF
		Hood trigger (Output Status).



Parts required (Not included)

1x THAR-FOR3

NOTES

The vehicles OEM remote and SmartKey are still operable during remote start.

MANDATORY INSTALL

*HOOD PIN



HOOD STATUS: THE HOOD PIN SWITCH MUST BE INSTALLED IF THE VEHICLE CAN BE REMOTE STARTED WITH THE HOOD OPEN, SET FUNCTION A11 TO OFF.

A11

OFF

Notice: the installation of safety elements are mandatory. The hood pin is an essential security element and must be installed.

THIS MODULE MUST BE INSTALLED BY A QUALIFIED TECHNICIAN. A WRONG CONNECTION CAN CAUSE PERMANENT DAMAGE TO THE VEHICLE.

PARTS REQUIRED (NOT INCLUDED)

1x **FLASH LINK UPDATER, FLASH LINK MANAGER**
SOFTWARE | PROGRAMME
1x Microsoft Windows Computer with Internet connection
Ordinateur Microsoft Windows

OR

1x **FLASH LINK MOBILE, FLASH LINK MOBILE APP**
Smartphone Android or iOS with Internet connection (provider charges may apply).

MANDATORY

HOOD PIN



REMOTE START SAFETY OVERRIDE SWITCH

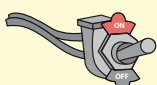







VALET SWITCH

Part #: RSPB available, Sold separately.

Notice: the installation of safety elements are mandatory. The hood pin and the valet switch are essential security elements and must be installed.

STAND ALONE CONFIGURATION

	Program bypass option	UNIT OPTION	DESCRIPTION
	OEM Remote Stand Alone Remote Starter:	D1.10 	By default, LOCK, LOCK, LOCK Par défaut, VERROUILLE, VERROUILLE, VERROUILLE
		D1.1 	
	Program bypass option with oem remote:	C1	OEM Remote Monitoring
	Program bypass option with RF KIT antenna:	H1 to H6	Supported RF Kits and select RF Kit
	Program bypass option Vehicle hybrid only:	D4	Hybrid mode (Vehicle hybrid only)

REMOTE STARTER FUNCTIONALITY



All doors must be closed.

3X 

Press the OEM remote's Lock button 3x to remote-start (or remote-stop) the vehicle.



START 

The vehicle will START.

REMOTE STARTER DIAGNOSTICS
MODULE RED LED

x2 flash :	Brake ON
x3 flash :	No tach
x4 flash :	Ignition before start
x5 flash :	Hood Open

REMOTE STARTER WARNING CARD



CUT THIS WARNING CARD AND STICK IT ON A VISIBLE PLACE:
or use the package RSPB, Sold separately.

WARNING



REMOTE STARTER

THE VEHICLE CAN BE STARTED BY EITHER: PRESSING THE LOCK BUTTON ON THE OEM REMOTE 3 TIMES CONSECUTIVELY OR BY A SMARTPHONE. **TURN ON** THE SAFETY SWITCH LOCATED UNDER THE DASHBOARD BEFORE WORKING ON THE VEHICLE.

DESCRIPTION

③ Behind glove box



① Gateway module, Behind OBD-II connector

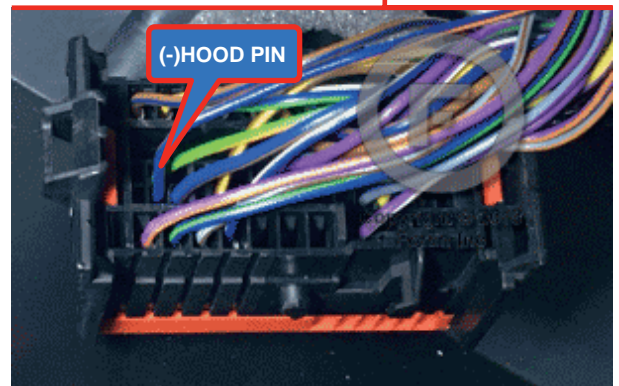
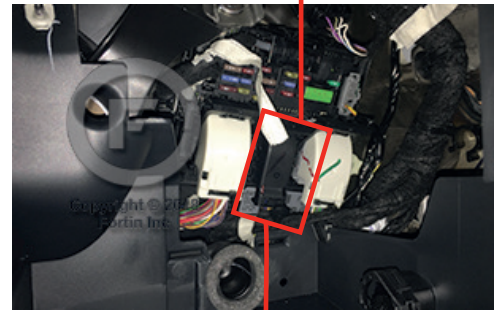
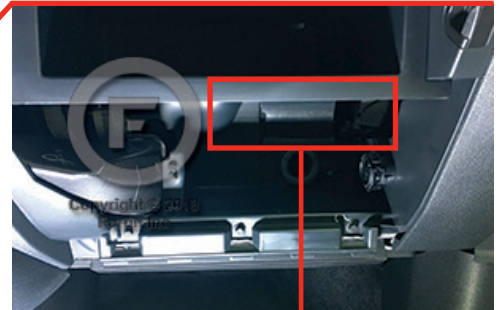
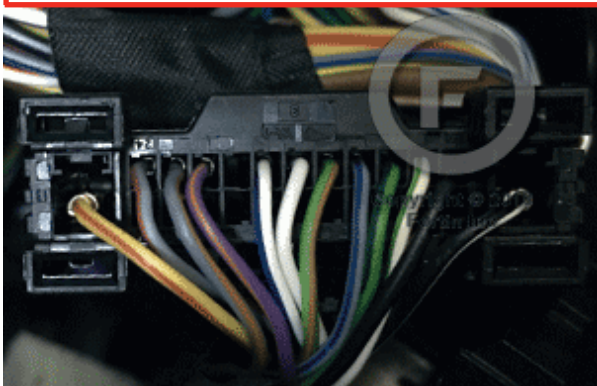

AUTOMATIC TRANSMISSION WIRING CONNECTION

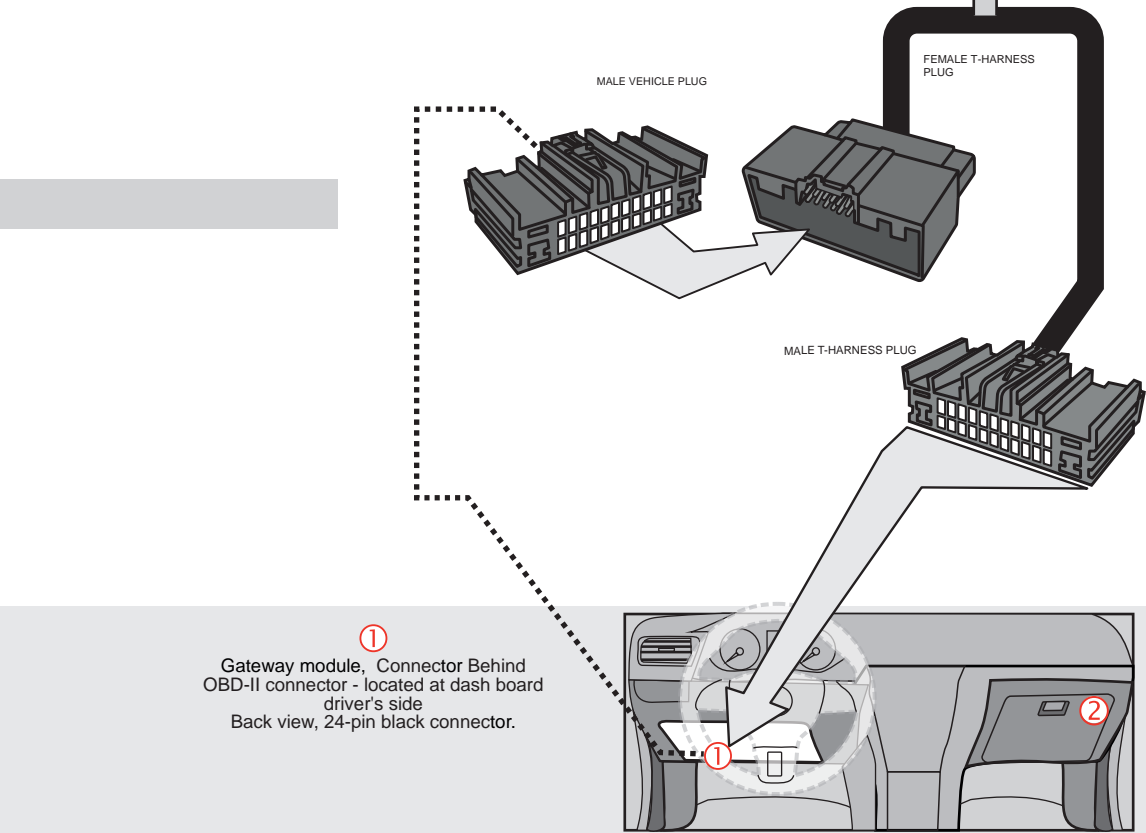
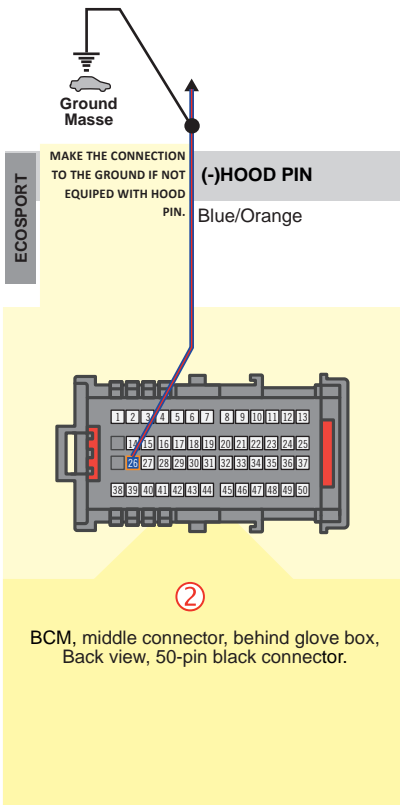
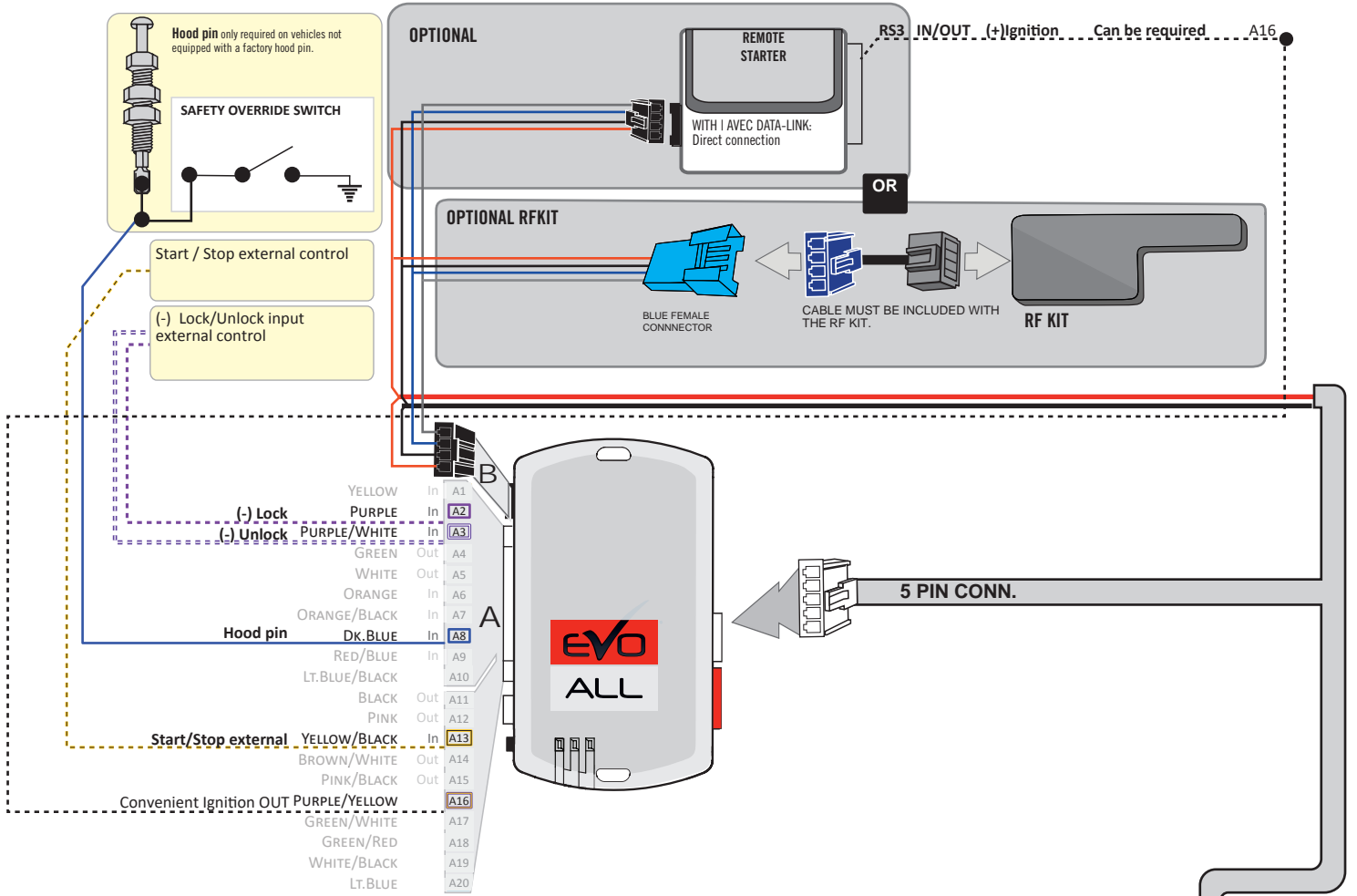

KEY BYPASS PROGRAMMING PROCEDURE 1/2

1

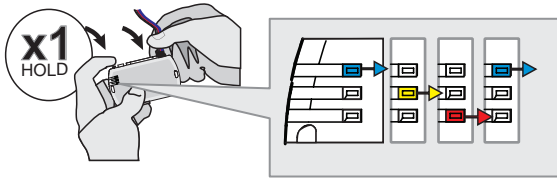

Press and hold the programming button:
Insert the 4-Pin (Data-Link) connector.

↳ The Blue, Red, Yellow and Blue & Red LEDs will alternatively illuminate.

2

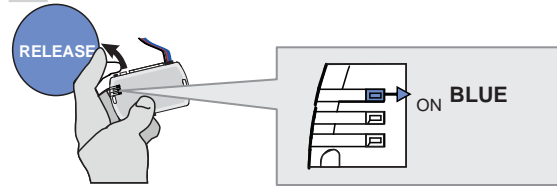

Release the programming button when the LED is BLUE.

If the LED is not solid BLUE disconnect the 4-Pin connector (Data-Link) and go back to step 1.

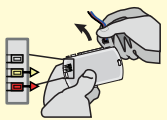

3

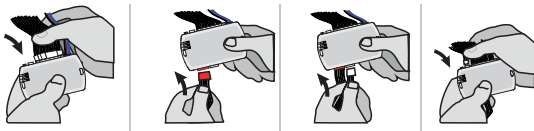

Insert the required remaining connectors.

4

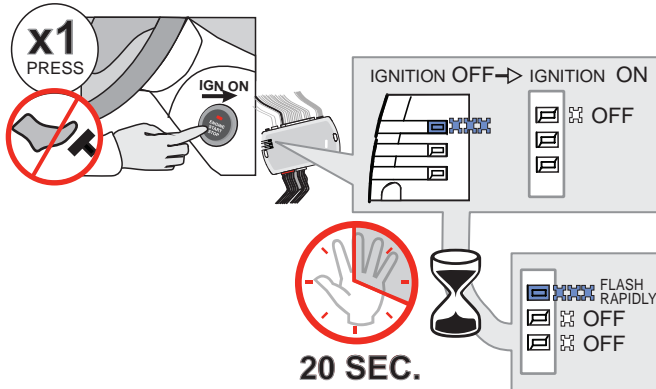

Do not press the brake pedal.
Press the Push-to-Start button once to turn on the ignition.

↳ The BLUE LED will turn OFF.

↳ The BLUE LED will flash rapidly.

5

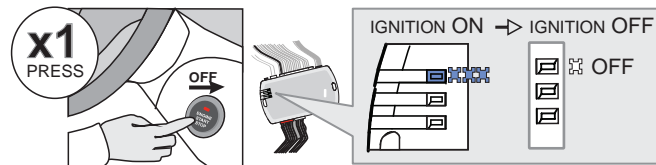

Press the Push-to-Start button once to turn off the ignition.

↳ The BLUE LED will turn off.

6

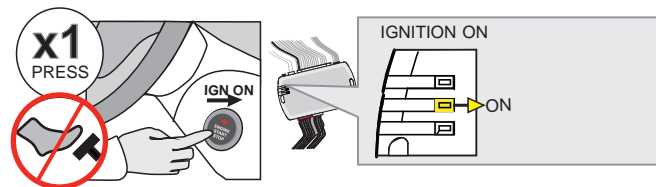

Do not press the brake pedal.
Press the Push-to-Start button once to turn on the ignition.

↳ The YELLOW LED will turn ON.

KEY BYPASS PROGRAMMING PROCEDURE 2/2

7



Wait 5 seconds.

8

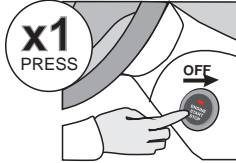

Press the Push-to-Start button once to turn off the ignition.

The module is now programmed.

OPTIONAL RF-KIT PROGRAMMING

PROGRAM BYPASS OPTION

	<p>Program bypass option:</p>	<p>H2</p>	<p>Supported RF-KITS enable H2 Fortin 2</p>
---	-------------------------------	------------------	--











OPTIONAL FORTIN RF KIT SERIES 4 OR SERIES 9 PROGRAMMING



The module must be programmed on the vehicle.

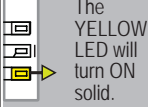
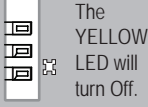
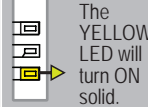
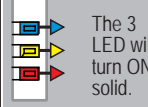

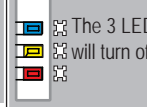
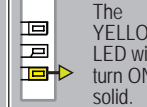
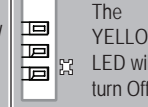
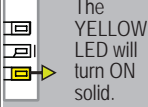
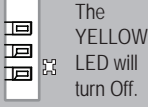
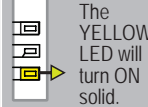
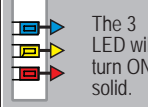

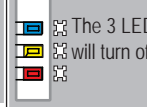
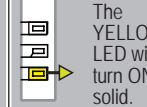
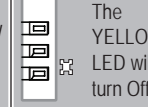

MAKE SURE THE IGNITION KEY HAS BEEN IN THE OFF POSITION FOR AT LEAST 5 SECONDS.

<p>1</p> <p>ON x1 PRESS</p>  <p>Do not press the brake pedal. Press the Push-to-Start button once to turn on the ignition.</p>	<p>2</p> <p>OFF x1 PRESS</p>  <p>Press the Push-to-Start button once to turn off the ignition.</p>	<p>3</p> <p>ON x1 PRESS</p>  <p>Do not press the brake pedal. Press the Push-to-Start button once to turn on the ignition.</p>	<p>4</p> <p>4X BRAKES</p> <p>x4 PRESS</p>  <p>Press and release the brake pedal four times.</p>	<p>5</p> <p>ON EACH TRANSMITTER</p> <p>4 BUTTONS</p> <p>[-] PRESS AND RELEASE</p> <p>→ PRESS AND RELEASE</p> <p>1 BUTTON</p> <p>PRESS APPROX. 12 SEC. AND WAIT FOR THE BLUE LED TO TURN OFF THEN BACK ON SOLID THEN RELEASE.</p>	<p>6</p> <p>OFF x1 PRESS</p>  <p>Press the Push-to-Start button once to turn off the ignition.</p>	<p>7</p> <p>ON x1 PRESS</p>  <p>Do not press the brake pedal. Press the Push-to-Start button once to turn on the ignition and leave it ON for 5 sec..</p>	<p>8</p> <p>OFF x1 PRESS</p>  <p>Press the Push-to-Start button once to turn off the ignition.</p>
 <p>The YELLOW LED will turn ON solid.</p>	 <p>The YELLOW LED will turn Off.</p>	 <p>The YELLOW LED will turn ON solid.</p>	 <p>The LED will flash rapidly.</p>	 <p>The LED will turn off each time.</p>	 <p>The LED will turn Off.</p>	 <p>The YELLOW LED will turn ON solid.</p>	 <p>The YELLOW LED will turn Off.</p>
 <p>The YELLOW LED will turn ON solid.</p>	 <p>The YELLOW LED will turn Off.</p>	 <p>The YELLOW LED will turn ON solid.</p>	 <p>The 3 LED will turn ON solid.</p>	 <p>The LED will flash rapidly.</p>	 <p>The 3 LED will turn off.</p>	 <p>The YELLOW LED will turn ON solid.</p>	 <p>The YELLOW LED will turn Off.</p>

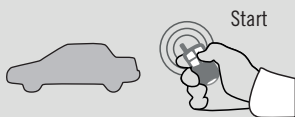

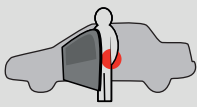
REMOTE STARTER FUNCTIONALITY

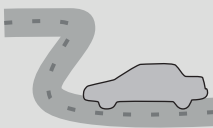
 <p>Start</p> <p>All doors must be closed.</p> <p>Remote start the vehicle.</p>	 <p>UNLOCK</p> <p>Unlock the doors with either:</p> <ul style="list-style-type: none"> • The OEM remote • The remote-starter remote • Or the proximity remote 	 <p>Enter the vehicle with the SMART-KEY.</p>	 <p>DO NOT PRESS THE BRAKE PEDAL.</p> <p>Press and release the Push-to-Start button once.</p>	 <p>Press the brake pedal. The vehicle can now be put in to gear and driven.</p> <p>If the Smart-Key is not detected the vehicle will shut down.</p>
--	---	--	---	---

THAR-FOR3 THARNNESS STAND ALONE INSTALLATION

ADDENDUM - SUGGESTED WIRING CONFIGURATION



ONLY COMPATIBLE WITH AUTOMATIC TRANSMISSION VEHICLES.



Vehicle functions supported in this diagram (functional if equipped)

VEHICLE

YEARS

Immobilizer bypass	Lock	Unlock	Arm	Disarm	RAP Disable	Parking Lights	Tachometer	Heated seats	Heated Mirrors	Rear defrost	Door Status	Trunk Status	Hood Status*	Hand-Brake Status	Foot-Brake Status	Active OEM Remote Start
--------------------	------	--------	-----	--------	-------------	----------------	------------	--------------	----------------	--------------	-------------	--------------	--------------	-------------------	-------------------	-------------------------

FORD

Edge	Push-to-Start 2015-2019	•	•	•	•	•	•	•	•	•	•	•	•	•	•	•
------	-------------------------	---	---	---	---	---	---	---	---	---	---	---	---	---	---	---

LINCOLN

MKX	Push-to-Start 2017	•	•	•	•	•	•	•	•	•	•	•	•	•	•	•
-----	--------------------	---	---	---	---	---	---	---	---	---	---	---	---	---	---	---



FIRMWARE VERSION

4.01

ONLY - SEULEMENT

To add the firmware version and the options, use the **FLASH LINK UPDATER** or **FLASH LINK MOBILE** tool, sold separately.



Program bypass option:

UNIT OPTION

DESCRIPTION

C1

OEM Remote status (Lock/Unlock) monitoring

D6

Push-to-Start

IF THE VEHICLE IS NOT EQUIPPED WITH FUNCTIONAL HOOD PIN:

A11

OFF

Hood trigger (Output Status).



Parts required (Not included)

1x THAR-FOR3

MANDATORY INSTALL

*HOOD PIN



HOOD STATUS: THE HOOD PIN SWITCH MUST BE INSTALLED IF THE VEHICLE CAN BE REMOTE STARTED WITH THE HOOD OPEN, SET FUNCTION **A11** TO OFF.

A11

OFF

Notice: the installation of safety elements are mandatory. The hood pin is an essential security element and must be installed.

THIS MODULE MUST BE INSTALLED BY A QUALIFIED TECHNICIAN. A WRONG CONNECTION CAN CAUSE PERMANENT DAMAGE TO THE VEHICLE.

PARTS REQUIRED (NOT INCLUDED)

1x **FLASH LINK UPDATER, FLASH LINK MANAGER**
SOFTWARE | PROGRAMME
1x Microsoft Windows Computer with Internet connection
Ordinateur Microsoft Windows avec connection Internet

OR

1x **FLASH LINK MOBILE, FLASH LINK MOBILE APP**
Smartphone Android or iOS with Internet connection (provider charges may apply).

MANDATORY

HOOD PIN



REMOTE START SAFETY OVERRIDE SWITCH









VALET SWITCH

Part #: RSPB available, Sold separately.

Notice: the installation of safety elements are mandatory. The hood pin and the valet switch are essential security elements and must be installed.

STAND ALONE CONFIGURATION

	Program bypass option	UNIT OPTION	DESCRIPTION
	OEM Remote Stand Alone Remote Starter:	OR D1.10  D1.1 	By default, LOCK, LOCK, LOCK Par défaut, VERROUILLE, VERROUILLE, VERROUILLE
	Program bypass option with oem remote:	C1	OEM Remote Monitoring
	Program bypass option with RF KIT antenna:	H1 to H6	Supported RF Kits and select RF Kit
	Program bypass option Vehicle hybrid only:	D4	Hybrid mode (Vehicle hybrid only)

REMOTE STARTER FUNCTIONALITY



All doors must be closed.

3X 

Press the OEM remote's Lock button 3x to remote-start (or remote-stop) the vehicle.



START

The vehicle will START.

REMOTE STARTER DIAGNOSTICS
MODULE RED LED

x2 flash :	Brake ON
x3 flash :	No tach
x4 flash :	Ignition before start
x5 flash :	Hood Open

REMOTE STARTER WARNING CARD



CUT THIS WARNING CARD AND STICK IT ON A VISIBLE PLACE:
or use the package RSPB, Sold separately.

WARNING | ATTENTION



REMOTE STARTER

THE VEHICLE CAN BE STARTED BY EITHER: PRESSING THE LOCK BUTTON ON THE OEM REMOTE 3 TIMES CONSECUTIVELY OR BY A SMARTPHONE. **TURN ON** THE SAFETY SWITCH LOCATED UNDER THE DASHBOARD BEFORE WORKING ON THE VEHICLE.

DESCRIPTION



② Parking Lights switch

① Gateway module, located at right of steering column.

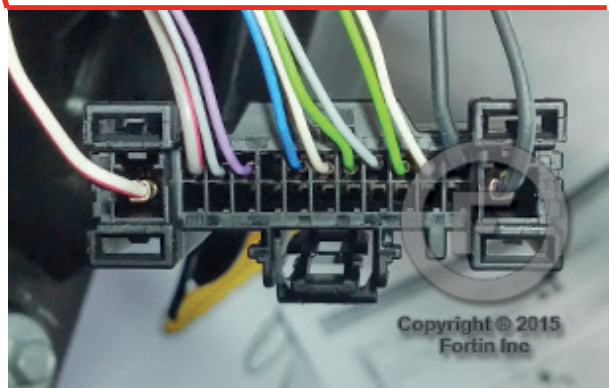
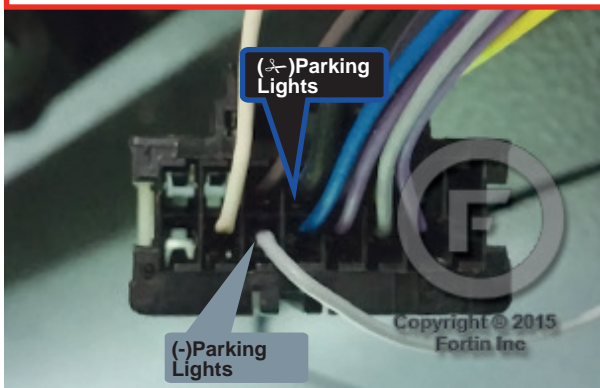

AUTOMATIC TRANSMISSION WIRING CONNECTION

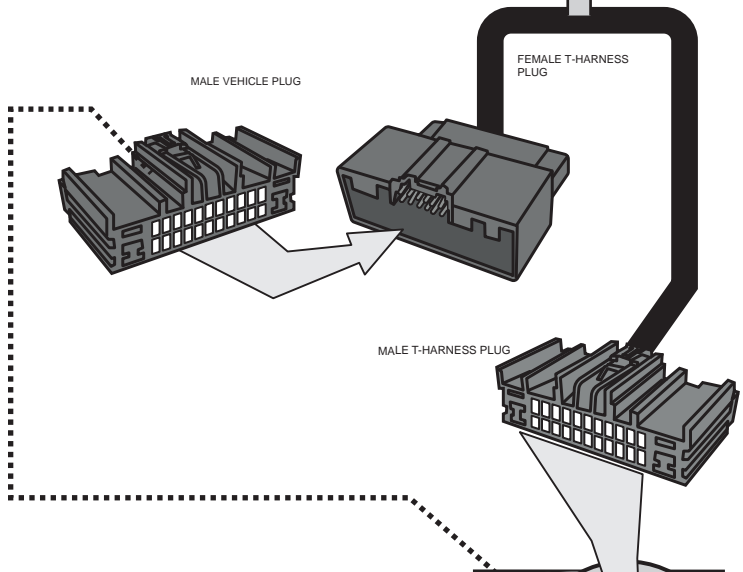
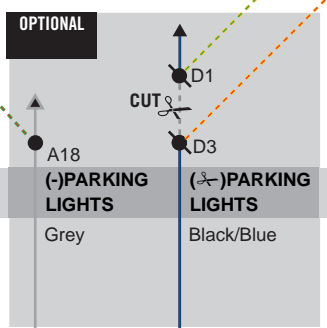
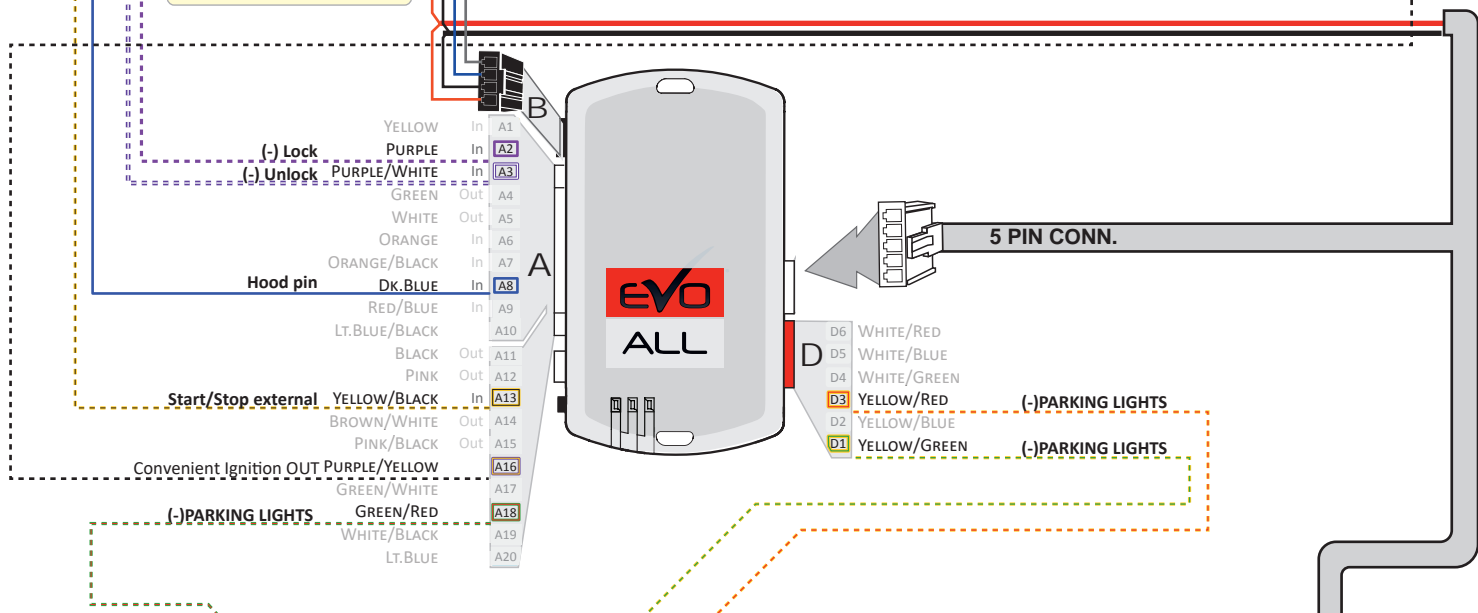
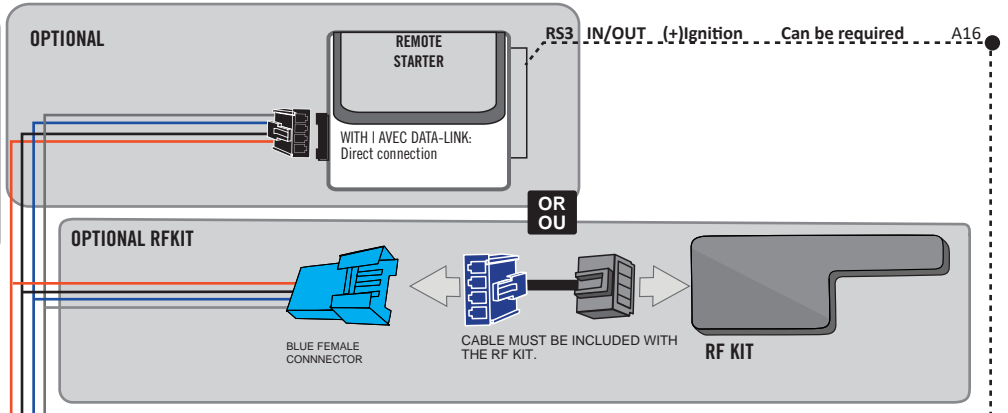
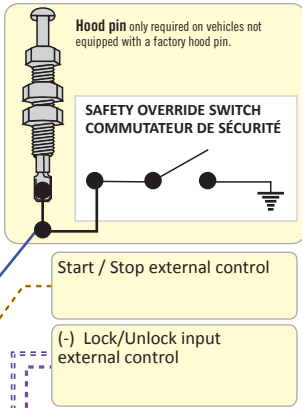

② Parking Lights switch
Back view, 14-pin black connector.

① Gateway module, located at right of steering column, Back view, 24-pin black connector.

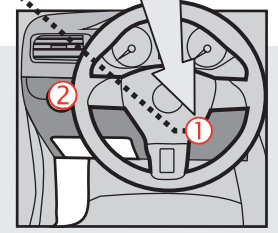

PROGRAMMING PROCEDURE

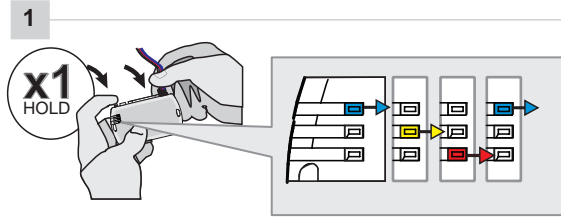

Press and hold the programming button:
Insert the 4-Pin (Data-Link) connector.

↳ The Blue, Red, Yellow and Blue & Red LEDs will alternatively illuminate.

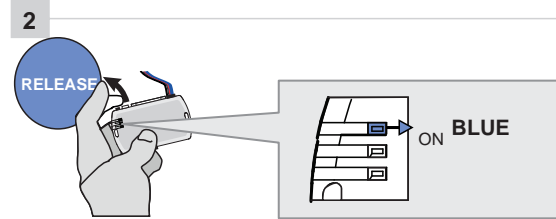

Release the programming button when the LED is BLUE.

If the LED is not solid BLUE disconnect the 4-Pin connector (Data-Link) and go back to step 1.

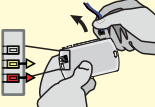
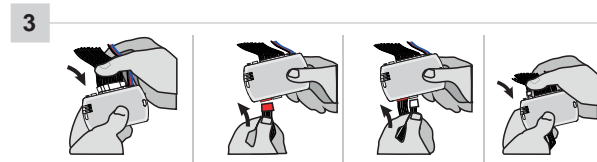

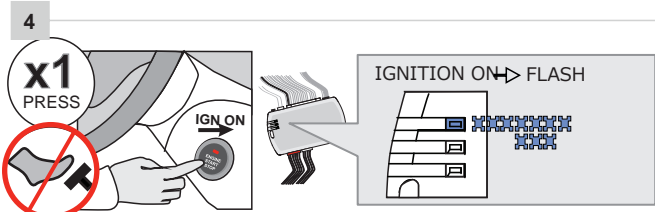

Insert the required remaining connectors.

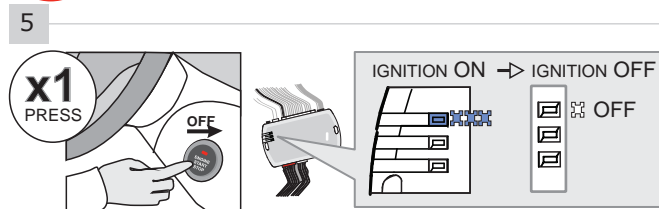

Do not press the brake pedal.
Press the Push-to-Start button once to turn on the ignition.

↳ The BLUE LED will flash rapidly.



Press the Push-to-Start button once to turn off the ignition.

↳ The BLUE LED will turn off.

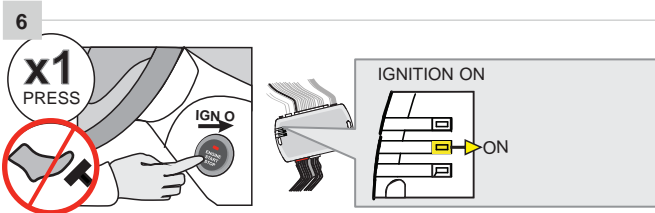

Do not press the brake pedal.
Press the Push-to-Start button once to turn on the ignition.

↳ The YELLOW LED will turn ON.

7



Wait 5 seconds.

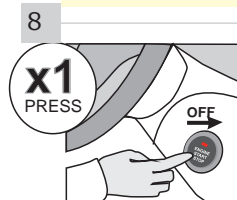

Press the Push-to-Start button once to turn off the ignition.



The module is now programmed.

OPTIONAL RF-KIT PROGRAMMING



PROGRAM BYPASS OPTION

	<p>Program bypass option:</p>	<p>H2</p>	<p>Supported RF-KITS enable H2 Fortin 2</p>
---	-------------------------------	------------------	--

OPTIONAL FORTIN RF KIT SERIES 4 OR SERIES 9 PROGRAMMING



The module must be programmed on the vehicle.

MAKE SURE THE IGNITION KEY HAS BEEN IN THE OFF POSITION FOR AT LEAST 5 SECONDS.

1

ON **x1** PRESS



Do not press the brake pedal. Press the Push-to-Start button once to turn on the ignition.

2

OFF **x1** PRESS



Press the Push-to-Start button once to turn off the ignition.

3

ON **x1** PRESS



Do not press the brake pedal. Press the Push-to-Start button once to turn on the ignition.

4

4X BRAKES

x4 PRESS



Press and release the brake pedal four times.

The LED will turn off each time.

5

ON EACH TRANSMITTER

4 BUTTONS

[-] PRESS AND RELEASE

→ PRESS AND RELEASE

LOCK PRESS AND RELEASE

1 BUTTON

PRESS APPROX. 12 SEC. AND WAIT FOR THE BLUE LED

6

OFF **x1** PRESS



Press the Push-to-Start button once to turn off the ignition.

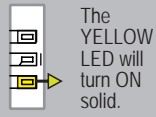

The YELLOW LED will turn ON solid.

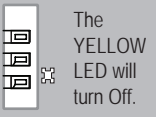

The YELLOW LED will turn Off.

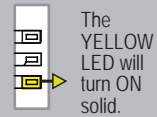

The YELLOW LED will turn ON solid.

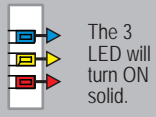

The 3 LED will turn ON solid.





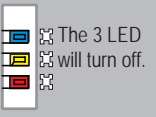

The LED will flash rapidly.



The 3 LED will turn off.

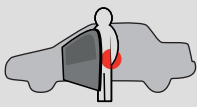

REMOTE STARTER FUNCTIONALITY

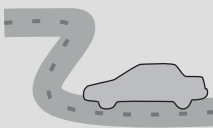
 <p>Start</p> <p>All doors must be closed.</p> <p>Remote start the vehicle.</p>	 <p>UNLOCK</p> <p>Unlock the doors with either:</p> <ul style="list-style-type: none"> • The OEM remote • The remote-starter remote • Or the proximity remote 	 <p>Enter the vehicle with the SMART-KEY.</p>	 <p>x1 PRESS</p> <p>DO NOT PRESS THE BRAKE PEDAL.</p> <p>Press and release the Push-to-Start button once.</p>	 <p>Press the brake pedal. The vehicle can now be put in to gear and driven.</p> <p>If the Smart-Key is not detected the vehicle will shut down.</p>
--	---	--	---	---

THAR-FOR3 THARNNESS STAND ALONE INSTALLATION

ADDENDUM - SUGGESTED WIRING CONFIGURATION



ONLY COMPATIBLE WITH AUTOMATIC TRANSMISSION VEHICLES.



Vehicle functions supported in this diagram (functional if equipped)

VEHICLE

YEARS

Immobilizer bypass	Lock	Unlock	Arm	Disarm	RAP Disable	Parking Lights	Tachometer	Heated seats	Heated Mirrors	Rear defrost	Door Status	Trunk Status	Hood Status*	Hand-Brake Status	Foot-Brake Status	Active OEM Remote Start
--------------------	------	--------	-----	--------	-------------	----------------	------------	--------------	----------------	--------------	-------------	--------------	--------------	-------------------	-------------------	-------------------------

FORD

Edge	Key 2015-2019	•	•	•	•	•	•	•	•	•	•	•	•	•	•	•
------	---------------	---	---	---	---	---	---	---	---	---	---	---	---	---	---	---

FIRMWARE VERSION

4.01

ONLY - SEULEMENT

To add the firmware version and the options, use the **FLASH LINK UPDATER** or **FLASH LINK MOBILE** tool, sold separately.

	UNIT OPTION	DESCRIPTION
	C1	<p>Program bypass option:</p> <p>OEM Remote status (Lock/Unlock) monitoring</p>

<p>IF THE VEHICLE IS NOT EQUIPPED WITH FUNCTIONAL HOOD PIN:</p>	A11	OFF	<p>Hood trigger (Output Status).</p>
--	------------	------------	--------------------------------------



Parts required (Not included)

1x THAR-FOR3



The vehicle must be equipped with the OEM remote with the door locks.

MANDATORY INSTALL

*HOOD PIN



HOOD STATUS: THE HOOD PIN SWITCH MUST BE INSTALLED IF THE VEHICLE CAN BE REMOTE STARTED WITH THE HOOD OPEN, SET FUNCTION A11 TO OFF.

A11

OFF

Notice: the installation of safety elements are mandatory. The hood pin is an essential security element and must be installed.

THIS MODULE MUST BE INSTALLED BY A QUALIFIED TECHNICIAN. A WRONG CONNECTION CAN CAUSE PERMANENT DAMAGE TO THE VEHICLE.

PARTS REQUIRED (NOT INCLUDED)

1x **FLASH LINK UPDATER,**
1x **FLASH LINK MANAGER**
SOFTWARE | PROGRAMME
1x Microsoft Windows Computer with Internet connection

OR

1x **FLASH LINK MOBILE**
1x **FLASH LINK MOBILE APP**
Smartphone *Android* or *iOS* with Internet connection (*provider charges may apply*).

MANDATORY

HOOD PIN



REMOTE START SAFETY OVERRIDE SWITCH

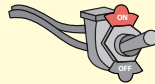

VALET SWITCH

Part #: RSPB available, Sold separately.

Notice: the installation of safety elements are mandatory. The hood pin and the valet switch are essential security elements and must be installed.

STAND ALONE CONFIGURATION

	Program bypass option	UNIT OPTION	DESCRIPTION
	OEM Remote Stand Alone Remote Starter:	D1.10	By default, LOCK, LOCK, LOCK
		D1.1	Par défaut, VERROUILLE, VERROUILLE, VERROUILLE
	Program bypass option with oem remote:	C1	OEM Remote Monitoring
	Program bypass option with RF KIT antenna:	H1 to H6	Supported RF Kits and select RF Kit
	Program bypass option Vehicle hybrid only:	D4	Hybrid mode (Vehicle hybrid only)

REMOTE STARTER FUNCTIONALITY

All doors must be closed.

3X

Press the OEM remote's Lock button 3x to remote-start (or remote-stop) the vehicle.

START

The vehicle will START.

REMOTE STARTER DIAGNOSTICS
MODULE RED LED

x2 flash :	Brake ON
x3 flash :	No tach
x4 flash :	Ignition before start
x5 flash :	Hood Open

REMOTE STARTER WARNING CARD



CUT THIS WARNING CARD AND STICK IT ON A VISIBLE PLACE:
or use the package RSPB, Sold separately.

WARNING | ATTENTION

REMOTE STARTER

THE VEHICLE CAN BE STARTED BY EITHER: PRESSING THE LOCK BUTTON ON THE OEM REMOTE 3 TIMES CONSECUTIVELY OR BY A SMARTPHONE. **TURN ON** THE SAFETY SWITCH LOCATED UNDER THE DASHBOARD BEFORE WORKING ON THE VEHICLE.

DESCRIPTION



② Parking Lights switch

① Gateway module, located at right of steering column.

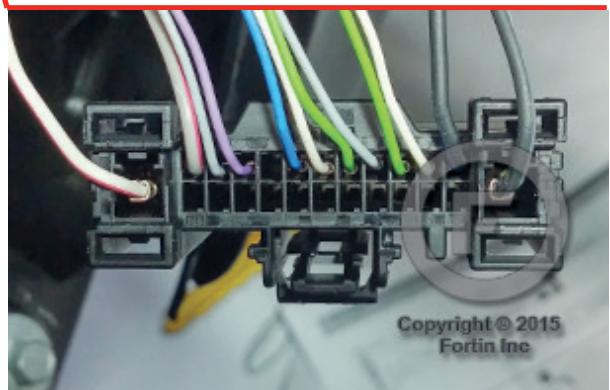
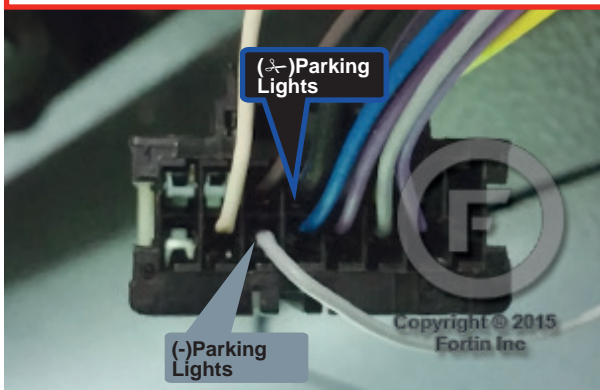

AUTOMATIC TRANSMISSION WIRING CONNECTION

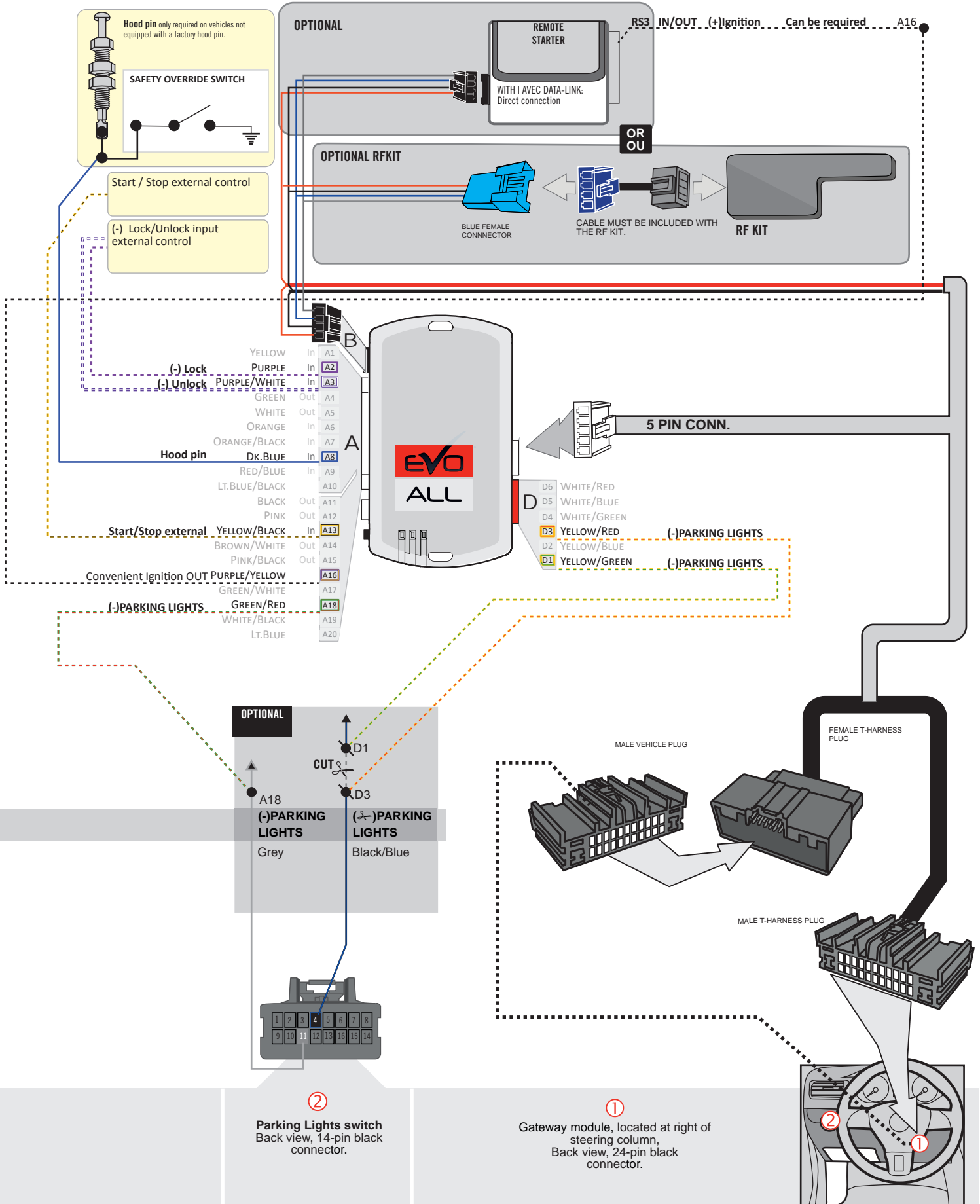

PROGRAMMING PROCEDURE

1

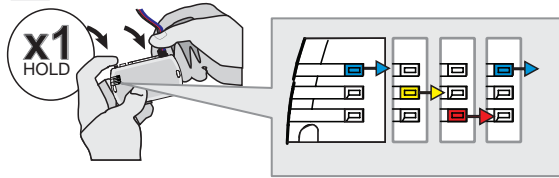

Press and hold the programming button:
Insert the 4-Pin (Data-Link) connector.

↳ The Blue, Red, Yellow and Blue & Red LEDs will alternatively illuminate.

2

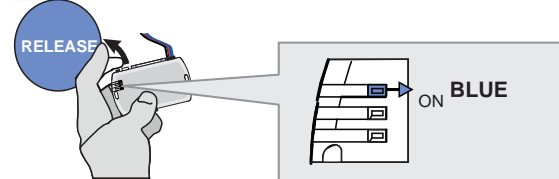

Release the programming button when the LED is BLUE.

If the LED is not solid BLUE disconnect the 4-Pin connector (Data-Link) and go back to step 1.

3

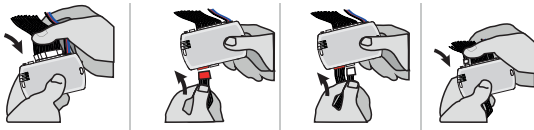

Insert the required remaining connectors.

4

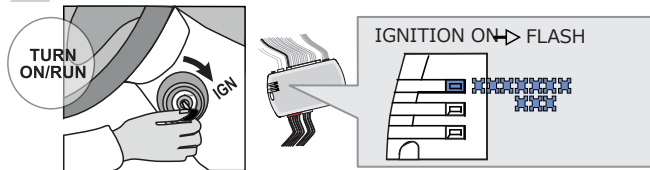

Turn the key to the Ignition ON/RUN position.

↳ The BLUE LED will flash rapidly.

5

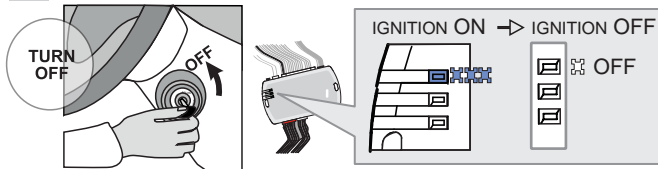

Turn the key to the OFF position.

↳ The BLUE LED will turn off.

6

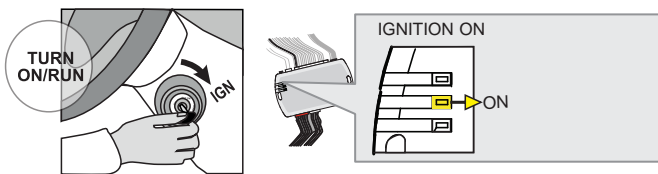

Turn the key to the Ignition ON/RUN position.

↳ The YELLOW LED will turn ON.

7

Wait 5 seconds.

8

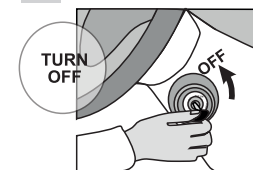

Turn the key to the OFF position.

The module is now programmed.







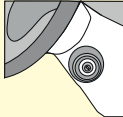



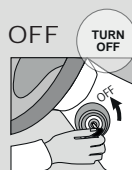

	<p>Program bypass option:</p>	<p>H2</p>	<p>Supported RF-KITS enable H2 Fortin 2</p>
---	-------------------------------	------------------	--

OPTIONAL FORTIN RF KIT SERIES 4 OR SERIES 9 PROGRAMMING

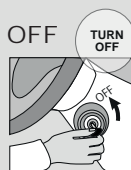
The module must be programmed on the vehicle.

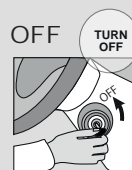
MAKE SURE THE IGNITION KEY HAS BEEN IN THE OFF POSITION FOR AT LEAST 5 SECONDS.

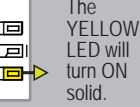
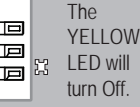
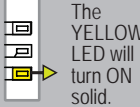
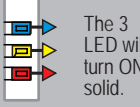
<p>1</p>  <p>ON (TURN ON/RUN)</p>	<p>2</p>  <p>OFF (TURN OFF)</p>	<p>3</p>  <p>ON (TURN ON/RUN)</p>	<p>4</p> <p>4X BRAKES</p>  <p>x4 PRESS</p>	<p>5</p> <p>ON EACH TRANSMITTER</p> <p>TÉLÉCOMMANDES</p> <p>4 BUTTONS</p> <p> PRESS AND RELEASE</p> <p> PRESS AND RELEASE</p> <p></p> <p>1 BUTTON</p> <p>PRESS APPROX. 12 SEC. AND WAIT FOR THE BLUE LED TO TURN OFF THEN BACK ON SOLID THEN RELEASE.</p>	<p>6</p>  <p>OFF (TURN OFF)</p>	<p>7</p>  <p>ON (TURN ON/RUN)</p>	<p>8</p>  <p>OFF (TURN OFF)</p>
<p>Turn the key to the ON/RUN position.</p>	<p>Turn the ignition to the OFF position.</p>	<p>Turn the key to the ON/RUN position.</p>	<p>Press and release the brake pedal four times.</p>	<p>The LED will turn off each time.</p>	<p>Turn the ignition to the OFF position.</p>	<p>Turn the key to the ON/RUN position and leave it ON for 5 sec.</p> 	<p>Turn the ignition to the OFF position.</p>
 <p>The YELLOW LED will turn ON solid.</p>	 <p>The YELLOW LED will turn Off.</p>	 <p>The YELLOW LED will turn ON solid.</p>	 <p>The 3 LED will turn ON solid.</p>	 <p>The LED will flash rapidly.</p>	 <p>The 3 LED will turn off.</p>	 <p>The YELLOW LED will turn ON solid.</p>	 <p>The YELLOW LED will turn Off.</p>
 <p>The 3 LED will turn off each time.</p>							

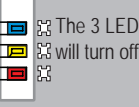
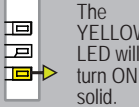
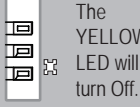
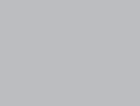

REMOTE STARTER FUNCTIONALITY



All doors must be closed.



Remote start the vehicle.



Unlock the doors with the remote-starter remote or the OEM remote.



Insert and Turn the key to the Ignition ON/RUN position.



Press the brake pedal.



The vehicle can now be put in to gear and driven.

THAR-FOR3 THARNNESS STAND ALONE INSTALLATION

ADDENDUM - SUGGESTED WIRING CONFIGURATION



ONLY COMPATIBLE WITH AUTOMATIC TRANSMISSION VEHICLES.



Vehicle functions supported in this diagram (functional if equipped)

VEHICLE	YEARS	Immobilizer bypass	Lock	Unlock	Armn	Disarm	RAP Disable	Parking Lights	Tachometer	Heated seats	Heated Mirrors	Rear defrost	Door Status	Trunk Status	Hood Status*	Hand-Brake Status	Foot-Brake Status	Active OEM Remote Start
FORD																		
Explorer	Key 2016-2019	•	•	•	•	•	•	•	•	•	•	•	•	•	•	•	•	•



FIRMWARE VERSION

4.01

ONLY - SEULEMENT

To add the firmware version and the options, use the **FLASH LINK UPDATER** or **FLASH LINK MOBILE** tool, sold separately.

UNIT OPTION	DESCRIPTION
C1	OEM Remote status (Lock/Unlock) monitoring

A11	OFF	Hood trigger (Output Status).
------------	-----	-------------------------------



Parts required (Not included)

1x THAR-FOR3



The vehicle must be equipped with the OEM remote with the door locks.

MANDATORY INSTALL

*HOOD PIN



HOOD STATUS: THE HOOD PIN SWITCH MUST BE INSTALLED IF THE VEHICLE CAN BE REMOTE STARTED WITH THE HOOD OPEN, SET FUNCTION A11 TO OFF.

A11

OFF

Notice: the installation of safety elements are mandatory. The hood pin is an essential security element and must be installed.

THIS MODULE MUST BE INSTALLED BY A QUALIFIED TECHNICIAN. A WRONG CONNECTION CAN CAUSE PERMANENT DAMAGE TO THE VEHICLE.

PARTS REQUIRED (NOT INCLUDED)

1x **FLASH LINK UPDATER,**
 1x **FLASH LINK MANAGER**
 SOFTWARE | PROGRAMME
 1x Microsoft Windows Computer with Internet connection

OR

1x **FLASH LINK MOBILE**
 1x **FLASH LINK MOBILE APP**
 Smartphone Android or iOS with Internet connection (provider charges may apply).

MANDATORY

HOOD PIN



REMOTE START SAFETY OVERRIDE SWITCH

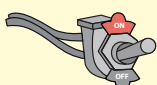







VALET SWITCH

Part #: RSPB available, Sold separately.

Notice: the installation of safety elements are mandatory. The hood pin and the valet switch are essential security elements and must be installed.

STAND ALONE CONFIGURATION

	Program bypass option	UNIT OPTION	DESCRIPTION
	OEM Remote Stand Alone Remote Starter:	D1.10 	By default, LOCK, LOCK, LOCK
		D1.1 	Par défaut, VERROUILLE, VERROUILLE, VERROUILLE
	Program bypass option with oem remote:	C1	OEM Remote Monitoring
	Program bypass option with RF KIT antenna:	H1 to H6	Supported RF Kits and select RF Kit
	Program bypass option Vehicle hybrid only:	D4	Hybrid mode (Vehicle hybrid only) Mode hybride (vehicule hybride seulement)

REMOTE STARTER FUNCTIONALITY



All doors must be closed.

3X 

Press the OEM remote's Lock button 3x to remote-start (or remote-stop) the vehicle.



START 

The vehicle will START.

REMOTE STARTER DIAGNOSTICS
MODULE RED LED

x2 flash :	Brake ON
x3 flash :	No tach
x4 flash :	Ignition before start
x5 flash :	Hood Open

REMOTE STARTER WARNING CARD



CUT THIS WARNING CARD AND STICK IT ON A VISIBLE PLACE:
 or use the package RSPB, Sold separately.

WARNING



REMOTE STARTER

THE VEHICLE CAN BE STARTED BY EITHER: PRESSING THE LOCK BUTTON ON THE OEM REMOTE 3 TIMES CONSECUTIVELY OR BY A SMARTPHONE. **TURN ON** THE SAFETY SWITCH LOCATED UNDER THE DASHBOARD BEFORE WORKING ON THE VEHICLE.

DESCRIPTION

② Parking Lights switch

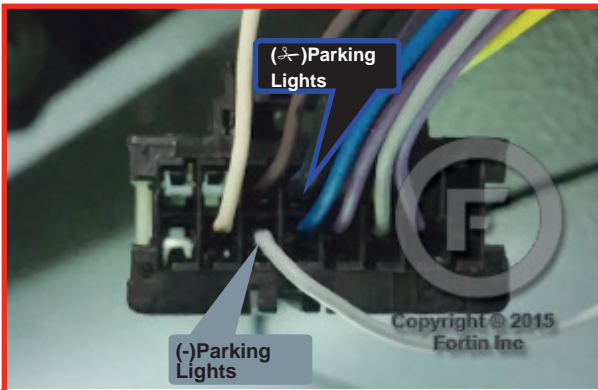

③ Fuse box

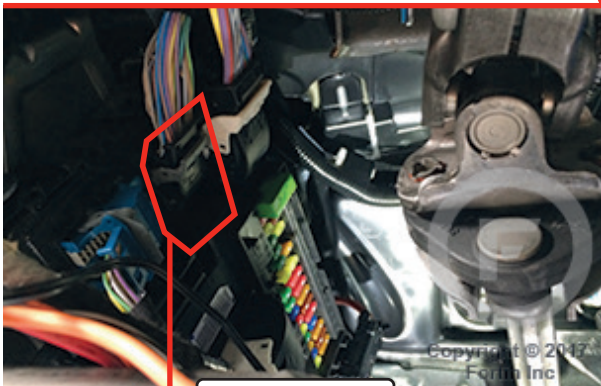

①

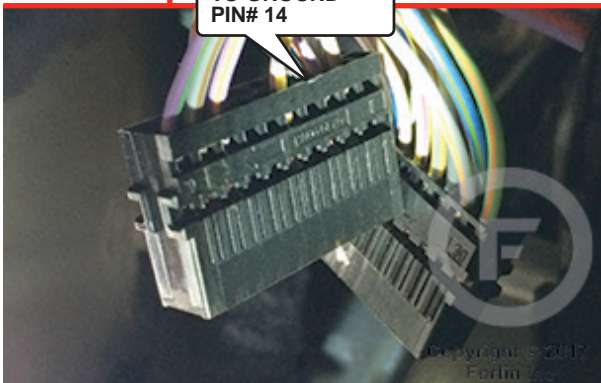
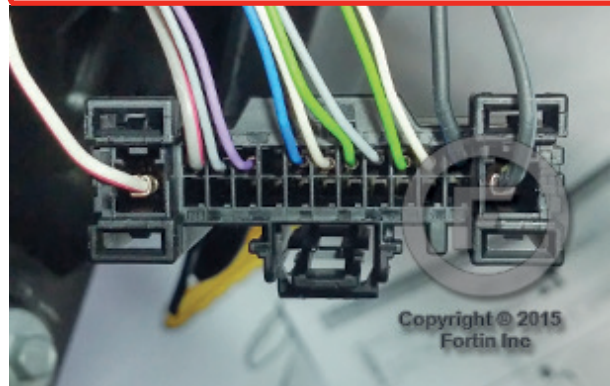

AUTOMATIC TRANSMISSION WIRING CONNECTION

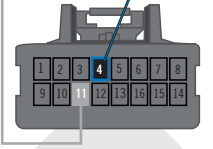
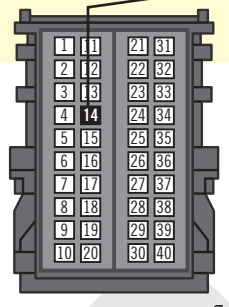
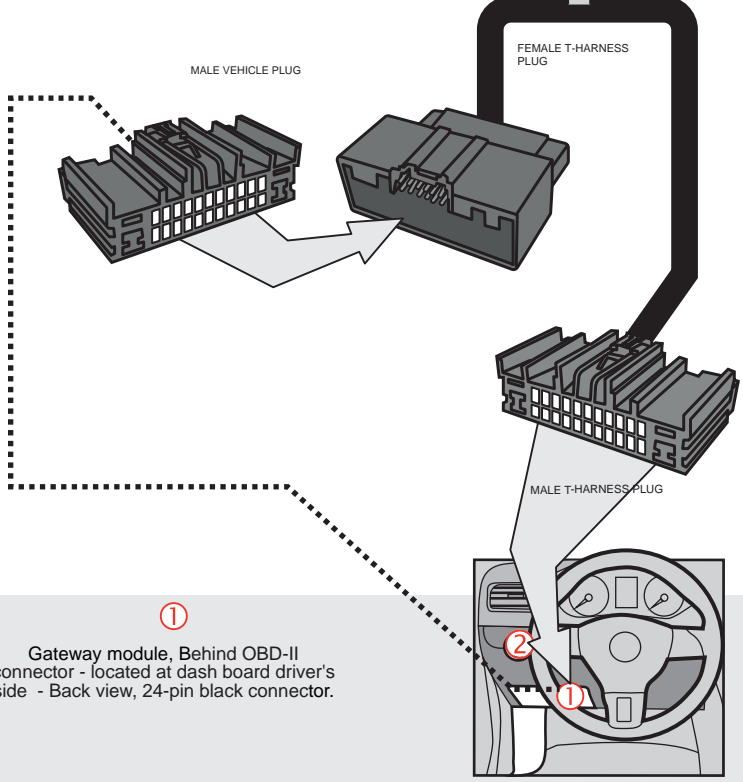
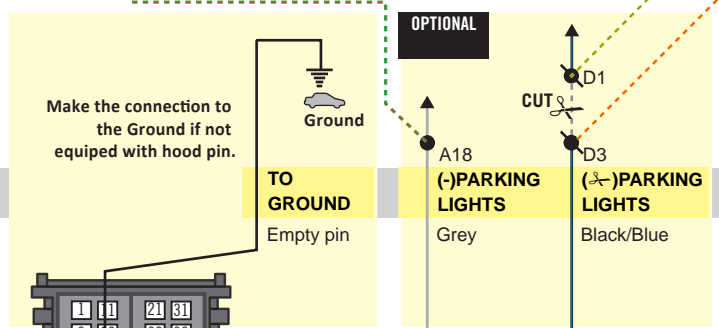
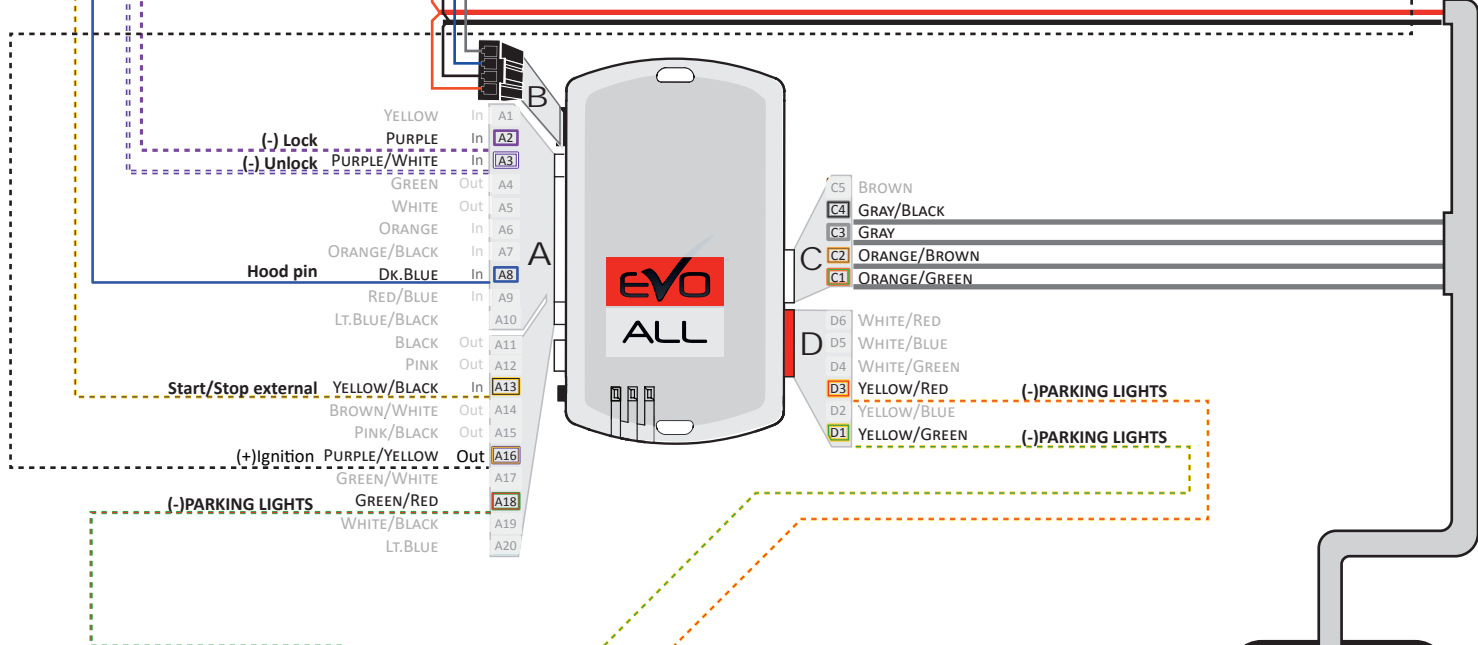
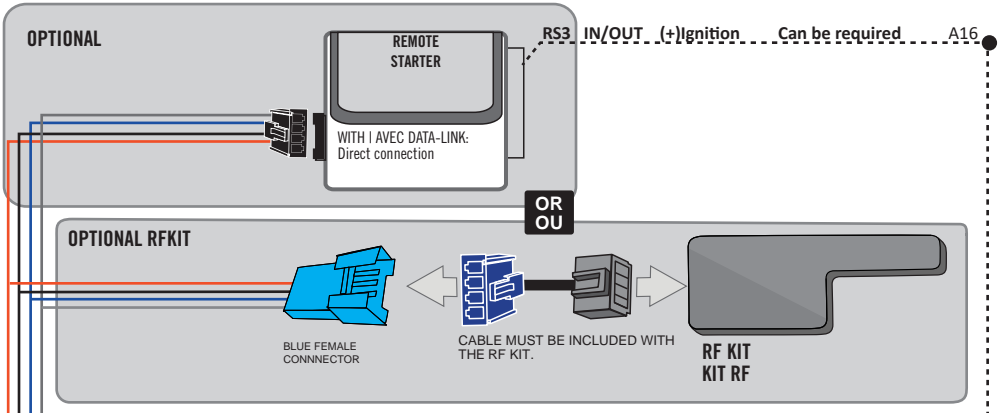
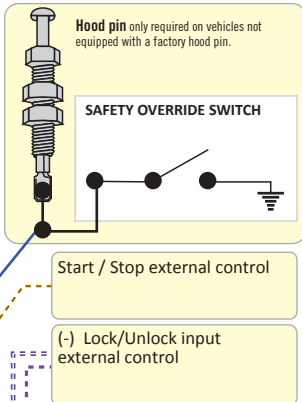

③ Back view Fuse box 20-pin black Connector

② Back view Parking Lights switch 14-pin Black Connector

① Gateway module, Behind OBD-II connector - located at dash board driver's side - Back view, 24-pin black connector.

PROGRAMMING PROCEDURE

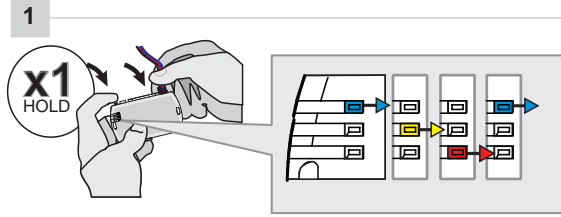

Press and hold the programming button:
Insert the 4-Pin (Data-Link) connector.

↳ The Blue, Red, Yellow and Blue & Red LEDs will alternatively illuminate.

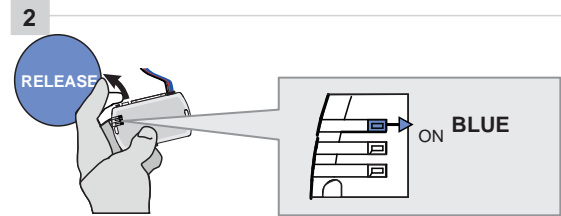

Release the programming button when the LED is BLUE.

If the LED is not solid BLUE disconnect the 4-Pin connector (Data-Link) and go back to step 1.

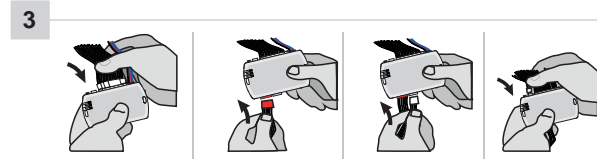

Insert the required remaining connectors.

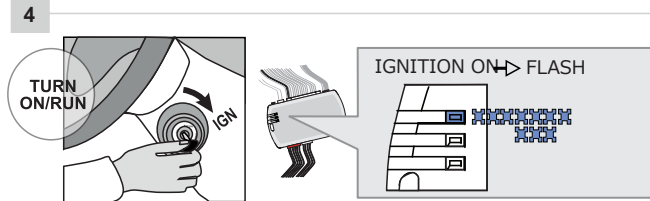

Turn the key to the Ignition ON/RUN position.

↳ The BLUE LED will flash rapidly.

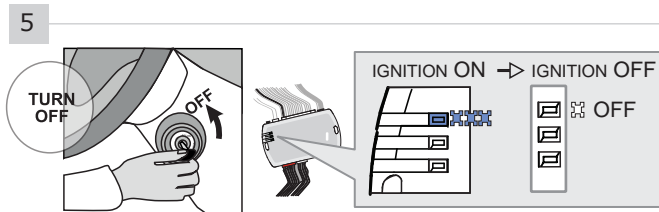

Turn the key to the OFF position.

↳ The BLUE LED will turn off.

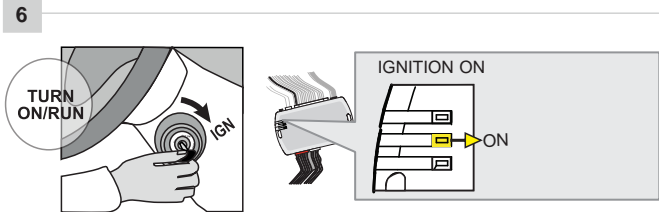

Turn the key to the Ignition ON/RUN position.

↳ The YELLOW LED will turn ON.

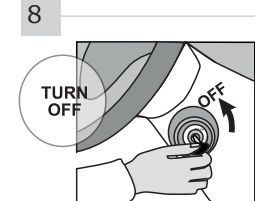
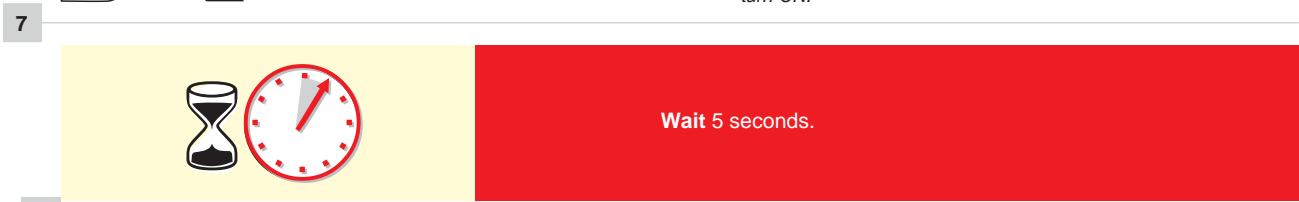

Turn the key to the OFF position.

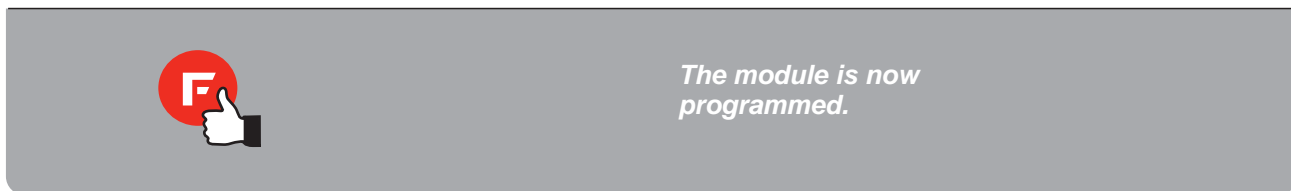

REMOTE STARTER FUNCTIONALITY



All doors must be closed.



Remote start the vehicle.



Unlock the doors with the remote-starter remote or the OEM remote.



Insert and Turn the key to the Ignition ON/RUN position.



Press the brake pedal.



The vehicle can now be put in to gear and driven.

THAR-FOR3 THARNNESS STAND ALONE INSTALLATION

ADDENDUM - SUGGESTED WIRING CONFIGURATION



ONLY COMPATIBLE WITH AUTOMATIC TRANSMISSION VEHICLES.



Vehicle functions supported in this diagram (functional if equipped)

VEHICLE	YEARS	Immobilizer bypass	Lock	Unlock	Arm	Disarm	RAP Disable	Tachometer	Heated seats	Heated Mirrors	Rear defrost	Door Status	Trunk Status	Hood Status*	Hand-Brake Status	Foot-Brake Status	Active OEM Remote Start
FORD																	
Explorer	Push-to-Start 2016-2019	•	•	•	•	•	•	•	•	•	•	•	•	•	•	•	•

FIRMWARE VERSION

4.01

ONLY - SEULEMENT

To add the firmware version and the options, use the **FLASH LINK UPDATER** or **FLASH LINK MOBILE** tool, sold separately.

	PROGRAM BYPASS OPTION:	UNIT OPTION	DESCRIPTION
	Program bypass option:	C1	OEM Remote status (Lock/Unlock) monitoring
		D6	Push-to-Start
	IF THE VEHICLE IS NOT EQUIPPED WITH FUNCTIONAL HOOD PIN:	A11	OFF
			Hood trigger (Output Status).



Parts required (Not included)

1x THAR-FOR3

MANDATORY INSTALL

***HOOD PIN**



HOOD STATUS: THE HOOD PIN SWITCH MUST BE INSTALLED IF THE VEHICLE CAN BE REMOTE STARTED WITH THE HOOD OPEN, SET FUNCTION **A11** TO OFF.

A11 OFF

Notice: the installation of safety elements are mandatory. The hood pin is an essential security element and must be installed.

THIS MODULE MUST BE INSTALLED BY A QUALIFIED TECHNICIAN. A WRONG CONNECTION CAN CAUSE PERMANENT DAMAGE TO THE VEHICLE.

PARTS REQUIRED (NOT INCLUDED)

1x **FLASH LINK UPDATER,**
1x **FLASH LINK MANAGER**
SOFTWARE | PROGRAMME
1x Microsoft Windows Computer with Internet connection

OR

1x **FLASH LINK MOBILE**
1x **FLASH LINK MOBILE APP**
Smartphone Android or iOS with Internet connection (provider charges may apply).

MANDATORY

HOOD PIN



REMOTE START SAFETY OVERRIDE SWITCH

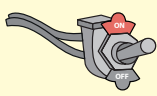





VALET SWITCH

Part #: RSPB available, Sold separately.

Notice: the installation of safety elements are mandatory. The hood pin and the valet switch are essential security elements and must be installed.

STAND ALONE CONFIGURATION

	Program bypass option	UNIT OPTION	DESCRIPTION
	OEM Remote Stand Alone Remote Starter:	D1.10 	By default, LOCK, LOCK, LOCK Par défaut, VERROUILLE,VERROUILLE,VERROUILLE
		D1.1 	
	Program bypass option with oem remote:	C1	OEM Remote Monitoring
	Program bypass option with RF KIT antenna:	H1 to H6	Supported RF Kits and select RF Kit

REMOTE STARTER FUNCTIONALITY



All doors must be closed.

3X 

Press the OEM remote's Lock button 3x to remote-start (or remote-stop) the vehicle.



START

The vehicle will START.

REMOTE STARTER DIAGNOSTICS
MODULE RED LED

x2 flash :	Brake ON
x3 flash :	No tach
x4 flash :	Ignition before start
x5 flash :	Hood Open

REMOTE STARTER WARNING CARD



CUT THIS WARNING CARD AND STICK IT ON A VISIBLE PLACE:
or use the package RSPB, Sold separately.

WARNING



REMOTE STARTER

THE VEHICLE CAN BE STARTED BY EITHER: PRESSING THE LOCK BUTTON ON THE OEM REMOTE 3 TIMES CONSECUTIVELY OR BY A SMARTPHONE. **TURN ON** THE SAFETY SWITCH LOCATED UNDER THE DASHBOARD BEFORE WORKING ON THE VEHICLE.

DESCRIPTION

① Gateway module left side of dash

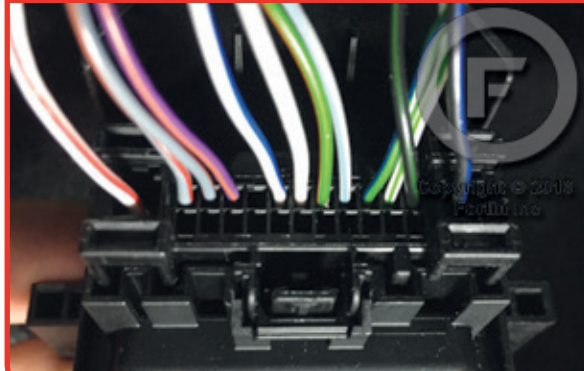

② Parking Lights switch

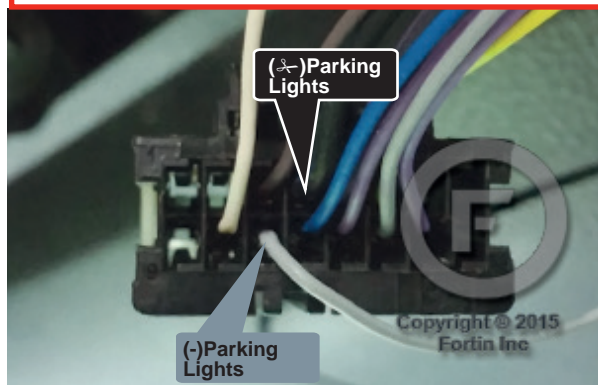

AUTOMATIC TRANSMISSION WIRING CONNECTION

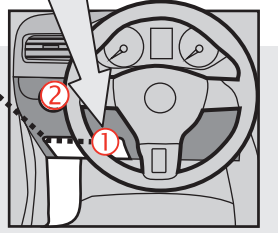
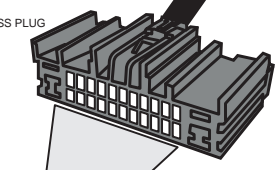
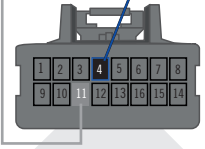
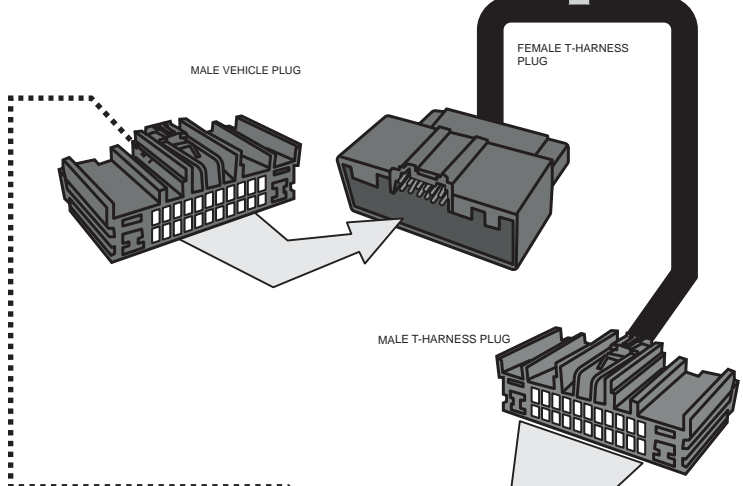
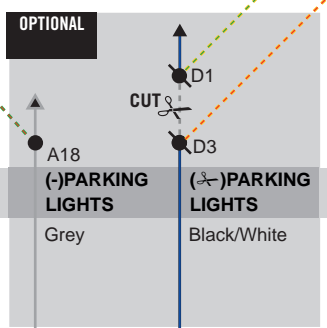
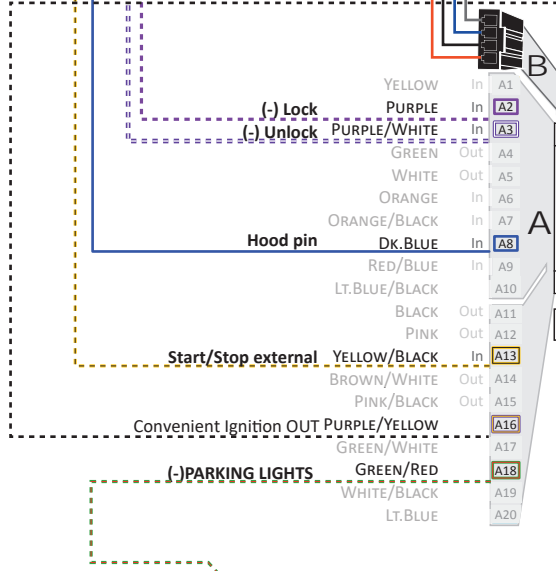
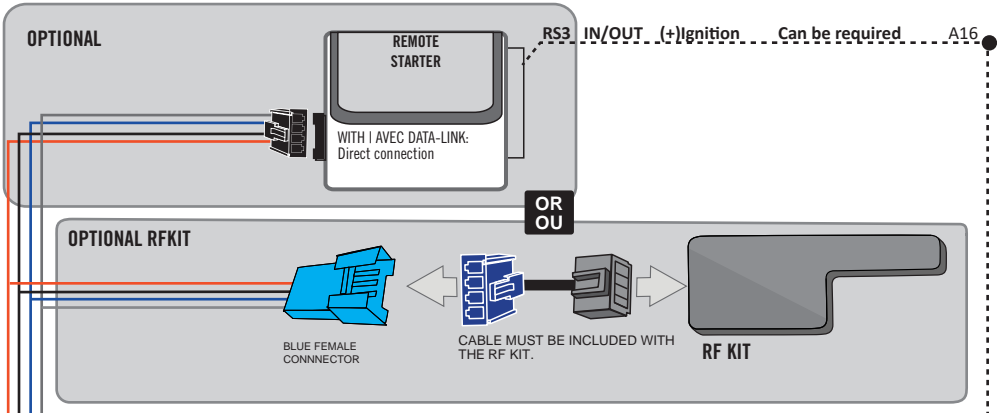
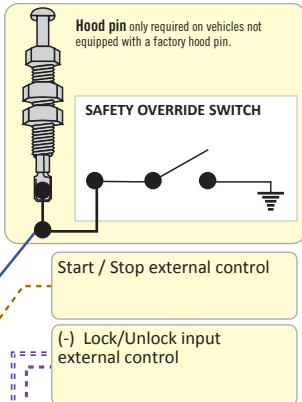

② Parking Lights switch
Back view, 14-pin black connector.

① Gateway module, located at dash board driver's side, Back view, 24-pin black connector.

PROGRAMMING PROCEDURE

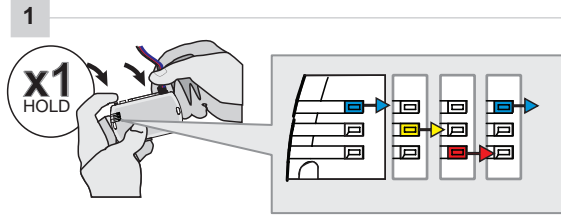

Press and hold the programming button:
Insert the 4-Pin (Data-Link) connector.

↳ The Blue, Red, Yellow and Blue & Red LEDs will alternatively illuminate.

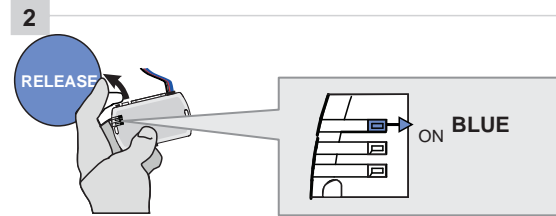

Release the programming button when the LED is BLUE.

If the LED is not solid BLUE disconnect the 4-Pin connector (Data-Link) and go back to step 1.

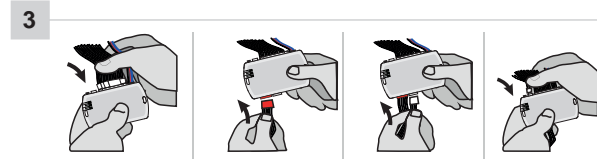

Insert the required remaining connectors.

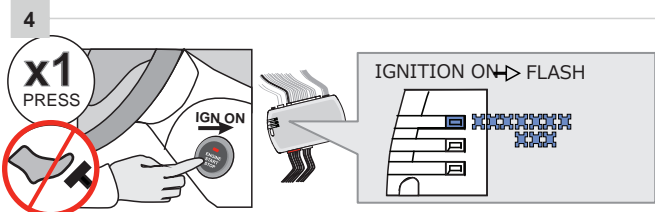

Do not press the brake pedal.
Press the Push-to-Start button once to turn on the ignition.

↳ The BLUE LED will flash rapidly.

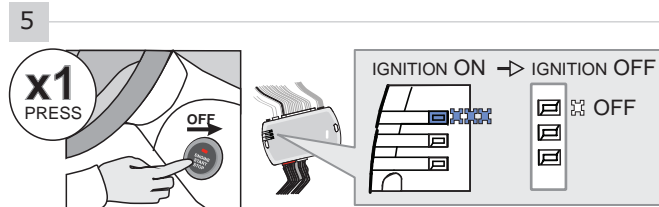

Press the Push-to-Start button once to turn off the ignition.

↳ The BLUE LED will turn off.

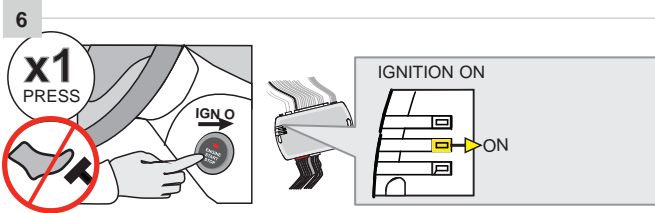

Do not press the brake pedal.
Press the Push-to-Start button once to turn on the ignition.



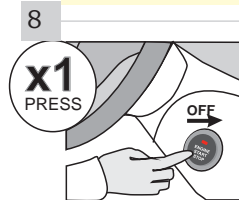
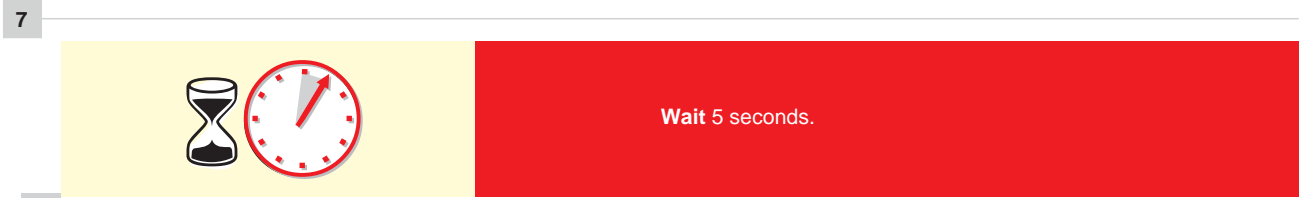

↳ The YELLOW LED will turn ON.



Press the Push-to-Start button once to turn off the ignition.

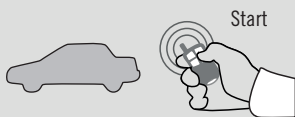

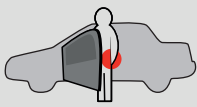
REMOTE STARTER FUNCTIONALITY

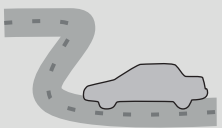
 <p>Start</p> <p>All doors must be closed.</p> <p>Remote start the vehicle.</p>	 <p>UNLOCK</p> <p>Unlock the doors with either:</p> <ul style="list-style-type: none"> • The OEM remote • The remote-starter remote • Or the proximity remote 	 <p>Enter the vehicle with the SMART-KEY.</p>	 <p>DO NOT PRESS THE BRAKE PEDAL.</p> <p>Press and release the Push-to-Start button once.</p>	 <p>Press the brake pedal. The vehicle can now be put in to gear and driven.</p> <p>If the Smart-Key is not detected the vehicle will shut down.</p>
--	---	--	---	---

THAR-FOR3 THARNNESS STAND ALONE INSTALLATION

ADDENDUM - SUGGESTED WIRING CONFIGURATION



ONLY COMPATIBLE WITH AUTOMATIC TRANSMISSION VEHICLES.



Vehicle functions supported in this diagram (functional if equipped)

VEHICLE	YEARS	Immobilizer bypass	Lock	Unlock	Arm	Disarm	RAP Disable	Parking Lights	Tachometer	Heated seats	Heated Mirrors	Rear defrost	Door Status	Trunk Status	Hood Status*	Hand-Brake Status	Foot-Brake Status	Active OEM Remote Start	
FORD																			
F-150	<i>Push-to-Start</i> 2015-2018	•	•	•	•	•	•	•	•	•	•	•	•	•	•	•	•	•	•
F-250	<i>Push-to-Start</i> 2017	•	•	•	•	•	•	•	•	•	•	•	•	•	•	•	•	•	•
F-350	<i>Push-to-Start</i> 2017	•	•	•	•	•	•	•	•	•	•	•	•	•	•	•	•	•	•
F-450	<i>Push-to-Start</i> 2017	•	•	•	•	•	•	•	•	•	•	•	•	•	•	•	•	•	•
LINCOLN																			
MKC	<i>Push-to-Start</i> 2015-2019	•	•	•	•	•	•	•	•	•	•	•	•	•	•	•	•	•	•

FIRMWARE VERSION

4.01

ONLY - SEULEMENT

To add the firmware version and the options, use the **FLASH LINK UPDATER** or **FLASH LINK MOBILE** tool, sold separately.

		UNIT OPTION	DESCRIPTION
	Program bypass option IF THE VEHICLE IS NOT EQUIPPED WITH FUNCTIONAL HOOD PIN:	A11	<div style="background-color: red; color: white; padding: 5px; display: inline-block; margin-bottom: 5px;">OFF</div> <p>Hood trigger (Output Status).</p>
	Program bypass option:	C1	<p>OEM Remote status (Lock/Unlock) monitoring</p>



Parts required (Not included)

1x THAR-FOR3

MANDATORY INSTALL

*HOOD PIN



HOOD STATUS: THE HOOD PIN SWITCH MUST BE INSTALLED IF THE VEHICLE CAN BE REMOTE STARTED WITH THE HOOD OPEN, SET FUNCTION A11 TO OFF.

A11

OFF

Notice: the installation of safety elements are mandatory. The hood pin is an essential security element and must be installed.

THIS MODULE MUST BE INSTALLED BY A QUALIFIED TECHNICIAN. A WRONG CONNECTION CAN CAUSE PERMANENT DAMAGE TO THE VEHICLE.

PARTS REQUIRED (NOT INCLUDED)

1x **FLASH LINK UPDATER,**
 1x **FLASH LINK MANAGER**
 SOFTWARE | PROGRAMME
 1x Microsoft Windows Computer with Internet connection

OR

1x **FLASH LINK MOBILE**
 1x **FLASH LINK MOBILE APP**
 Smartphone Android or iOS with Internet connection (provider charges may apply).

MANDATORY

HOOD PIN



REMOTE START SAFETY OVERRIDE SWITCH

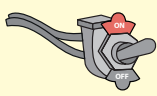







VALET SWITCH

Part #: RSPB available, Sold separately.

Notice: the installation of safety elements are mandatory. The hood pin and the valet switch are essential security elements and must be installed.

STAND ALONE CONFIGURATION

	Program bypass option	UNIT OPTION	DESCRIPTION
	OEM Remote Stand Alone Remote Starter:	D1.10 	By default, LOCK, LOCK, LOCK
		D1.1 	Par défaut, VERROUILLE, VERROUILLE, VERROUILLE
	Program bypass option with oem remote:	C1	OEM Remote Monitoring
	Program bypass option with RF KIT antenna:	H1 to H6	Supported RF Kits and select RF Kit
	Program bypass option Vehicle hybrid only:	D4	Hybrid mode (Vehicle hybrid only)

REMOTE STARTER FUNCTIONALITY



All doors must be closed.

3X 

Press the OEM remote's Lock button 3x to remote-start (or remote-stop) the vehicle.



START 

The vehicle will START.

REMOTE STARTER DIAGNOSTICS
MODULE RED LED

x2 flash :	Brake ON
x3 flash :	No tach
x4 flash :	Ignition before start
x5 flash :	Hood Open

REMOTE STARTER WARNING CARD



CUT THIS WARNING CARD AND STICK IT ON A VISIBLE PLACE:
 or use the package RSPB, Sold separately.

WARNING



REMOTE STARTER

THE VEHICLE CAN BE STARTED BY EITHER: PRESSING THE LOCK BUTTON ON THE OEM REMOTE 3 TIMES CONSECUTIVELY OR BY A SMARTPHONE. **TURN ON** THE SAFETY SWITCH LOCATED UNDER THE DASHBOARD BEFORE WORKING ON THE VEHICLE.

DESCRIPTION



② Parking Lights switch

① Gateway module, located at dash board driver's side,

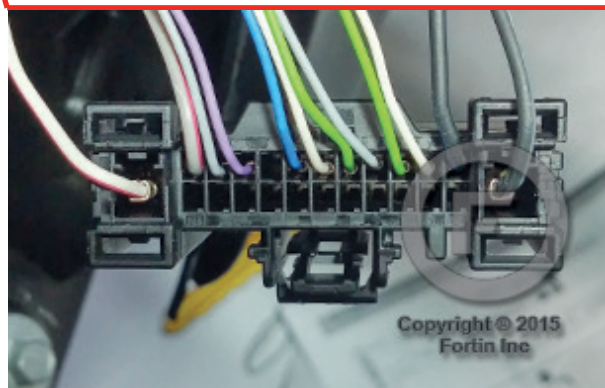
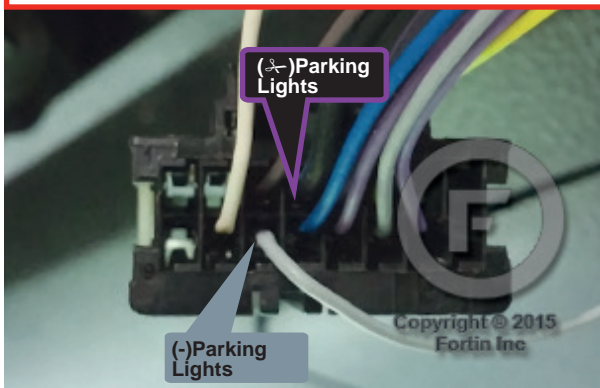

④ Under the hood If not equipped with hood pin.

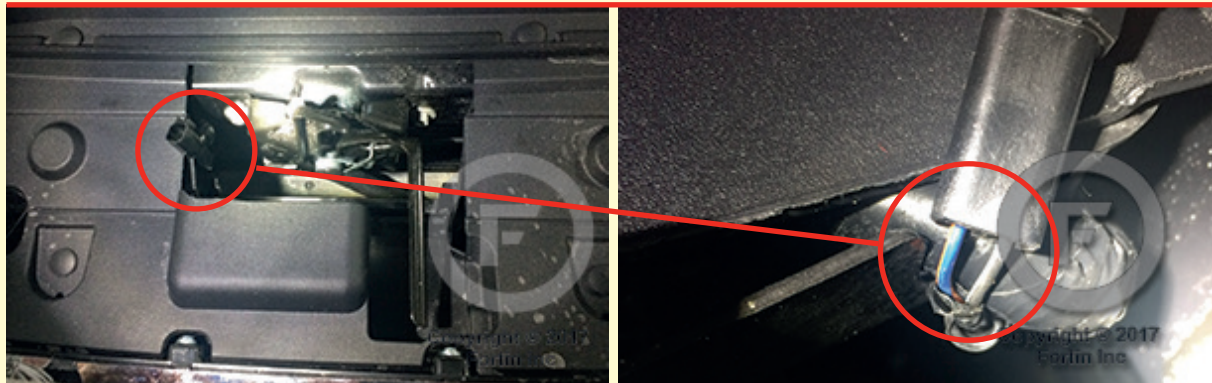

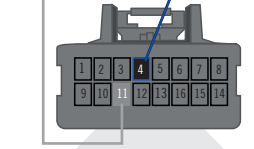
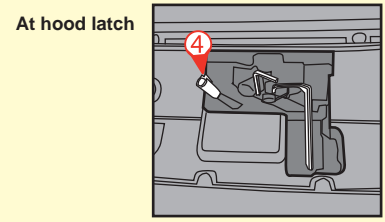
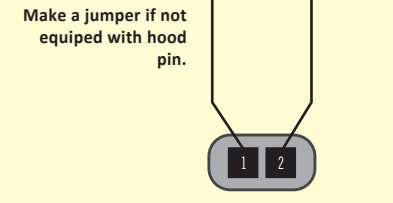
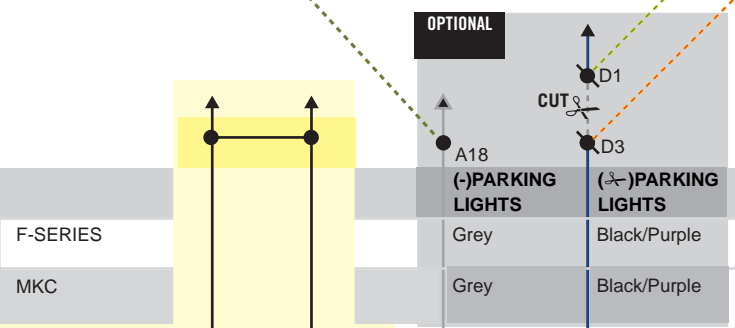
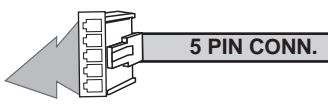
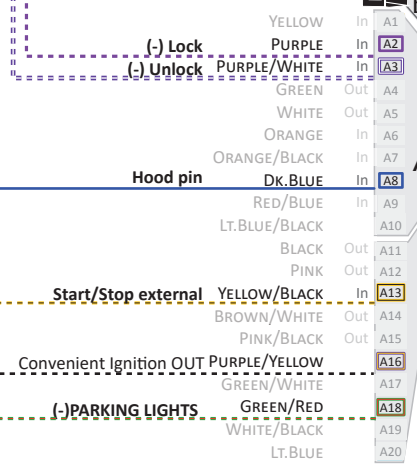
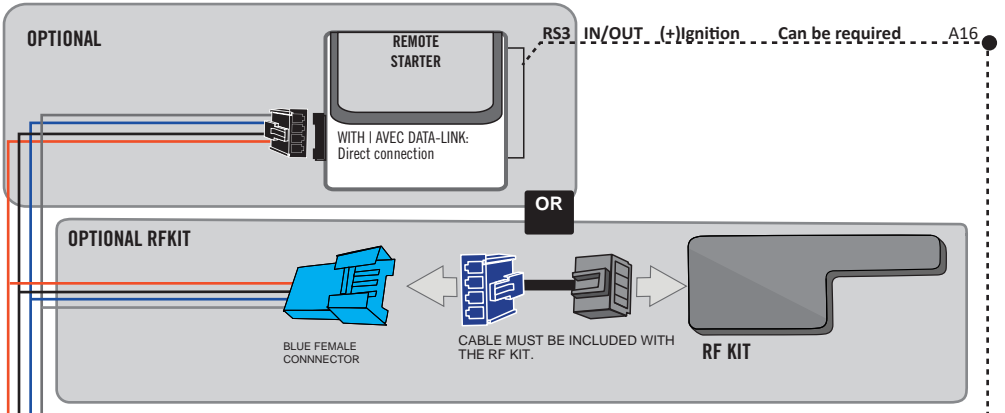
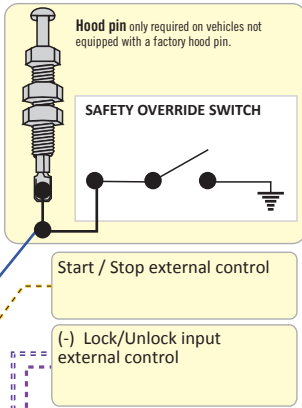

② Parking Lights switch
Back view, 14-pin black connector.

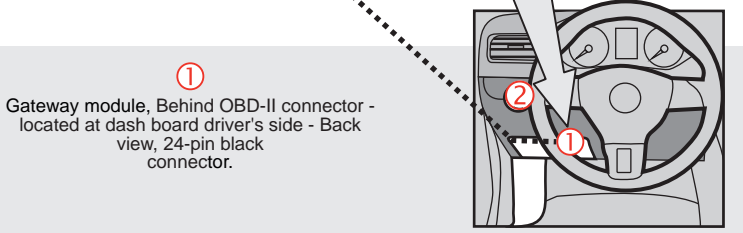
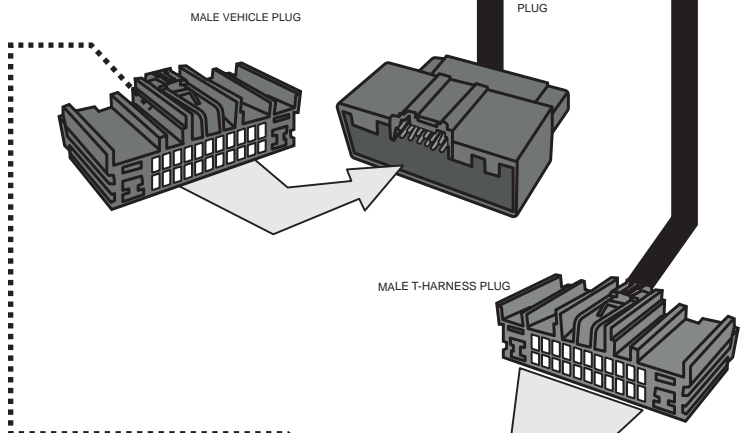

① Gateway module, Behind OBD-II connector - located at dash board driver's side - Back view, 24-pin black connector.

PROGRAMMING PROCEDURE

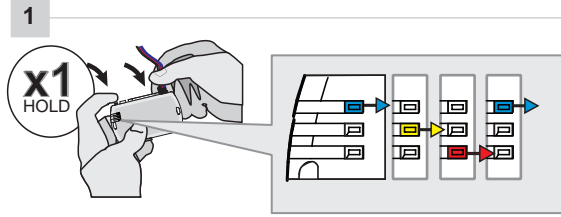

Press and hold the programming button:
Insert the 4-Pin (Data-Link) connector.

↳ The Blue, Red, Yellow and Blue & Red LEDs will alternatively illuminate.

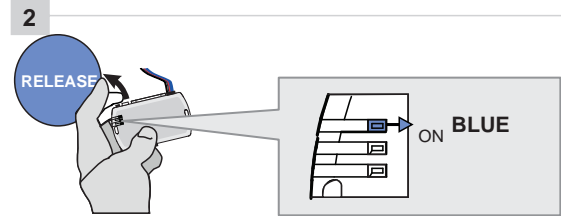

Release the programming button when the LED is BLUE.

If the LED is not solid BLUE disconnect the 4-Pin connector (Data-Link) and go back to step 1.

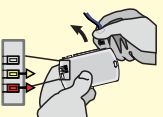
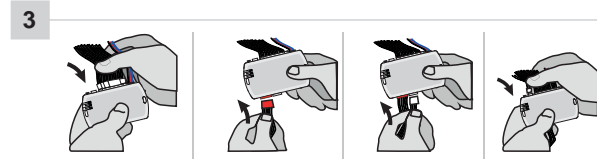

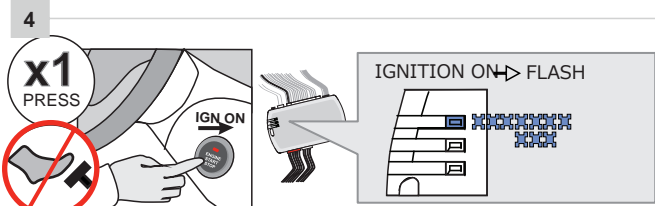

Insert the required remaining connectors.

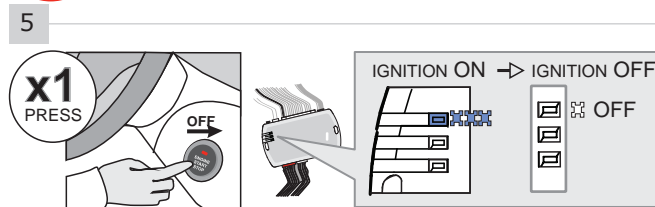

Do not press the brake pedal.
Press the Push-to-Start button once to turn on the ignition.

↳ The BLUE LED will flash rapidly.



Press the Push-to-Start button once to turn off the ignition.

↳ The BLUE LED will turn off.

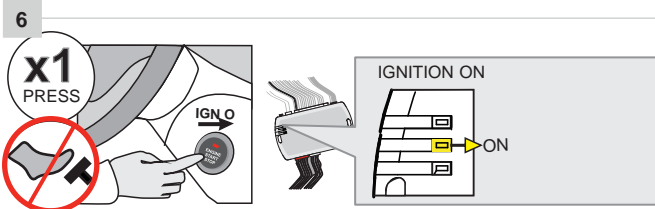

Do not press the brake pedal.
Press the Push-to-Start button once to turn on the ignition.

↳ The YELLOW LED will turn ON.

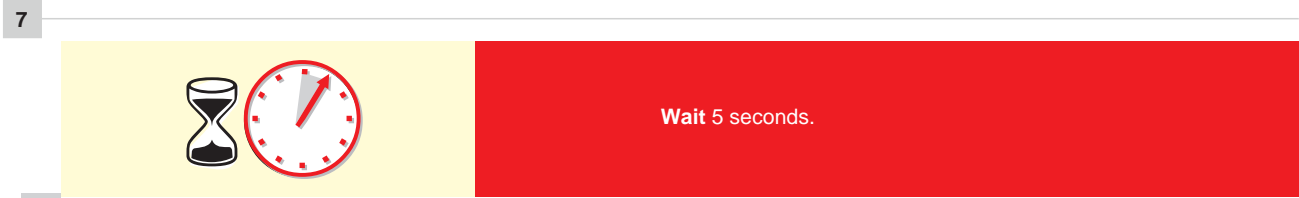

Wait 5 seconds.

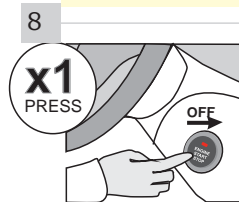



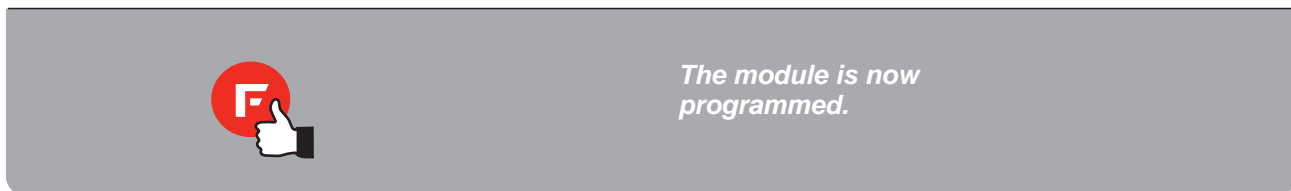

Press the Push-to-Start button once to turn off the ignition.

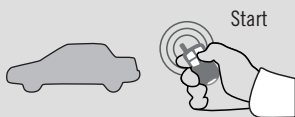

The module is now programmed.

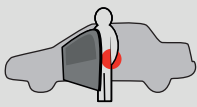
REMOTE STARTER FUNCTIONALITY

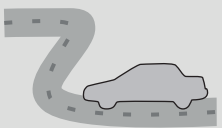
 <p>Start</p> <p>All doors must be closed.</p> <p>Remote start the vehicle.</p>	 <p>UNLOCK</p> <p>Unlock the doors with either:</p> <ul style="list-style-type: none"> • The OEM remote • The remote-starter remote • Or the proximity remote 	 <p>Enter the vehicle with the SMART-KEY.</p>	 <p>DO NOT PRESS THE BRAKE PEDAL.</p> <p>Press and release the Push-to-Start button once.</p>	 <p>Press the brake pedal. The vehicle can now be put in to gear and driven.</p> <p>If the Smart-Key is not detected the vehicle will shut down.</p>
--	---	--	---	---

THAR-FOR3 THARNNESS STAND ALONE INSTALLATION

ADDENDUM - SUGGESTED WIRING CONFIGURATION



ONLY COMPATIBLE WITH AUTOMATIC TRANSMISSION VEHICLES.



Vehicle functions supported in this diagram (functional if equipped)

VEHICLE	YEARS	Immobilizer bypass	Lock	Unlock	Arm	Disarm	RAP Disable	Parking Lights	Tachometer	Heated seats	Heated Mirrors	Rear defrost	Door Status	Trunk Status	Hood Status*	Hand-Brake Status	Foot-Brake Status	Active OEM Remote Start
FORD																		
F-150	Key 2015-2019	•	•	•	•	•	•	•	•	•	•	•	•	•	•	•	•	•
F-250	Key 2017-2019	•	•	•	•	•	•	•	•	•	•	•	•	•	•	•	•	•
F-350	Key 2017-2019	•	•	•	•	•	•	•	•	•	•	•	•	•	•	•	•	•
F-450	Key 2017-2019	•	•	•	•	•	•	•	•	•	•	•	•	•	•	•	•	•
F-550	Key 2017	•	•	•	•	•	•	•	•	•	•	•	•	•	•	•	•	•



FIRMWARE VERSION

4.01

ONLY - SEULEMENT

To add the firmware version and the options, use the **FLASH LINK UPDATER** or **FLASH LINK MOBILE** tool, sold separately.



Program bypass option IF THE VEHICLE IS NOT EQUIPPED WITH FUNCTIONAL HOOD PIN:

UNIT OPTION

A11

OFF

DESCRIPTION

Hood trigger (Output Status).



Program bypass option:

UNIT OPTION

C1

DESCRIPTION

OEM Remote status (Lock/Unlock) monitoring



Parts required (Not included)

1x THAR-FOR3



The vehicle must be equipped with the OEM remote with the door locks.

MANDATORY INSTALL

*HOOD PIN



HOOD STATUS: THE HOOD PIN SWITCH MUST BE INSTALLED IF THE VEHICLE CAN BE REMOTE STARTED WITH THE HOOD OPEN, SET FUNCTION A11 TO OFF.

A11

OFF

Notice: the installation of safety elements are mandatory. The hood pin is an essential security element and must be installed.

THIS MODULE MUST BE INSTALLED BY A QUALIFIED TECHNICIAN. A WRONG CONNECTION CAN CAUSE PERMANENT DAMAGE TO THE VEHICLE.

PARTS REQUIRED (NOT INCLUDED)

1x **FLASH LINK UPDATER,**
1x **FLASH LINK MANAGER**
SOFTWARE | PROGRAMME
1x Microsoft Windows Computer with Internet connection

OR

1x **FLASH LINK MOBILE**
1x **FLASH LINK MOBILE APP**
Smartphone Android or iOS with Internet connection (provider charges may apply).

MANDATORY

HOOD PIN



REMOTE START SAFETY OVERRIDE SWITCH

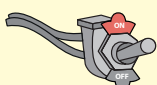







VALET SWITCH

Part #: RSPB available, Sold separately.

Notice: the installation of safety elements are mandatory. The hood pin and the valet switch are essential security elements and must be installed.

STAND ALONE CONFIGURATION

	Program bypass option	UNIT OPTION	DESCRIPTION
	OEM Remote Stand Alone Remote Starter:	D1.10 	By default, LOCK, LOCK, LOCK
		D1.1 	Par défaut, VERROUILLE, VERROUILLE, VERROUILLE
	Program bypass option with oem remote:	C1	OEM Remote Monitoring
	Program bypass option with RF KIT antenna:	H1 to H6	Supported RF Kits and select RF Kit
	Program bypass option Vehicle hybrid only:	D4	Hybrid mode (Vehicle hybrid only)

REMOTE STARTER FUNCTIONALITY



All doors must be closed.

3X 

Press the OEM remote's Lock button 3x to remote-start (or remote-stop) the vehicle.



START 

The vehicle will START.

REMOTE STARTER DIAGNOSTICS
MODULE RED LED

x2 flash :	Brake ON
x3 flash :	No tach
x4 flash :	Ignition before start
x5 flash :	Hood Open

REMOTE STARTER WARNING CARD



CUT THIS WARNING CARD AND STICK IT ON A VISIBLE PLACE:
or use the package RSPB, Sold separately.

WARNING



REMOTE STARTER

THE VEHICLE CAN BE STARTED BY EITHER: PRESSING THE LOCK BUTTON ON THE OEM REMOTE 3 TIMES CONSECUTIVELY OR BY A SMARTPHONE. **TURN ON** THE SAFETY SWITCH LOCATED UNDER THE DASHBOARD BEFORE WORKING ON THE VEHICLE.

DESCRIPTION



② Parking Lights switch

① Gateway module, located at dash board driver's side,

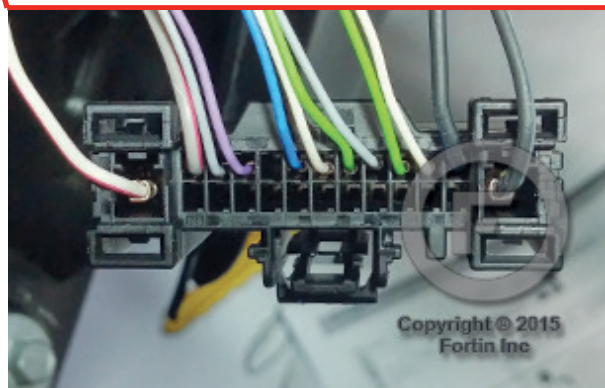
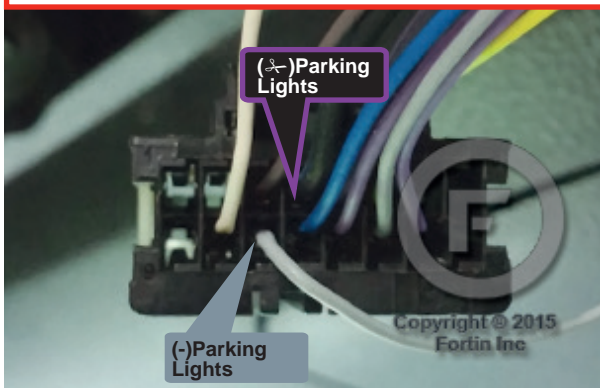

④ Under the hood If not equipped with hood pin.

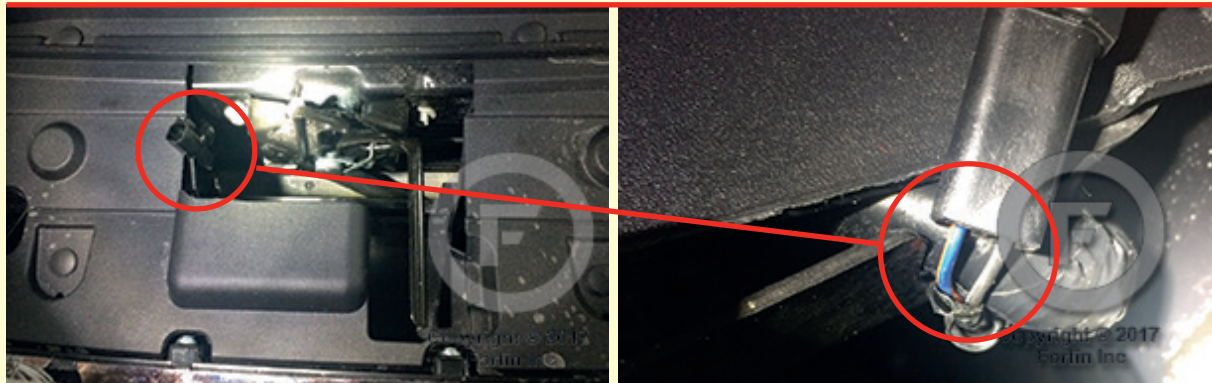

AUTOMATIC TRANSMISSION WIRING CONNECTION

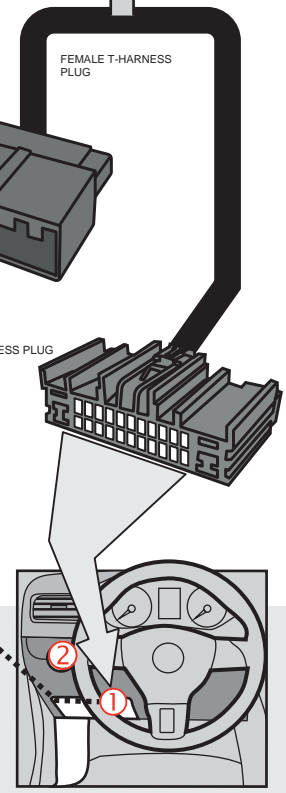
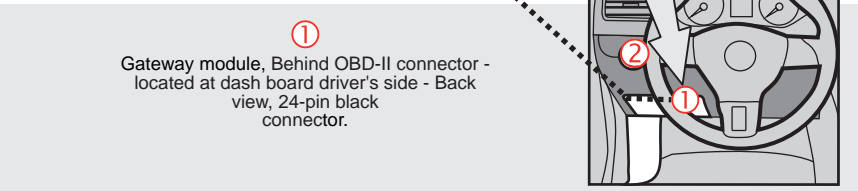
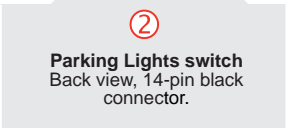
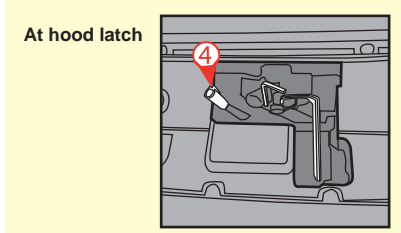
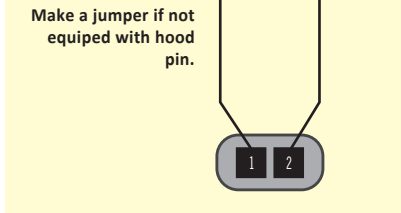
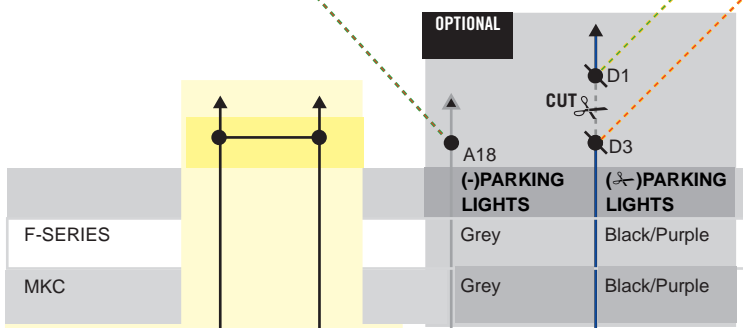
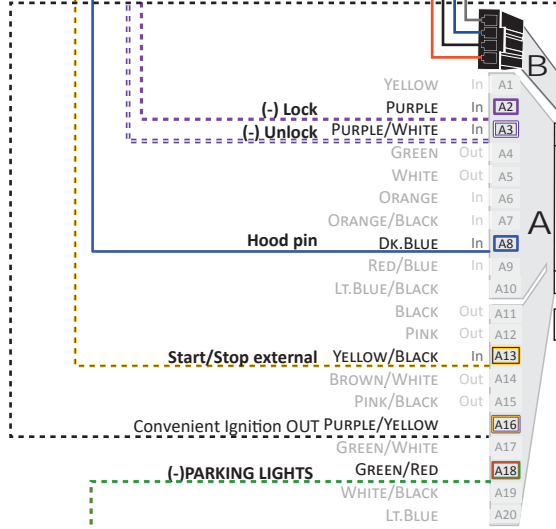
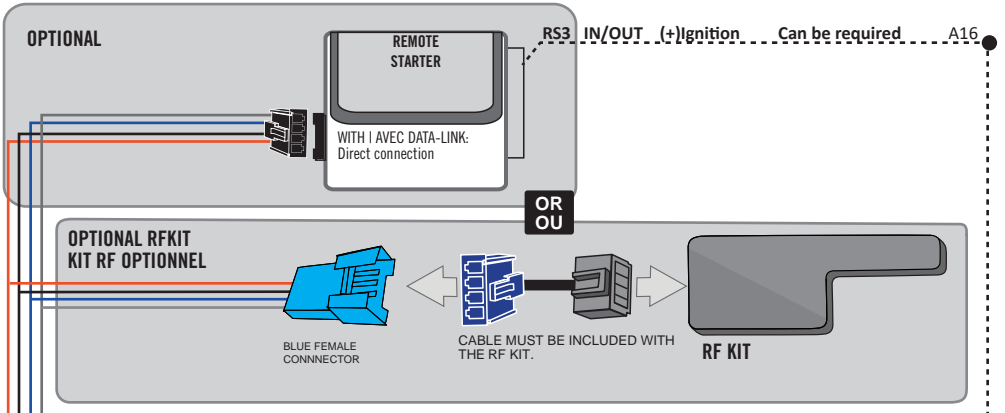
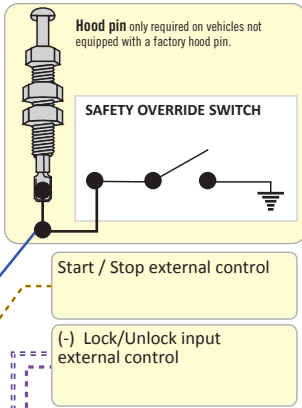

PROGRAMMING PROCEDURE

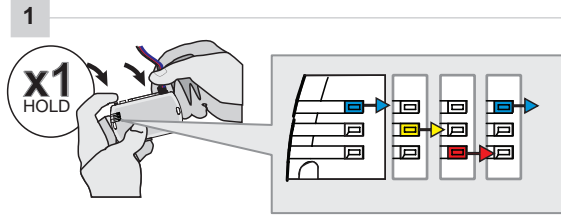

Press and hold the programming button:
Insert the 4-Pin (Data-Link) connector.

↳ The Blue, Red, Yellow and Blue & Red LEDs will alternatively illuminate.

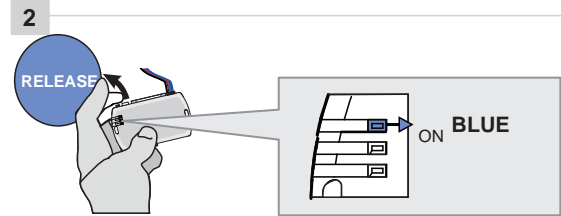

Release the programming button when the LED is BLUE.

If the LED is not solid BLUE disconnect the 4-Pin connector (Data-Link) and go back to step 1.

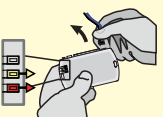
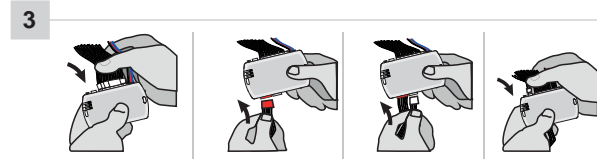

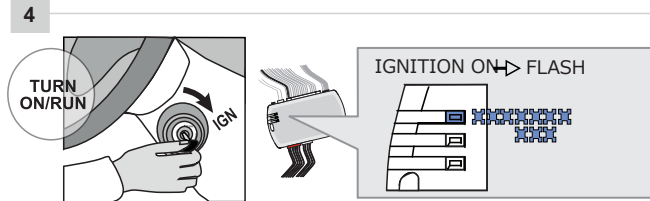

Insert the required remaining connectors.

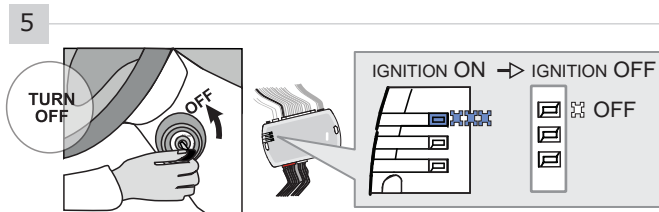

Turn the key to the Ignition ON/RUN position.

↳ The BLUE LED will flash rapidly.



Turn the key to the OFF position.

↳ The BLUE LED will turn off.

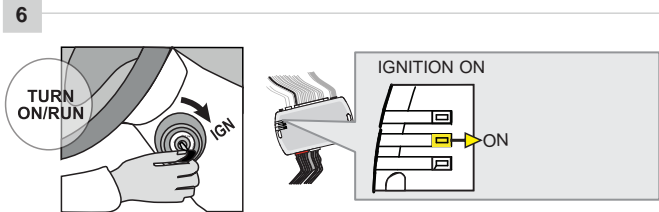

Turn the key to the Ignition ON/RUN position.

↳ The YELLOW LED will turn ON.

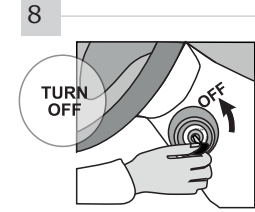
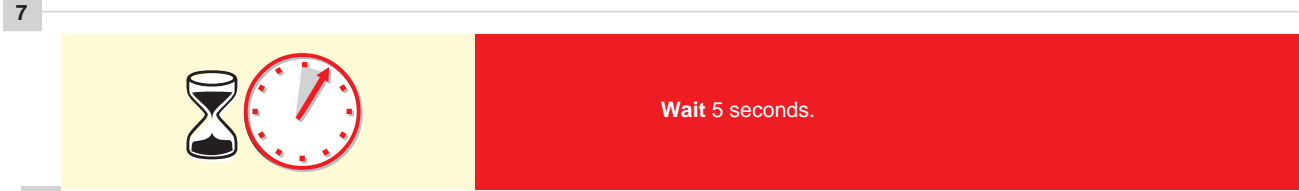

Turn the key to the OFF position.



REMOTE STARTER FUNCTIONALITY



All doors must be closed.



Remote start the vehicle.



Unlock the doors with the remote-starter remote or the OEM remote.



Insert and Turn the key to the Ignition ON/RUN position.



Press the brake pedal.



The vehicle can now be put in to gear and driven.

**THAR-FOR3 THARNESSTAND ALONE
INSTALLATION**

ADDENDUM - SUGGESTED WIRING CONFIGURATION

ONLY COMPATIBLE WITH AUTOMATIC TRANSMISSION VEHICLES.

VEHICLE	YEARS	Vehicle functions supported in this diagram (functional if equipped)																
		Immobilizer bypass	Lock	Unlock	Armn	Disarm	RAP Disable	Parking Lights	Tachometer	Heated seats	Heated Mirrors	Rear defrost	Door Status	Trunk Status	Hood Status*	Hand-Brake Status	Foot-Brake Status	Active OEM Remote Start
FORD																		
Fusion	Push-to-Start	2014-2019	•	•	•	•	•	•	•	•	•	•	•	•	•	•	•	•
	Hybrid Push-to-Start	2014-2019	•	•	•	•	•	•	•	•	•	•	•	•	•	•	•	•
LINCOLN																		
Continental	Push-to-Start	2017-2019	•	•	•	•	•	•	•	•	•	•	•	•	•	•	•	•
MKZ	Push-to-Start	2013-2019	•	•	•	•	•	•	•	•	•	•	•	•	•	•	•	•
	Hybrid Push-to-Start	2013-2019	•	•	•	•	•	•	•	•	•	•	•	•	•	•	•	•

4.01

ONLY - SEULEMENT

 To add the firmware version and the options, use the **FLASH LINK UPDATER** or **FLASH LINK MOBILE** tool, sold separately.

	Program bypass option IF THE VEHICLE IS NOT EQUIPPED WITH FUNCTIONAL HOOD PIN: :	UNIT OPTION	DESCRIPTION
		A11	OFF
	Program bypass option:	UNIT OPTION	DESCRIPTION
		C1	OEM Remote status (Lock/Unlock) monitoring
	Program bypass option (Vehicle hybrid only):	UNIT OPTION	DESCRIPTION
		D4	Hybrid mode (Vehicle hybrid only)
		D6	Push-to-Start

Parts required (Not included)

1x THAR-FOR3

MANDATORY INSTALL
***HOOD PIN**

HOOD STATUS: THE HOOD PIN SWITCH MUST BE INSTALLED IF THE VEHICLE CAN BE REMOTE STARTED WITH THE HOOD OPEN, SET FUNCTION A11 TO OFF.

A11
OFF
Notice: the installation of safety elements are mandatory. The hood pin is an essential security element and must be installed.

THIS MODULE MUST BE INSTALLED BY A QUALIFIED TECHNICIAN. A WRONG CONNECTION CAN CAUSE PERMANENT DAMAGE TO THE VEHICLE.

PARTS REQUIRED (NOT INCLUDED)

1x **FLASH LINK UPDATER,**
1x **FLASH LINK MANAGER**
SOFTWARE | PROGRAMME
1x Microsoft Windows Computer with Internet connection

OR

1x **FLASH LINK MOBILE**
1x **FLASH LINK MOBILE APP**
Smartphone Android or iOS with Internet connection (provider charges may apply).

MANDATORY

HOOD PIN



REMOTE START SAFETY OVERRIDE SWITCH

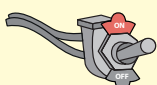







VALET SWITCH

Part #: RSPB available, Sold separately.

Notice: the installation of safety elements are mandatory. The hood pin and the valet switch are essential security elements and must be installed.

STAND ALONE CONFIGURATION

	Program bypass option	UNIT OPTION	DESCRIPTION
	OEM Remote Stand Alone Remote Starter:	D1.10 	By default, LOCK, LOCK, LOCK
		D1.1 	Par défaut, VERROUILLE, VERROUILLE, VERROUILLE
	Program bypass option with oem remote:	C1	OEM Remote Monitoring
	Program bypass option with RF KIT antenna:	H1 to H6	Supported RF Kits and select RF Kit
	Program bypass option Vehicle hybrid only:	D4	Hybrid mode (Vehicle hybrid only)

REMOTE STARTER FUNCTIONALITY



All doors must be closed.

3X 

Press the OEM remote's Lock button 3x to remote-start (or remote-stop) the vehicle.



START 

The vehicle will START.

REMOTE STARTER DIAGNOSTICS
MODULE RED LED

x2 flash :	Brake ON
x3 flash :	No tach
x4 flash :	Ignition before start
x5 flash :	Hood Open

REMOTE STARTER WARNING CARD



CUT THIS WARNING CARD AND STICK IT ON A VISIBLE PLACE:
or use the package RSPB, Sold separately.

WARNING



REMOTE STARTER

THE VEHICLE CAN BE STARTED BY EITHER: PRESSING THE LOCK BUTTON ON THE OEM REMOTE 3 TIMES CONSECUTIVELY OR BY A SMARTPHONE. **TURN ON** THE SAFETY SWITCH LOCATED UNDER THE DASHBOARD BEFORE WORKING ON THE VEHICLE.

DESCRIPTION



②

Parking Lights switch

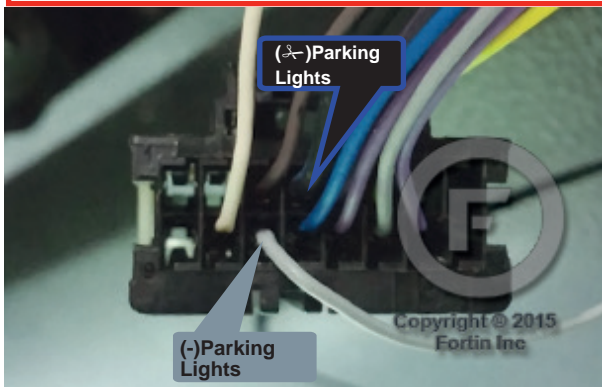

①

Gateway module, Behind OBD-II connector

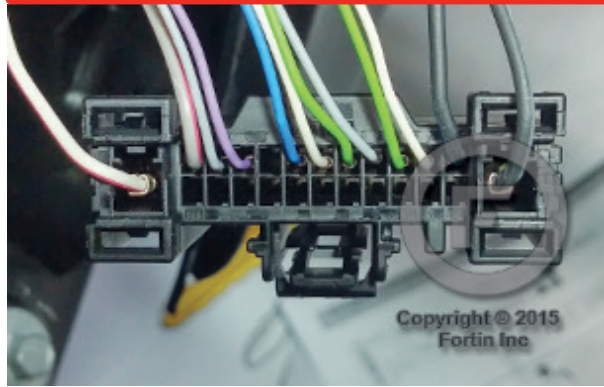

AUTOMATIC TRANSMISSION WIRING CONNECTION

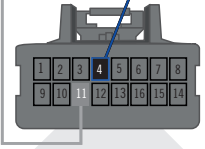
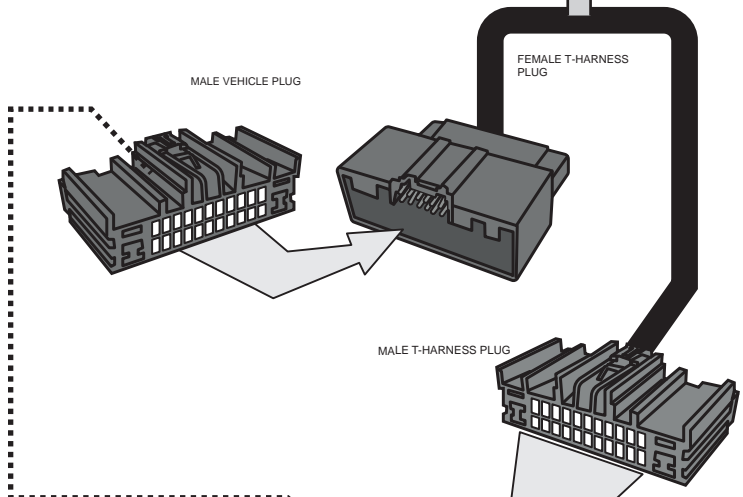
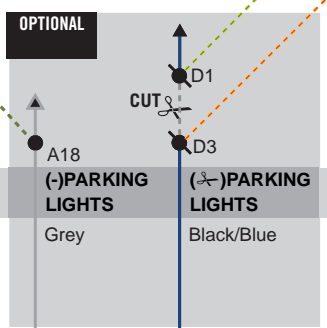
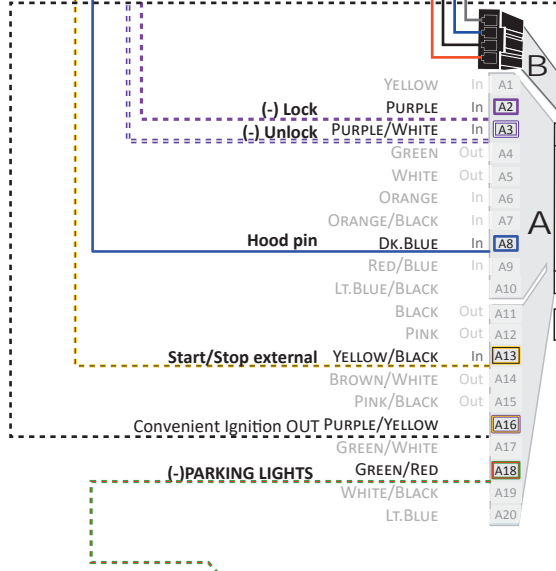
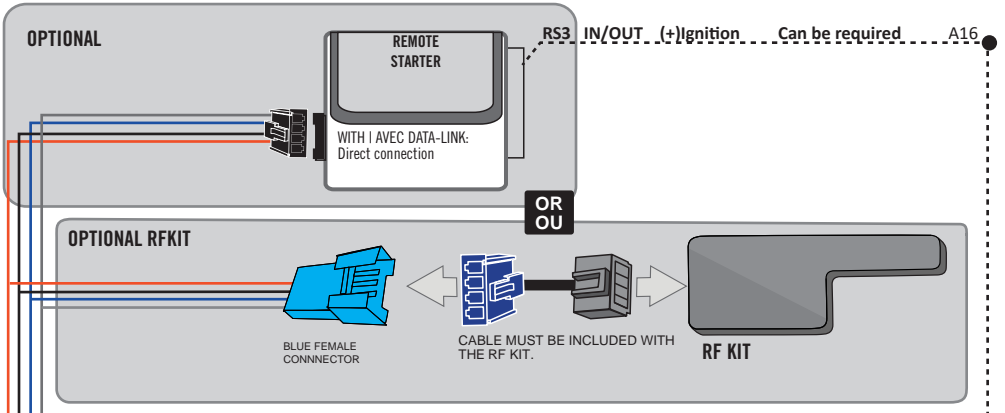
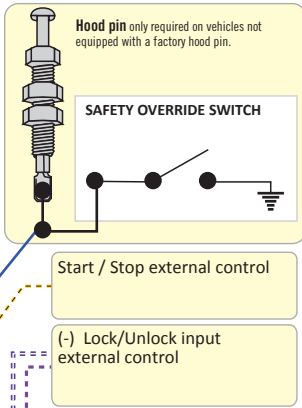

② Parking Lights switch
Back view, 14-pin black connector.

① Gateway module, Connector Behind OBD-II connector - located at dash board driver's side
Back view, 24-pin black connector.

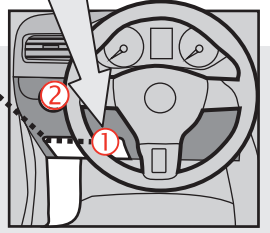

PROGRAMMING PROCEDURE

1

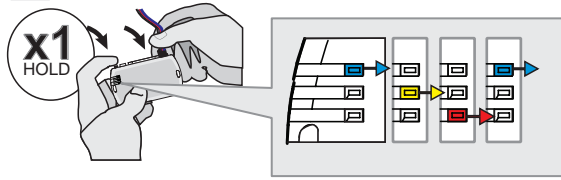

Press and hold the programming button:
Insert the 4-Pin (Data-Link) connector.

↳ The Blue, Red, Yellow and Blue & Red LEDs will alternatively illuminate.

2

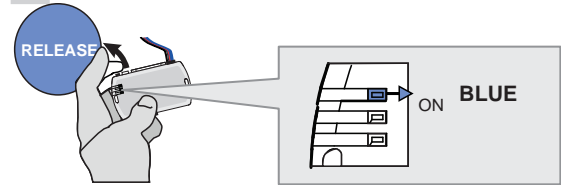

Release the programming button when the LED is BLUE.

If the LED is not solid BLUE disconnect the 4-Pin connector (Data-Link) and go back to step 1.

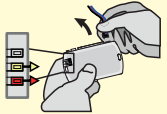

3

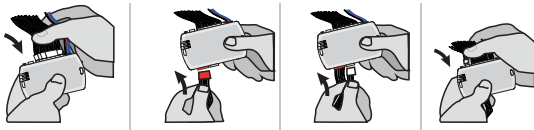

Insert the required remaining connectors.

4

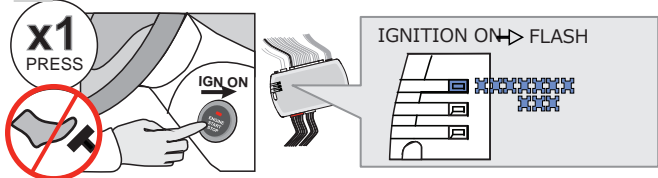

Do not press the brake pedal.
Press the Push-to-Start button once to turn on the ignition.

↳ The BLUE LED will flash rapidly.

5

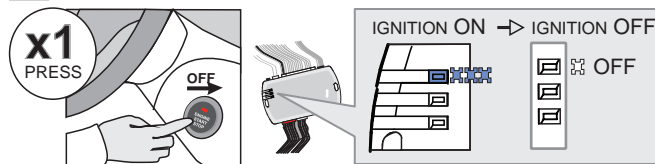

Press the Push-to-Start button once to turn off the ignition.

↳ The BLUE LED will turn off.

6

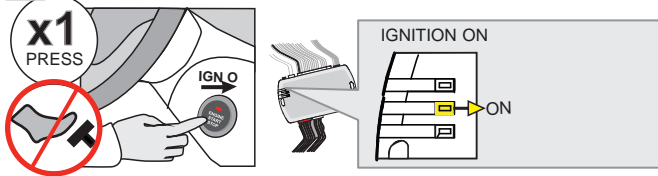

Do not press the brake pedal.
Press the Push-to-Start button once to turn on the ignition.

↳ The YELLOW LED will turn ON.

7



Wait 5 seconds.

8

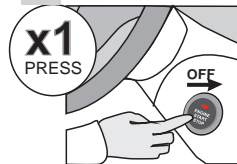

Press the Push-to-Start button once to turn off the ignition.



The module is now programmed.

OPTIONAL RF-KIT PROGRAMMING



PROGRAM BYPASS OPTION

	<p>Program bypass option:</p>	<p>H2</p>	<p>Supported RF-KITS enable</p> <p>H2 Fortin 2</p>

OPTIONAL FORTIN RF KIT SERIES 4 OR SERIES 9 PROGRAMMING



The module must be programmed on the vehicle.

MAKE SURE THE IGNITION KEY HAS BEEN IN THE OFF POSITION FOR AT LEAST 5 SECONDS.

1

ON **x1** PRESS



Do not press the brake pedal. Press the Push-to-Start button once to turn on the ignition.

2

OFF **x1** PRESS



Press the Push-to-Start button once to turn off the ignition.

3

ON **x1** PRESS



Do not press the brake pedal. Press the Push-to-Start button once to turn on the ignition.

4

4X BRAKES

x4 PRESS



Press and release the brake pedal four times.

The LED will turn off each time.

5

ON EACH TRANSMITTER

4 BUTTONS

[-] PRESS AND RELEASE

→ PRESS AND RELEASE

LOCK PRESS AND RELEASE

1 BUTTON

PRESS APPROX. 12 SEC. AND WAIT FOR THE BLUE LED TO TURN OFF THEN BACK ON SOLID THEN RELEASE.

6

OFF **x1** PRESS



Press the Push-to-Start button once to turn off the ignition.

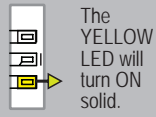

The YELLOW LED will turn ON solid.

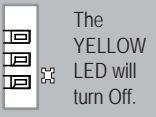

The YELLOW LED will turn Off.

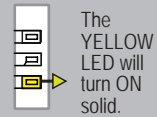

The YELLOW LED will turn ON solid.

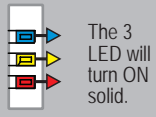

The 3 LED will turn ON solid.





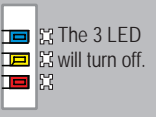

The LED will flash rapidly.



The 3 LED will turn off.

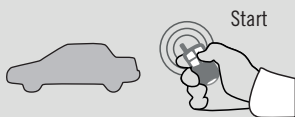

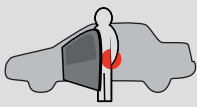
REMOTE STARTER FUNCTIONALITY

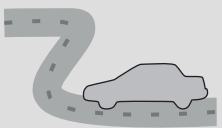
 <p>Start</p> <p>All doors must be closed.</p> <p>Remote start the vehicle.</p>	 <p>UNLOCK</p> <p>Unlock the doors with either:</p> <ul style="list-style-type: none"> • The OEM remote • The remote-starter remote • Or the proximity remote 	 <p>Enter the vehicle with the SMART-KEY.</p>	 <p>DO NOT PRESS THE BRAKE PEDAL.</p> <p>Press and release the Push-to-Start button once.</p>	 <p>Press the brake pedal. The vehicle can now be put in to gear and driven.</p> <p>If the Smart-Key is not detected the vehicle will shut down.</p>
--	---	--	---	---

THAR-FOR3 THARNESST STAND ALONE INSTALLATION

ADDENDUM - SUGGESTED WIRING CONFIGURATION



ONLY COMPATIBLE WITH AUTOMATIC TRANSMISSION VEHICLES.

VEHICLE	YEARS	Vehicle functions supported in this diagram (functional if equipped)																
		Immobilizer bypass	Lock	Unlock	Armn	Disarm	RAP Disable	Parking Lights	Tachometer	Heated seats	Heated Mirrors	Rear defrost	Door Status	Trunk Status	Hood Status*	Hand-Brake Status	Foot-Brake Status	Active OEM Remote Start
FORD Fusion	Key 2014-2019	•	•	•	•	•	•	•	•	•	•	•	•	•	•	•	•	•
	Hybrid Key 2014-2019	•	•	•	•	•	•	•	•	•	•	•	•	•	•	•	•	•

FIRMWARE VERSION

4.01

ONLY - SEULEMENT

To add the firmware version and the options, use the **FLASH LINK UPDATER** or **FLASH LINK MOBILE** tool, sold separately.

Program bypass option IF THE VEHICLE IS NOT EQUIPPED WITH FUNCTIONAL HOOD PIN:	UNIT OPTION	DESCRIPTION
		A11
		Hood trigger (Output Status).
Program bypass option:	UNIT OPTION	DESCRIPTION
	C1	OEM Remote status (Lock/Unlock) monitoring
Program bypass option (Vehicle hybrid only):	UNIT OPTION	DESCRIPTION
	D4	Hybrid mode (Vehicle hybrid only)



Parts required (Not included)

1x THAR-FOR3

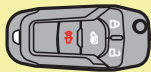

The vehicle must be equipped with the OEM remote with the door locks.

MANDATORY INSTALL

*HOOD PIN



HOOD STATUS: THE HOOD PIN SWITCH MUST BE INSTALLED IF THE VEHICLE CAN BE REMOTE STARTED WITH THE HOOD OPEN, SET FUNCTION A11 TO OFF.

A11

OFF

Notice: the installation of safety elements are mandatory. The hood pin is an essential security element and must be installed.

THIS MODULE MUST BE INSTALLED BY A QUALIFIED TECHNICIAN. A WRONG CONNECTION CAN CAUSE PERMANENT DAMAGE TO THE VEHICLE.

PARTS REQUIRED (NOT INCLUDED)

1x **FLASH LINK UPDATER,**
1x **FLASH LINK MANAGER**
SOFTWARE | PROGRAMME
1x Microsoft Windows Computer with Internet connection

OR

1x **FLASH LINK MOBILE**
1x **FLASH LINK MOBILE APP**
Smartphone *Android* or *iOS* with Internet connection (*provider charges may apply*).

MANDATORY

HOOD PIN



REMOTE START SAFETY OVERRIDE SWITCH

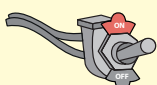







VALET SWITCH

Part #: RSPB available, Sold separately.

Notice: the installation of safety elements are mandatory. The hood pin and the valet switch are essential security elements and must be installed.

STAND ALONE CONFIGURATION

	Program bypass option	UNIT OPTION	DESCRIPTION
	OEM Remote Stand Alone Remote Starter:	D1.10 	By default, LOCK, LOCK, LOCK
		D1.1 	Par défaut, VERROUILLE, VERROUILLE, VERROUILLE
	Program bypass option with oem remote:	C1	OEM Remote Monitoring
	Program bypass option with RF KIT antenna:	H1 to H6	Supported RF Kits and select RF Kit
	Program bypass option Vehicle hybrid only:	D4	Hybrid mode (Vehicle hybrid only)

REMOTE STARTER FUNCTIONALITY



All doors must be closed.

3X 

Press the OEM remote's Lock button 3x to remote-start (or remote-stop) the vehicle.



START

The vehicle will START.

REMOTE STARTER DIAGNOSTICS
MODULE RED LED

x2 flash :	Brake ON
x3 flash :	No tach
x4 flash :	Ignition before start
x5 flash :	Hood Open

REMOTE STARTER WARNING CARD



CUT THIS WARNING CARD AND STICK IT ON A VISIBLE PLACE:
or use the package **RSPB**, Sold separately.

WARNING



REMOTE STARTER

THE VEHICLE CAN BE STARTED BY EITHER: PRESSING THE LOCK BUTTON ON THE OEM REMOTE 3 TIMES CONSECUTIVELY OR BY A SMARTPHONE. **TURN ON** THE SAFETY SWITCH LOCATED UNDER THE DASHBOARD BEFORE WORKING ON THE VEHICLE.

DESCRIPTION



②

Parking Lights switch

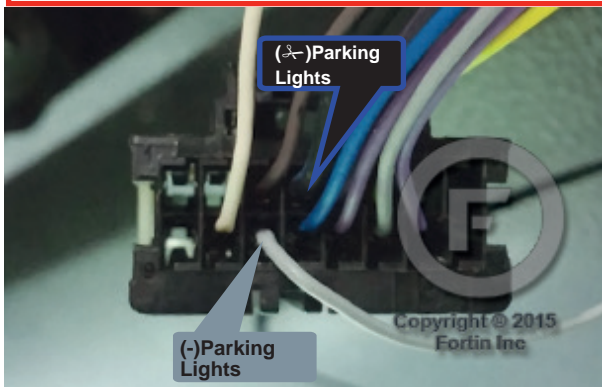

①

Gateway module, Behind OBD-II connector

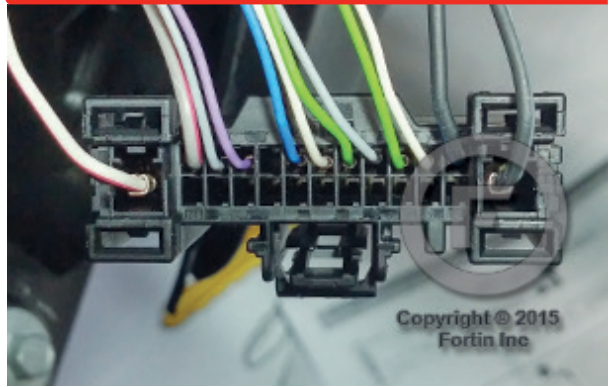

AUTOMATIC TRANSMISSION WIRING CONNECTION

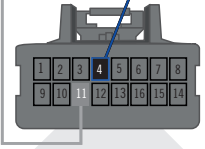
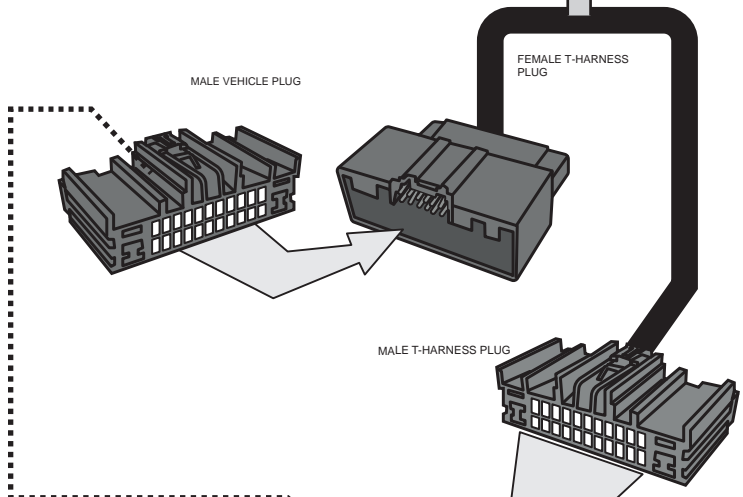
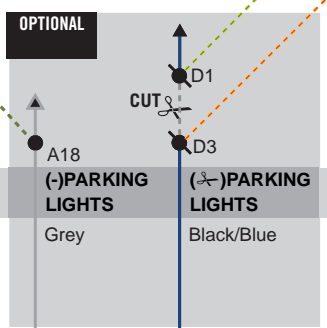
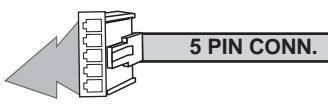
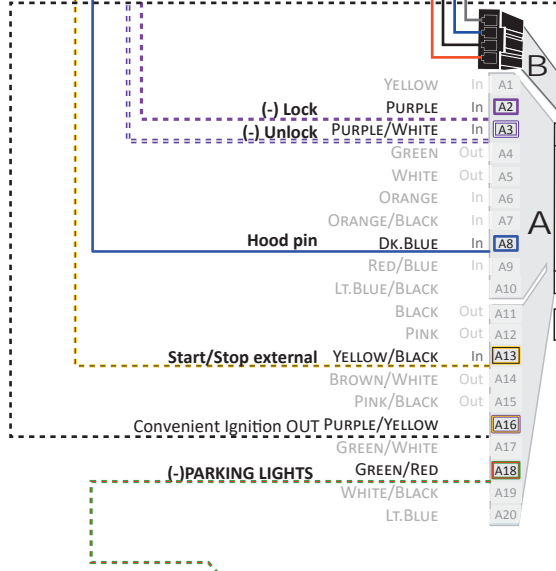
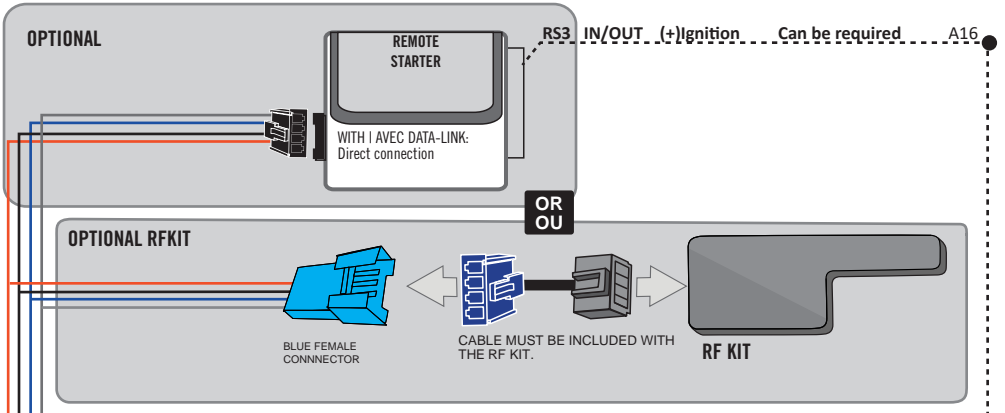
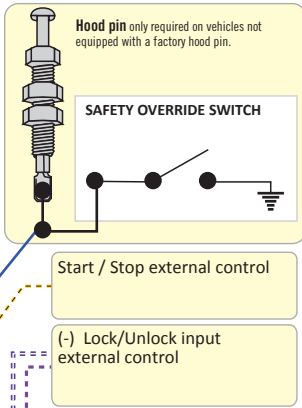

② Parking Lights switch
Back view, 14-pin black connector.

① Gateway module, Connector Behind OBD-II connector - located at dash board driver's side
Back view, 24-pin black connector.

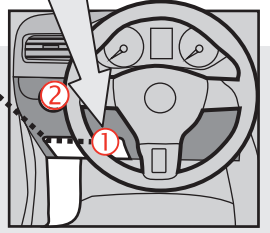

PROGRAMMING PROCEDURE

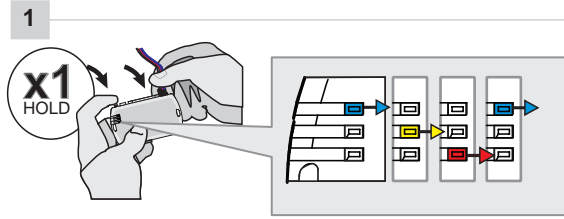

Press and hold the programming button:
Insert the 4-Pin (Data-Link) connector.

↳ The Blue, Red, Yellow and Blue & Red LEDs will alternatively illuminate.

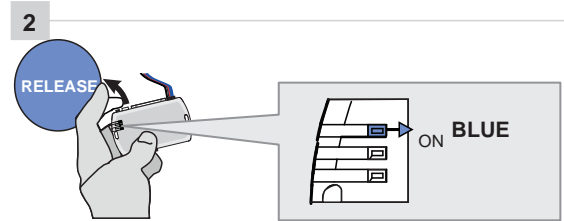

Release the programming button when the LED is BLUE.

If the LED is not solid BLUE disconnect the 4-Pin connector (Data-Link) and go back to step 1.

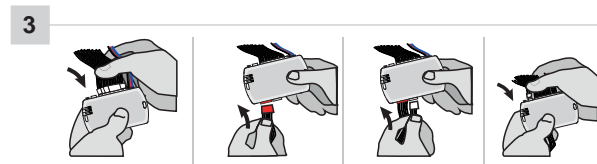

Insert the required remaining connectors.

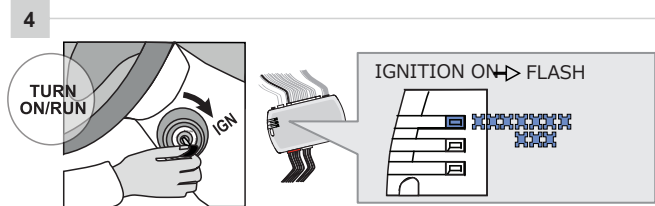

Turn the key to the Ignition ON/RUN position.

↳ The BLUE LED will flash rapidly.

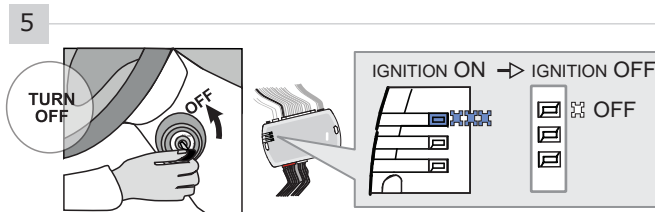

Turn the key to the OFF position.

↳ The BLUE LED will turn off.

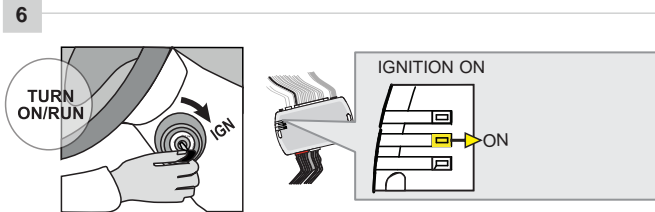

Turn the key to the Ignition ON/RUN position.

↳ The YELLOW LED will turn ON.

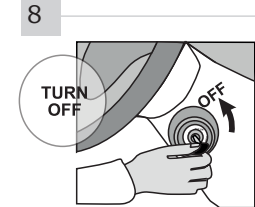
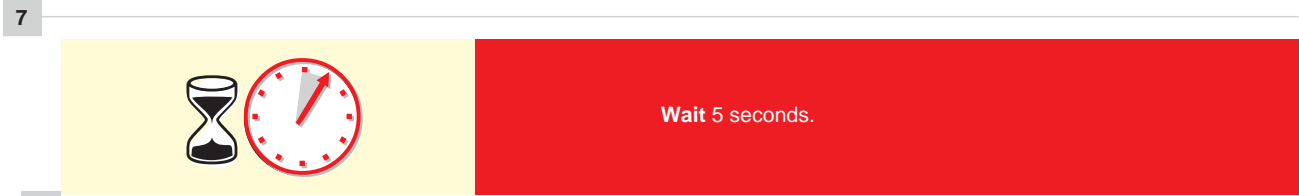

Turn the key to the OFF position.





OPTIONAL RF-KIT PROGRAMMING

PROGRAM BYPASS OPTION







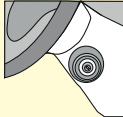



	<p>Program bypass option:</p>	<p>H2</p>	<p>Supported RF-KITS enable H2 Fortin 2</p>
---	-------------------------------	------------------	--

OPTIONAL FORTIN RF KIT SERIES 4 OR SERIES 9 PROGRAMMING

The module must be programmed on the vehicle.

MAKE SURE THE IGNITION KEY HAS BEEN IN THE OFF POSITION FOR AT LEAST 5 SECONDS.

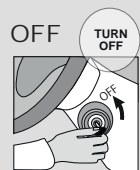
<p>1</p>  <p>ON TURN ON/RUN</p>	<p>2</p>  <p>OFF TURN OFF</p>	<p>3</p>  <p>ON TURN ON/RUN</p>	<p>4</p> <p>4X BRAKES</p>  <p>x4 PRESS</p>	<p>5</p> <p>ON EACH TRANSMITTER</p> <p>4 BUTTONS</p>  <p>PRESS AND RELEASE</p>  <p>PRESS AND RELEASE</p> <p>1 BUTTON</p>  <p>PRESS APPROX. 12 SEC. AND WAIT FOR THE BLUE LED TO TURN OFF THEN BACK ON SOLID THEN RELEASE.</p>	<p>6</p>  <p>OFF TURN OFF</p>	<p>7</p>  <p>ON TURN ON/RUN</p>	<p>8</p>  <p>OFF TURN OFF</p>
<p>Turn the key to the ON/RUN position.</p>	<p>Turn the ignition to the OFF position.</p>	<p>Turn the key to the ON/RUN position.</p>	<p>Press and release the brake pedal four times.</p>	<p>The LED will turn off each time.</p>	<p>Turn the ignition to the OFF position.</p>	<p>Turn the key to the ON/RUN position and leave it ON for 5 sec.</p> 	<p>Turn the ignition to the OFF position.</p>
 <p>The YELLOW LED will turn ON solid.</p>	 <p>The YELLOW LED will turn Off.</p>	 <p>The LED will turn ON solide.</p>	 <p>The LED will flash rapidly.</p>	 <p>The LED will turn off each time.</p>	 <p>The LED will turn Off.</p>	 <p>The LED will turn ON solid.</p>	 <p>The LED will turn Off.</p>
 <p>The 3 LED will turn ON solid.</p>	 <p>The 3 LED will turn off each time.</p>	 <p>The 3 LED will turn ON solid.</p>	 <p>The 3 LED will flash rapidly.</p>	 <p>The 3 LED will turn off each time.</p>	 <p>The 3 LED will turn off.</p>	 <p>The 3 LED will turn ON solid.</p>	 <p>The 3 LED will turn Off.</p>

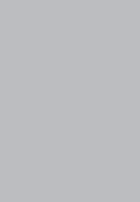
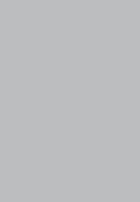
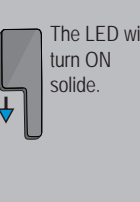
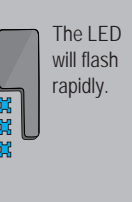
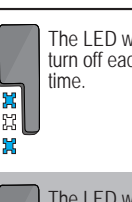
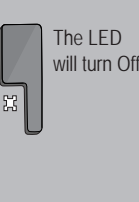
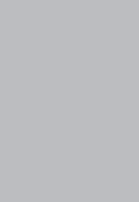
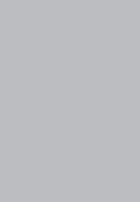
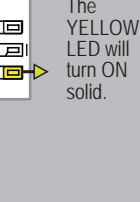
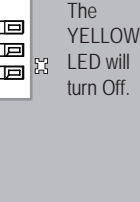
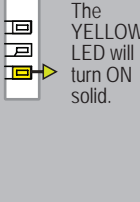
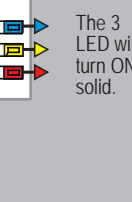
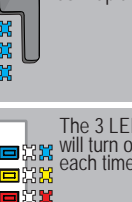
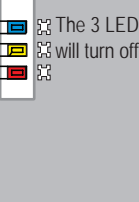
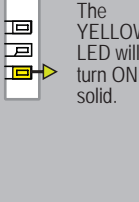
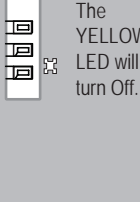

REMOTE STARTER FUNCTIONALITY



All doors must be closed.



Remote start the vehicle.



Unlock the doors with the remote-starter remote or the OEM remote.



Insert and Turn the key to the Ignition ON/RUN position.



Press the brake pedal.



The vehicle can now be put in to gear and driven.

THAR-FOR3 THARNNESS STAND ALONE INSTALLATION

ADDENDUM - SUGGESTED WIRING CONFIGURATION



ONLY COMPATIBLE WITH AUTOMATIC TRANSMISSION VEHICLES.



Vehicle functions supported in this diagram (functional if equipped)

VEHICLE	YEARS	Immobilizer bypass	Lock	Unlock	Arm	Disarm	RAP Disable	Parking Lights	Tachometer	Heated seats	Heated Mirrors	Rear defrost	Door Status	Trunk Status	Hood Status*	Hand-Brake Status	Foot-Brake Status	Active OEM Remote Start	
FORD																			
Mondeo	Key 2013-2015	•	•	•	•	•	•	•	•	•	•	•	•	•	•	•	•	•	•



FIRMWARE VERSION

4.01

ONLY - SEULEMENT

To add the firmware version and the options, use the **FLASH LINK UPDATER** or **FLASH LINK MOBILE** tool, sold separately.



Program bypass option:

UNIT OPTION

DESCRIPTION

C1

OEM Remote status (Lock/Unlock) monitoring

IF THE VEHICLE IS NOT EQUIPPED WITH FUNCTIONAL HOOD PIN:

A11

OFF

Hood trigger (Output Status).



Parts required (Not included)

1x THAR-FOR3

NOTES



The vehicle must be equipped with the OEM remote with the door locks.

MANDATORY INSTALL

***HOOD PIN**



HOOD STATUS: THE HOOD PIN SWITCH MUST BE INSTALLED IF THE VEHICLE CAN BE REMOTE STARTED WITH THE HOOD OPEN, SET FUNCTION A11 TO OFF.

A11

OFF

Notice: the installation of safety elements are mandatory. The hood pin is an essential security element and must be installed.

THIS MODULE MUST BE INSTALLED BY A QUALIFIED TECHNICIAN. A WRONG CONNECTION CAN CAUSE PERMANENT DAMAGE TO THE VEHICLE.

PARTS REQUIRED (NOT INCLUDED)

1x **FLASH LINK UPDATER,**
 1x **FLASH LINK MANAGER**
 SOFTWARE | PROGRAMME
 1x Microsoft Windows Computer with Internet connection

OR

1x **FLASH LINK MOBILE**
 1x **FLASH LINK MOBILE APP**
 Smartphone Android or iOS with Internet connection (provider charges may apply).

MANDATORY

HOOD PIN



REMOTE START SAFETY OVERRIDE SWITCH

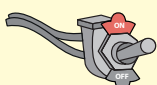







VALET SWITCH

Part #: RSPB available, Sold separately.

Notice: the installation of safety elements are mandatory. The hood pin and the valet switch are essential security elements and must be installed.

STAND ALONE CONFIGURATION

	Program bypass option	UNIT OPTION	DESCRIPTION
	OEM Remote Stand Alone Remote Starter:	D1.10 	By default, LOCK, LOCK, LOCK
		D1.1 	Par défaut, VERROUILLE, VERROUILLE, VERROUILLE
	Program bypass option with oem remote:	C1	OEM Remote Monitoring
	Program bypass option with RF KIT antenna:	H1 to H6	Supported RF Kits and select RF Kit
	Program bypass option Vehicle hybrid only:	D4	Hybrid mode (Vehicle hybrid only)

REMOTE STARTER FUNCTIONALITY



All doors must be closed.

3X 

Press the OEM remote's Lock button 3x to remote-start (or remote-stop) the vehicle.



START 

The vehicle will START.

REMOTE STARTER DIAGNOSTICS
MODULE RED LED

x2 flash :	Brake ON
x3 flash :	No tach
x4 flash :	Ignition before start
x5 flash :	Hood Open

REMOTE STARTER WARNING CARD



CUT THIS WARNING CARD AND STICK IT ON A VISIBLE PLACE:
 or use the package RSPB, Sold separately.

WARNING



REMOTE STARTER

THE VEHICLE CAN BE STARTED BY EITHER: PRESSING THE LOCK BUTTON ON THE OEM REMOTE 3 TIMES CONSECUTIVELY OR BY A SMARTPHONE. **TURN ON** THE SAFETY SWITCH LOCATED UNDER THE DASHBOARD BEFORE WORKING ON THE VEHICLE.

DESCRIPTION

① Gateway module, located at dash board driver's side,



② Parking Lights switch

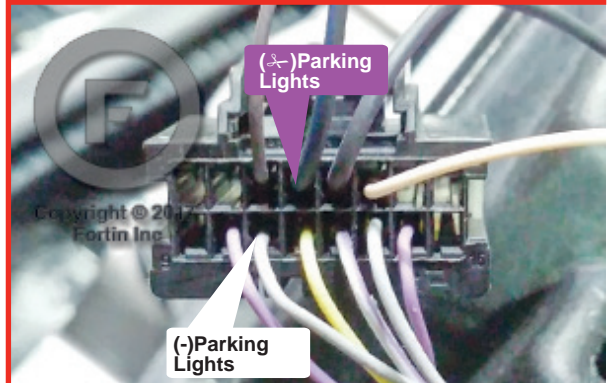

AUTOMATIC TRANSMISSION WIRING CONNECTION

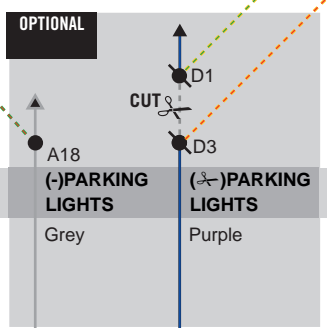
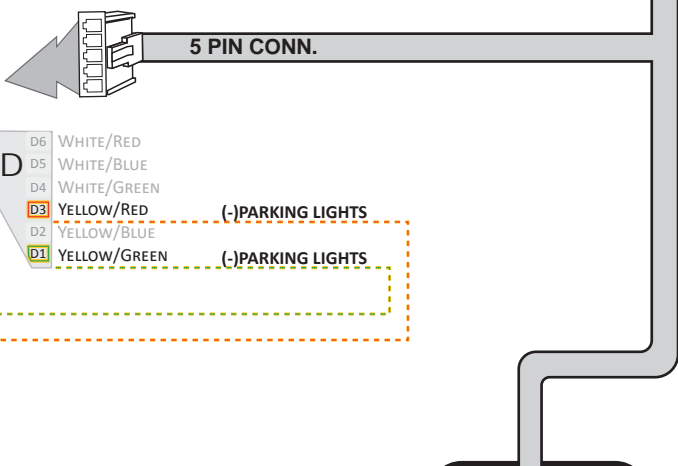
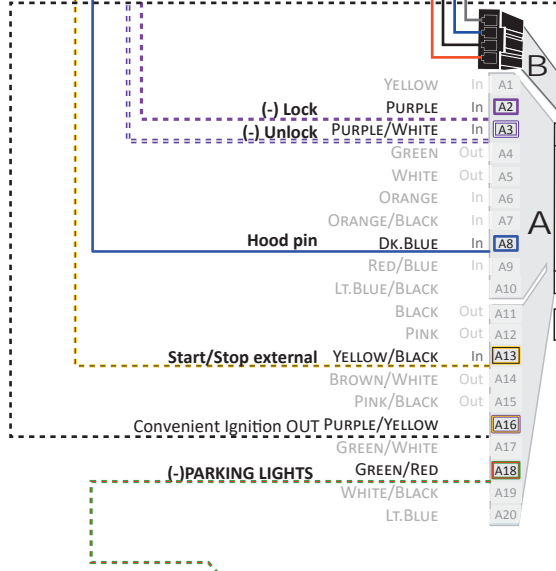
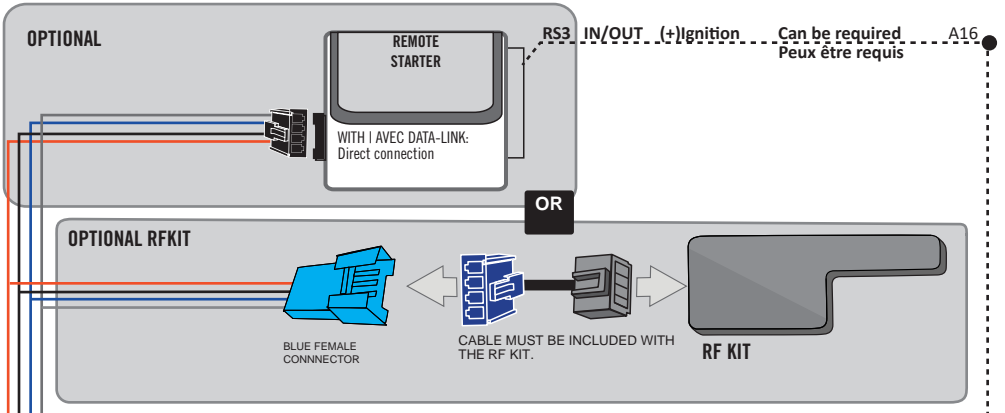
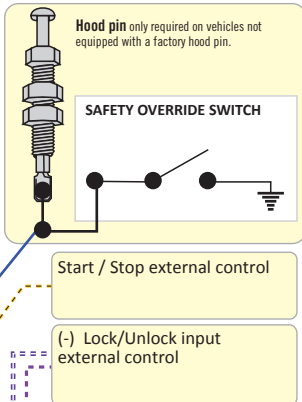

Mondeo

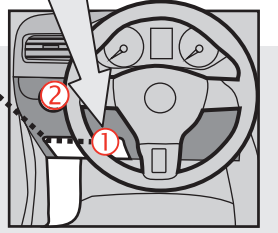
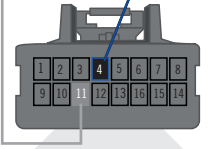
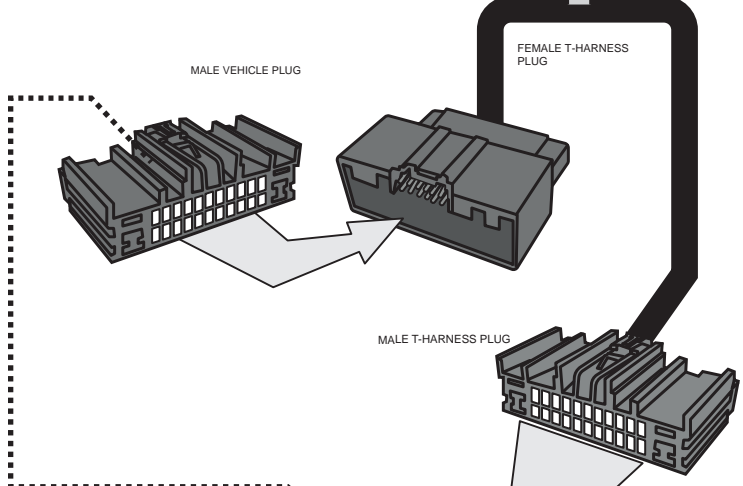

② Parking Lights switch
Back view, 14-pin black connector.

① Gateway module, behind OBD-II connector - located at dash board driver's side - Back view, 24-pin black connector.

PROGRAMMING PROCEDURE

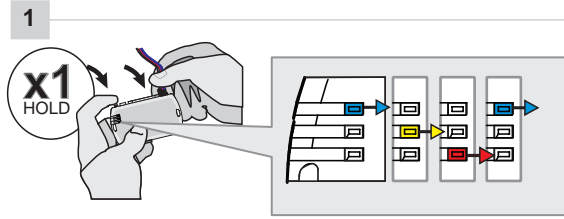

Press and hold the programming button:
Insert the 4-Pin (Data-Link) connector.

↳ The Blue, Red, Yellow and Blue & Red LEDs will alternatively illuminate.

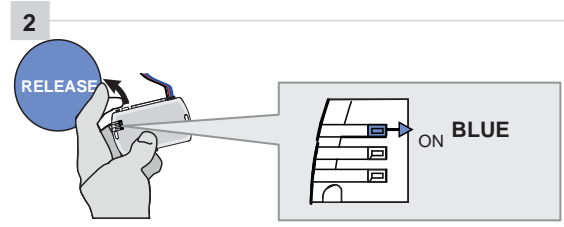

Release the programming button when the LED is BLUE.

If the LED is not solid BLUE disconnect the 4-Pin connector (Data-Link) and go back to step 1.

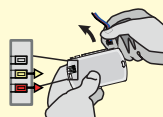
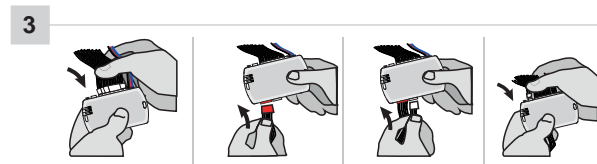

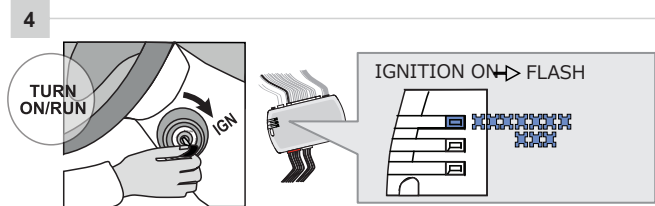

Insert the required remaining connectors.

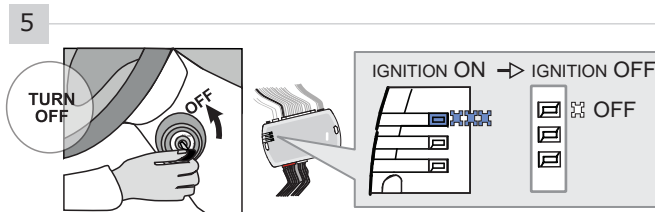

Turn the key to the Ignition ON/RUN position.

↳ The BLUE LED will flash rapidly.



Turn the key to the OFF position.

↳ The BLUE LED will turn off.

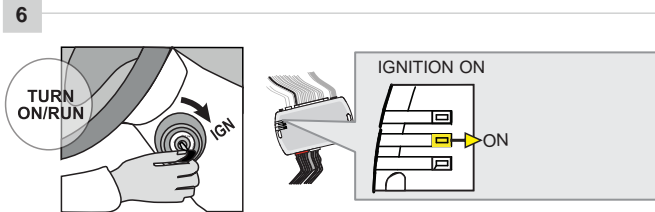

Turn the key to the Ignition ON/RUN position.

↳ The YELLOW LED will turn ON.



Wait 5 seconds.

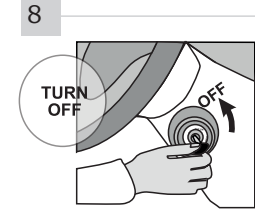

Turn the key to the OFF position.



The module is now programmed.

REMOTE STARTER FUNCTIONALITY



All doors must be closed.



Remote start the vehicle.



Unlock the doors with the remote-starter remote or the OEM remote.

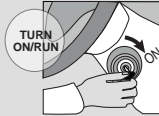

Insert and Turn the key to the Ignition ON/RUN position.



Press the brake pedal.



The vehicle can now be put in to gear and driven.

THAR-FOR3 THARNNESS STAND ALONE INSTALLATION

ADDENDUM - SUGGESTED WIRING CONFIGURATION

ONLY COMPATIBLE WITH AUTOMATIC TRANSMISSION VEHICLES.

VEHICLE	YEARS	Vehicle functions supported in this diagram (functional if equipped)														
		KEY CONTROL	T-Harness	Lock	Unlock	Arm	Disarm	RAP Disable	Parking Lights	Tachometer	Door Status	Trunk Status	Hood Status*	Hand-Brake Status	Foot-Brake Status	OEM Remote monitoring
FORD																
Mustang	PTS 2015-2018	•	•	•	•	•	•	•	•	•	•	•	•	•	•	•



HARDWARE VERSION

MINIMUM **6**

4.05

ONLY - SEULEMENT

To add the firmware version and the options, use the **FLASH LINK UPDATER** or **FLASH LINK MOBILE** tool, sold separately.

	Program bypass option	UNIT OPTION	DESCRIPTION
	IF THE VEHICLE IS NOT EQUIPPED WITH FUNCTIONAL HOOD PIN:	A11	OFF
	Program bypass option:	C1	OEM Remote status (Lock/Unlock) monitoring
		D6	Push-to-Start

- Parts required (Not included)**

 - 1X Vehicle key
 - 1X 7.5 Amp. Fuse
 - 1X Relay
 - 1X Diode

MANDATORY INSTALL

***HOOD PIN**

HOOD STATUS: THE HOOD PIN SWITCH MUST BE INSTALLED IF THE VEHICLE CAN BE REMOTE STARTED WITH THE HOOD OPEN, SET FUNCTION **A11** TO OFF.

A11

OFF

Notice: the installation of safety elements are mandatory. The hood pin is an essential security element and must be installed.

THIS MODULE MUST BE INSTALLED BY A QUALIFIED TECHNICIAN. A WRONG CONNECTION CAN CAUSE PERMANENT DAMAGE TO THE VEHICLE.

PARTS REQUIRED (NOT INCLUDED)

1x **FLASH LINK UPDATER, FLASH LINK MANAGER**
SOFTWARE | PROGRAMME
1x Microsoft Windows Computer with Internet connection

OR

1x **FLASH LINK MOBILE, FLASH LINK MOBILE APP**
Smartphone Android or iOS with Internet connection (provider charges may apply).

MANDATORY

HOOD PIN



REMOTE START SAFETY OVERRIDE SWITCH

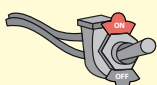







VALET SWITCH

Part #: RSPB available, Sold separately.

Notice: the installation of safety elements are mandatory. The hood pin and the valet switch are essential security elements and must be installed.

STAND ALONE CONFIGURATION

	Program bypass option	UNIT OPTION	DESCRIPTION
	OEM Remote Stand Alone Remote Starter:	D1.10 	By default, LOCK, LOCK, LOCK Par défaut, VERROUILLE, VERROUILLE, VERROUILLE
		D1.1 	
	Program bypass option with oem remote:	C1	OEM Remote Monitoring
	Program bypass option with RF KIT antenna:	H1 to H6	Supported RF Kits and select RF Kit
	Program bypass option Vehicle hybrid only:	D4	Hybrid mode (Vehicle hybrid only)

REMOTE STARTER FUNCTIONALITY



All doors must be closed.

3X 

Press the OEM remote's Lock button 3x to remote-start (or remote-stop) the vehicle.



START

The vehicle will START.

REMOTE STARTER DIAGNOSTICS
MODULE RED LED

x2 flash :	Brake ON
x3 flash :	No tach
x4 flash :	Ignition before start
x5 flash :	Hood Open

REMOTE STARTER WARNING CARD



CUT THIS WARNING CARD AND STICK IT ON A VISIBLE PLACE:
or use the package RSPB, Sold separately.

WARNING



REMOTE STARTER

THE VEHICLE CAN BE STARTED BY EITHER: PRESSING THE LOCK BUTTON ON THE OEM REMOTE 3 TIMES CONSECUTIVELY OR BY A SMARTPHONE. **TURN ON** THE SAFETY SWITCH LOCATED UNDER THE DASHBOARD BEFORE WORKING ON THE VEHICLE.

DESCRIPTION

③ ④ BCM, Passenger kick panel

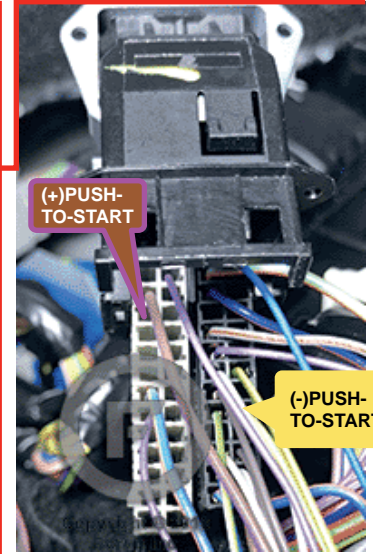
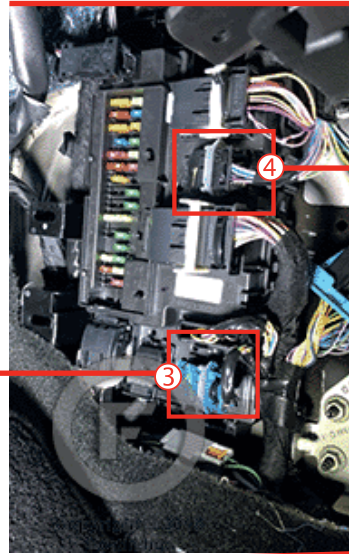
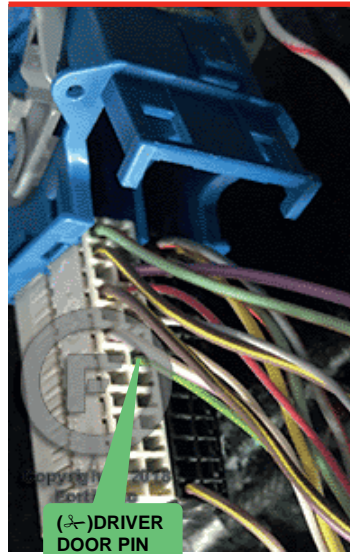

② Parking Lights switch

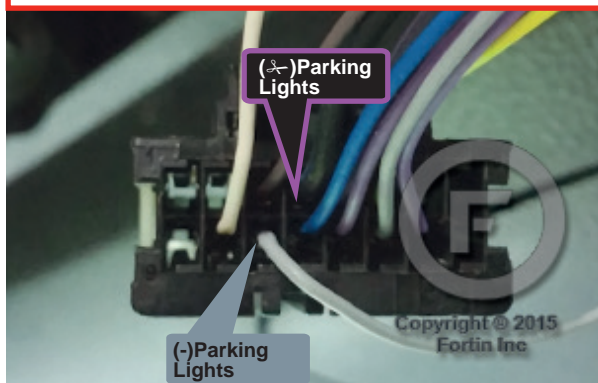

① Gateway module, located at right of steering column.

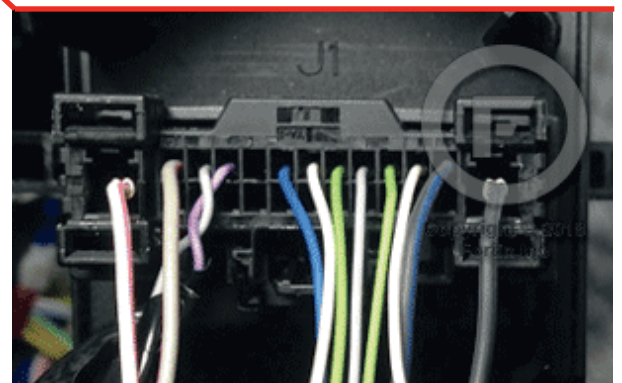

AUTOMATIC TRANSMISSION WIRING CONNECTION

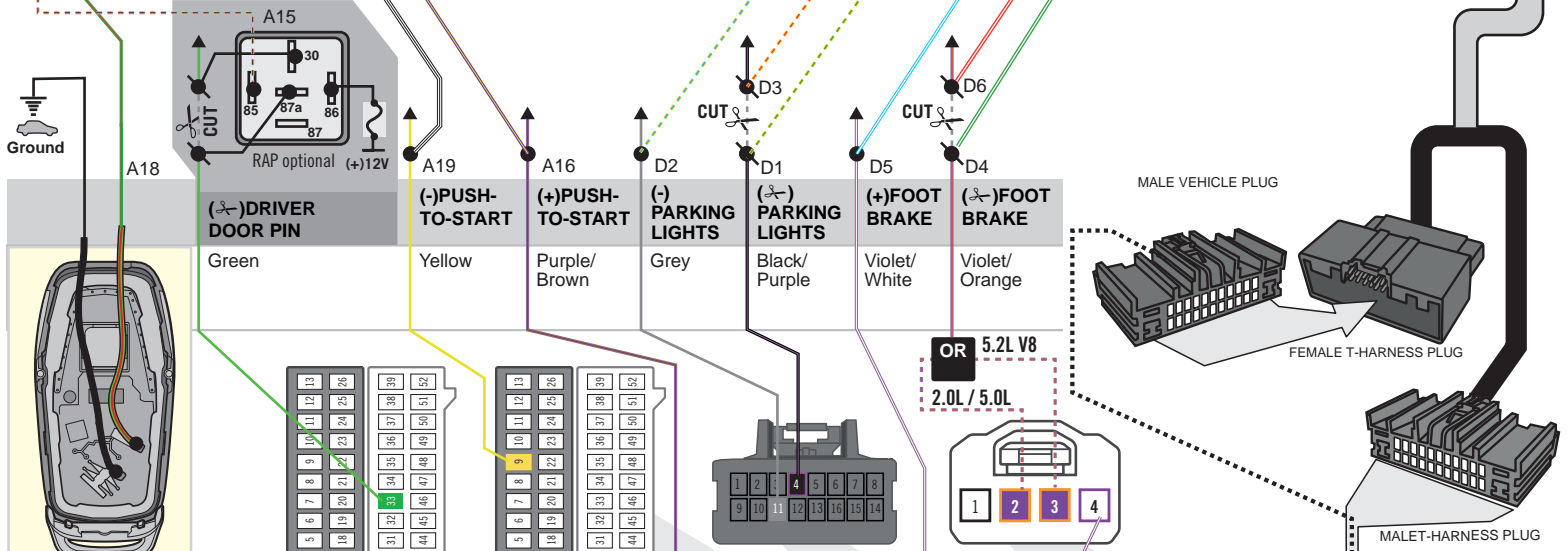
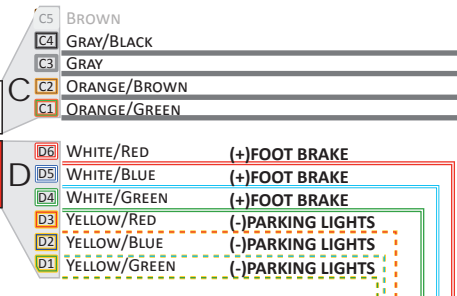
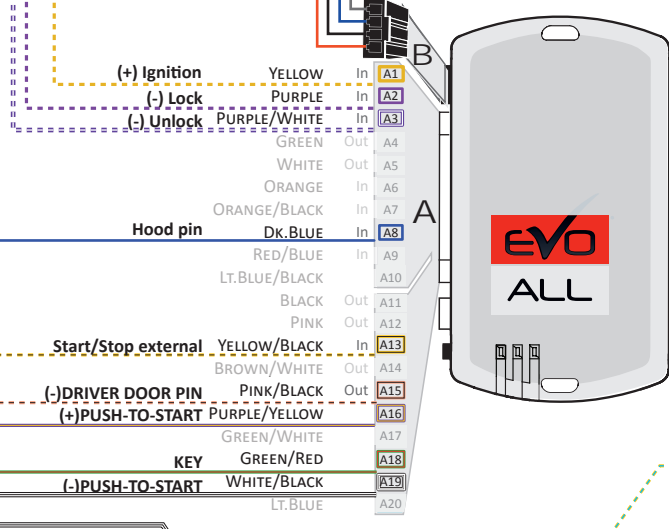
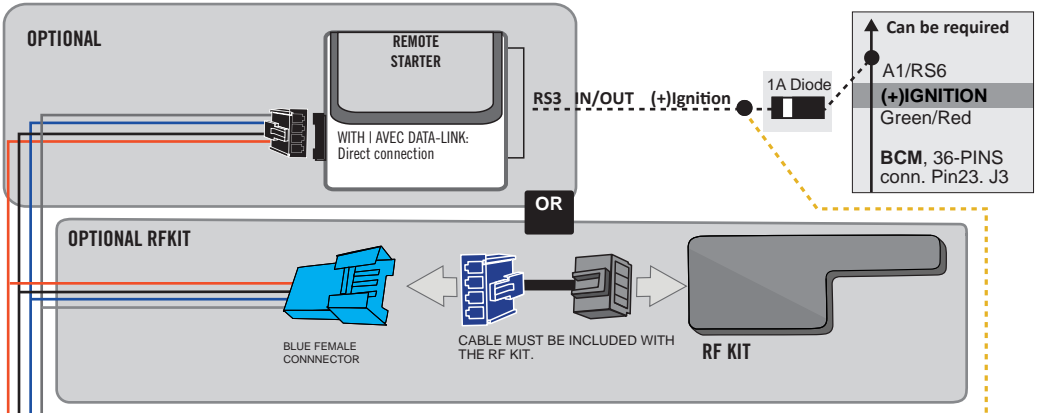
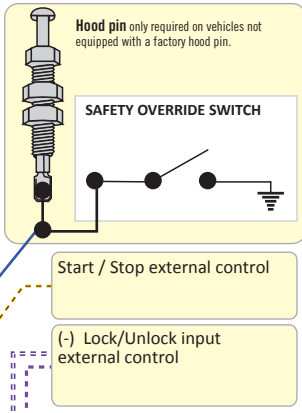

- Open the remote control.
- Remove the batteries.
- Solder onto the contacts of the battery as shown.
- Place the remote control in the indicated area.

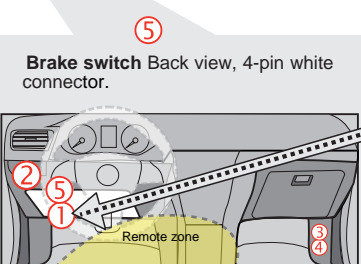
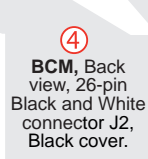
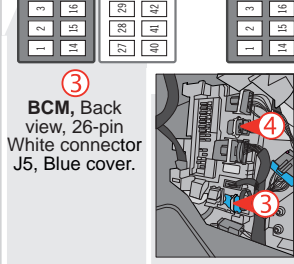

T-HARNESS - HARNAIS ENT THAR-FOR3

PROGRAMMING PROCEDURE

1

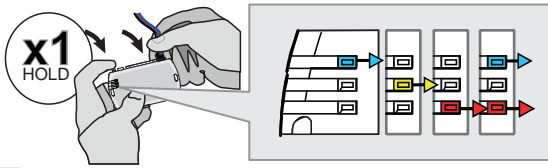

Press and hold the programming button:
Connect the 4-Pin Data-link connector.

↳ The BLUE, RED, YELLOW and BLUE & RED LEDs will alternatively illuminate.

2

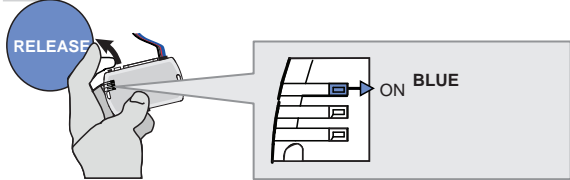

Release the programming button when the LED is BLUE.

If the LED is not solid BLUE disconnect the 4-Pin connector (Data-Link) and go back to step 1.

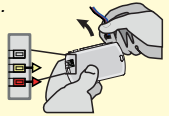

3

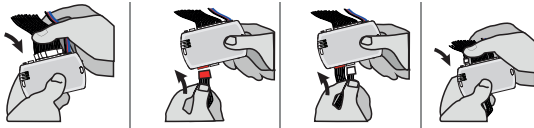

Insert the required remaining connectors.

4

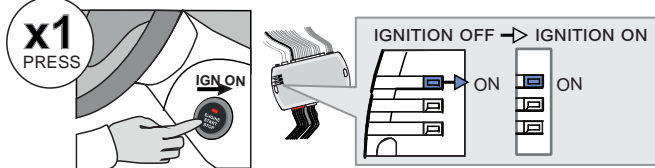

Press the Push-to-Start button to turn ON the ignition.

5

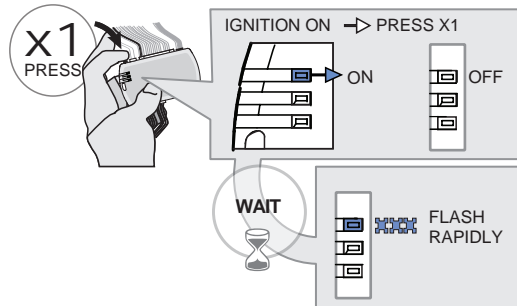

Press and release the programming button once (1x).

↳ The BLUE LED will turn off.

Wait,

↳ The BLUE LED will flash rapidly.

6

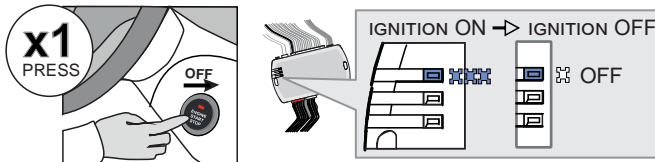

Press the Push-to-Start button once to turn off the ignition.

↳ The BLUE LED will turn off.



The module is now programmed.

OPTIONAL RF-KIT PROGRAMMING

PROGRAM BYPASS OPTION



Program bypass option:

H2

Supported RF-KITS enable

H2 Fortin 2

OPTIONAL FORTIN RF KIT SERIES 4 OR SERIES 9 PROGRAMMING



The module must be programmed on the vehicle.



MAKE SURE THE IGNITION KEY HAS BEEN IN THE OFF POSITION FOR AT LEAST 5 SECONDS.

<p>1</p> <p>ON x1 PRESS</p> <p>Do not press the brake pedal. Press the Push-to-Start button once to turn on the ignition.</p>	<p>2</p> <p>OFF x1 PRESS</p> <p>Press the Push-to-Start button once to turn off the ignition.</p>	<p>3</p> <p>ON x1 PRESS</p> <p>Do not press the brake pedal. Press the Push-to-Start button once to turn on the ignition.</p>	<p>4</p> <p>4X BRAKES</p> <p>x4 PRESS</p> <p>Press and release the brake pedal four times.</p>	<p>5</p> <p>ON EACH TRANSMITTER</p> <p>4 BUTTONS 4 BOUTONS</p> <p>[-] PRESS AND RELEASE</p> <p>→ PRESS AND RELEASE</p> <p>1 BUTTON</p> <p>PRESS APPROX. 12 SEC. AND WAIT FOR THE BLUE LED TO TURN OFF THEN BACK ON SOLID THEN RELEASE.</p>	<p>6</p> <p>OFF x1 PRESS</p> <p>Press the Push-to-Start button once to turn off the ignition.</p>	<p>7</p> <p>ON x1 PRESS</p> <p>Do not press the brake pedal. Press the Push-to-Start button once to turn on the ignition and leave it ON for 5 sec..</p>	<p>8</p> <p>OFF x1 PRESS</p> <p>Press the Push-to-Start button once to turn off the ignition.</p>
<p>The YELLOW LED will turn ON solid.</p>	<p>The YELLOW LED will turn Off.</p>	<p>The LED will turn ON solide.</p> <p>The YELLOW LED will turn ON solid.</p>	<p>The LED will flash rapidly.</p> <p>The LED will turn off each time.</p> <p>The 3 LED will turn ON solid.</p>	<p>The LED will flash rapidly.</p> <p>The LED will turn off each time.</p> <p>The 3 LED will turn off each time.</p>	<p>The LED will turn Off.</p> <p>The 3 LED will turn off.</p>	<p>The YELLOW LED will turn ON solid.</p>	<p>The YELLOW LED will turn Off.</p>



REMOTE STARTER FUNCTIONALITY



All doors must be closed.



Remote start the vehicle.



Unlock the doors with either:

- The OEM remote
- The remote-starter remote
- Or the proximity remote



Enter the vehicle with the Intelligent Key.



The vehicle can now be put in to gear and driven.

If the vehicle is not unlocked with one of these conditions the remote-starter will shut down as soon as any door is opened.



THAR-FOR3 THARNNESS STAND ALONE INSTALLATION

ADDENDUM - SUGGESTED WIRING CONFIGURATION



ONLY COMPATIBLE WITH AUTOMATIC TRANSMISSION VEHICLES.



VEHICLE

YEARS

Vehicle functions supported in this diagram (functional if equipped)

VEHICLE	YEARS	Immobilizer bypass	Lock	Unlock	Armn	Disarm	RAP Disable	Parking Lights	Tachometer	Heated seats	Heated Mirrors	Rear defrost	Door Status	Trunk Status	Hood Status*	Hand-Brake Status	Foot-Brake Status	Active OEM Remote Start	
LINCOLN																			
Nautilus	Push-to-Start 2019	•	•	•	•	•	•	•	•	•	•	•	•	•	•	•	•	•	•
Navigator	Push-to-Start 2018-2019	•	•	•	•	•	•	•	•	•	•	•	•	•	•	•	•	•	•



FIRMWARE VERSION

4.01

ONLY - SEULEMENT

To add the firmware version and the options, use the **FLASH LINK UPDATER** or **FLASH LINK MOBILE** tool, sold separately.



Program bypass option:

UNIT OPTION

DESCRIPTION

C1

OEM Remote status (Lock/Unlock) monitoring

D6

Push-to-Start

IF THE VEHICLE IS NOT EQUIPPED WITH FUNCTIONAL HOOD PIN:

A11

OFF

Hood trigger (Output Status).



Parts required (Not included)

1x THAR-FOR3

MANDATORY INSTALL

***HOOD PIN**



HOOD STATUS: THE HOOD PIN SWITCH MUST BE INSTALLED IF THE VEHICLE CAN BE REMOTE STARTED WITH THE HOOD OPEN, SET FUNCTION **A11** TO OFF.

A11

OFF

Notice: the installation of safety elements are mandatory. The hood pin is an essential security element and must be installed.

THIS MODULE MUST BE INSTALLED BY A QUALIFIED TECHNICIAN. A WRONG CONNECTION CAN CAUSE PERMANENT DAMAGE TO THE VEHICLE.

PARTS REQUIRED (NOT INCLUDED)

1x **FLASH LINK UPDATER,**
1x **FLASH LINK MANAGER**
SOFTWARE | PROGRAMME
1x Microsoft Windows Computer with Internet connection

OR

1x **FLASH LINK MOBILE**
1x **FLASH LINK MOBILE APP**
Smartphone Android or iOS with Internet connection (provider charges may apply).

MANDATORY

HOOD PIN



REMOTE START SAFETY OVERRIDE SWITCH

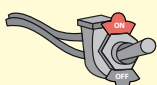







VALET SWITCH

Part #: RSPB available, Sold separately.

Notice: the installation of safety elements are mandatory. The hood pin and the valet switch are essential security elements and must be installed.

STAND ALONE CONFIGURATION

	Program bypass option	UNIT OPTION	DESCRIPTION
	OEM Remote Stand Alone Remote Starter:	D1.10 	By default, LOCK, LOCK, LOCK
		D1.1 	Par défaut, VERROUILLE, VERROUILLE, VERROUILLE
	Program bypass option with oem remote:	C1	OEM Remote Monitoring
	Program bypass option with RF KIT antenna:	H1 to H6	Supported RF Kits and select RF Kit
	Program bypass option Vehicle hybrid only:	D4	Hybrid mode (Vehicle hybrid only)

REMOTE STARTER FUNCTIONALITY



All doors must be closed.

3X 

Press the OEM remote's Lock button 3x to remote-start (or remote-stop) the vehicle.



START 

The vehicle will START.

REMOTE STARTER DIAGNOSTICS
MODULE RED LED

x2 flash :	Brake ON
x3 flash :	No tach
x4 flash :	Ignition before start
x5 flash :	Hood Open

REMOTE STARTER WARNING CARD



CUT THIS WARNING CARD AND STICK IT ON A VISIBLE PLACE:
or use the package RSPB, Sold separately.



WARNING

REMOTE STARTER

THE VEHICLE CAN BE STARTED BY EITHER: PRESSING THE LOCK BUTTON ON THE OEM REMOTE 3 TIMES CONSECUTIVELY OR BY A SMARTPHONE. **TURN ON** THE SAFETY SWITCH LOCATED UNDER THE DASHBOARD BEFORE WORKING ON THE VEHICLE.

DESCRIPTION



② Parking Lights switch

① Gateway module, Behind OBD-II connector

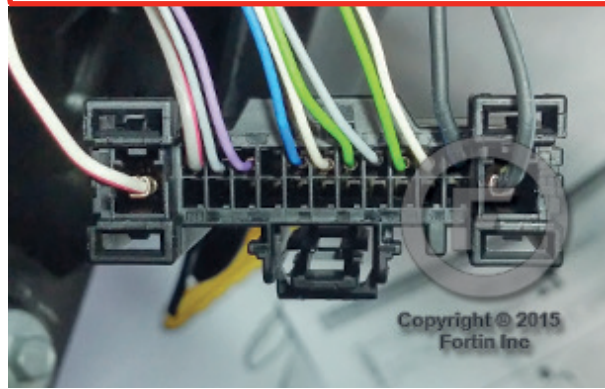
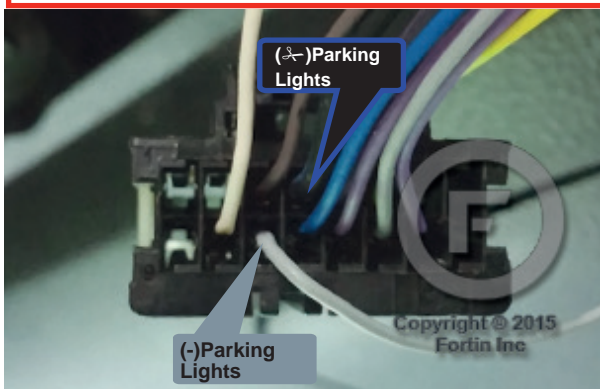

AUTOMATIC TRANSMISSION WIRING CONNECTION

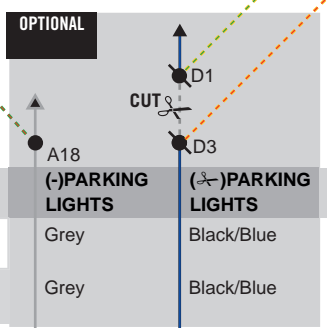
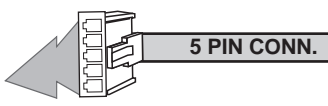
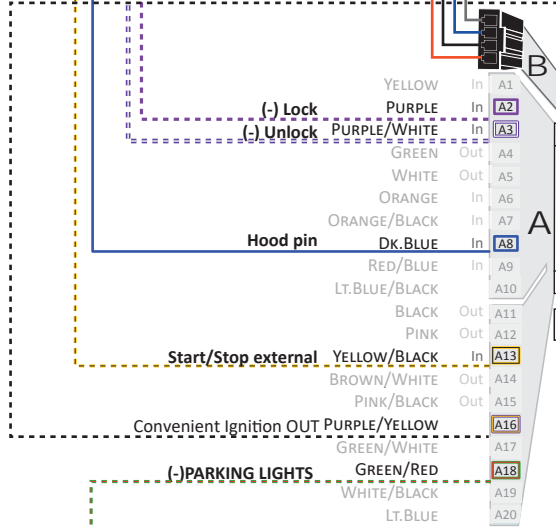
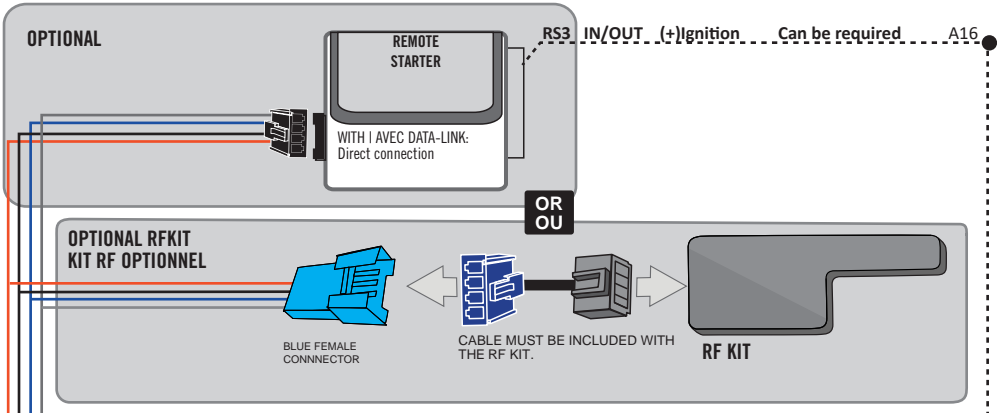
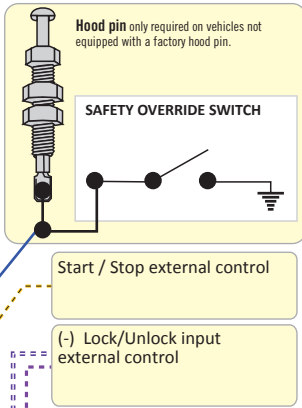

Nautilus	Grey	Black/Blue
Navigator	Grey	Black/Blue

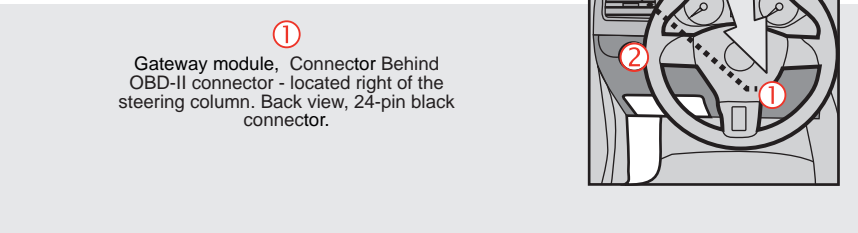
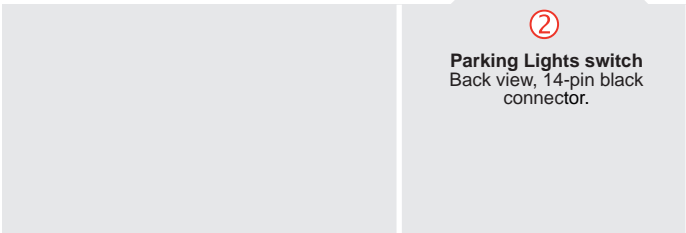
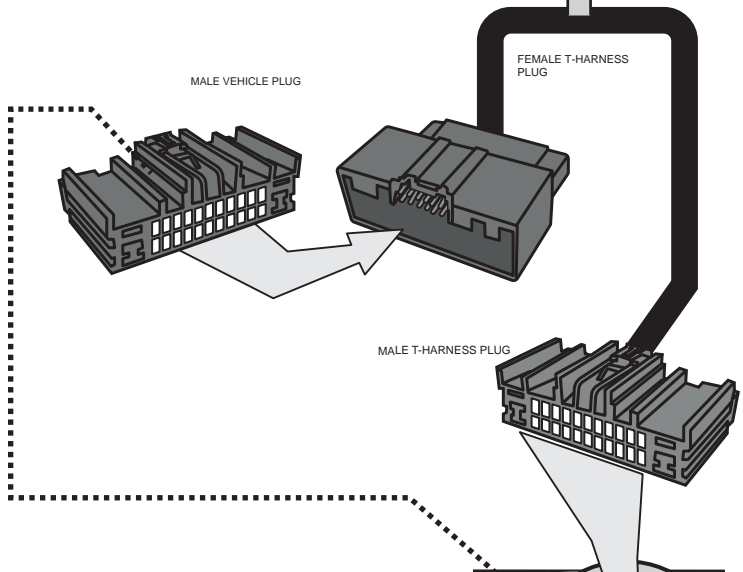

PROGRAMMING PROCEDURE

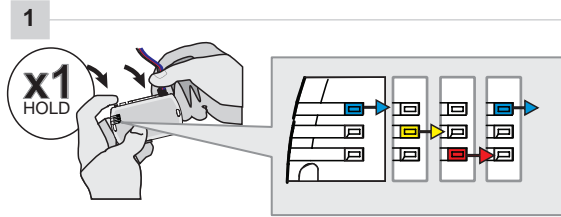

Press and hold the programming button:
Insert the 4-Pin (Data-Link) connector.

↳ The Blue, Red, Yellow and Blue & Red LEDs will alternatively illuminate.

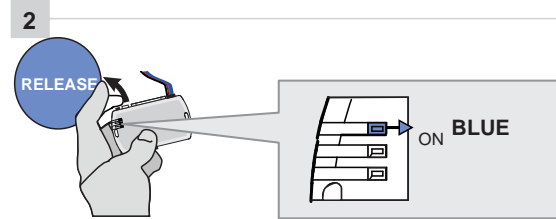

Release the programming button when the LED is BLUE.

If the LED is not solid BLUE disconnect the 4-Pin connector (Data-Link) and go back to step 1.

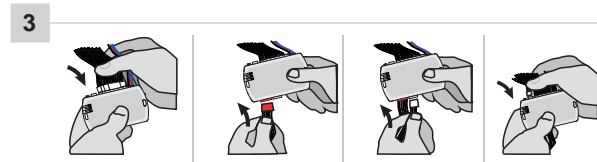

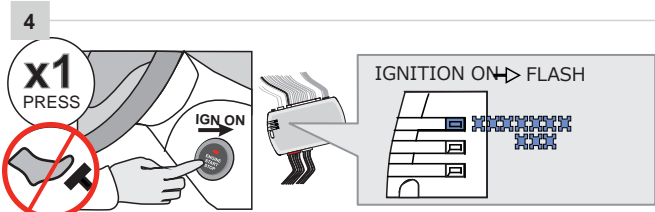

Insert the required remaining connectors.

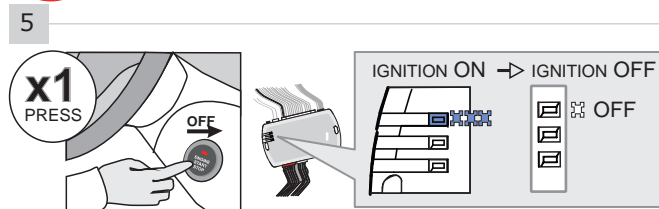

Do not press the brake pedal.
Press the Push-to-Start button once to turn on the ignition.

↳ The BLUE LED will flash rapidly.



Press the Push-to-Start button once to turn off the ignition.

↳ The BLUE LED will turn off.

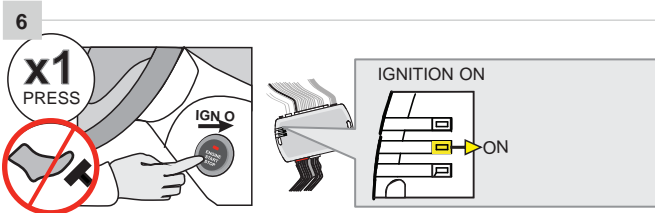

Do not press the brake pedal.
Press the Push-to-Start button once to turn on the ignition.

↳ The YELLOW LED will turn ON.

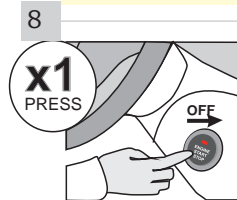
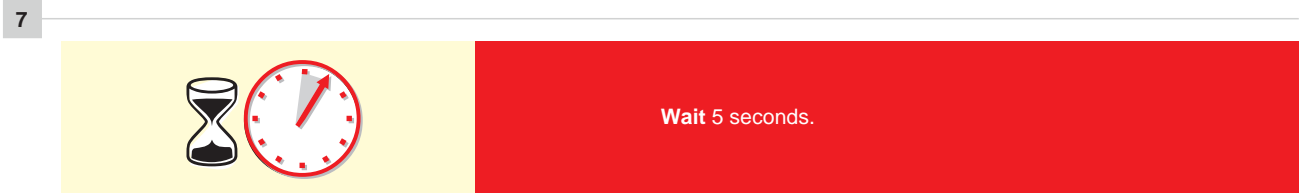

Press the Push-to-Start button once to turn off the ignition.

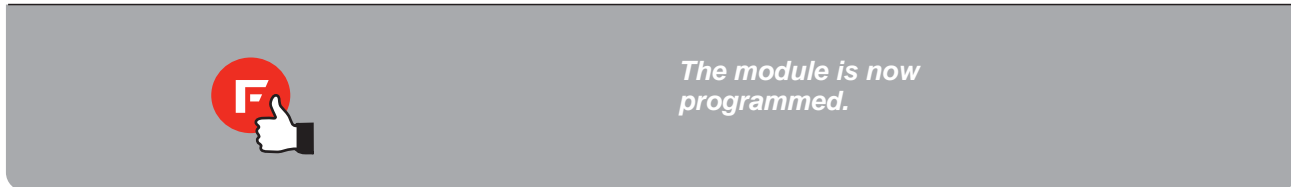

OPTIONAL RF-KIT PROGRAMMING



PROGRAM BYPASS OPTION

	<p>Program bypass option:</p>	<p>H2</p>	<p>Supported RF-KITS enable</p> <p>H2 Fortin 2</p>

OPTIONAL FORTIN RF KIT SERIES 4 OR SERIES 9 PROGRAMMING



The module must be programmed on the vehicle.

MAKE SURE THE IGNITION KEY HAS BEEN IN THE OFF POSITION FOR AT LEAST 5 SECONDS.

1

ON **x1** PRESS



Do not press the brake pedal. **Press** the Push-to-Start button once to turn on the ignition.

2

OFF **x1** PRESS



Press the Push-to-Start button once to turn off the ignition.

3

ON **x1** PRESS



Do not press the brake pedal. **Press** the Push-to-Start button once to turn on the ignition.

4

4X BRAKES

x4 PRESS



Press and release the brake pedal four times.

The LED will turn off each time.

5

ON EACH TRANSMITTER

4 BUTTONS

[-] PRESS AND RELEASE

→ PRESS AND RELEASE

LOCK PRESS AND RELEASE

1 BUTTON 1 BOUTON

PRESS APPROX. 12 SEC. AND WAIT FOR THE BLUE LED TO TURN OFF THEN BACK ON SOLID THEN RELEASE.

6

OFF **x1** PRESS



Press the Push-to-Start button once to turn off the ignition.

The YELLOW LED will turn ON solid.



The YELLOW LED will turn Off.



The YELLOW LED will turn ON solid.



The 3 LED will turn ON solid.

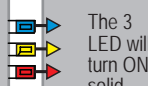

The LED will turn off each time.



The LED will flash rapidly.



The LED will turn Off.



The 3 LED will turn off.

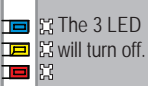



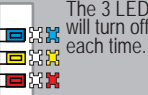

The 3 LED will turn off each time.



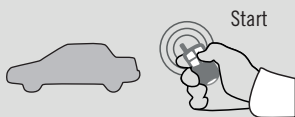

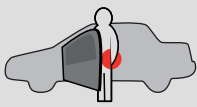
REMOTE STARTER FUNCTIONALITY

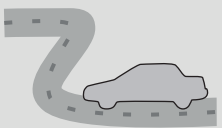
 <p>Start</p> <p>All doors must be closed.</p> <p>Remote start the vehicle.</p>	 <p>UNLOCK</p> <p>Unlock the doors with either:</p> <ul style="list-style-type: none"> • The OEM remote • The remote-starter remote • Or the proximity remote 	 <p>Enter the vehicle with the SMART-KEY.</p>	 <p>DO NOT PRESS THE BRAKE PEDAL.</p> <p>Press and release the Push-to-Start button once.</p>	 <p>Press the brake pedal. The vehicle can now be put in to gear and driven.</p> <p>If the Smart-Key is not detected the vehicle will shut down.</p>
--	---	--	---	---

THAR-FOR3 THARNNESS STAND ALONE INSTALLATION

ADDENDUM - SUGGESTED WIRING CONFIGURATION



ONLY COMPATIBLE WITH AUTOMATIC TRANSMISSION VEHICLES.



Vehicle functions supported in this diagram (functional if equipped)

VEHICLE	YEARS	Immobilizer bypass	T-Harness	Lock	Unlock	Arm	Disarm	RAP Disable	Horn	Parking Lights	Tachometer	Heated seats	Heated Mirrors	Rear defrost	Door Status	Trunk Status	Hood Status*	Hand-Brake Status	Foot-Brake Status	Active OEM Remote Start	
FORD Ranger	Push-to-Start 2019	•	•	•	•	•	•	•	•	•	•	•	•	•	•	•	•	•	•	•	•



FIRMWARE VERSION

4.01

ONLY - SEULEMENT

To add the firmware version and the options, use the **FLASH LINK UPDATER** or **FLASH LINK MOBILE** tool, sold separately.



**Program bypass option
IF THE VEHICLE IS NOT EQUIPPED
WITH FUNCTIONAL HOOD PIN:**

UNIT OPTION

A11

OFF

DESCRIPTION

Hood trigger (Output Status).



Program bypass option:

UNIT OPTION

C1

DESCRIPTION

OEM Remote status (Lock/Unlock) monitoring



Parts required (Not included)

1x 7.5Amp. Fuse

MANDATORY INSTALL

*HOOD PIN



HOOD STATUS: THE HOOD PIN SWITCH MUST BE INSTALLED IF THE VEHICLE CAN BE REMOTE STARTED WITH THE HOOD OPEN, SET FUNCTION **A11** TO OFF.

A11

OFF

Notice: the installation of safety elements are mandatory. The hood pin is an essential security element and must be installed.

THIS MODULE MUST BE INSTALLED BY A QUALIFIED TECHNICIAN. A WRONG CONNECTION CAN CAUSE PERMANENT DAMAGE TO THE VEHICLE.

PARTS REQUIRED (NOT INCLUDED)

1x **FLASH LINK UPDATER, FLASH LINK MANAGER**
SOFTWARE | PROGRAMME
1x Microsoft Windows Computer with Internet connection

OR

1x **FLASH LINK MOBILE, FLASH LINK MOBILE APP**
Smartphone Android or iOS with Internet connection (provider charges may apply).

MANDATORY

HOOD PIN



REMOTE START SAFETY OVERRIDE SWITCH

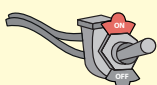





VALET SWITCH

Part #: RSPB available, Sold separately.

Notice: the installation of safety elements are mandatory. The hood pin and the valet switch are essential security elements and must be installed.

STAND ALONE CONFIGURATION

	Program bypass option	UNIT OPTION	DESCRIPTION
	OEM Remote Stand Alone Remote Starter:	D1.10 	By default, LOCK, LOCK, LOCK Par défaut, VERROUILLE,VERROUILLE,VERROUILLE
		D1.1 	
	Program bypass option with oem remote:	C1	OEM Remote Monitoring
	Program bypass option with RF KIT antenna:	H1 to H6	Supported RF Kits and select RF Kit

REMOTE STARTER FUNCTIONALITY



All doors must be closed.

3X 

Press the OEM remote's Lock button 3x to remote-start (or remote-stop) the vehicle.



START

The vehicle will START.

REMOTE STARTER DIAGNOSTICS
MODULE RED LED

x2 flash :	Brake ON
x3 flash :	No tach
x4 flash :	Ignition before start
x5 flash :	Hood Open

REMOTE STARTER WARNING CARD



CUT THIS WARNING CARD AND STICK IT ON A VISIBLE PLACE:
or use the package RSPB, Sold separately.

WARNING



REMOTE STARTER

THE VEHICLE CAN BE STARTED BY EITHER: PRESSING THE LOCK BUTTON ON THE OEM REMOTE 3 TIMES CONSECUTIVELY OR BY A SMARTPHONE. **TURN ON** THE SAFETY SWITCH LOCATED UNDER THE DASHBOARD BEFORE WORKING ON THE VEHICLE.

DESCRIPTION



① Gateway module, located at dash board driver's side,



AUTOMATIC TRANSMISSION WIRING CONNECTION

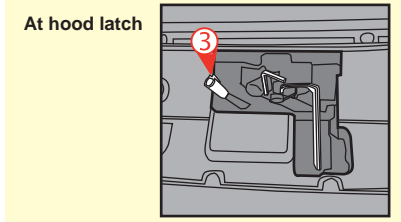
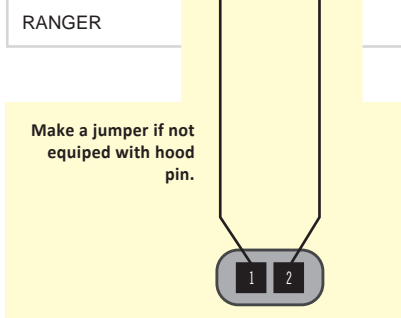
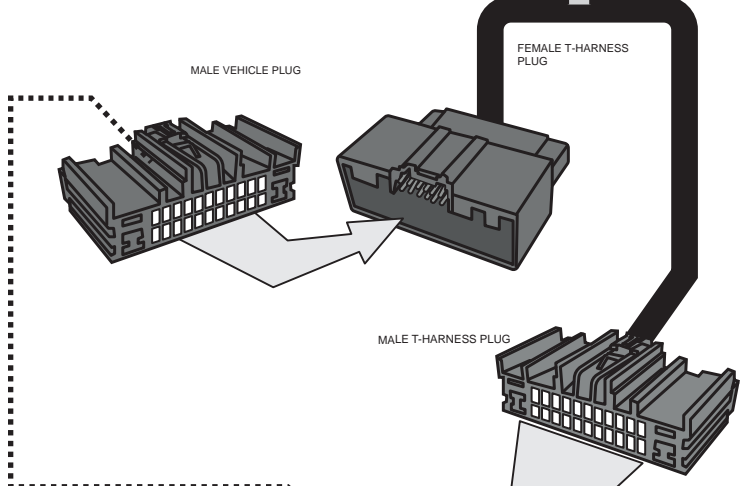
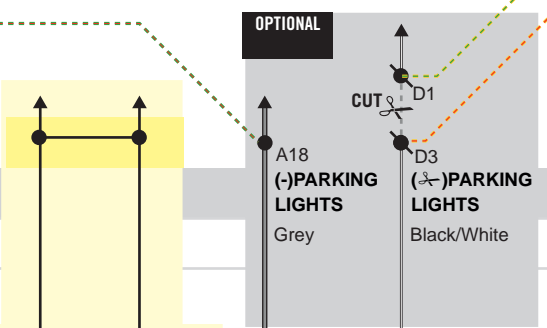
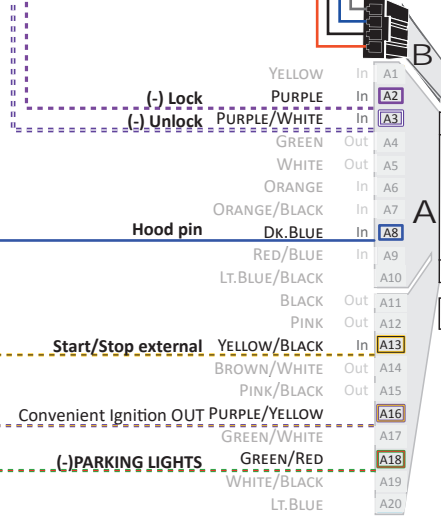
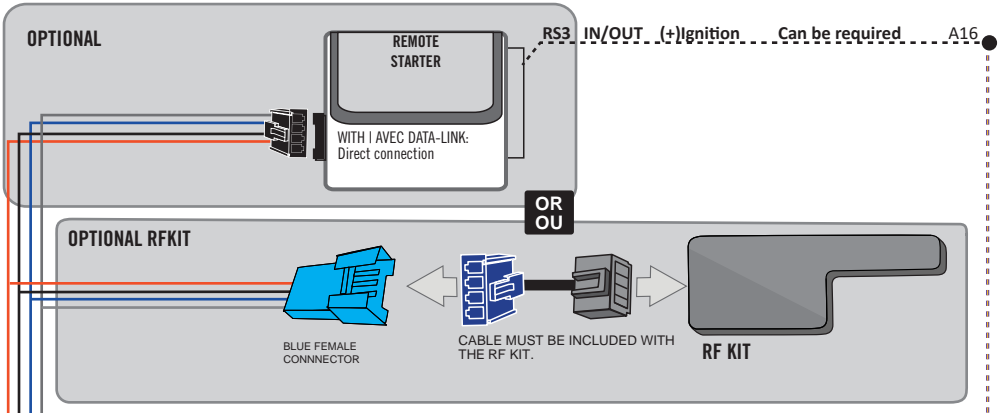
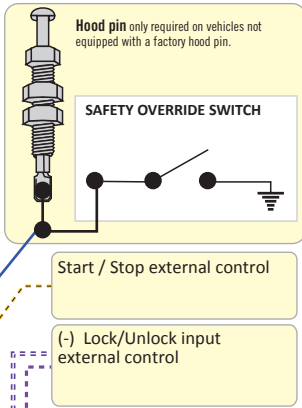

2 Parking Lights switch
Back view, 14-pin black connector.

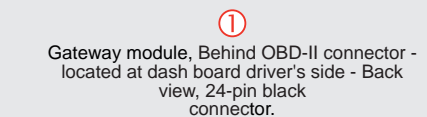

1 Gateway module, Behind OBD-II connector - located at dash board driver's side - Back view, 24-pin black connector.

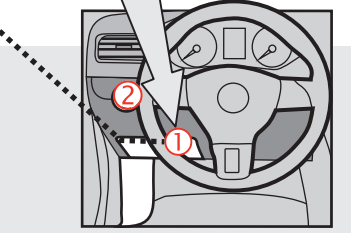

PROGRAMMING PROCEDURE

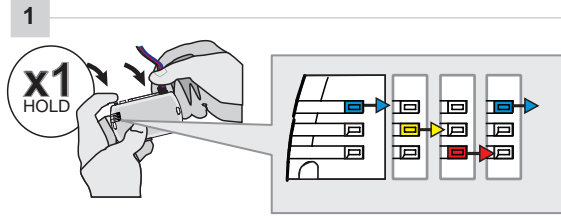

Press and hold the programming button:
Insert the 4-Pin (Data-Link) connector.

↳ The Blue, Red, Yellow and Blue & Red LEDs will alternatively illuminate.

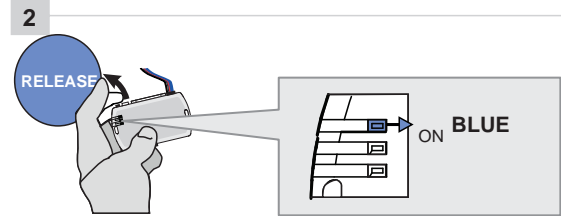

Release the programming button when the LED is BLUE.

If the LED is not solid BLUE disconnect the 4-Pin connector (Data-Link) and go back to step 1.

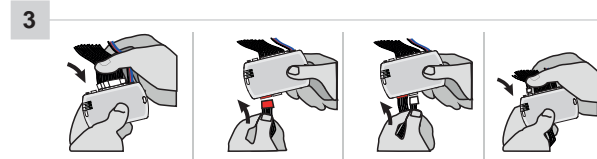

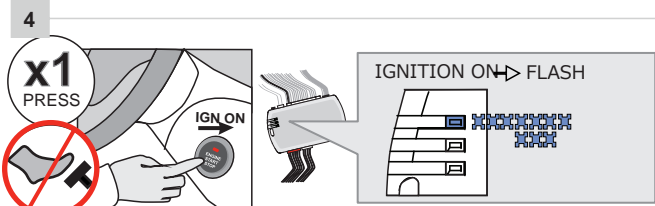

Insert the required remaining connectors.

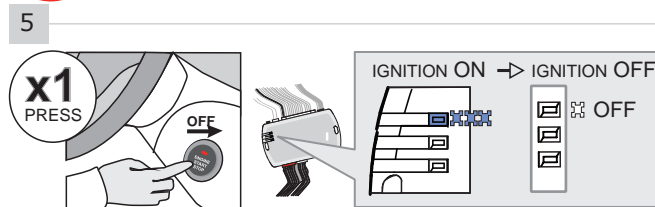

Do not press the brake pedal.
Press the Push-to-Start button once to turn on the ignition.

↳ The BLUE LED will flash rapidly.



Press the Push-to-Start button once to turn off the ignition.

↳ The BLUE LED will turn off.

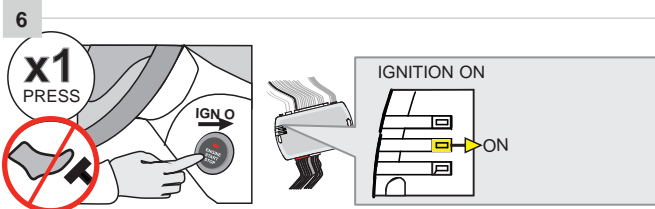

Do not press the brake pedal.
Press the Push-to-Start button once to turn on the ignition.

↳ The YELLOW LED will turn ON.



Wait 5 seconds.

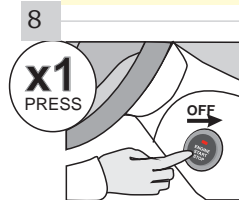

Press the Push-to-Start button once to turn off the ignition.



The module is now programmed.

REMOTE STARTER FUNCTIONALITY

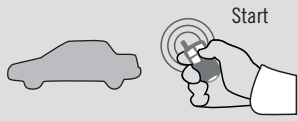

All doors must be closed.

Remote start the vehicle.



Unlock the doors with either:

- The OEM remote
- The remote-starter remote
- Or the proximity remote

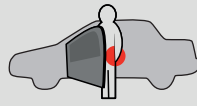

Enter the vehicle with the SMART-KEY.



DO NOT PRESS THE BRAKE PEDAL.

Press and release the Push-to-Start button once.



Press the brake pedal. The vehicle can now be put in to gear and driven.

If the Smart-Key is not detected the vehicle will shut down.

THAR-FOR3 THARNNESS STAND ALONE INSTALLATION

ADDENDUM - SUGGESTED WIRING CONFIGURATION



ONLY COMPATIBLE WITH AUTOMATIC TRANSMISSION VEHICLES.



VEHICLE VEHICLES

YEARS

Vehicle functions supported in this diagram (functional if equipped)

VEHICLE VEHICLES	YEARS	Immobilizer bypass	Lock	Unlock	Arm	Disarm	RAP Disable	Parking Lights	Tachometer	Heated seats	Heated Mirrors	Rear defrost	Door Status	Trunk Status	Hood Status*	Hand-Brake Status	Foot-Brake Status	Active OEM Remote Start	
Transit Connect	Key 2019	•	•	•	•	•	•	•	•	•	•	•	•	•	•	•	•	•	•



FIRMWARE VERSION

4.02

ONLY - SEULEMENT

To add the firmware version and the options, use the **FLASH LINK UPDATER** or **FLASH LINK MOBILE** tool, sold separately.



Program bypass option:

UNIT OPTION

C1

DESCRIPTION

OEM Remote status (Lock/Unlock) monitoring

IF THE VEHICLE IS NOT EQUIPPED WITH FUNCTIONAL HOOD PIN:

A11

OFF

Hood trigger (Output Status).



Parts required (Not included)

1x THAR-FOR3

NOTES



The vehicle must be equipped with the OEM remote with the door locks.

MANDATORY INSTALL

*HOOD PIN



HOOD STATUS: THE HOOD PIN SWITCH MUST BE INSTALLED IF THE VEHICLE CAN BE REMOTE STARTED WITH THE HOOD OPEN, SET FUNCTION A11 TO OFF.

A11

OFF

Notice: the installation of safety elements are mandatory. The hood pin is an essential security element and must be installed.

THIS MODULE MUST BE INSTALLED BY A QUALIFIED TECHNICIAN. A WRONG CONNECTION CAN CAUSE PERMANENT DAMAGE TO THE VEHICLE.

PARTS REQUIRED (NOT INCLUDED)

1x **FLASH LINK UPDATER,**
1x **FLASH LINK MANAGER**
SOFTWARE | PROGRAMME
1x Microsoft Windows Computer with Internet connection

OR

1x **FLASH LINK MOBILE**
1x **FLASH LINK MOBILE APP**
Smartphone *Android* or *iOS* with Internet connection (*provider charges may apply*).

MANDATORY

HOOD PIN



REMOTE START SAFETY OVERRIDE SWITCH

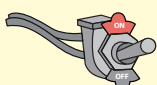







VALET SWITCH

Part #: RSPB available, Sold separately.

Notice: the installation of safety elements are mandatory. The hood pin and the valet switch are essential security elements and must be installed.

STAND ALONE CONFIGURATION

	Program bypass option	UNIT OPTION	DESCRIPTION
	OEM Remote Stand Alone Remote Starter:	OR D1.10  D1.1 	By default, LOCK, LOCK, LOCK Par défaut, VERROUILLE, VERROUILLE, VERROUILLE
	Program bypass option with oem remote:	C1	OEM Remote Monitoring
	Program bypass option with RF KIT antenna:	H1 to H6	Supported RF Kits and select RF Kit
	Program bypass option Vehicle hybrid only:	D4	Hybrid mode (Vehicle hybrid only)

REMOTE STARTER FUNCTIONALITY



All doors must be closed.

3X 

Press the OEM remote's Lock button 3x to remote-start (or remote-stop) the vehicle.



START

The vehicle will START.

REMOTE STARTER DIAGNOSTICS
MODULE RED LED

x2 flash :	Brake ON
x3 flash :	No tach
x4 flash :	Ignition before start
x5 flash :	Hood Open

REMOTE STARTER WARNING CARD



CUT THIS WARNING CARD AND STICK IT ON A VISIBLE PLACE:
or use the package RSPB, Sold separately.

WARNING



REMOTE STARTER

THE VEHICLE CAN BE STARTED BY EITHER: PRESSING THE LOCK BUTTON ON THE OEM REMOTE 3 TIMES CONSECUTIVELY OR BY A SMARTPHONE. **TURN ON** THE SAFETY SWITCH LOCATED UNDER THE DASHBOARD BEFORE WORKING ON THE VEHICLE.

DESCRIPTION



② Parking Lights switch

① Gateway module, located at dash board driver's side,

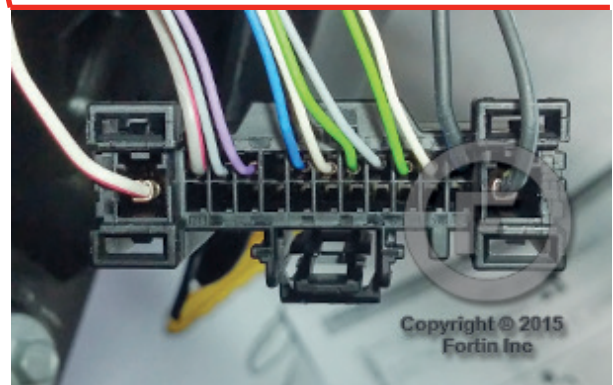
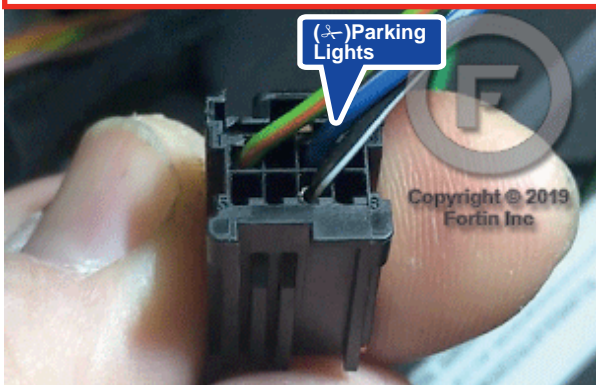

④ Under the hood If not equipped with hood pin.

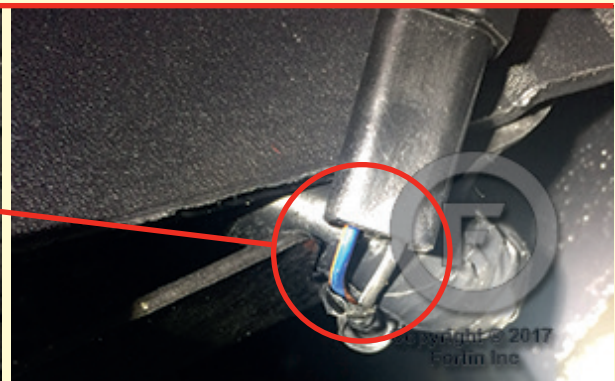

AUTOMATIC TRANSMISSION WIRING CONNECTION

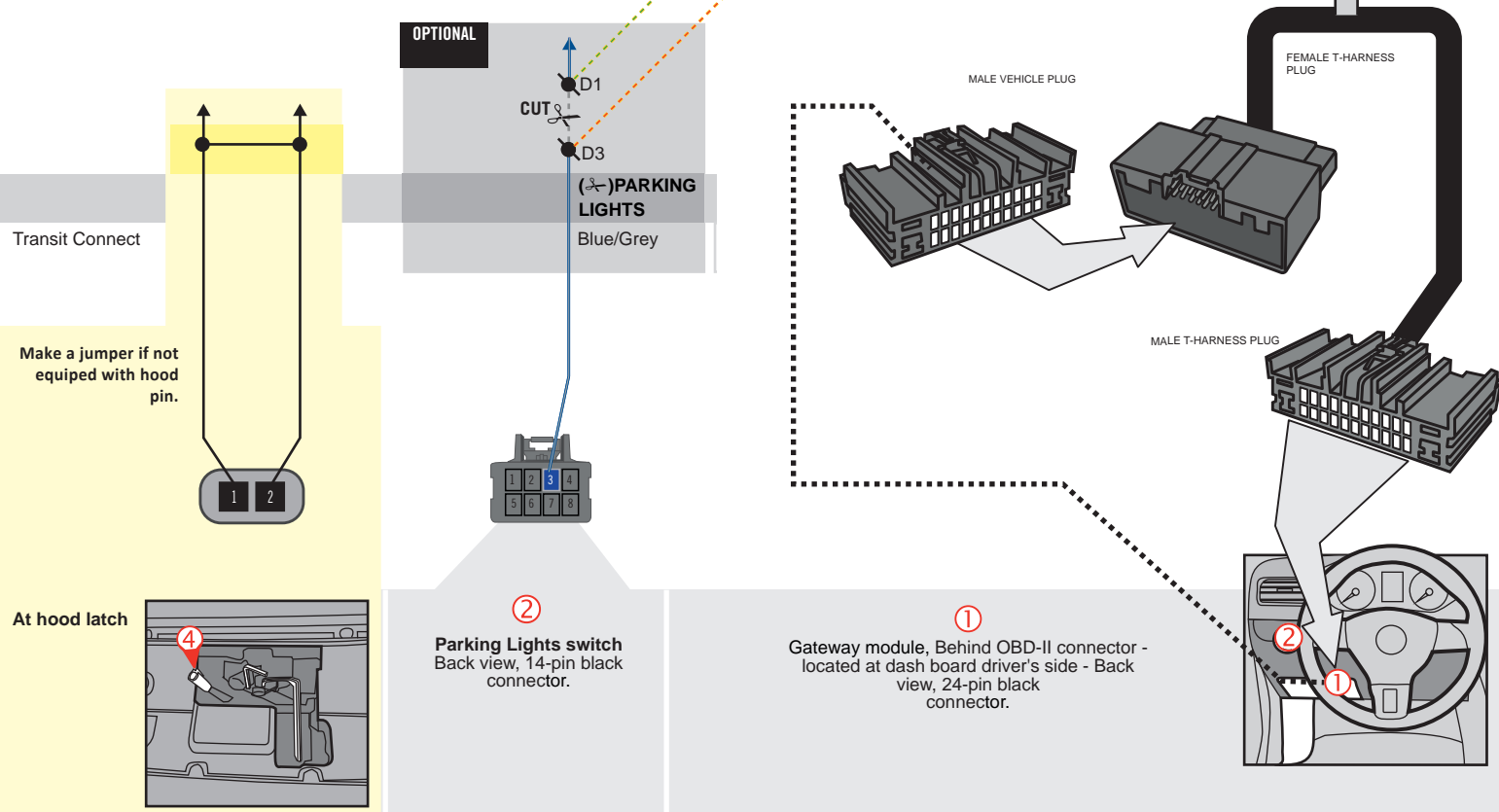
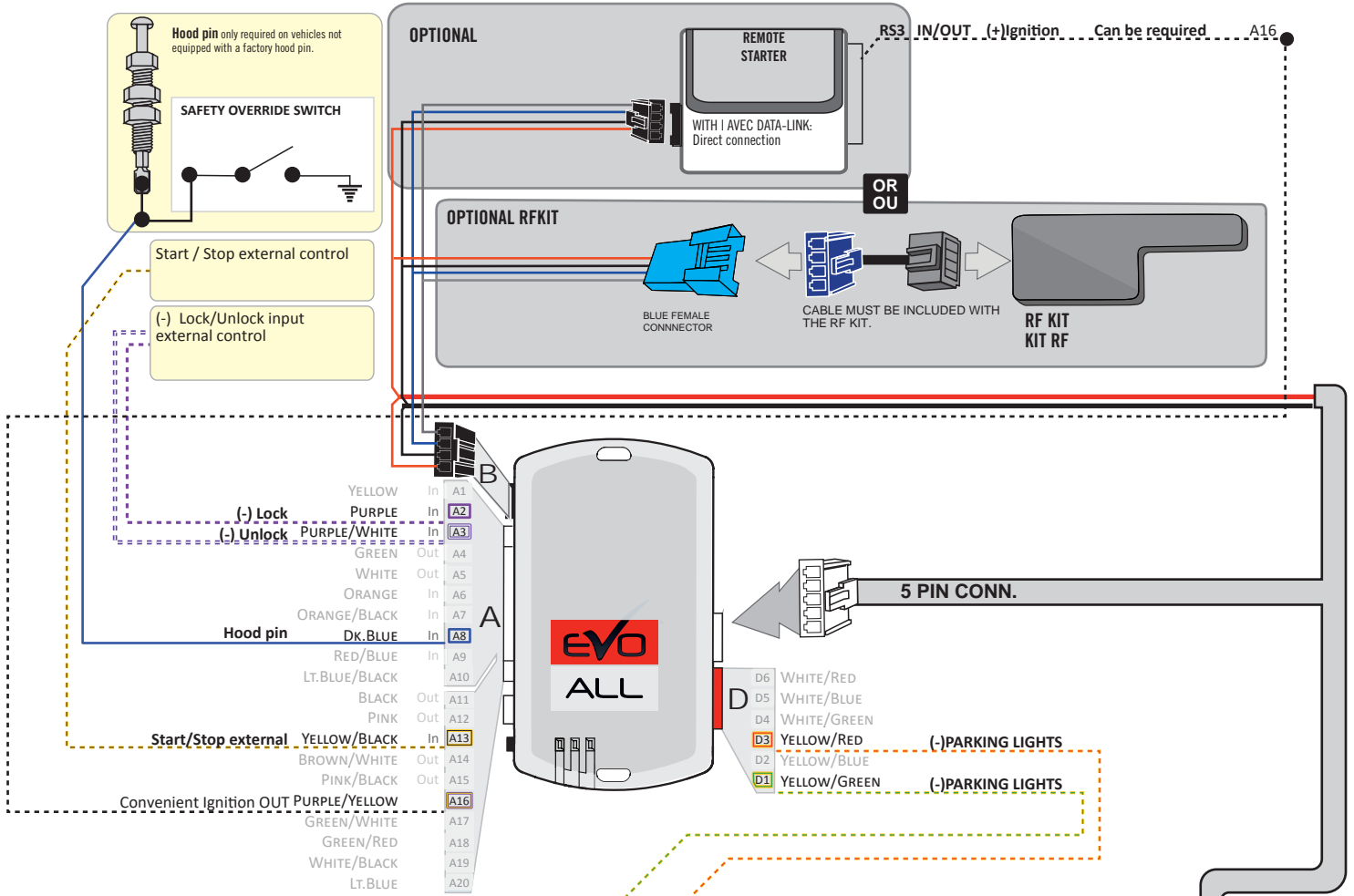

KEY BYPASS PROGRAMMING PROCEDURE 1/2

1

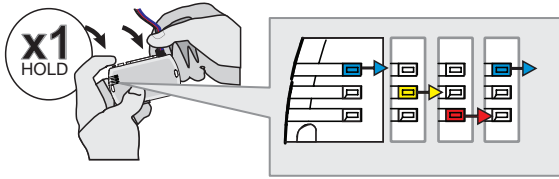

Press and hold the programming button:
Insert the 4-Pin (Data-Link) connector.

↳ The Blue, Red, Yellow and Blue & Red LEDs will alternatively illuminate.

2

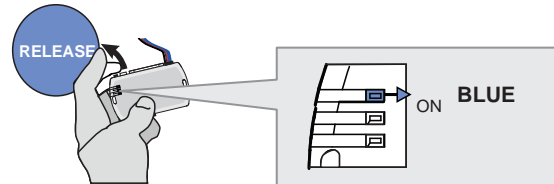

Release the programming button when the LED is BLUE.

If the LED is not solid BLUE disconnect the 4-Pin connector (Data-Link) and go back to step 1.

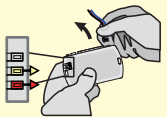

3

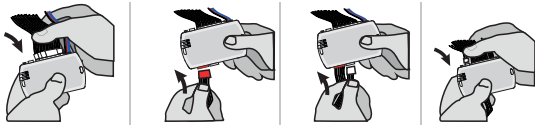

Insert the required remaining connectors.

4

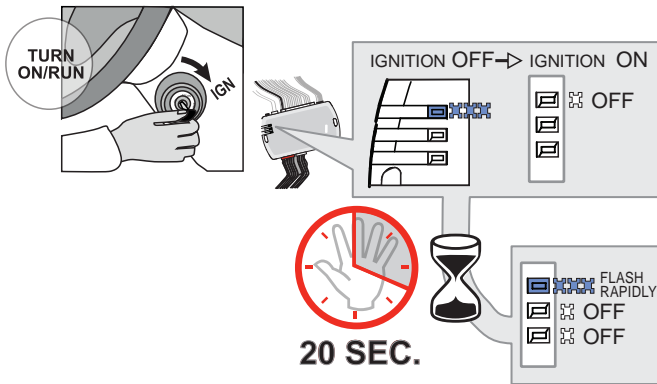

Turn the key to the Ignition ON/RUN position.

↳ The BLUE LED will turn OFF.

↳ The BLUE LED will flash rapidly.

5

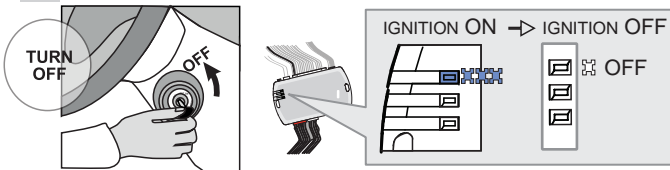

Turn the key to the OFF position.

↳ The BLUE LED will turn off.

6

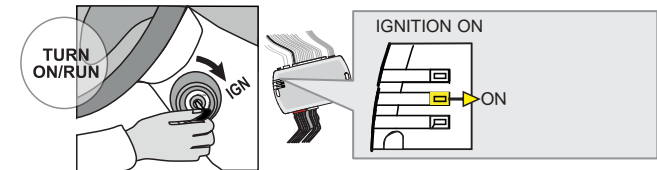

Turn the key to the Ignition ON/RUN position.

↳ The YELLOW LED will turn ON.

7



Wait 5 seconds.

KEY BYPASS PROGRAMMING PROCEDURE 2/2

8

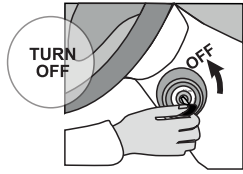

Turn the key to the OFF position.



The module is now programmed.

OPTIONAL RF-KIT PROGRAMMING

PROGRAM BYPASS OPTION

	<p>Program bypass option:</p>	<p>H2</p>	<p>Supported RF-KITS enable</p> <p>H2 Fortin 2</p>

OPTIONAL FORTIN RF KIT SERIES 4 OR SERIES 9 PROGRAMMING

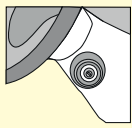

The module must be programmed on the vehicle.

MAKE SURE THE IGNITION KEY HAS BEEN IN THE OFF POSITION FOR AT LEAST 5 SECONDS.

1

ON 

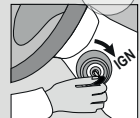

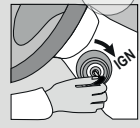
Turn the key to the ON/RUN position.

2

OFF 

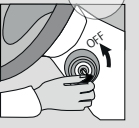

Turn the ignition to the OFF position.

3

ON 

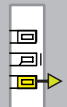

Turn the key to the ON/RUN position.

4

4X BRAKES



Press and release the brake pedal four times.

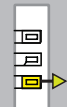



The LED will turn off each time.

5

ON EACH TRANSMITTER

4 BUTTONS

 PRESS AND RELEASE

 PRESS AND RELEASE



1 BUTTON

PRESS APPROX. 12 SEC. AND WAIT FOR THE BLUE LED TO TURN OFF THEN BACK ON SOLID THEN RELEASE.



The LED will turn off each time.



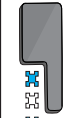

The LED will flash rapidly.



The 3 LED will turn off each time.

6

OFF 



Turn the ignition to the OFF position.



The LED will turn Off.

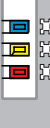

The 3 LED will turn off.



REMOTE STARTER FUNCTIONALITY



All doors must be closed.



Remote start the vehicle.



Unlock the doors with the remote-starter remote or the OEM remote.



Insert and Turn the key to the Ignition ON/RUN position.



Press the brake pedal.



The vehicle can now be put in to gear and driven.