



REGULAR INSTALLATION AND THAR-GM6 INSTALLATION

ADDENDUM - SUGGESTED WIRING CONFIGURATION

Vehicle functions supported in this diagram (functional if equipped)

	VEHICLE	YEARS	Immobilizer bypass	Lock	Unlock	Arm	Disarm	Parking Light	Trunk (open)	RAP Disable	Tachometer	Door Status	Trunk Status	Hand-Brake Status	Foot-Brake Status	OEM Remote Monitoring
	CHEVROLET															
Impala	Push-To-Start	2014-2019	•	•	•	•	•	•	•	•	•	•	•	•	•	•

	FIRMWARE VERSION	To add the firmware version and the options, use the FLASH LINK UPDATER or FLASH LINK MOBILE tool, sold separately.
	<h1>70.[41]</h1> <p>GM MINIMUM</p>	

	<p>IF THE VEHICLE IS NOT EQUIPPED WITH FUNCTIONAL HOOD PIN:</p> <p>Program bypass option:</p>	UNIT OPTION	DESCRIPTION
		A11	OFF

	<p>Program bypass option:</p>	C1	OEM Remote status (Lock/Unlock) monitoring
		D6	Push-to-Start
		E5	<p>SPECIAL FUNCTIONS: BY DEFAULT DEACTIVATED</p> <p>OFF</p> <p>ON</p>

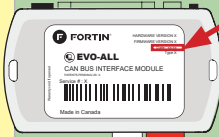
 <p>ATTENTION!</p>	 <p>DATE: XX-XX</p>	E5	<p>OFF</p> <p>ON</p>
--	--	-----------	------------------------------------

MANDATORY INSTALL

*HOOD PIN



HOOD STATUS: THE HOOD PIN SWITCH MUST BE INSTALLED IF THE VEHICLE CAN BE REMOTE STARTED WITH THE HOOD OPEN, SET FUNCTION **A11** TO OFF.

A11	OFF
------------	------------

Notice: the installation of safety elements are mandatory. The hood pin is an essential security element and must be installed.

THIS MODULE MUST BE INSTALLED BY A QUALIFIED TECHNICIAN. A WRONG CONNECTION CAN CAUSE PERMANENT DAMAGE TO THE VEHICLE.

DESCRIPTION

Parts required (Not included) PAGE

WIRE TO WIRE DIAGRAM

	Page 3
--	--------

THARNNESS DIAGRAM

THARNNESS THAR-GM6	1x THAR-GM6	1x THAR-GM6	Page 4
--------------------	-------------	-------------	--------

BCM

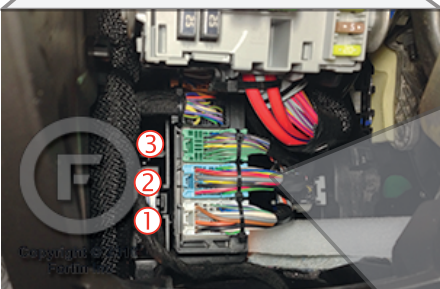
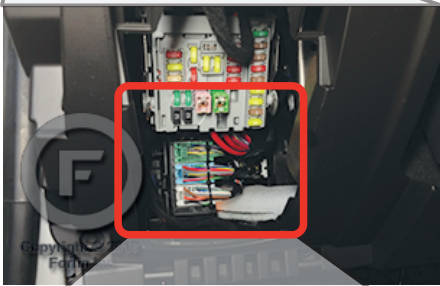

Impala

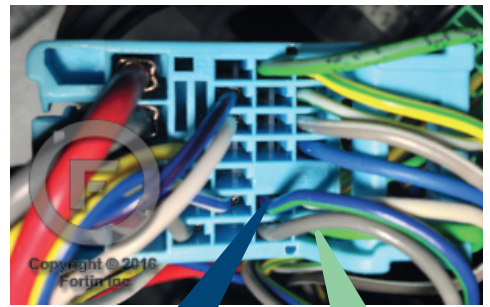
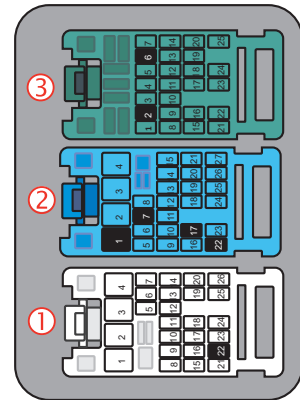
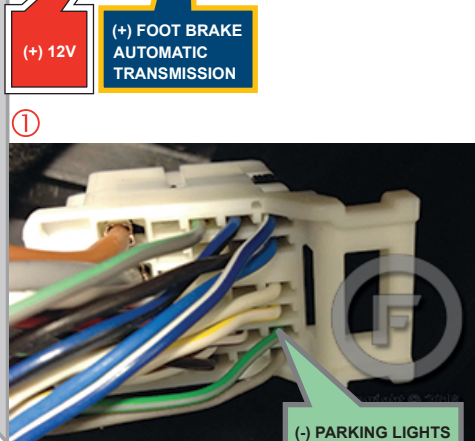
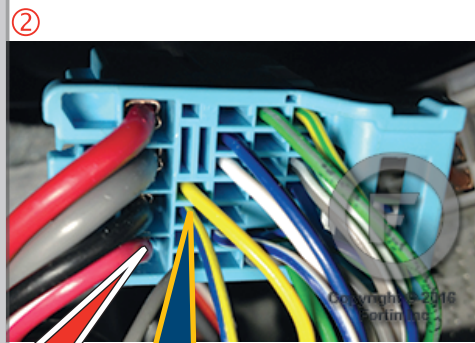
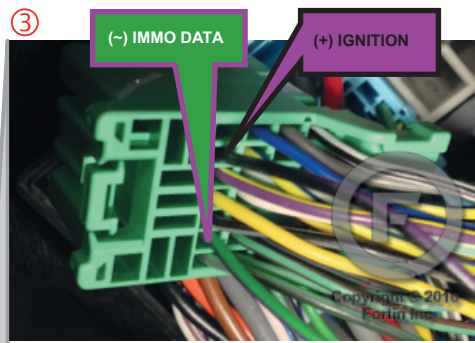

AUTOMATIC TRANSMISSION WIRING CONNECTION

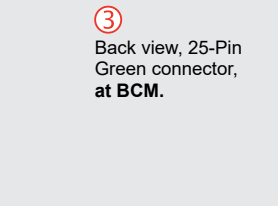
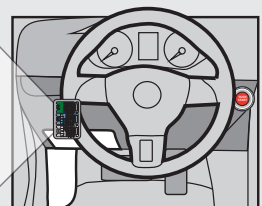
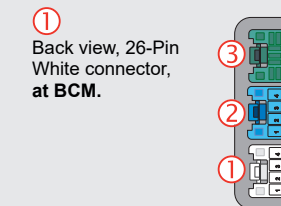
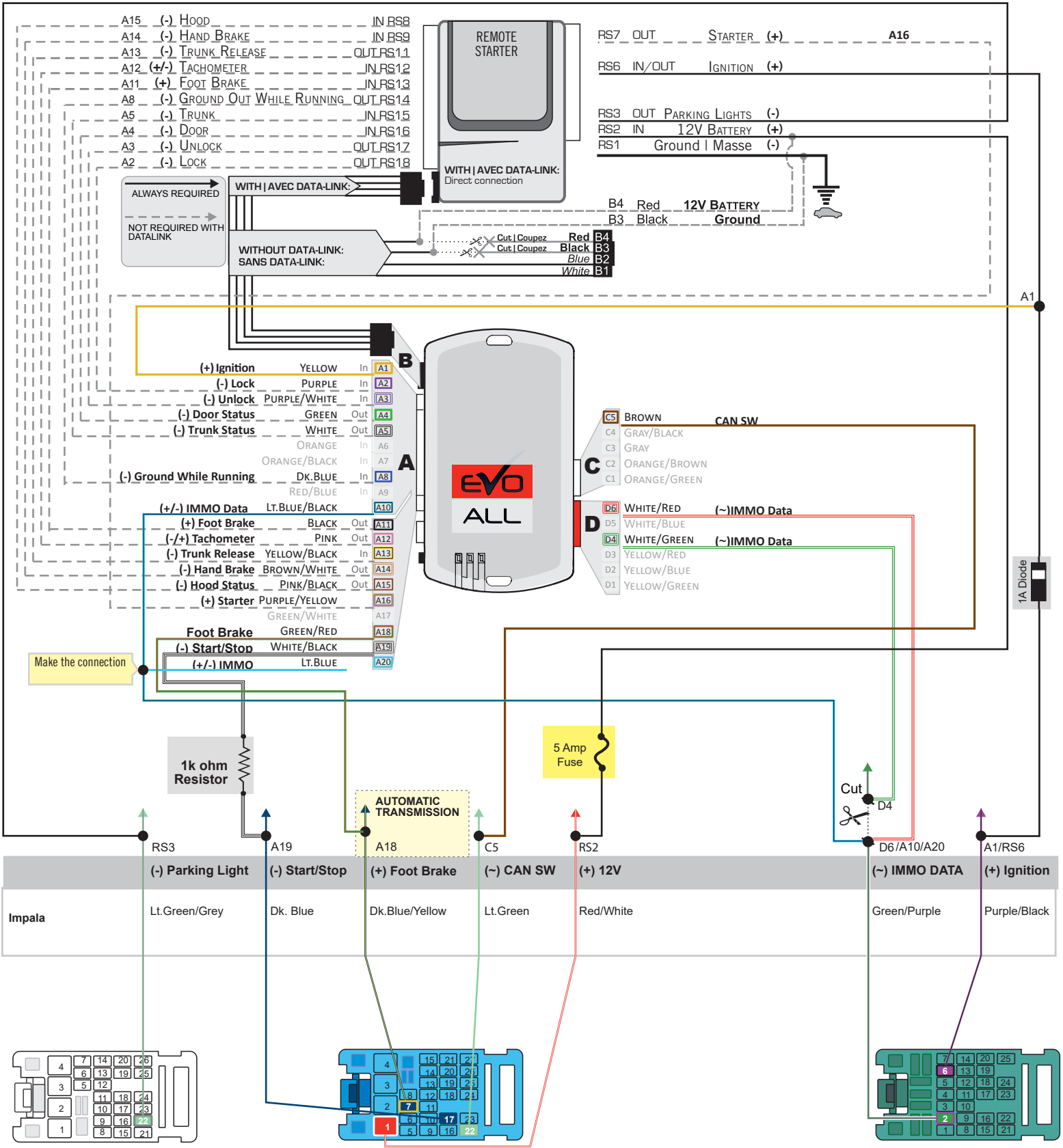

THAR-GM6 | WIRING CONNECTION

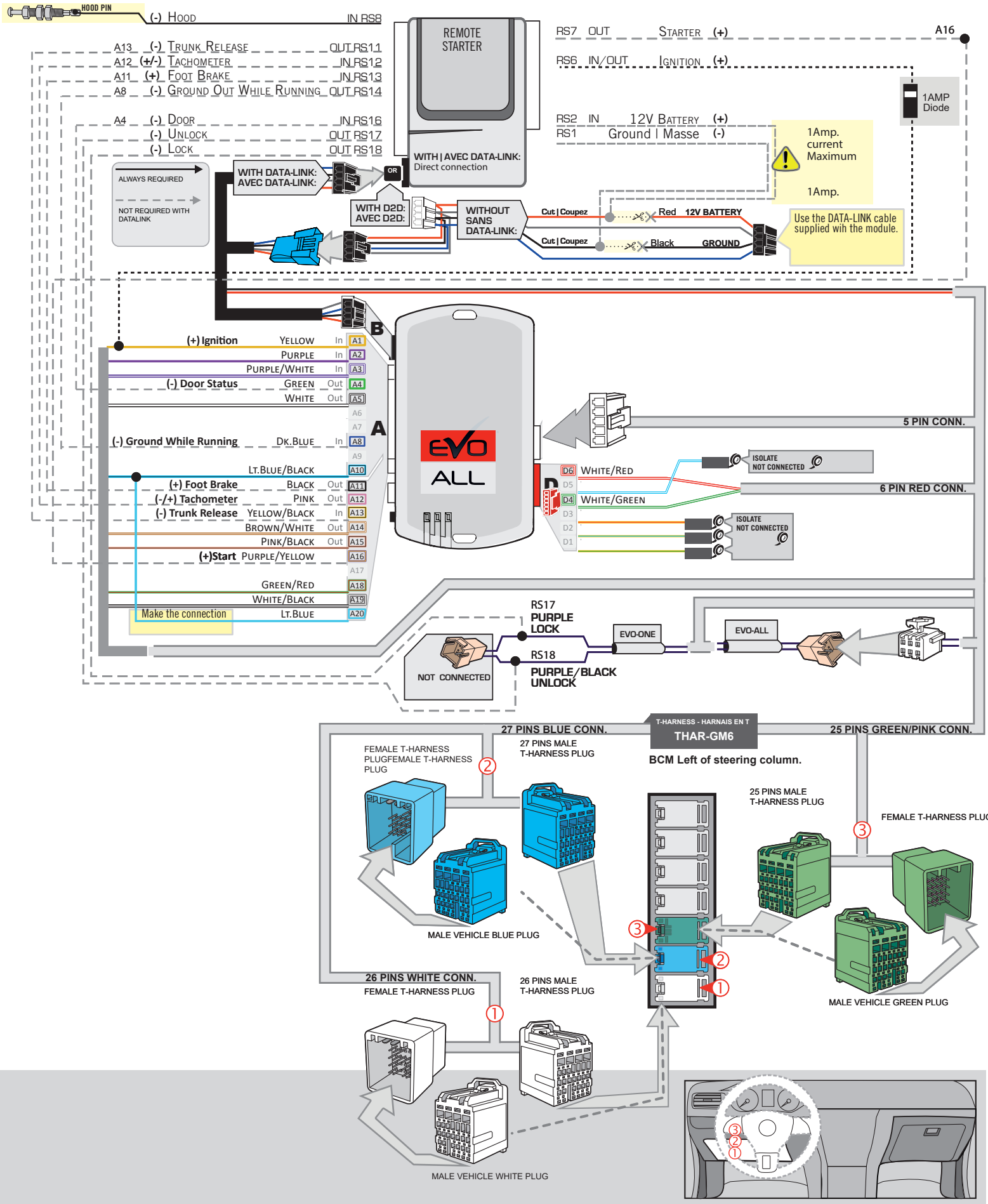

KEY BYPASS PROGRAMMING PROCEDURE 1/3



1 Remove the battery from the OEM remote.

2 Place the OEM remote into the transmitter pocket of the center console.

Refer to vehicle user guide for keyport location.

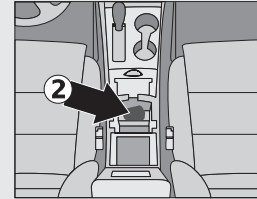

1

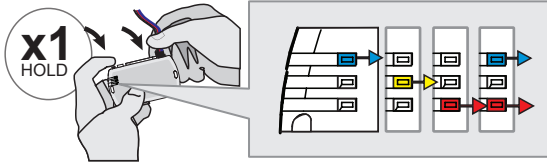

Press and hold the programming button:
Connect the 4-PIN Data-link harness (Black connector).

↳The Blue, Red, Yellow and Blue & Red LEDs will alternatively illuminate.

2

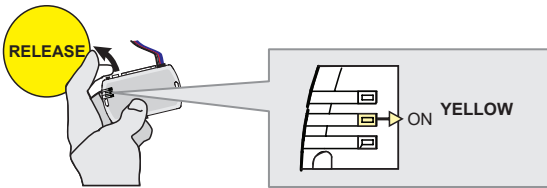

Release the programming button when the LED is YELLOW.

If the LED is not solid YELLOW disconnect the 4-Pin connector (Data-Link) and go back to step 1.

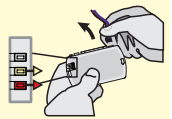

3

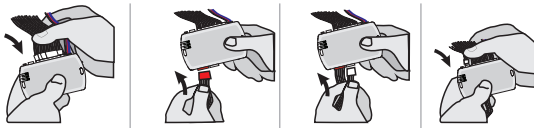

Insert the required remaining connectors.

4

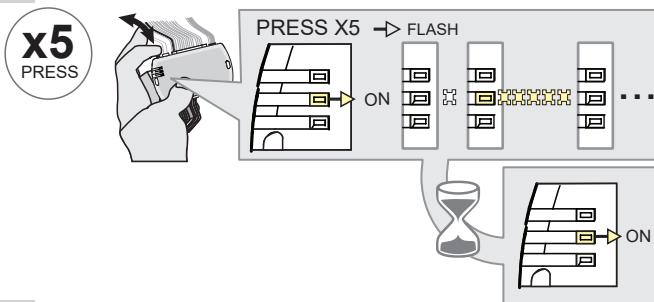

Press and release the programming button five (5x) times.

↳The YELLOW LED will flash 5 times each second.

↳**WAIT** for the YELLOW LED to turn ON solide.

5

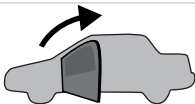

Open the driver door.

6

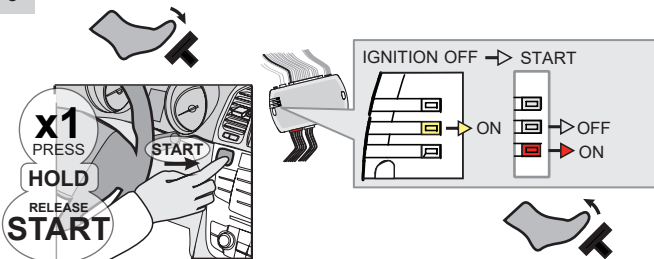

Press the foot-brake pedal.

Press the Push-to-Start button until the engine start.

Release the foot-brake pedal.

↳The RED LED will turn ON.
↳The YELLOW LED will turn OFF.

KEY BYPASS PROGRAMMING PROCEDURE 2/3

7



Press the Push-to-Start button until the engine turn OFF.

8

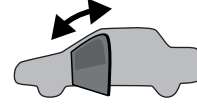

Close and open the driver door.

9

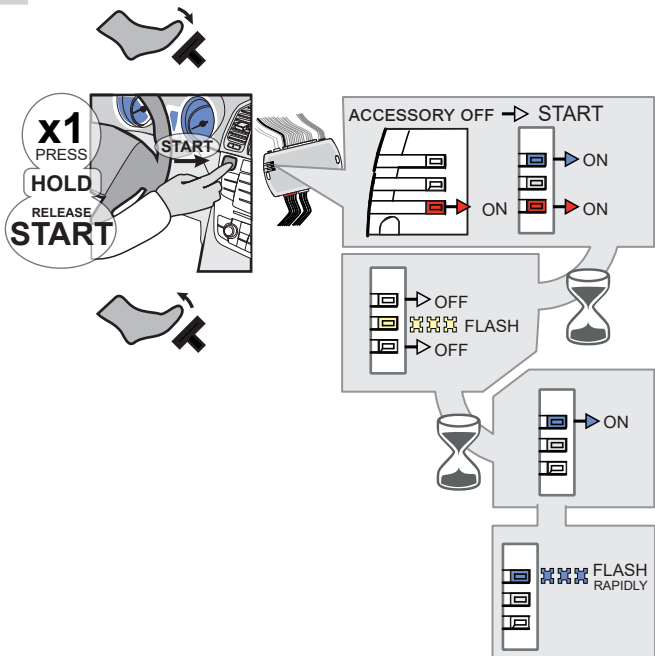

Press the foot-brake pedal.

Press the Push-to-Start button until the engine start.

Release the foot-brake pedal.

- ↳ The BLUE LED will turn ON.
- ↳ The BLUE LED will turn OFF. The RED LED will turn OFF.
- ↳ The YELLOW LED will flash rapidly
- ↳ The BLUE LED will turn ON.
- ↳ The BLUE LED will flash rapidly

10

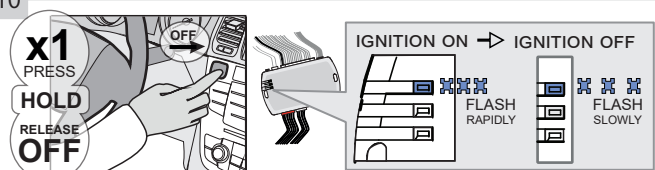

Press the Push-to-Start button until the engine turn OFF.

- ↳ The BLUE LED will flash slowly

11

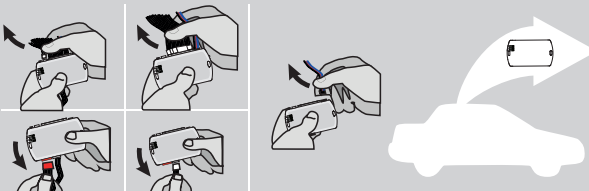

Disconnect all the connectors and after the Data-Link (4-pins) connector.

12

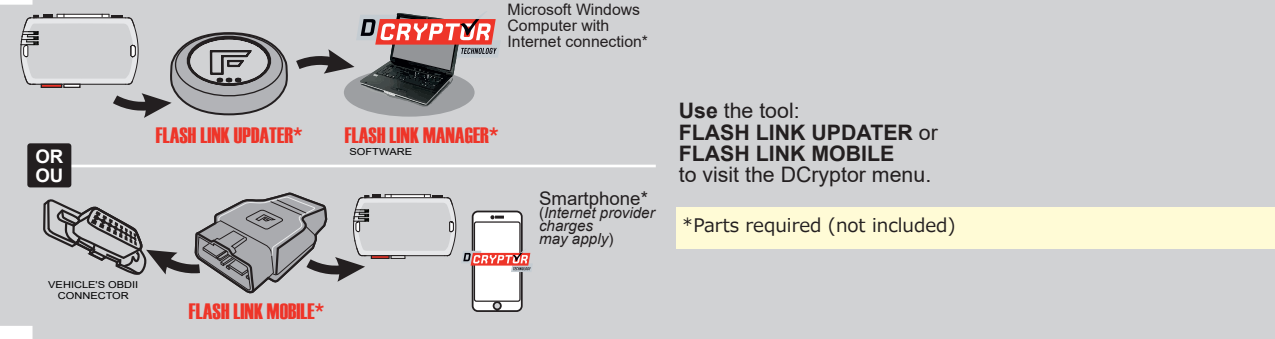

Use the tool: FLASH LINK UPDATER or FLASH LINK MOBILE to visit the DCRYPTOR menu.

***Parts required (not included)**

KEY BYPASS PROGRAMMING PROCEDURE 3/3

13

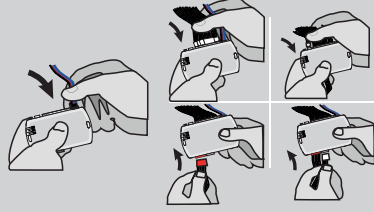
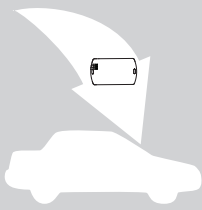

AFTER DCRYPTOR PROGRAMMING COMPLETED
Go back to the vehicle and **reconnect** the 4-Pin (Data-Link) connector and after, all the remaining connector.



The module is now programmed.



REMOTE STARTER / ALARM VERIFICATION PROCEDURE

Test the remote starter. Remote start the vehicle.

REMOTE STARTER FUNCTIONALITY



All doors must be closed.



Remote start the vehicle.



Unlock the doors with either:

- The OEM remote
- The remote-starter remote
- Or the proximity remote

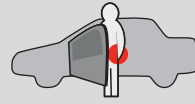

Enter the vehicle with the Intelligent Key.



The vehicle can now be put in to gear and driven.

If the vehicle is not unlocked with one of these conditions the remote-starter will shut down as soon as any door is opened.



REGULAR INSTALLATION AND THAR-GM6 INSTALLATION

ADDENDUM - SUGGESTED WIRING CONFIGURATION

VEHICLE	YEARS	Vehicle functions supported in this diagram (functional if equipped)													
		Immobilizer bypass	Lock	Unlock	Arm	Disarm	Parking Light	Trunk (open)	RAP Disable	Tachometer	Door Status	Trunk Status	Hand-Brake Status	Foot-Brake Status	OEM Remote Monitoring
BUICK															
LaCrosse	Push-To-Start	2010	•	•	•	•	•	•	•	•	•	•	•	•	•

FIRMWARE VERSION

70.[41]

GM MINIMUM

To add the firmware version and the options, use the **FLASH LINK UPDATER** or **FLASH LINK MOBILE** tool, sold separately.

IF THE VEHICLE IS NOT EQUIPPED WITH FUNCTIONAL HOOD PIN:	A11	OFF	Hood trigger (Output Status).
---	------------	------------	-------------------------------

	UNIT OPTION	DESCRIPTION
<p>Program bypass option:</p>	C1	OEM Remote status (Lock/Unlock) monitoring
	D6	Push-to-Start

	ATTENTION!	<p>DATE: XX-XX</p>	E5	OFF	SPECIAL FUNCTIONS: BY DEFAULT DEACTIVATED
			ON	MANUFACTURED MODULES BETWEEN: 04/2018 TO 04/2019	

MANDATORY INSTALL

*HOOD PIN



HOOD STATUS: THE HOOD PIN SWITCH MUST BE INSTALLED IF THE VEHICLE CAN BE REMOTE STARTED WITH THE HOOD OPEN, SET FUNCTION **A11** TO OFF.

A11

OFF

Notice: the installation of safety elements are mandatory. The hood pin is an essential security element and must be installed.

THIS MODULE MUST BE INSTALLED BY A QUALIFIED TECHNICIAN. A WRONG CONNECTION CAN CAUSE PERMANENT DAMAGE TO THE VEHICLE.

DESCRIPTION

Parts required (Not included) PAGE

WIRE TO WIRE DIAGRAM

	1X 1Amp Diode 1X 5 Amp Fuse 1X 1k Ohm Resistor	Page 3
--	--	--------

THARNNESS DIAGRAM

THARNNESS THAR-GM6	1x THAR-GM6	Page 4
--------------------	-------------	--------

BCM

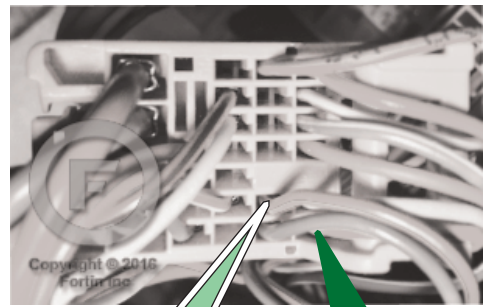
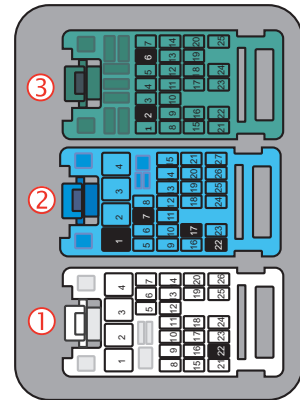
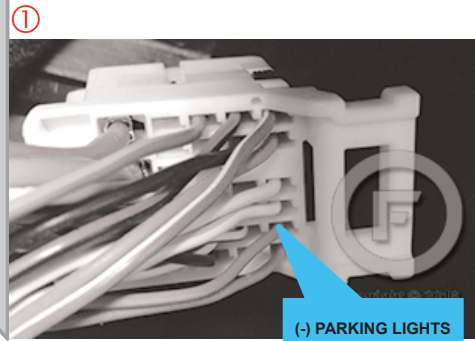
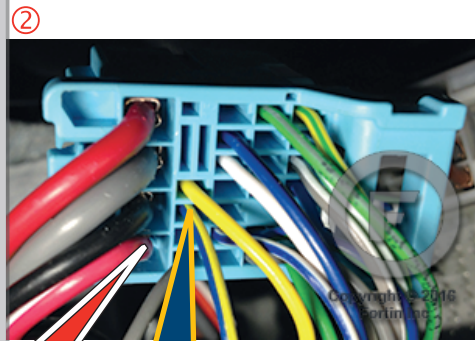
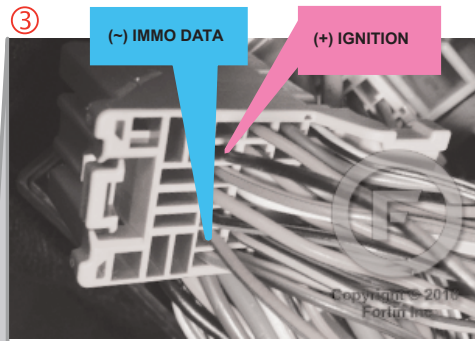
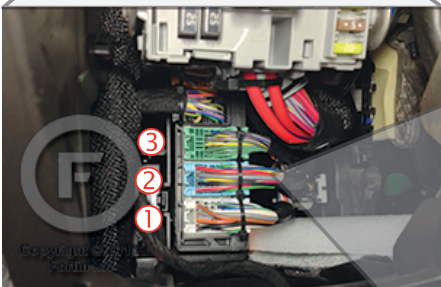
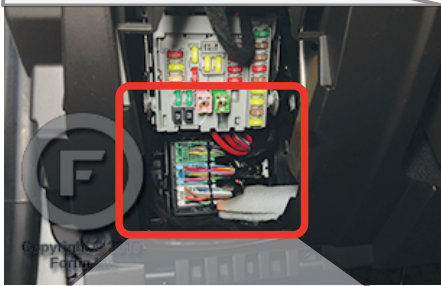

AUTOMATIC TRANSMISSION WIRING CONNECTION

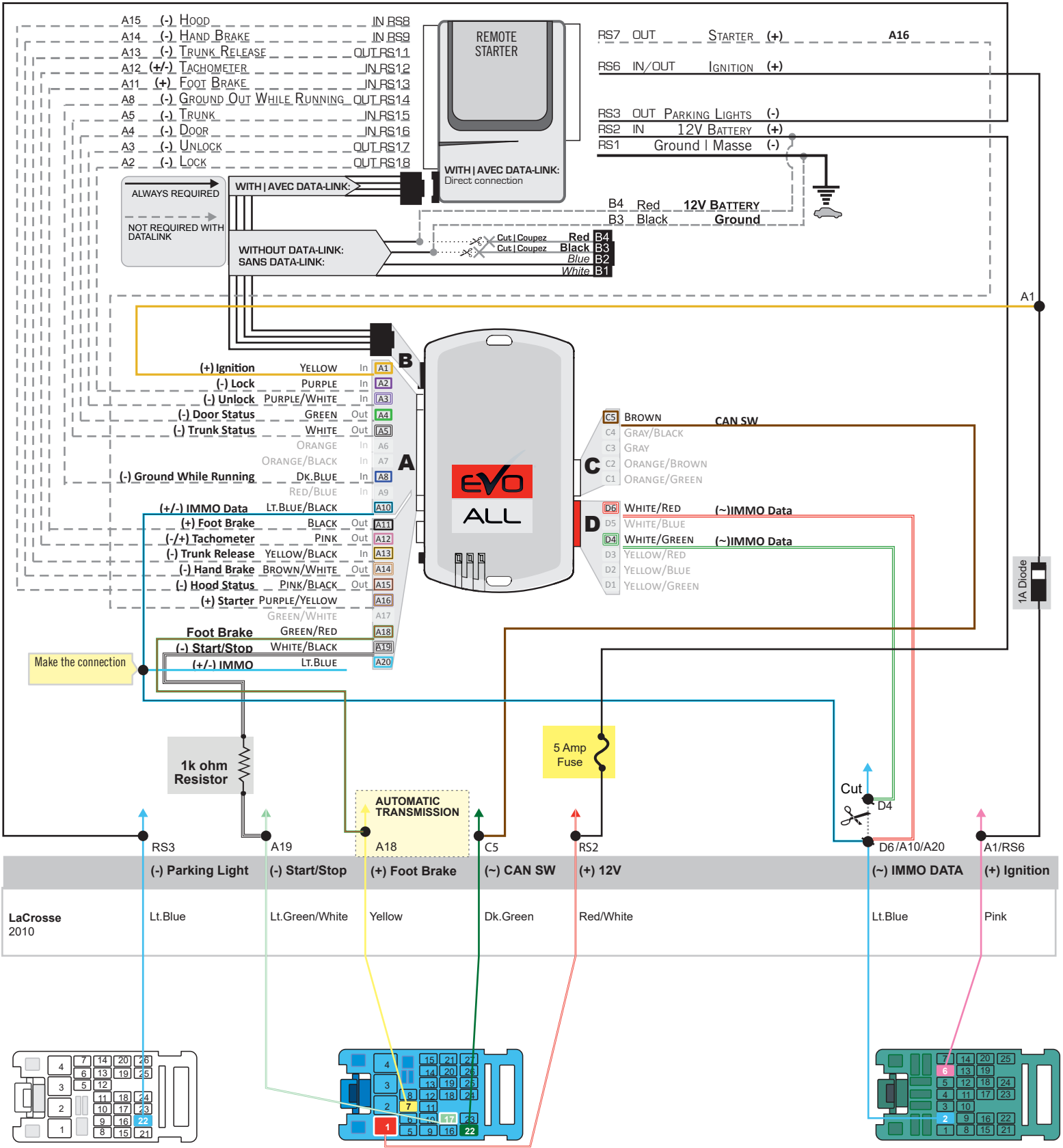

① Back view, 26-Pin White connector, at BCM.

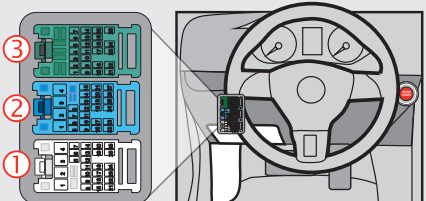

② Back view, 27-Pin Blue connector, at BCM.

③ Back view, 25-Pin Green connector, at BCM.

THAR-GM6 | WIRING CONNECTION

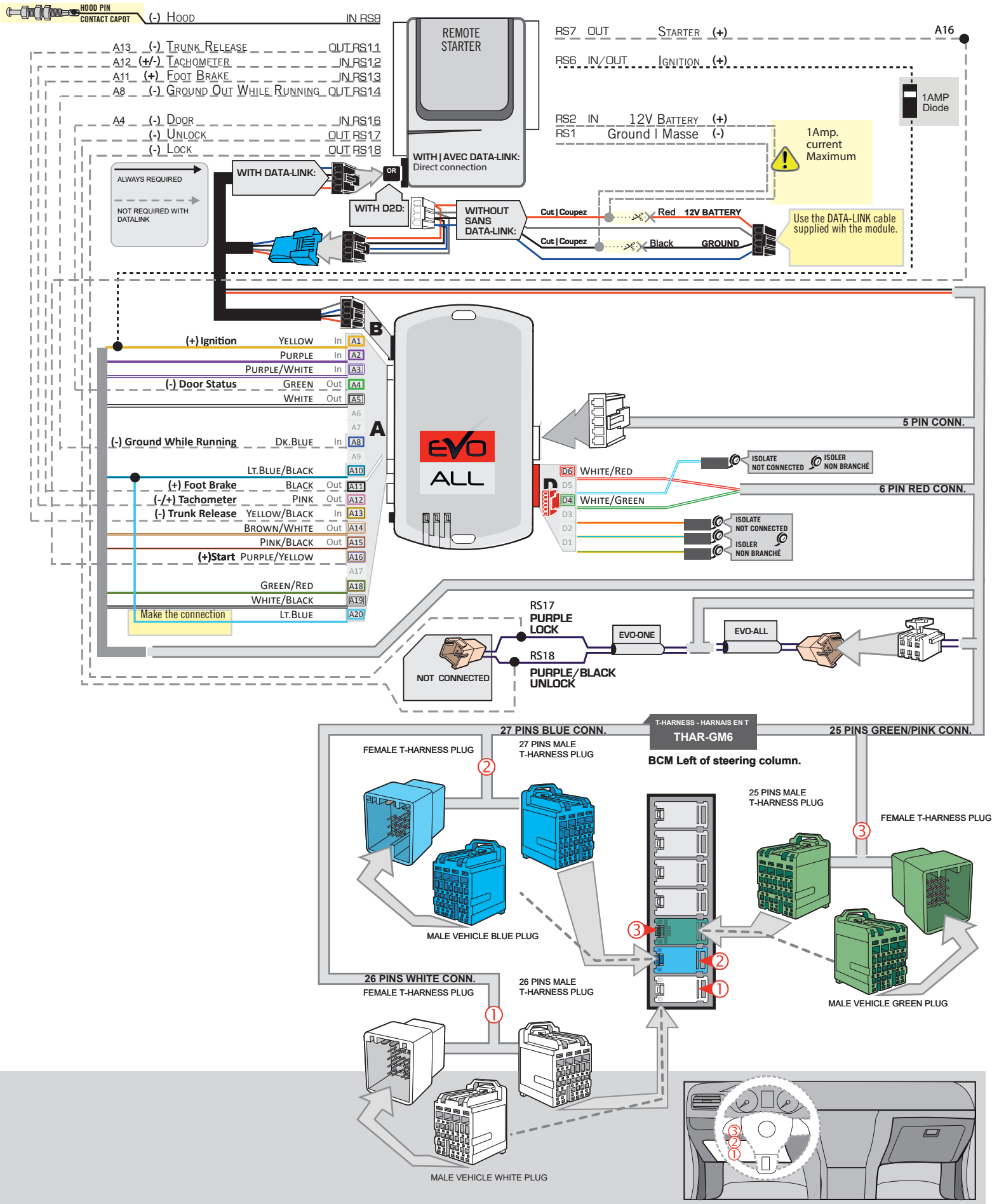

KEY BYPASS PROGRAMMING PROCEDURE 1/3 |

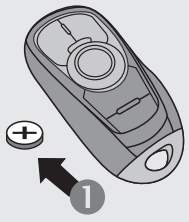

1 Remove the battery from the OEM remote.

2 Place the OEM remote into the transmitter pocket of the center console.

Refer to vehicle user guide for keyport location.

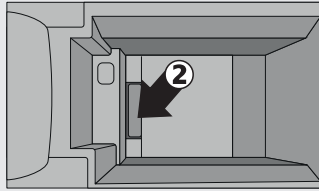

1

x1 HOLD

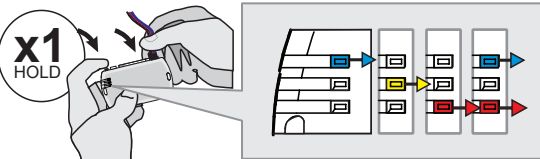

Press and hold the programming button:
Connect the 4-PIN Data-link harness (Black connector).

↳The Blue, Red, Yellow and Blue & Red LEDs will alternatively illuminate.

2

RELEASE

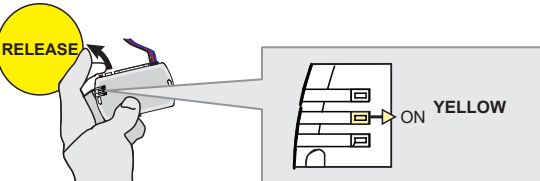

Release the programming button when the LED is **YELLOW**.

If the LED is not solid YELLOW disconnect the 4-Pin connector (Data-Link) and go back to step 1.

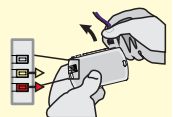

3

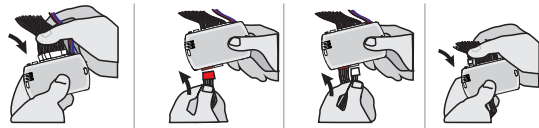

Insert the required remaining connectors.

4

x5 PRESS

PRESS X5 → FLASH

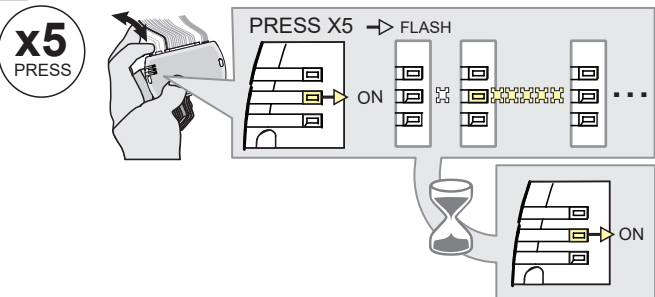

Press and release the programming button five (5x) times.

↳The **YELLOW LED** will flash 5 times each second.

↳**WAIT** for the **YELLOW LED** to turn ON solide.

5



Open the driver door.

6

x1 PRESS HOLD START

RELEASE START

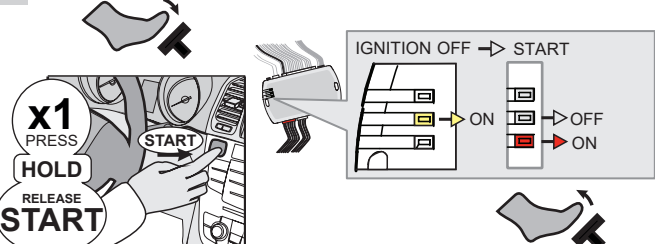

Press the foot-brake pedal.

Press the Push-to-Start button until the engine start.

Release the foot-brake pedal.

↳The **RED LED** will turn ON.
 ↳The **YELLOW LED** will turn OFF.

KEY BYPASS PROGRAMMING PROCEDURE 2/3 |

7



Press the Push-to-Start button until the engine turn OFF.

8

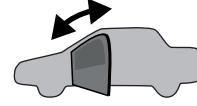

Close and open the driver door.

9

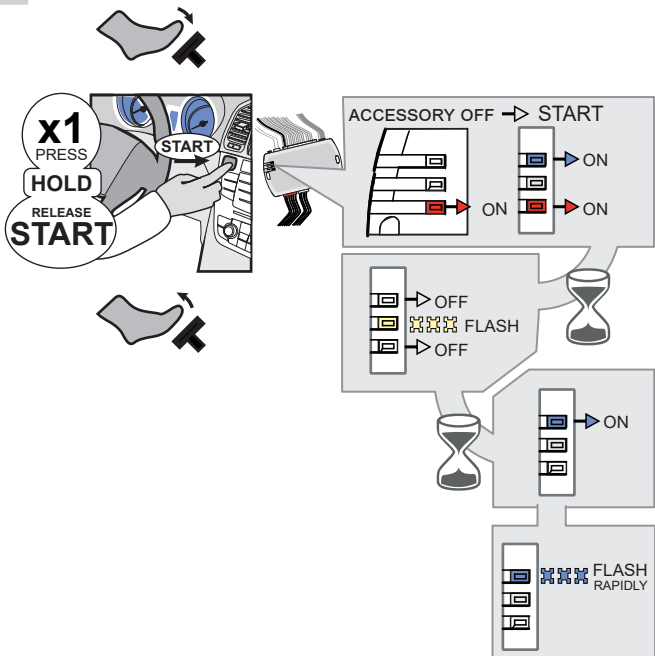

Press the foot-brake pedal.

Press the Push-to-Start button until the engine start.

Release the foot-brake pedal.

- ↳ The BLUE LED will turn ON.
- ↳ The BLUE LED will turn OFF. The RED LED will turn OFF.
- ↳ The YELLOW LED will flash rapidly
- ↳ The BLUE LED will turn ON.
- ↳ The BLUE LED will flash rapidly

10

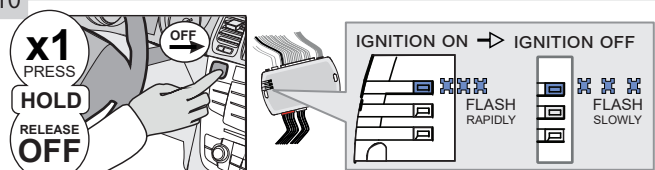

Press the Push-to-Start button until the engine turn OFF.

- ↳ The BLUE LED will flash slowly

11

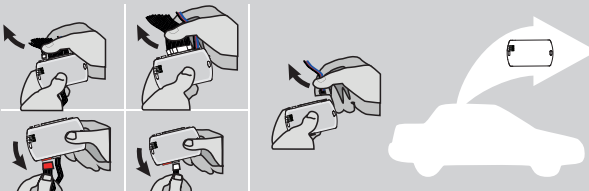

Disconnect all the connectors and after the Data-Link (4-pins) connector.

12

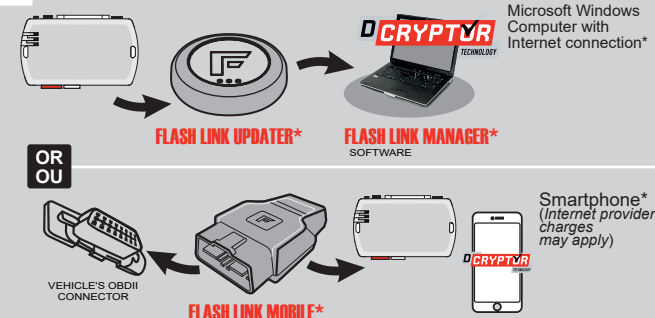

Microsoft Windows Computer with Internet connection*

FLASH LINK UPDATER*

FLASH LINK MOBILE*

Smartphone* (Internet provider charges may apply)

VEHICLE'S OBDII CONNECTOR

Use the tool: FLASH LINK UPDATER or FLASH LINK MOBILE to visit the DCryptor menu.

*Parts required (not included)

13

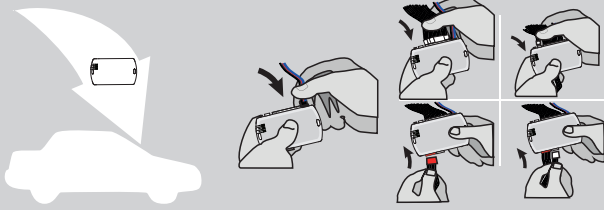

AFTER DCRYPTOR PROGRAMMING COMPLETED
Go back to the vehicle and **reconnect** the 4-Pin (Data-Link) connector and after, all the remaining connector.



The module is now programmed.



REMOTE STARTER / ALARM VERIFICATION PROCEDURE

Test the remote starter. Remote start the vehicle.

REMOTE STARTER FUNCTIONALITY |



All doors must be closed.



Remote start the vehicle.



Unlock the doors with either:

- The OEM remote
- The remote-starter remote
- Or the proximity remote



Enter the vehicle with the Intelligent Key.



The vehicle can now be put in to gear and driven.

If the vehicle is not unlocked with one of these conditions the remote-starter will shut down as soon as any door is opened.



REGULAR INSTALLATION AND THAR-GM6 INSTALLATION

ADDENDUM - SUGGESTED WIRING CONFIGURATION

VEHICLE	YEARS	Vehicle functions supported in this diagram (functional if equipped)													
		Immobilizer bypass	Lock	Unlock	Arm	Disarm	Parking Light	Trunk (open)	RAP Disable	Tachometer	Door Status	Trunk Status	Hand-Brake Status	Foot-Brake Status	OEM Remote Monitoring
BUICK															
LaCrosse	Push-To-Start	2011-2013	•	•	•	•	•	•	•	•	•	•	•	•	•



FIRMWARE VERSION

70.[41]

GM MINIMUM

To add the firmware version and the options, use the **FLASH LINK UPDATER** or **FLASH LINK MOBILE** tool, sold separately.

IF THE VEHICLE IS NOT EQUIPPED WITH FUNCTIONAL HOOD PIN:	A11	OFF	Hood trigger (Output Status).
---	------------	------------	-------------------------------

	UNIT OPTION	DESCRIPTION
 Program bypass option:	C1	OEM Remote status (Lock/Unlock) monitoring
	D6	Push-to-Start

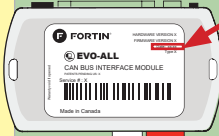
	ATTENTION!	 <p>DATE: XX-XX</p>	E5	OFF	SPECIAL FUNCTIONS: BY DEFAULT DEACTIVATED
				ON	MANUFACTURED MODULES BETWEEN: 04/2018 TO 04/2019

MANDATORY INSTALL

*HOOD PIN



HOOD STATUS: THE HOOD PIN SWITCH MUST BE INSTALLED IF THE VEHICLE CAN BE REMOTE STARTED WITH THE HOOD OPEN, SET FUNCTION **A11** TO OFF.

A11

OFF

Notice: the installation of safety elements are mandatory. The hood pin is an essential security element and must be installed.

THIS MODULE MUST BE INSTALLED BY A QUALIFIED TECHNICIAN. A WRONG CONNECTION CAN CAUSE PERMANENT DAMAGE TO THE VEHICLE.

DESCRIPTION

Parts required (Not included) PAGE

	1X 1Amp Diode 1X 5 Amp Fuse 1X 1k Ohm Resistor	Page 3
--	--	--------

THARNES THAR-GM6	1x THAR-GM6	Page 4
------------------	-------------	--------

BCM

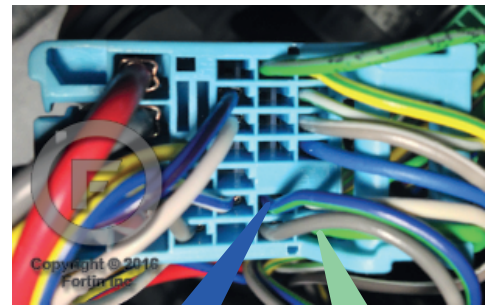
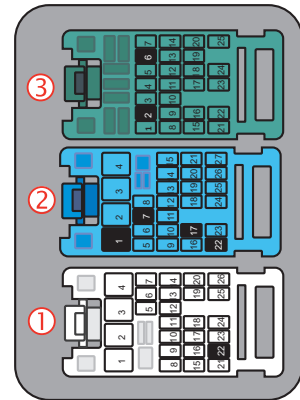
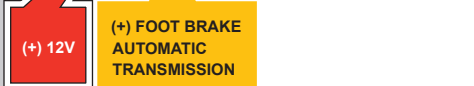
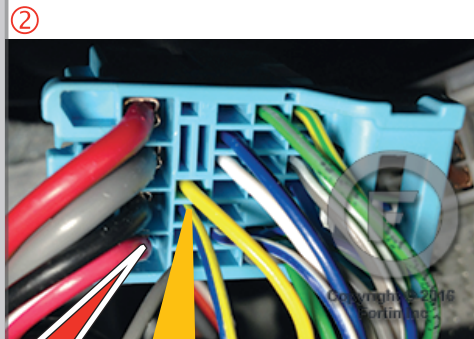
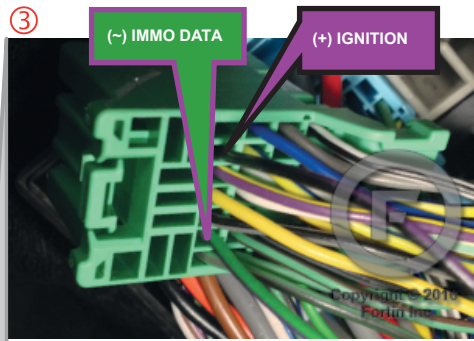
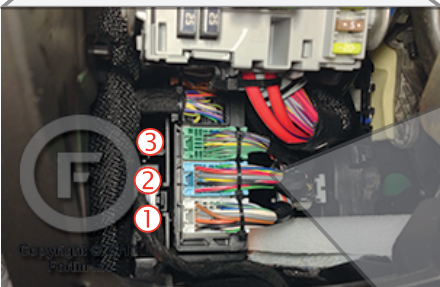

AUTOMATIC TRANSMISSION WIRING CONNECTION

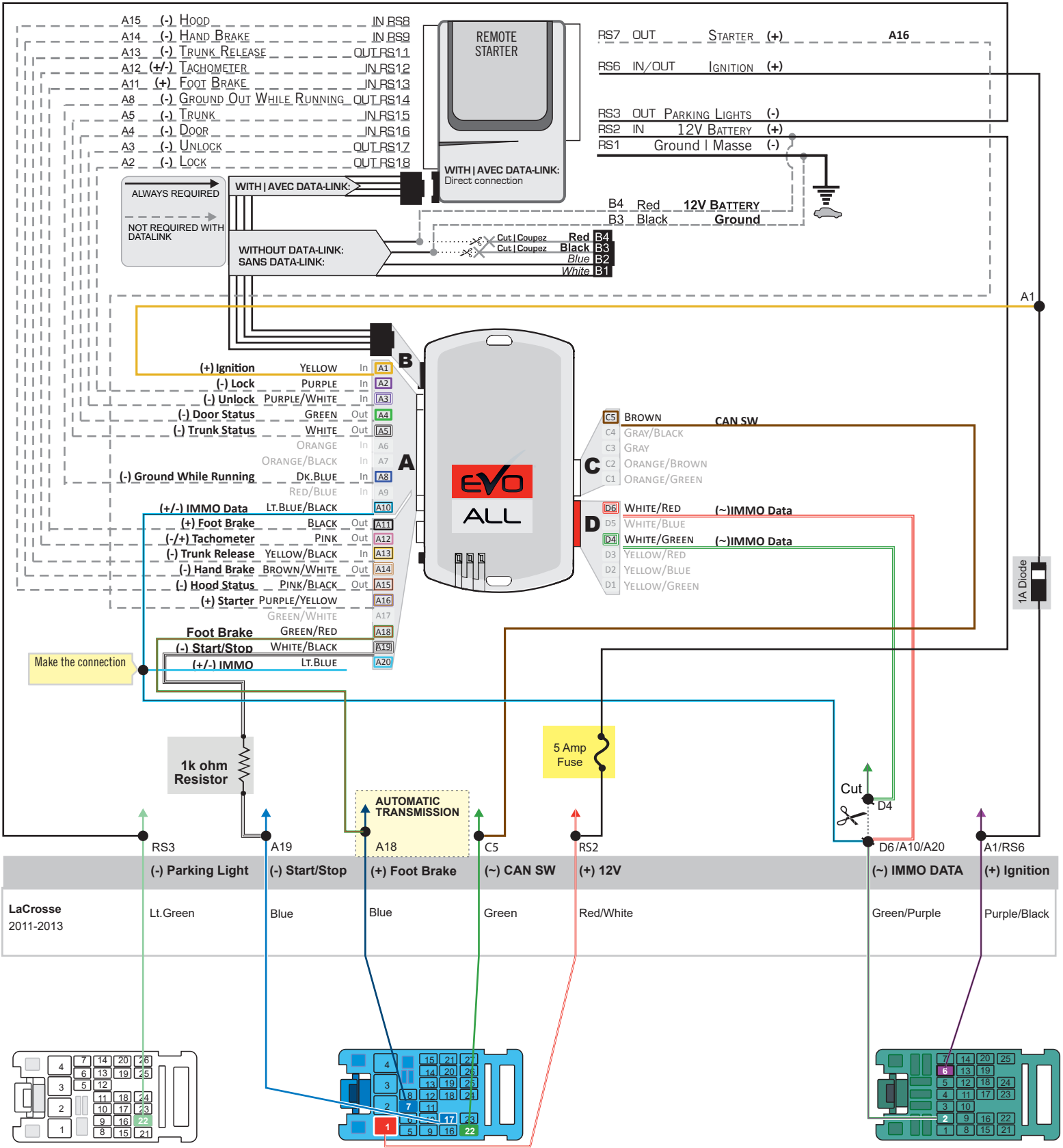

- ① Back view, 26-Pin White connector, at BCM.
- ② Back view, 27-Pin Blue connector, at BCM.
- ③ Back view, 25-Pin Green connector, at BCM.

THAR-GM6 | WIRING CONNECTION

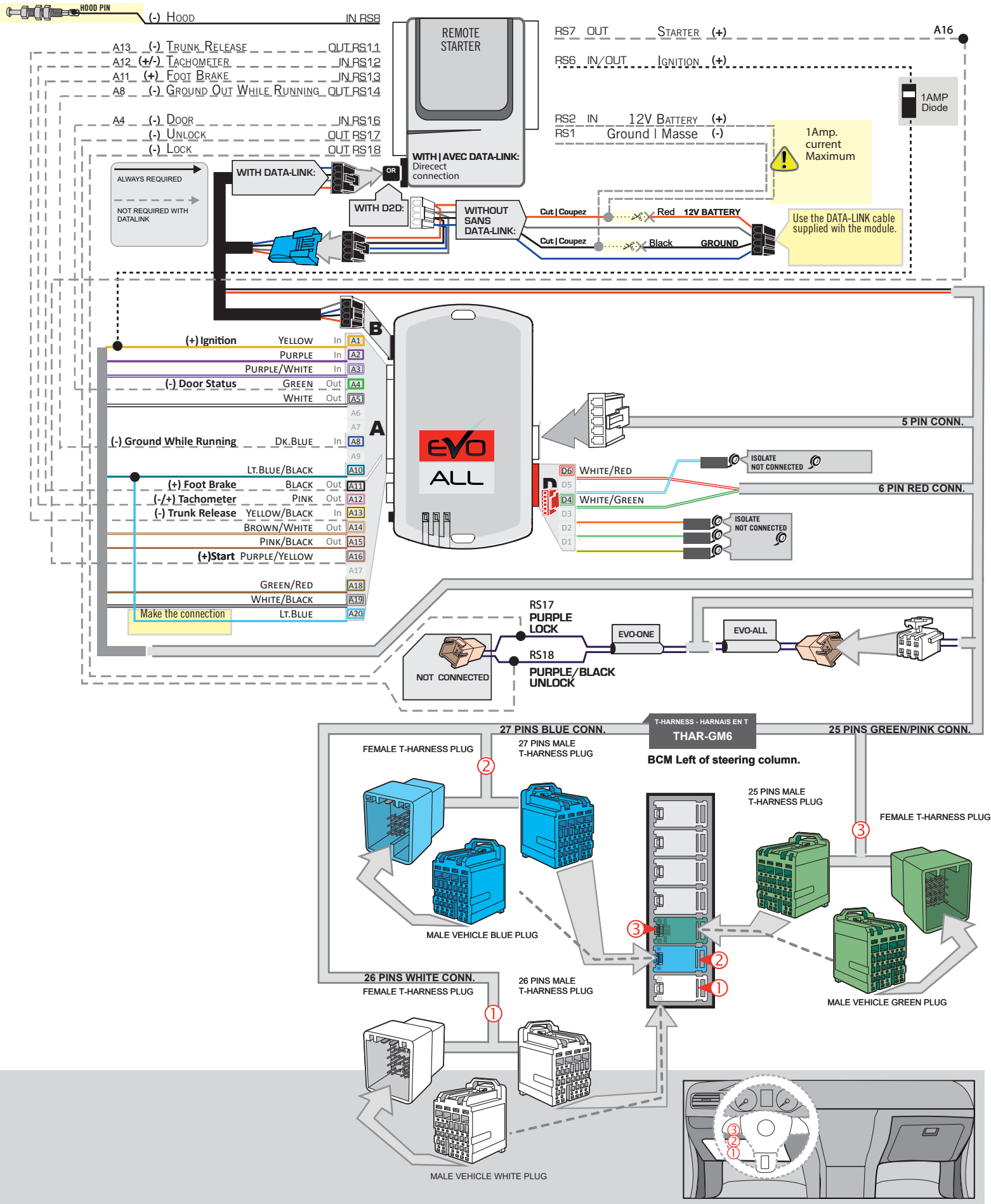

KEY BYPASS PROGRAMMING PROCEDURE 1/3

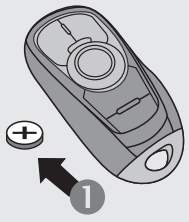

1 Remove the battery from the OEM remote.

2 Place the OEM remote into the transmitter pocket of the center console.

Refer to vehicle user guide for keyport location.

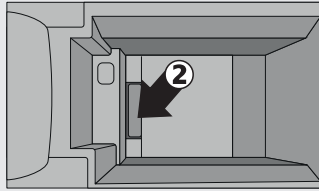

1

x1 HOLD

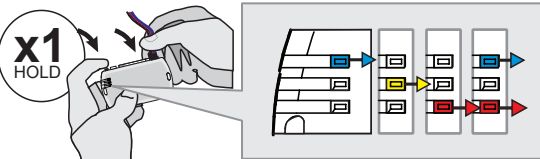

Press and hold the programming button:
Connect the 4-PIN Data-link harness (Black connector).

↳The Blue, Red, Yellow and Blue & Red LEDs will alternatively illuminate.

2

RELEASE

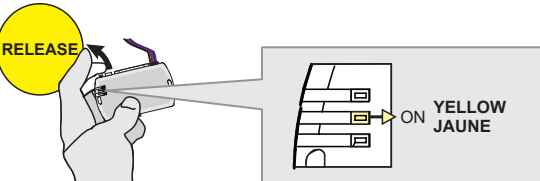

ON YELLOW JAUNE

Release the programming button when the LED is YELLOW.

If the LED is not solid YELLOW disconnect the 4-Pin connector (Data-Link) and go back to step 1.

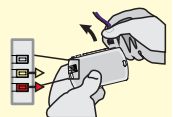

3

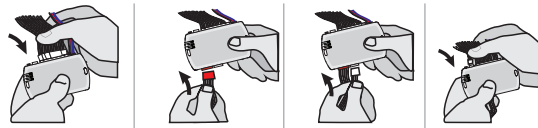

Insert the required remaining connectors.

4

x5 PRESS

ON → FLASH

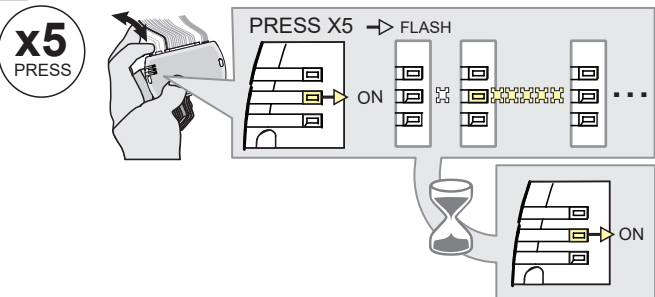

ON

Press and release the programming button five (5x) times.

↳The YELLOW LED will flash 5 times each second.

↳**WAIT** for the YELLOW LED to turn ON solide.

5

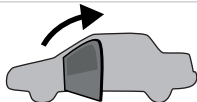

Open the driver door.

6

x1 PRESS HOLD START

IGNITION OFF → START

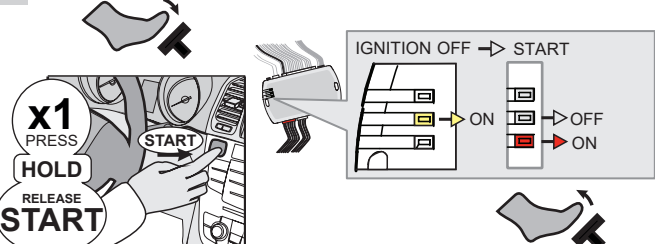

ON → OFF ON

Press the foot-brake pedal.

Press the Push-to-Start button until the engine start.

Release the foot-brake pedal.

↳The RED LED will turn ON.
 ↳The YELLOW LED will turn OFF.

KEY BYPASS PROGRAMMING PROCEDURE 2/3

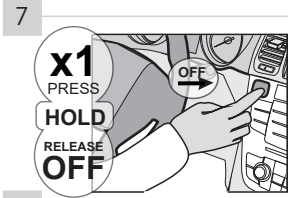

Press the Push-to-Start button until the engine turn OFF.

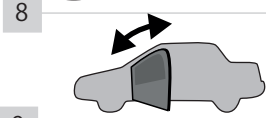

Close and open the driver door.



Press the foot-brake pedal.

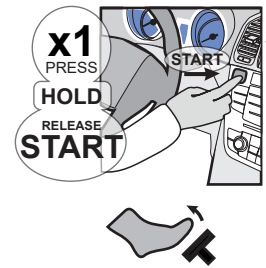

Press the Push-to-Start button until the engine start.

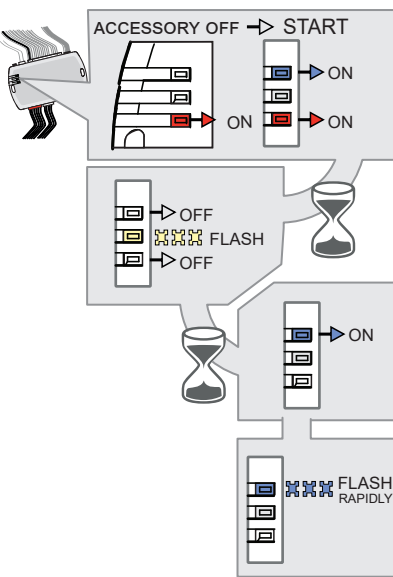

Release the foot-brake pedal.

↳ The BLUE LED will turn ON.

↳ The BLUE LED will turn OFF. The RED LED will turn OFF.

↳ The YELLOW LED will flash rapidly

↳ The BLUE LED will turn ON.

↳ The BLUE LED will flash rapidly

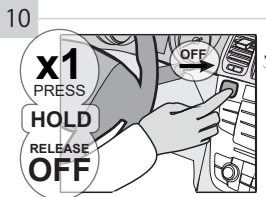

Press the Push-to-Start button until the engine turn OFF.

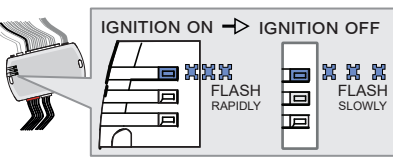

↳ The BLUE LED will flash slowly

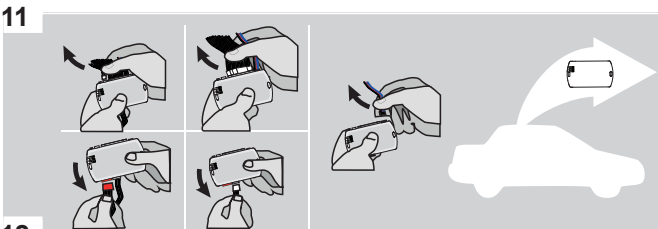

Disconnect all the connectors and after the Data-Link (4-pins) connector.

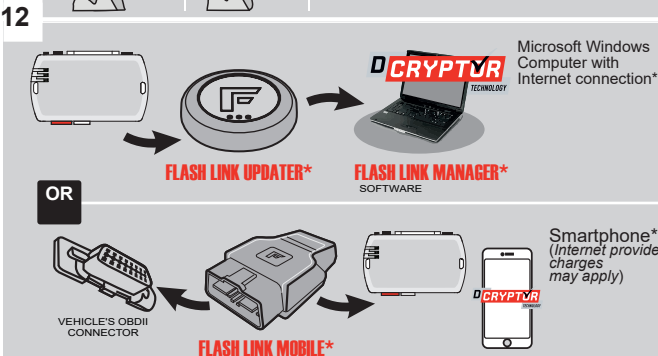

Use the tool: FLASH LINK UPDATER or FLASH LINK MOBILE to visit the DCRYPTOR menu.

*Parts required (not included)

KEY BYPASS PROGRAMMING PROCEDURE 3/3

13

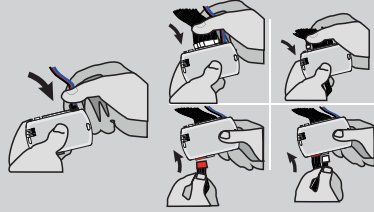
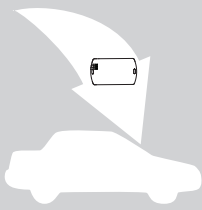

AFTER DCRYPTOR PROGRAMMING COMPLETED
Go back to the vehicle and **reconnect** the 4-Pin (Data-Link) connector and after, all the remaining connector.



The module is now programmed.



REMOTE STARTER / ALARM VERIFICATION PROCEDURE

Test the remote starter. Remote start the vehicle.

REMOTE STARTER FUNCTIONALITY



All doors must be closed.



Remote start the vehicle.



Unlock the doors with either:

- The OEM remote
- The remote-starter remote
- Or the proximity remote

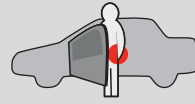

Enter the vehicle with the Intelligent Key.



The vehicle can now be put in to gear and driven.

If the vehicle is not unlocked with one of these conditions the remote-starter will shut down as soon as any door is opened.



REGULAR INSTALLATION AND THAR-GM6 INSTALLATION

ADDENDUM - SUGGESTED WIRING CONFIGURATION

VEHICLE		YEARS	Vehicle functions supported in this diagram (functional if equipped)													
			Immobilizer bypass	Lock	Unlock	Arm	Disarm	Parking Light	Trunk (open)	RAP Disable	Tachometer	Door Status	Trunk Status	Hand-Brake Status	Foot-Brake Status	OEM Remote Monitoring
BUICK																
LaCrosse	Push-To-Start	2014	•	•	•	•	•	•	•	•	•	•	•	•	•	•

FIRMWARE VERSION

70.[41]

GM MINIMUM

To add the firmware version and the options, use the **FLASH LINK UPDATER** or **FLASH LINK MOBILE** tool, sold separately.

<p>IF THE VEHICLE IS NOT EQUIPPED WITH FUNCTIONAL HOOD PIN:</p>	A11	OFF	Hood trigger (Output Status).
--	------------	------------	-------------------------------

	UNIT OPTION	DESCRIPTION
<p>Program bypass option:</p>	C1	OEM Remote status (Lock/Unlock) monitoring
	D6	Push-to-Start

	<p>ATTENTION!</p>	<p>DATE: XX-XX</p>	E5	OFF	<p>SPECIAL FUNCTIONS: BY DEFAULT DEACTIVATED</p>
				ON	<p>MANUFACTURED MODULES BETWEEN: 04/2018 TO 04/2019</p>

MANDATORY INSTALL

*HOOD PIN



HOOD STATUS: THE HOOD PIN SWITCH MUST BE INSTALLED IF THE VEHICLE CAN BE REMOTE STARTED WITH THE HOOD OPEN, SET FUNCTION **A11** TO OFF.

A11	OFF
------------	------------

Notice: the installation of safety elements are mandatory. The hood pin is an essential security element and must be installed.

THIS MODULE MUST BE INSTALLED BY A QUALIFIED TECHNICIAN. A WRONG CONNECTION CAN CAUSE PERMANENT DAMAGE TO THE VEHICLE.

DESCRIPTION

Parts required (Not included) PAGE

WIRE TO WIRE DIAGRAM

	1X 1Amp Diode 1X 5 Amp Fuse 1X 1k Ohm Resistor	Page 3
--	--	--------

THARNESS DIAGRAM

THARNESS THAR-GM6	1x THAR-GM6	Page 4
-------------------	-------------	--------

BCM

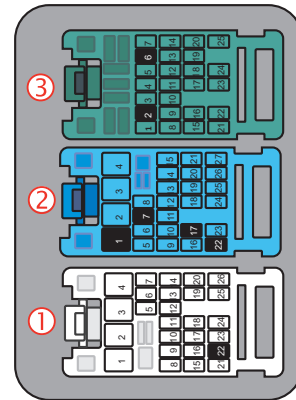
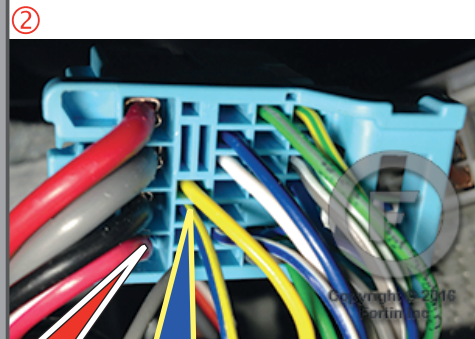
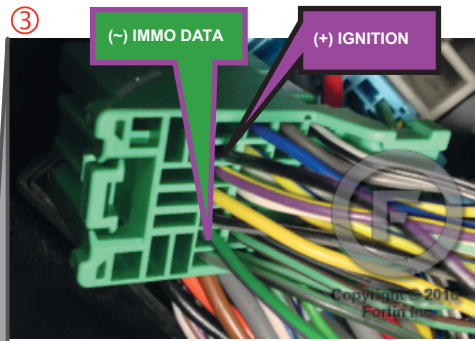
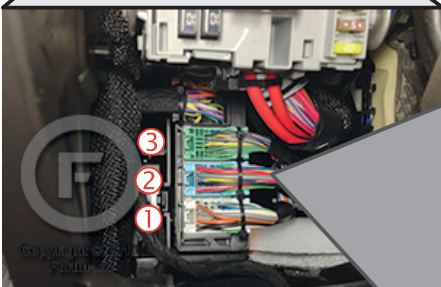
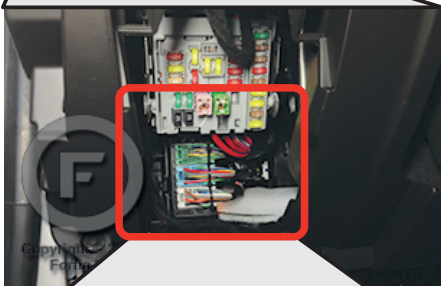

AUTOMATIC TRANSMISSION WIRING CONNECTION

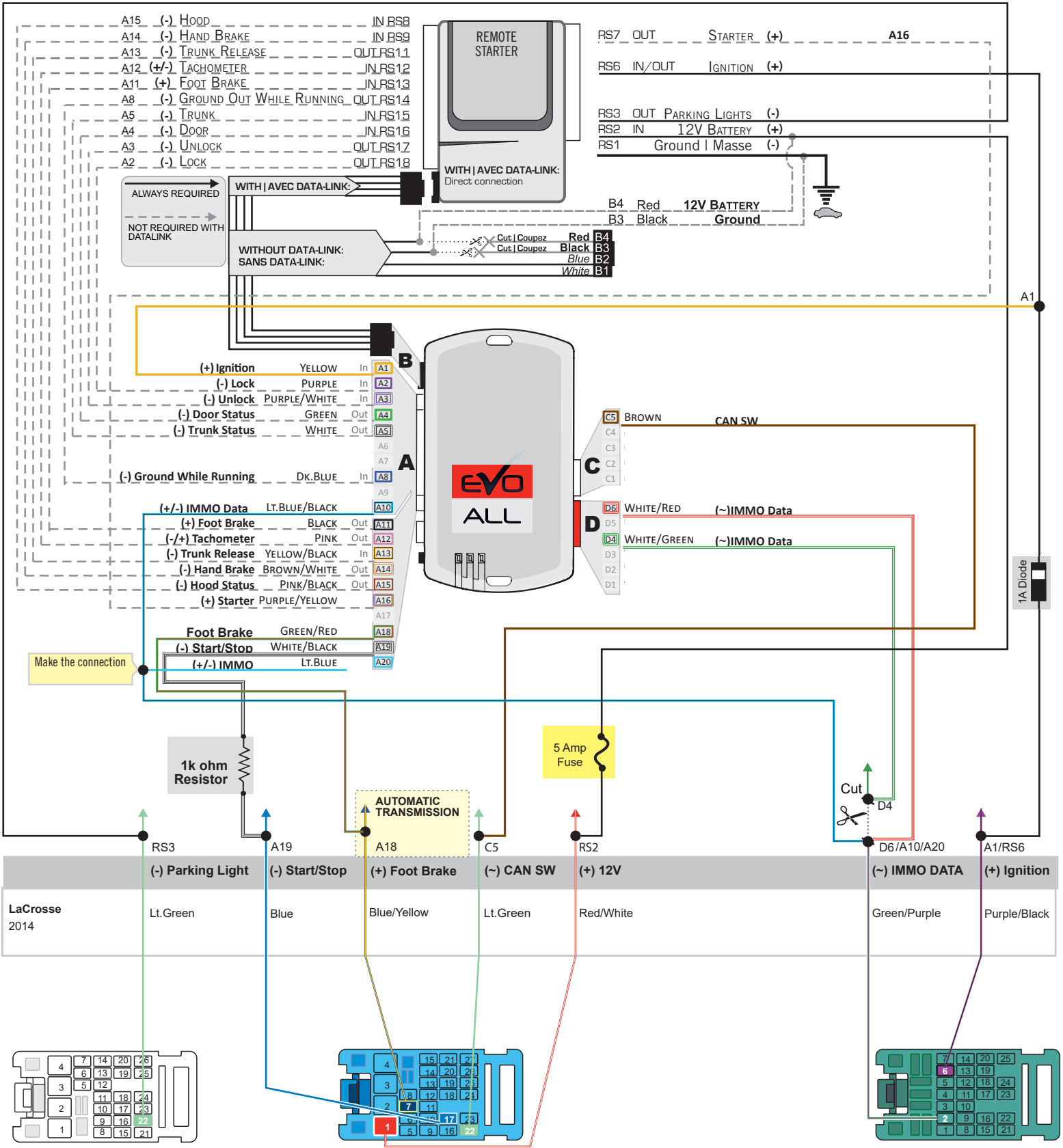

① Back view, 26-Pin White connector, at BCM.

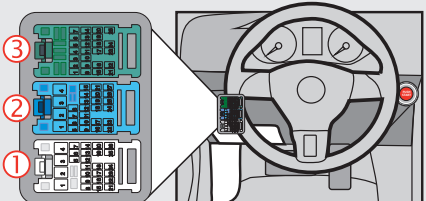

② Back view, 27-Pin Blue connector, at BCM.

③ Back view, 25-Pin Green connector, at BCM.

THAR-GM6 | WIRING CONNECTION

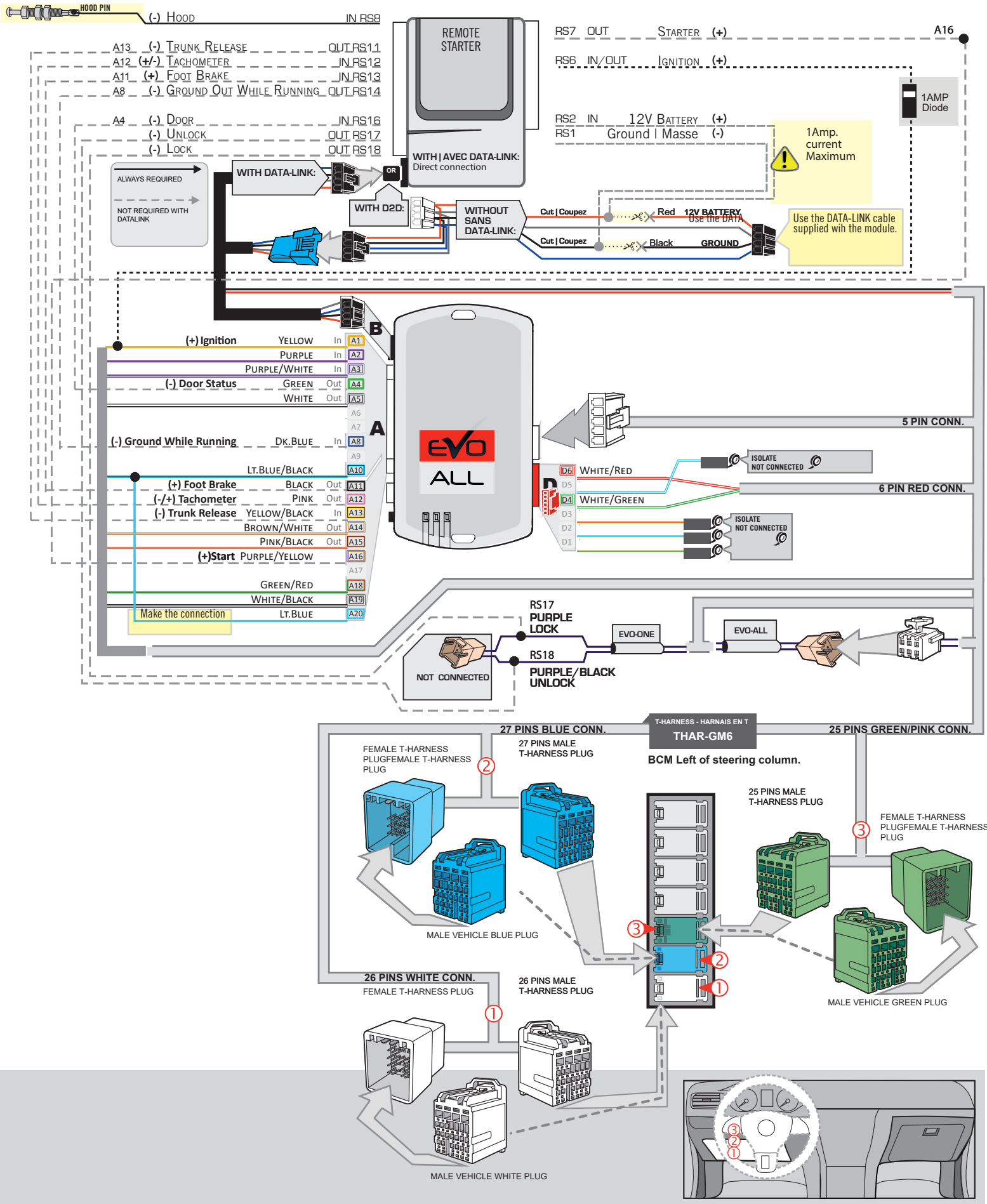

KEY BYPASS PROGRAMMING PROCEDURE 1/3

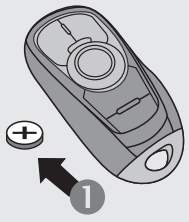

1 Remove the battery from the OEM remote.

2 Place the OEM remote into the transmitter pocket of the center console.

Refer to vehicle user guide for keyport location.

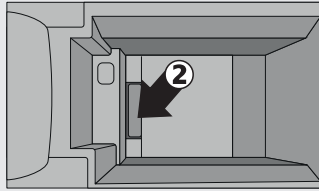

1

x1 HOLD

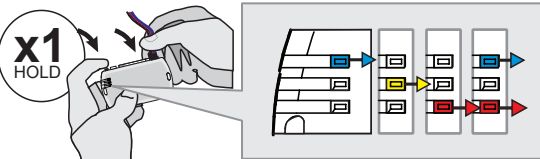
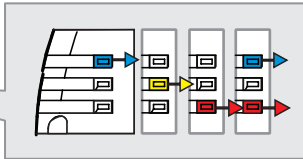



Press and hold the programming button:
Connect the 4-PIN Data-link harness (Black connector).

↳The Blue, Red, Yellow and Blue & Red LEDs will alternatively illuminate.

2

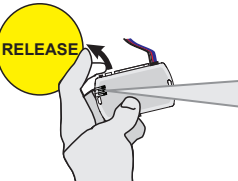
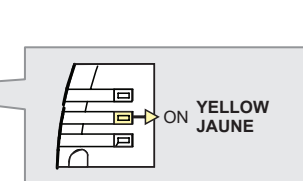
RELEASE



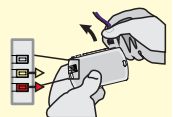

Release the programming button when the LED is **YELLOW**.

If the LED is not solid YELLOW disconnect the 4-Pin connector (Data-Link) and go back to step 1.

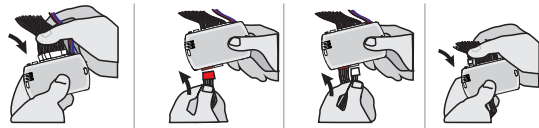

3



Insert the required remaining connectors.

4

x5 PRESS

PRESS X5 → FLASH

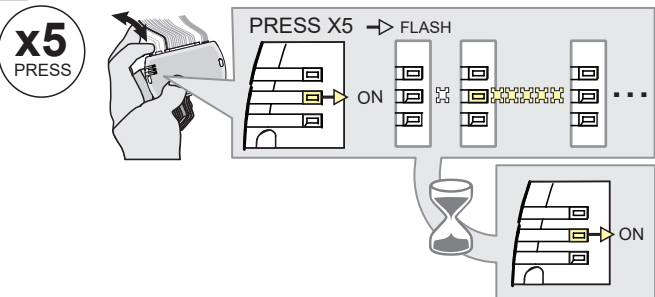

Press and release the programming button five (5x) times.

↳The **YELLOW LED** will flash 5 times each second.

↳**WAIT** for the **YELLOW LED** to turn ON solide.

5



Open the driver door.

6

x1 PRESS HOLD RELEASE START

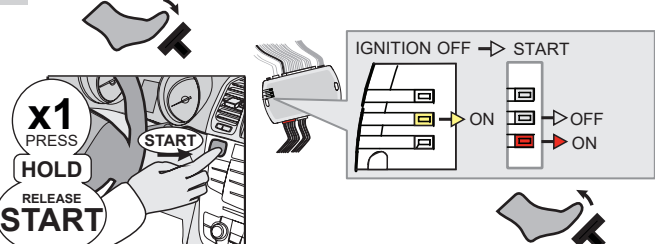

IGNITION OFF → START

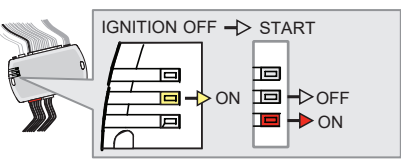

Press the foot-brake pedal.

Press the Push-to-Start button until the engine start.

Release the foot-brake pedal.

↳The **RED LED** will turn ON.
 ↳The **YELLOW LED** will turn OFF.

KEY BYPASS PROGRAMMING PROCEDURE 2/3

7



Press the Push-to-Start button until the engine turn OFF.

8

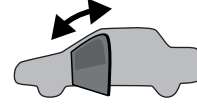

Close and open the driver door.

9

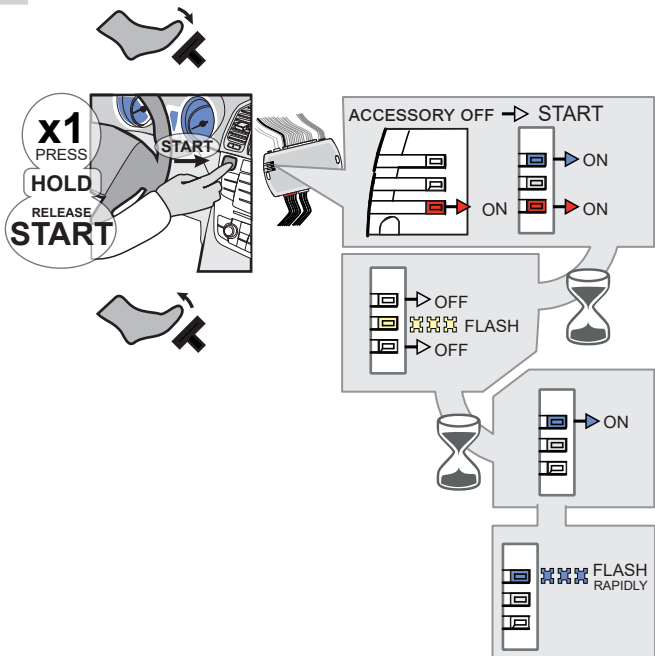

Press the foot-brake pedal.

Press the Push-to-Start button until the engine start.

Release the foot-brake pedal.

- ↳ The BLUE LED will turn ON.
- ↳ The BLUE LED will turn OFF. The RED LED will turn OFF.
- ↳ The YELLOW LED will flash rapidly
- ↳ The BLUE LED will turn ON.
- ↳ The BLUE LED will flash rapidly

10

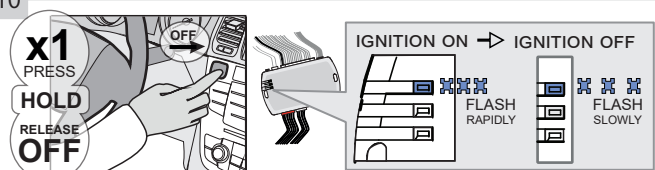

Press the Push-to-Start button until the engine turn OFF.

- ↳ The BLUE LED will flash slowly

11

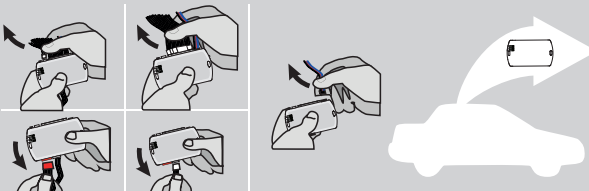

Disconnect all the connectors and after the Data-Link (4-pins) connector.

12

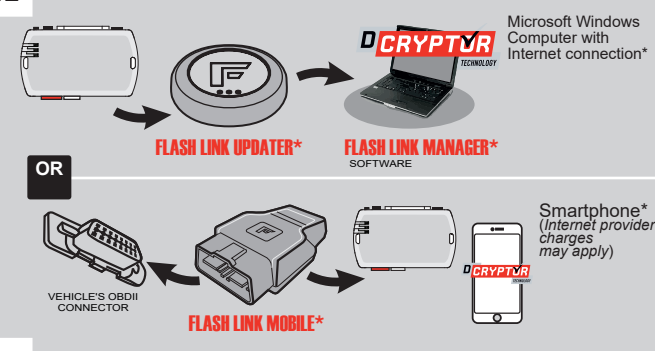

Microsoft Windows Computer with Internet connection*

FLASH LINK UPDATER* **FLASH LINK MANAGER*** SOFTWARE

OR

Smartphone* (Internet provider charges may apply)

VEHICLE'S OBDII CONNECTOR **FLASH LINK MOBILE***

Use the tool: FLASH LINK UPDATER or FLASH LINK MOBILE to visit the DCryptor menu.

*Parts required (not included)

KEY BYPASS PROGRAMMING PROCEDURE 3/3

13

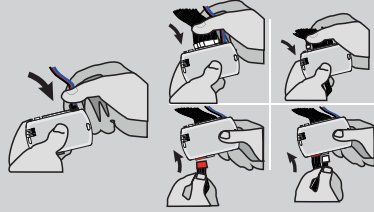
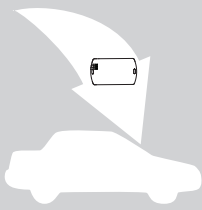

AFTER DCRYPTOR PROGRAMMING COMPLETED
Go back to the vehicle and **reconnect** the 4-Pin (Data-Link) connector and after, all the remaining connector.



The module is now programmed.



REMOTE STARTER / ALARM VERIFICATION PROCEDURE

Test the remote starter. Remote start the vehicle.

REMOTE STARTER FUNCTIONALITY |



All doors must be closed.



Remote start the vehicle.



Unlock the doors with either:

- The OEM remote
- The remote-starter remote
- Or the proximity remote

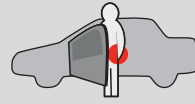

Enter the vehicle with the Intelligent Key.



The vehicle can now be put in to gear and driven.

If the vehicle is not unlocked with one of these conditions the remote-starter will shut down as soon as any door is opened.



REGULAR INSTALLATION AND THAR-GM6

ADDENDUM - SUGGESTED WIRING CONFIGURATION

VEHICLE	YEARS	Vehicle functions supported in this diagram (functional if equipped)													
		Immobilizer bypass	Lock	Unlock	Arm	Disarm	Parking Light	Trunk (open)	RAP Disable	Tachometer	Door Status	Trunk Status	Hand-Brake Status	Foot-Brake Status	OEM Remote Monitoring
BUICK															
LaCrosse	Push-To-Start	2015-2016	•	•	•	•	•	•	•	•	•	•	•	•	•



FIRMWARE VERSION

70.[41]

GM MINIMUM

To add the firmware version and the options, use the **FLASH LINK UPDATER** or **FLASH LINK MOBILE** tool, sold separately.

IF THE VEHICLE IS NOT EQUIPPED WITH FUNCTIONAL HOOD PIN:	A11	OFF	Hood trigger (Output Status).
---	------------	------------	-------------------------------

	UNIT OPTION	DESCRIPTION
 Program bypass option:	C1	OEM Remote status (Lock/Unlock) monitoring
	D6	Push-to-Start

	ATTENTION!	 <p>DATE: XX-XX</p>	E5	OFF	SPECIAL FUNCTIONS: BY DEFAULT DEACTIVATED
				ON	MANUFACTURED MODULES BETWEEN: 04/2018 TO 04/2019

MANDATORY INSTALL

*HOOD PIN



HOOD STATUS: THE HOOD PIN SWITCH MUST BE INSTALLED IF THE VEHICLE CAN BE REMOTE STARTED WITH THE HOOD OPEN, SET FUNCTION **A11** TO OFF.

A11	OFF
------------	------------

Notice: the installation of safety elements are mandatory. The hood pin is an essential security element and must be installed.

THIS MODULE MUST BE INSTALLED BY A QUALIFIED TECHNICIAN. A WRONG CONNECTION CAN CAUSE PERMANENT DAMAGE TO THE VEHICLE.

DESCRIPTION

Parts required (Not included) PAGE

WIRE TO WIRE DIAGRAM

	1X 1Amp Diode 1X 5 Amp Fuse 1X 1k Ohm Resistor	Page 3
--	--	--------

THARNESSE DIAGRAM

THARNESSE THAR-GM6	1x THAR-GM6	Page 4
--------------------	-------------	--------

BCM

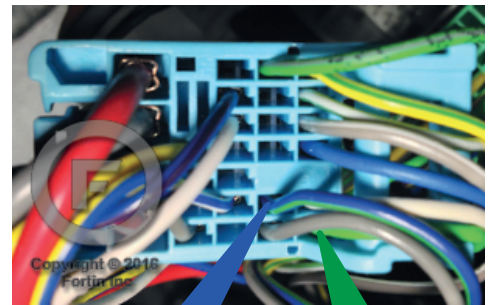
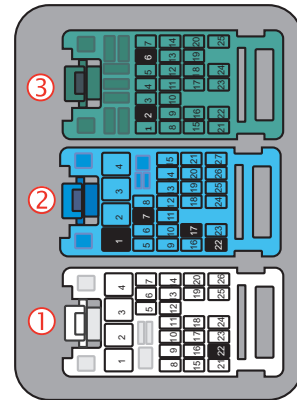
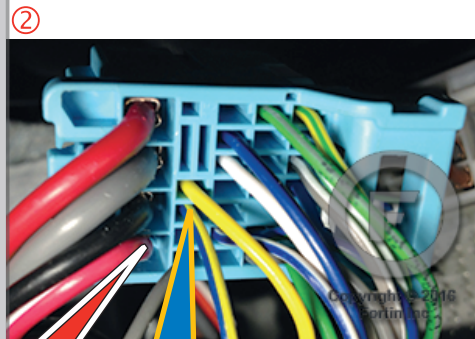
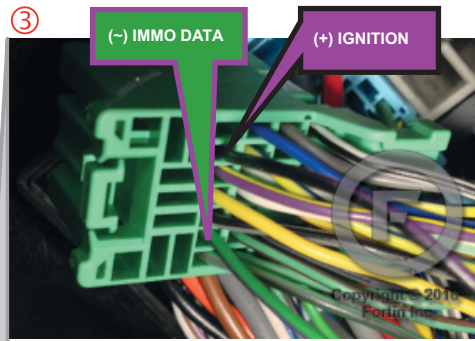
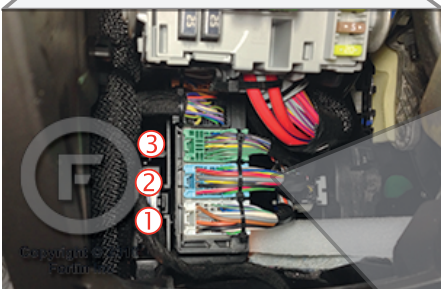
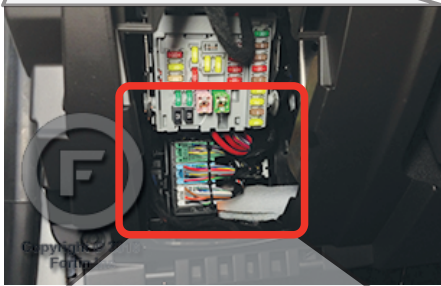

AUTOMATIC TRANSMISSION WIRING CONNECTION

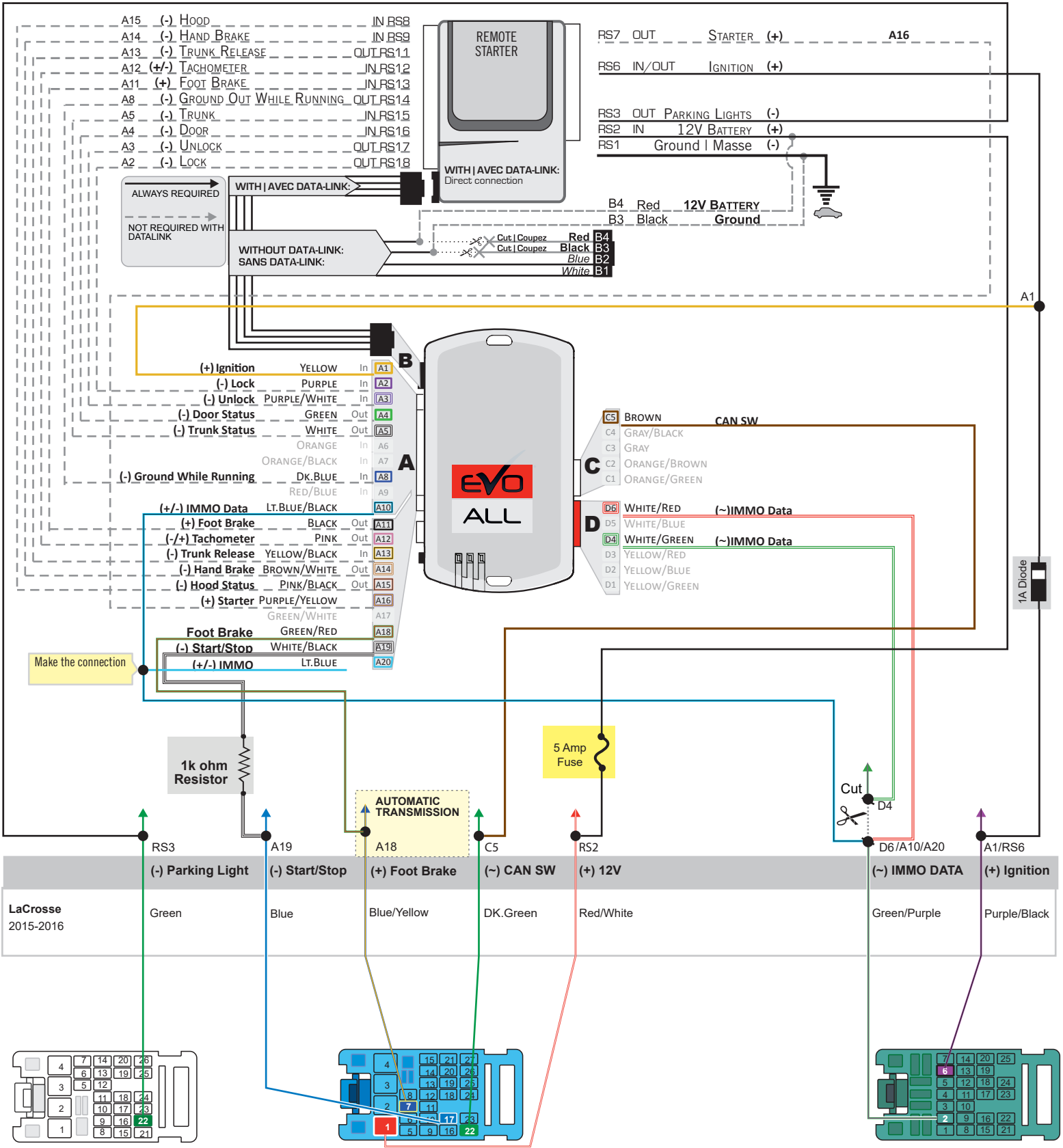

- Back view, 26-Pin White connector, at BCM.
- Back view, 27-Pin Blue connector, at BCM.
- Back view, 25-Pin Green connector, at BCM.

THAR-GM6 | WIRING CONNECTION

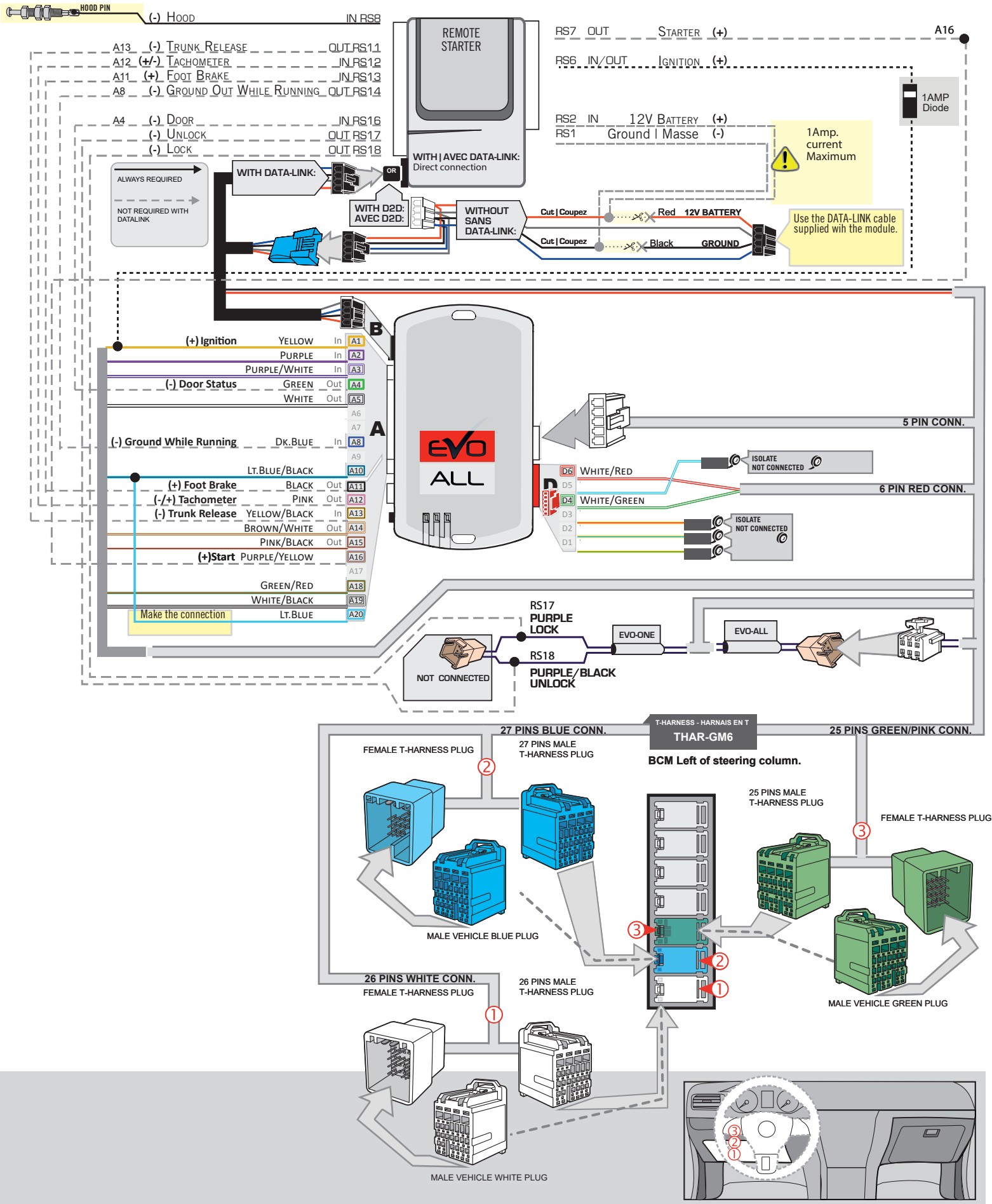

KEY BYPASS PROGRAMMING PROCEDURE 1/3 |

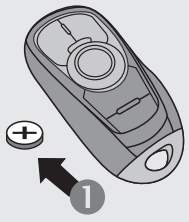

1 Remove the battery from the OEM remote.

2 Place the OEM remote into the transmitter pocket of the center console.

Refer to vehicle user guide for keyport location.

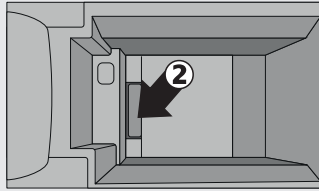

1

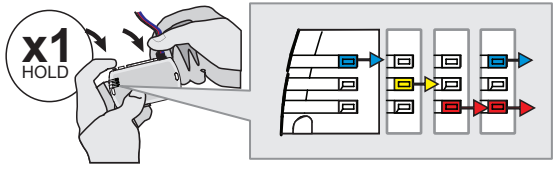

Press and hold the programming button:
Connect the 4-PIN Data-link harness (Black connector).

↳The Blue, Red, Yellow and Blue & Red LEDs will alternatively illuminate.

2

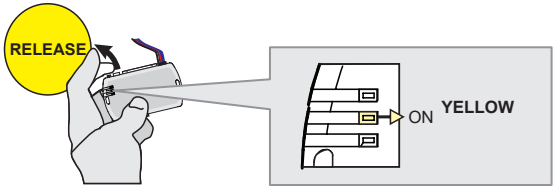

Release the programming button when the LED is **YELLOW**.

If the LED is not solid YELLOW disconnect the 4-Pin connector (Data-Link) and go back to step 1.

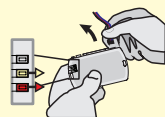

3

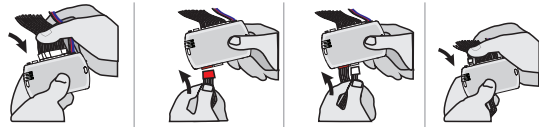

Insert the required remaining connectors.

4

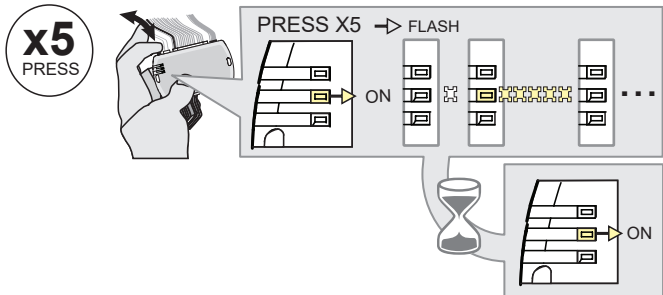

Press and release the programming button five (5x) times.

↳The YELLOW LED will flash 5 times each second.

↳WAIT for the YELLOW LED to turn ON solide.

5

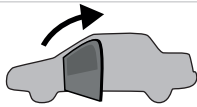

Open the driver door.

6

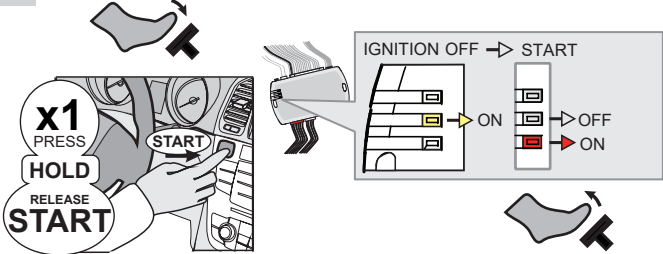

Press the foot-brake pedal.

Press the Push-to-Start button until the engine start.

Release the foot-brake pedal.

↳The RED LED will turn ON.
↳The YELLOW LED will turn OFF.

KEY BYPASS PROGRAMMING PROCEDURE 2/3 |

7



Press the Push-to-Start button until the engine turn OFF.

8

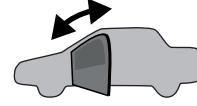

Close and open the driver door.

9

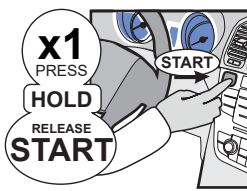
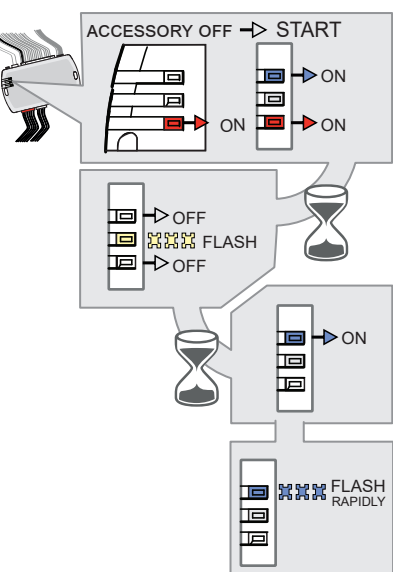
Press the foot-brake pedal.

Press the Push-to-Start button until the engine start.

Release the foot-brake pedal.

- ↳ The BLUE LED will turn ON.
- ↳ The BLUE LED will turn OFF. The RED LED will turn OFF.
- ↳ The YELLOW LED will flash rapidly
- ↳ The BLUE LED will turn ON.
- ↳ The BLUE LED will flash rapidly

10

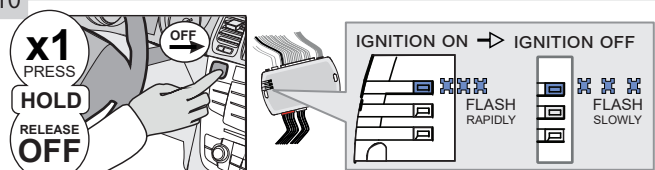
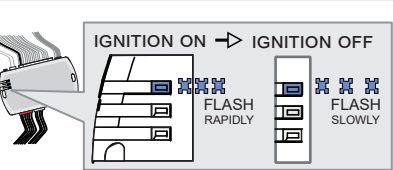
Press the Push-to-Start button until the engine turn OFF.

- ↳ The BLUE LED will flash slowly

11

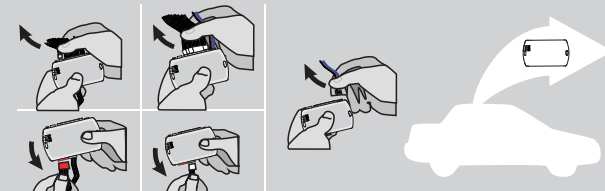

Disconnect all the connectors and after the Data-Link (4-pins) connector.

Débranchez tous les connecteurs et ensuite le connecteur Data-Link (4-pins).

12

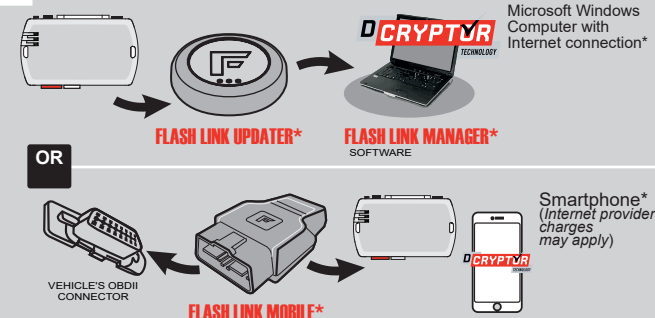

Microsoft Windows Computer with Internet connection*

FLASH LINK UPDATER* **FLASH LINK MANAGER*** SOFTWARE

OR

Smartphone* (Internet provider charges may apply)

FLASH LINK MOBILE*

Use the tool: FLASH LINK UPDATER or FLASH LINK MOBILE to visit the DCryptor menu.

*Parts required (not included)

13

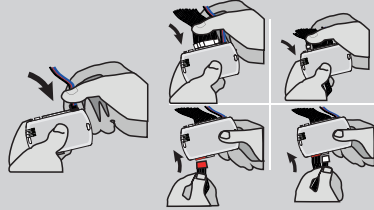
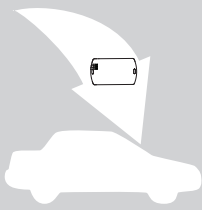

AFTER DCRYPTOR PROGRAMMING COMPLETED
Go back to the vehicle and **reconnect** the 4-Pin (Data-Link) connector and after, all the remaining connector.



The module is now programmed.



REMOTE STARTER / ALARM VERIFICATION PROCEDURE

Test the remote starter. Remote start the vehicle.

REMOTE STARTER FUNCTIONALITY |



All doors must be closed.



Remote start the vehicle.



Unlock the doors with either:

- The OEM remote
- The remote-starter remote
- Or the proximity remote



Enter the vehicle with the Intelligent Key.



The vehicle can now be put in to gear and driven.

If the vehicle is not unlocked with one of these conditions the remote-starter will shut down as soon as any door is opened.



REGULAR INSTALLATION AND THAR-GM6 INSTALLATION

ADDENDUM - SUGGESTED WIRING CONFIGURATION

VEHICLE	YEARS	Vehicle functions supported in this diagram (functional if equipped)																
		Immobilizer bypass	Lock	Unlock	Arm	Disarm	Parking Light	Trunk (open)	RAP Disable	Tachometer	Door Status	Trunk Status	Hand-Brake Status	Foot-Brake Status	OEM Remote Monitoring			
																		
CHEVROLET																		
Malibu	Push-To-Start	2013-2015	•	•	•	•	•	•	•	•	•	•	•	•	•	•	•	•



FIRMWARE VERSION

70.[41]

GM MINIMUM

To add the firmware version and the options, use the **FLASH LINK UPDATER** or **FLASH LINK MOBILE** tool, sold separately.

IF THE VEHICLE IS NOT EQUIPPED WITH FUNCTIONAL HOOD PIN:	A11	OFF	Hood trigger (Output Status).
---	------------	-----	-------------------------------

	UNIT OPTION	DESCRIPTION
 <p>Program bypass option:</p>	C1	OEM Remote status (Lock/Unlock) monitoring
	D6	Push-to-Start

	ATTENTION!	 <p>DATE: XX-XX</p>	E5	OFF	SPECIAL FUNCTIONS: BY DEFAULT DEACTIVATED
				ON	MANUFACTURED MODULES BETWEEN: 04/2018 TO 04/2019

MANDATORY INSTALL

*HOOD PIN



HOOD STATUS: THE HOOD PIN SWITCH MUST BE INSTALLED IF THE VEHICLE CAN BE REMOTE STARTED WITH THE HOOD OPEN, SET FUNCTION **A11** TO OFF.

A11	OFF
------------	-----

Notice: the installation of safety elements are mandatory. The hood pin is an essential security element and must be installed.

THIS MODULE MUST BE INSTALLED BY A QUALIFIED TECHNICIAN. A WRONG CONNECTION CAN CAUSE PERMANENT DAMAGE TO THE VEHICLE.

DESCRIPTION

Parts required (Not included) PAGE

WIRE TO WIRE DIAGRAM

	1X 1Amp Diode 1X 5 Amp Fuse 1X 1k Ohm Resistor	Page 3
--	--	--------

THARNESS DIAGRAM

THARNESS THAR-GM6	1x THAR-GM6	Page 4
-------------------	-------------	--------

BCM

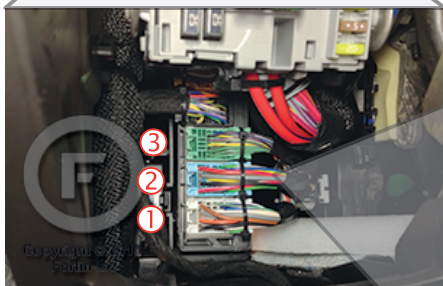
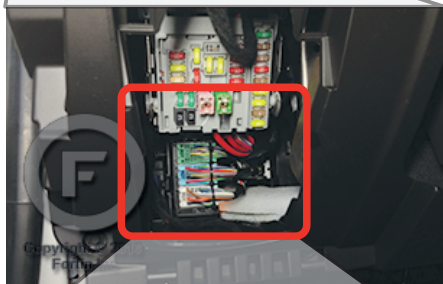

Malibu

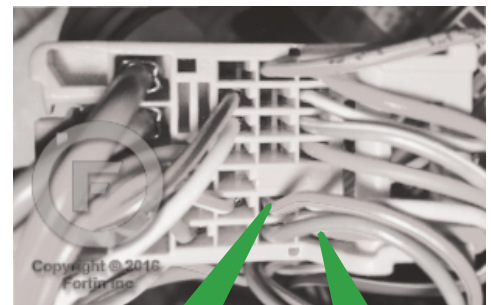
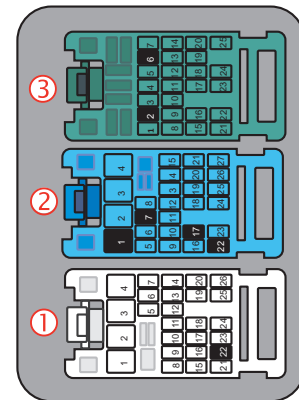
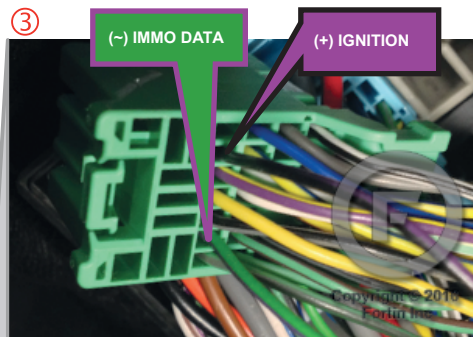

(-) PARKING LIGHTS

AUTOMATIC TRANSMISSION WIRING CONNECTION

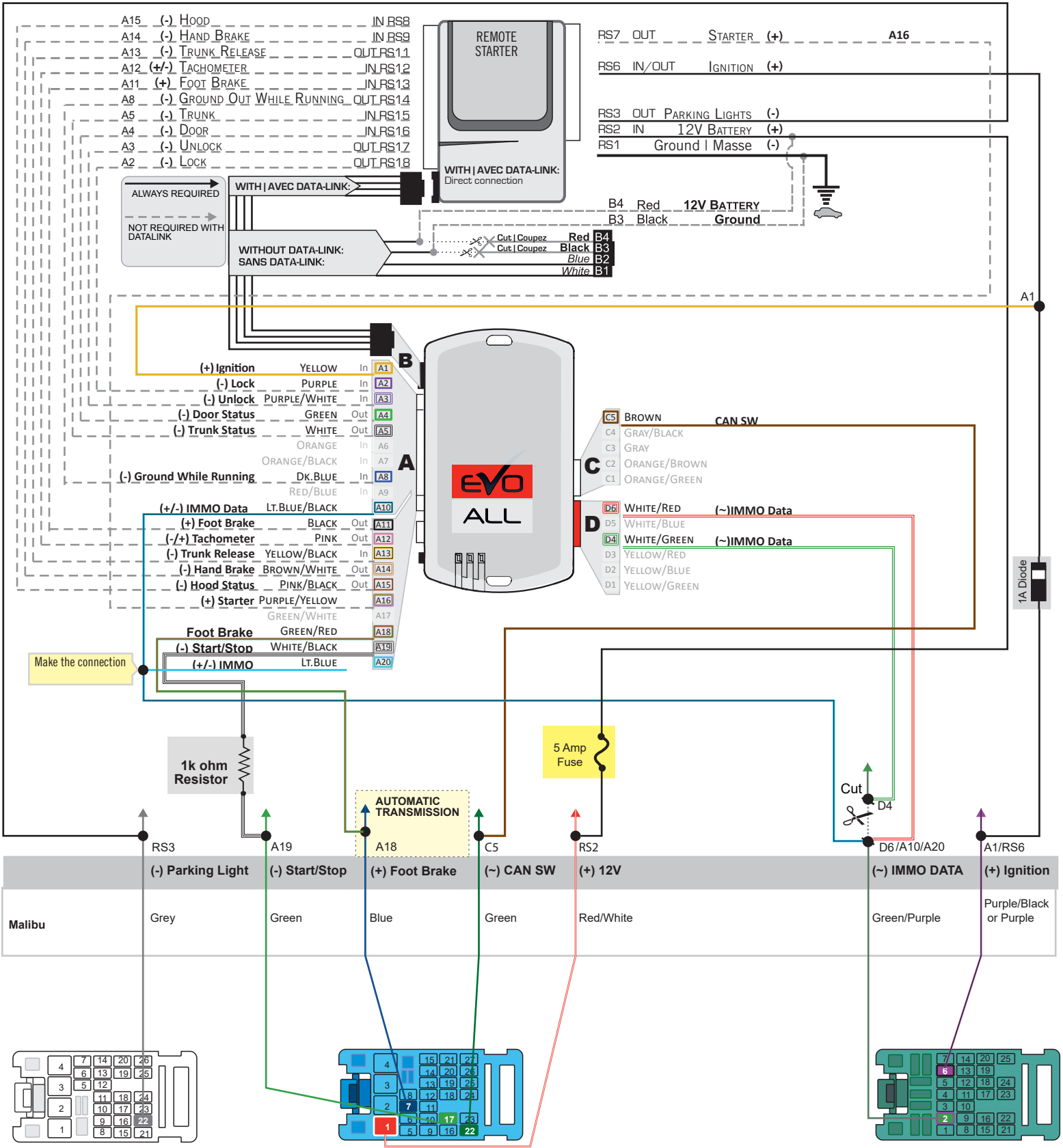

① Back view, 26-Pin White connector, at BCM.

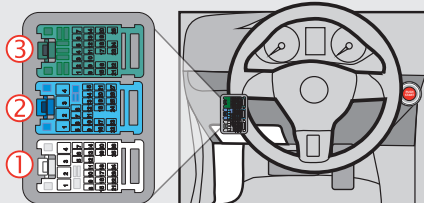

② Back view, 27-Pin Blue connector, at BCM.

③ Back view, 25-Pin Green connector, at BCM.

THAR-GM6 | WIRING CONNECTION

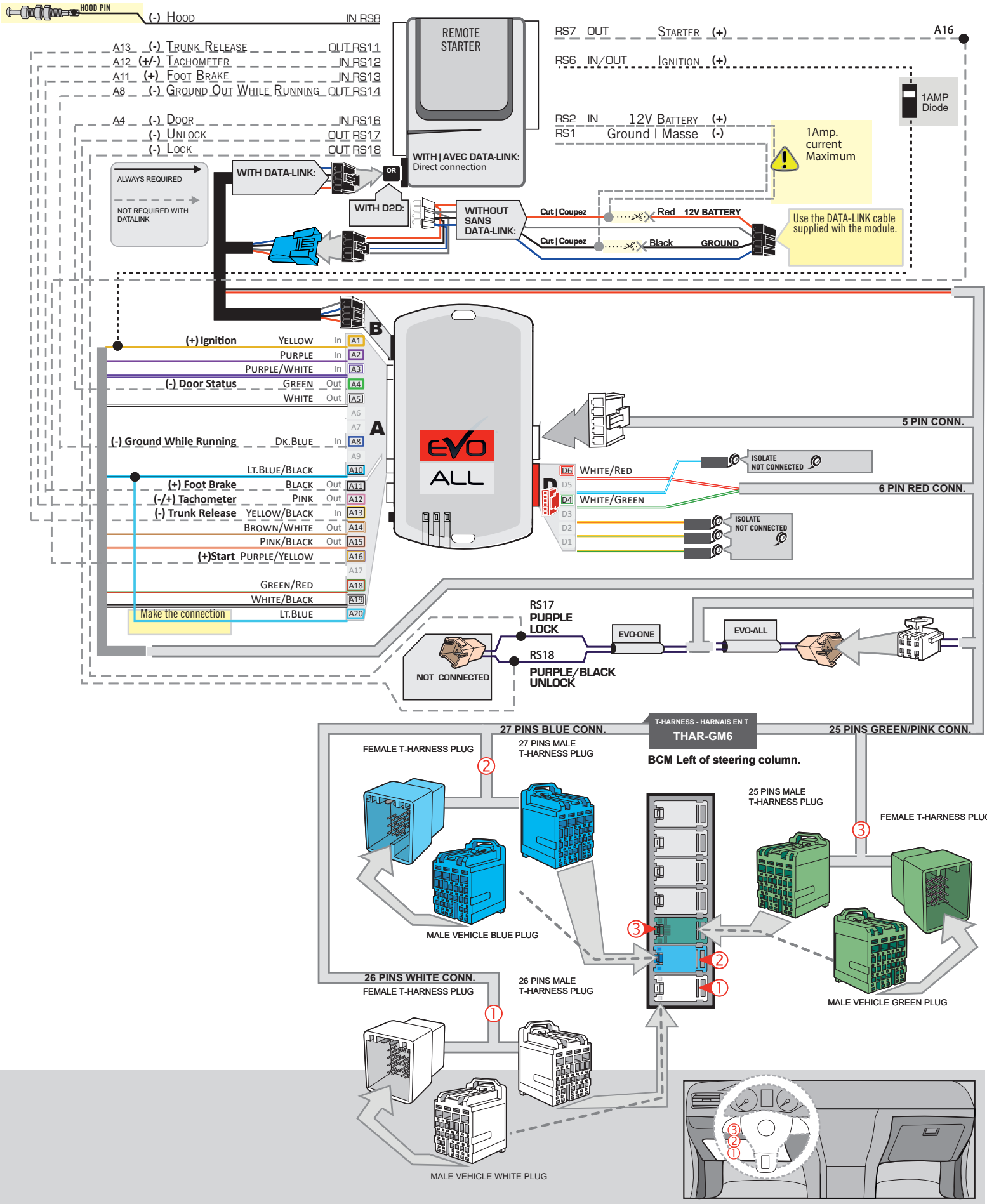

KEY BYPASS PROGRAMMING PROCEDURE 1/3 |

Chevrolet Malibu



- 1 Remove the battery from the OEM remote.
- 2 Place the OEM remote into the transmitter pocket of the center console.
Refer to vehicle user guide for keyport location.

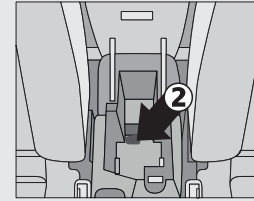

1

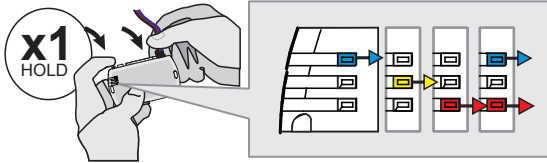

Press and hold the programming button:
Connect the 4-PIN Data-link harness (Black connector).

↳The Blue, Red, Yellow and Blue & Red LEDs will alternatively illuminate.

2

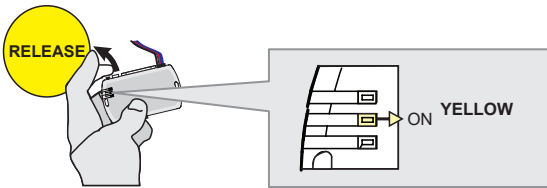

Release the programming button when the LED is YELLOW.

If the LED is not solid YELLOW disconnect the 4-Pin connector (Data-Link) and go back to step 1.

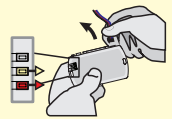

3

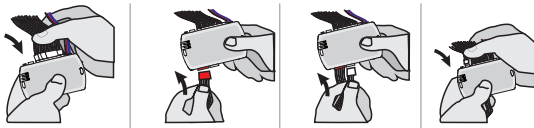

Insert the required remaining connectors.

4

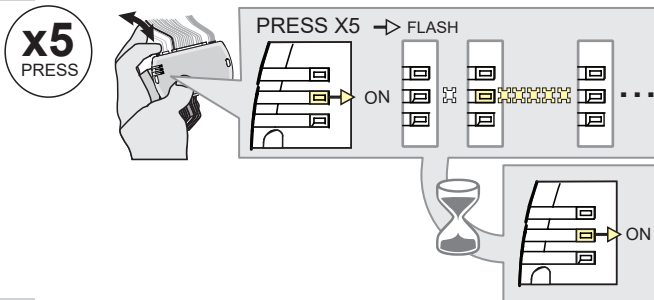

Press and release the programming button five (5x) times.

↳The YELLOW LED will flash 5 times each second.

↳**WAIT** for the YELLOW LED to turn ON solide.

5

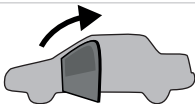

Open the driver door.

6

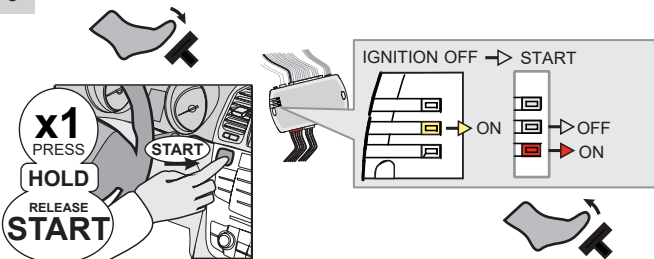

Press the foot-brake pedal.

Press the Push-to-Start button until the engine start.

Release the foot-brake pedal.

↳The RED LED will turn ON.
↳The YELLOW LED will turn OFF.

KEY BYPASS PROGRAMMING PROCEDURE 2/3 |

7



Press the Push-to-Start button until the engine turn OFF.

8

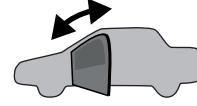

Close and open the driver door.

9

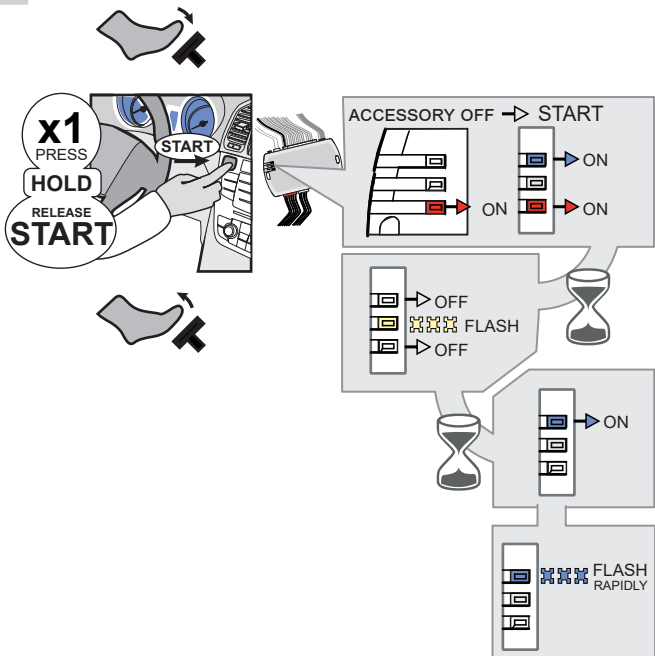

Press the foot-brake pedal.

Press the Push-to-Start button until the engine start.

Release the foot-brake pedal.

- ↳ The BLUE LED will turn ON.
- ↳ The BLUE LED will turn OFF. The RED LED will turn OFF.
- ↳ The YELLOW LED will flash rapidly
- ↳ The BLUE LED will turn ON.
- ↳ The BLUE LED will flash rapidly

10

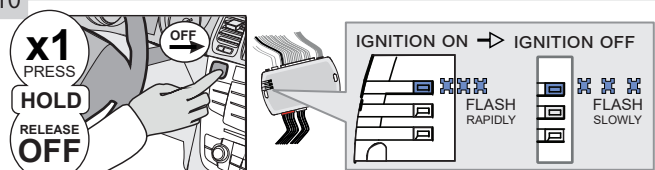

Press the Push-to-Start button until the engine turn OFF.

- ↳ The BLUE LED will flash slowly

11

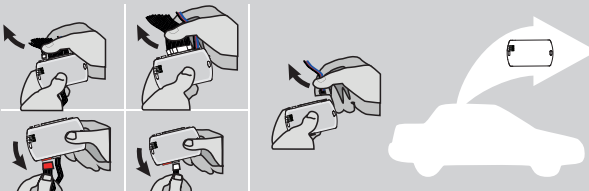

Disconnect all the connectors and after the Data-Link (4-pins) connector.

12

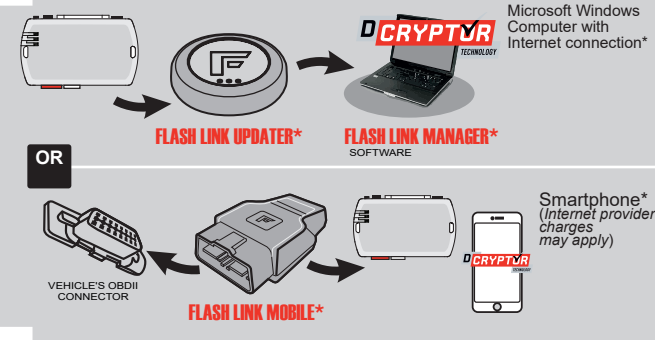

Microsoft Windows Computer with Internet connection*

FLASH LINK UPDATER* FLASH LINK MANAGER* SOFTWARE

OR

FLASH LINK MOBILE* Smartphone* (Internet provider charges may apply)

VEHICLE'S OBDII CONNECTOR

Use the tool: FLASH LINK UPDATER or FLASH LINK MOBILE to visit the DCRYPTOR menu.

*Parts required (not included)

13

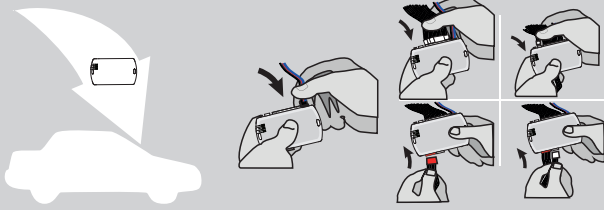

AFTER DCRYPTOR PROGRAMMING COMPLETED
Go back to the vehicle and **reconnect** the 4-Pin (Data-Link) connector and after, all the remaining connector.



The module is now programmed.



REMOTE STARTER / ALARM VERIFICATION PROCEDURE

Test the remote starter. Remote start the vehicle.

REMOTE STARTER FUNCTIONALITY |



All doors must be closed.



Remote start the vehicle.



Unlock the doors with either:

- The OEM remote
- The remote-starter remote
- Or the proximity remote



Enter the vehicle with the Intelligent Key.



The vehicle can now be put in to gear and driven.

If the vehicle is not unlocked with one of these conditions the remote-starter will shut down as soon as any door is opened.





REGULAR INSTALLATION AND THAR-GM6 INSTALLATION

ADDENDUM - SUGGESTED WIRING CONFIGURATION

VEHICLE		YEARS	Vehicle functions supported in this diagram (functional if equipped)													
			Immobilizer bypass	Lock	Unlock	Arm	Disarm	Parking Light	Trunk (open)	RAP Disable	Tachometer	Door Status	Trunk Status	Hand-Brake Status	Foot-Brake Status	OEM Remote Monitoring
BUICK																
Regal	Push-To-Start	2011-2017	•	•	•	•	•	•	•	•	•	•	•	•	•	•

	FIRMWARE VERSION	To add the firmware version and the options, use the FLASH LINK UPDATER or FLASH LINK MOBILE tool, sold separately.
	70.[41] GM MINIMUM	

	IF THE VEHICLE IS NOT EQUIPPED WITH FUNCTIONAL HOOD PIN:	A11	<input type="checkbox"/> OFF	Hood trigger (Output Status).
---	---	------------	------------------------------	-------------------------------

	Program bypass option:	UNIT OPTION	DESCRIPTION
		C1	OEM Remote status (Lock/Unlock) monitoring
		D6	Push-to-Start

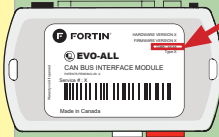
	ATTENTION!		DATE: XX-XX	E5	<input type="checkbox"/> OFF	SPECIAL FUNCTIONS: BY DEFAULT DEACTIVATED
					<input type="checkbox"/> ON	MANUFACTURED MODULES BETWEEN: 04/2018 TO 04/2019

NOTES

**Manuelle Transmission. Remote starter with compatible Data-Link required

MANDATORY INSTALL	*HOOD PIN 	HOOD STATUS: THE HOOD PIN SWITCH MUST BE INSTALLED IF THE VEHICLE CAN BE REMOTE STARTED WITH THE HOOD OPEN, SET FUNCTION A11 TO OFF.	A11	<input type="checkbox"/> OFF	Notice: the installation of safety elements are mandatory. The hood pin is an essential security element and must be installed.	THIS MODULE MUST BE INSTALLED BY A QUALIFIED TECHNICIAN. A WRONG CONNECTION CAN CAUSE PERMANENT DAMAGE TO THE VEHICLE.
--------------------------	--	--	------------	------------------------------	---	--

DESCRIPTION

Parts required (Not included) PAGE

WIRE TO WIRE DIAGRAM

AUTOMATIC TRANSMISSION	1X 1Amp Diode 1X 5 Amp Fuse 1X 1k Ohm Resistor	Page 3
MANUAL TRANSMISSION	1X 1Amp Diode 1X 5 Amp Fuse 1X 1k Ohm Resistor 1X 180 Ohm Resistor	Page 4

THARNESS DIAGRAM

THARNESS THAR-GM6	AUTOMATIC TRANSMISSION	1x THAR-GM6	Page 5
THARNESS THAR-GM6	MANUAL TRANSMISSION	1x THAR-GM6 1X 180 Ohm Resistor	Page 6

BCM

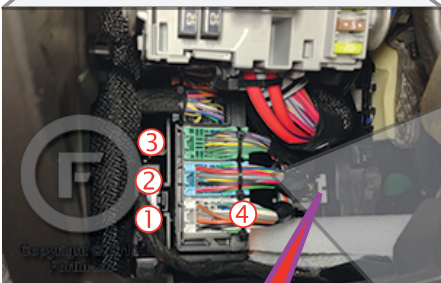
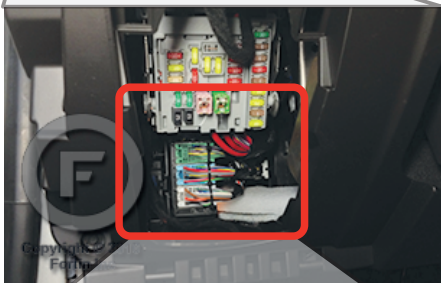

Regal

(-) CLUTCH BYPASS
MANUAL
TRANSMISSION

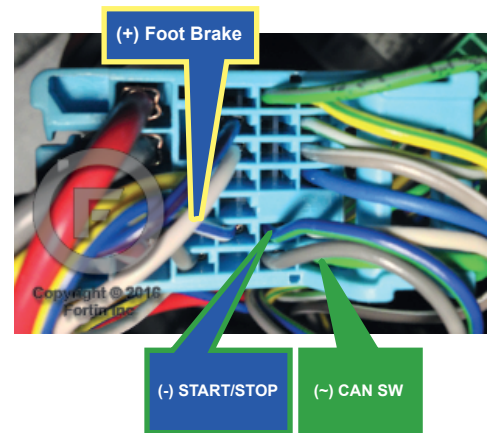
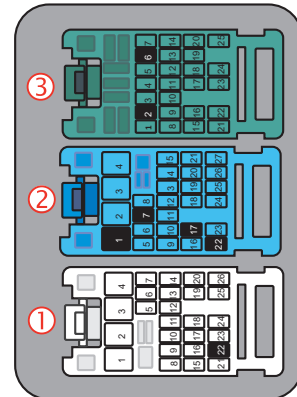
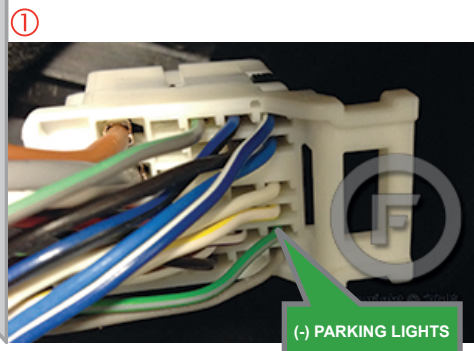
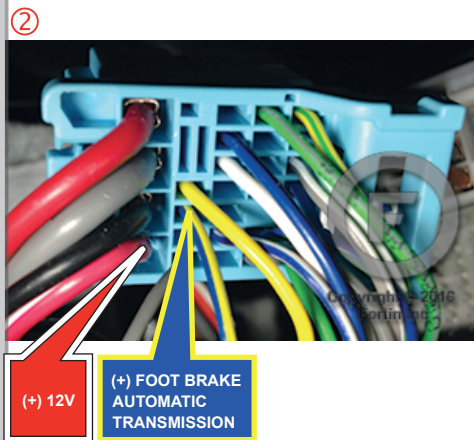
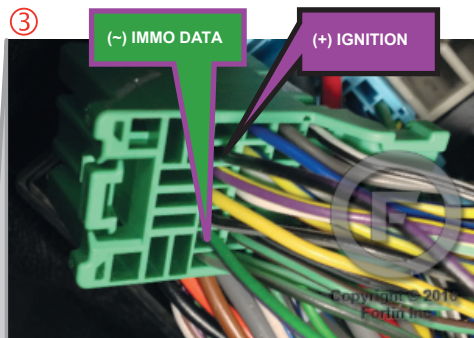

AUTOMATIC TRANSMISSION WIRING CONNECTION

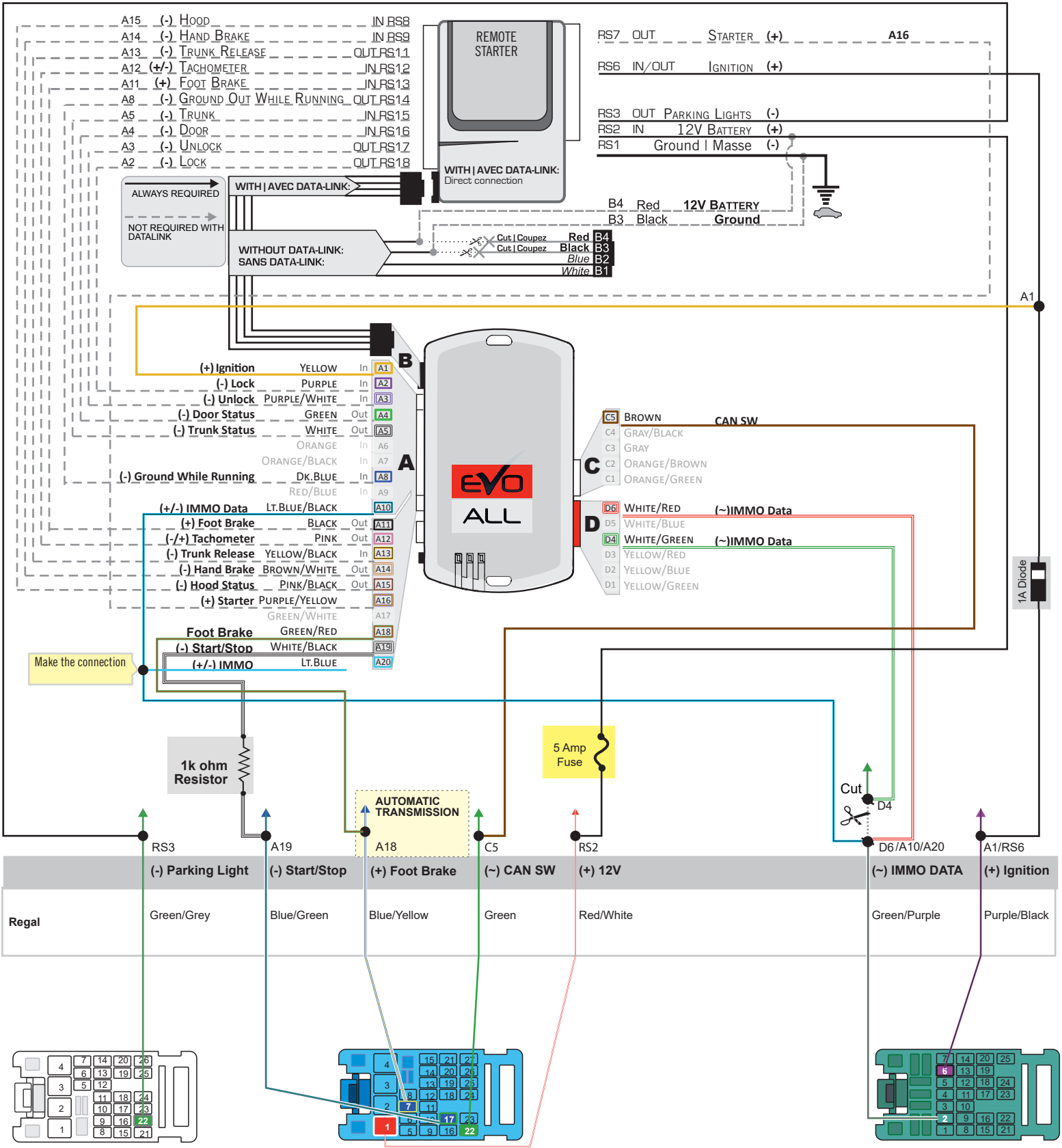

① Back view, 26-Pin White connector, at BCM.

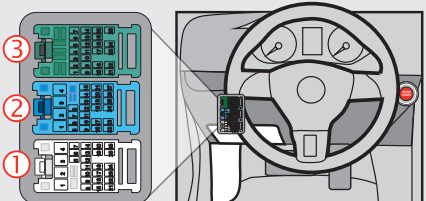

② Back view, 27-Pin Blue connector, at BCM.

③ Back view, 25-Pin Green connector, at BCM.

MANUAL TRANSMISSION WIRING CONNECTION

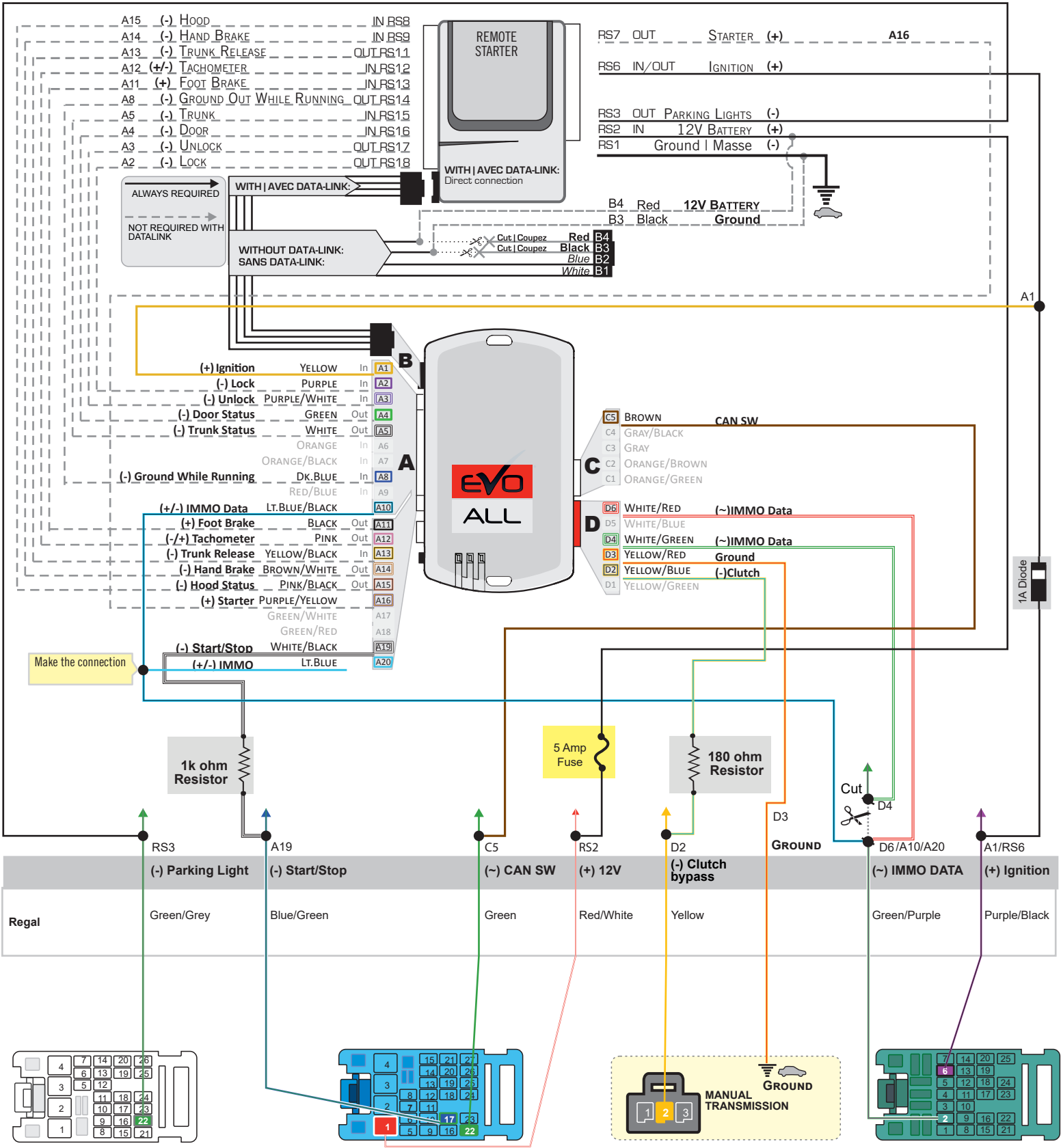

① Back view, 26-Pin White connector, at BCM.

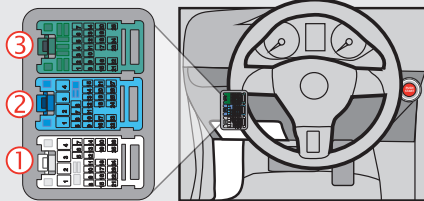

② Back view, 27-Pin Blue connector, at BCM.

④ Back view, 3-Pin Black connector, at Switch.

③ Back view, 25-Pin Green connector, at BCM.

THAR-GM6 | AUTOMATIC TRANSMISSION CONNECTION

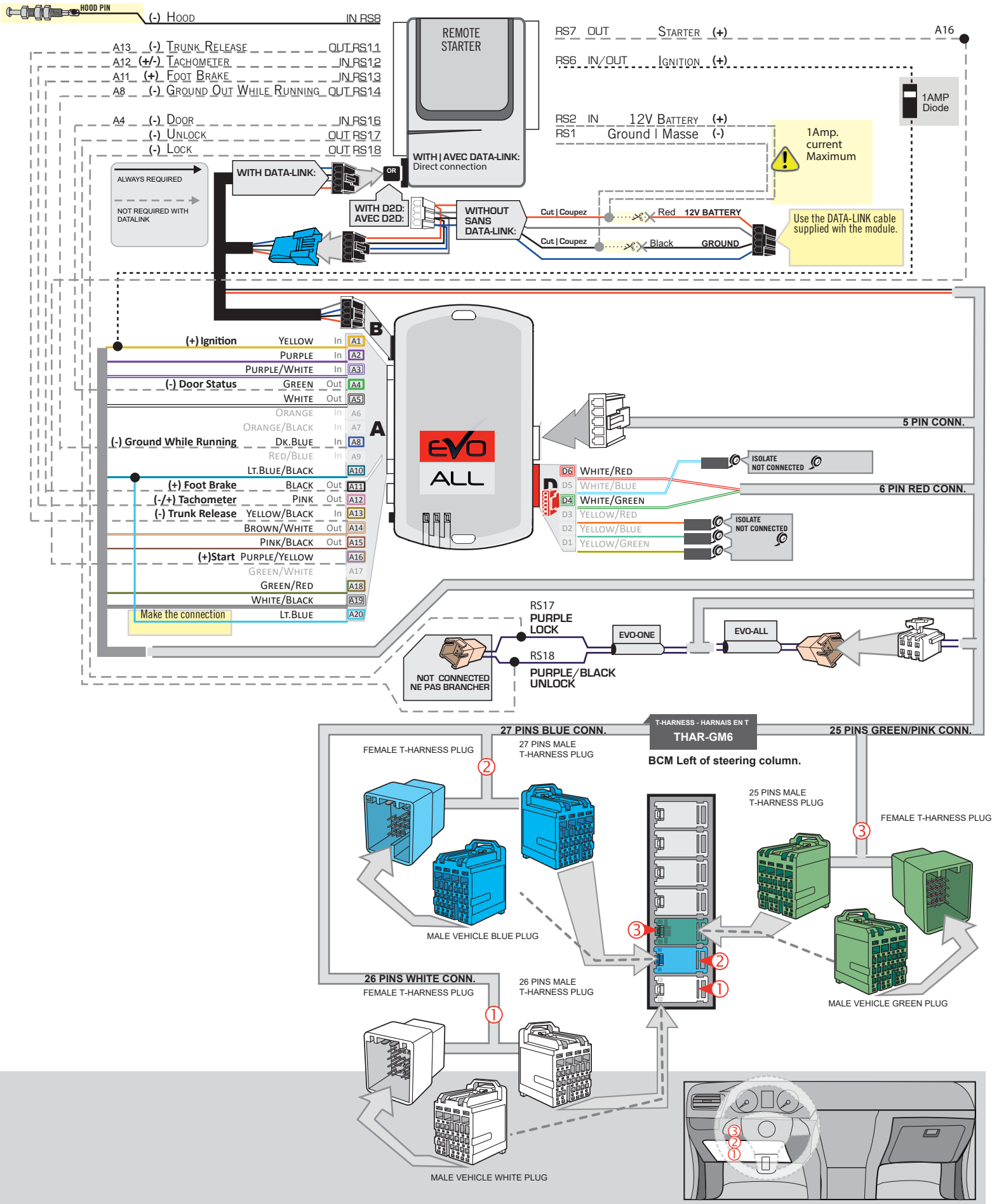

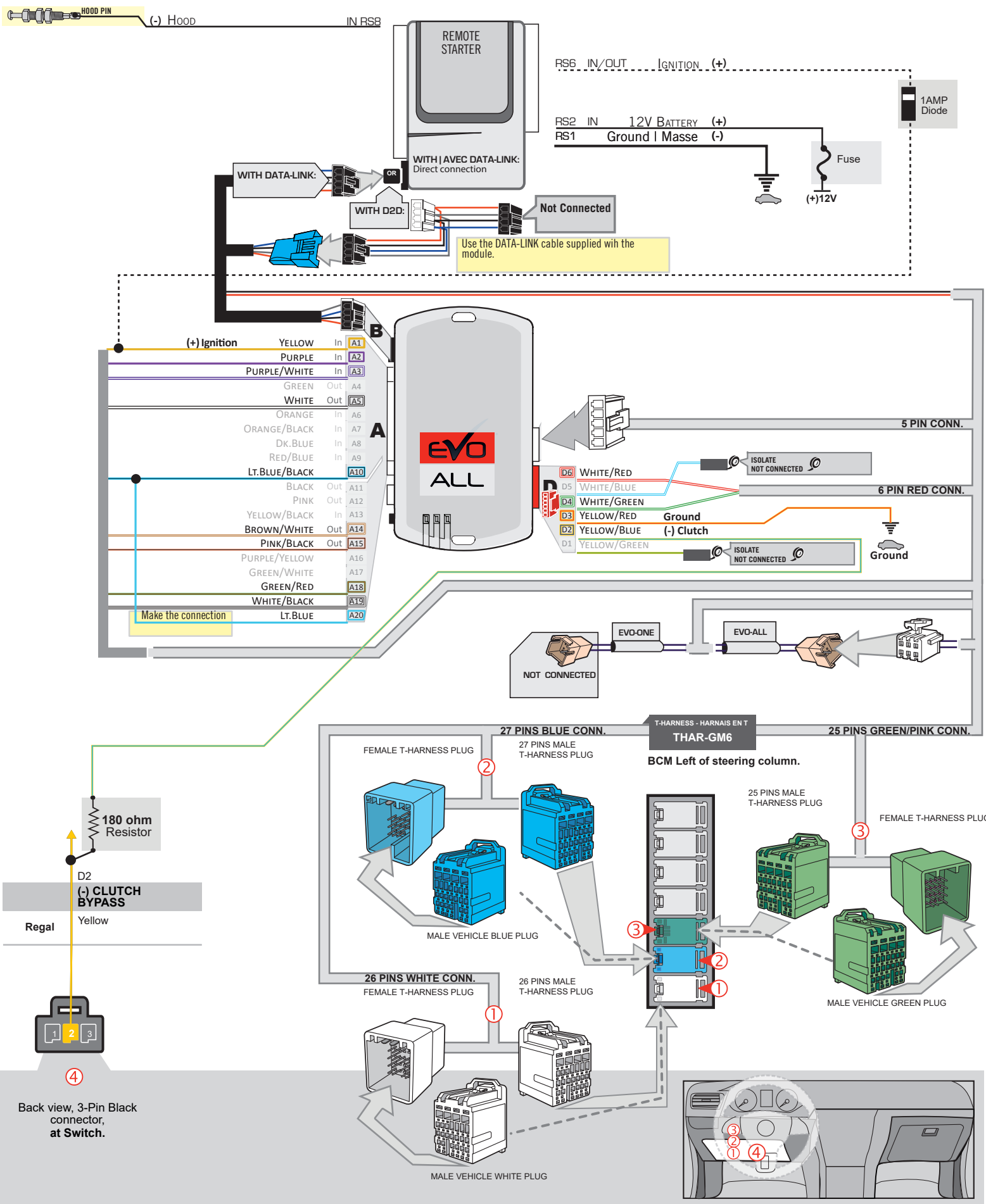

KEY BYPASS PROGRAMMING PROCEDURE 1/3



- 1** Remove the battery from the OEM remote
- 2** Place the OEM remote in the **back** cup holder in the center console.
Refer to vehicle user guide for keyport location.

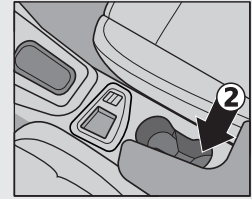

1

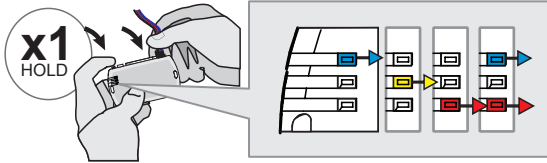

Press and hold the programming button:
Connect the 4-PIN Data-link harness (Black connector).

↳The Blue, Red, Yellow and Blue & Red LEDs will alternatively illuminate.

2

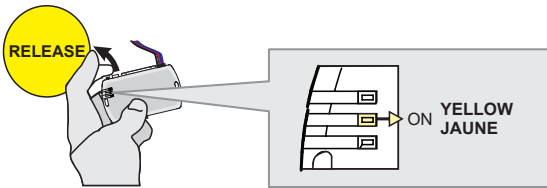

Release the programming button when the LED is **YELLOW**.

If the LED is not solid YELLOW disconnect the 4-Pin connector (Data-Link) and go back to step 1.

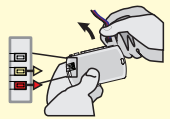

3

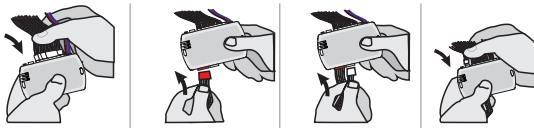

Insert the required remaining connectors.

4

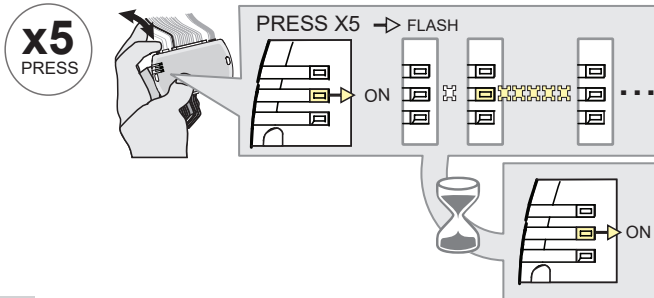

Press and release the programming button five (5x) times.

↳The **YELLOW LED** will flash 5 times each second.

↳**WAIT** for the **YELLOW LED** to turn ON solide.

5

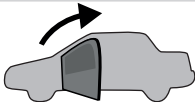

Open the driver door.

6

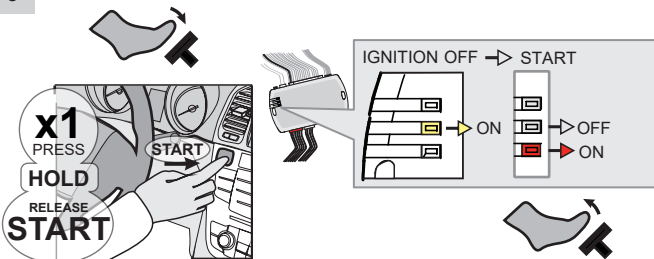

Press the foot-brake pedal.

Press the Push-to-Start button until the engine start.

Release the foot-brake pedal.

↳The **RED LED** will turn ON.
↳The **YELLOW LED** will turn OFF.

KEY BYPASS PROGRAMMING PROCEDURE 2/3

7



Press the Push-to-Start button until the engine turn OFF.

8

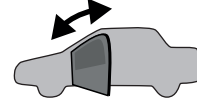

Close and open the driver door.

9

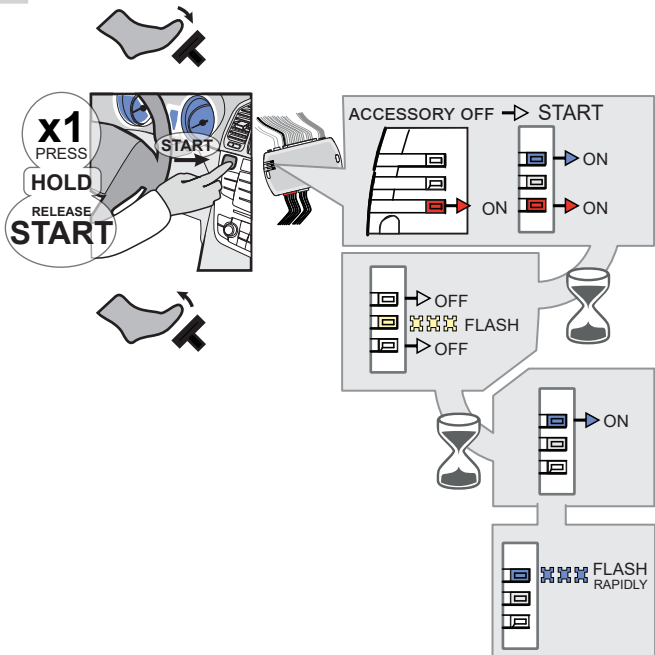

Press the foot-brake pedal.

Press the Push-to-Start button until the engine start.

Release the foot-brake pedal.

- ↳ The BLUE LED will turn ON.
- ↳ The BLUE LED will turn OFF. The RED LED will turn OFF.
- ↳ The YELLOW LED will flash rapidly
- ↳ The BLUE LED will turn ON.
- ↳ The BLUE LED will flash rapidly

10

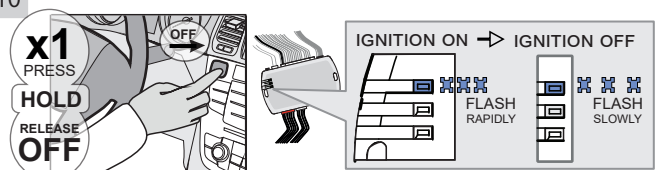

Press the Push-to-Start button until the engine turn OFF.

- ↳ The BLUE LED will flash slowly

11

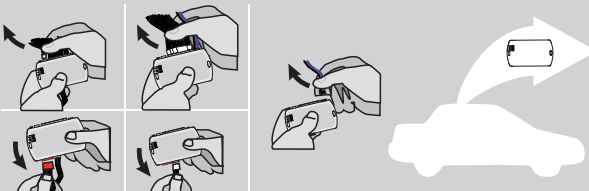

Disconnect all the connectors and after the Data-Link (4-pins) connector.

12

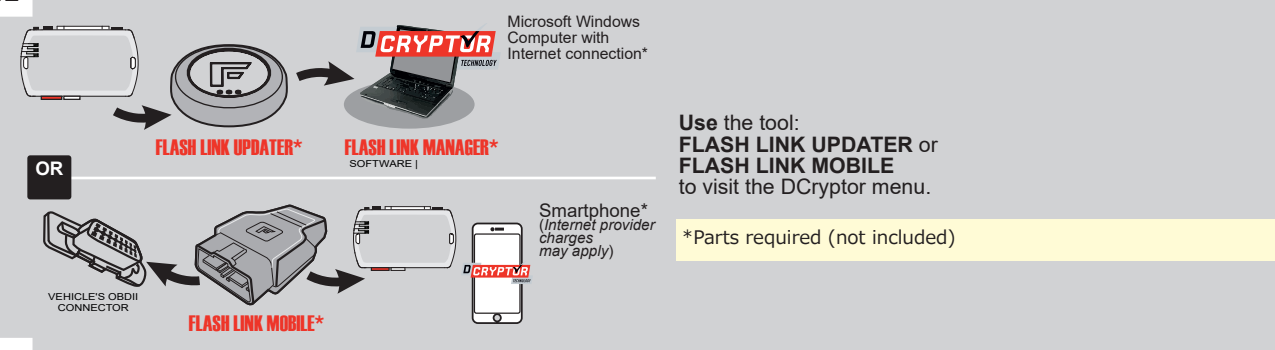

Use the tool: FLASH LINK UPDATER or FLASH LINK MOBILE to visit the DCryptor menu.

***Parts required (not included)**

KEY BYPASS PROGRAMMING PROCEDURE 3/3

13

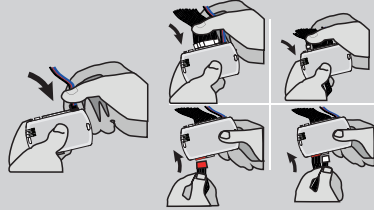
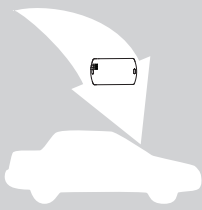

AFTER DCRYPTOR PROGRAMMING COMPLETED
Go back to the vehicle and **reconnect** the 4-Pin (Data-Link) connector and after, all the remaining connector.



The module is now programmed.



REMOTE STARTER / ALARM VERIFICATION PROCEDURE

Test the remote starter. Remote start the vehicle.

REMOTE STARTER FUNCTIONALITY



All doors must be closed.



Remote start the vehicle.



Unlock the doors with either:

- The OEM remote
- The remote-starter remote
- Or the proximity remote



Enter the vehicle with the Intelligent Key.



The vehicle can now be put in to gear and driven.

proximité.

If the vehicle is not unlocked with one of these conditions the remote-starter will shut down as soon as any door is opened.



REGULAR INSTALLATION AND THAR-GM6 INSTALLATION

ADDENDUM - SUGGESTED WIRING CONFIGURATION

VEHICLE	YEARS	Vehicle functions supported in this diagram (functional if equipped)																	
		Immobilizer bypass	Lock	Unlock	Arm	Disarm	Parking Light	Trunk (open)	RAP Disable	Tachometer	Door Status	Trunk Status	Hand-Brake Status	Foot-Brake Status	OEM Remote Monitoring				
																			
BUICK																			
Regal	Push-To-Start	2018-2019	•	•	•	•	•	•	•	•	•	•	•	•	•	•	•	•	•





FIRMWARE VERSION

70.[41]

GM MINIMUM

To add the firmware version and the options, use the **FLASH LINK UPDATER** or **FLASH LINK MOBILE** tool, sold separately.

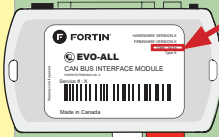
IF THE VEHICLE IS NOT EQUIPPED WITH FUNCTIONAL HOOD PIN:		A11	OFF	Hood trigger (Output Status).
	Program bypass option:	UNIT OPTION		DESCRIPTION
		C1		OEM Remote status (Lock/Unlock) monitoring
		D6		Push-to-Start
	ATTENTION!		E5	<div style="text-align: center;"> <p>OFF</p> <p>SPECIAL FUNCTIONS: BY DEFAULT DEACTIVATED</p> <p>ON</p> <p>MANUFACTURED MODULES</p> </div>

NOTES

****Manuelle Transmission.** Remote starter with compatible Data-Link required

MANDATORY INSTALL

***HOOD PIN**

HOOD STATUS: THE HOOD PIN SWITCH MUST BE INSTALLED IF THE VEHICLE CAN BE REMOTE STARTED WITH THE HOOD OPEN, SET FUNCTION **A11** TO OFF.

Notice: the installation of safety elements are mandatory. The hood pin is an essential security element and must be installed.

THIS MODULE MUST BE INSTALLED BY A QUALIFIED TECHNICIAN. A WRONG CONNECTION CAN CAUSE PERMANENT DAMAGE TO THE VEHICLE.

A11

OFF

DESCRIPTION

Parts required (Not included)		PAGE
-------------------------------	--	------

WIRE TO WIRE DIAGRAM

AUTOMATIC TRANSMISSION	1X 1Amp Diode 1X 5 Amp Fuse 1X 1k Ohm Resistor	Page 3
MANUAL TRANSMISSION	1X 1Amp Diode 1X 5 Amp Fuse 1X 1k Ohm Resistor 1X 180 Ohm Resistor	Page 4

THARNESS DIAGRAM

THARNESS THAR-GM6	AUTOMATIC TRANSMISSION	1x THAR-GM6	Page 5
THARNESS THAR-GM6	MANUAL TRANSMISSION	1x THAR-GM6 1X 180 Ohm Resistor	Page 6

Regal
2018-2019

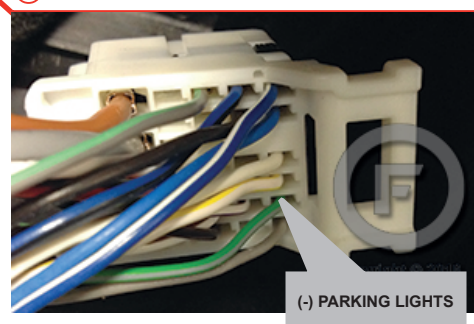
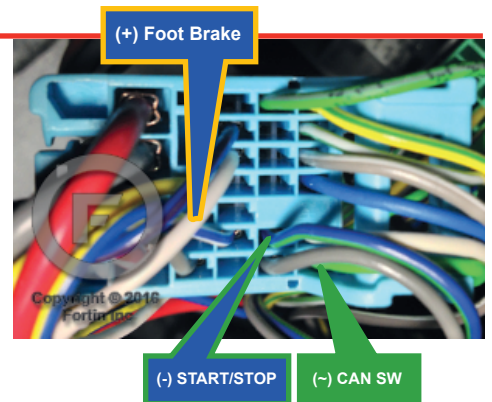
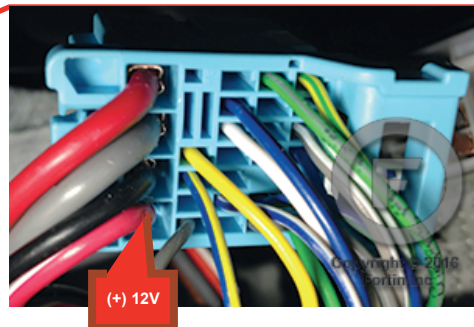
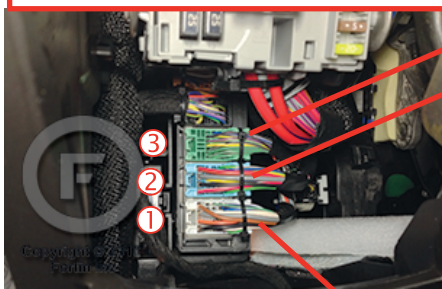
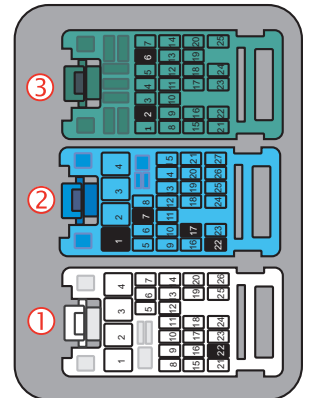
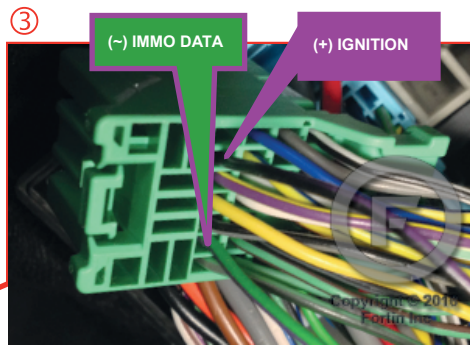

AUTOMATIC TRANSMISSION WIRING CONNECTION

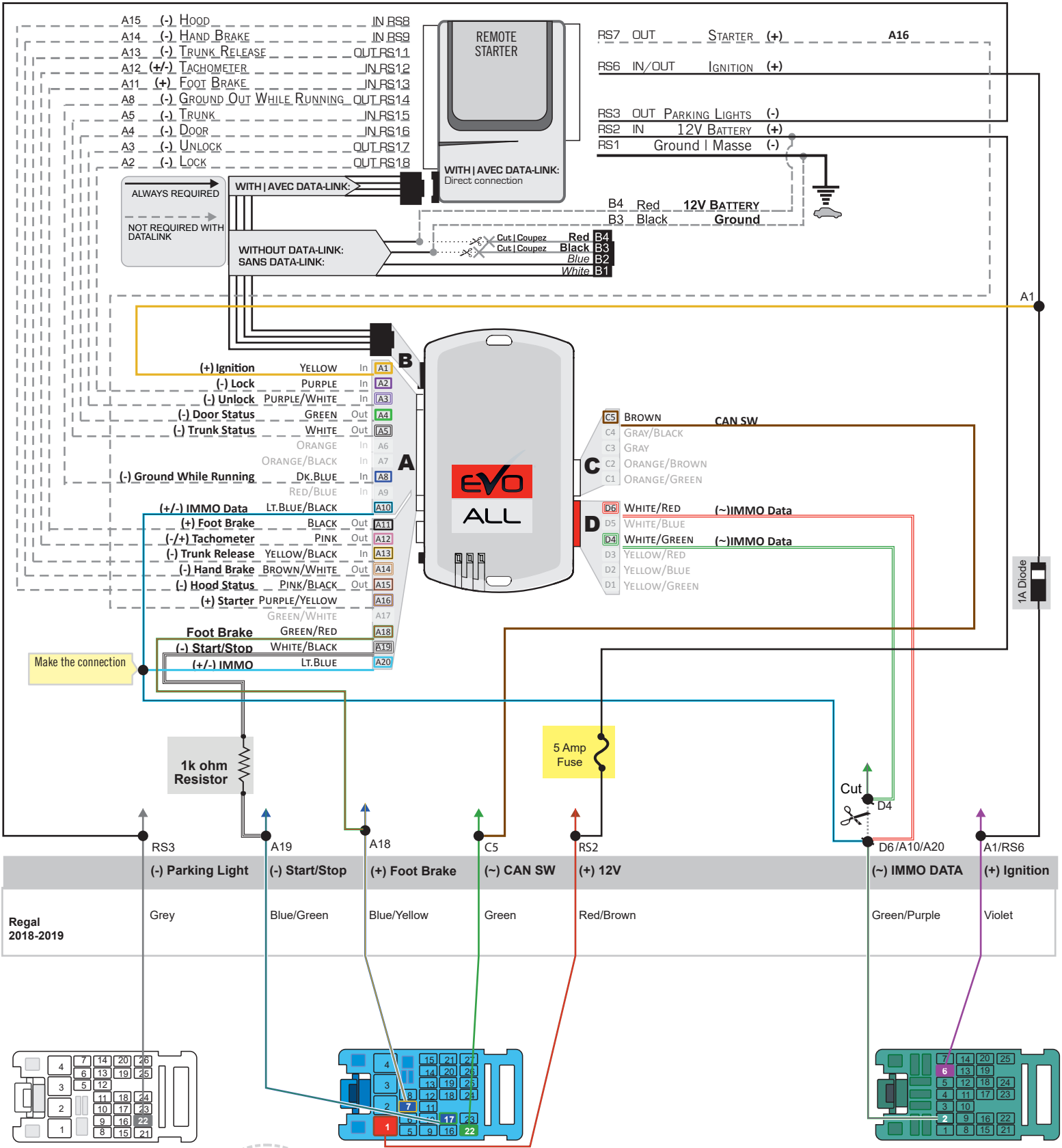

① Back view, 26-Pin White connector, at BCM.

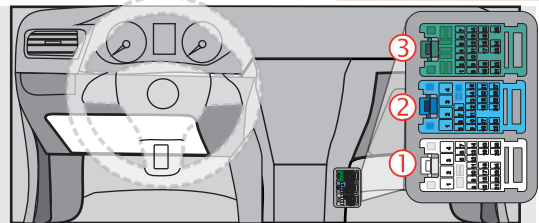

② Back view, 27-Pin Blue connector, at BCM.

③ Back view, 25-Pin Green connector, at BCM.

MANUAL TRANSMISSION WIRING CONNECTION

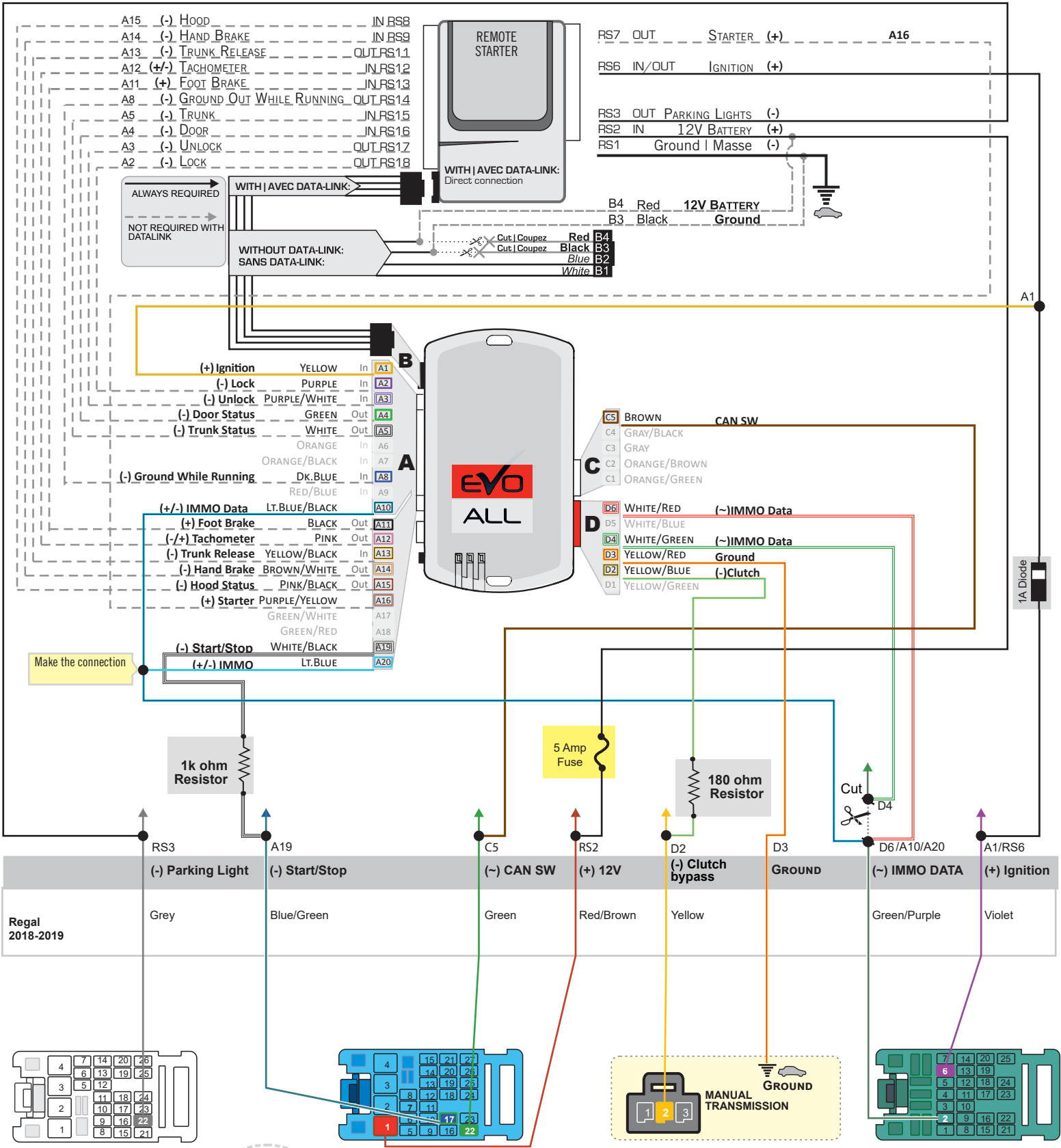

① Back view, 26-Pin White connector, at BCM.

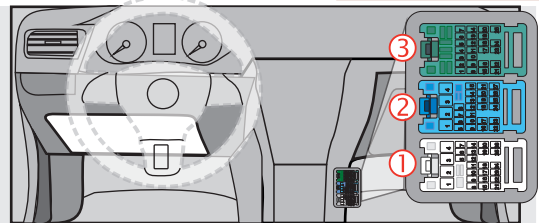

② Back view, 27-Pin Blue connector, at BCM.

④ Back view, 3-Pin Black connector, at Switch.

③ Back view, 25-Pin Green connector, at BCM.

THAR-GM6 | AUTOMATIC TRANSMISSION CONNECTION

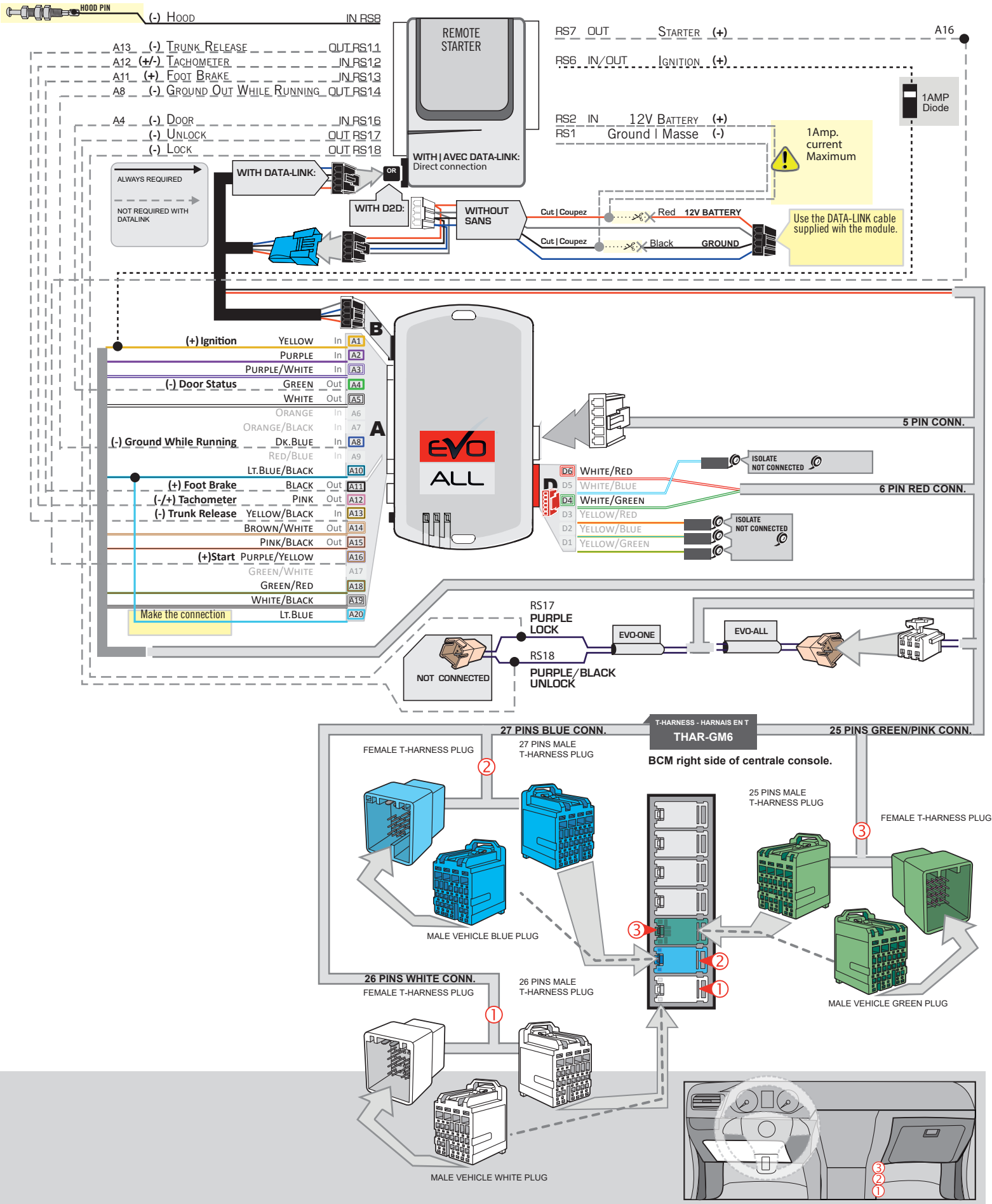

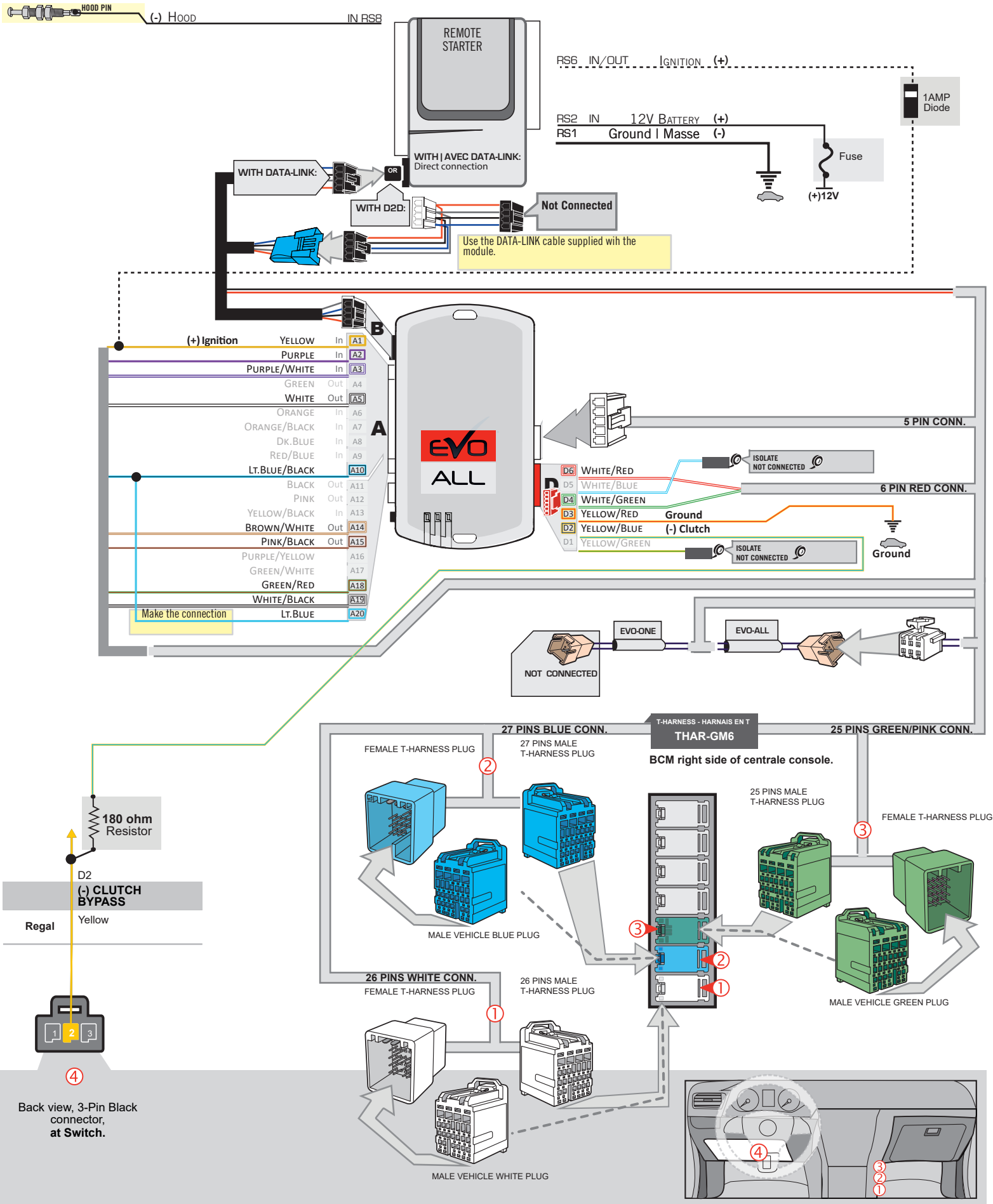

KEY BYPASS PROGRAMMING PROCEDURE 1/3



- 1** Remove the battery from the OEM remote
- 2** Place the OEM remote in the **back** cup holder in the center console.
Refer to vehicle user guide for keyport location.

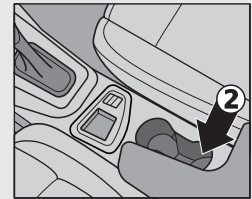

1

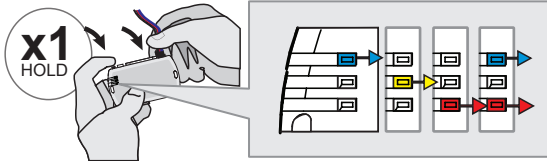

Press and hold the programming button:
Connect the 4-PIN Data-link harness (Black connector).

↳The Blue, Red, Yellow and Blue & Red LEDs will alternatively illuminate.

2

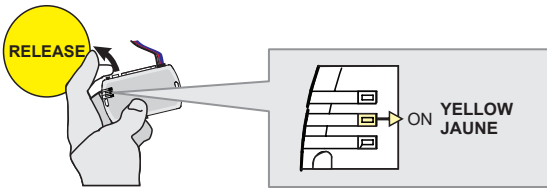

Release the programming button when the LED is **YELLOW**.

If the LED is not solid YELLOW disconnect the 4-Pin connector (Data-Link) and go back to step 1.

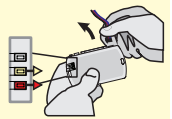

3

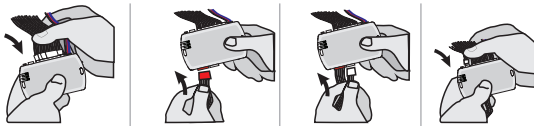

Insert the required remaining connectors.

4

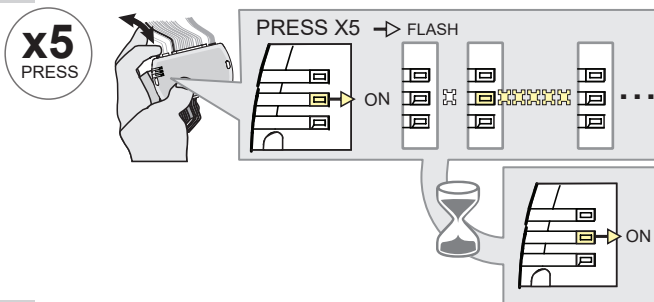

Press and release the programming button five (5x) times.

↳The **YELLOW LED** will flash 5 times each second.

↳**WAIT** for the **YELLOW LED** to turn **ON** solide.

5

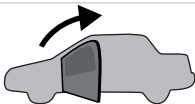

Open the driver door.

6

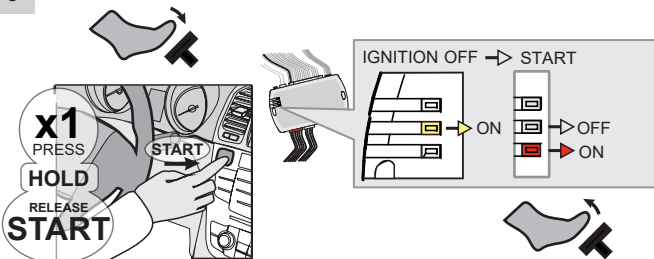

Press the foot-brake pedal.

Press the Push-to-Start button until the engine start.

Release the foot-brake pedal.

↳The **RED LED** will turn **ON**.
↳The **YELLOW LED** will turn **OFF**.

KEY BYPASS PROGRAMMING PROCEDURE 2/3

7



Press the Push-to-Start button until the engine turn OFF.

8

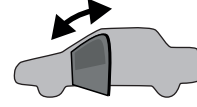

Close and open the driver door.

9

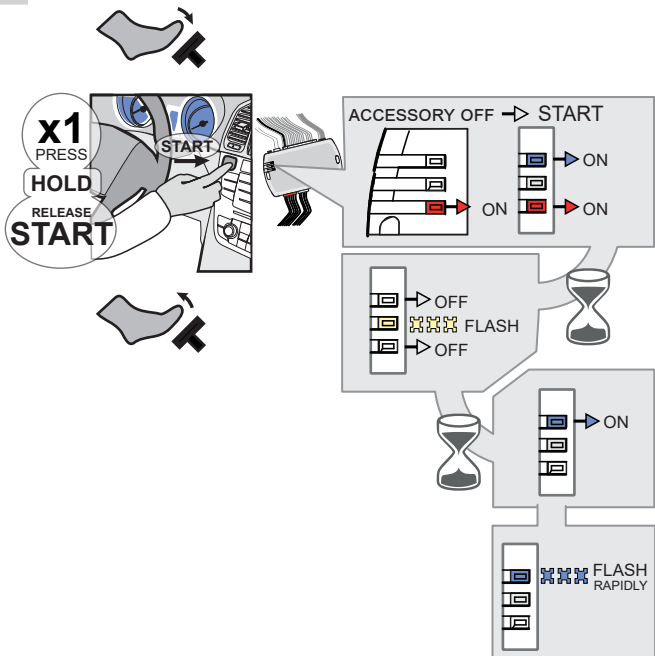

Press the foot-brake pedal.

Press the Push-to-Start button until the engine start.

Release the foot-brake pedal.

- ↳ The BLUE LED will turn ON.
- ↳ The BLUE LED will turn OFF. The RED LED will turn OFF.
- ↳ The YELLOW LED will flash rapidly
- ↳ The BLUE LED will turn ON.
- ↳ The BLUE LED will flash rapidly

10

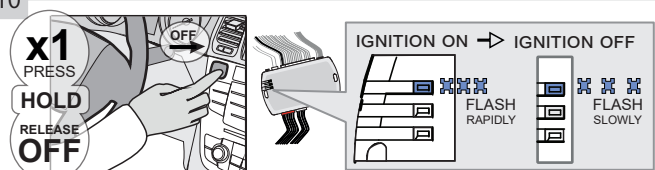

Press the Push-to-Start button until the engine turn OFF.

- ↳ The BLUE LED will flash slowly

11



Disconnect all the connectors and after the Data-Link (4-pins) connector.

12

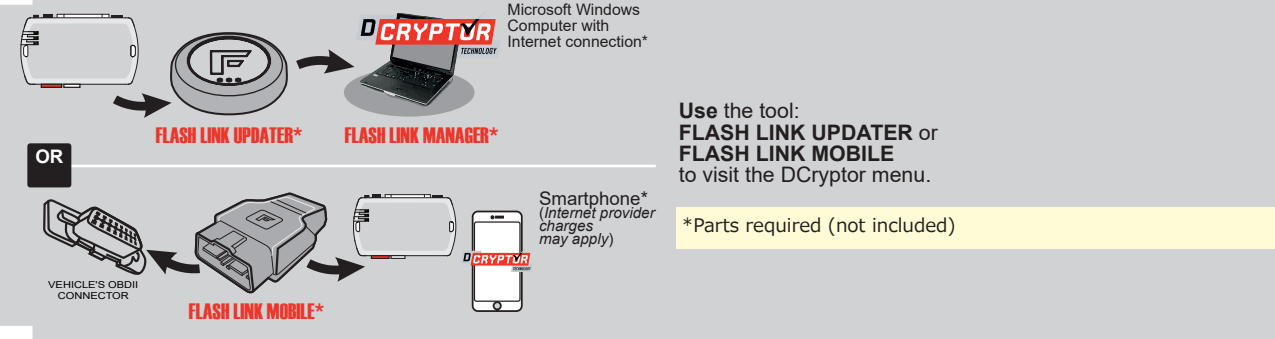

Use the tool: FLASH LINK UPDATER or FLASH LINK MOBILE to visit the DCRYPTOR menu.

***Parts required (not included)**

KEY BYPASS PROGRAMMING PROCEDURE 3/3

13

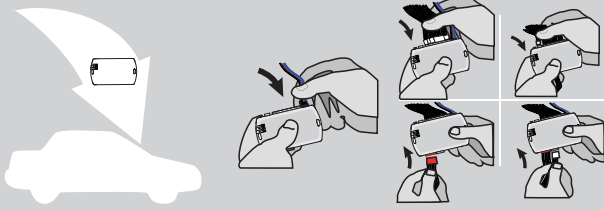

AFTER DCRYPTOR PROGRAMMING COMPLETED
Go back to the vehicle and **reconnect** the 4-Pin (Data-Link) connector and after, all the remaining connector.



The module is now programmed.



REMOTE STARTER / ALARM VERIFICATION PROCEDURE

Test the remote starter. Remote start the vehicle.

REMOTE STARTER FUNCTIONALITY



All doors must be closed.



Remote start the vehicle.



Unlock the doors with either:

- The OEM remote
- The remote-starter remote
- Or the proximity remote

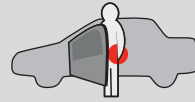

Enter the vehicle with the Intelligent Key.



The vehicle can now be put in to gear and driven.

If the vehicle is not unlocked with one of these conditions the remote-starter will shut down as soon as any door is opened.



REGULAR INSTALLATION AND THAR-GM6 INSTALLATION

ADDENDUM - SUGGESTED WIRING CONFIGURATION

VEHICLE	YEARS	Vehicle functions supported in this diagram (functional if equipped)																
		Immobilizer bypass	Lock	Unlock	Arm	Disarm	Parking Light	Trunk (open)	RAP Disable	Tachometer	Door Status	Trunk Status	Hand-Brake Status	Foot-Brake Status	OEM Remote Monitoring			
																		
CADILLAC																		
SRX	Push-To-Start	2010-2012	•	•	•	•	•	•	•	•	•	•	•	•	•	•	•	•



FIRMWARE VERSION

70.[41]

GM MINIMUM

To add the firmware version and the options, use the **FLASH LINK UPDATER** or **FLASH LINK MOBILE** tool, sold separately.

IF THE VEHICLE IS NOT EQUIPPED WITH FUNCTIONAL HOOD PIN:	A11	OFF	Hood trigger (Output Status).
---	------------	-----	-------------------------------

	UNIT OPTION	DESCRIPTION
 <p>Program bypass option:</p>	C1	OEM Remote status (Lock/Unlock) monitoring
	D6	Push-to-Start

	<p>ATTENTION!</p>	 <p>DATE: XX-XX</p>	E5	OFF	<p>SPECIAL FUNCTIONS: BY DEFAULT DEACTIVATED</p>
				ON	<p>MANUFACTURED MODULES BETWEEN: 04/2018 TO 04/2019</p>

MANDATORY INSTALL

*HOOD PIN



HOOD STATUS: THE HOOD PIN SWITCH MUST BE INSTALLED IF THE VEHICLE CAN BE REMOTE STARTED WITH THE HOOD OPEN, SET FUNCTION **A11** TO OFF.

A11

OFF

Notice: the installation of safety elements are mandatory. The hood pin is an essential security element and must be installed.

THIS MODULE MUST BE INSTALLED BY A QUALIFIED TECHNICIAN. A WRONG CONNECTION CAN CAUSE PERMANENT DAMAGE TO THE VEHICLE.

DESCRIPTION

Parts required (Not included) PAGE

WIRE TO WIRE DIAGRAM

<p>1X 1Amp Diode 1X 5 Amp Fuse 1X 1k Ohm Resistor</p>	<p>Page 3</p>
---	---------------

THARNESS DIAGRAM

<p>THARNESS THAR-GM6</p>	<p>1x THAR-GM6</p>	<p>Page 4</p>
--------------------------	--------------------	---------------

BCM

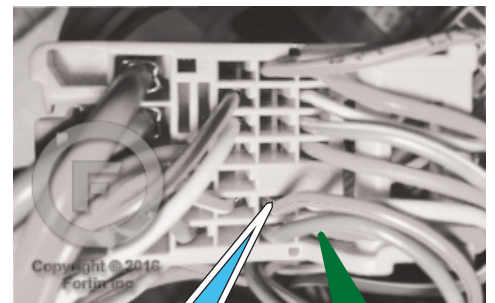
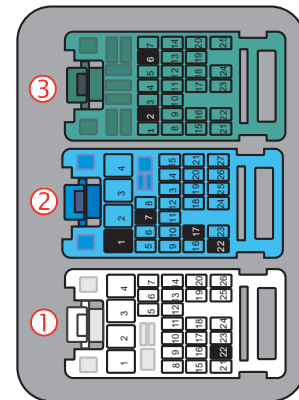
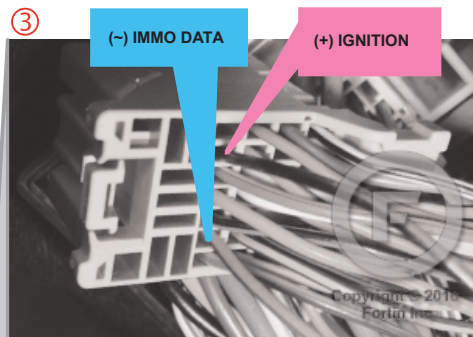
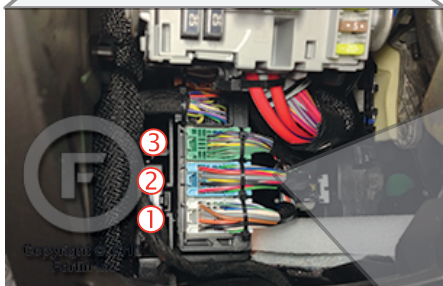
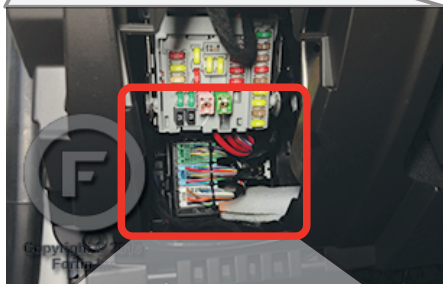

AUTOMATIC TRANSMISSION WIRING CONNECTION

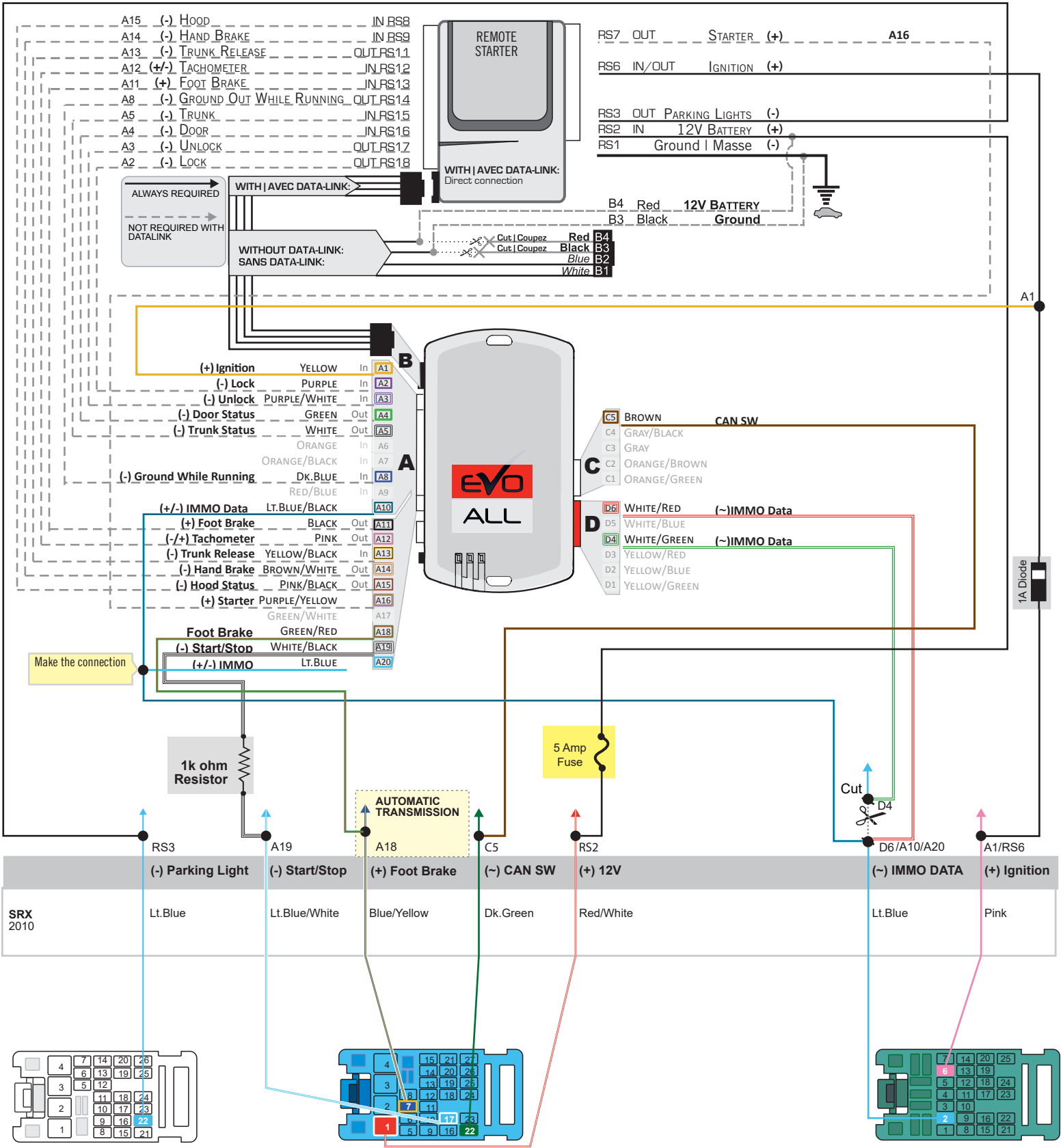

① Back view, 26-Pin White connector, at BCM.

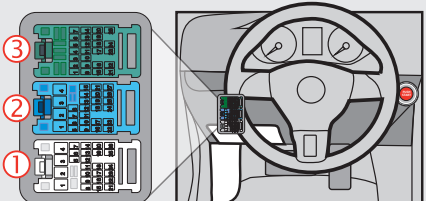

② Back view, 27-Pin Blue connector, at BCM.

③ Back view, 25-Pin Green connector, at BCM.

THAR-GM6 | WIRING CONNECTION

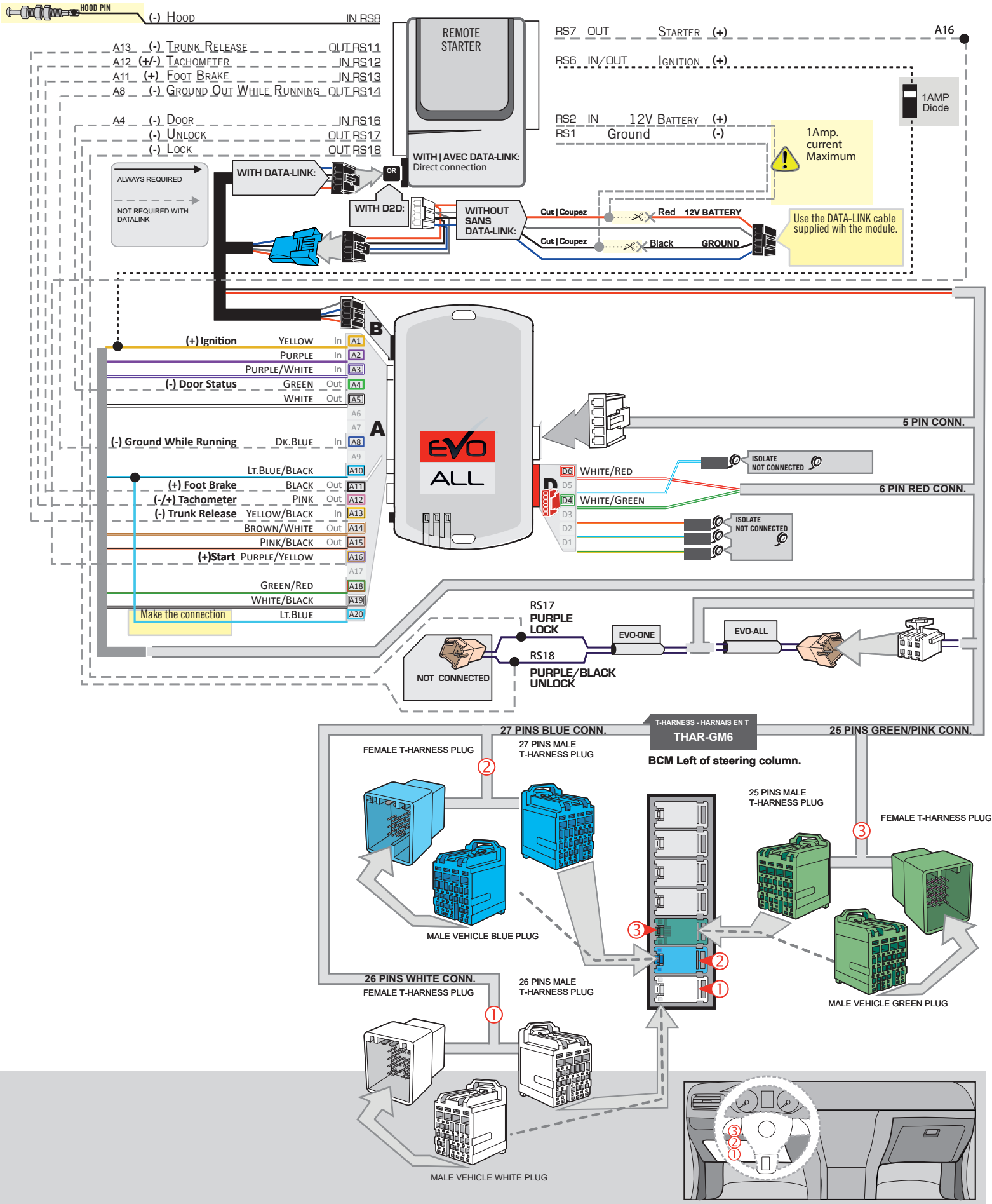

KEY BYPASS PROGRAMMING PROCEDURE 1/3 |

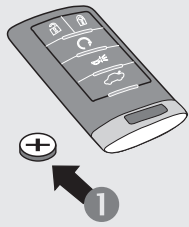

1 Remove the battery from the OEM remote.

2 Place the OEM remote into the transmitter pocket of the center console.

Refer to vehicle user guide for keyport location.

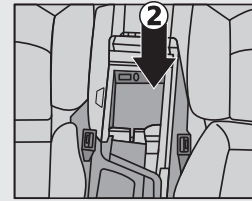

1

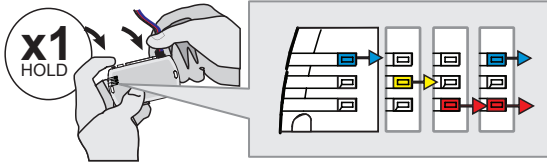

Press and hold the programming button:
Connect the 4-PIN Data-link harness (Black connector).

↳The Blue, Red, Yellow and Blue & Red LEDs will alternatively illuminate.

2

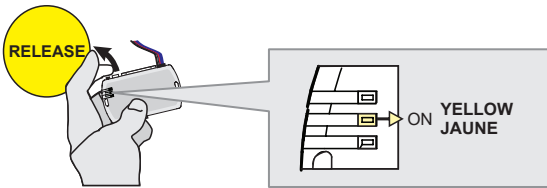

Release the programming button when the LED is YELLOW.

If the LED is not solid YELLOW disconnect the 4-Pin connector (Data-Link) and go back to step 1.

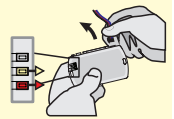

3

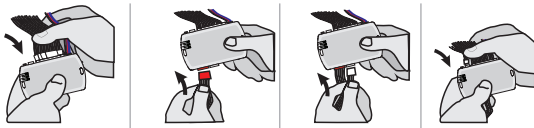

Insert the required remaining connectors.

4

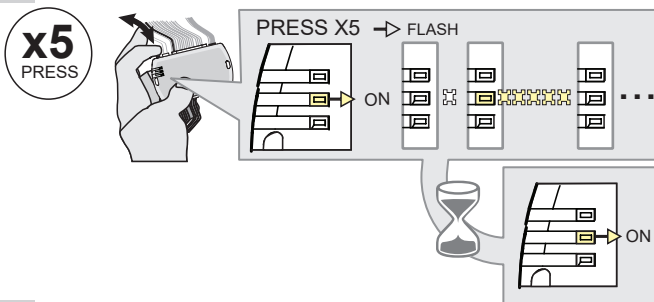

Press and release the programming button five (5x) times.

↳The YELLOW LED will flash 5 times each second.

↳**WAIT** for the YELLOW LED to turn ON solide.

5

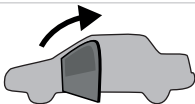

Open the driver door.

6

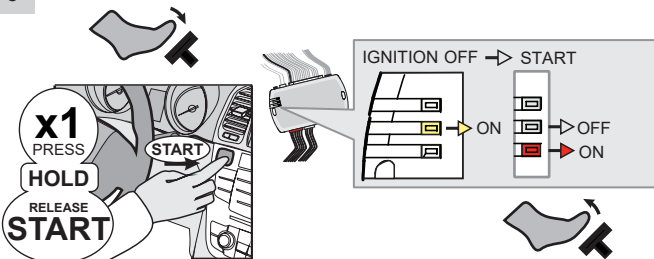

Press the foot-brake pedal.

Press the Push-to-Start button until the engine start.

Release the foot-brake pedal.

↳The RED LED will turn ON.
↳The YELLOW LED will turn OFF.

KEY BYPASS PROGRAMMING PROCEDURE 2/3 |

7



Press the Push-to-Start button until the engine turn OFF.

8

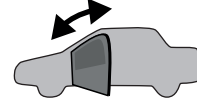

Close and open the driver door.

9

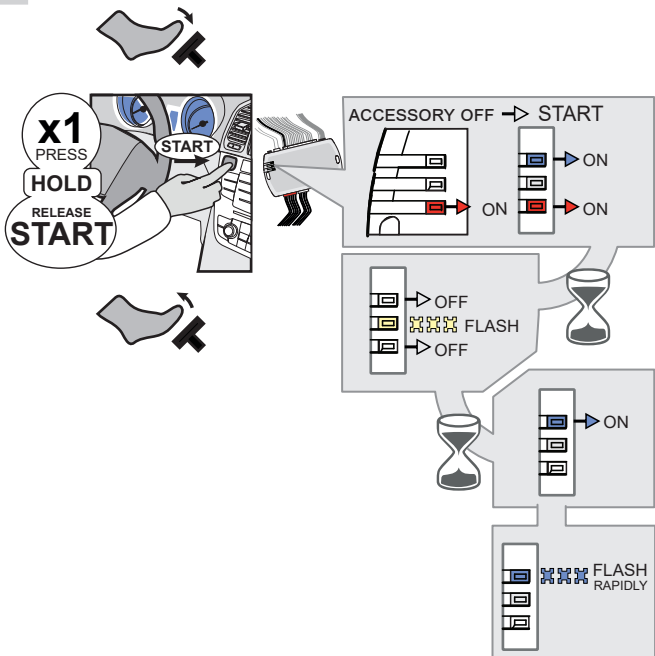

Press the foot-brake pedal.

Press the Push-to-Start button until the engine start.

Release the foot-brake pedal.

- ↳ The BLUE LED will turn ON.
- ↳ The BLUE LED will turn OFF. The RED LED will turn OFF.
- ↳ The YELLOW LED will flash rapidly
- ↳ The BLUE LED will turn ON.
- ↳ The BLUE LED will flash rapidly

10

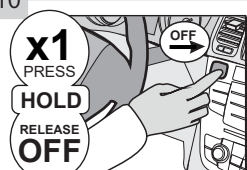

Press the Push-to-Start button until the engine turn OFF.

- ↳ The BLUE LED will flash slowly

11

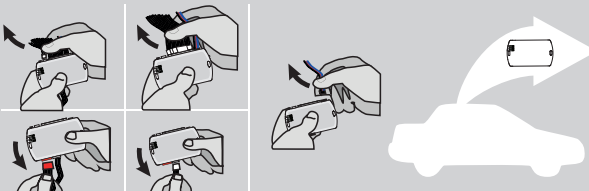

Disconnect all the connectors and after the Data-Link (4-pins) connector.

12

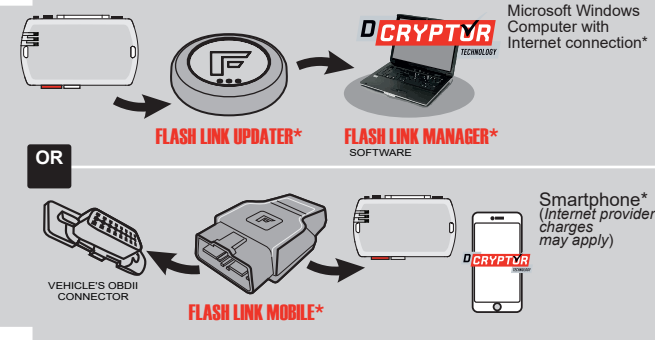

Use the tool: FLASH LINK UPDATER or FLASH LINK MOBILE to visit the DCryptor menu.

Microsoft Windows Computer with Internet connection*

Smartphone* (Internet provider charges may apply)

*Parts required (not included)

13

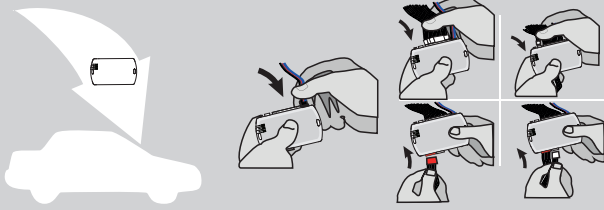

AFTER DCRYPTOR PROGRAMMING COMPLETED
Go back to the vehicle and **reconnect** the 4-Pin (Data-Link) connector and after, all the remaining connector.



The module is now programmed.



REMOTE STARTER / ALARM VERIFICATION PROCEDURE

Test the remote starter. Remote start the vehicle.

REMOTE STARTER FUNCTIONALITY |



All doors must be closed.



Remote start the vehicle.



Unlock the doors with either:

- The OEM remote
- The remote-starter remote
- Or the proximity remote



Enter the vehicle with the Intelligent Key.



The vehicle can now be put in to gear and driven.

If the vehicle is not unlocked with one of these conditions the remote-starter will shut down as soon as any door is opened.



REGULAR INSTALLATION AND THAR-GM6 INSTALLATION

ADDENDUM - SUGGESTED WIRING CONFIGURATION

VEHICLE		YEARS	Vehicle functions supported in this diagram (functional if equipped)													
			Immobilizer bypass	Lock	Unlock	Arm	Disarm	Parking Light	Trunk (open)	RAP Disable	Tachometer	Door Status	Trunk Status	Hand-Brake Status	Foot-Brake Status	OEM Remote Monitoring
	CADILLAC															
SRX	Push-To-Start	2013-2016	•	•	•	•	•	•	•	•	•	•	•	•	•	•



FIRMWARE VERSION



70.[41]

GM MINIMUM

To add the firmware version and the options, use the **FLASH LINK UPDATER** or **FLASH LINK MOBILE** tool, sold separately.

IF THE VEHICLE IS NOT EQUIPPED WITH FUNCTIONAL HOOD PIN:	A11	OFF	Hood trigger (Output Status).
---	------------	------------	-------------------------------

	UNIT OPTION	DESCRIPTION
 <p>Program bypass option:</p>	C1	OEM Remote status (Lock/Unlock) monitoring
	D6	Push-to-Start

	ATTENTION!	 <p>DATE: XX-XX</p>	E5	OFF	SPECIAL FUNCTIONS: BY DEFAULT DEACTIVATED
				ON	MANUFACTURED MODULES BETWEEN: 04/2018 TO 04/2019

MANDATORY INSTALL

*HOOD PIN



HOOD STATUS: THE HOOD PIN SWITCH MUST BE INSTALLED IF THE VEHICLE CAN BE REMOTE STARTED WITH THE HOOD OPEN, SET FUNCTION **A11** TO OFF.

A11

OFF

Notice: the installation of safety elements are mandatory. The hood pin is an essential security element and must be installed.

THIS MODULE MUST BE INSTALLED BY A QUALIFIED TECHNICIAN. A WRONG CONNECTION CAN CAUSE PERMANENT DAMAGE TO THE VEHICLE.

DESCRIPTION

Parts required (Not included) PAGE

WIRE TO WIRE DIAGRAM

	Page 3
--	--------

1X 1Amp Diode
1X 5 Amp Fuse
1X 1k Ohm Resistor

THARNES DIAGRAM

THARNES THAR-GM6	1x THAR-GM6	Page 4
------------------	-------------	--------

BCM

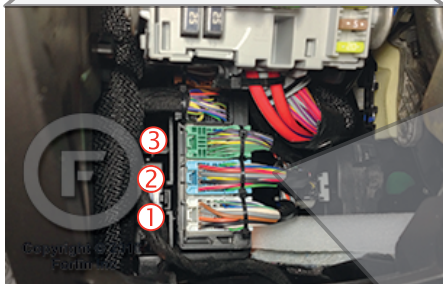
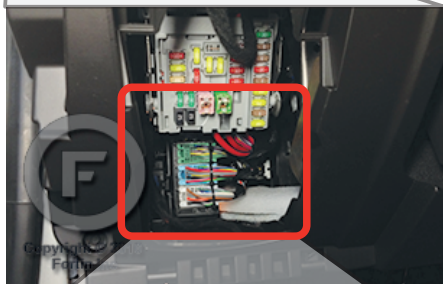

SRX
2013-2016

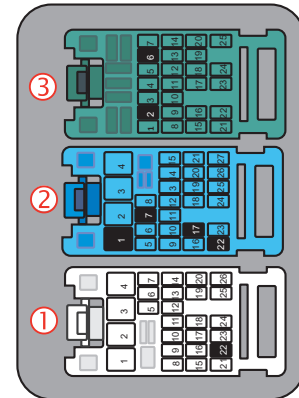
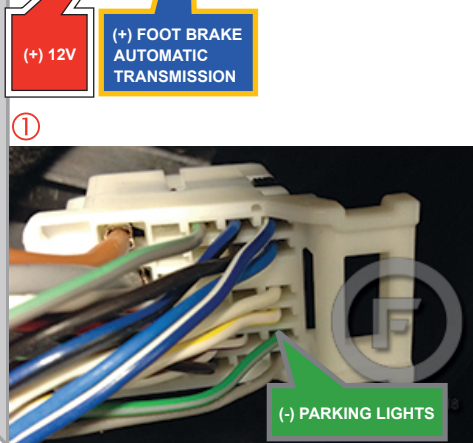
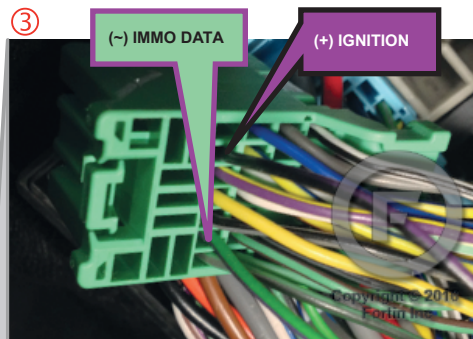

AUTOMATIC TRANSMISSION WIRING CONNECTION

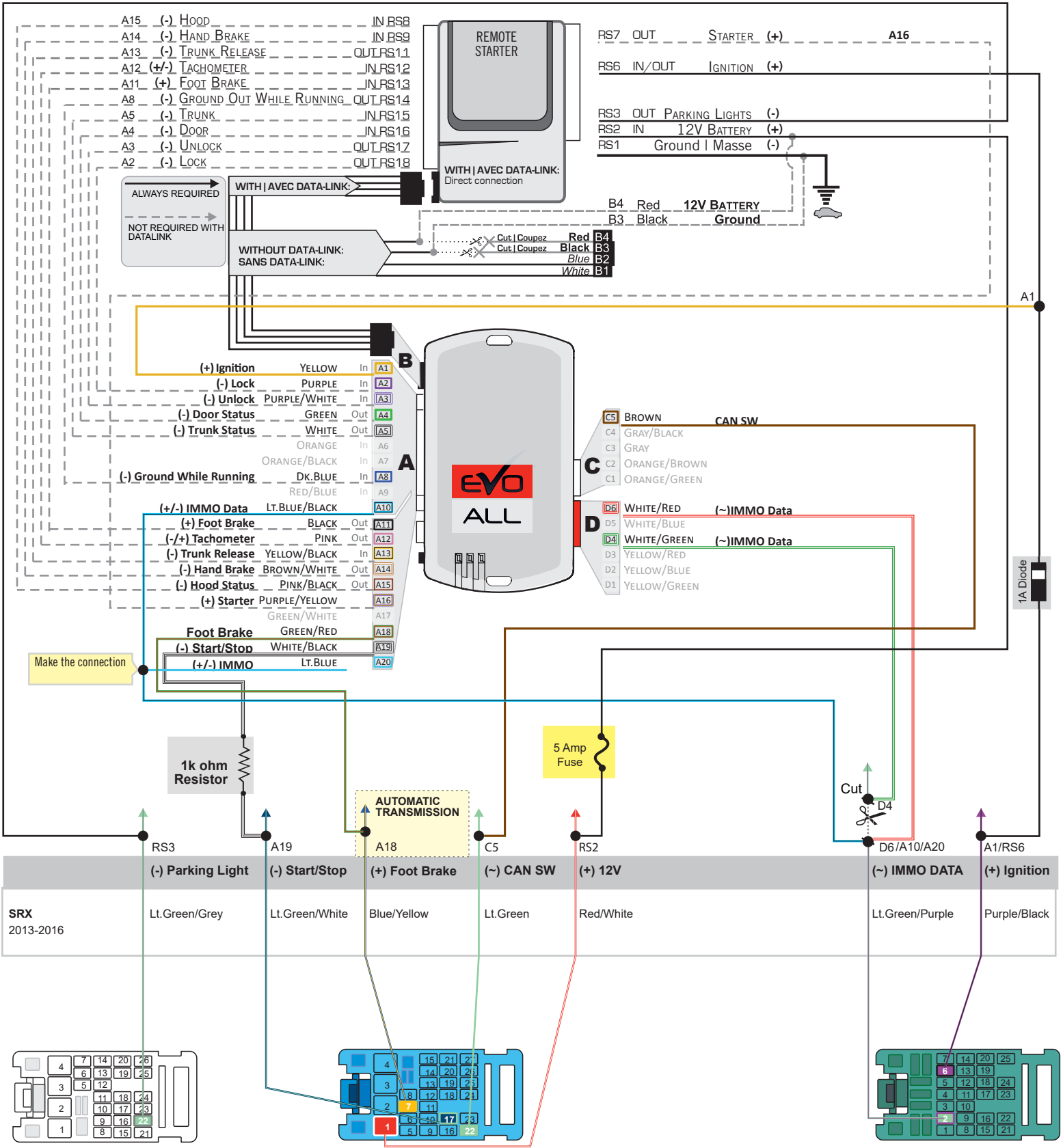

① Back view, 26-Pin White connector, at BCM.

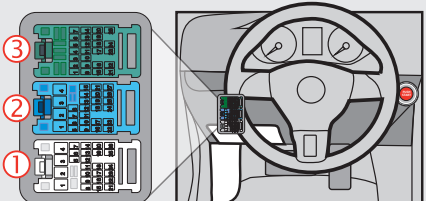

② Back view, 27-Pin Blue connector, at BCM.

③ Back view, 25-Pin Green connector, at BCM.

THAR-GM6 | WIRING CONNECTION

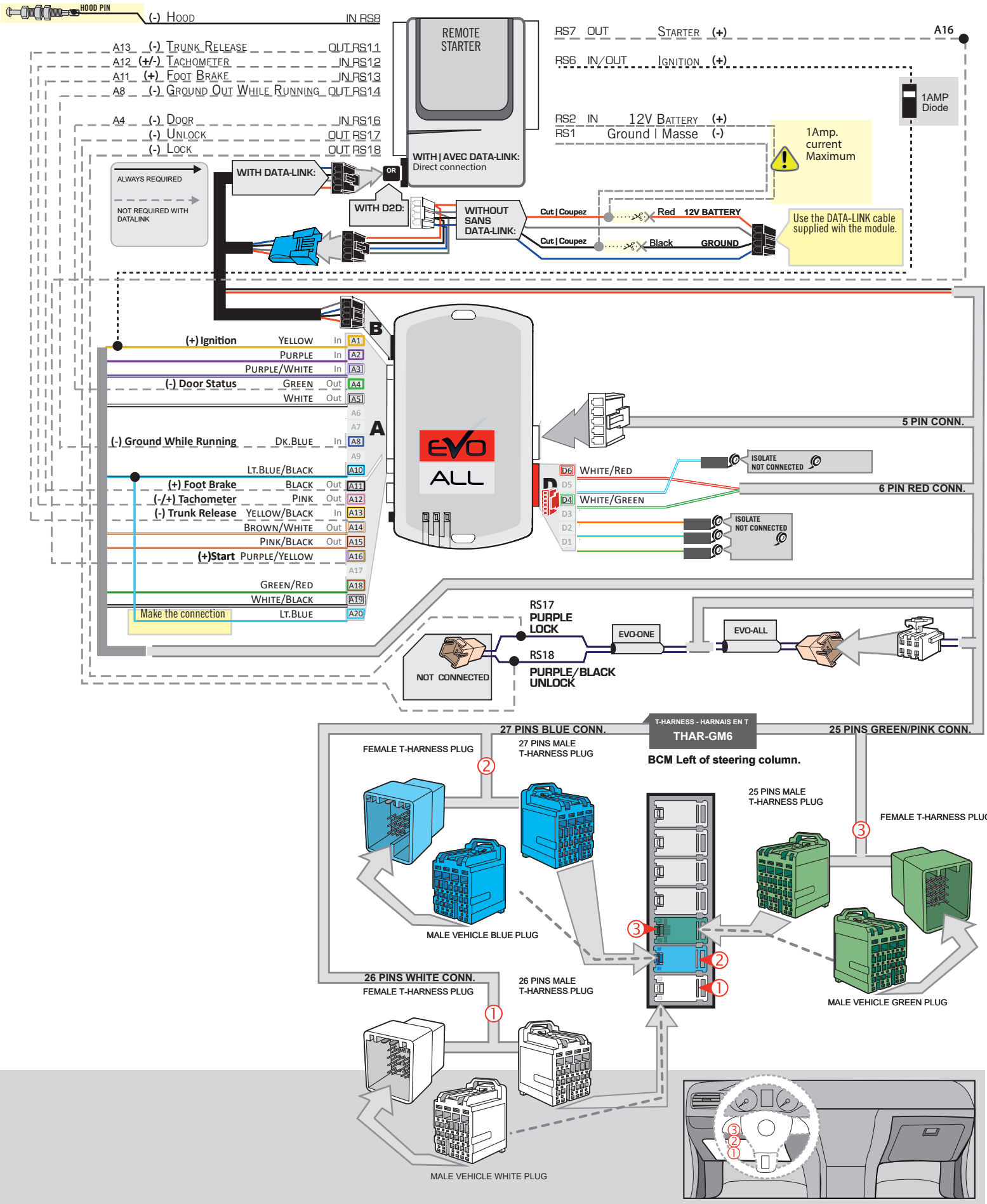

KEY BYPASS PROGRAMMING PROCEDURE 1/3 |

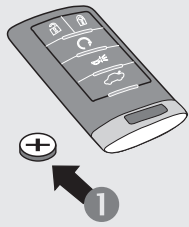

1 Remove the battery from the OEM remote.

2 Place the OEM remote into the transmitter pocket of the center console.

Refer to vehicle user guide for keyport location.

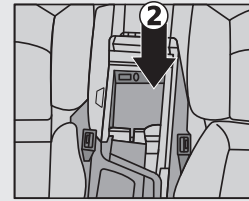

1

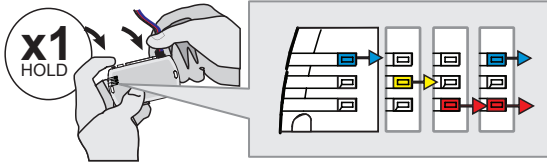

Press and hold the programming button:
Connect the 4-PIN Data-link harness (Black connector).

↳The Blue, Red, Yellow and Blue & Red LEDs will alternatively illuminate.

2

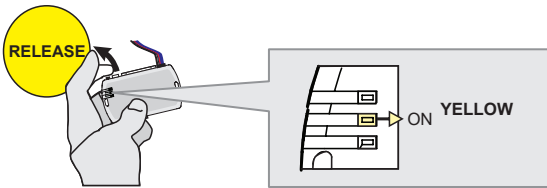

Release the programming button when the LED is YELLOW.

If the LED is not solid YELLOW disconnect the 4-Pin connector (Data-Link) and go back to step 1.

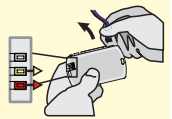

3

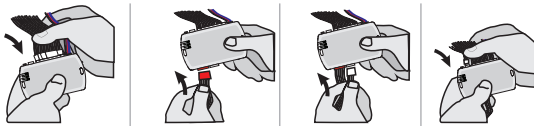

Insert the required remaining connectors.

4

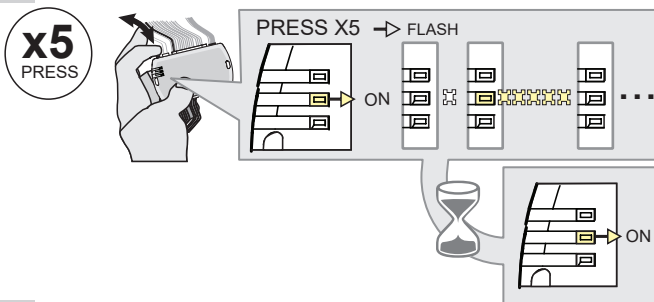

Press and release the programming button five (5x) times.

↳The YELLOW LED will flash 5 times each second.

↳WAIT for the YELLOW LED to turn ON solide.

5

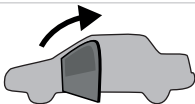

Open the driver door.

6

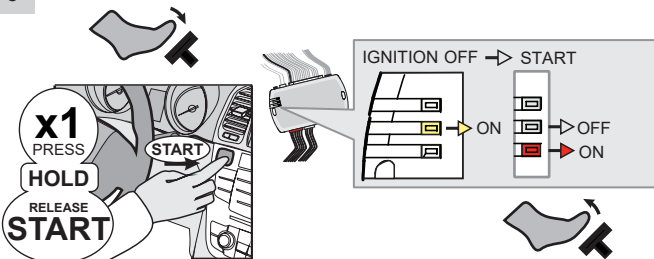

Press the foot-brake pedal.

Press the Push-to-Start button until the engine start.

Release the foot-brake pedal.

↳The RED LED will turn ON.
↳The YELLOW LED will turn OFF.

KEY BYPASS PROGRAMMING PROCEDURE 2/3 |

7



Press the Push-to-Start button until the engine turn OFF.

8

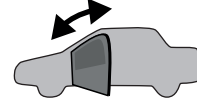

Close and open the driver door.

9

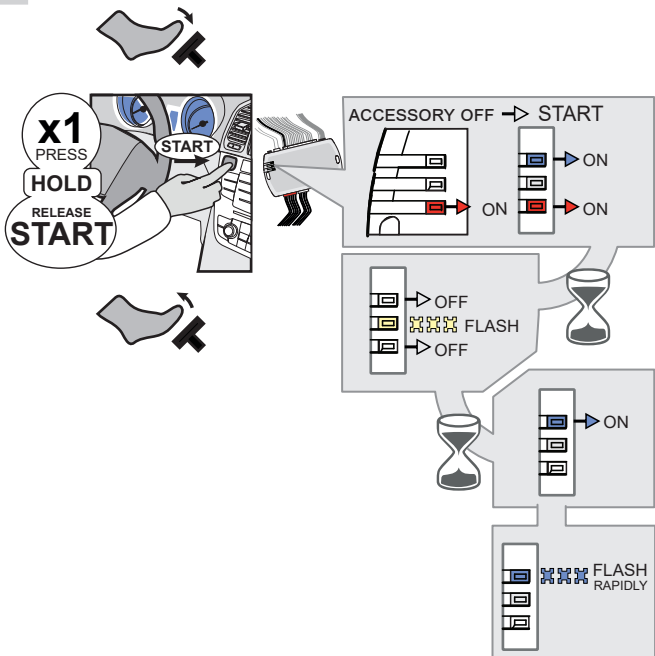
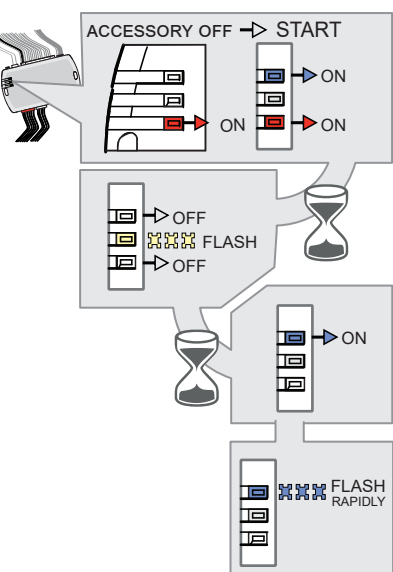
Press the foot-brake pedal.

Press the Push-to-Start button until the engine start.

Release the foot-brake pedal.

- ↳ The BLUE LED will turn ON.
- ↳ The BLUE LED will turn OFF. The RED LED will turn OFF.
- ↳ The YELLOW LED will flash rapidly
- ↳ The BLUE LED will turn ON.
- ↳ The BLUE LED will flash rapidly

10

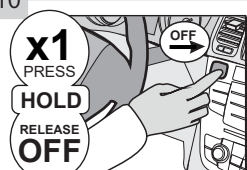
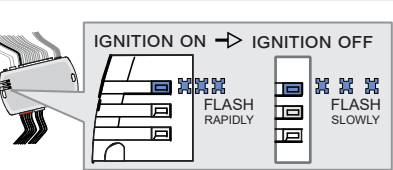
Press the Push-to-Start button until the engine turn OFF.

- ↳ The BLUE LED will flash slowly

11

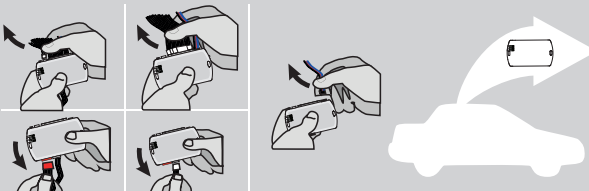

Disconnect all the connectors and after the Data-Link (4-pins) connector.

12

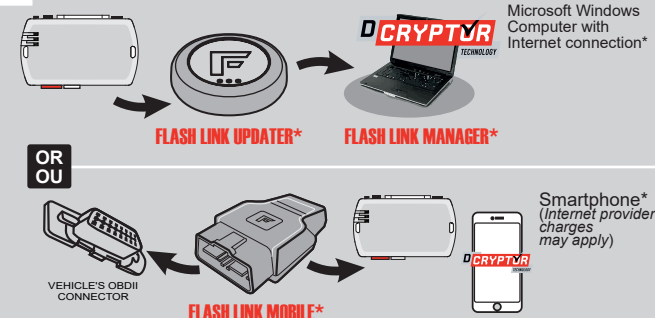

Microsoft Windows Computer with Internet connection*

Smartphone* (Internet provider charges may apply)

Use the tool: FLASH LINK UPDATER or FLASH LINK MOBILE to visit the DCRYPTOR menu.

*Parts required (not included)

13

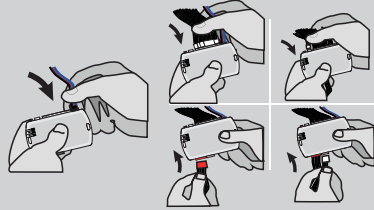
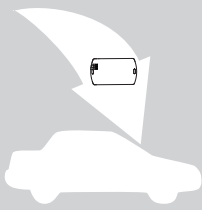

AFTER DCRYPTOR PROGRAMMING COMPLETED
Go back to the vehicle and **reconnect** the 4-Pin (Data-Link) connector and after, all the remaining connector.



The module is now programmed.



REMOTE STARTER / ALARM VERIFICATION PROCEDURE

Test the remote starter. Remote start the vehicle.

REMOTE STARTER FUNCTIONALITY |



All doors must be closed.



Remote start the vehicle.



Unlock the doors with either:

- The OEM remote
- The remote-starter remote
- Or the proximity remote

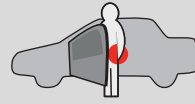

Enter the vehicle with the Intelligent Key.



The vehicle can now be put in to gear and driven.

If the vehicle is not unlocked with one of these conditions the remote-starter will shut down as soon as any door is opened.



REGULAR INSTALLATION AND THAR-GM6 INSTALLATION

ADDENDUM - SUGGESTED WIRING CONFIGURATION

VEHICLE	YEARS	Vehicle functions supported in this diagram (functional if equipped)																
		Immobilizer bypass	Lock	Unlock	Arm	Disarm	Parking Light	Trunk (open)	RAP Disable	Tachometer	Door Status	Trunk Status	Hand-Brake Status	Foot-Brake Status	OEM Remote Monitoring			
																		
CADILLAC																		
XTS	Push-To-Start	2013-2018	•	•	•	•	•	•	•	•	•	•	•	•	•	•	•	•



FIRMWARE VERSION

70.[41]

GM MINIMUM

To add the firmware version and the options, use the **FLASH LINK UPDATER** or **FLASH LINK MOBILE** tool, sold separately.

IF THE VEHICLE IS NOT EQUIPPED WITH FUNCTIONAL HOOD PIN:	A11	OFF	Hood trigger (Output Status).
---	------------	------------	-------------------------------

	UNIT OPTION	DESCRIPTION
 <p>Program bypass option:</p>	C1	OEM Remote status (Lock/Unlock) monitoring
	D6	Push-to-Start

 <p>ATTENTION!</p>	 <p>DATE: XX-XX</p>	E5	OFF	SPECIAL FUNCTIONS: BY DEFAULT DEACTIVATED
		ON	MANUFACTURED MODULES BETWEEN: 04/2018 TO 04/2019	

MANDATORY INSTALL

*HOOD PIN



HOOD STATUS: THE HOOD PIN SWITCH MUST BE INSTALLED IF THE VEHICLE CAN BE REMOTE STARTED WITH THE HOOD OPEN, SET FUNCTION **A11** TO OFF.

A11	OFF
------------	------------

Notice: the installation of safety elements are mandatory. The hood pin is an essential security element and must be installed.

THIS MODULE MUST BE INSTALLED BY A QUALIFIED TECHNICIAN. A WRONG CONNECTION CAN CAUSE PERMANENT DAMAGE TO THE VEHICLE.

DESCRIPTION | DESCRIPTION

Parts required (Not included) PAGE

WIRE TO WIRE DIAGRAM

<p>1X 1Amp Diode 1X 5 Amp Fuse 1X 1k Ohm Resistor</p>	<p>Page 3</p>
---	---------------

THARNESSE DIAGRAM

<p>THARNESSE THAR-GM6</p>	<p>1x THAR-GM6</p>	<p>Page 4</p>
---------------------------	--------------------	---------------

BCM

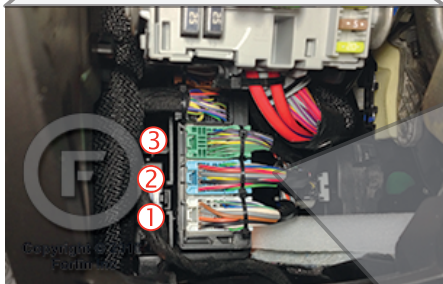
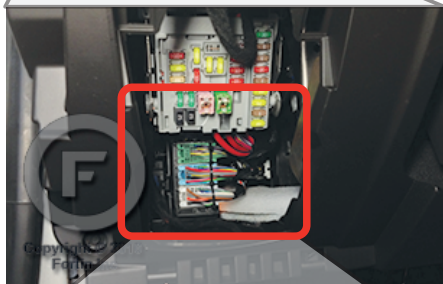
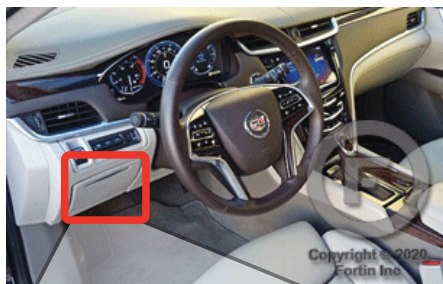

XTS

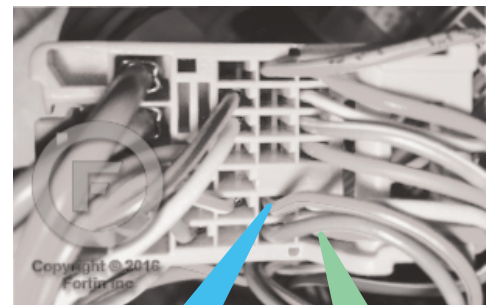
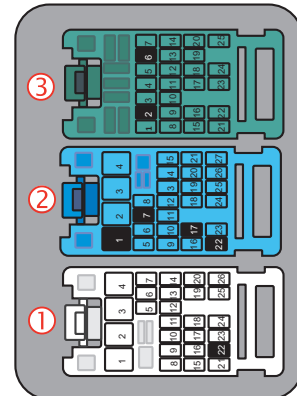
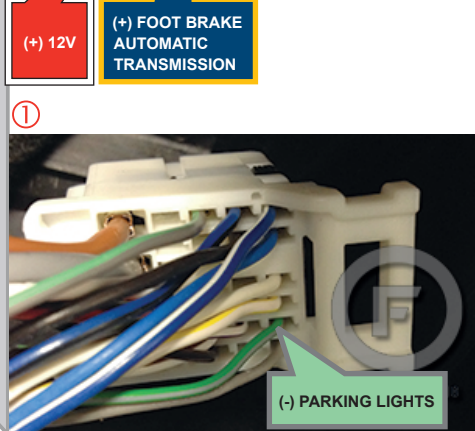
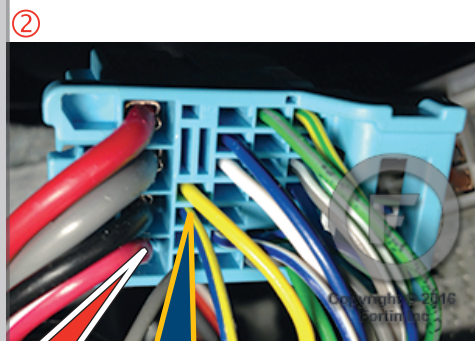
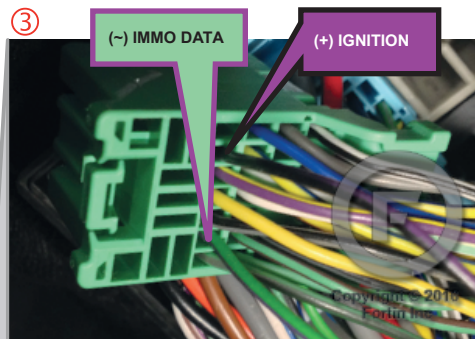

AUTOMATIC TRANSMISSION WIRING CONNECTION

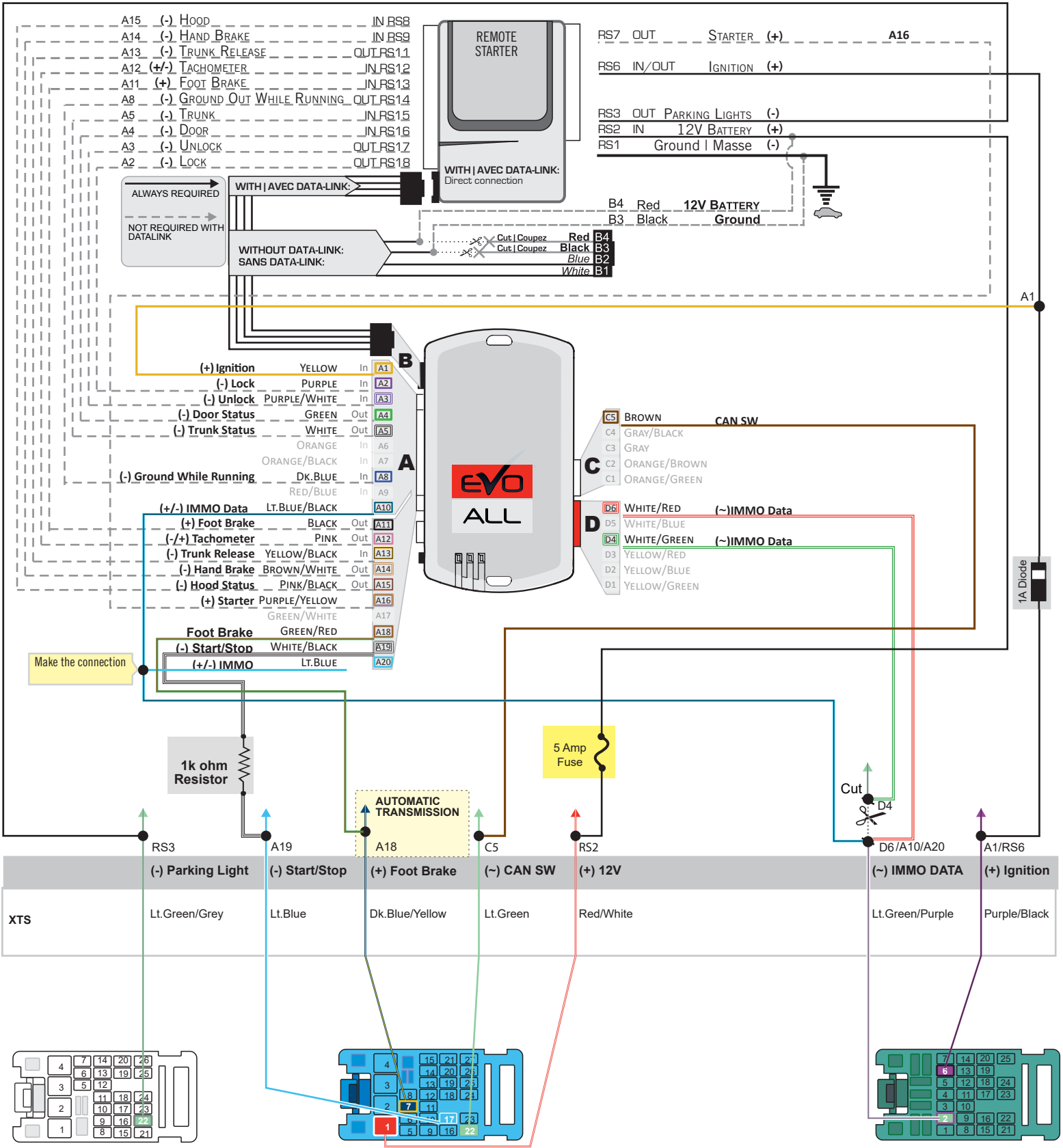

① Back view, 26-Pin White connector, at BCM.

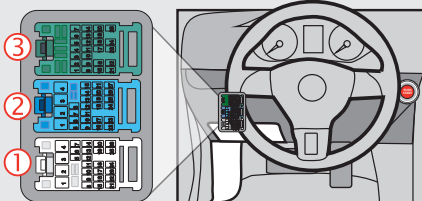

② Back view, 27-Pin Blue connector, at BCM.

③ Back view, 25-Pin Green connector, at BCM.

THAR-GM6 | WIRING CONNECTION

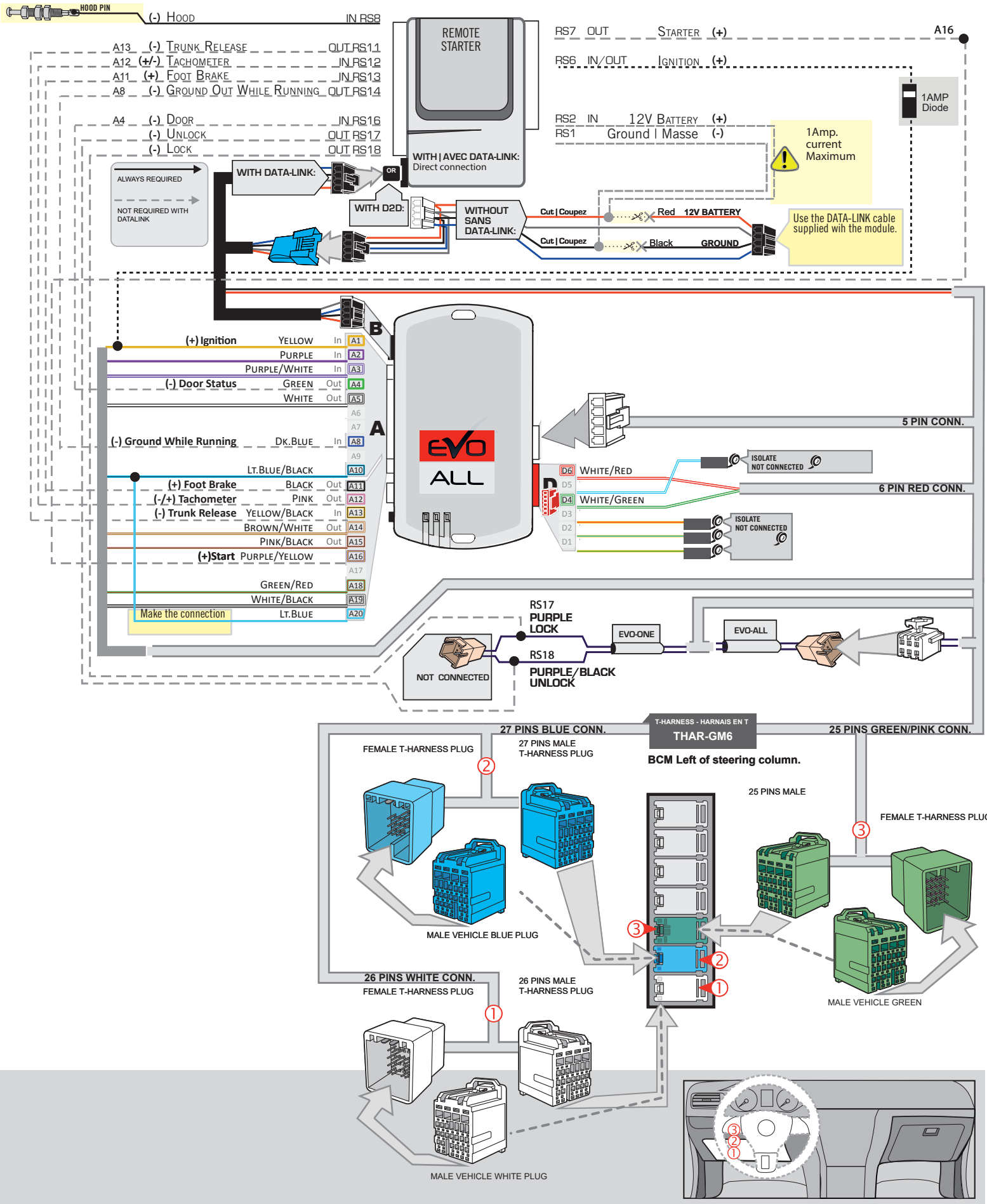

KEY BYPASS PROGRAMMING PROCEDURE 1/3 |

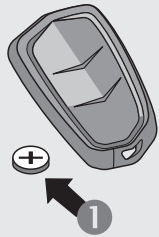

- 1 Remove the battery from the OEM remote.
- 2 Place the OEM remote into the transmitter pocket of the center console.
Refer to vehicle user guide for keyport location.

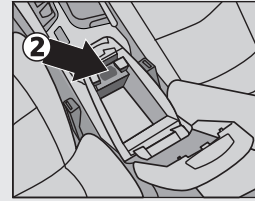

1

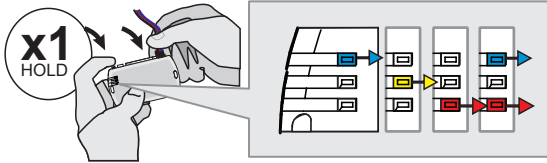

Press and hold the programming button:
Connect the 4-PIN Data-link harness (Black connector).

↳The Blue, Red, Yellow and Blue & Red LEDs will alternatively illuminate.

2

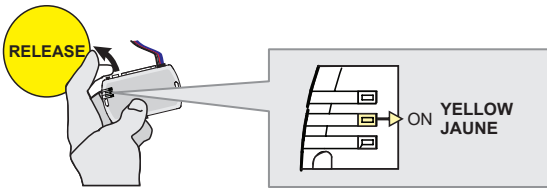

Release the programming button when the LED is YELLOW.

If the LED is not solid YELLOW disconnect the 4-Pin connector (Data-Link) and go back to step 1.

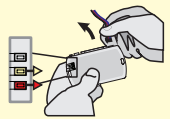

3

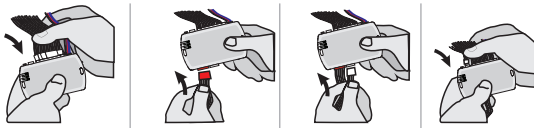

Insert the required remaining connectors.

4

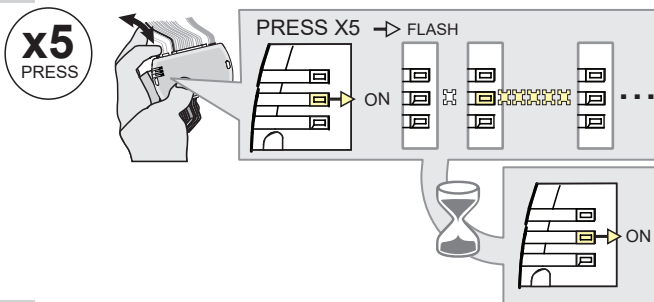

Press and release the programming button five (5x) times.

↳The YELLOW LED will flash 5 times each second.

↳**WAIT** for the YELLOW LED to turn ON solide.

5

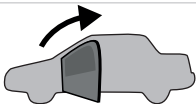

Open the driver door.

6

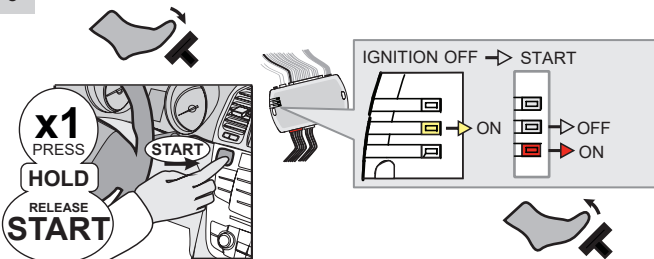

Press the foot-brake pedal.

Press the Push-to-Start button until the engine start.

Release the foot-brake pedal.

↳The RED LED will turn ON.
↳The YELLOW LED will turn OFF.

KEY BYPASS PROGRAMMING PROCEDURE 2/3 |

7



Press the Push-to-Start button until the engine turn OFF.

8

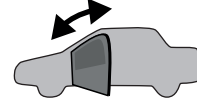

Close and open the driver door.

9

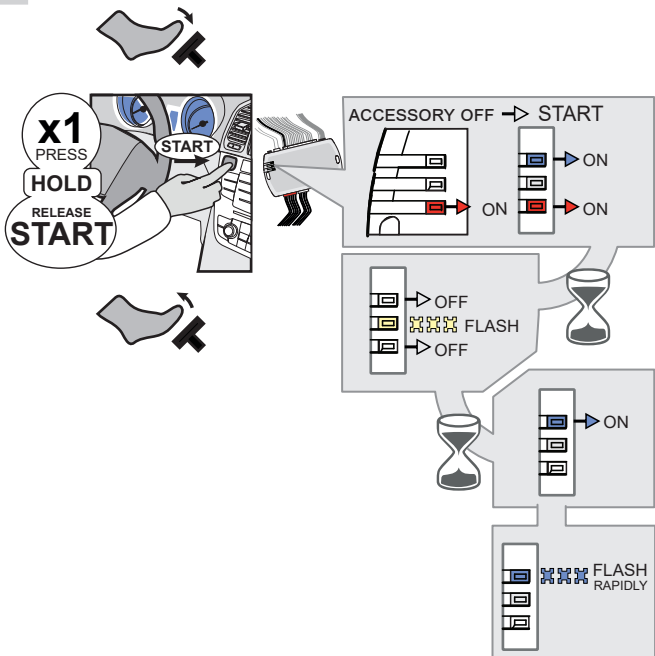
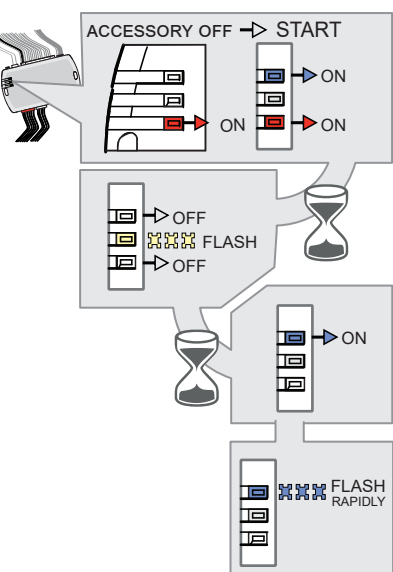
Press the foot-brake pedal.

Press the Push-to-Start button until the engine start.

Release the foot-brake pedal.

- ↳ The BLUE LED will turn ON.
- ↳ The BLUE LED will turn OFF. The RED LED will turn OFF.
- ↳ The YELLOW LED will flash rapidly
- ↳ The BLUE LED will turn ON.
- ↳ The BLUE LED will flash rapidly

10

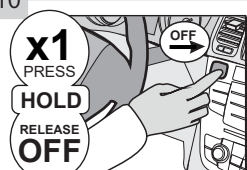
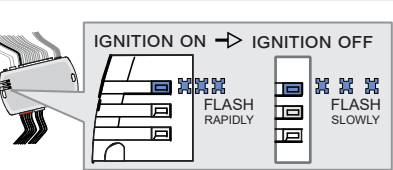
Press the Push-to-Start button until the engine turn OFF.

- ↳ The BLUE LED will flash slowly

11

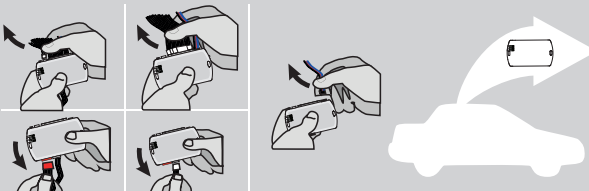

Disconnect all the connectors and after the Data-Link (4-pins) connector.

12

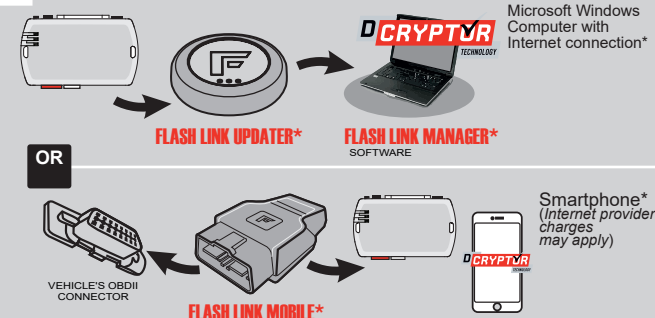

Microsoft Windows Computer with Internet connection*

Smartphone* (Internet provider charges may apply)

Use the tool: FLASH LINK UPDATER or FLASH LINK MOBILE to visit the DCRYPTOR menu.

*Parts required (not included)

13

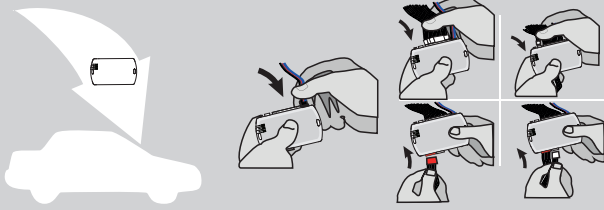

AFTER DCRYPTOR PROGRAMMING COMPLETED
Go back to the vehicle and **reconnect** the 4-Pin (Data-Link) connector and after, all the remaining connector.



The module is now programmed.



REMOTE STARTER / ALARM VERIFICATION PROCEDURE

Test the remote starter. Remote start the vehicle.

REMOTE STARTER FUNCTIONALITY |



All doors must be closed.



Remote start the vehicle.



Unlock the doors with either:

- The OEM remote
- The remote-starter remote
- Or the proximity remote

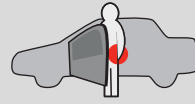

Enter the vehicle with the Intelligent Key.



The vehicle can now be put in to gear and driven.

If the vehicle is not unlocked with one of these conditions the remote-starter will shut down as soon as any door is opened.



STAND ALONE INSTALLATION AND THAR-GM6 INSTALLATION

ADDENDUM - SUGGESTED WIRING CONFIGURATION



ONLY COMPATIBLE WITH AUTOMATIC TRANSMISSION VEHICLES.



VEHICLE

YEARS

Vehicle functions supported in this diagram (functional if equipped)

VEHICLE	YEARS	Immobilizer bypass	Lock	Unlock	Arm	Disarm	Parking Light	Trunk (open)	RAP Disable	Tachometer	Door Status	Trunk Status	Hand-Brake Status	Foot-Brake Status	OEM Remote Monitoring
CHEVROLET															
Impala	Push-To-Start	2014-2019	•	•	•	•	•	•	•	•	•	•	•	•	•



FIRMWARE VERSION

70.[41]

GM MINIMUM

To add the firmware version and the options, use the **FLASH LINK UPDATER** or **FLASH LINK MOBILE** tool, sold separately.

IF THE VEHICLE IS NOT EQUIPPED WITH FUNCTIONAL HOOD PIN:

A11

OFF

Hood trigger (Output Status).



Program bypass option:

UNIT OPTION

DESCRIPTION

C1

OEM Remote status (Lock/Unlock) monitoring

D6

Push-to-Start



ATTENTION!

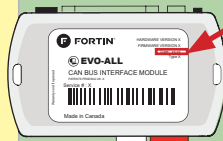

DATE: XX-XX

E5

OFF

SPECIAL FUNCTIONS: BY DEFAULT DEACTIVATED

ON

MANUFACTURED MODULES BETWEEN: 04/2018 TO 04/2019

MANDATORY INSTALL

*HOOD PIN



HOOD STATUS: THE HOOD PIN SWITCH MUST BE INSTALLED IF THE VEHICLE CAN BE REMOTE STARTED WITH THE HOOD OPEN, SET FUNCTION **A11** TO OFF.

A11

OFF

Notice: the installation of safety elements are mandatory. The hood pin is an essential security element and must be installed.

THIS MODULE MUST BE INSTALLED BY A QUALIFIED TECHNICIAN. A WRONG CONNECTION CAN CAUSE PERMANENT DAMAGE TO THE VEHICLE.

PARTS REQUIRED (NOT INCLUDED)

1x **FLASH LINK UPDATER**
 1x **FLASH LINK MANAGER**
 SOFTWARE
 1x Microsoft Windows Computer with Internet connection

OR

1x **FLASH LINK MOBILE**
 1x **FLASH LINK MOBILE APP**
 Smartphone *Android* or *iOS* with Internet connection (*provider charges may apply*).
 1x

MANDATORY

HOOD PIN



REMOTE START SAFETY OVERRIDE SWITCH

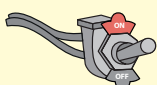





VALET SWITCH

Part #: RSPB available, Sold separately.

Notice: the installation of safety elements are mandatory. The hood pin and the valet switch are essential security elements and must be installed.

STAND ALONE CONFIGURATION

	Program bypass option	UNIT OPTION	DESCRIPTION
	OEM Remote Stand Alone Remote Starter:	D1.10 	By default, LOCK, LOCK, LOCK Par défaut, VERROUILLE,VERROUILLE,VERROUILLE
		D1.1 	
	Program bypass option with oem remote:	C1	OEM Remote Monitoring
	Program bypass option with RF KIT antenna:	H1 to H6	Supported RF Kits and select RF Kit

REMOTE STARTER FUNCTIONALITY



All doors must be closed.

3X 

Press the OEM remote's Lock button 3x to remote-start (or remote-stop) the vehicle.



START 

The vehicle will START.

REMOTE STARTER DIAGNOSTICS
MODULE RED LED

x2 flash :	Brake ON
x3 flash :	No tach
x4 flash :	Ignition before start
x5 flash :	Hood Open

REMOTE STARTER WARNING CARD



CUT THIS WARNING CARD AND STICK IT ON A VISIBLE PLACE:
 or use the package **RSPB**, Sold separately.

WARNING | ATTENTION

REMOTE STARTER

THE VEHICLE CAN BE STARTED BY EITHER: PRESSING THE LOCK BUTTON ON THE OEM REMOTE 3 TIMES CONSECUTIVELY OR BY A SMARTPHONE. **TURN ON** THE SAFETY SWITCH LOCATED UNDER THE DASHBOARD BEFORE WORKING ON THE VEHICLE.

DESCRIPTION

Parts required (Not included)		PAGE
-------------------------------	--	------

WIRE TO WIRE DIAGRAM

	1X 5 Amp Fuse 1X 1k Ohm Resistor	Page 4
--	-------------------------------------	--------

THARNESSE DIAGRAM

THARNESSE THAR-GM6	1x THAR-GM6	Page 5
--------------------	-------------	--------

BCM

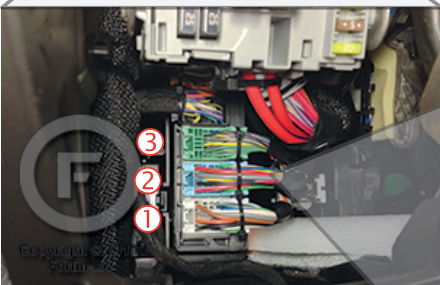
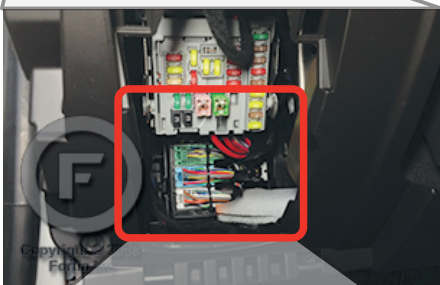

Impala

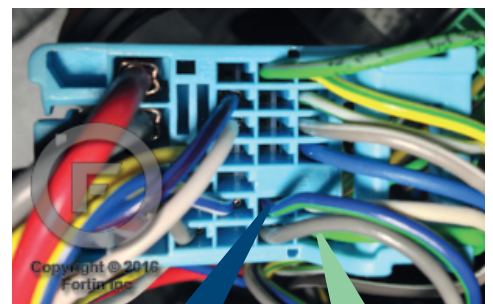
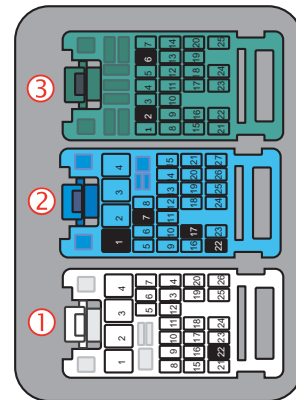
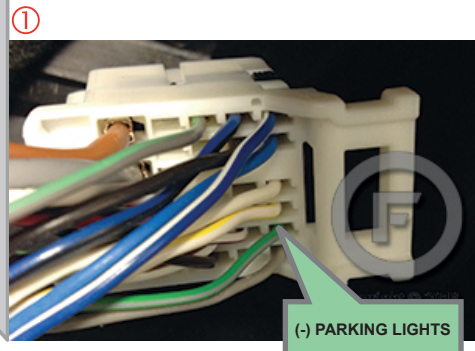
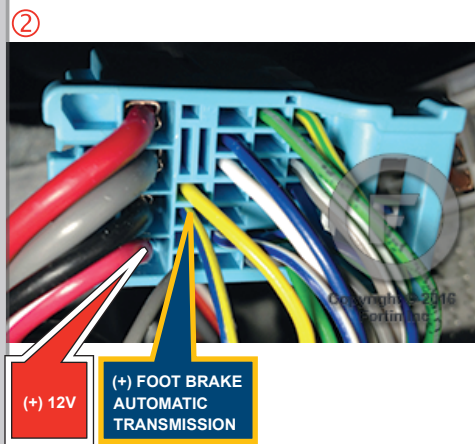
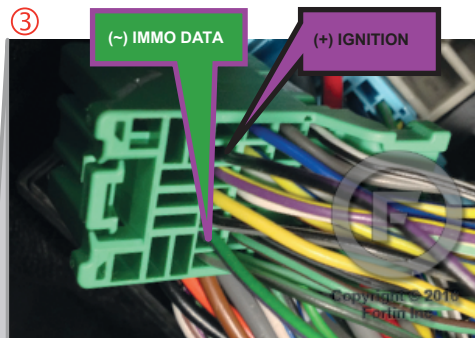

AUTOMATIC TRANSMISSION WIRING CONNECTION

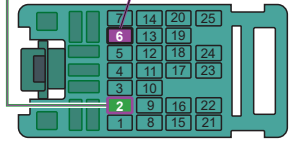
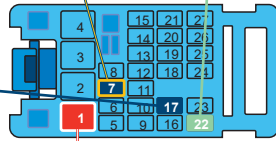
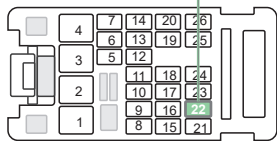
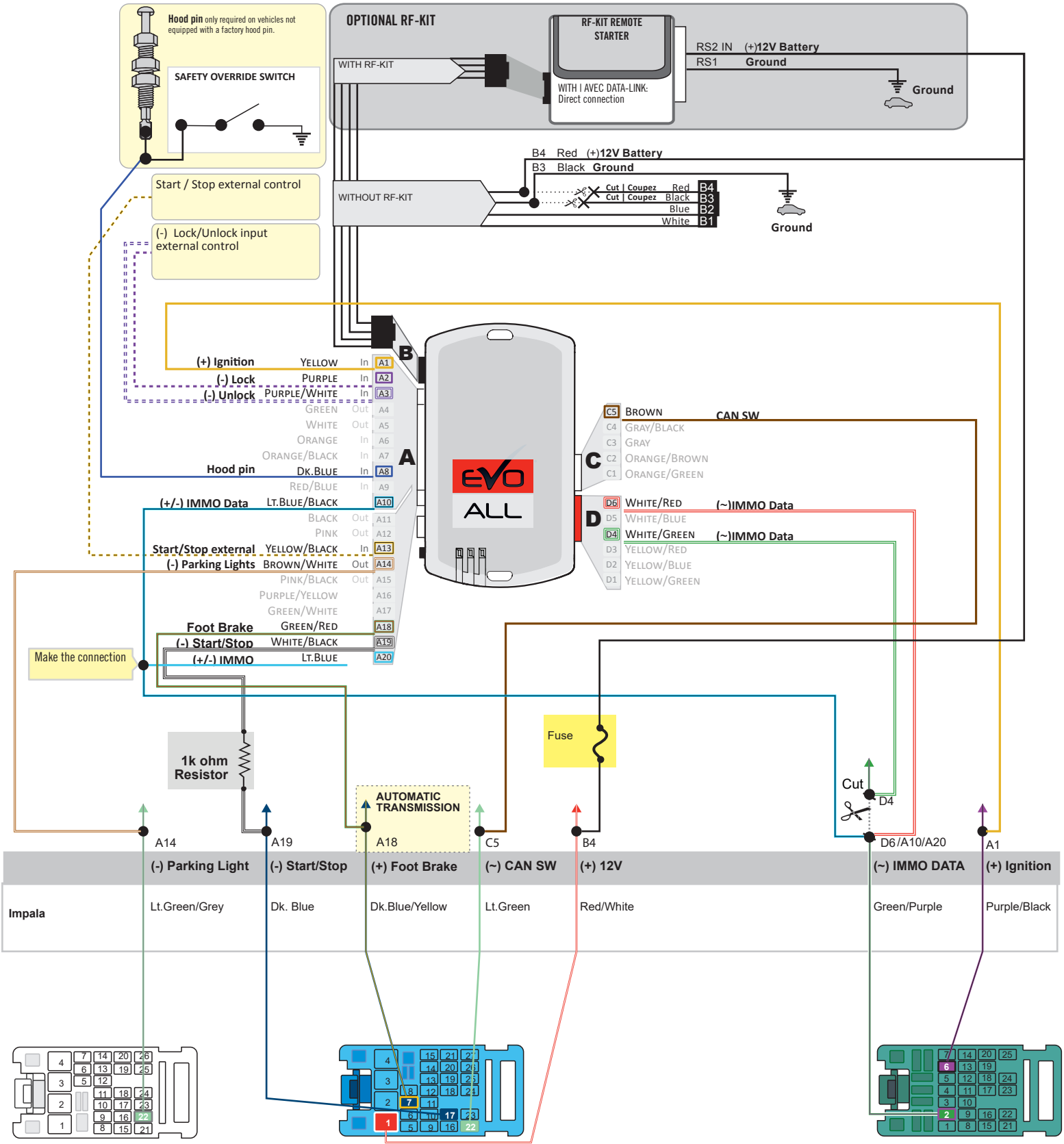

① Back view, 26-Pin White connector, at BCM.

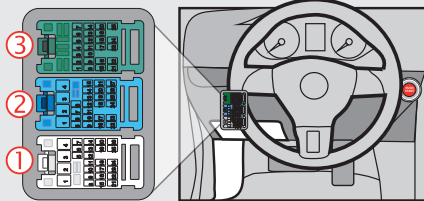

② Back view, 27-Pin Blue connector, at BCM.

③ Back view, 25-Pin Green connector, at BCM.

THAR-GM6 | AUTOMATIC TRANSMISSION CONNECTION

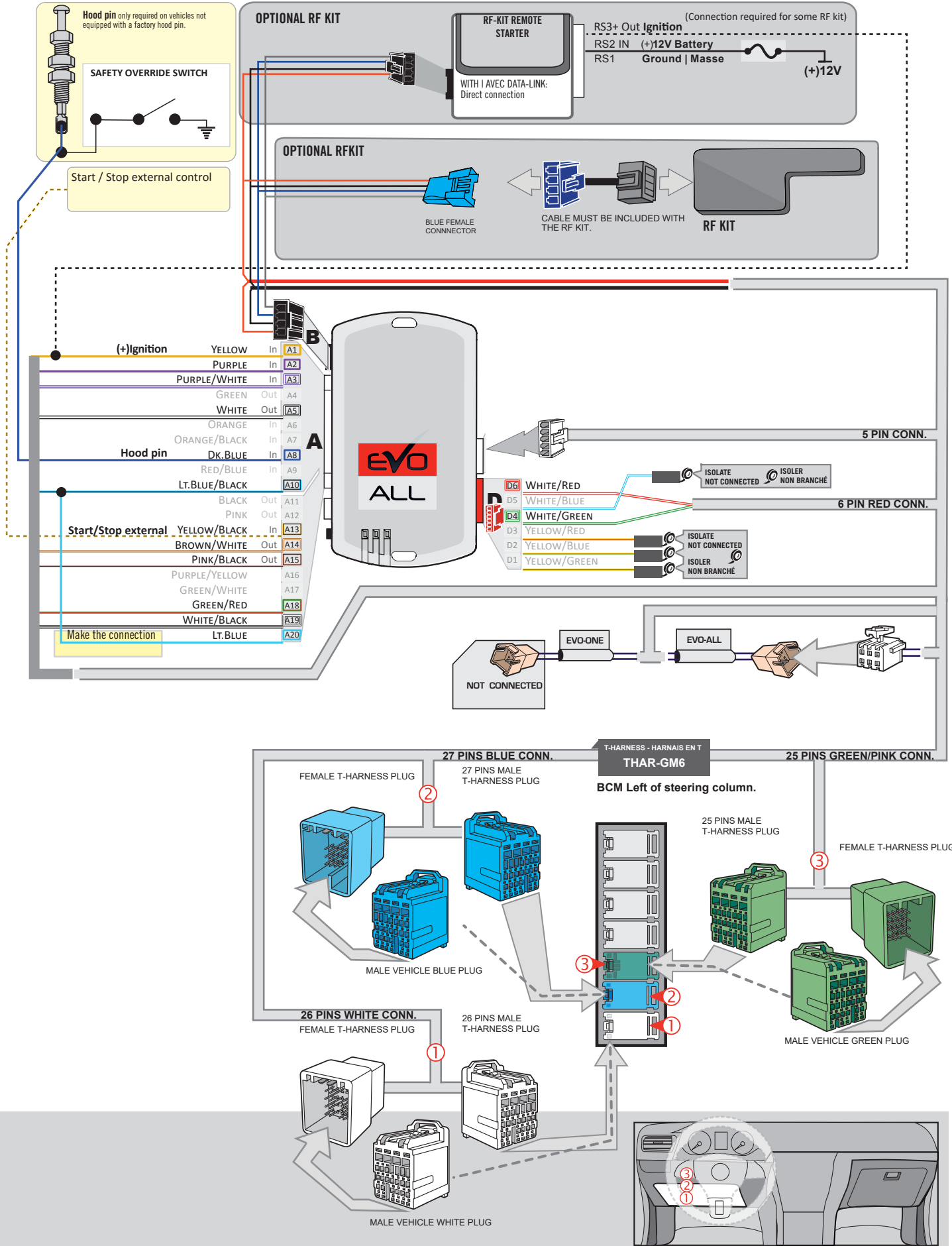

KEY BYPASS PROGRAMMING PROCEDURE 1/3



- 1 Remove** the battery from the OEM remote.
- 2 Place** the OEM remote into the transmitter pocket of the center console.
Refer to vehicule user guide for keyport location.

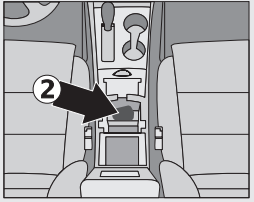

1

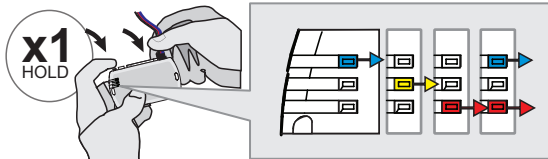

Press and hold the programming button:
Connect the 4-PIN Data-link harness (Black connector).

↳The Blue, Red, Yellow and Blue & Red LEDs will alternatively illuminate.

2

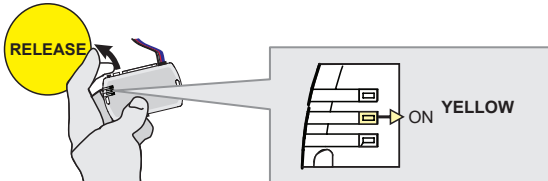

Release the programming button when the LED is YELLOW.

If the LED is not solid YELLOW disconnect the 4-Pin connector (Data-Link) and go back to step 1.

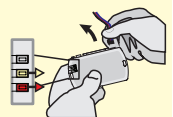

3

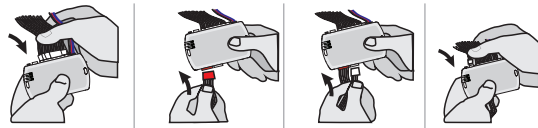

Insert the required remaining connectors.

4

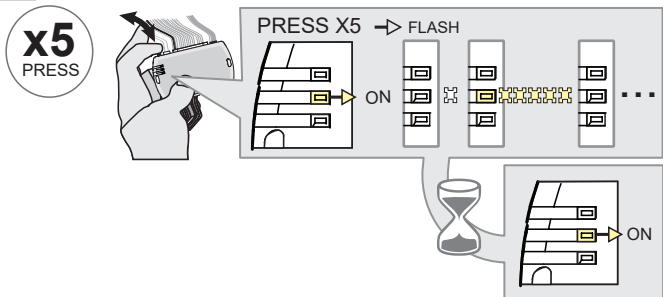

Press and release the programming button five (5x) times.

↳The YELLOW LED will flash 5 times each second.

↳**WAIT** for the YELLOW LED to turn ON solide.

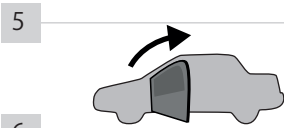

Open the driver door.

6

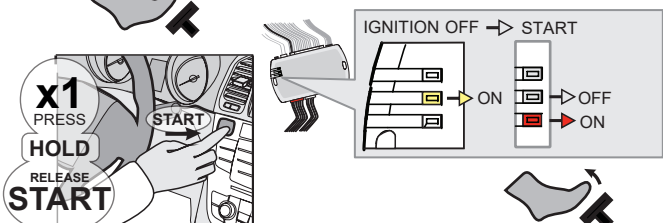

Press the foot-brake pedal.

Press the Push-to-Start button until the engine start.

Release the foot-brake pedal.

↳The RED LED will turn ON.
↳The YELLOW LED will turn OFF.

KEY BYPASS PROGRAMMING PROCEDURE 2/3

7



Press the Push-to-Start button until the engine turn OFF.

8

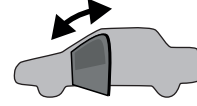

Close and open the driver door.

9

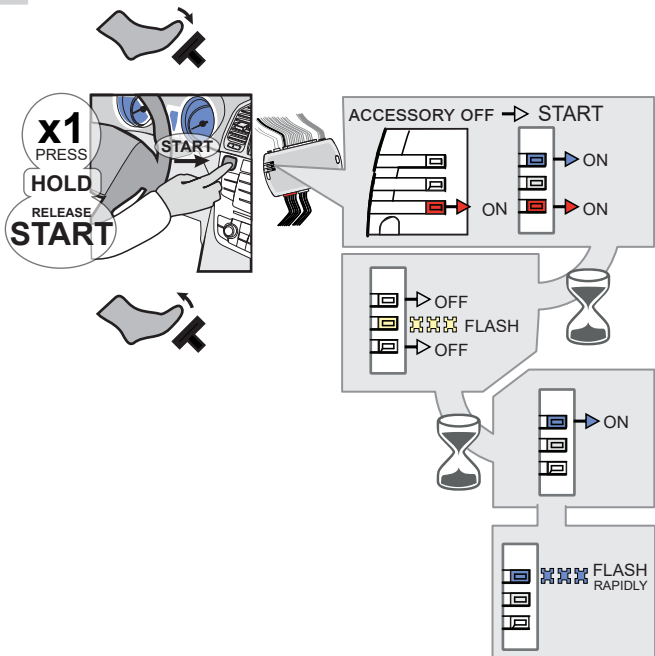
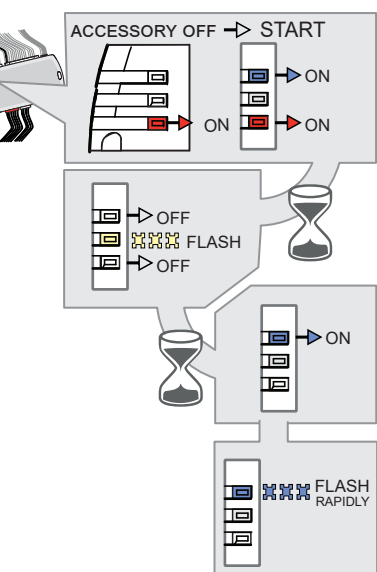
Press the foot-brake pedal.

Press the Push-to-Start button until the engine start.

Release the foot-brake pedal.

- ↳ The BLUE LED will turn ON.
- ↳ The BLUE LED will turn OFF. The RED LED will turn OFF.
- ↳ The YELLOW LED will flash rapidly
- ↳ The BLUE LED will turn ON.
- ↳ The BLUE LED will flash rapidly

10

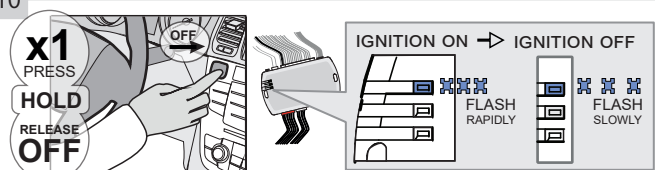
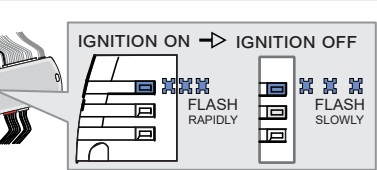
Press the Push-to-Start button until the engine turn OFF.

- ↳ The BLUE LED will flash slowly

11

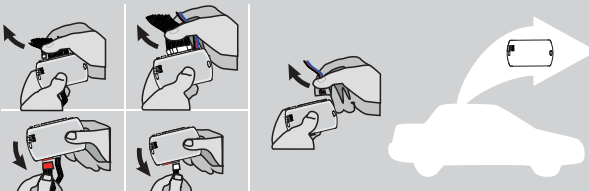

Disconnect all the connectors and after the Data-Link (4-pins) connector.

12

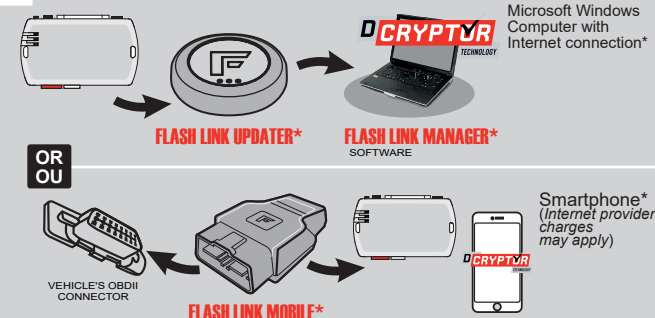

Microsoft Windows Computer with Internet connection*

FLASH LINK UPDATER* **FLASH LINK MANAGER*** SOFTWARE

OR

Smartphone* (Internet provider charges may apply)

FLASH LINK MOBILE*

Use the tool: FLASH LINK UPDATER or FLASH LINK MOBILE to visit the DCryptor menu.

*Parts required (not included)

KEY BYPASS PROGRAMMING PROCEDURE 3/3

13

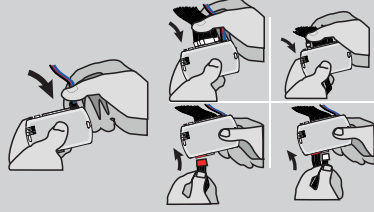
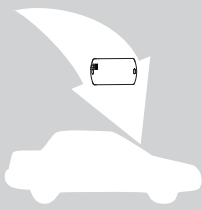

AFTER DCRYPTOR PROGRAMMING COMPLETED
Go back to the vehicle and **reconnect** the 4-Pin (Data-Link) connector and after, all the remaining connector.



The module is now programmed.



REMOTE STARTER / ALARM VERIFICATION PROCEDURE

Test the remote starter. Remote start the vehicle.

OPTIONAL RF-KIT PROGRAMMING

PROGRAM BYPASS OPTION

	<p>Program bypass option:</p>	<p>H2</p>	<p>Supported RF-KITS enable</p> <p>H2 Fortin 2</p>

OPTIONAL FORTIN RF KIT SERIES 4 OR SERIES 9 PROGRAMMING

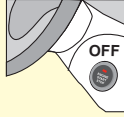

The module must be programmed on the vehicle.

MAKE SURE THE IGNITION KEY HAS BEEN IN THE OFF POSITION FOR AT LEAST 5 SECONDS.

1

ON



ON

Press the foot-brake pedal. Press the Push-to-Start button until the engine start. Release the foot-brake pedal.

2

OFF



OFF

Press the Push-to-Start button until the engine turn OFF.

3

ON

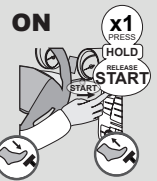

ON

Press the foot-brake pedal. Press the Push-to-Start button until the engine start. Release the foot-brake pedal.

4

4X BRAKES



4X PRESS

Press and release the brake pedal four times.

5

ON EACH TRANSMITTER

4 BUTTONS



PRESS AND RELEASE



PRESS AND RELEASE

1 BUTTON



PRESS APPROX. 12 SEC. AND WAIT FOR THE BLUE LED TO TURN OFF THEN BACK ON SOLID THEN RELEASE.

6

OFF

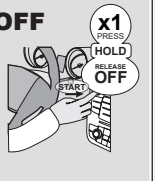

OFF

Press the Push-to-Start button until the engine turn OFF.

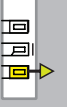

The YELLOW LED will turn ON solid.



The YELLOW LED will turn Off.

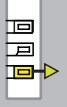

The YELLOW LED will turn ON solid.

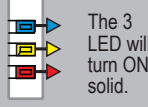

The 3 LED will turn ON solid.



The LED will flash rapidly.

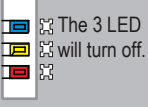

The 3 LED will turn off.



The LED will turn ON solide.



The LED will flash rapidly.



The LED will turn off each time.



The LED will flash rapidly.



The 3 LED will turn off each time.



The LED will turn Off.



REMOTE STARTER FUNCTIONALITY



All doors must be closed.



Remote start the vehicle.



Unlock the doors with either:

- The OEM remote
- The remote-starter remote
- Or the proximity remote



Enter the vehicle with the Intelligent Key.



The vehicle can now be put in to gear and driven.

If the vehicle is not unlocked with one of these conditions the remote-starter will shut down as soon as any door is opened.



STAND ALONE INSTALLATION AND THAR-GM6 INSTALLATION

ADDENDUM - SUGGESTED WIRING CONFIGURATION



ONLY COMPATIBLE WITH AUTOMATIC TRANSMISSION VEHICLES.



Vehicle functions supported in this diagram (functional if equipped)

VEHICLE	YEARS	Immobilizer bypass	Lock	Unlock	Arm	Disarm	Parking Light	Trunk (open)	RAP Disable	Tachometer	Door Status	Trunk Status	Hand-Brake Status	Foot-Brake Status	OEM Remote Monitoring
BUICK															
LaCrosse	Push-To-Start	2010	•	•	•	•	•	•	•	•	•	•	•	•	•



FIRMWARE VERSION

70.[41]

GM MINIMUM

To add the firmware version and the options, use the **FLASH LINK UPDATER** or **FLASH LINK MOBILE** tool, sold separately.

IF THE VEHICLE IS NOT EQUIPPED WITH FUNCTIONAL HOOD PIN:	A11	OFF	Hood trigger (Output Status).
--	-----	-----	-------------------------------

	UNIT OPTION	DESCRIPTION
 <p>Program bypass option:</p>	C1	OEM Remote status (Lock/Unlock) monitoring
	D6	Push-to-Start

	ATTENTION!	 <p>DATE: XX-XX</p>	E5	OFF	<p>SPECIAL FUNCTIONS: BY DEFAULT DEACTIVATED</p>
			ON	<p>MANUFACTURED MODULES BETWEEN: 04/2018 TO 04/2019</p>	

MANDATORY INSTALL

*HOOD PIN



HOOD STATUS: THE HOOD PIN SWITCH MUST BE INSTALLED IF THE VEHICLE CAN BE REMOTE STARTED WITH THE HOOD OPEN, SET FUNCTION A11 TO OFF.

A11	OFF
-----	-----

Notice: the installation of safety elements are mandatory. The hood pin is an essential security element and must be installed.

THIS MODULE MUST BE INSTALLED BY A QUALIFIED TECHNICIAN. A WRONG CONNECTION CAN CAUSE PERMANENT DAMAGE TO THE VEHICLE.

PARTS REQUIRED (NOT INCLUDED)

1x **FLASH LINK UPDATER**
 1x **FLASH LINK MANAGER**
 SOFTWARE
 1x Microsoft Windows Computer with Internet connection

OR

1x **FLASH LINK MOBILE**
 1x **FLASH LINK MOBILE APP**
 Smartphone *Android* or *iOS* with Internet connection (*provider charges may apply*).
 1x

MANDATORY

HOOD PIN



REMOTE START SAFETY OVERRIDE SWITCH

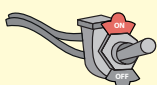





VALET SWITCH

Part #: RSPB available, Sold separately.

Notice: the installation of safety elements are mandatory. The hood pin and the valet switch are essential security elements and must be installed.

STAND ALONE CONFIGURATION

	Program bypass option	UNIT OPTION	DESCRIPTION
	OEM Remote Stand Alone Remote Starter:	D1.10 	By default, LOCK, LOCK, LOCK Par défaut, VERROUILLE,VERROUILLE,VERROUILLE
		D1.1 	
	Program bypass option with oem remote:	C1	OEM Remote Monitoring
	Program bypass option with RF KIT antenna:	H1 to H6	Supported RF Kits and select RF Kit

REMOTE STARTER FUNCTIONALITY



All doors must be closed.

3X 

Press the OEM remote's Lock button 3x to remote-start (or remote-stop) the vehicle.



START

The vehicle will START.

REMOTE STARTER DIAGNOSTICS
MODULE RED LED

x2 flash :	Brake ON
x3 flash :	No tach
x4 flash :	Ignition before start
x5 flash :	Hood Open

REMOTE STARTER WARNING CARD



CUT THIS WARNING CARD AND STICK IT ON A VISIBLE PLACE:
 or use the package **RSPB**, Sold separately.

WARNING | ATTENTION



REMOTE STARTER

THE VEHICLE CAN BE STARTED BY EITHER: PRESSING THE LOCK BUTTON ON THE OEM REMOTE 3 TIMES CONSECUTIVELY OR BY A SMARTPHONE. **TURN ON** THE SAFETY SWITCH LOCATED UNDER THE DASHBOARD BEFORE WORKING ON THE VEHICLE.

DESCRIPTION

Parts required (Not included) PAGE

WIRE TO WIRE DIAGRAM

	1X 5 Amp Fuse 1X 1k Ohm Resistor	Page 4
--	-------------------------------------	--------

THARNESSE DIAGRAM

THARNESSE THAR-GM6	1x THAR-GM6	Page 5
--------------------	-------------	--------

BCM

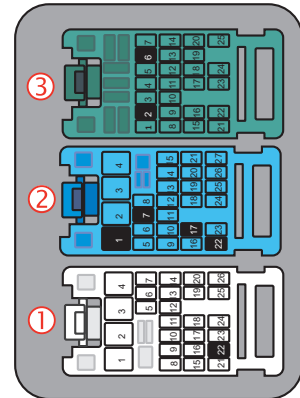
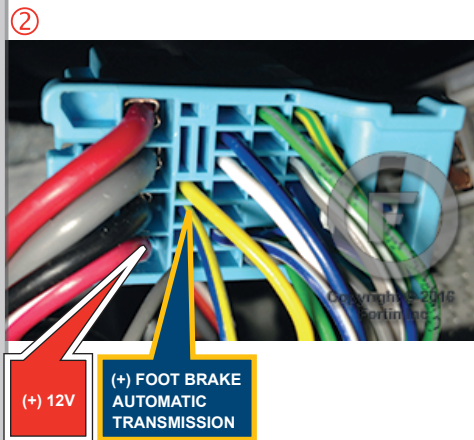
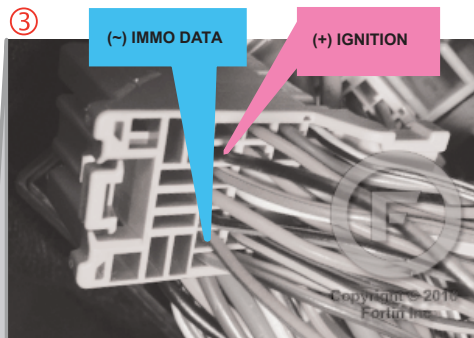
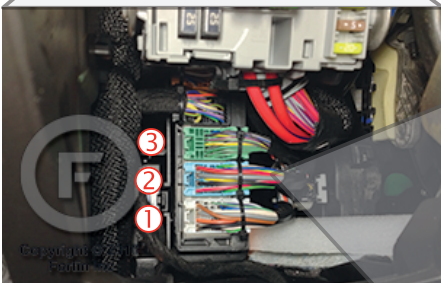
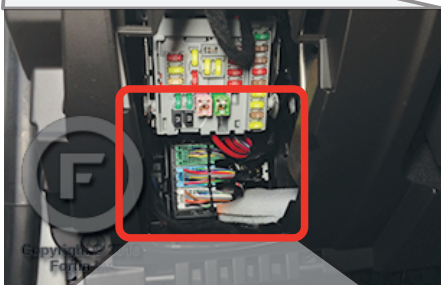

AUTOMATIC TRANSMISSION WIRING CONNECTION

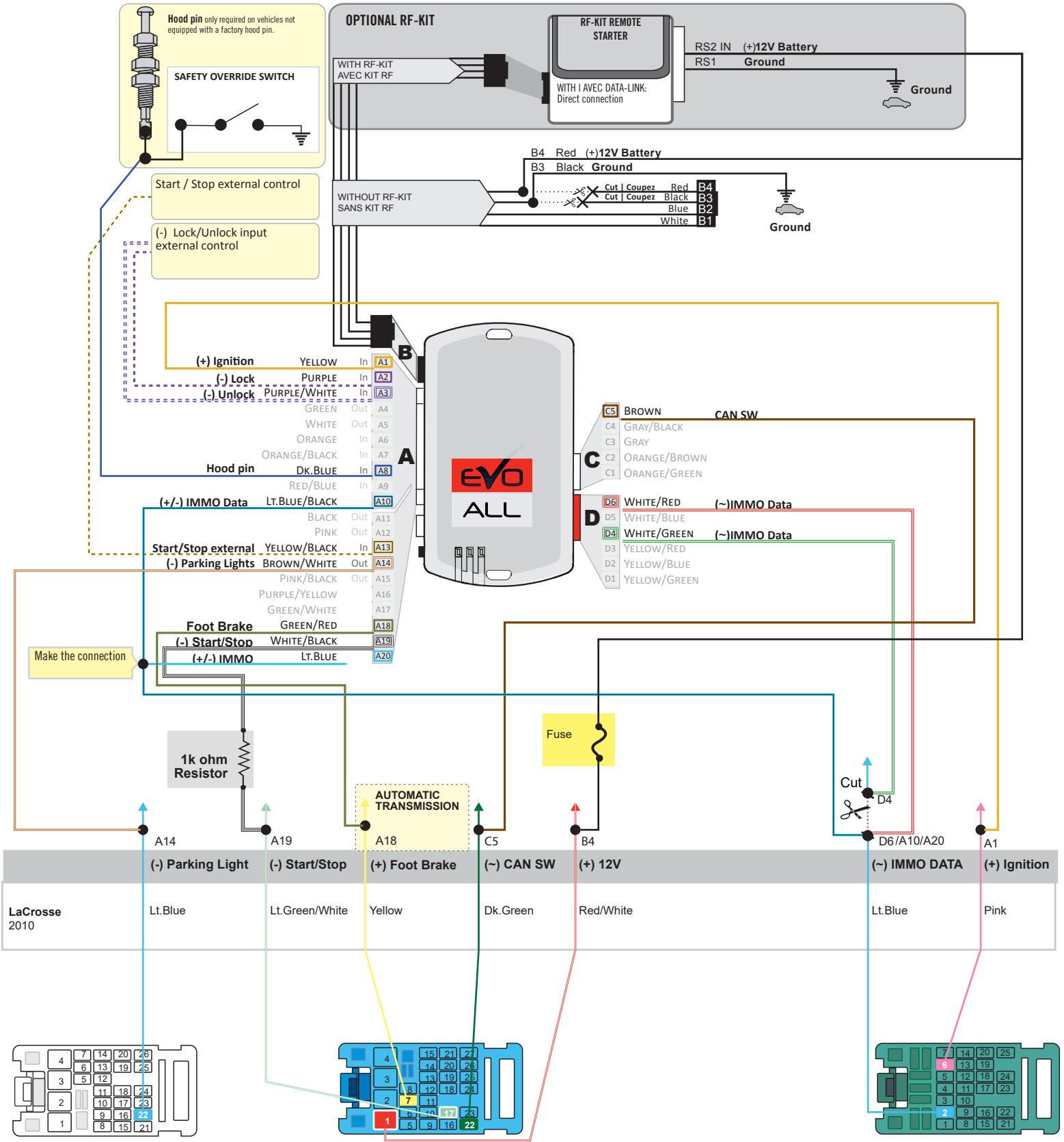

① Back view, 26-Pin White connector, at BCM.

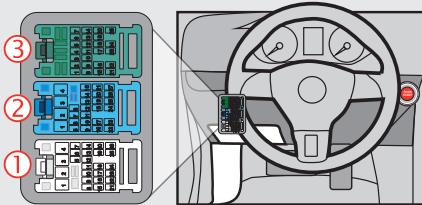

② Back view, 27-Pin Blue connector, at BCM.

③ Back view, 25-Pin Green connector, at BCM.

THAR-GM6 | AUTOMATIC TRANSMISSION CONNECTION

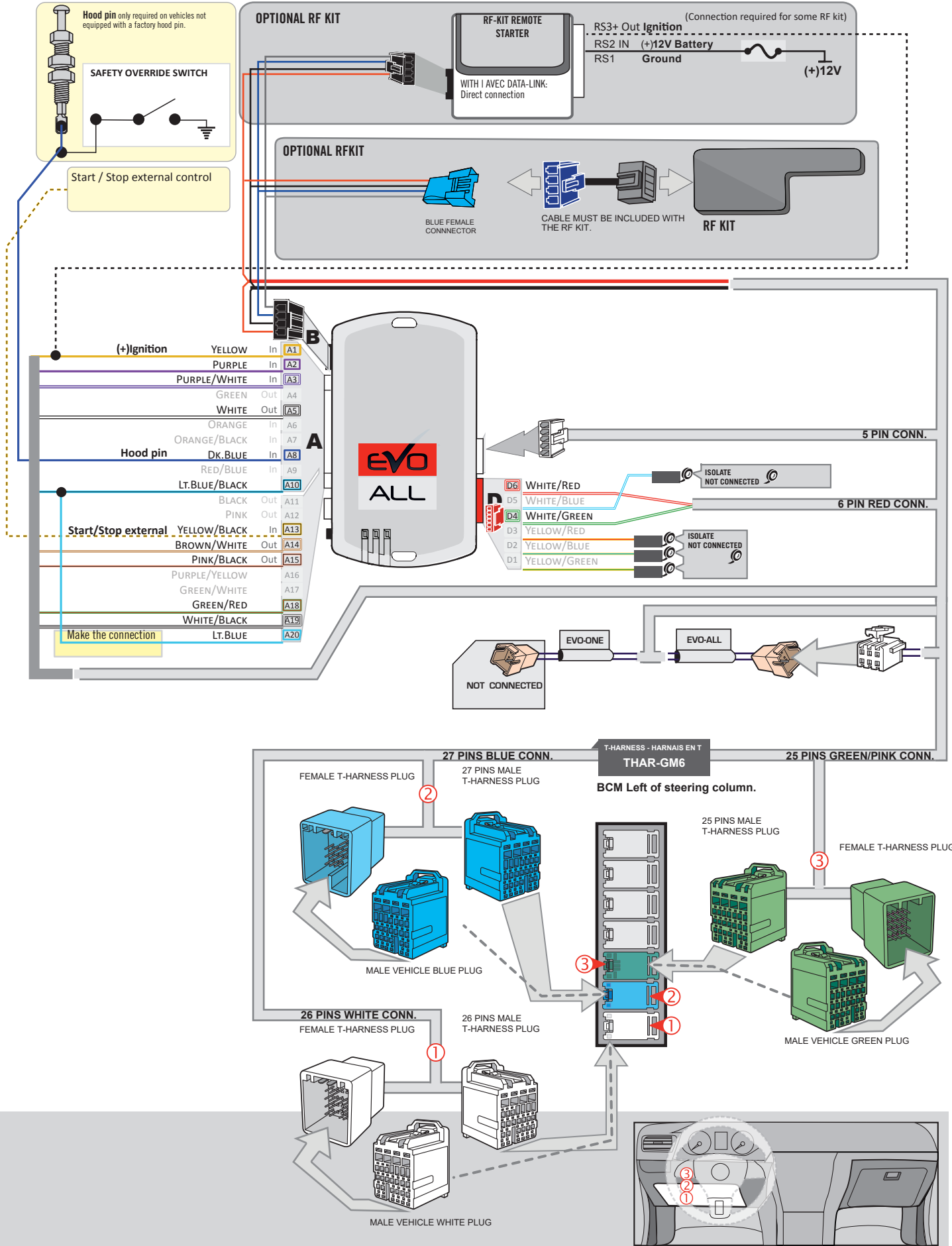

KEY BYPASS PROGRAMMING PROCEDURE 1/3

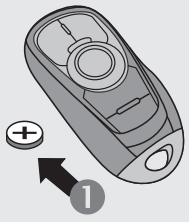

1 Remove the battery from the OEM remote.

2 Place the OEM remote into the transmitter pocket of the center console.

Refer to vehicle user guide for keyport location.

Retire

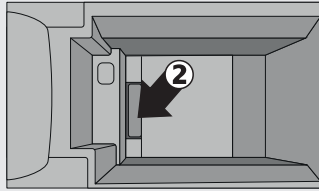

1

x1 HOLD

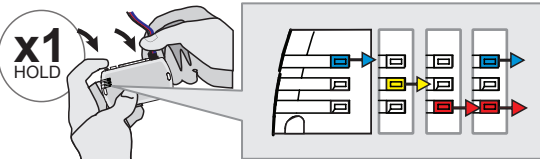

Press and hold the programming button:
Connect the 4-PIN Data-link harness (Black connector).

↳The Blue, Red, Yellow and Blue & Red LEDs will alternatively illuminate.

2

RELEASE

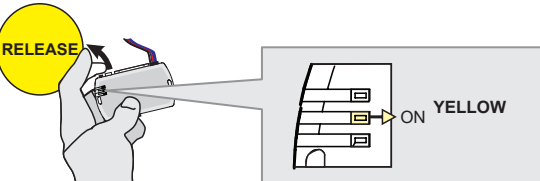

Release the programming button when the LED is **YELLOW**.

If the LED is not solid YELLOW disconnect the 4-Pin connector (Data-Link) and go back to step 1.

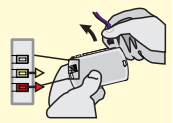

3

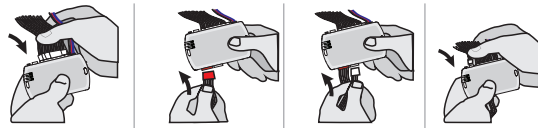

Insert the required remaining connectors.

4

x5 PRESS

PRESS X5 → FLASH

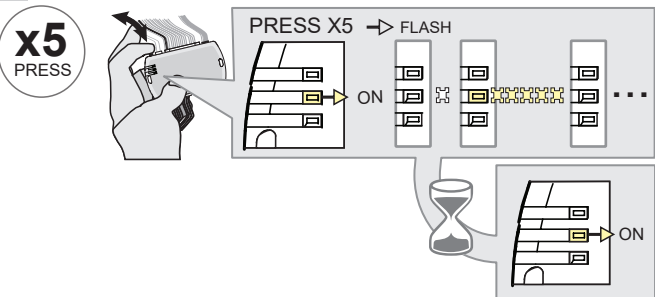

Press and release the programming button five (5x) times.

↳The **YELLOW LED** will flash 5 times each second.

↳**WAIT** for the **YELLOW LED** to turn ON solide.

5

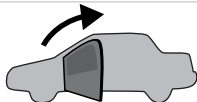

Open the driver door.

6

x1 PRESS

HOLD

RELEASE

START

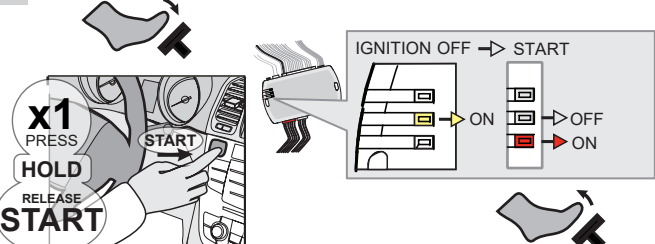

Press the foot-brake pedal.

Press the Push-to-Start button until the engine start.

Release the foot-brake pedal.

↳The **RED LED** will turn ON.
 ↳The **YELLOW LED** will turn OFF.

KEY BYPASS PROGRAMMING PROCEDURE 2/3

7



Press the Push-to-Start button until the engine turn OFF.

8

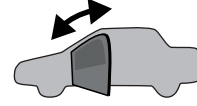

Close and open the driver door.

9

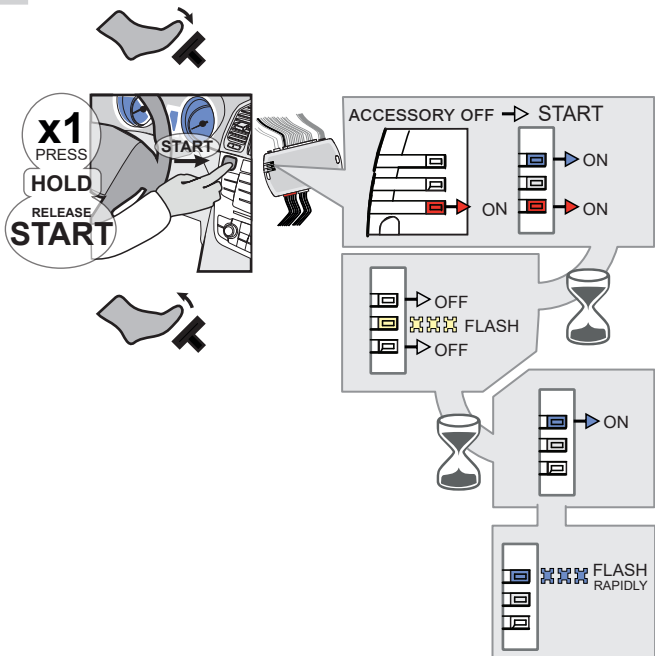

Press the foot-brake pedal.

Press the Push-to-Start button until the engine start.

Release the foot-brake pedal.

- ↳ The BLUE LED will turn ON.
- ↳ The BLUE LED will turn OFF. The RED LED will turn OFF.
- ↳ The YELLOW LED will flash rapidly
- ↳ The BLUE LED will turn ON.
- ↳ The BLUE LED will flash rapidly

10

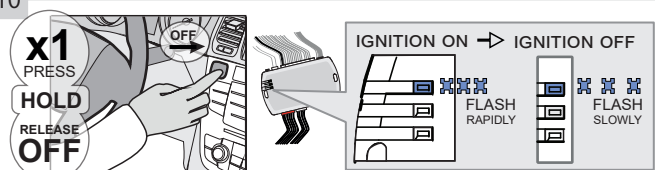

Press the Push-to-Start button until the engine turn OFF.

- ↳ The BLUE LED will flash slowly

11

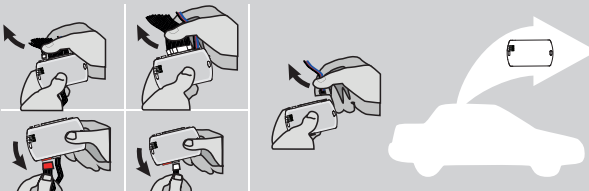

Disconnect all the connectors and after the Data-Link (4-pins) connector.

12

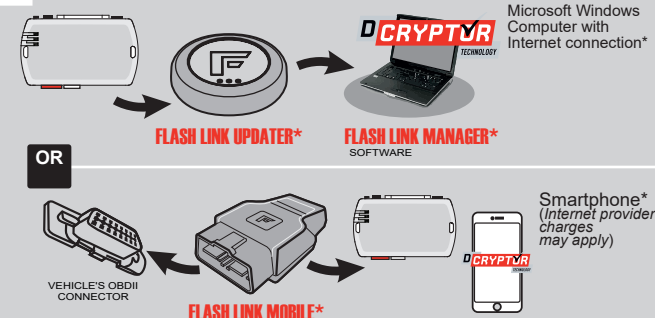

Microsoft Windows Computer with Internet connection*

FLASH LINK UPDATER* **FLASH LINK MANAGER*** SOFTWARE

OR

VEHICLE'S OBDII CONNECTOR **FLASH LINK MOBILE*** Smartphone* (Internet provider charges may apply)

Use the tool: FLASH LINK UPDATER or FLASH LINK MOBILE to visit the DCRYPTOR menu.

*Parts required (not included)

KEY BYPASS PROGRAMMING PROCEDURE 3/3

13

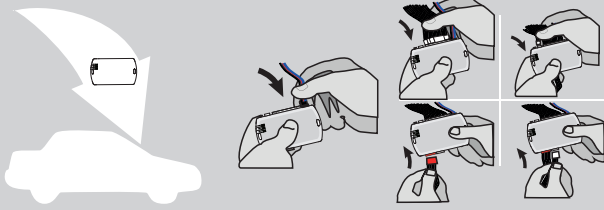

AFTER DCRYPTOR PROGRAMMING COMPLETED
Go back to the vehicle and **reconnect** the 4-Pin (Data-Link) connector and after, all the remaining connector.



The module is now programmed.



REMOTE STARTER / ALARM VERIFICATION PROCEDURE

Test the remote starter. **Remote start** the vehicle.

REMOTE STARTER FUNCTIONALITY



All doors must be closed.



Remote start the vehicle.



Unlock the doors with either:

- The OEM remote
- The remote-starter remote
- Or the proximity remote



Enter the vehicle with the Intelligent Key.



The vehicle can now be put in to gear and driven.

If the vehicle is not unlocked with one of these conditions the remote-starter will shut down as soon as any door is opened.



**STAND ALONE INSTALLATION AND THAR-GM6
INSTALLATION**

ADDENDUM - SUGGESTED WIRING CONFIGURATION



ONLY COMPATIBLE WITH AUTOMATIC TRANSMISSION VEHICLES.



VEHICLE

YEARS

Vehicle functions supported in this diagram (functional if equipped)

VEHICLE	YEARS	Immobilizer bypass	Lock	Unlock	Arm	Disarm	Parking Light	Trunk (open)	RAP Disable	Tachometer	Door Status	Trunk Status	Hand-Brake Status	Foot-Brake Status	OEM Remote Monitoring
BUICK															
LaCrosse	Push-To-Start	2011-2013	•	•	•	•	•	•	•	•	•	•	•	•	•



FIRMWARE VERSION

70.[41]

GM MINIMUM

To add the firmware version and the options, use the **FLASH LINK UPDATER** or **FLASH LINK MOBILE** tool, sold separately.

IF THE VEHICLE IS NOT EQUIPPED WITH FUNCTIONAL HOOD PIN:

A11

OFF

Hood trigger (Output Status).



Program bypass option:

UNIT OPTION

DESCRIPTION

C1

OEM Remote status (Lock/Unlock) monitoring

D6

Push-to-Start



ATTENTION!

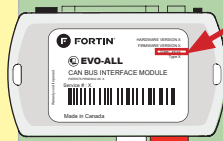

DATE: XX-XX

E5

OFF

SPECIAL FUNCTIONS: BY DEFAULT DEACTIVATED

ON

MANUFACTURED MODULES BETWEEN: 04/2018 TO 04/2019

MANDATORY INSTALL

*HOOD PIN



HOOD STATUS: THE HOOD PIN SWITCH MUST BE INSTALLED IF THE VEHICLE CAN BE REMOTE STARTED WITH THE HOOD OPEN, SET FUNCTION **A11** TO OFF.

A11

OFF

Notice: the installation of safety elements are mandatory. The hood pin is an essential security element and must be installed.

THIS MODULE MUST BE INSTALLED BY A QUALIFIED TECHNICIAN. A WRONG CONNECTION CAN CAUSE PERMANENT DAMAGE TO THE VEHICLE.

PARTS REQUIRED (NOT INCLUDED)

1x **FLASH LINK UPDATER**
 1x **FLASH LINK MANAGER**
 SOFTWARE
 1x Microsoft Windows Computer with Internet connection

OR

1x **FLASH LINK MOBILE**
 1x **FLASH LINK MOBILE APP**
 Smartphone *Android* or *iOS* with Internet connection (*provider charges may apply*).
 1x

MANDATORY

HOOD PIN



REMOTE START SAFETY OVERRIDE SWITCH

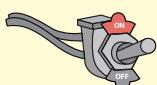





VALET SWITCH

Part #: RSPB available, Sold separately.

Notice: the installation of safety elements are mandatory. The hood pin and the valet switch are essential security elements and must be installed.

STAND ALONE CONFIGURATION

	Program bypass option	UNIT OPTION	DESCRIPTION
	OEM Remote Stand Alone Remote Starter:	D1.10 	By default, LOCK, LOCK, LOCK Par défaut, VERROUILLE,VERROUILLE,VERROUILLE
		D1.1 	
	Program bypass option with oem remote:	C1	OEM Remote Monitoring
	Program bypass option with RF KIT antenna:	H1 to H6	Supported RF Kits and select RF Kit

REMOTE STARTER FUNCTIONALITY



All doors must be closed.

3X 

Press the OEM remote's Lock button 3x to remote-start (or remote-stop) the vehicle.



START 

The vehicle will START.

REMOTE STARTER DIAGNOSTICS
MODULE RED LED

x2 flash :	Brake ON
x3 flash :	No tach
x4 flash :	Ignition before start
x5 flash :	Hood Open

REMOTE STARTER WARNING CARD



CUT THIS WARNING CARD AND STICK IT ON A VISIBLE PLACE:
 or use the package **RSPB**, Sold separately.

WARNING | ATTENTION



REMOTE STARTER

THE VEHICLE CAN BE STARTED BY EITHER: PRESSING THE LOCK BUTTON ON THE OEM REMOTE 3 TIMES CONSECUTIVELY OR BY A SMARTPHONE. **TURN ON** THE SAFETY SWITCH LOCATED UNDER THE DASHBOARD BEFORE WORKING ON THE VEHICLE.

DESCRIPTION

Parts required (Not included) PAGE

WIRE TO WIRE DIAGRAM

	1X 5 Amp Fuse 1X 1k Ohm Resistor	Page 4
--	-------------------------------------	--------

THARNESS DIAGRAM

THARNESS THAR-GM6	1x THAR-GM6	Page 5
-------------------	-------------	--------

BCM

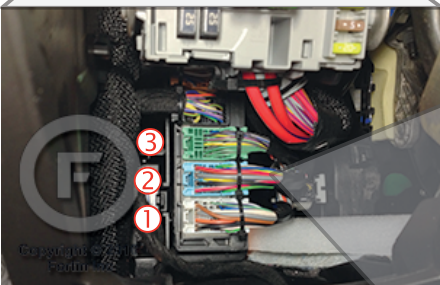
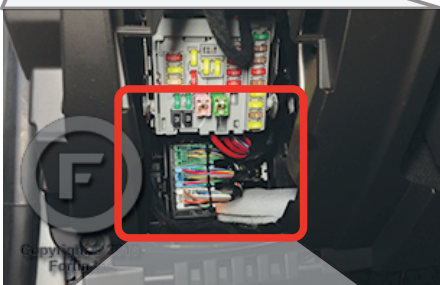
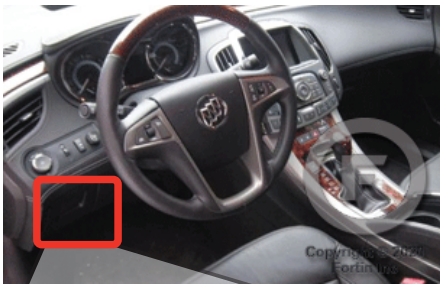

LaCrosse
2011-2013

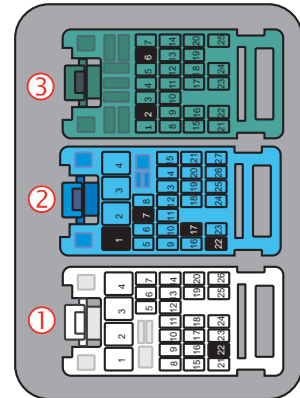
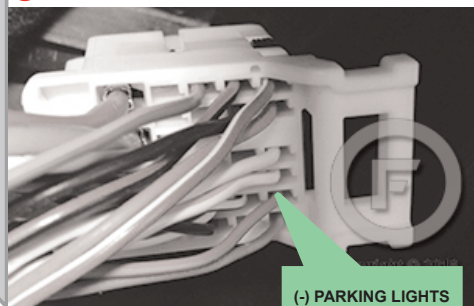
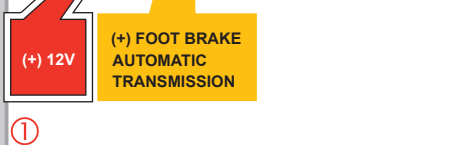
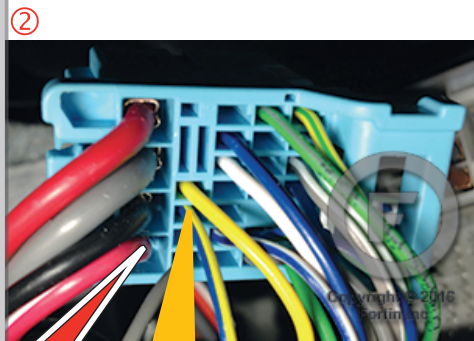
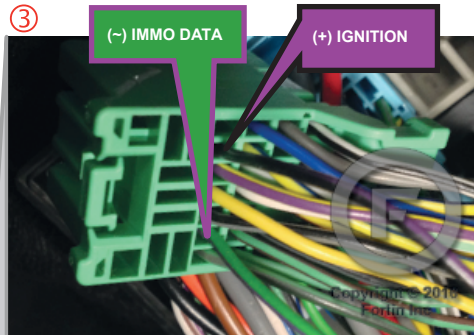

AUTOMATIC TRANSMISSION WIRING CONNECTION

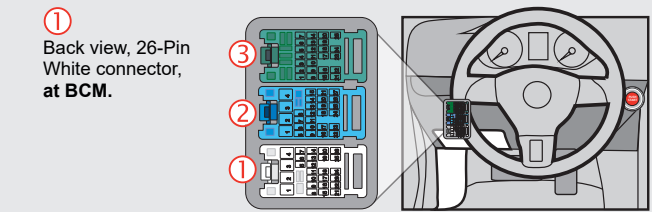
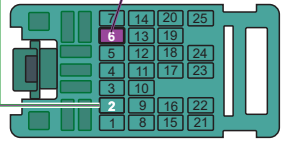
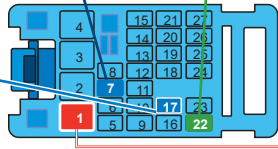
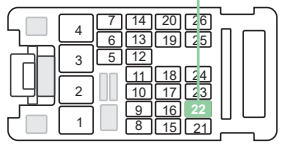
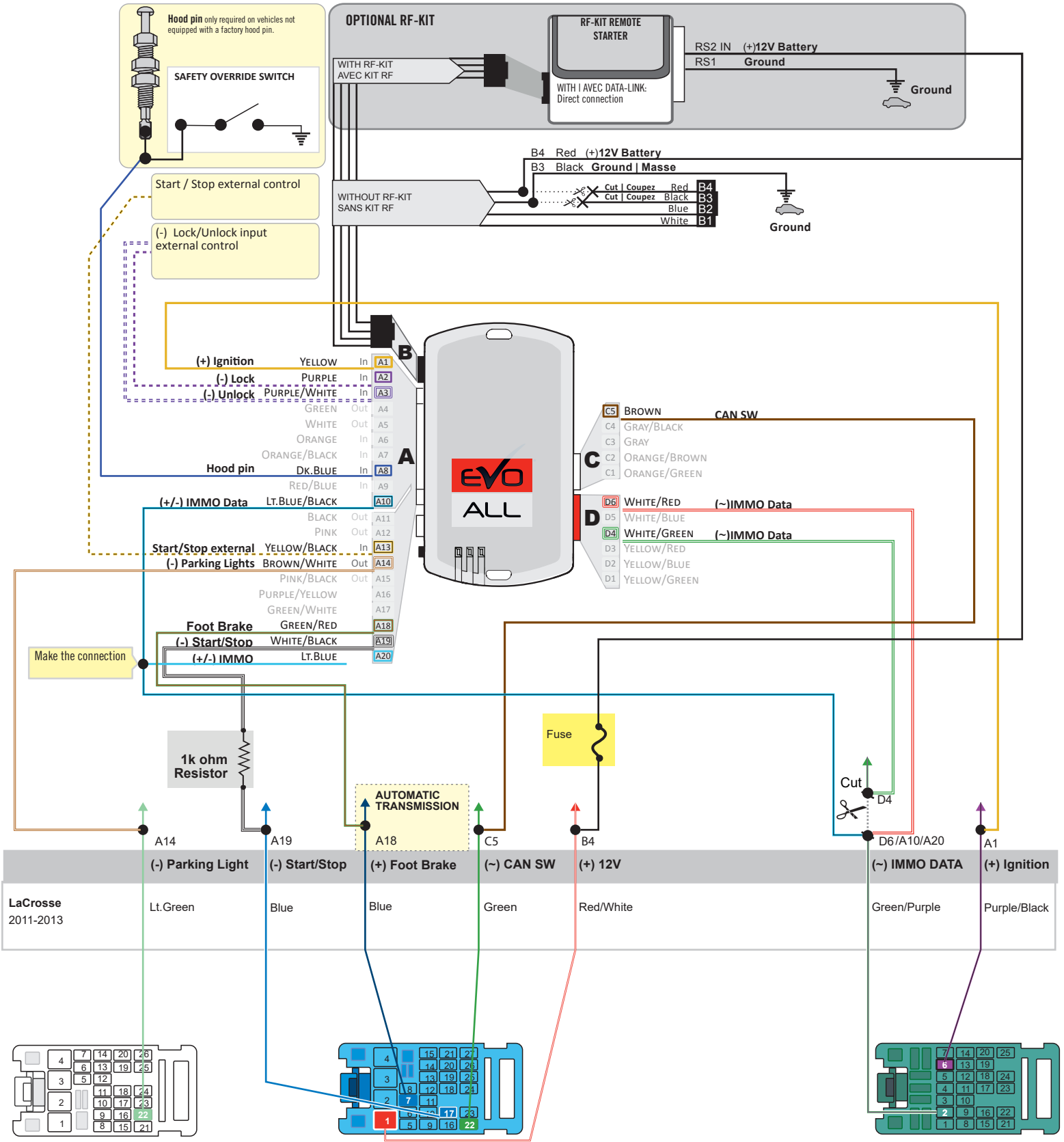

① Back view, 26-Pin White connector, at BCM.

② Back view, 27-Pin Blue connector, at BCM.

③ Back view, 25-Pin Green connector, at BCM.

THAR-GM6 | AUTOMATIC TRANSMISSION CONNECTION

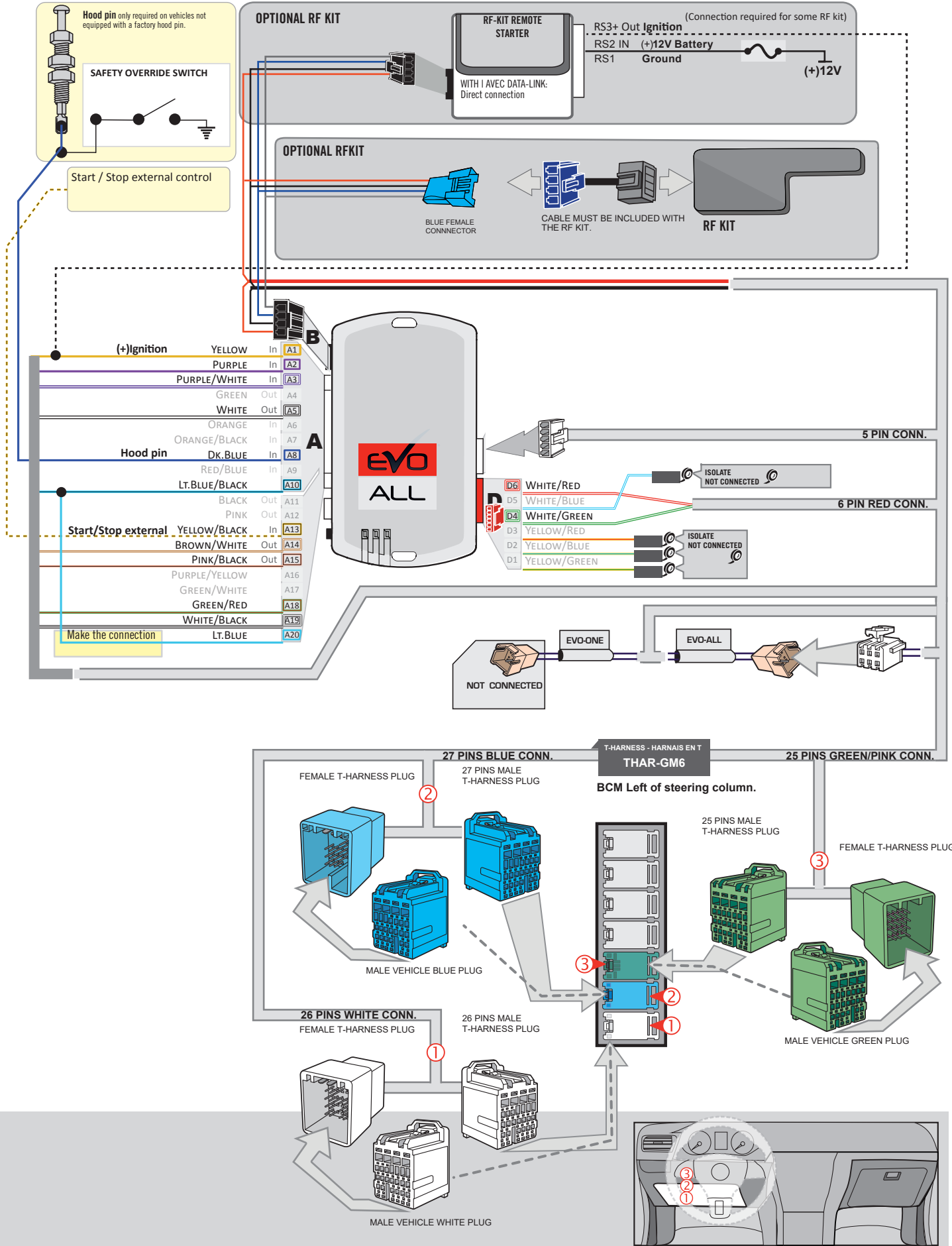

KEY BYPASS PROGRAMMING PROCEDURE 1/3

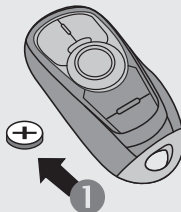

1 Remove the battery from the OEM remote.

2 Place the OEM remote into the transmitter pocket of the center console.

Refer to vehicle user guide for keyport location.

Retire

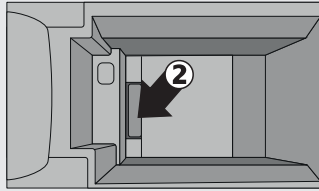

1

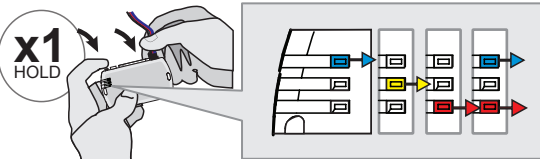

Press and hold the programming button:
Connect the 4-PIN Data-link harness (Black connector).

↳The Blue, Red, Yellow and Blue & Red LEDs will alternatively illuminate.

2

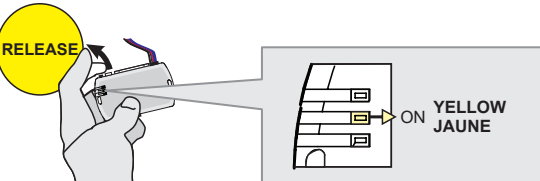

Release the programming button when the LED is **YELLOW**.

If the LED is not solid YELLOW disconnect the 4-Pin connector (Data-Link) and go back to step 1.

3

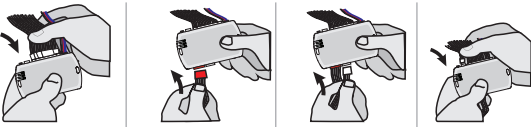

Insert the required remaining connectors.

4

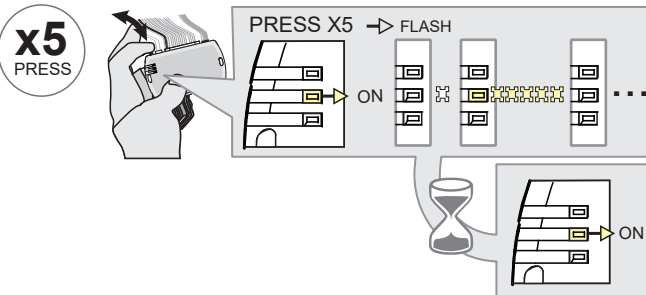

Press and release the programming button five (5x) times.

↳The YELLOW LED will flash 5 times each second.

↳WAIT for the YELLOW LED to turn ON solide.

5

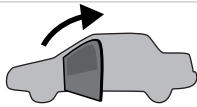

Open the driver door.

6

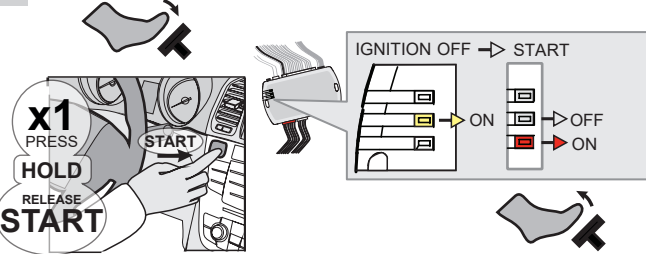

Press the foot-brake pedal.

Press the Push-to-Start button until the engine start.

Release the foot-brake pedal.

↳The RED LED will turn ON.
↳The YELLOW LED will turn OFF.

KEY BYPASS PROGRAMMING PROCEDURE 2/3

7



Press the Push-to-Start button until the engine turn OFF.

8

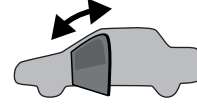

Close and open the driver door.

9

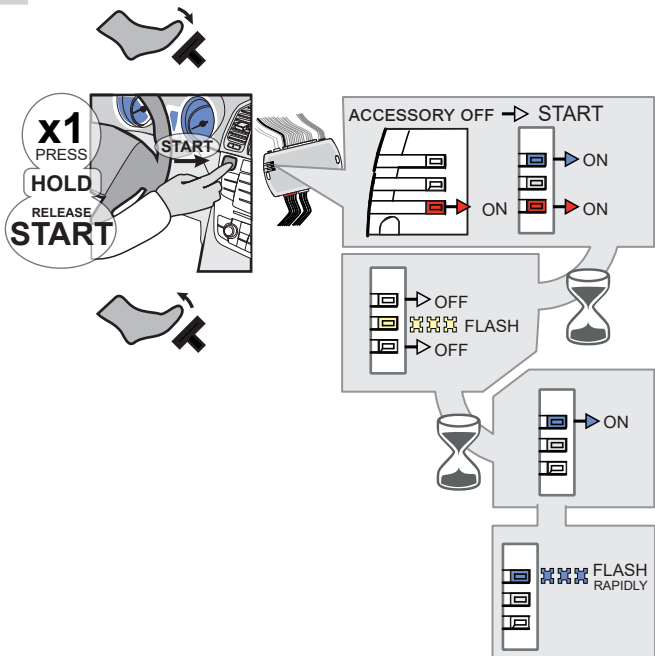
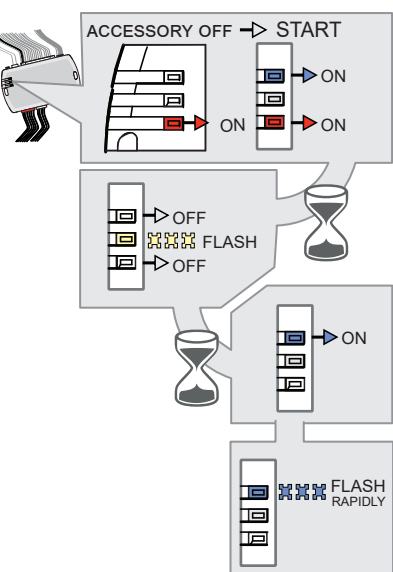
Press the foot-brake pedal.

Press the Push-to-Start button until the engine start.

Release the foot-brake pedal.

- ↳ The BLUE LED will turn ON.
- ↳ The BLUE LED will turn OFF. The RED LED will turn OFF.
- ↳ The YELLOW LED will flash rapidly
- ↳ The BLUE LED will turn ON.
- ↳ The BLUE LED will flash rapidly

10

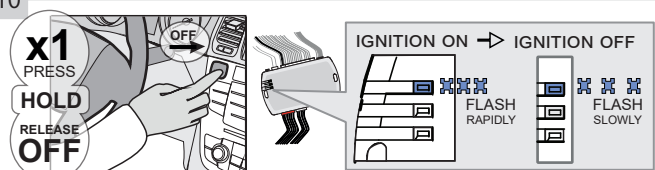
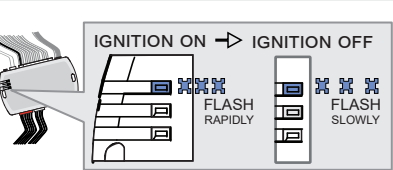
Press the Push-to-Start button until the engine turn OFF.

- ↳ The BLUE LED will flash slowly

11

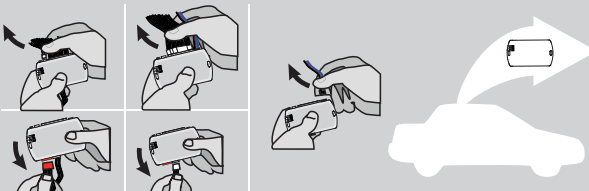

Disconnect all the connectors and after the Data-Link (4-pins) connector.

12

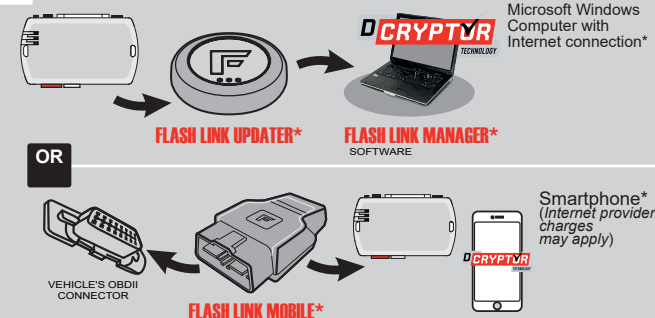

Use the tool: FLASH LINK UPDATER or FLASH LINK MOBILE to visit the DCRYPTOR menu.

*Parts required (not included)

KEY BYPASS PROGRAMMING PROCEDURE 3/3

13

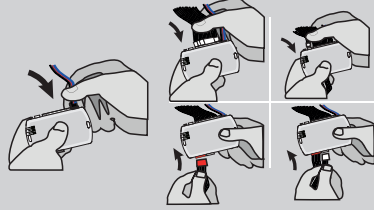
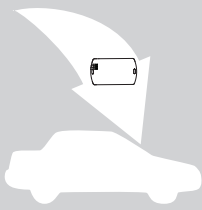

AFTER DCRYPTOR PROGRAMMING COMPLETED
Go back to the vehicle and **reconnect** the 4-Pin (Data-Link) connector and after, all the remaining connector.



The module is now programmed.



REMOTE STARTER / ALARM VERIFICATION PROCEDURE

Test the remote starter. **Remote start** the vehicle.

REMOTE STARTER FUNCTIONALITY



All doors must be closed.



Remote start the vehicle.



Unlock the doors with either:

- The OEM remote
- The remote-starter remote
- Or the proximity remote

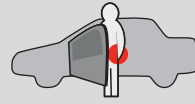

Enter the vehicle with the Intelligent Key.



The vehicle can now be put in to gear and driven.

If the vehicle is not unlocked with one of these conditions the remote-starter will shut down as soon as any door is opened.



**STAND ALONE INSTALLATION AND THAR-GM6
INSTALLATION**

ADDENDUM - SUGGESTED WIRING CONFIGURATION



ONLY COMPATIBLE WITH AUTOMATIC TRANSMISSION VEHICLES.



VEHICLE

YEARS

Vehicle functions supported in this diagram (functional if equipped)

BUICK

LaCrosse

Push-To-Start

2014

Immobilizer bypass

Lock

Unlock

Arm

Disarm

Parking Light

Trunk (open)

RAP Disable

Tachometer

Door Status

Trunk Status

Hand-Brake Status

Foot-Brake Status

OEM Remote Monitoring

•

•

•

•

•

•

•

•

•

•

•

•

•

•



FIRMWARE VERSION

70.[41]

GM MINIMUM

To add the firmware version and the options use the **FLASH LINK UPDATER** or **FLASH LINK MOBILE** tool, sold separately.

IF THE VEHICLE IS NOT EQUIPPED WITH FUNCTIONAL HOOD PIN:

A11

OFF

Hood trigger (Output Status).



Program bypass option:

UNIT OPTION

DESCRIPTION

C1

OEM Remote status (Lock/Unlock) monitoring

D6

Push-to-Start



ATTENTION!

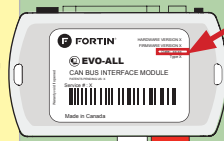

DATE: XX-XX

E5

OFF

SPECIAL FUNCTIONS: BY DEFAULT DEACTIVATED

ON

MANUFACTURED MODULES BETWEEN: 04/2018 TO 04/2019

MANDATORY INSTALL

*HOOD PIN



HOOD STATUS: THE HOOD PIN SWITCH MUST BE INSTALLED IF THE VEHICLE CAN BE REMOTE STARTED WITH THE HOOD OPEN, SET FUNCTION **A11** TO OFF.

A11

OFF

Notice: the installation of safety elements are mandatory. The hood pin is an essential security element and must be installed.

THIS MODULE MUST BE INSTALLED BY A QUALIFIED TECHNICIAN. A WRONG CONNECTION CAN CAUSE PERMANENT DAMAGE TO THE VEHICLE.

PARTS REQUIRED (NOT INCLUDED)

1x **FLASH LINK UPDATER**
 1x **FLASH LINK MANAGER**
 SOFTWARE | PROGRAMME
 1x Microsoft Windows Computer with Internet connection

OR

1x **FLASH LINK MOBILE**
 1x **FLASH LINK MOBILE APP**
 Smartphone *Android* or *iOS* with Internet connection (*provider charges may apply*).
 1x

MANDATORY

HOOD PIN



REMOTE START SAFETY OVERRIDE SWITCH

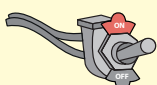





VALET SWITCH

Part #: RSPB available, Sold separately.

Notice: the installation of safety elements are mandatory. The hood pin and the valet switch are essential security elements and must be installed.

STAND ALONE CONFIGURATION

	Program bypass option	UNIT OPTION	DESCRIPTION
	OEM Remote Stand Alone Remote Starter:	D1.10 	By default, LOCK, LOCK, LOCK Par défaut, VERROUILLE,VERROUILLE,VERROUILLE
		D1.1 	
	Program bypass option with oem remote:	C1	OEM Remote Monitoring
	Program bypass option with RF KIT antenna:	H1 to H6	Supported RF Kits and select RF Kit

REMOTE STARTER FUNCTIONALITY



All doors must be closed.

3X 

Press the OEM remote's Lock button 3x to remote-start (or remote-stop) the vehicle.



START

The vehicle will START.

REMOTE STARTER DIAGNOSTICS
MODULE RED LED

x2 flash :	Brake ON
x3 flash :	No tach
x4 flash :	Ignition before start
x5 flash :	Hood Open

REMOTE STARTER WARNING CARD



CUT THIS WARNING CARD AND STICK IT ON A VISIBLE PLACE:
 or use the package **RSPB**, Sold separately.

WARNING



REMOTE STARTER

THE VEHICLE CAN BE STARTED BY EITHER: PRESSING THE LOCK BUTTON ON THE OEM REMOTE 3 TIMES CONSECUTIVELY OR BY A SMARTPHONE. **TURN ON** THE SAFETY SWITCH LOCATED UNDER THE DASHBOARD BEFORE WORKING ON THE VEHICLE.

DESCRIPTION

Parts required (Not included) PAGE

WIRE TO WIRE DIAGRAM

	1X 5 Amp Fuse 1X 1k Ohm Resistor	Page 4
--	-------------------------------------	--------

THARNESSE DIAGRAM

THARNESSE THAR-GM6	1x THAR-GM6	Page 5
--------------------	-------------	--------

BCM

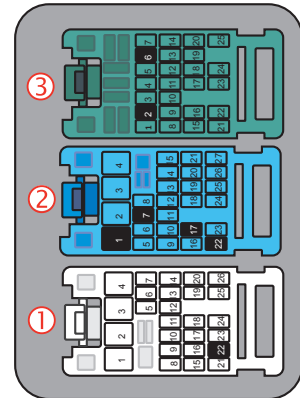
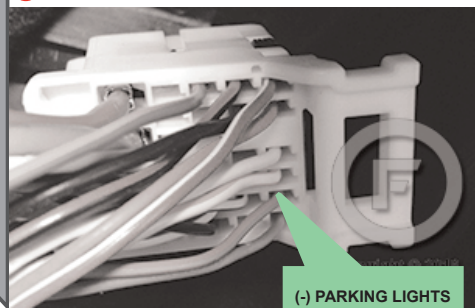
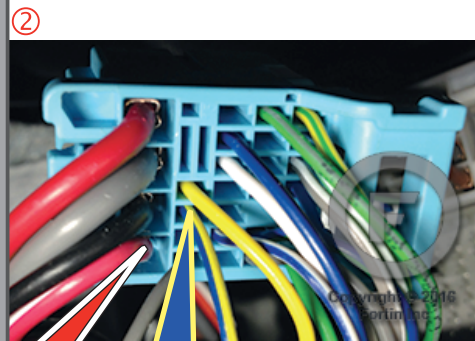
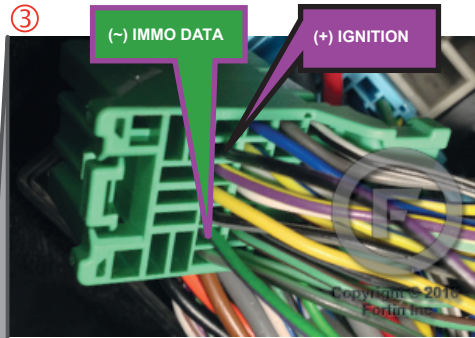
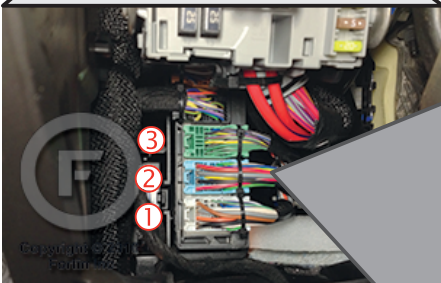
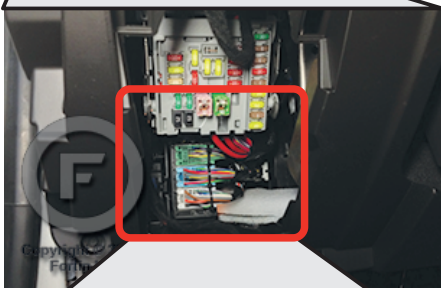

AUTOMATIC TRANSMISSION WIRING CONNECTION

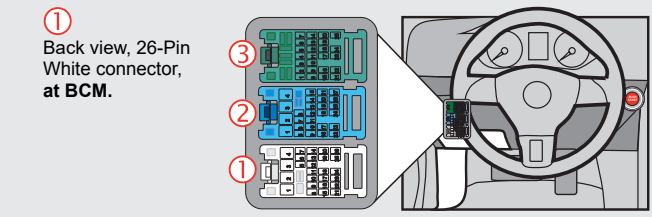
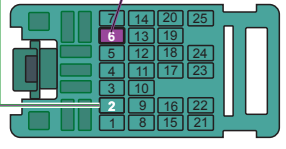
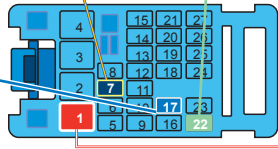
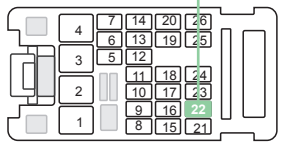
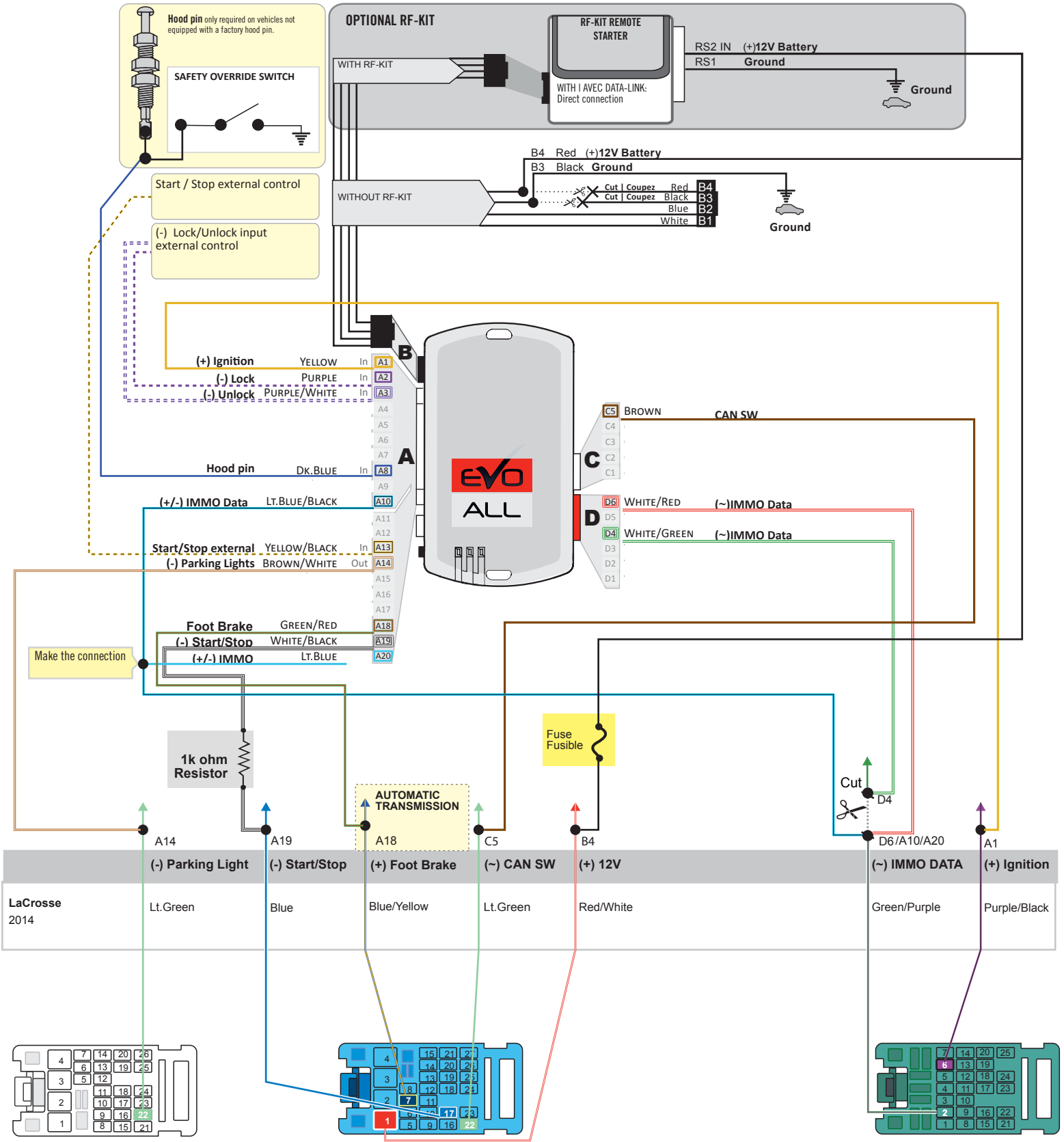

① Back view, 26-Pin White connector, at BCM.

② Back view, 27-Pin Blue connector, at BCM.

③ Back view, 25-Pin Green connector, at BCM.

THAR-GM6 | AUTOMATIC TRANSMISSION CONNECTION

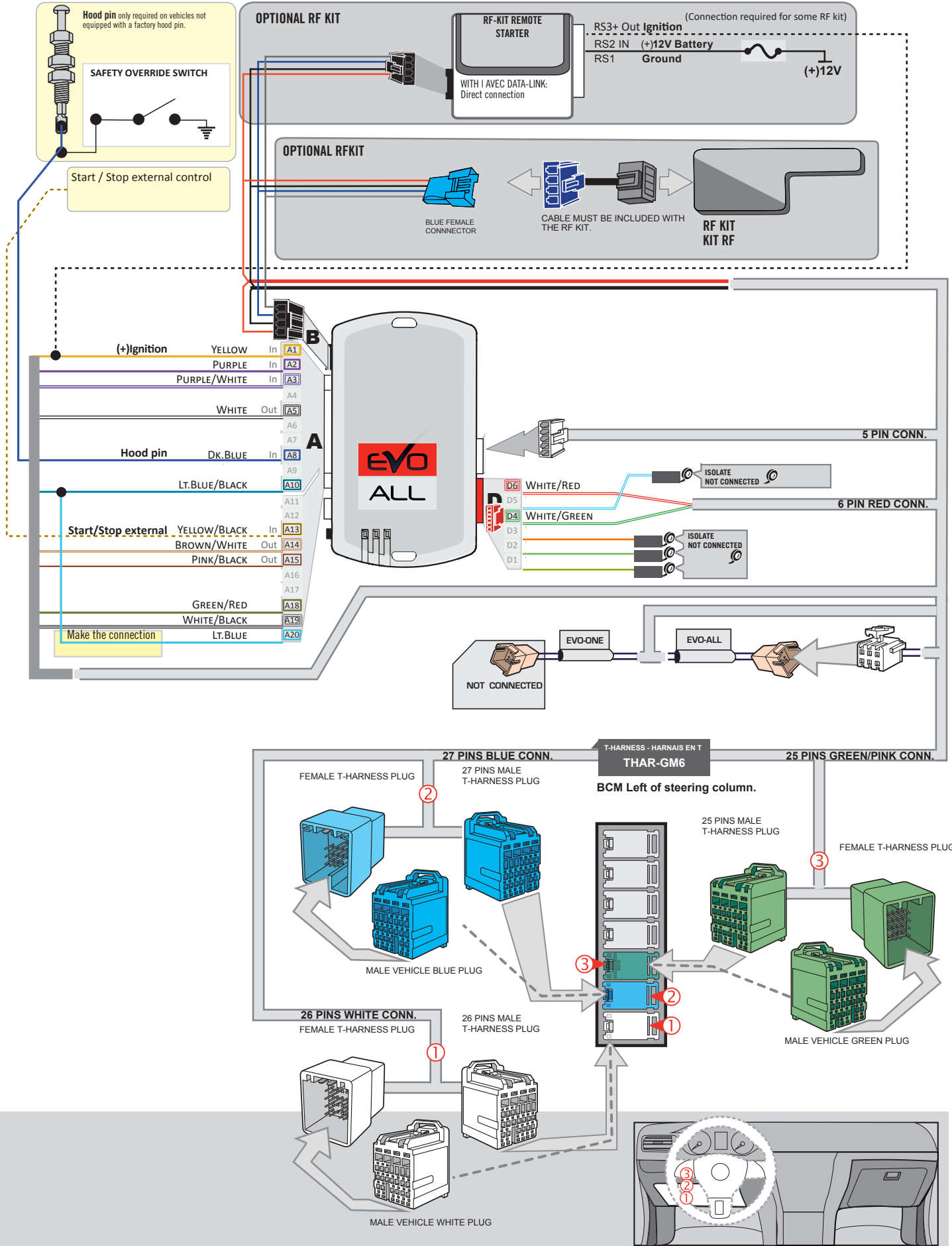

KEY BYPASS PROGRAMMING PROCEDURE 1/3

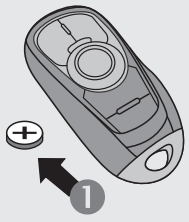

1 Remove the battery from the OEM remote.

2 Place the OEM remote into the transmitter pocket of the center console.

Refer to vehicle user guide for keyport location.

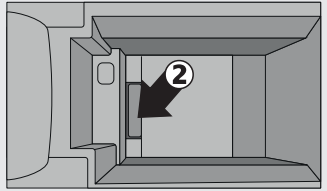

1

x1 HOLD

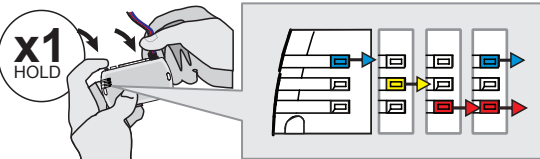

Press and hold the programming button:
Connect the 4-PIN Data-link harness (Black connector).

↳The Blue, Red, Yellow and Blue & Red LEDs will alternatively illuminate.

2

RELEASE

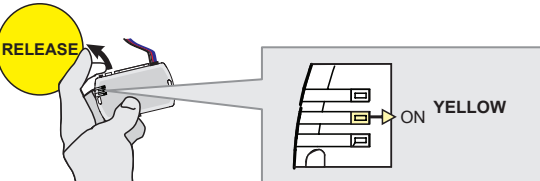

Release the programming button when the LED is **YELLOW**.

If the LED is not solid YELLOW disconnect the 4-Pin connector (Data-Link) and go back to step 1.

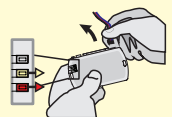

3

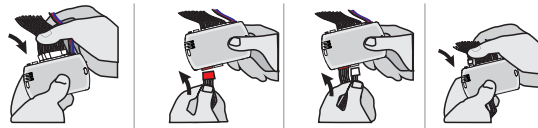

Insert the required remaining connectors.

4

x5 PRESS

PRESS X5 → FLASH

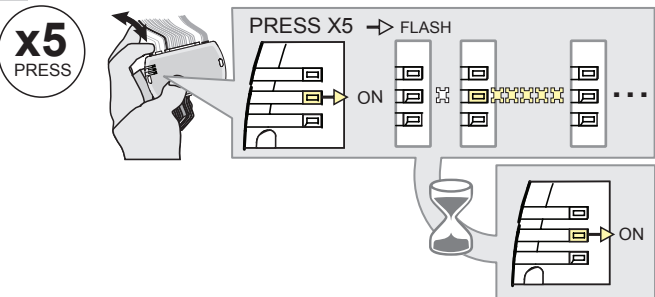

Press and release the programming button five (5x) times.

↳The **YELLOW LED** will flash 5 times each second.

↳**WAIT** for the **YELLOW LED** to turn ON solide.

5

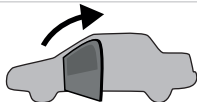

Open the driver door.

6

x1 PRESS HOLD START

RELEASE START

IGNITION OFF → START

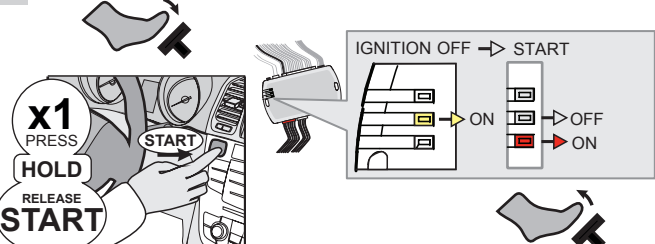

Press the foot-brake pedal.

Press the Push-to-Start button until the engine start.

Release the foot-brake pedal.

↳The **RED LED** will turn ON.
 ↳The **YELLOW LED** will turn OFF.

KEY BYPASS PROGRAMMING PROCEDURE 2/3

7



Press the Push-to-Start button until the engine turn OFF.

8

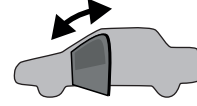

Close and open the driver door.

9

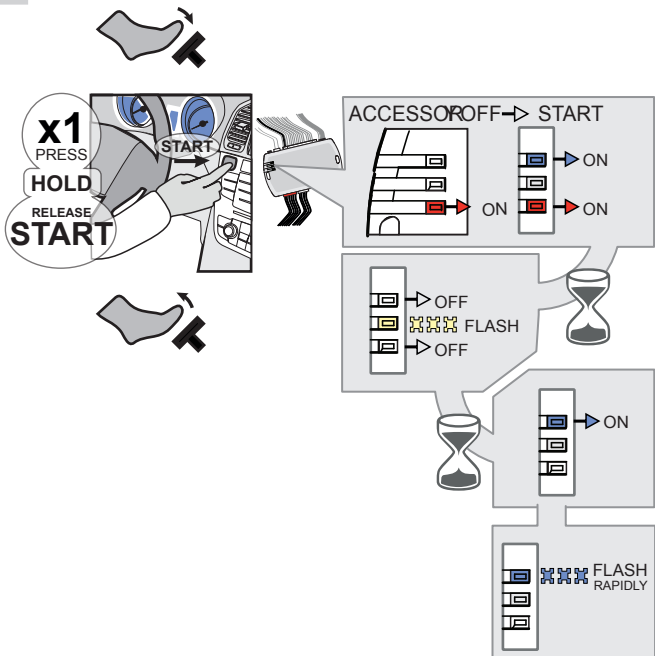

Press the foot-brake pedal.

Press the Push-to-Start button until the engine start.

Release the foot-brake pedal.

- ↳ The BLUE LED will turn ON.
- ↳ The BLUE LED will turn OFF. The RED LED will turn OFF.
- ↳ The YELLOW LED will flash rapidly
- ↳ The BLUE LED will turn ON.
- ↳ The BLUE LED will flash rapidly

10

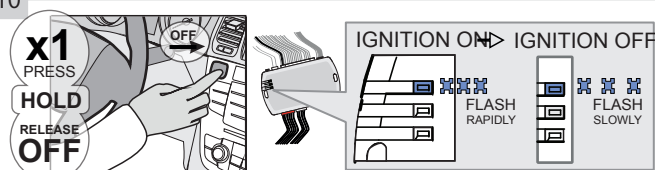

Press the Push-to-Start button until the engine turn OFF.

- ↳ The BLUE LED will flash slowly

11

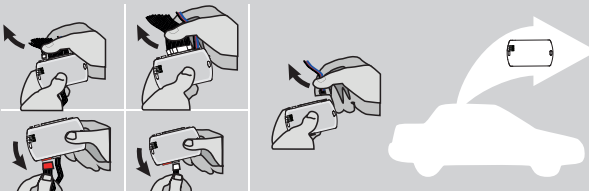

Disconnect all the connectors and after the Data-Link (4-pins) connector.

12

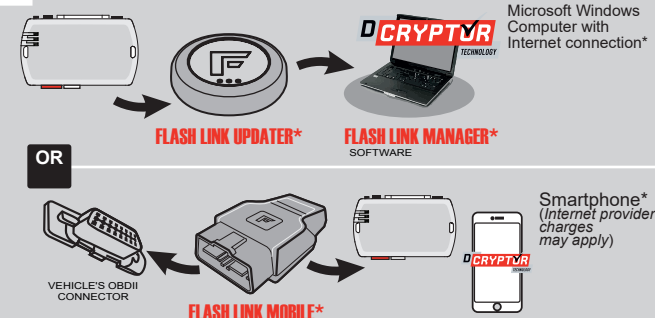

Use the tool: FLASH LINK UPDATER or FLASH LINK MOBILE to visit the DCryptor menu.

***Parts required (not included)**

KEY BYPASS PROGRAMMING PROCEDURE 3/3

13

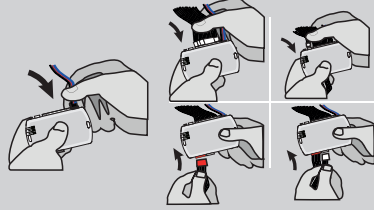
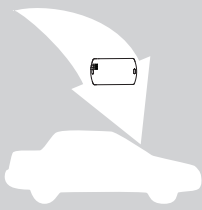

AFTER DCRYPTOR PROGRAMMING COMPLETED
Go back to the vehicle and **reconnect** the 4-Pin (Data-Link) connector and after, all the remaining connector.



The module is now programmed.



REMOTE STARTER / ALARM VERIFICATION PROCEDURE

Test the remote starter. **Remote start** the vehicle.

REMOTE STARTER FUNCTIONALITY



All doors must be closed.



Remote start the vehicle.



Unlock the doors with either:

- The OEM remote
- The remote-starter remote
- Or the proximity remote

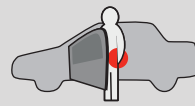

Enter the vehicle with the Intelligent Key.



The vehicle can now be put in to gear and driven.

If the vehicle is not unlocked with one of these conditions the remote-starter will shut down as soon as any door is opened.



**STAND ALONE INSTALLATION AND THAR-GM6
INSTALLATION**

ADDENDUM - SUGGESTED WIRING CONFIGURATION



ONLY COMPATIBLE WITH AUTOMATIC TRANSMISSION VEHICLES.



VEHICLE

YEARS

Vehicle functions supported in this diagram (functional if equipped)

BUICK

LaCrosse

Push-To-Start

2015-2016

Immobilizer bypass

Lock

Unlock

Arm

Disarm

Parking Light

Trunk (open)

RAP Disable

Tachometer

Door Status

Trunk Status

Hand-Brake Status

Foot-Brake Status

OEM Remote Monitoring

•

•

•

•

•

•

•

•

•

•

•

•

•

•



FIRMWARE VERSION

70.[41]

GM MINIMUM

To add the firmware version and the options, use the **FLASH LINK UPDATER** or **FLASH LINK MOBILE** tool, sold separately.

IF THE VEHICLE IS NOT EQUIPPED WITH FUNCTIONAL HOOD PIN:

A11

OFF

Hood trigger (Output Status).



Program bypass option:

UNIT OPTION

DESCRIPTION

C1

OEM Remote status (Lock/Unlock) monitoring

D6

Push-to-Start



ATTENTION!

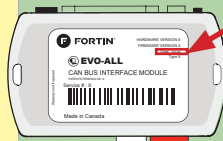

DATE: XX-XX

E5

OFF

SPECIAL FUNCTIONS: BY DEFAULT DEACTIVATED

ON

MANUFACTURED MODULES BETWEEN: 04/2018 TO 04/2019

MANDATORY INSTALL

*HOOD PIN



HOOD STATUS: THE HOOD PIN SWITCH MUST BE INSTALLED IF THE VEHICLE CAN BE REMOTE STARTED WITH THE HOOD OPEN, SET FUNCTION **A11** TO OFF.

A11

OFF

Notice: the installation of safety elements are mandatory. The hood pin is an essential security element and must be installed.

THIS MODULE MUST BE INSTALLED BY A QUALIFIED TECHNICIAN. A WRONG CONNECTION CAN CAUSE PERMANENT DAMAGE TO THE VEHICLE.

PARTS REQUIRED (NOT INCLUDED)

1x **FLASH LINK UPDATER**
 1x **FLASH LINK MANAGER**
 SOFTWARE
 1x Microsoft Windows Computer with Internet connection

OR

1x **FLASH LINK MOBILE**
 1x **FLASH LINK MOBILE APP**
 Smartphone *Android* or *iOS* with Internet connection (*provider charges may apply*).
 1x

MANDATORY

HOOD PIN



REMOTE START SAFETY OVERRIDE SWITCH

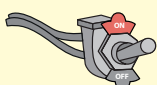





VALET SWITCH

Part #: RSPB available, Sold separately.

Notice: the installation of safety elements are mandatory. The hood pin and the valet switch are essential security elements and must be installed.

STAND ALONE CONFIGURATION

	Program bypass option	UNIT OPTION	DESCRIPTION
	OEM Remote Stand Alone Remote Starter:	D1.10 	By default, LOCK, LOCK, LOCK
		D1.1 	Par défaut, VERROUILLE,VERROUILLE,VERROUILLE
	Program bypass option with oem remote:	C1	OEM Remote Monitoring
	Program bypass option with RF KIT antenna:	H1 to H6	Supported RF Kits and select RF Kit

REMOTE STARTER FUNCTIONALITY



All doors must be closed.

3X 

Press the OEM remote's Lock button 3x to remote-start (or remote-stop) the vehicle.



START 

The vehicle will START.

REMOTE STARTER DIAGNOSTICS
MODULE RED LED

x2 flash :	Brake ON
x3 flash :	No tach
x4 flash :	Ignition before start
x5 flash :	Hood Open

REMOTE STARTER WARNING CARD



CUT THIS WARNING CARD AND STICK IT ON A VISIBLE PLACE:
 or use the package **RSPB**, Sold separately.

WARNING | ATTENTION

REMOTE STARTER

THE VEHICLE CAN BE STARTED BY EITHER: PRESSING THE LOCK BUTTON ON THE OEM REMOTE 3 TIMES CONSECUTIVELY OR BY A SMARTPHONE. **TURN ON** THE SAFETY SWITCH LOCATED UNDER THE DASHBOARD BEFORE WORKING ON THE VEHICLE.

DESCRIPTION

Parts required (Not included) PAGE

WIRE TO WIRE DIAGRAM

	1X 5 Amp Fuse 1X 1k Ohm Resistor	Page 4
--	-------------------------------------	--------

THARNESS DIAGRAM

THARNESS THAR-GM6	1x THAR-GM6	Page 5
-------------------	-------------	--------

BCM

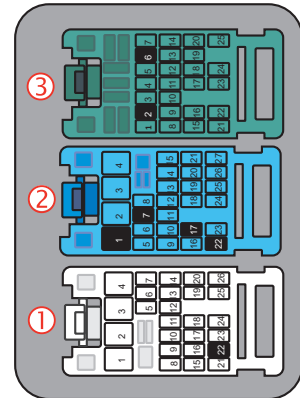
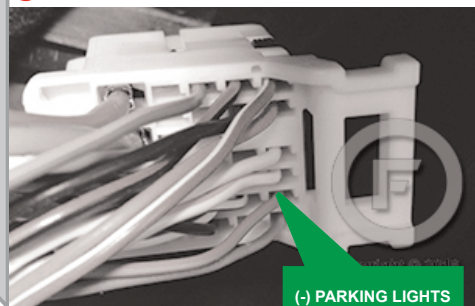
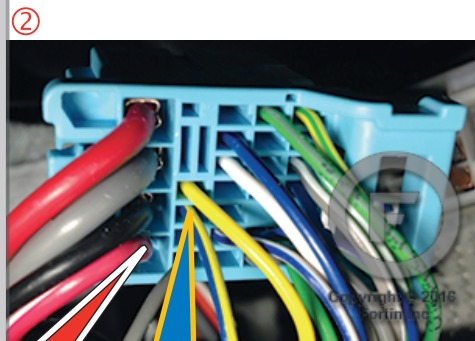
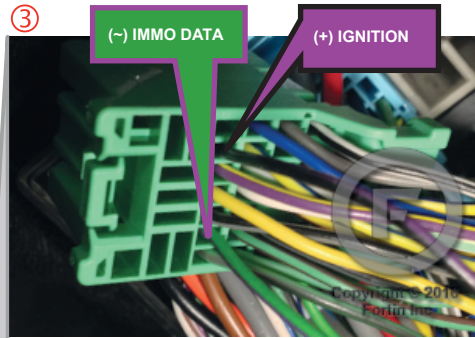
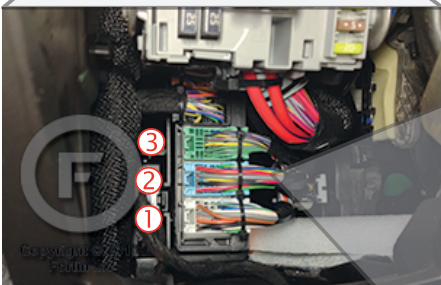

AUTOMATIC TRANSMISSION WIRING CONNECTION

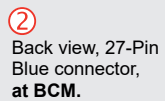
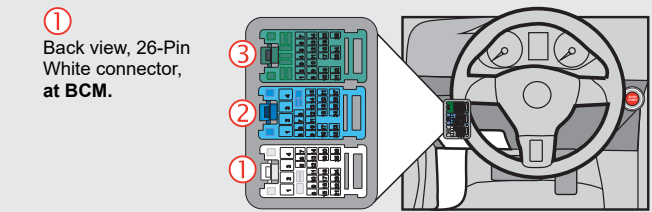
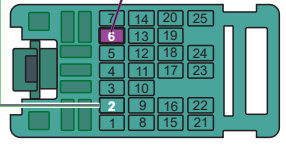
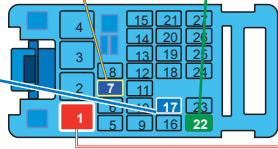
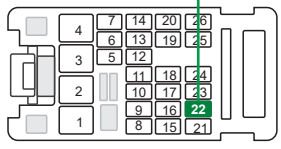
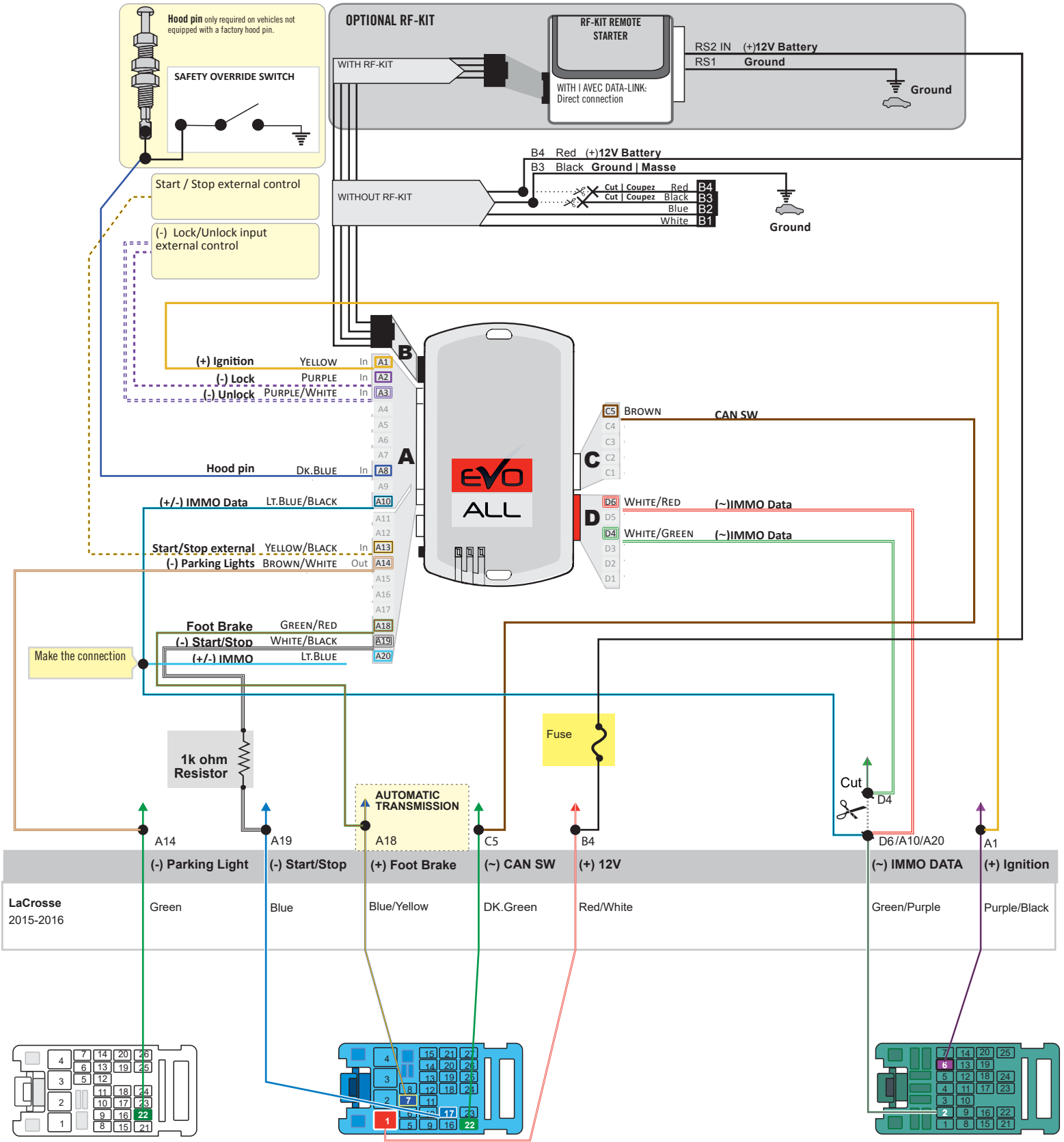

THAR-GM6 | AUTOMATIC TRANSMISSION CONNECTION

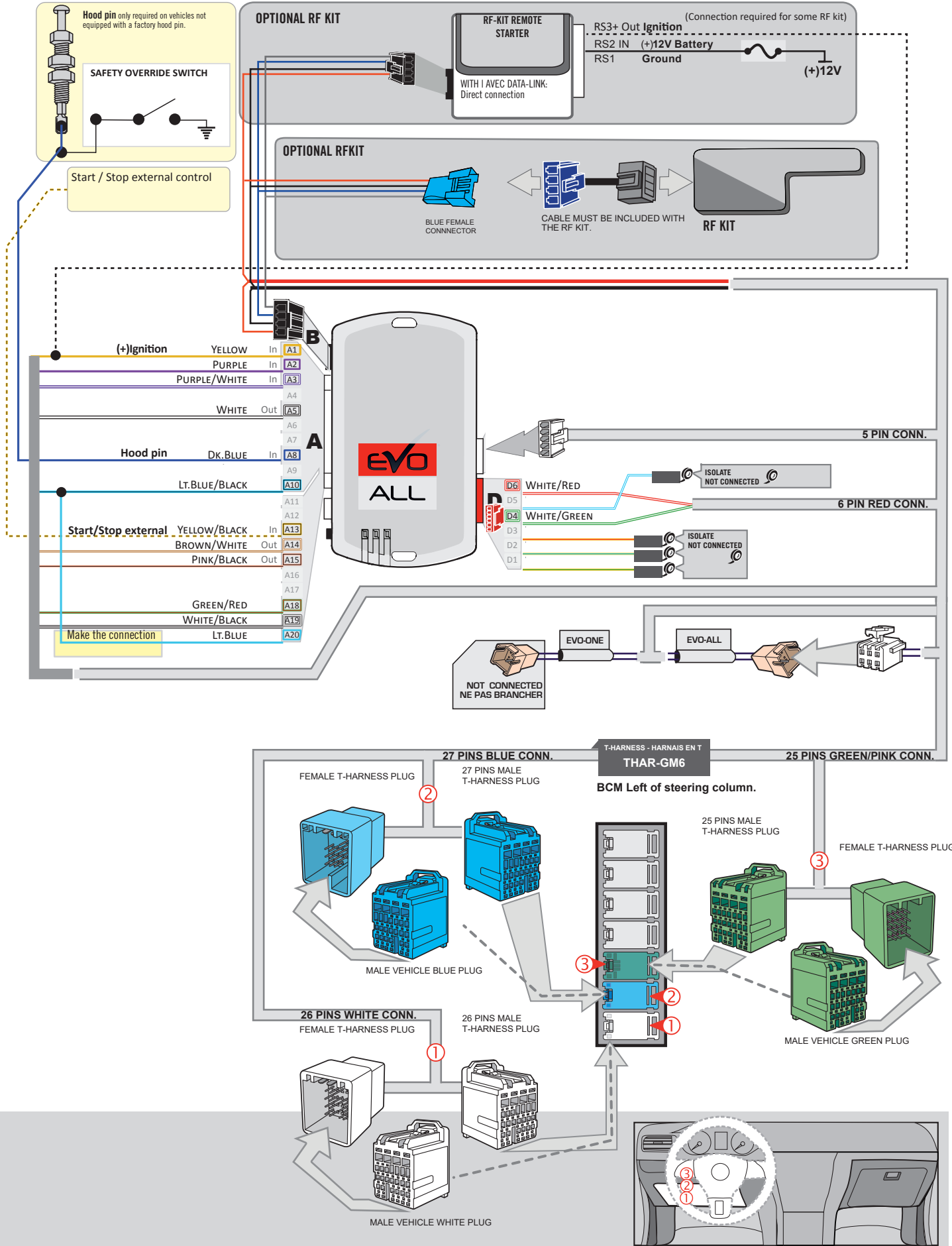

KEY BYPASS PROGRAMMING PROCEDURE 1/3

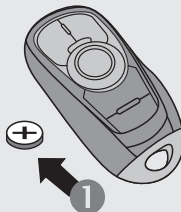

1 Remove the battery from the OEM remote.

2 Place the OEM remote into the transmitter pocket of the center console.

Refer to vehicle user guide for keyport location.

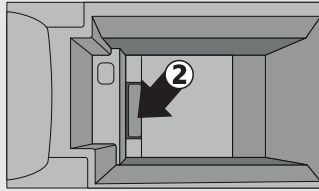

1

x1 HOLD

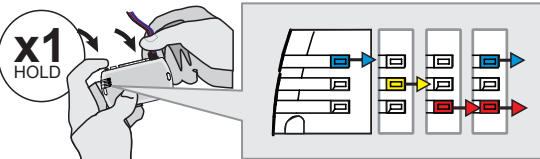

Press and hold the programming button:
Connect the 4-PIN Data-link harness (Black connector).

↳The Blue, Red, Yellow and Blue & Red LEDs will alternatively illuminate.

2

RELEASE

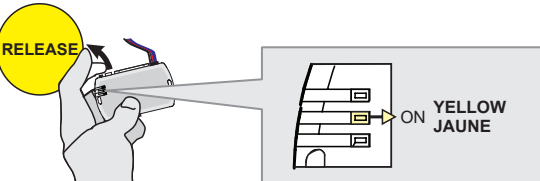

Release the programming button when the LED is YELLOW.

If the LED is not solid YELLOW disconnect the 4-Pin connector (Data-Link) and go back to step 1.

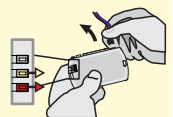

3

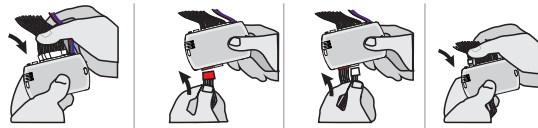

Insert the required remaining connectors.

4

x5 PRESS

PRESS X5 → FLASH

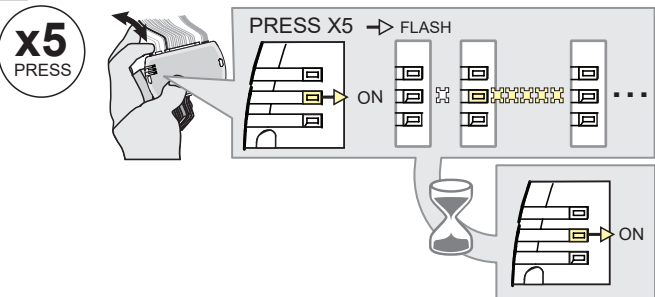

Press and release the programming button five (5x) times.

↳The YELLOW LED will flash 5 times each second.

↳**WAIT** for the YELLOW LED to turn ON solide.

5

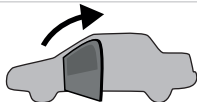

Open the driver door.

6

x1 PRESS HOLD START

RELEASE START

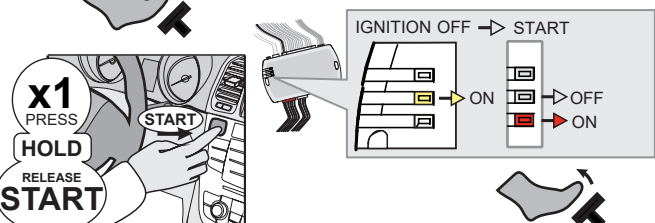

Press the foot-brake pedal.

Press the Push-to-Start button until the engine start.

Release the foot-brake pedal.

↳The RED LED will turn ON.
 ↳The YELLOW LED will turn OFF.

KEY BYPASS PROGRAMMING PROCEDURE 2/3

7



Press the Push-to-Start button until the engine turn OFF.

8

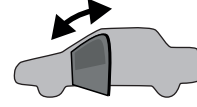

Close and open the driver door.

9

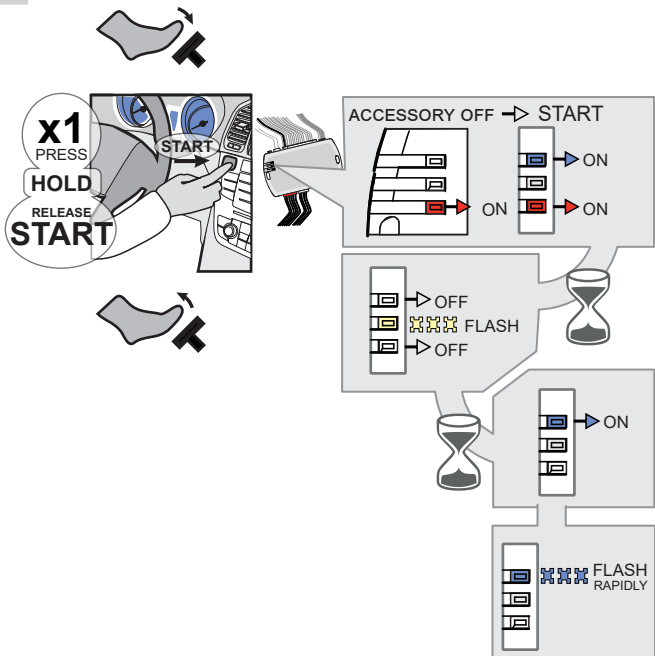

Press the foot-brake pedal.

Press the Push-to-Start button until the engine start.

Release the foot-brake pedal.

- ↳ The BLUE LED will turn ON.
- ↳ The BLUE LED will turn OFF. The RED LED will turn OFF.
- ↳ The YELLOW LED will flash rapidly
- ↳ The BLUE LED will turn ON.
- ↳ The BLUE LED will flash rapidly

10

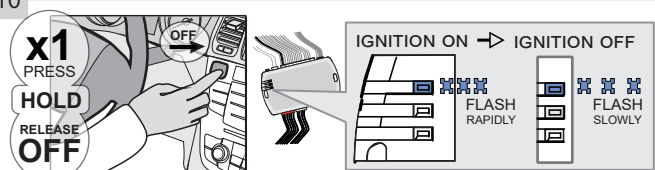

Press the Push-to-Start button until the engine turn OFF.

- ↳ The BLUE LED will flash slowly

11

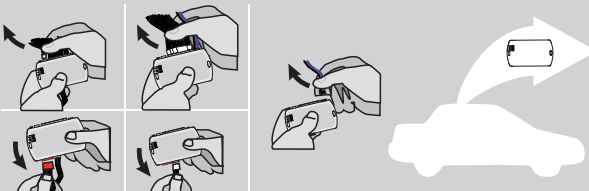

Disconnect all the connectors and after the Data-Link (4-pins) connector.

12

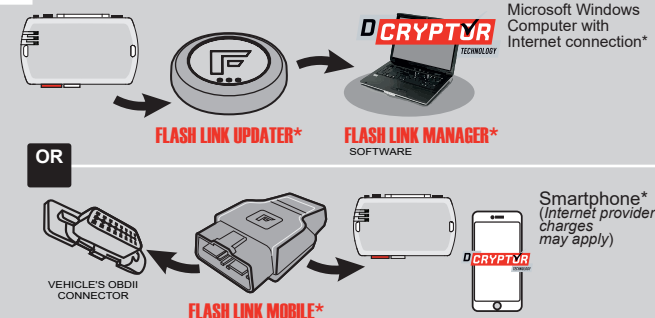

Microsoft Windows Computer with Internet connection*

FLASH LINK UPDATER* **FLASH LINK MANAGER* SOFTWARE**

OR

Vehicle's OBDII Connector **FLASH LINK MOBILE*** Smartphone* (Internet provider charges may apply)

Use the tool: FLASH LINK UPDATER or FLASH LINK MOBILE to visit the DCryptor menu.

*Parts required (not included)

KEY BYPASS PROGRAMMING PROCEDURE 3/3

13

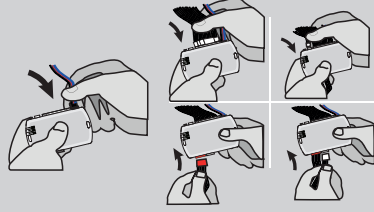
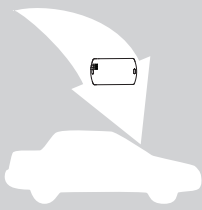

AFTER DCRYPTOR PROGRAMMING COMPLETED
Go back to the vehicle and **reconnect** the 4-Pin (Data-Link) connector and after, all the remaining connector.



The module is now programmed.



REMOTE STARTER / ALARM VERIFICATION PROCEDURE

Test the remote starter. Remote start the vehicle.

REMOTE STARTER FUNCTIONALITY



All doors must be closed.



Remote start the vehicle.



Unlock the doors with either:

- The OEM remote
- The remote-starter remote
- Or the proximity remote

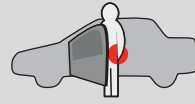

Enter the vehicle with the Intelligent Key.



The vehicle can now be put in to gear and driven.

If the vehicle is not unlocked with one of these conditions the remote-starter will shut down as soon as any door is opened.



STAND ALONE INSTALLATION AND THAR-GM6 INSTALLATION

ADDENDUM - SUGGESTED WIRING CONFIGURATION



ONLY COMPATIBLE WITH AUTOMATIC TRANSMISSION VEHICLES.



VEHICLE

YEARS

Vehicle functions supported in this diagram (functional if equipped)

VEHICLE	YEARS	Immobilizer bypass	Lock	Unlock	Arm	Disarm	Parking Light	Trunk (open)	RAP Disable	Tachometer	Door Status	Trunk Status	Hand-Brake Status	Foot-Brake Status	OEM Remote Monitoring
CHEVROLET															
Malibu	Push-To-Start	2013-2015	•	•	•	•	•	•	•	•	•	•	•	•	•



FIRMWARE VERSION

70.[41]

GM MINIMUM

To add the firmware version and the options, use the **FLASH LINK UPDATER** or **FLASH LINK MOBILE** tool, sold separately.

IF THE VEHICLE IS NOT EQUIPPED WITH FUNCTIONAL HOOD PIN:

A11

OFF

Hood trigger (Output Status).



Program bypass option:

UNIT OPTION

DESCRIPTION

C1

OEM Remote status (Lock/Unlock) monitoring

D6

Push-to-Start



ATTENTION!

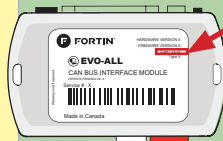

DATE: XX-XX

E5

OFF

SPECIAL FUNCTIONS: BY DEFAULT DEACTIVATED

ON

MANUFACTURED MODULES BETWEEN: 04/2018 TO 04/2019

MANDATORY INSTALL

*HOOD PIN



HOOD STATUS: THE HOOD PIN SWITCH MUST BE INSTALLED IF THE VEHICLE CAN BE REMOTE STARTED WITH THE HOOD OPEN, SET FUNCTION **A11** TO OFF.

A11

OFF

Notice: the installation of safety elements are mandatory. The hood pin is an essential security element and must be installed.

THIS MODULE MUST BE INSTALLED BY A QUALIFIED TECHNICIAN. A WRONG CONNECTION CAN CAUSE PERMANENT DAMAGE TO THE VEHICLE.

PARTS REQUIRED (NOT INCLUDED)

1x **FLASH LINK UPDATER,**
 1x **FLASH LINK MANAGER**
 SOFTWARE | PROGRAMME
 1x Microsoft Windows Computer with Internet connection

OR

1x **FLASH LINK MOBILE**
 1x **FLASH LINK MOBILE APP**
 Smartphone *Android* or *iOS* with Internet connection (*provider charges may apply*).

MANDATORY

HOOD PIN



REMOTE START SAFETY OVERRIDE SWITCH

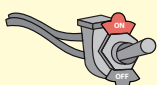





VALET SWITCH

Part #: RSPB available, Sold separately.

Notice: the installation of safety elements are mandatory. The hood pin and the valet switch are essential security elements and must be installed.

STAND ALONE CONFIGURATION

	Program bypass option	UNIT OPTION	DESCRIPTION
	OEM Remote Stand Alone Remote Starter:	D1.10 	By default, LOCK, LOCK, LOCK
		D1.1 	Par défaut, VERROUILLE,VERROUILLE,VERROUILLE
	Program bypass option with oem remote:	C1	OEM Remote Monitoring
	Program bypass option with RF KIT antenna:	H1 to H6	Supported RF Kits and select RF Kit

REMOTE STARTER FUNCTIONALITY



All doors must be closed.

3X 

Press the OEM remote's Lock button 3x to remote-start (or remote-stop) the vehicle.



START 

The vehicle will START.

REMOTE STARTER DIAGNOSTICS
MODULE RED LED

x2 flash :	Brake ON
x3 flash :	No tach
x4 flash :	Ignition before start
x5 flash :	Hood Open

REMOTE STARTER WARNING CARD



CUT THIS WARNING CARD AND STICK IT ON A VISIBLE PLACE:
 or use the package **RSPB**, Sold separately.

WARNING | ATTENTION

REMOTE STARTER

THE VEHICLE CAN BE STARTED BY EITHER: PRESSING THE LOCK BUTTON ON THE OEM REMOTE 3 TIMES CONSECUTIVELY OR BY A SMARTPHONE. **TURN ON** THE SAFETY SWITCH LOCATED UNDER THE DASHBOARD BEFORE WORKING ON THE VEHICLE.

DESCRIPTION

Parts required (Not included) PAGE

WIRE TO WIRE DIAGRAM

1X 5 Amp Fuse 1X 1k Ohm Resistor	Page 4
-------------------------------------	--------

THARNES DIAGRAM

THARNES THAR-GM6	1x THAR-GM6	Page 5
------------------	-------------	--------

BCM

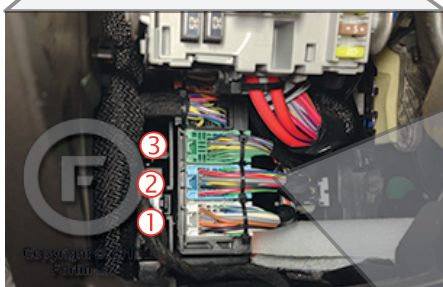
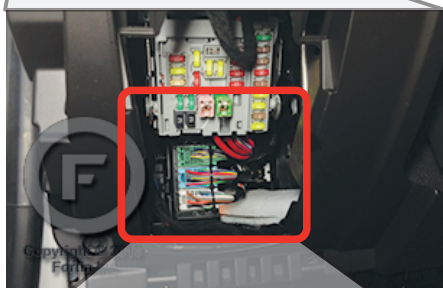

Malibu

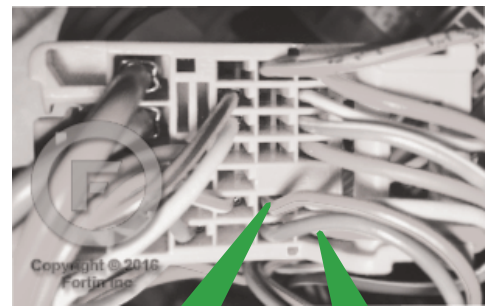
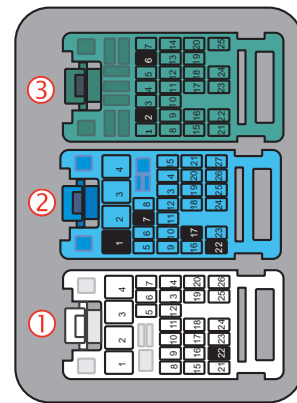
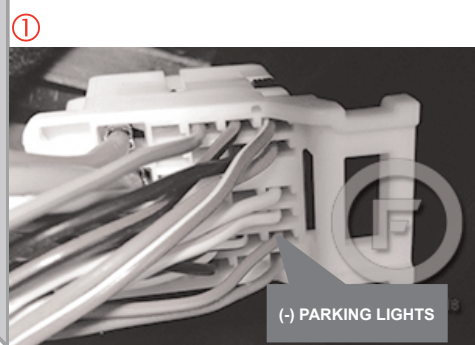
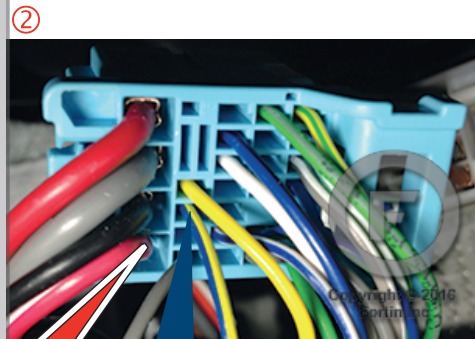
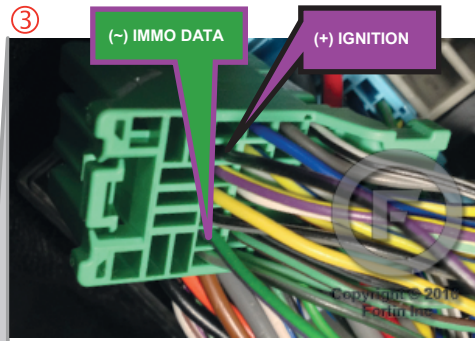

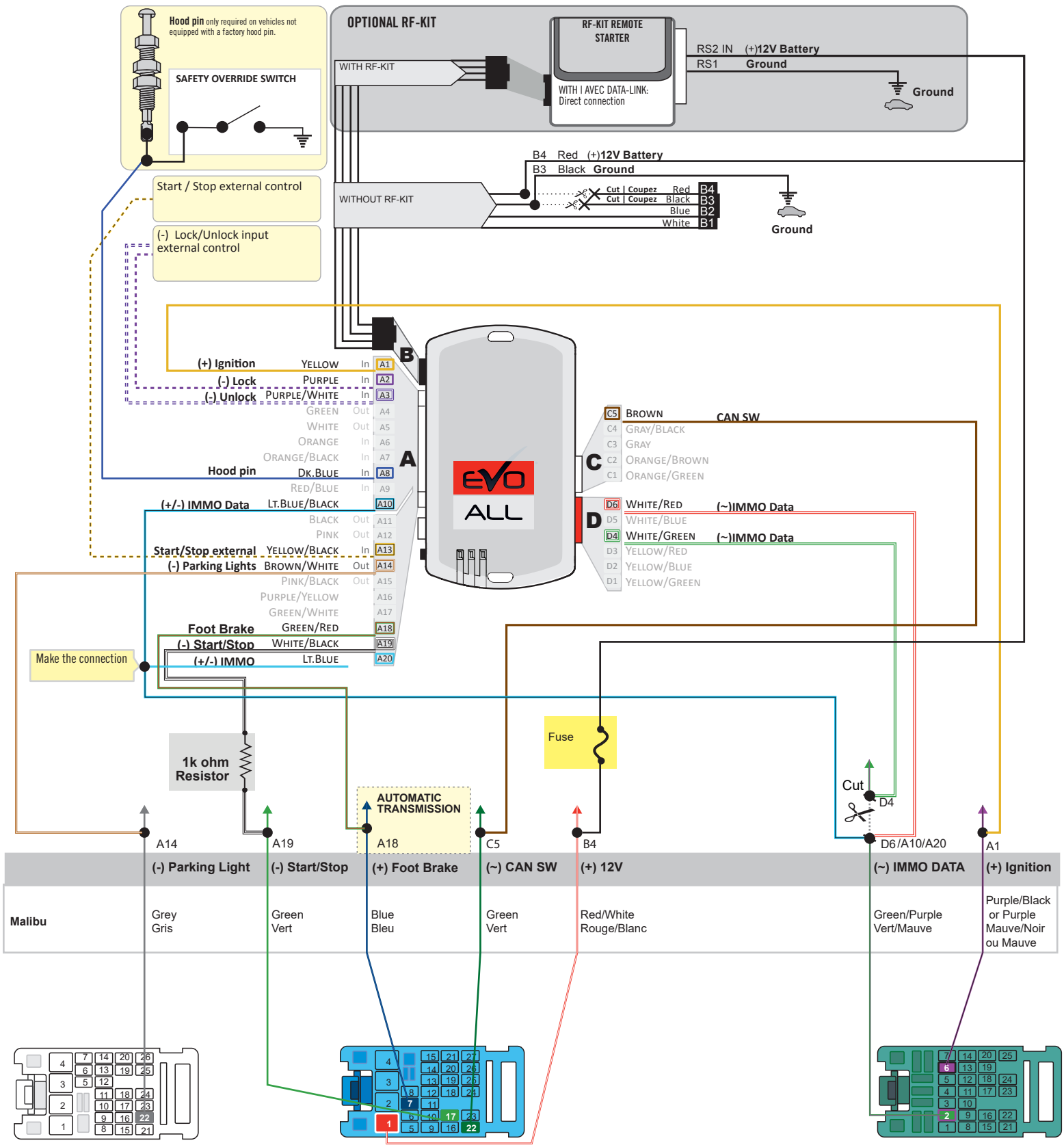

① Back view, 26-Pin White connector, at BCM.

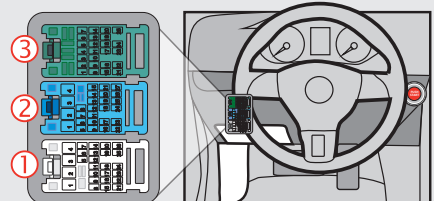

② Back view, 27-Pin Blue connector, at BCM.

③ Back view, 25-Pin Green connector, at BCM.

THAR-GM6 | AUTOMATIC TRANSMISSION CONNECTION

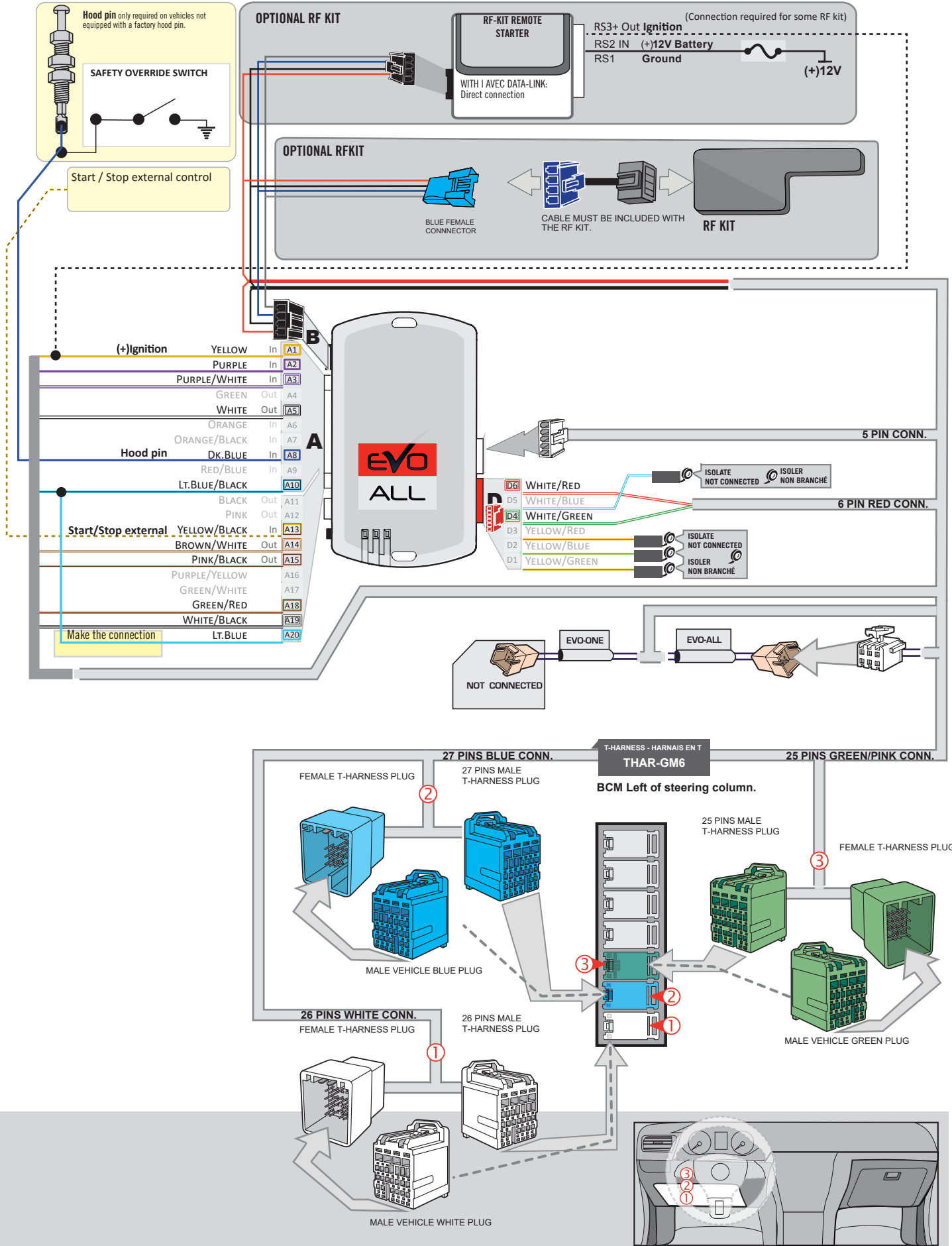

KEY BYPASS PROGRAMMING PROCEDURE 1/3

Chevrolet Malibu



- 1 Remove the battery from the OEM remote.
- 2 Place the OEM remote into the transmitter pocket of the center console.
Refer to vehicle user guide for keyport location.

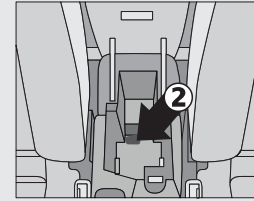

1

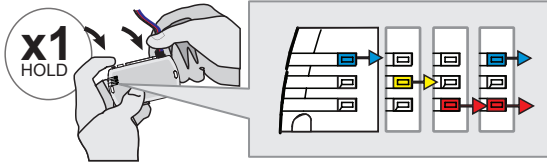

Press and hold the programming button:
Connect the 4-PIN Data-link harness (Black connector).

↳The Blue, Red, Yellow and Blue & Red LEDs will alternatively illuminate.

2

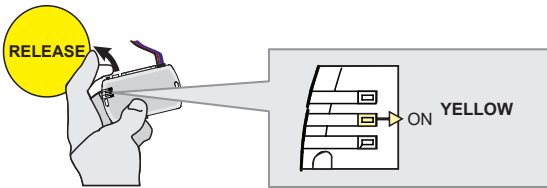

Release the programming button when the LED is YELLOW.

If the LED is not solid YELLOW disconnect the 4-Pin connector (Data-Link) and go back to step 1.

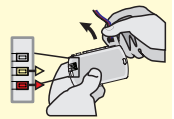

3

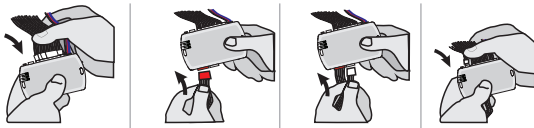

Insert the required remaining connectors.

4

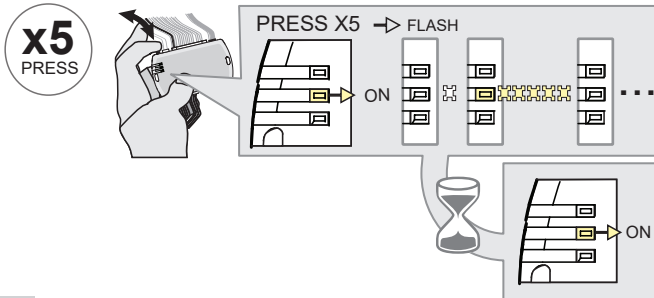

Press and release the programming button five (5x) times.

↳The YELLOW LED will flash 5 times each second.

↳**WAIT** for the YELLOW LED to turn ON solide.

5

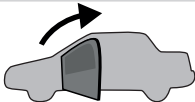

Open the driver door.

6

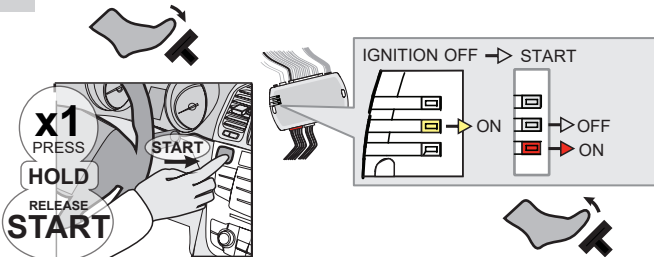

Press the foot-brake pedal.

Press the Push-to-Start button until the engine start.

Release the foot-brake pedal.

↳The RED LED will turn ON.
↳The YELLOW LED will turn OFF.

KEY BYPASS PROGRAMMING PROCEDURE 2/3

7



Press the Push-to-Start button until the engine turn OFF.

8

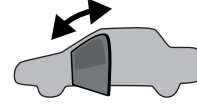

Close and open the driver door.

9

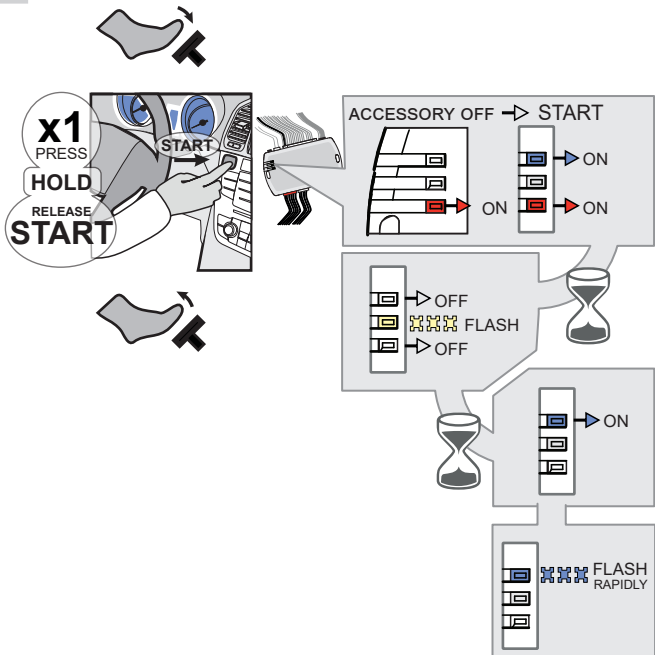

Press the foot-brake pedal.

Press the Push-to-Start button until the engine start.

Release the foot-brake pedal.

- ↳ The BLUE LED will turn ON.
- ↳ The BLUE LED will turn OFF. The RED LED will turn OFF.
- ↳ The YELLOW LED will flash rapidly
- ↳ The BLUE LED will turn ON.
- ↳ The BLUE LED will flash rapidly

10

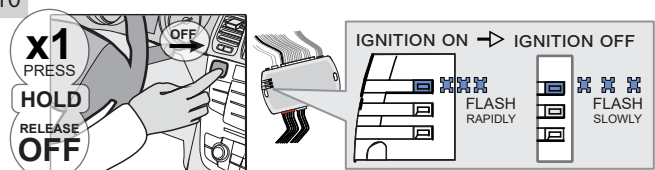

Press the Push-to-Start button until the engine turn OFF.

- ↳ The BLUE LED will flash slowly

11

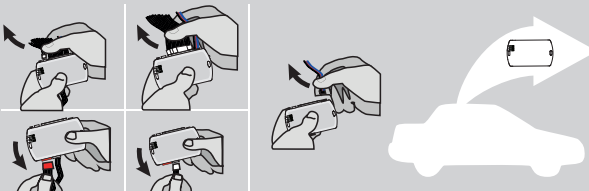

Disconnect all the connectors and after the Data-Link (4-pins) connector.

12

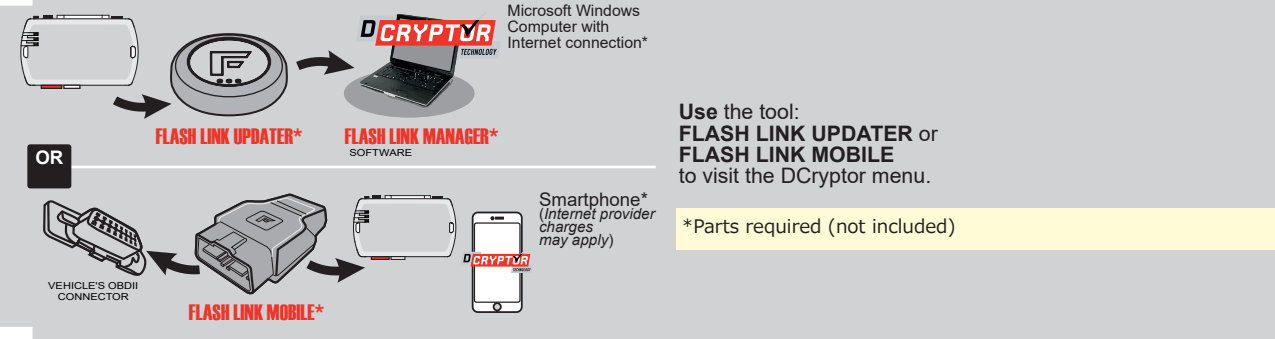

Use the tool: FLASH LINK UPDATER or FLASH LINK MOBILE to visit the DCRYPTOR menu.

***Parts required (not included)**

KEY BYPASS PROGRAMMING PROCEDURE 3/3

13

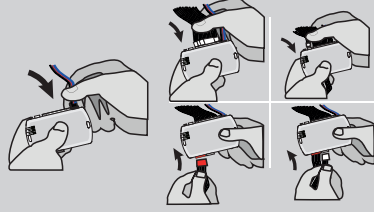
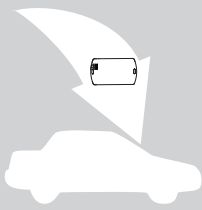

AFTER DCRYPTOR PROGRAMMING COMPLETED
Go back to the vehicle and **reconnect** the 4-Pin (Data-Link) connector and after, all the remaining connector.



The module is now programmed.



REMOTE STARTER / ALARM VERIFICATION PROCEDURE

Test the remote starter. **Remote start** the vehicle.

OPTIONAL RF-KIT PROGRAMMING

PROGRAM BYPASS OPTION



Program bypass option:

H2

Supported RF-KITS enable

H2 Fortin 2

OPTIONAL FORTIN RF KIT SERIES 4 OR SERIES 9 PROGRAMMING

The module must be programmed on the vehicle.

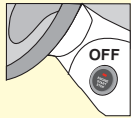

MAKE SURE THE IGNITION KEY HAS BEEN IN THE OFF POSITION FOR AT LEAST 5 SECONDS.

	1	2	3	4	5	6
	<p>ON x1 PRESS (HOLD) START</p> <p>Press the foot-brake pedal. Press the Push-to-Start button until the engine start. Release the foot-brake pedal.</p>	<p>OFF x1 PRESS (HOLD) START OFF</p> <p>Press the Push-to-Start button until the engine turn OFF.</p>	<p>ON x1 PRESS (HOLD) START</p> <p>Press the foot-brake pedal. Press the Push-to-Start button until the engine start. Release the foot-brake pedal.</p>	<p>4X BRAKES x4 PRESS</p> <p>Press and release the brake pedal four times.</p>	<p>ON EACH TRANSMITTER</p> <p>4 BUTTONS</p> <p>[-] PRESS AND RELEASE</p> <p>→ PRESS AND RELEASE</p> <p>[LOCK] PRESS AND RELEASE</p> <p>1 BUTTON</p> <p>[POWER] PRESS APPROX. 12 SEC. AND WAIT FOR THE BLUE LED TO TURN OFF THEN BACK ON SOLID THEN RELEASE.</p>	<p>OFF x1 PRESS (HOLD) START OFF</p> <p>Press the Push-to-Start button until the engine turn OFF.</p>
			<p>The LED will turn ON solide.</p>	<p>The LED will flash rapidly.</p>	<p>The LED will turn off each time.</p>	<p>The LED will turn Off.</p>
	<p>The YELLOW LED will turn ON solid.</p>	<p>The YELLOW LED will turn Off.</p>	<p>The YELLOW LED will turn ON solid.</p>	<p>The 3 LED will turn ON solid.</p>	<p>The LED will flash rapidly. Le témoin clignotera rapidement.</p>	<p>The 3 LED will turn off each time.</p>



REMOTE STARTER FUNCTIONALITY



All doors must be closed.



Remote start the vehicle.



Unlock the doors with either:

- The OEM remote
- The remote-starter remote
- Or the proximity remote



Enter the vehicle with the Intelligent Key.



The vehicle can now be put in to gear and driven.

If the vehicle is not unlocked with one of these conditions the remote-starter will shut down as soon as any door is opened.



STAND ALONE INSTALLATION AND THAR-GM6

ADDENDUM - SUGGESTED WIRING CONFIGURATION



ONLY COMPATIBLE WITH AUTOMATIC TRANSMISSION VEHICLES.



VEHICLE

YEARS

Vehicle functions supported in this diagram (functional if equipped)

BUICK

VEHICLE	YEARS	Immobilizer bypass	Lock	Unlock	Arm	Disarm	Parking Light	Trunk (open)	RAP Disable	Tachometer	Door Status	Trunk Status	Hand-Brake Status	Foot-Brake Status	OEM Remote Monitoring
Regal	Push-To-Start	2011-2017	•	•	•	•	•	•	•	•	•	•	•	•	•



FIRMWARE VERSION

70.[41]

GM MINIMUM

To add the firmware version and the options, use the **FLASH LINK UPDATER** or **FLASH LINK MOBILE** tool, sold separately.

IF THE VEHICLE IS NOT EQUIPPED WITH FUNCTIONAL HOOD PIN:

A11

OFF

Hood trigger (Output Status).



Program bypass option:

UNIT OPTION

DESCRIPTION

C1

OEM Remote status (Lock/Unlock) monitoring

D6

Push-to-Start



ATTENTION!

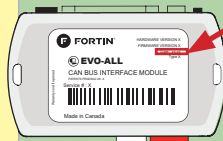

DATE: XX-XX

E5

OFF

SPECIAL FUNCTIONS: BY DEFAULT DEACTIVATED

ON

MANUFACTURED MODULES BETWEEN: 04/2018 TO 04/2019

MANDATORY INSTALL

*HOOD PIN



HOOD STATUS: THE HOOD PIN SWITCH MUST BE INSTALLED IF THE VEHICLE CAN BE REMOTE STARTED WITH THE HOOD OPEN, SET FUNCTION **A11** TO OFF.

A11

OFF

Notice: the installation of safety elements are mandatory. The hood pin is an essential security element and must be installed.

THIS MODULE MUST BE INSTALLED BY A QUALIFIED TECHNICIAN. A WRONG CONNECTION CAN CAUSE PERMANENT DAMAGE TO THE VEHICLE.

PARTS REQUIRED (NOT INCLUDED)

1x **FLASH LINK UPDATER**
 1x **FLASH LINK MANAGER**
 SOFTWARE
 1x Microsoft Windows Computer with Internet connection

OR

1x **FLASH LINK MOBILE**
 1x **FLASH LINK MOBILE APP**
 Smartphone *Android* or *iOS* with Internet connection (*provider charges may apply*).
 1x

MANDATORY

HOOD PIN



REMOTE START SAFETY OVERRIDE SWITCH

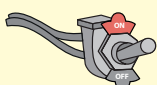





VALET SWITCH

Part #: RSPB available, Sold separately.

Notice: the installation of safety elements are mandatory. The hood pin and the valet switch are essential security elements and must be installed.

STAND ALONE CONFIGURATION

	Program bypass option	UNIT OPTION	DESCRIPTION
	OEM Remote Stand Alone Remote Starter:	D1.10 	By default, LOCK, LOCK, LOCK Par défaut, VERROUILLE,VERROUILLE,VERROUILLE
		D1.1 	
	Program bypass option with oem remote:	C1	OEM Remote Monitoring
	Program bypass option with RF KIT antenna:	H1 to H6	Supported RF Kits and select RF Kit

REMOTE STARTER FUNCTIONALITY



All doors must be closed.

3X 

Press the OEM remote's Lock button 3x to remote-start (or remote-stop) the vehicle.



START 

The vehicle will START.

REMOTE STARTER DIAGNOSTICS
MODULE RED LED

x2 flash :	Brake ON
x3 flash :	No tach
x4 flash :	Ignition before start
x5 flash :	Hood Open

REMOTE STARTER WARNING CARD



CUT THIS WARNING CARD AND STICK IT ON A VISIBLE PLACE:
 or use the package **RSPB**, Sold separately.

WARNING | ATTENTION

REMOTE STARTER

THE VEHICLE CAN BE STARTED BY EITHER: PRESSING THE LOCK BUTTON ON THE OEM REMOTE 3 TIMES CONSECUTIVELY OR BY A SMARTPHONE. **TURN ON** THE SAFETY SWITCH LOCATED UNDER THE DASHBOARD BEFORE WORKING ON THE VEHICLE.

DESCRIPTION

		Parts required (Not included)	PAGE
--	--	-------------------------------	------

WIRE TO WIRE DIAGRAM

AUTOMATIC TRANSMISSION	1X 5 Amp Fuse 1X 1k Ohm Resistor	Page 4
------------------------	-------------------------------------	--------

THARNESSE DIAGRAM

THARNESSE THAR-GM6	AUTOMATIC TRANSMISSION	1x THAR-GM6	Page 5
--------------------	------------------------	-------------	--------

BCM

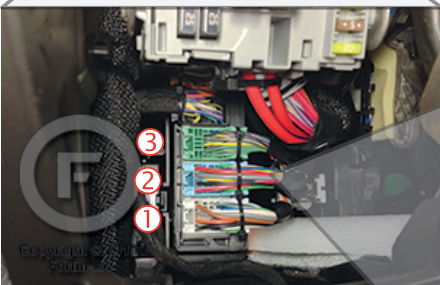
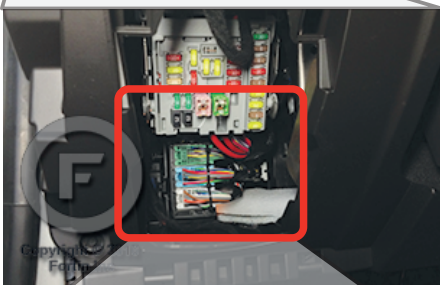

Regal

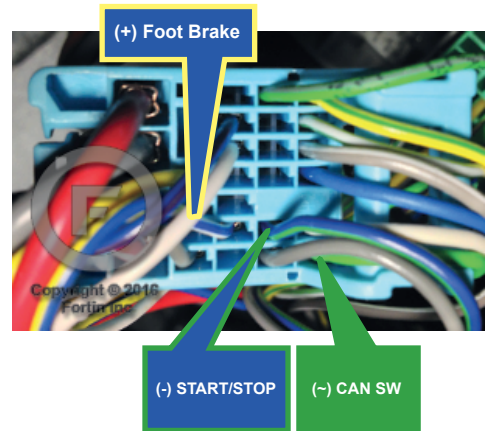
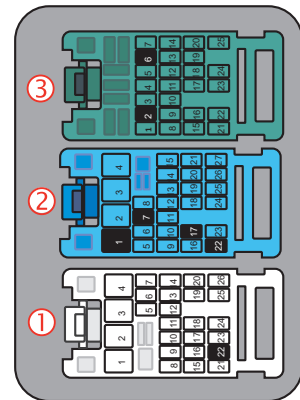
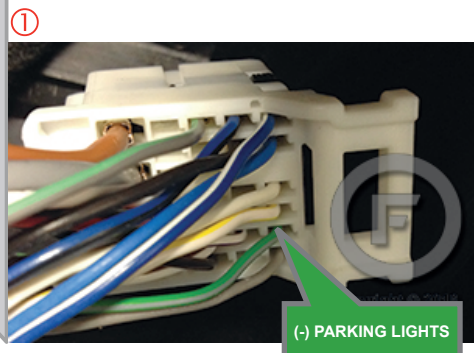
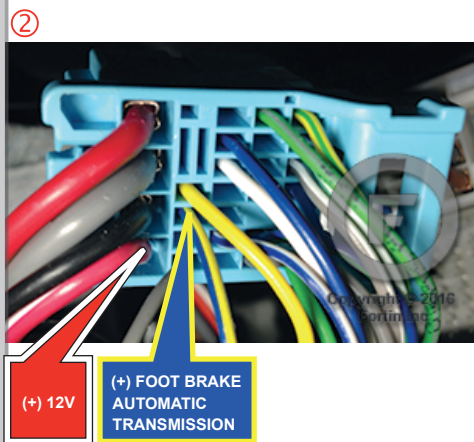
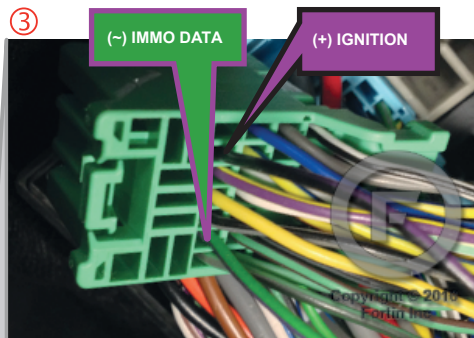

AUTOMATIC TRANSMISSION WIRING CONNECTION

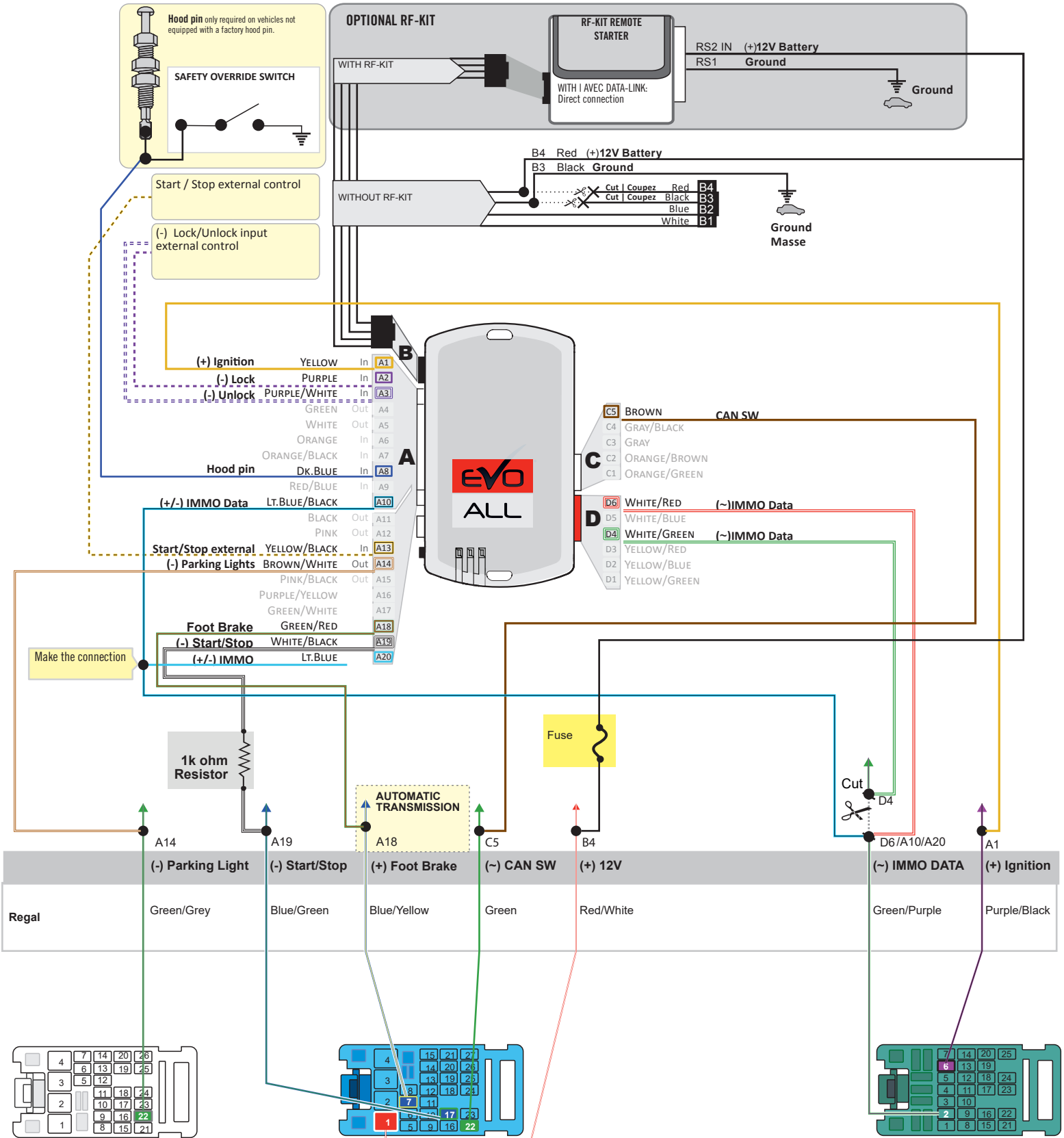

① Back view, 26-Pin White connector, at BCM.

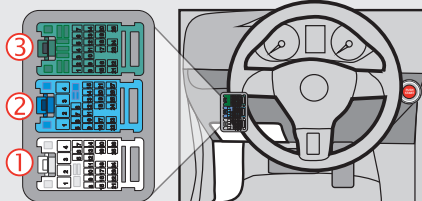

② Back view, 27-Pin Blue connector, at BCM.

③ Back view, 25-Pin Green connector, at BCM.

THAR-GM6 | AUTOMATIC TRANSMISSION CONNECTION

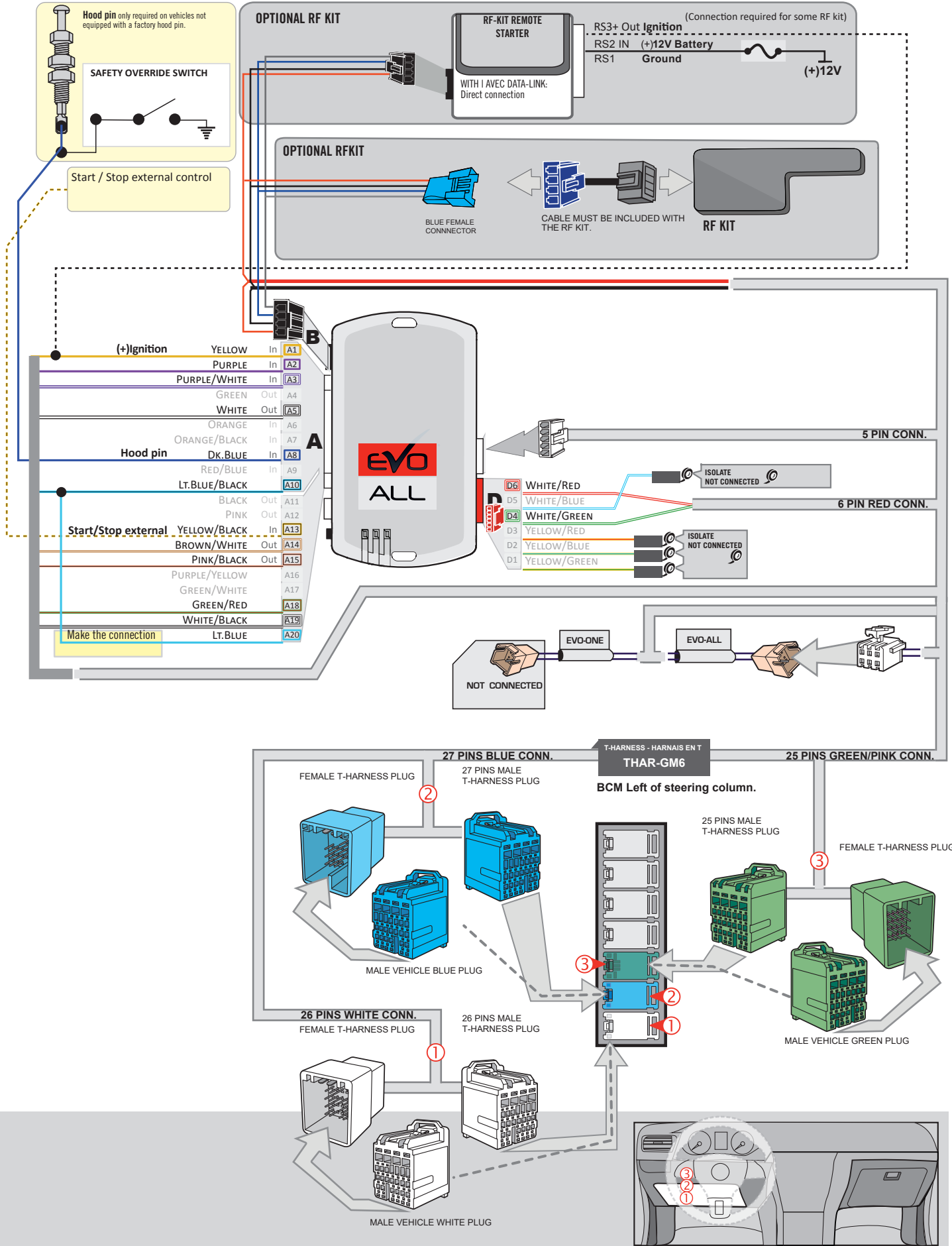

KEY BYPASS PROGRAMMING PROCEDURE 1/3



- 1** Remove the battery from the OEM remote
- 2** Place the OEM remote in the **back** cup holder in the center console.
Refer to vehicle user guide for keyport location.

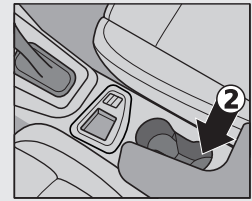

1

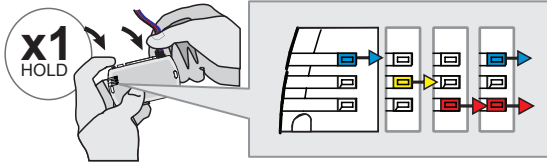

Press and hold the programming button:
Connect the 4-PIN Data-link harness (Black connector).

↳The Blue, Red, Yellow and Blue & Red LEDs will alternatively illuminate.

2

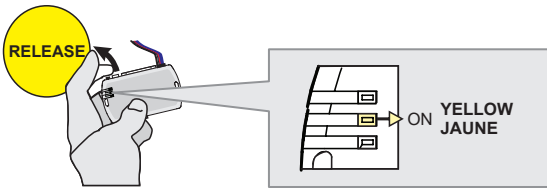

Release the programming button when the LED is **YELLOW**.

If the LED is not solid YELLOW disconnect the 4-Pin connector (Data-Link) and go back to step 1.

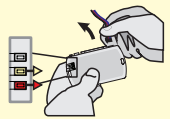

3

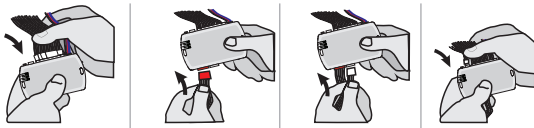

Insert the required remaining connectors.

4

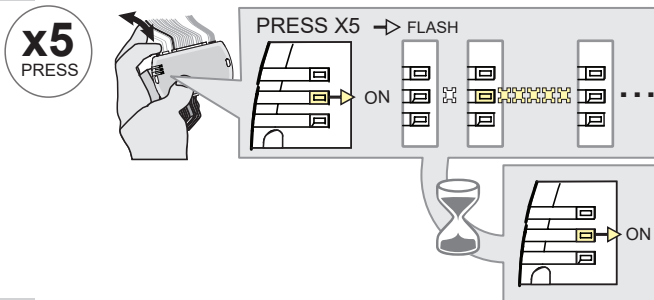

Press and release the programming button five (5x) times.

↳The **YELLOW LED** will flash 5 times each second.

↳**WAIT** for the **YELLOW LED** to turn **ON** solide.

5

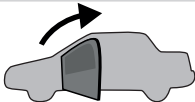

Open the driver door.

6

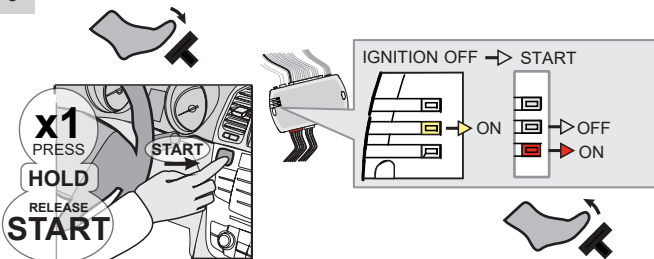

Press the foot-brake pedal.

Press the Push-to-Start button until the engine start.

Release the foot-brake pedal.

↳The **RED LED** will turn **ON**.
↳The **YELLOW LED** will turn **OFF**.

KEY BYPASS PROGRAMMING PROCEDURE 2/3

7



Press the Push-to-Start button until the engine turn OFF.

8

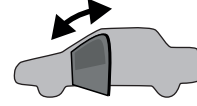

Close and open the driver door.

9

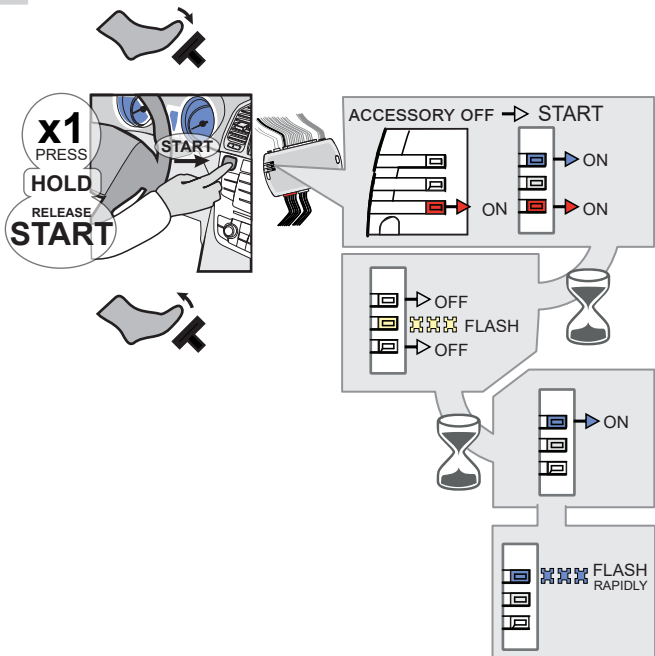

Press the foot-brake pedal.

Press the Push-to-Start button until the engine start.

Release the foot-brake pedal.

- ↳ The BLUE LED will turn ON.
- ↳ The BLUE LED will turn OFF. The RED LED will turn OFF.
- ↳ The YELLOW LED will flash rapidly
- ↳ The BLUE LED will turn ON.
- ↳ The BLUE LED will flash rapidly

10

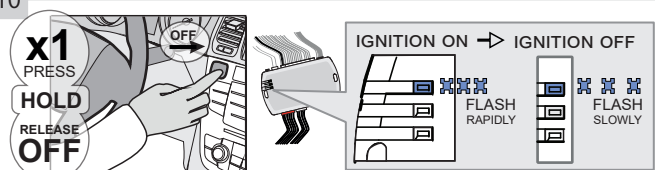

Press the Push-to-Start button until the engine turn OFF.

- ↳ The BLUE LED will flash slowly

11

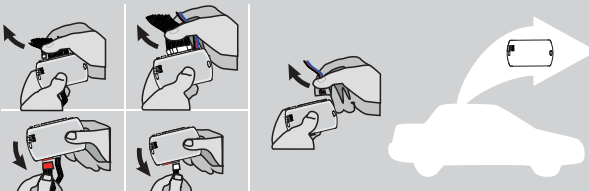

Disconnect all the connectors and after the Data-Link (4-pins) connector.

12

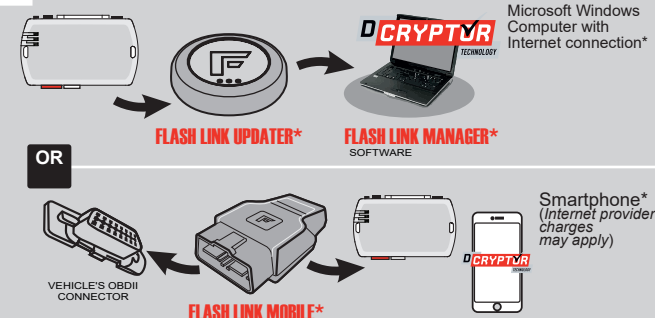

Use the tool: FLASH LINK UPDATER or FLASH LINK MOBILE to visit the DCRYPTOR menu.

***Parts required (not included)**

KEY BYPASS PROGRAMMING PROCEDURE 3/3

13

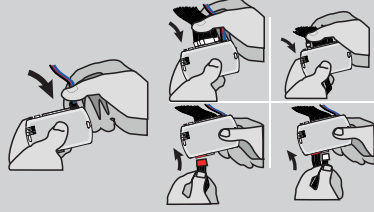
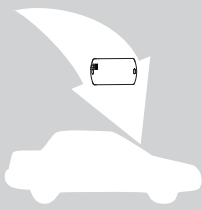

AFTER DCRYPTOR PROGRAMMING COMPLETED
Go back to the vehicle and **reconnect** the 4-Pin (Data-Link) connector and after, all the remaining connector.



The module is now programmed.



REMOTE STARTER / ALARM VERIFICATION PROCEDURE

Test the remote starter. Remote start the vehicle.

OPTIONAL RF-KIT PROGRAMMING

PROGRAM BYPASS OPTION



Program bypass option:

H2

Supported RF-KITS enable

H2 Fortin 2

OPTIONAL FORTIN RF KIT SERIES 4 OR SERIES 9 PROGRAMMING

The module must be programmed on the vehicle.

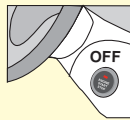

MAKE SURE THE IGNITION KEY HAS BEEN IN THE OFF POSITION FOR AT LEAST 5 SECONDS.

	1	2	3	4	5	6
	<p>ON</p> <p>x1 PRESS (HOLD) START</p>	<p>OFF</p> <p>x1 PRESS (HOLD) START OFF</p>	<p>ON</p> <p>x1 PRESS (HOLD) START</p>	<p>4X BRAKES</p> <p>x4 PRESS</p>	<p>ON EACH TRANSMITTER</p> <p>4 BUTTONS</p> <p>[-] PRESS AND RELEASE</p> <p>→ PRESS AND RELEASE</p> <p>[LOCK] PRESS AND RELEASE</p> <p>1 BUTTON</p> <p>⏻ PRESS APPROX. 12 SEC. AND WAIT FOR THE BLUE LED TO TURN OFF THEN BACK ON SOLID THEN RELEASE.</p>	<p>OFF</p> <p>x1 PRESS (HOLD) START OFF</p>
	<p>Press the foot-brake pedal. Press the Push-to-Start button until the engine start. Release the foot-brake pedal.</p>	<p>Press the Push-to-Start button until the engine turn OFF.</p>	<p>Press the foot-brake pedal. Press the Push-to-Start button until the engine start. Release the foot-brake pedal.</p>	<p>Press and release the brake pedal four times.</p>	<p>The LED will turn off each time.</p>	<p>Press the Push-to-Start button until the engine turn OFF.</p>
	<p>The YELLOW LED will turn ON solid.</p>	<p>The YELLOW LED will turn Off.</p>	<p>The LED will turn ON solide.</p>	<p>The LED will flash rapidly.</p>	<p>The LED will turn off each time.</p>	<p>The LED will turn Off.</p>
	<p>The 3 LED will turn ON solid.</p>	<p>The 3 LED will turn off.</p>	<p>The LED will turn ON solide.</p>	<p>The 3 LED will turn ON solid.</p>	<p>The LED will flash rapidly.</p>	<p>The 3 LED will turn off.</p>
	<p>The 3 LED will turn off each time.</p>				<p>The 3 LED will turn off each time.</p>	



REMOTE STARTER FUNCTIONALITY |



All doors must be closed.



Remote start the vehicle.



Unlock the doors with either:

- The OEM remote
- The remote-starter remote
- Or the proximity remote



Enter the vehicle with the Intelligent Key.



The vehicle can now be put in to gear and driven.

If the vehicle is not unlocked with one of these conditions the remote-starter will shut down as soon as any door is opened.



**STAND ALONE INSTALLATION AND THAR-GM6
INSTALLATION**

ADDENDUM - SUGGESTED WIRING CONFIGURATION



ONLY COMPATIBLE WITH AUTOMATIC TRANSMISSION VEHICLES.



VEHICLE

YEARS

Vehicle functions supported in this diagram (functional if equipped)

VEHICLE	YEARS	Immobilizer bypass	Lock	Unlock	Arm	Disarm	Parking Light	Trunk (open)	RAP Disable	Tachometer	Door Status	Trunk Status	Hand-Brake Status	Foot-Brake Status	OEM Remote Monitoring
BUICK															
Regal	Push-To-Start	2018-2019	•	•	•	•	•	•	•	•	•	•	•	•	•



FIRMWARE VERSION

70.[41]

GM MINIMUM

To add the firmware version and the options, use the **FLASH LINK UPDATER** or **FLASH LINK MOBILE** tool, sold separately.

IF THE VEHICLE IS NOT EQUIPPED WITH FUNCTIONAL HOOD PIN:

A11

OFF

Hood trigger (Output Status).



Program bypass option:

UNIT OPTION

DESCRIPTION

C1

OEM Remote status (Lock/Unlock) monitoring

D6

Push-to-Start



ATTENTION!

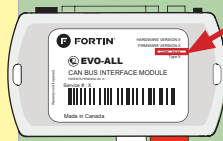

DATE: XX-XX

E5

OFF

SPECIAL FUNCTIONS: BY DEFAULT DEACTIVATED

ON

MANUFACTURED MODULES BETWEEN: 04/2018 TO 04/2019

MANDATORY INSTALL

*HOOD PIN



HOOD STATUS: THE HOOD PIN SWITCH MUST BE INSTALLED IF THE VEHICLE CAN BE REMOTE STARTED WITH THE HOOD OPEN, SET FUNCTION **A11** TO OFF.

A11

OFF

Notice: the installation of safety elements are mandatory. The hood pin is an essential security element and must be installed.

THIS MODULE MUST BE INSTALLED BY A QUALIFIED TECHNICIAN. A WRONG CONNECTION CAN CAUSE PERMANENT DAMAGE TO THE VEHICLE.

PARTS REQUIRED (NOT INCLUDED)

1x **FLASH LINK UPDATER**
 1x **FLASH LINK MANAGER**
 SOFTWARE
 1x Microsoft Windows Computer with Internet connection

OR

1x **FLASH LINK MOBILE**
 1x **FLASH LINK MOBILE APP**
 Smartphone *Android* or *iOS* with Internet connection (*provider charges may apply*).
 1x

MANDATORY

HOOD PIN



REMOTE START SAFETY OVERRIDE SWITCH

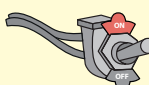





VALET SWITCH

Part #: RSPB available, Sold separately.

Notice: the installation of safety elements are mandatory. The hood pin and the valet switch are essential security elements and must be installed.

STAND ALONE CONFIGURATION

	Program bypass option	UNIT OPTION	DESCRIPTION
	OEM Remote Stand Alone Remote Starter:	D1.10 	By default, LOCK, LOCK, LOCK Par défaut, VERROUILLE,VERROUILLE,VERROUILLE
		D1.1 	
	Program bypass option with oem remote:	C1	OEM Remote Monitoring
	Program bypass option with RF KIT antenna:	H1 to H6	Supported RF Kits and select RF Kit

REMOTE STARTER FUNCTIONALITY



All doors must be closed.

3X 

Press the OEM remote's Lock button 3x to remote-start (or remote-stop) the vehicle.



START

The vehicle will START.

REMOTE STARTER DIAGNOSTICS
MODULE RED LED

x2 flash :	Brake ON
x3 flash :	No tach
x4 flash :	Ignition before start
x5 flash :	Hood Open

REMOTE STARTER WARNING CARD



CUT THIS WARNING CARD AND STICK IT ON A VISIBLE PLACE:
 or use the package **RSPB**, Sold separately.

WARNING

REMOTE STARTER

THE VEHICLE CAN BE STARTED BY EITHER: PRESSING THE LOCK BUTTON ON THE OEM REMOTE 3 TIMES CONSECUTIVELY OR BY A SMARTPHONE. **TURN ON** THE SAFETY SWITCH LOCATED UNDER THE DASHBOARD BEFORE WORKING ON THE VEHICLE.

DESCRIPTION

Parts required (Not included)		PAGE
-------------------------------	--	------

WIRE TO WIRE DIAGRAM

AUTOMATIC TRANSMISSION	1X 5 Amp Fuse 1X 1k Ohm Resistor	Page 4
------------------------	-------------------------------------	--------

THARNES DIAGRAM

THARNES THAR-GM6	AUTOMATIC TRANSMISSION	1x THAR-GM6	Page 5
------------------	------------------------	-------------	--------

Regal
2018-2019

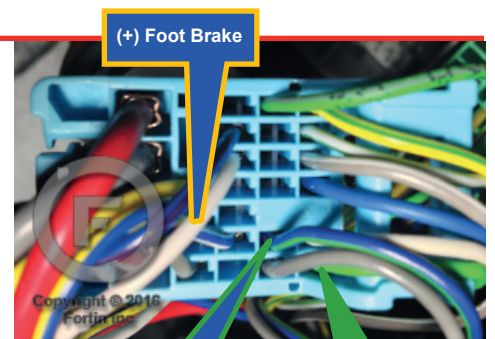
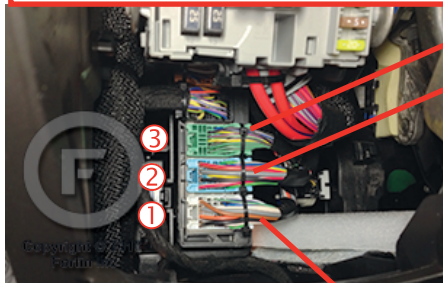
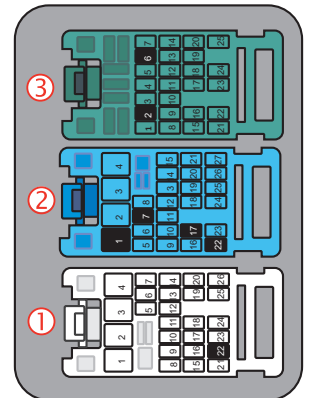
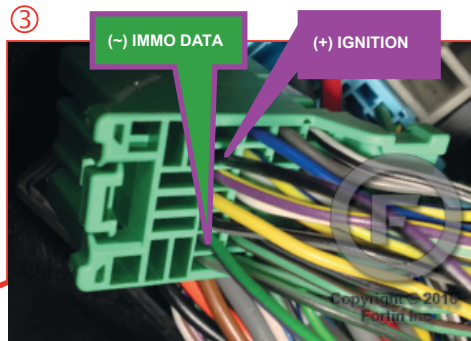

AUTOMATIC TRANSMISSION WIRING CONNECTION

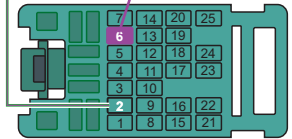
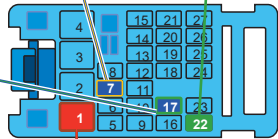
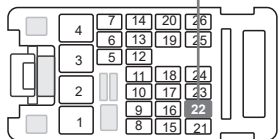
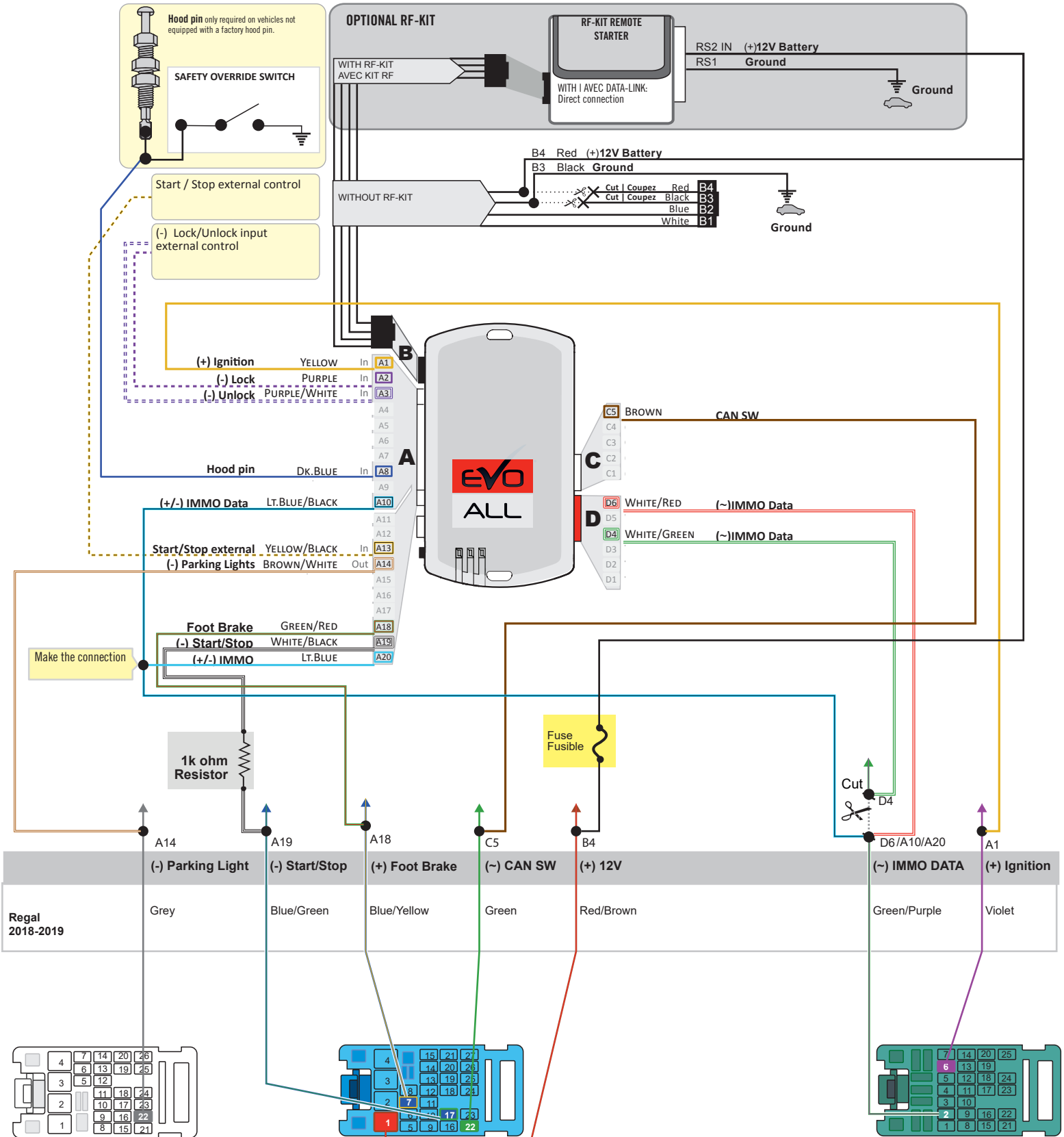

① Back view, 26-Pin White connector, at BCM.

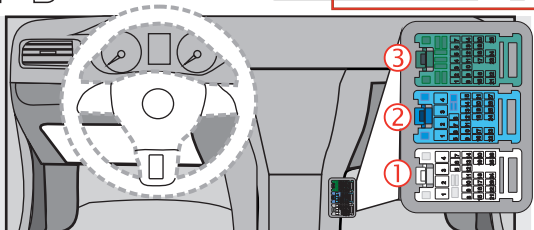

② Back view, 27-Pin Blue connector, at BCM.

③ Back view, 25-Pin Green connector, at BCM.

THAR-GM6 | AUTOMATIC TRANSMISSION CONNECTION

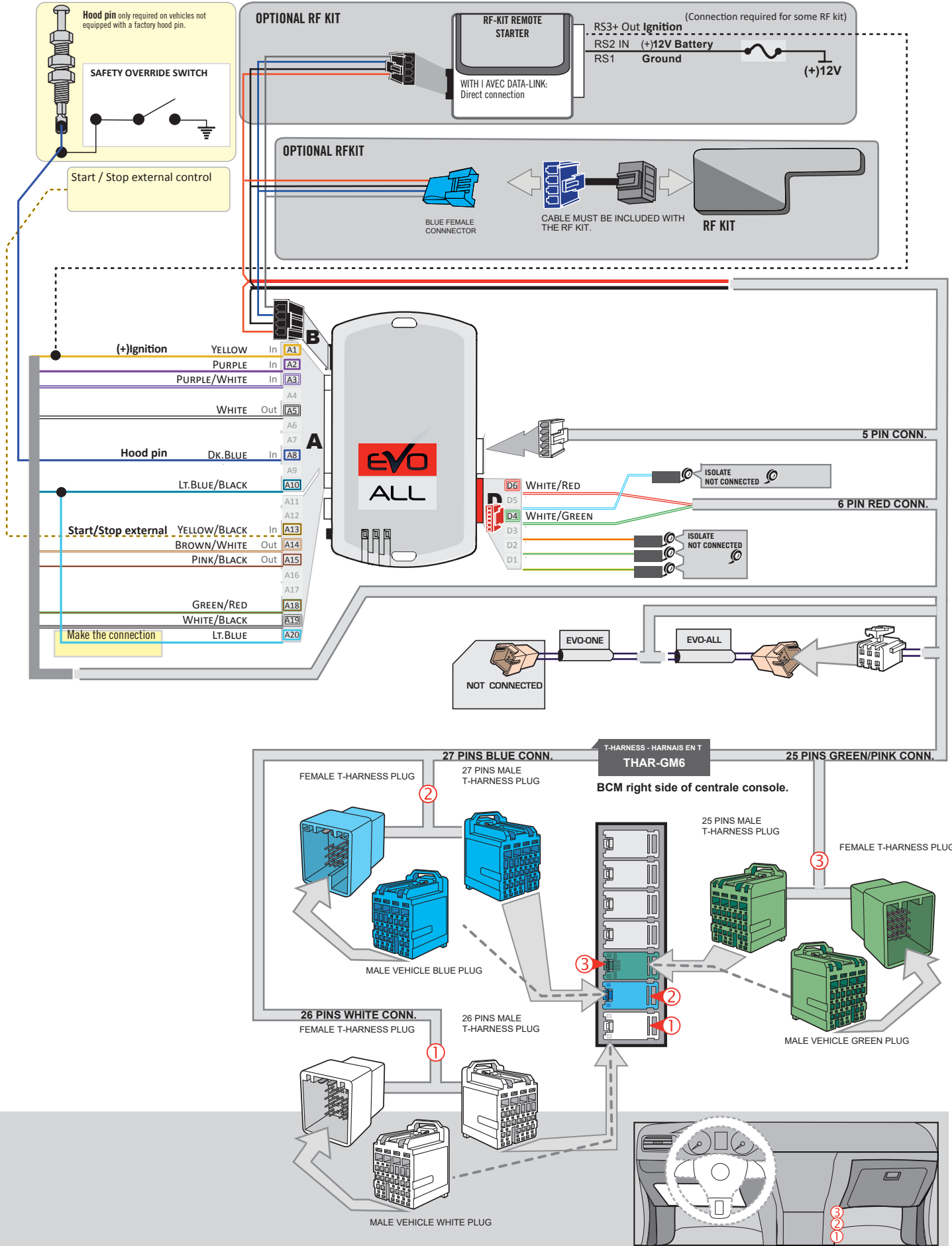

KEY BYPASS PROGRAMMING PROCEDURE 1/3 |



- 1** Remove the battery from the OEM remote.
- 2** Place the OEM remote in the **back** cup holder in the center console.
Refer to vehicle user guide for keyport location.

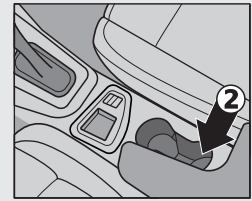

1

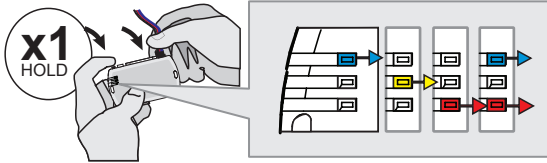

Press and hold the programming button:
Connect the 4-PIN Data-link harness (Black connector).

↳The Blue, Red, Yellow and Blue & Red LEDs will alternatively illuminate.

2

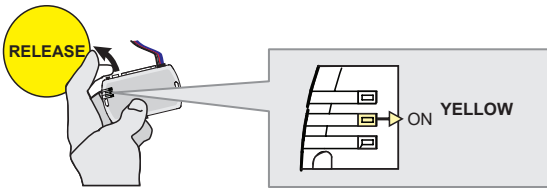

Release the programming button when the LED is **YELLOW**.

If the LED is not solid YELLOW disconnect the 4-Pin connector (Data-Link) and go back to step 1.

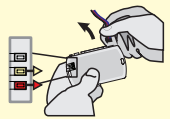

3

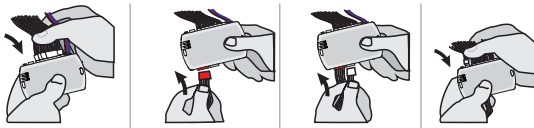

Insert the required remaining connectors.

4

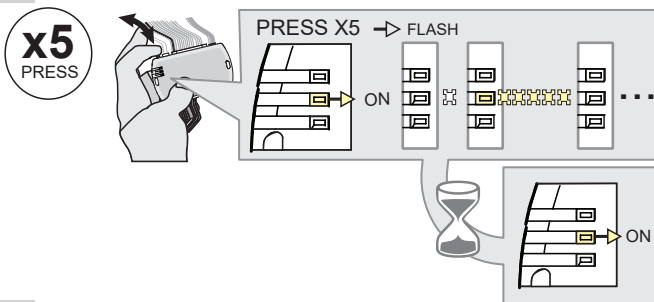

Press and release the programming button five (5x) times.

↳The **YELLOW LED** will flash 5 times each second.

↳**WAIT** for the **YELLOW LED** to turn ON solide.

5

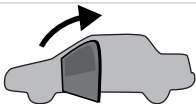

Open the driver door.

6

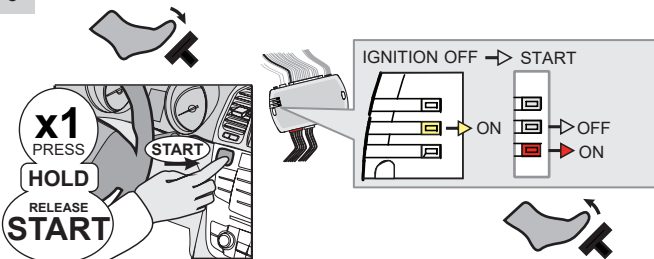

Press the foot-brake pedal.

Press the Push-to-Start button until the engine start.

Release the foot-brake pedal.

↳The **RED LED** will turn ON.
↳The **YELLOW LED** will turn OFF.

KEY BYPASS PROGRAMMING PROCEDURE 2/3

7



Press the Push-to-Start button until the engine turn OFF.

8

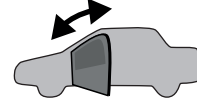

Close and open the driver door.

9

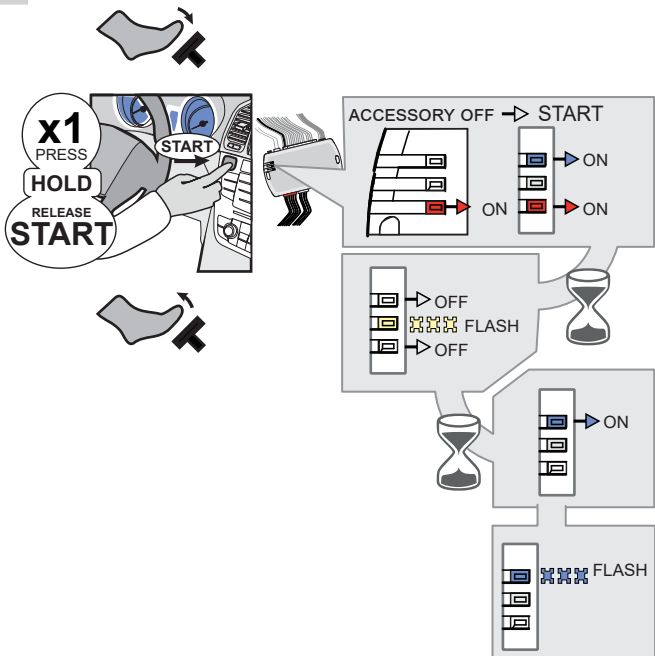

Press the foot-brake pedal.

Press the Push-to-Start button until the engine start.

Release the foot-brake pedal.

- ↳ The BLUE LED will turn ON.
- ↳ The BLUE LED will turn OFF. The RED LED will turn OFF.
- ↳ The YELLOW LED will flash rapidly
- ↳ The BLUE LED will turn ON.
- ↳ The BLUE LED will flash rapidly

10

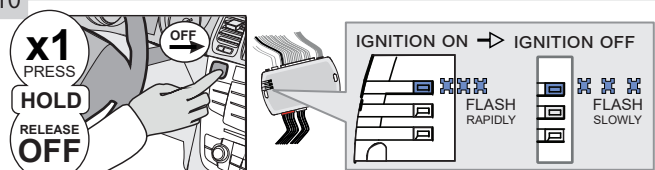

Press the Push-to-Start button until the engine turn OFF.

- ↳ The BLUE LED will flash slowly

11

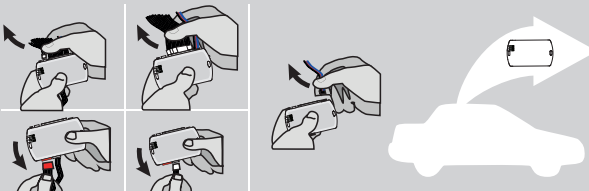

Disconnect all the connectors and after the Data-Link (4-pins) connector.

12

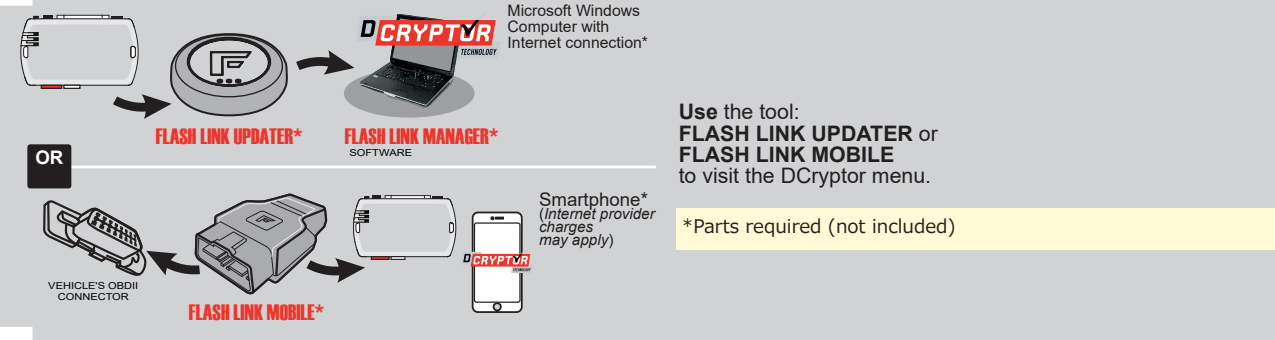

Use the tool: FLASH LINK UPDATER or FLASH LINK MOBILE to visit the DCRYPTOR menu.

***Parts required (not included)**

KEY BYPASS PROGRAMMING PROCEDURE 3/3

13

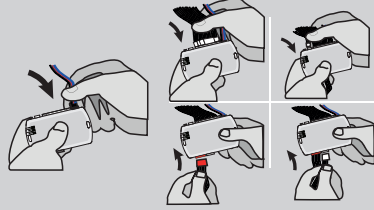
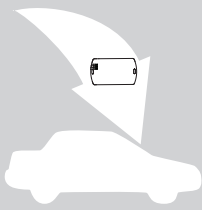

AFTER DCRYPTOR PROGRAMMING COMPLETED
Go back to the vehicle and **reconnect** the 4-Pin (Data-Link) connector and after, all the remaining connector.



The module is now programmed.



REMOTE STARTER / ALARM VERIFICATION PROCEDURE

Test the remote starter. **Remote start** the vehicle.

OPTIONAL RF-KIT PROGRAMMING



PROGRAM BYPASS OPTION

	<p>Program bypass option:</p>	<p>H2</p>	<p>Supported RF-KITS enable</p> <p>H2 Fortin 2</p>

OPTIONAL FORTIN RF KIT SERIES 4 OR SERIES 9 PROGRAMMING



The module must be programmed on the vehicle.

MAKE SURE THE IGNITION KEY HAS BEEN IN THE OFF POSITION FOR AT LEAST 5 SECONDS.

1

ON



x1 PRESS (HOLD) START

Press the foot-brake pedal. Press the Push-to-Start button until the engine start. Release the foot-brake pedal.

2

OFF



x1 PRESS (HOLD) START OFF

Press the Push-to-Start button until the engine turn OFF.

3

ON



x1 PRESS (HOLD) START

Press the foot-brake pedal. Press the Push-to-Start button until the engine start. Release the foot-brake pedal.

4

4X BRAKES



x4 PRESS

Press and release the brake pedal four times.

5

ON EACH TRANSMITTER

4 BUTTONS



Press and release the brake pedal four times.

1 BUTTON

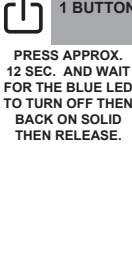

Press approx. 12 sec. and wait for the blue LED to turn off then back on solid then release.

6

OFF



x1 PRESS (HOLD) START OFF

Press the Push-to-Start button until the engine turn OFF.

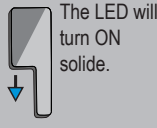

The LED will turn ON solide.

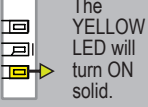

The YELLOW LED will turn ON solid.

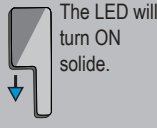

The LED will turn ON solide.

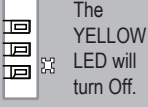

The YELLOW LED will turn Off.

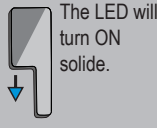

The LED will turn ON solide.

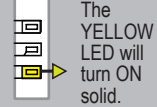

The YELLOW LED will turn ON solid.

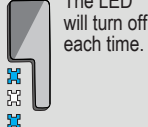

The LED will turn off each time.

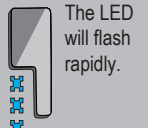

The LED will flash rapidly.

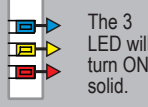

The 3 LED will turn ON solid.

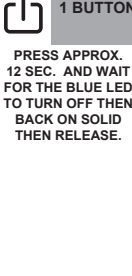

The LED will turn off each time.

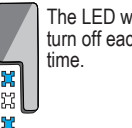

The LED will turn off each time.

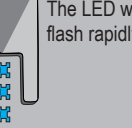

The LED will flash rapidly.

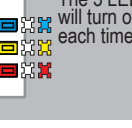

The 3 LED will turn off each time.

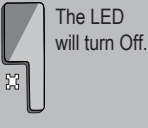

The LED will turn Off.

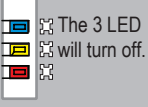

The 3 LED will turn off.



REMOTE STARTER FUNCTIONALITY



All doors must be closed.



Remote start the vehicle.



Unlock the doors with either:

- The OEM remote
- The remote-starter remote
- Or the proximity remote



Enter the vehicle with the Intelligent Key.



The vehicle can now be put in to gear and driven.

If the vehicle is not unlocked with one of these conditions the remote-starter will shut down as soon as any door is opened.





STAND ALONE INSTALLATION AND THAR-GM6

ADDENDUM - SUGGESTED WIRING CONFIGURATION



ONLY COMPATIBLE WITH AUTOMATIC TRANSMISSION VEHICLES.

VEHICLE	YEARS	Vehicle functions supported in this diagram (functional if equipped)																	
		Immobilizer bypass	Lock	Unlock	Arm	Disarm	Parking Light	Trunk (open)	RAP Disable	Tachometer	Door Status	Trunk Status	Hand-Brake Status	Foot-Brake Status	OEM Remote Monitoring				
																			
CADILLAC																			
SRX	Push-To-Start	2010-2012	•	•	•	•	•	•	•	•	•	•	•	•	•	•	•	•	•



FIRMWARE VERSION



70.[41]

GM MINIMUM

To add the firmware version and the options, use the **FLASH LINK UPDATER** or **FLASH LINK MOBILE** tool, sold separately.

IF THE VEHICLE IS NOT EQUIPPED WITH FUNCTIONAL HOOD PIN:	A11	OFF	Hood trigger (Output Status).
--	-----	-----	-------------------------------

	UNIT OPTION	DESCRIPTION
 <p>Program bypass option:</p>	C1	OEM Remote status (Lock/Unlock) monitoring
	D6	Push-to-Start

	ATTENTION!	 <p>DATE: XX-XX</p>	E5	OFF	<p>SPECIAL FUNCTIONS: BY DEFAULT DEACTIVATED</p>
			ON	<p>MANUFACTURED MODULES BETWEEN: 04/2018 TO 04/2019</p>	

MANDATORY INSTALL

*HOOD PIN



HOOD STATUS: THE HOOD PIN SWITCH MUST BE INSTALLED IF THE VEHICLE CAN BE REMOTE STARTED WITH THE HOOD OPEN, SET FUNCTION A11 TO OFF.

A11

OFF

Notice: the installation of safety elements are mandatory. The hood pin is an essential security element and must be installed.

THIS MODULE MUST BE INSTALLED BY A QUALIFIED TECHNICIAN. A WRONG CONNECTION CAN CAUSE PERMANENT DAMAGE TO THE VEHICLE.

PARTS REQUIRED (NOT INCLUDED)

1x **FLASH LINK UPDATER**
 1x **FLASH LINK MANAGER**
 SOFTWARE
 1x Microsoft Windows Computer with Internet connection

OR

1x **FLASH LINK MOBILE**
 1x **FLASH LINK MOBILE APP**
 Smartphone *Android* or *iOS* with Internet connection (*provider charges may apply*).
 1x

MANDATORY



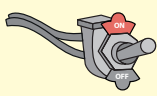

HOOD PIN 

REMOTE START SAFETY OVERRIDE SWITCH 

Part #: RSPB available, Sold separately.

Notice: the installation of safety elements are mandatory. The hood pin and the valet switch are essential security elements and must be installed.

STAND ALONE CONFIGURATION

	Program bypass option	UNIT OPTION	DESCRIPTION
	OEM Remote Stand Alone Remote Starter:	D1.10 	By default, LOCK, LOCK, LOCK Par défaut, VERROUILLE,VERROUILLE,VERROUILLE
		D1.1 	
	Program bypass option with oem remote:	C1	OEM Remote Monitoring
	Program bypass option with RF KIT antenna:	H1 to H6	Supported RF Kits and select RF Kit

REMOTE STARTER FUNCTIONALITY



All doors must be closed.

3X 

Press the OEM remote's Lock button 3x to remote-start (or remote-stop) the vehicle.



START 

The vehicle will START.

REMOTE STARTER DIAGNOSTICS
MODULE RED LED

x2 flash :	Brake ON
x3 flash :	No tach
x4 flash :	Ignition before start
x5 flash :	Hood Open

REMOTE STARTER WARNING CARD



CUT THIS WARNING CARD AND STICK IT ON A VISIBLE PLACE:
 or use the package **RSPB**, Sold separately.

WARNING | ATTENTION



REMOTE STARTER

THE VEHICLE CAN BE STARTED BY EITHER: PRESSING THE LOCK BUTTON ON THE OEM REMOTE 3 TIMES CONSECUTIVELY OR BY A SMARTPHONE. **TURN ON** THE SAFETY SWITCH LOCATED UNDER THE DASHBOARD BEFORE WORKING ON THE VEHICLE.

DESCRIPTION

Parts required (Not included) PAGE

WIRE TO WIRE DIAGRAM

1X 5 Amp Fuse 1X 1k Ohm Resistor	Page 4
-------------------------------------	--------

THARNES DIAGRAM

THARNES THAR-GM6	1x THAR-GM6	Page 5
------------------	-------------	--------

BCM

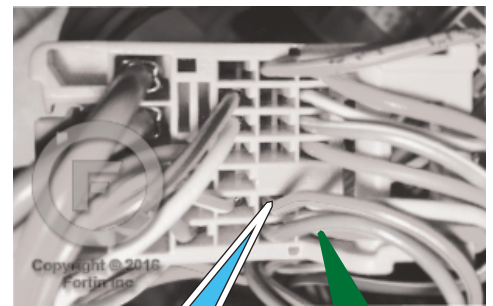
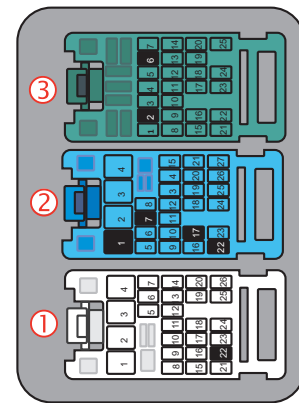
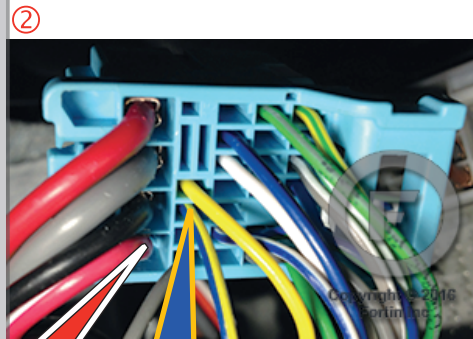
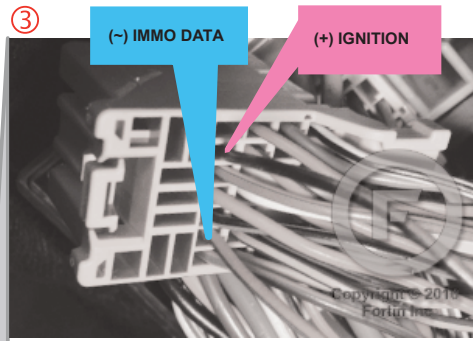
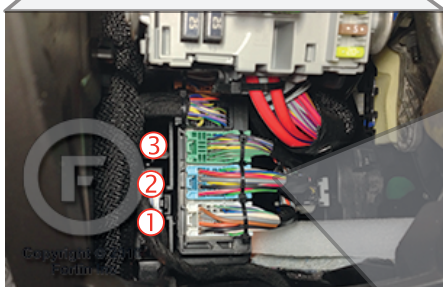
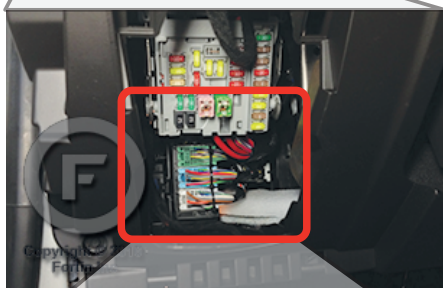

AUTOMATIC TRANSMISSION WIRING CONNECTION

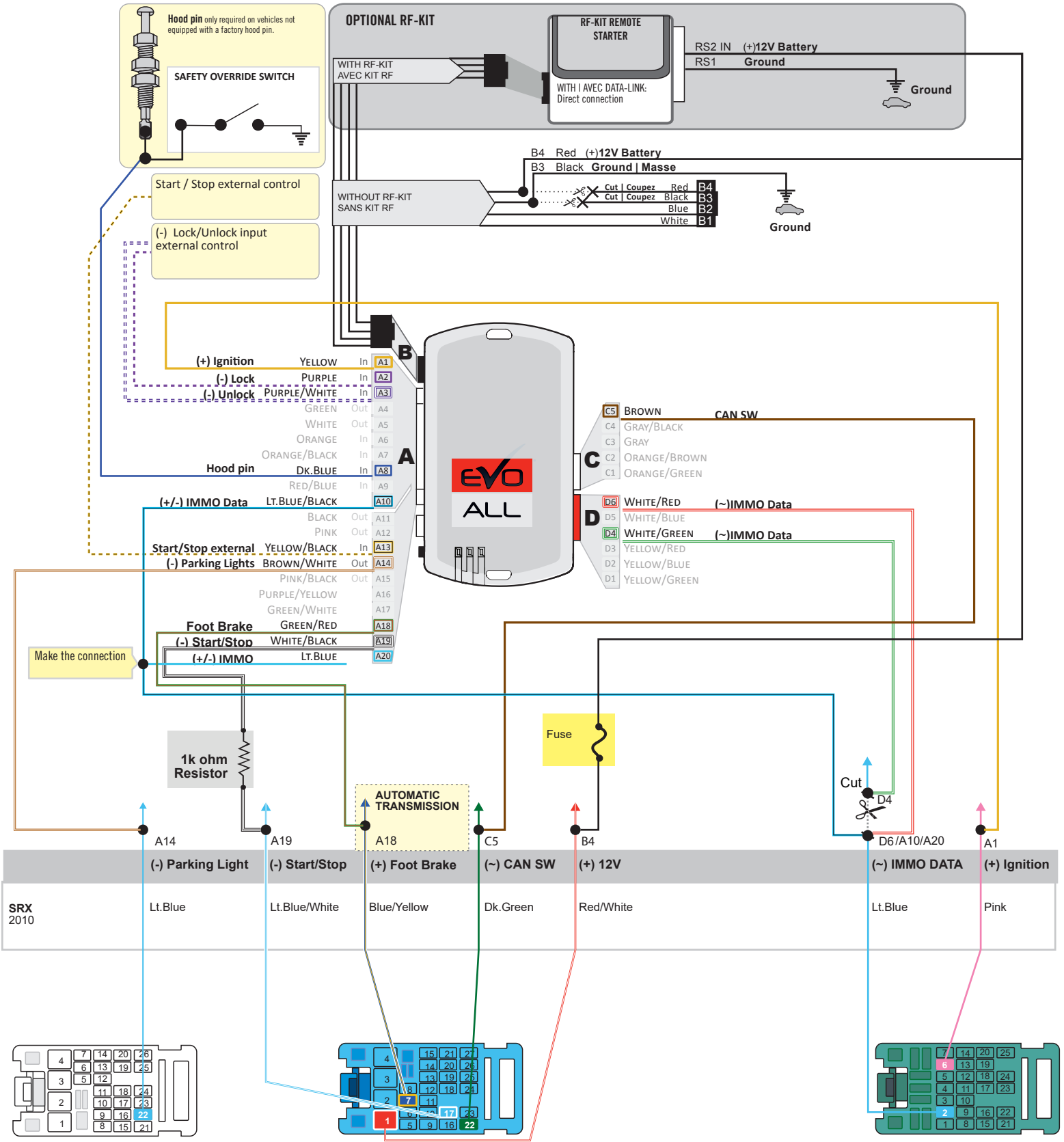

① Back view, 26-Pin White connector, at BCM.

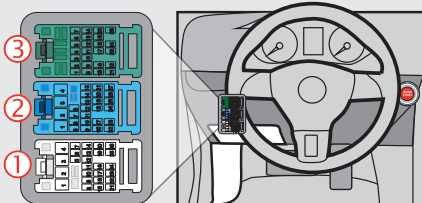

② Back view, 27-Pin Blue connector, at BCM.

③ Back view, 25-Pin Green connector, at BCM.

THAR-GM6 | AUTOMATIC TRANSMISSION CONNECTION

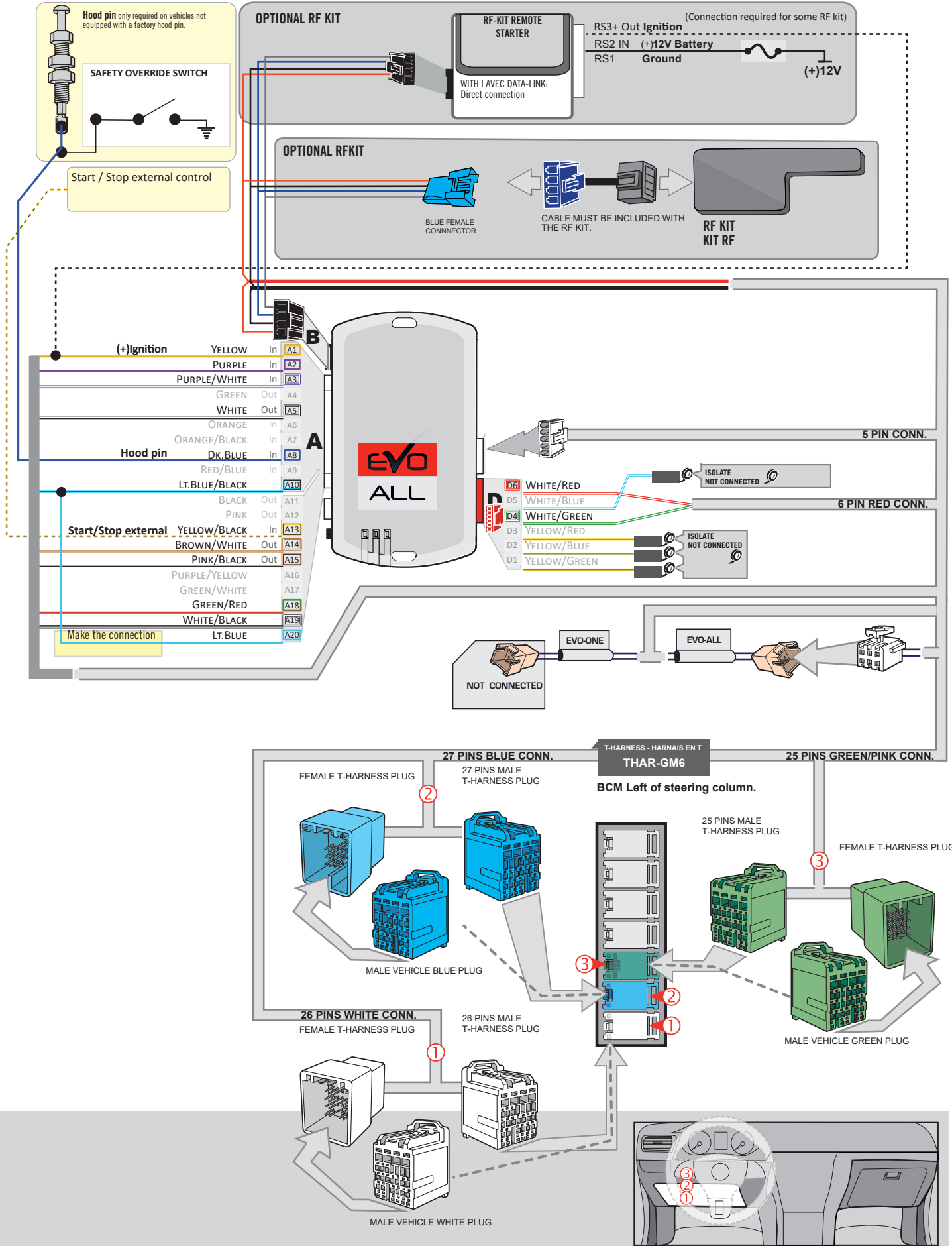

KEY BYPASS PROGRAMMING PROCEDURE 1/3

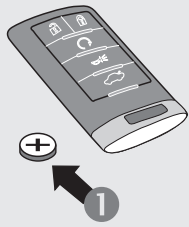

1 Remove the battery from the OEM remote.

2 Place the OEM remote into the transmitter pocket of the center console.

Refer to vehicle user guide for keyport location.

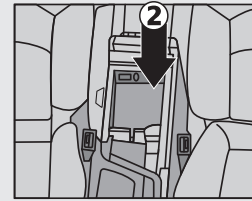

1

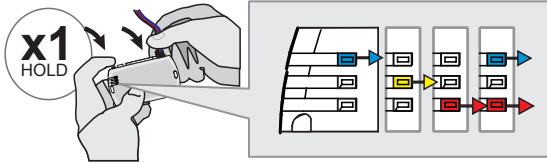

Press and hold the programming button:
Connect the 4-PIN Data-link harness (Black connector).

↳The Blue, Red, Yellow and Blue & Red LEDs will alternatively illuminate.

2

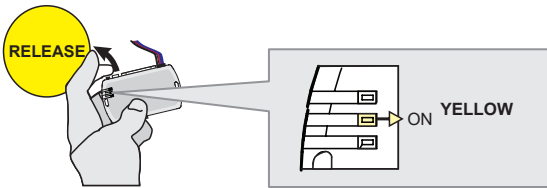

Release the programming button when the LED is YELLOW.

If the LED is not solid YELLOW disconnect the 4-Pin connector (Data-Link) and go back to step 1.

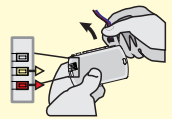

3

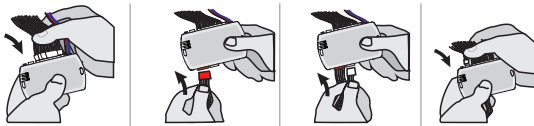

Insert the required remaining connectors.

4

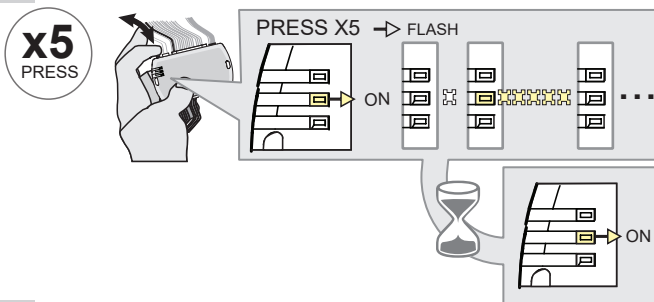

Press and release the programming button five (5x) times.

↳The YELLOW LED will flash 5 times each second.

↳WAIT for the YELLOW LED to turn ON solide.

5

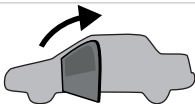

Open the driver door.

6

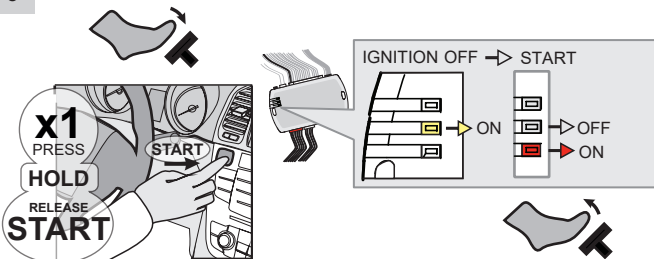

Press the foot-brake pedal.

Press the Push-to-Start button until the engine start.

Release the foot-brake pedal.

↳The RED LED will turn ON.
↳The YELLOW LED will turn OFF.

KEY BYPASS PROGRAMMING PROCEDURE 2/3

7



Press the Push-to-Start button until the engine turn OFF.

8

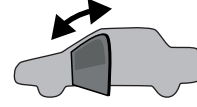

Close and open the driver door.

9

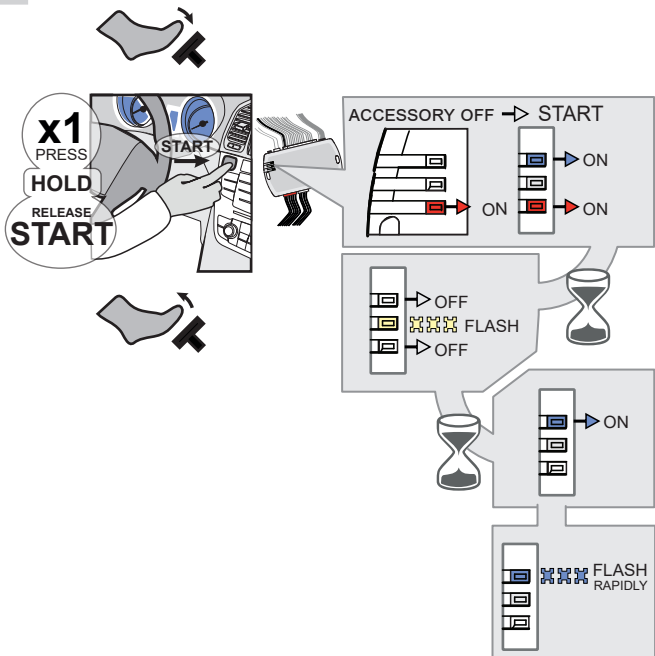

Press the foot-brake pedal.

Press the Push-to-Start button until the engine start.

Release the foot-brake pedal.

- ↳ The BLUE LED will turn ON.
- ↳ The BLUE LED will turn OFF. The RED LED will turn OFF.
- ↳ The YELLOW LED will flash rapidly
- ↳ The BLUE LED will turn ON.
- ↳ The BLUE LED will flash rapidly

10

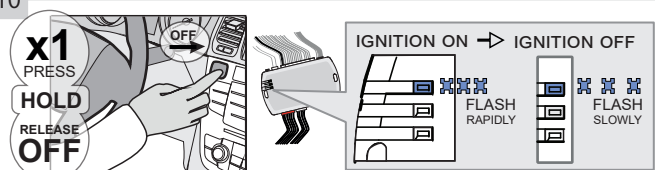

Press the Push-to-Start button until the engine turn OFF.

- ↳ The BLUE LED will flash slowly

11

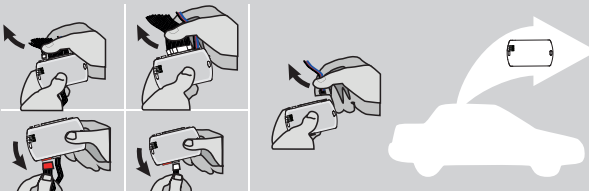

Disconnect all the connectors and after the Data-Link (4-pins) connector.

12

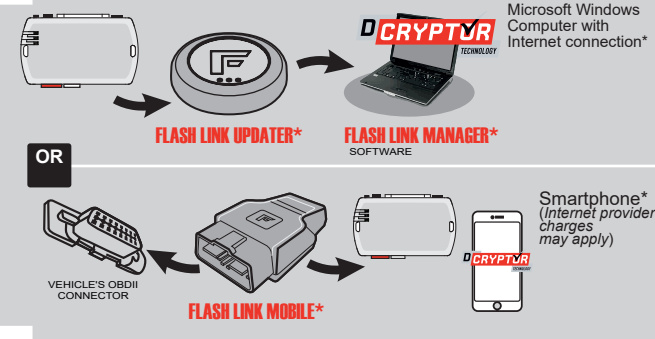

Use the tool: FLASH LINK UPDATER or FLASH LINK MOBILE to visit the DCryptor menu.

*Parts required (not included)

KEY BYPASS PROGRAMMING PROCEDURE 3/3

13

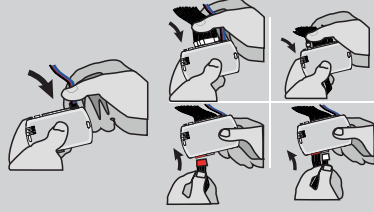
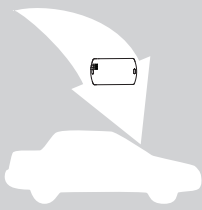

AFTER DCRYPTOR PROGRAMMING COMPLETED
Go back to the vehicle and **reconnect** the 4-Pin (Data-Link) connector and after, all the remaining connector.



The module is now programmed.



REMOTE STARTER / ALARM VERIFICATION PROCEDURE

Test the remote starter. Remote start the vehicle.

REMOTE STARTER FUNCTIONALITY |



All doors must be closed.



Remote start the vehicle.



Unlock the doors with either:

- The OEM remote
- The remote-starter remote
- Or the proximity remote

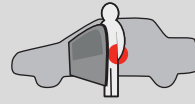

Enter the vehicle with the Intelligent Key.



The vehicle can now be put in to gear and driven.

If the vehicle is not unlocked with one of these conditions the remote-starter will shut down as soon as any door is opened.





STAND ALONE INSTALLATION AND THAR-GM6

ADDENDUM - SUGGESTED WIRING CONFIGURATION



ONLY COMPATIBLE WITH AUTOMATIC TRANSMISSION VEHICLES.

VEHICLE	YEARS	Vehicle functions supported in this diagram (functional if equipped)													
		Immobilizer bypass	Lock	Unlock	Arm	Disarm	Parking Light	Trunk (open)	RAP Disable	Tachometer	Door Status	Trunk Status	Hand-Brake Status	Foot-Brake Status	OEM Remote Monitoring
															
CADILLAC															
SRX	Push-To-Start	2013-2016	•	•	•	•	•	•	•	•	•	•	•	•	•



FIRMWARE VERSION



70.[41]

GM MINIMUM

To add the firmware version and the options, use the **FLASH LINK UPDATER** or **FLASH LINK MOBILE** tool, sold separately.

IF THE VEHICLE IS NOT EQUIPPED WITH FUNCTIONAL HOOD PIN:	A11	OFF	Hood trigger (Output Status). ontact de capot (état de sortie).
--	------------	------------	--

	UNIT OPTION	DESCRIPTION
 <p>Program bypass option:</p>	C1	OEM Remote status (Lock/Unlock) monitoring
	D6	Push-to-Start

	ATTENTION!	 <p>DATE: XX-XX</p>	E5	OFF	<p>SPECIAL FUNCTIONS: BY DEFAULT DEACTIVATED</p>
				ON	<p>MANUFACTURED MODULES BETWEEN: 04/2018 TO 04/2019</p>

MANDATORY INSTALL

*HOOD PIN



HOOD STATUS: THE HOOD PIN SWITCH MUST BE INSTALLED IF THE VEHICLE CAN BE REMOTE STARTED WITH THE HOOD OPEN, SET FUNCTION **A11** TO OFF.

A11

OFF

Notice: the installation of safety elements are mandatory. The hood pin is an essential security element and must be installed.

THIS MODULE MUST BE INSTALLED BY A QUALIFIED TECHNICIAN. A WRONG CONNECTION CAN CAUSE PERMANENT DAMAGE TO THE VEHICLE.

PARTS REQUIRED (NOT INCLUDED)

1x **FLASH LINK UPDATER**,
 1x **FLASH LINK MANAGER**
 SOFTWARE
 1x Microsoft Windows Computer
 with Internet connection

OR

1x **FLASH LINK MOBILE**
 1x **FLASH LINK MOBILE APP**
 Smartphone *Android* or *iOS* with Internet
 connection (*provider charges may apply*).

MANDATORY

HOOD PIN

REMOTE START SAFETY OVERRIDE SWITCH

VALET SWITCH

Part #: RSPB available, Sold separately.

Notice: the installation of safety elements are mandatory. The hood pin and the valet switch are essential security elements and must be installed.

STAND ALONE CONFIGURATION

	Program bypass option	UNIT OPTION	DESCRIPTION
	OEM Remote Stand Alone Remote Starter:	OR D1.10 D1.1	By default, LOCK, LOCK, LOCK Par défaut, VERROUILLE,VERROUILLE,VERROUILLE
	Program bypass option with oem remote:	C1	OEM Remote Monitoring
	Program bypass option with RF KIT antenna:	H1 to H6	Supported RF Kits and select RF Kit

REMOTE STARTER FUNCTIONALITY

All doors must be closed.

3X

Press the OEM remote's Lock button 3x to remote-start (or remote-stop) the vehicle.

The vehicle will START.

REMOTE STARTER DIAGNOSTICS
MODULE RED LED

x2 flash :	Brake ON
x3 flash :	No tach
x4 flash :	Ignition before start
x5 flash :	Hood Open

REMOTE STARTER WARNING CARD

CUT THIS WARNING CARD AND STICK IT ON A VISIBLE PLACE:
 or use the package **RSPB**, Sold separately.

WARNING | ATTENTION

REMOTE STARTER

THE VEHICLE CAN BE STARTED BY EITHER: PRESSING THE LOCK BUTTON ON THE OEM REMOTE 3 TIMES CONSECUTIVELY OR BY A SMARTPHONE. **TURN ON** THE SAFETY SWITCH LOCATED UNDER THE DASHBOARD BEFORE WORKING ON THE VEHICLE.

DESCRIPTION

Parts required (Not included) PAGE

WIRE TO WIRE DIAGRAM

1X 5 Amp Fuse 1X 1k Ohm Resistor	Page 4
-------------------------------------	--------

THARNES DIAGRAM

THARNES THAR-GM6	1x THAR-GM6	Page 5
------------------	-------------	--------

BCM

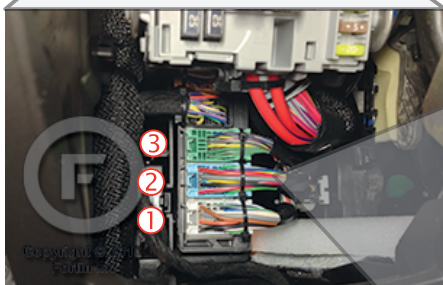
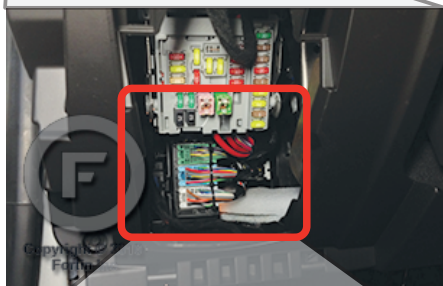

SRX
2013-2016

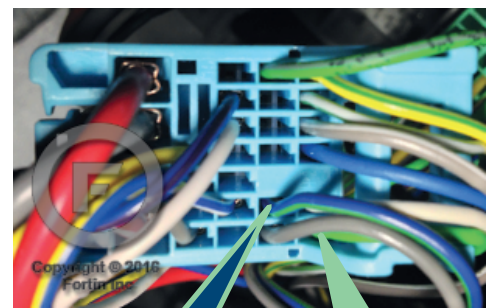
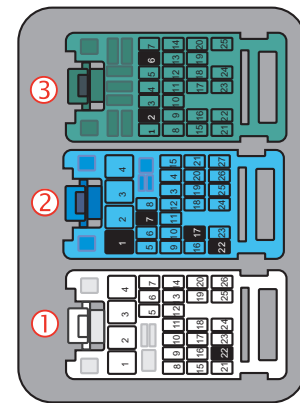
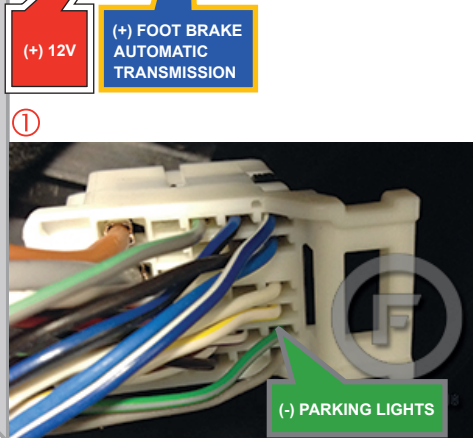
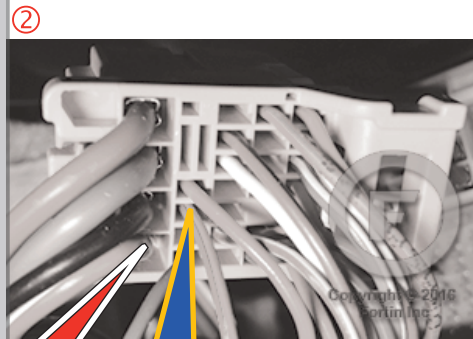
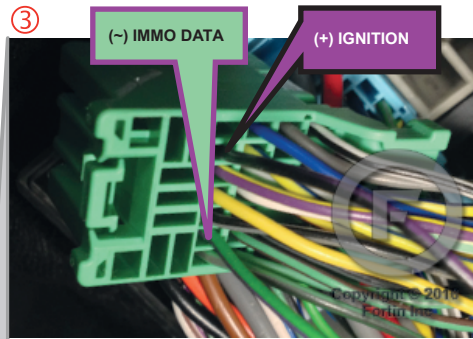

AUTOMATIC TRANSMISSION WIRING CONNECTION

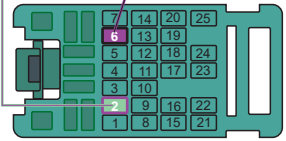
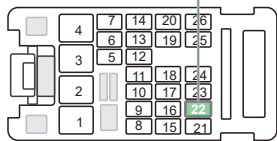
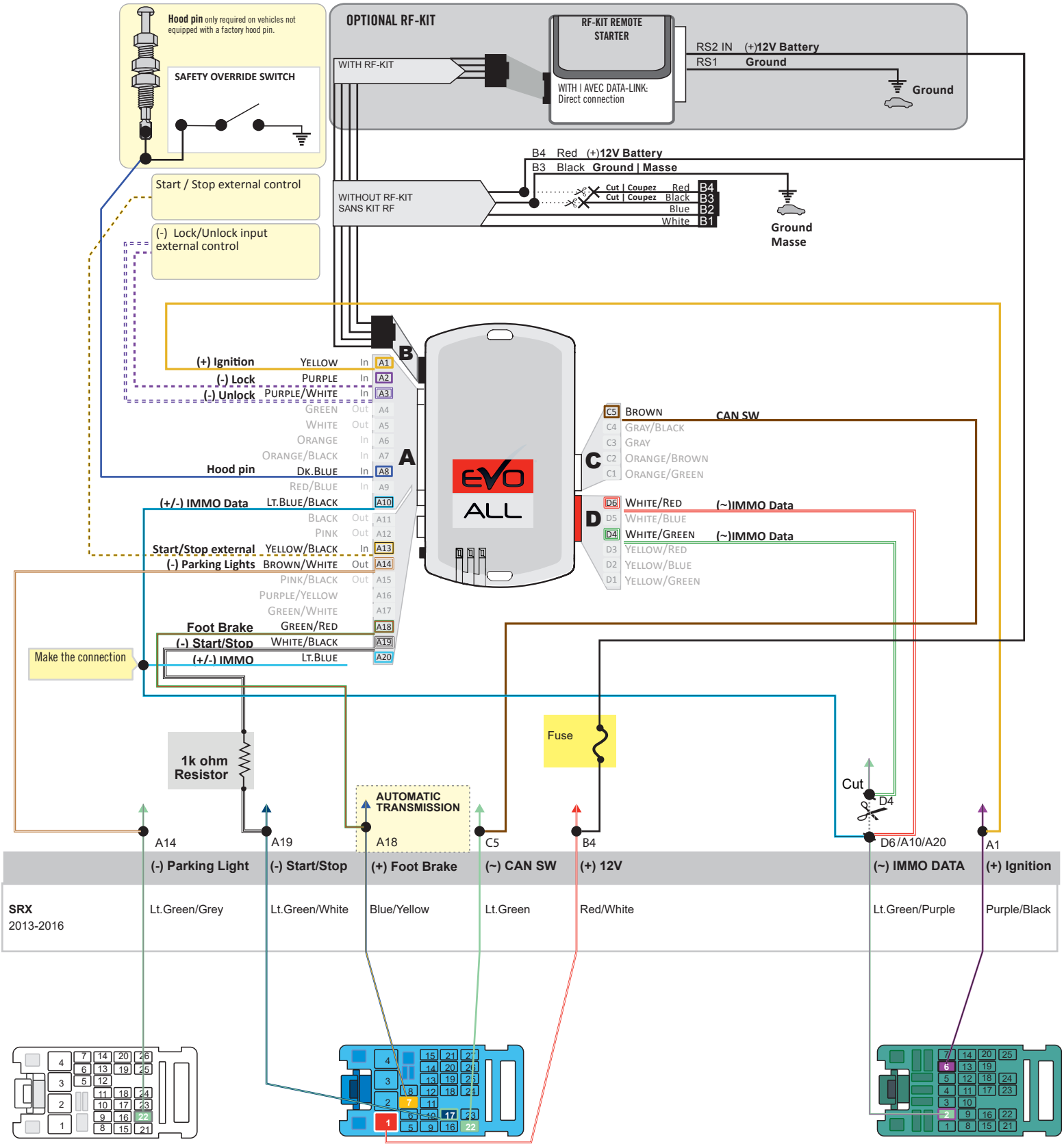

① Back view, 26-Pin White connector, at BCM.

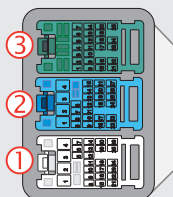

② Back view, 27-Pin Blue connector, at BCM.

③ Back view, 25-Pin Green connector, at BCM.

THAR-GM6 | AUTOMATIC TRANSMISSION CONNECTION

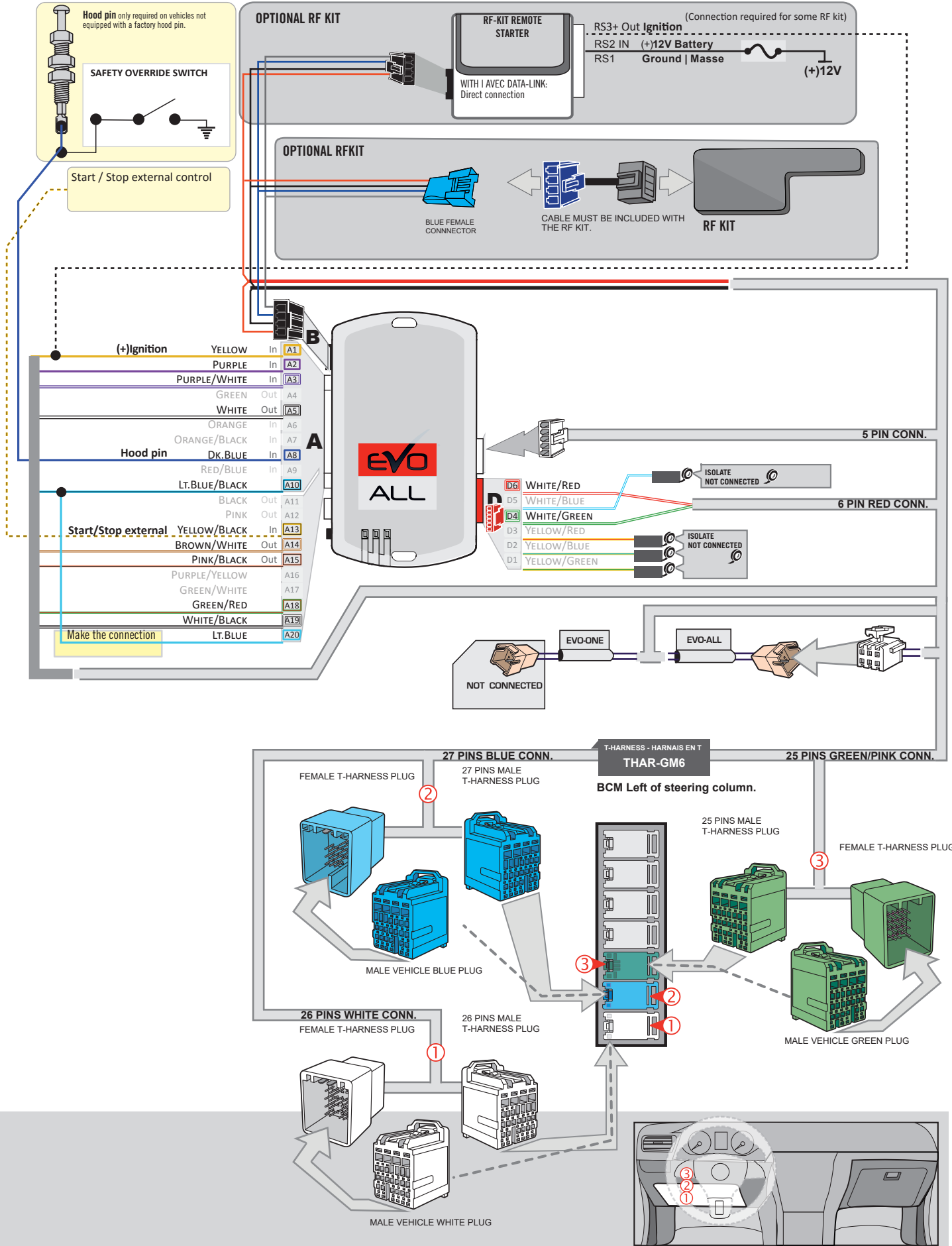

KEY BYPASS PROGRAMMING PROCEDURE 1/3

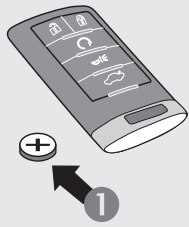

1 Remove the battery from the OEM remote.

2 Place the OEM remote into the transmitter pocket of the center console.

Refer to vehicle user guide for keyport location.

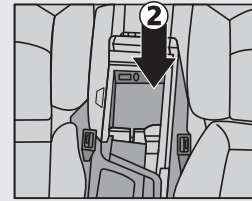

1

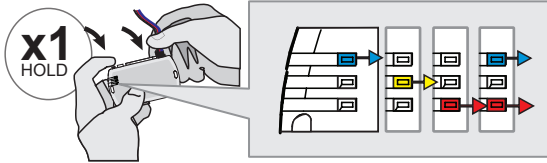

Press and hold the programming button:
Connect the 4-PIN Data-link harness (Black connector).

↳The Blue, Red, Yellow and Blue & Red LEDs will alternatively illuminate.

2

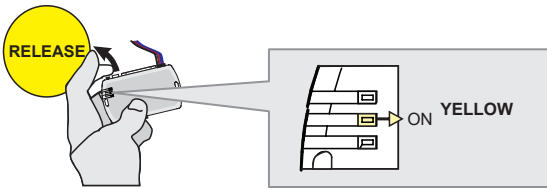

Release the programming button when the LED is **YELLOW**.

If the LED is not solid YELLOW disconnect the 4-Pin connector (Data-Link) and go back to step 1.

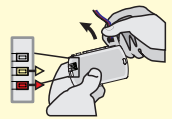

3

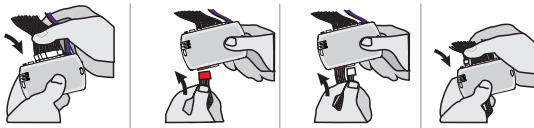

Insert the required remaining connectors.

4

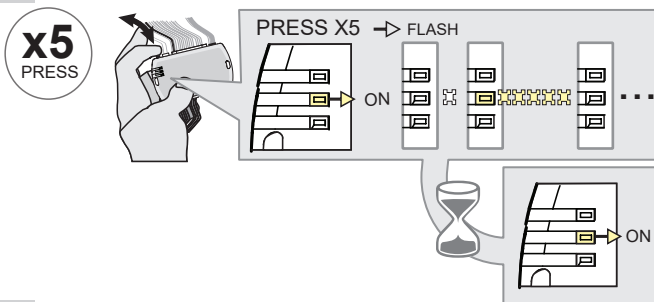

Press and release the programming button five (5x) times.

↳The YELLOW LED will flash 5 times each second.

↳**WAIT** for the YELLOW LED to turn ON solide.

5

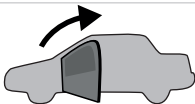

Open the driver door.

6

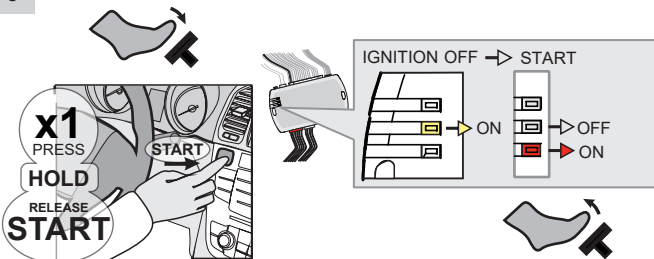

Press the foot-brake pedal.

Press the Push-to-Start button until the engine start.

Release the foot-brake pedal.

↳The RED LED will turn ON.
 ↳The YELLOW LED will turn OFF.

KEY BYPASS PROGRAMMING PROCEDURE 2/3

7



Press the Push-to-Start button until the engine turn OFF.

8

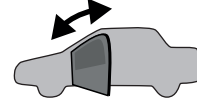

Close and open the driver door.

9

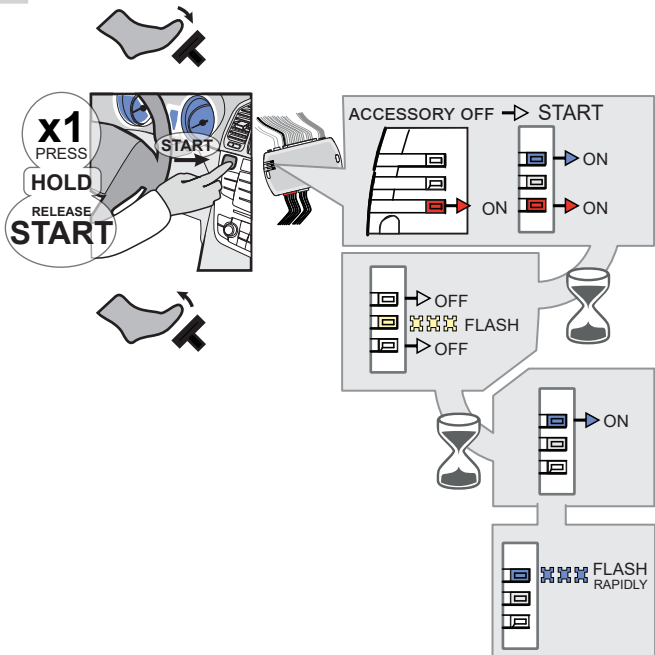

Press the foot-brake pedal.

Press the Push-to-Start button until the engine start.

Release the foot-brake pedal.

- ↳ The BLUE LED will turn ON.
- ↳ The BLUE LED will turn OFF. The RED LED will turn OFF.
- ↳ The YELLOW LED will flash rapidly
- ↳ The BLUE LED will turn ON.
- ↳ The BLUE LED will flash rapidly

10

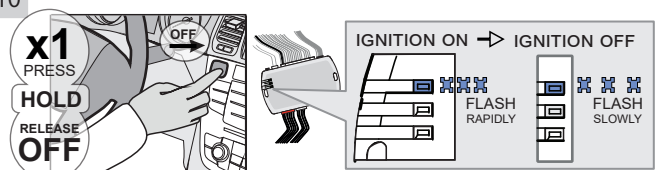

Press the Push-to-Start button until the engine turn OFF.

- ↳ The BLUE LED will flash slowly

11

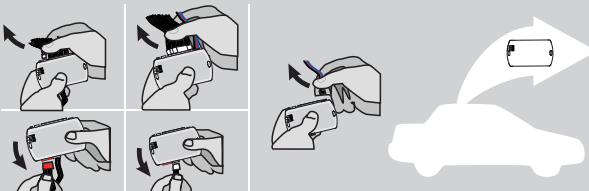

Disconnect all the connectors and after the Data-Link (4-pins) connector.

12

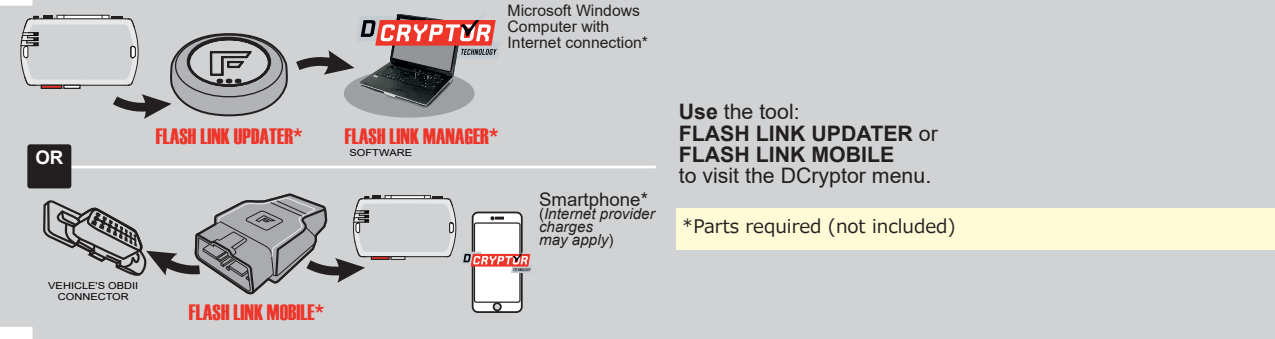

Microsoft Windows Computer with Internet connection*

FLASH LINK UPDATER* **FLASH LINK MANAGER***
SOFTWARE

OR

VEHICLE'S OBDII CONNECTOR **FLASH LINK MOBILE*** Smartphone*
(Internet provider charges may apply)

Use the tool: FLASH LINK UPDATER or FLASH LINK MOBILE to visit the DCRYPTOR menu.

***Parts required (not included)**

KEY BYPASS PROGRAMMING PROCEDURE 3/3

13

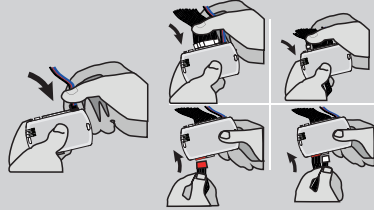
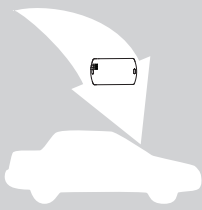

AFTER DCRYPTOR PROGRAMMING COMPLETED
Go back to the vehicle and **reconnect** the 4-Pin (Data-Link) connector and after, all the remaining connector.



The module is now programmed.



REMOTE STARTER / ALARM VERIFICATION PROCEDURE

Test the remote starter. Remote start the vehicle.

OPTIONAL RF-KIT PROGRAMMING

PROGRAM BYPASS OPTION

	<p>Program bypass option:</p>	<p>H2</p>	<p>Supported RF-KITS enable</p> <p>H2 Fortin 2</p>

OPTIONAL FORTIN RF KIT SERIES 4 OR SERIES 9 PROGRAMMING



The module must be programmed on the vehicle.



MAKE SURE THE IGNITION KEY HAS BEEN IN THE OFF POSITION FOR AT LEAST 5 SECONDS.

1

ON



ON

Press the foot-brake pedal. Press the Push-to-Start button until the engine start. Release the foot-brake pedal.

2

OFF



OFF

Press the Push-to-Start button until the engine turn OFF.

3

ON



ON

Press the foot-brake pedal. Press the Push-to-Start button until the engine start. Release the foot-brake pedal.

4

4X BRAKES



4X PRESS

Press and release the brake pedal four times.

frein.



The LED will turn off each time.

5

ON EACH TRANSMITTER

4 BUTTONS



PRESS AND RELEASE



PRESS AND RELEASE

1 BUTTON



PRESS APPROX. 12 SEC. AND WAIT FOR THE BLUE LED TO TURN OFF THEN BACK ON SOLID THEN RELEASE.



The LED will turn off each time.



The LED will flash rapidly.



The 3 LED will turn off each time.

6

OFF



OFF

Press the Push-to-Start button until the engine turn OFF.



The LED will turn Off.



The 3 LED will turn off.



REMOTE STARTER FUNCTIONALITY



All doors must be closed.



Remote start the vehicle.



Unlock the doors with either:

- The OEM remote
- The remote-starter remote
- Or the proximity remote



Enter the vehicle with the Intelligent Key.



The vehicle can now be put in to gear and driven.

If the vehicle is not unlocked with one of these conditions the remote-starter will shut down as soon as any door is opened.



STAND ALONE INSTALLATION AND THAR-GM6

ADDENDUM - SUGGESTED WIRING CONFIGURATION



ONLY COMPATIBLE WITH AUTOMATIC TRANSMISSION VEHICLES.

VEHICLE			Vehicle functions supported in this diagram (functional if equipped)													
VEHICLE	YEARS		Immobilizer bypass	Lock	Unlock	Arm	Disarm	Parking Light	Trunk (open)	RAP Disable	Tachometer	Door Status	Trunk Status	Hand-Brake Status	Foot-Brake Status	OEM Remote Monitoring
																
CADILLAC																
XTS	Push-To-Start	2013-2018	•	•	•	•	•	•	•	•	•	•	•	•	•	•



FIRMWARE VERSION

70.[41]

GM MINIMUM

To add the firmware version and the options, use the **FLASH LINK UPDATER** or **FLASH LINK MOBILE** tool, sold separately.

IF THE VEHICLE IS NOT EQUIPPED WITH FUNCTIONAL HOOD PIN:	A11	OFF	Hood trigger (Output Status).
---	------------	------------	-------------------------------

	UNIT OPTION	DESCRIPTION
 <p>Program bypass option:</p>	C1	OEM Remote status (Lock/Unlock) monitoring
	D6	Push-to-Start

	ATTENTION!	 <p>DATE: XX-XX</p>	E5	OFF	SPECIAL FUNCTIONS: BY DEFAULT DEACTIVATED
			ON	MANUFACTURED MODULES BETWEEN: 04/2018 TO 04/2019	

MANDATORY INSTALL

*HOOD PIN



HOOD STATUS: THE HOOD PIN SWITCH MUST BE INSTALLED IF THE VEHICLE CAN BE REMOTE STARTED WITH THE HOOD OPEN, SET FUNCTION **A11** TO OFF.

A11

OFF

Notice: the installation of safety elements are mandatory. The hood pin is an essential security element and must be installed.

THIS MODULE MUST BE INSTALLED BY A QUALIFIED TECHNICIAN. A WRONG CONNECTION CAN CAUSE PERMANENT DAMAGE TO THE VEHICLE.

PARTS REQUIRED (NOT INCLUDED)

1x **FLASH LINK UPDATER**
 1x **FLASH LINK MANAGER**
SOFTWARE
 1x Microsoft Windows Computer with Internet connection

OR

1x **FLASH LINK MOBILE**
 1x **FLASH LINK MOBILE APP**
Smartphone Android or iOS with Internet connection (provider charges may apply).

MANDATORY I

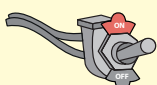



HOOD PIN  REMOTE START SAFETY OVERRIDE SWITCH 

VALET SWITCH

Part #: RSPB available, Sold separately.

Notice: the installation of safety elements are mandatory. The hood pin and the valet switch are essential security elements and must be installed.

STAND ALONE CONFIGURATION

	Program bypass option	UNIT OPTION	DESCRIPTION
	OEM Remote Stand Alone Remote Starter:	D1.10 	By default, LOCK, LOCK, LOCK Par défaut, VERROUILLE,VERROUILLE,VERROUILLE
		D1.1 	
	Program bypass option with oem remote:	C1	OEM Remote Monitoring
	Program bypass option with RF KIT antenna:	H1 to H6	Supported RF Kits and select RF Kit

REMOTE STARTER FUNCTIONALITY



All doors must be closed.

3X 

Press the OEM remote's Lock button 3x to remote-start (or remote-stop) the vehicle.



START 

The vehicle will START.

REMOTE STARTER DIAGNOSTICS
MODULE RED LED

x2 flash :	Brake ON
x3 flash :	No tach
x4 flash :	Ignition before start
x5 flash :	Hood Open

REMOTE STARTER WARNING CARD



CUT THIS WARNING CARD AND STICK IT ON A VISIBLE PLACE:
 or use the package RSPB, Sold separately.

WARNING



REMOTE STARTER

THE VEHICLE CAN BE STARTED BY EITHER: PRESSING THE LOCK BUTTON ON THE OEM REMOTE 3 TIMES CONSECUTIVELY OR BY A SMARTPHONE. **TURN ON** THE SAFETY SWITCH LOCATED UNDER THE DASHBOARD BEFORE WORKING ON THE VEHICLE.

DESCRIPTION

Parts required (Not included) PAGE

WIRE TO WIRE DIAGRAM

	1X 5 Amp Fuse 1X 1k Ohm Resistor	Page 4
--	-------------------------------------	--------

THARNES DIAGRAM

THARNES THAR-GM6	1x THAR-GM6 1x Fuse	Page 5
------------------	------------------------	--------

BCM

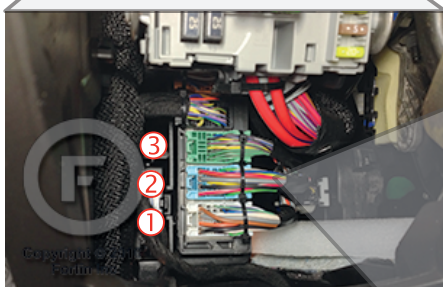
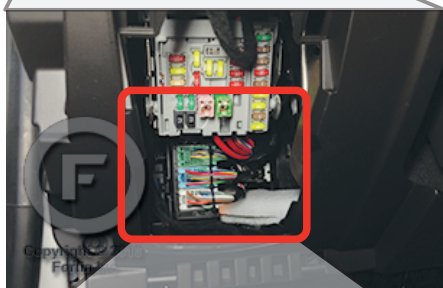
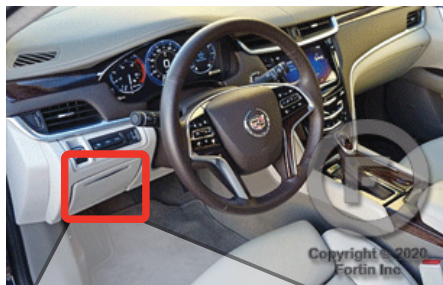

XTS

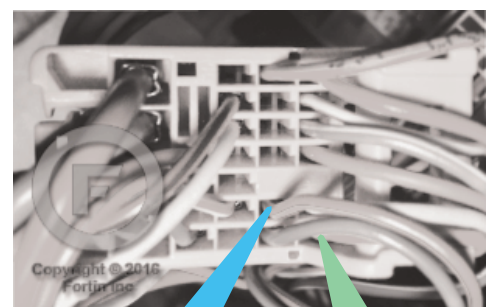
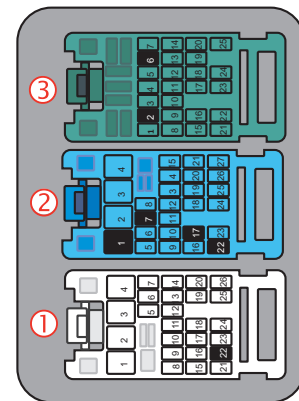
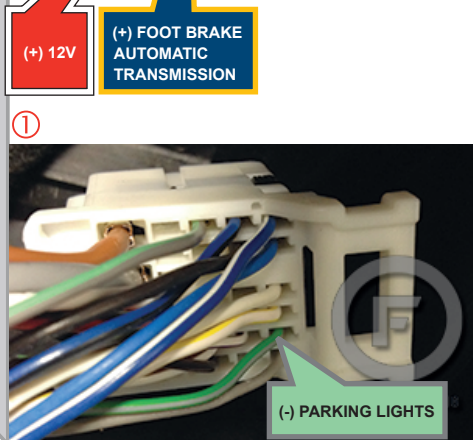
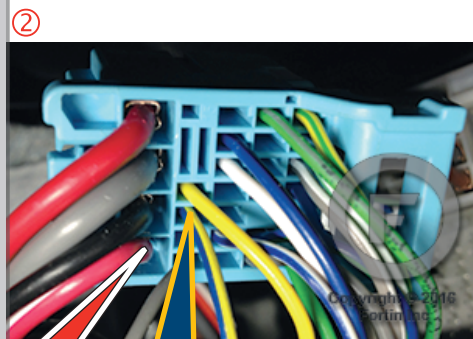
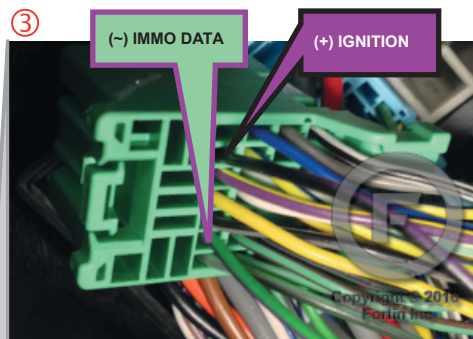

(-) START/STOP (-) CAN SW

AUTOMATIC TRANSMISSION WIRING CONNECTION

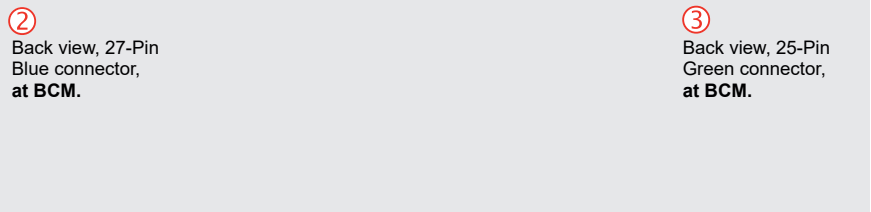
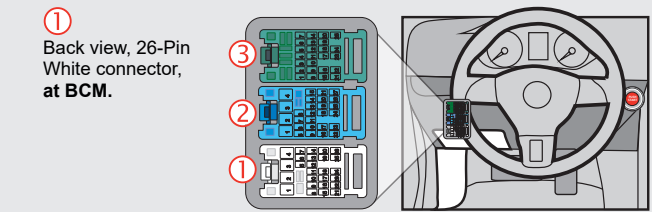
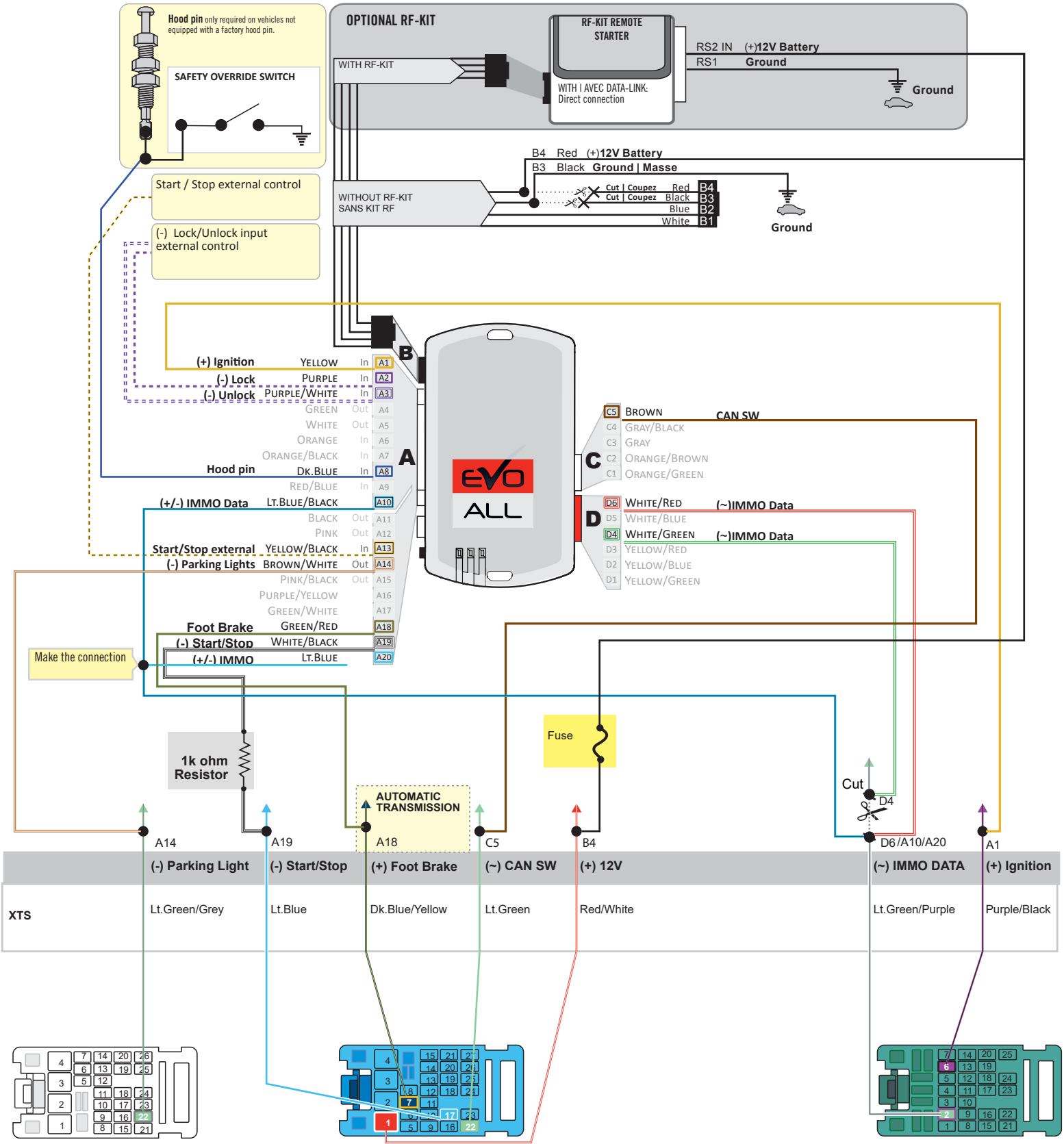

THAR-GM6 | AUTOMATIC TRANSMISSION CONNECTION

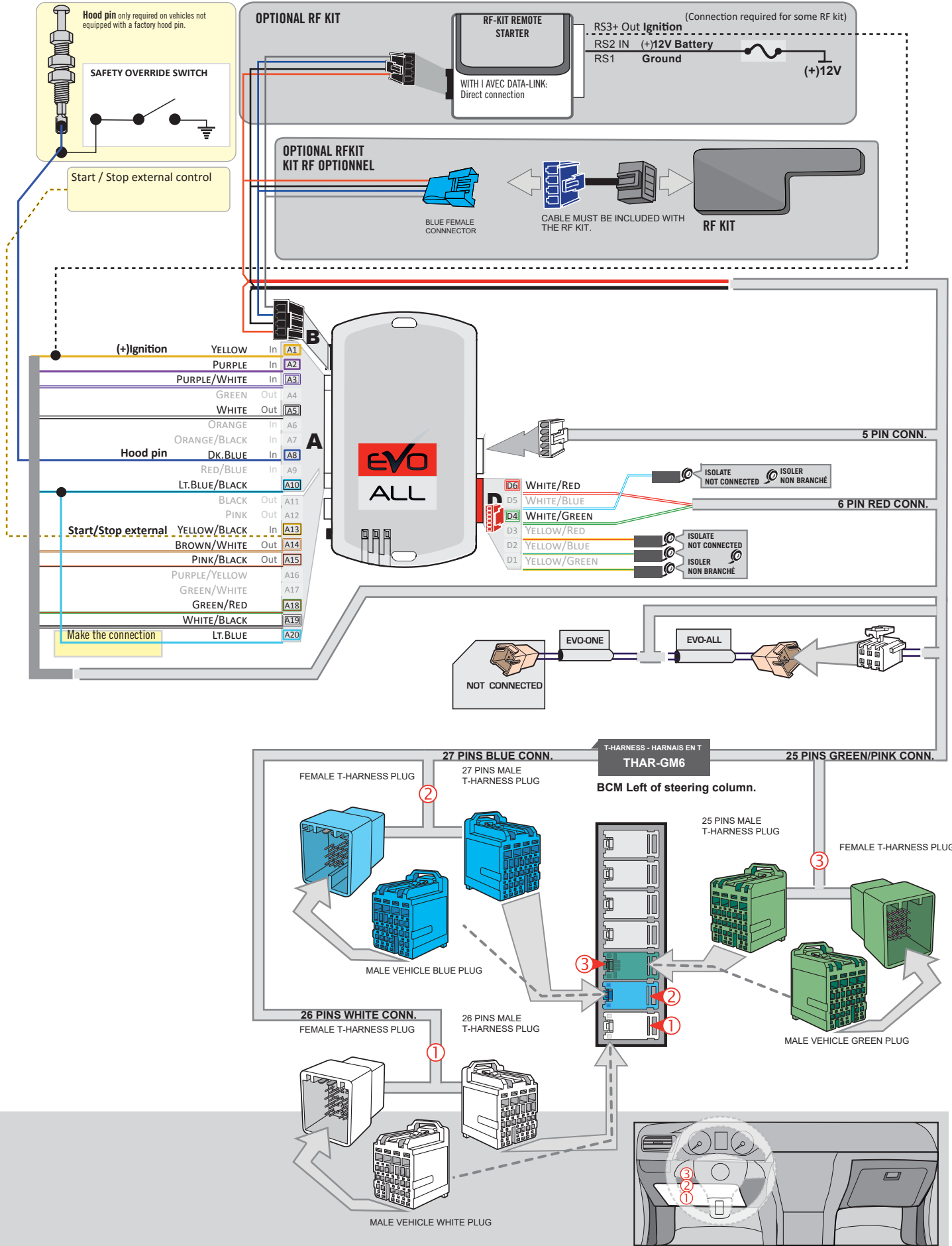

KEY BYPASS PROGRAMMING PROCEDURE 1/3

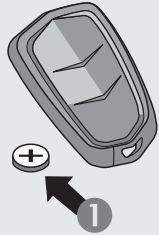

- 1** Remove the battery from the OEM remote.
- 2** Place the OEM remote into the transmitter pocket of the center console.
Refer to vehicle user guide for keyport location

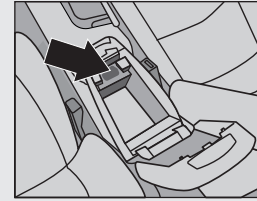

1

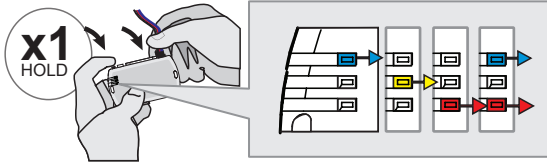

Press and hold the programming button:
Connect the 4-PIN Data-link harness (Black connector).

↳The Blue, Red, Yellow and Blue & Red LEDs will alternatively illuminate.

2

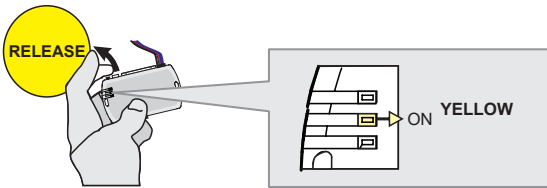

Release the programming button when the LED is YELLOW.

If the LED is not solid YELLOW disconnect the 4-Pin connector (Data-Link) and go back to step 1.

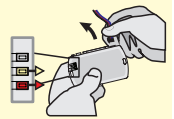

3

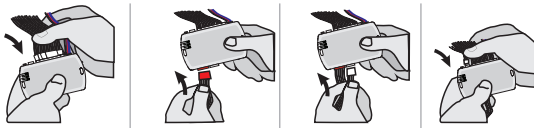

Insert the required remaining connectors.

4

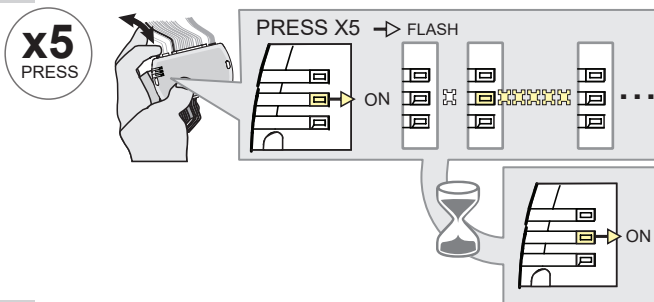

Press and release the programming button five (5x) times.

↳The YELLOW LED will flash 5 times each second.

↳**WAIT** for the YELLOW LED to turn ON solide.

5

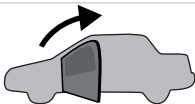

Open the driver door.

6

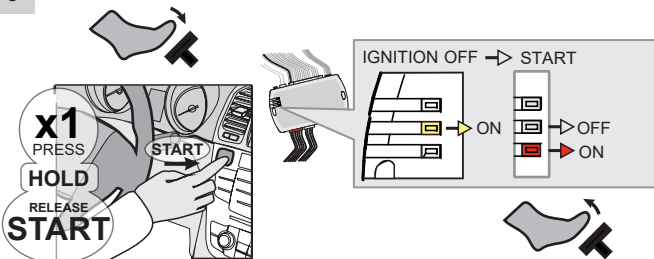

Press the foot-brake pedal.

Press the Push-to-Start button until the engine start.

Release the foot-brake pedal.

↳The RED LED will turn ON.
↳The YELLOW LED will turn OFF.

KEY BYPASS PROGRAMMING PROCEDURE 2/3

7

Press the Push-to-Start button until the engine turn OFF.

8

Close and open the driver door.

9

Press the foot-brake pedal.

Press the Push-to-Start button until the engine start.

Release the foot-brake pedal.

- ↳ The BLUE LED will turn ON.
- ↳ The BLUE LED will turn OFF. The RED LED will turn OFF.
- ↳ The YELLOW LED will flash rapidly
- ↳ The BLUE LED will turn ON.
- ↳ The BLUE LED will flash rapidly

10

Press the Push-to-Start button until the engine turn OFF.

- ↳ The BLUE LED will flash slowly

11

Disconnect all the connectors and after the Data-Link (4-pins) connector.

12

Use the tool: FLASH LINK UPDATER or FLASH LINK MOBILE to visit the DCRYPTOR menu.

*Parts required (not included)

KEY BYPASS PROGRAMMING PROCEDURE 3/3

13

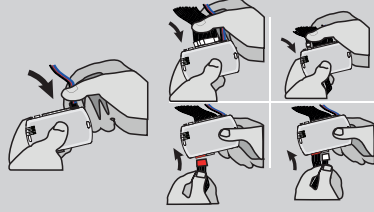
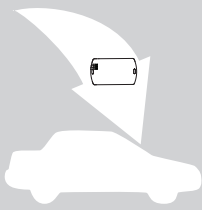

AFTER DCRYPTOR PROGRAMMING COMPLETED
Go back to the vehicle and **reconnect** the 4-Pin (Data-Link) connector and after, all the remaining connector.



The module is now programmed.



REMOTE STARTER / ALARM VERIFICATION PROCEDURE

Test the remote starter. Remote start the vehicle.

OPTIONAL RF-KIT PROGRAMMING

PROGRAM BYPASS OPTION

	<p>Program bypass option:</p>	<p>H2</p>	<p>Supported RF-KITS enable</p> <p>H2 Fortin 2</p>

OPTIONAL FORTIN RF KIT SERIES 4 OR SERIES 9 PROGRAMMING



The module must be programmed on the vehicle.



MAKE SURE THE IGNITION KEY HAS BEEN IN THE OFF POSITION FOR AT LEAST 5 SECONDS.

1

ON



x1 (HOLD) PRESS START

Press the foot-brake pedal. Press the Push-to-Start button until the engine start. Release the foot-brake pedal.

2

OFF



x1 (HOLD) PRESS START OFF

Press the Push-to-Start button until the engine turn OFF.

3

ON

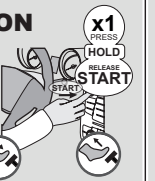

x1 (HOLD) PRESS START

Press the foot-brake pedal. Press the Push-to-Start button until the engine start. Release the foot-brake pedal.

4

4X BRAKES



x4 PRESS

Press and release the brake pedal four times.

5

ON EACH TRANSMITTER

4 BUTTONS



PRESS AND RELEASE

PRESS AND RELEASE

1 BUTTON

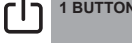

PRESS APPROX. 12 SEC. AND WAIT FOR THE BLUE LED TO TURN OFF THEN BACK ON SOLID THEN RELEASE.

6

OFF

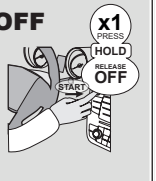

x1 (HOLD) PRESS START OFF

Press the Push-to-Start button until the engine turn OFF.



The YELLOW LED will turn ON solid.



The YELLOW LED will turn Off.



The YELLOW LED will turn ON solid.

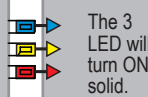

The 3 LED will turn ON solid.

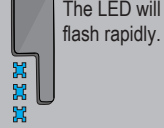

The LED will flash rapidly.

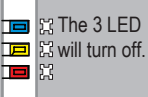

The 3 LED will turn off.

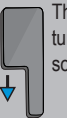

The LED will turn ON solide.



The LED will flash rapidly.

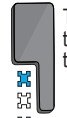

The LED will turn off each time.



The LED will turn Off.

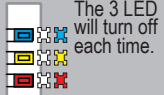

The 3 LED will turn off each time.



REMOTE STARTER FUNCTIONALITY



All doors must be closed.



Remote start the vehicle.



Unlock the doors with either:

- The OEM remote
- The remote-starter remote
- Or the proximity remote

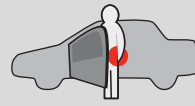

Enter the vehicle with the Intelligent Key.



The vehicle can now be put in to gear and driven.

If the vehicle is not unlocked with one of these conditions the remote-starter will shut down as soon as any door is opened.



THAR-GM6

THARNNESS
INSTALLATION

ADDENDUM - SUGGESTED WIRING CONFIGURATION

VEHICLE			Vehicle functions supported in this diagram (functional if equipped)													
VEHICLE	YEARS		Immobilizer bypass	Lock	Unlock	Arm	Disarm	Trunk (open)	RAP Disable	Tachometer	Door Status	Trunk Status (Data-Link Only, Data-Link Seuilment)	Hand-Brake Status (Data-Link Only, Data-Link Seuilment)	Foot-Brake Status	OEM Remote Monitoring	
GMC																
Acadia	Push-To-Start	2017-2020	•	•	•	•	•	•	•	•	•	•	•	•	•	

COMPATIBLE MODULE REQUIRED:

QR CODE ON THE LABEL MANUFACTURED AFTER: 2019

FIRMWARE VERSION

70.[39]

GM MINIMUM

To add the firmware version and the options, use the **FLASH LINK UPDATER** or **FLASH LINK MOBILE** tool, sold separately.

IF THE VEHICLE IS NOT EQUIPPED WITH FUNCTIONAL HOOD PIN:	A11	OFF	Hood trigger (Output Status).
---	------------	------------	-------------------------------

	Program bypass option:	UNIT OPTION	DESCRIPTION
		C1	OEM Remote status (Lock/Unlock) monitoring
		D6	Push-to-Start

	ATTENTION!		E5	OFF	<p>SPECIAL FUNCTIONS: BY DEFAULT DEACTIVATED</p>
				ON	<p>MANUFACTURED MODULES BETWEEN: 04/2018 TO 04/2019</p>

Parts required (Not included)

1X 1Amp Diode

MANDATORY INSTALL

*HOOD PIN



HOOD STATUS: THE HOOD PIN SWITCH MUST BE INSTALLED IF THE VEHICLE CAN BE REMOTE STARTED WITH THE HOOD OPEN, SET FUNCTION A11 TO OFF.

A11

OFF

Notice: the installation of safety elements are mandatory. The hood pin is an essential security element and must be installed.

THIS MODULE MUST BE INSTALLED BY A QUALIFIED TECHNICIAN. A WRONG CONNECTION CAN CAUSE PERMANENT DAMAGE TO THE VEHICLE.

DESCRIPTION

BCM located on passenger side center console



③

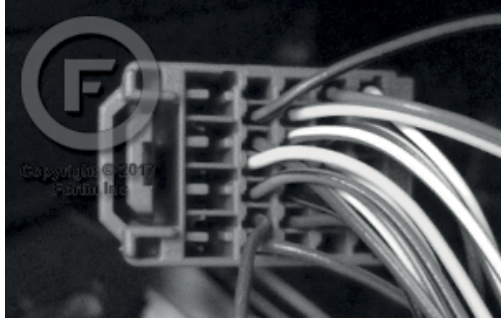

②

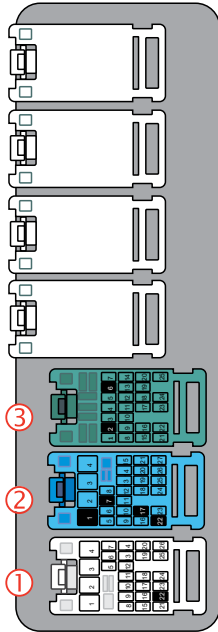
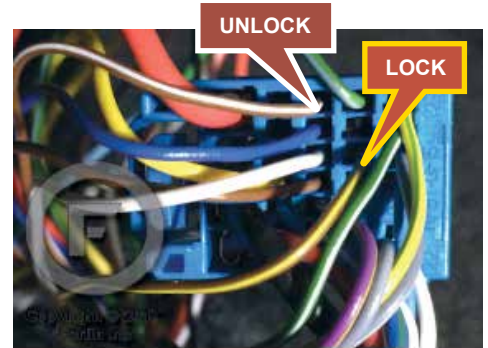
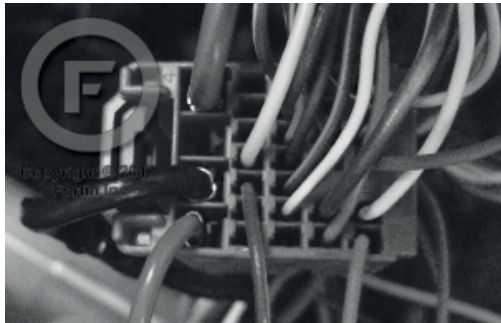

①



AUTOMATIC TRANSMISSION WIRING CONNECTION

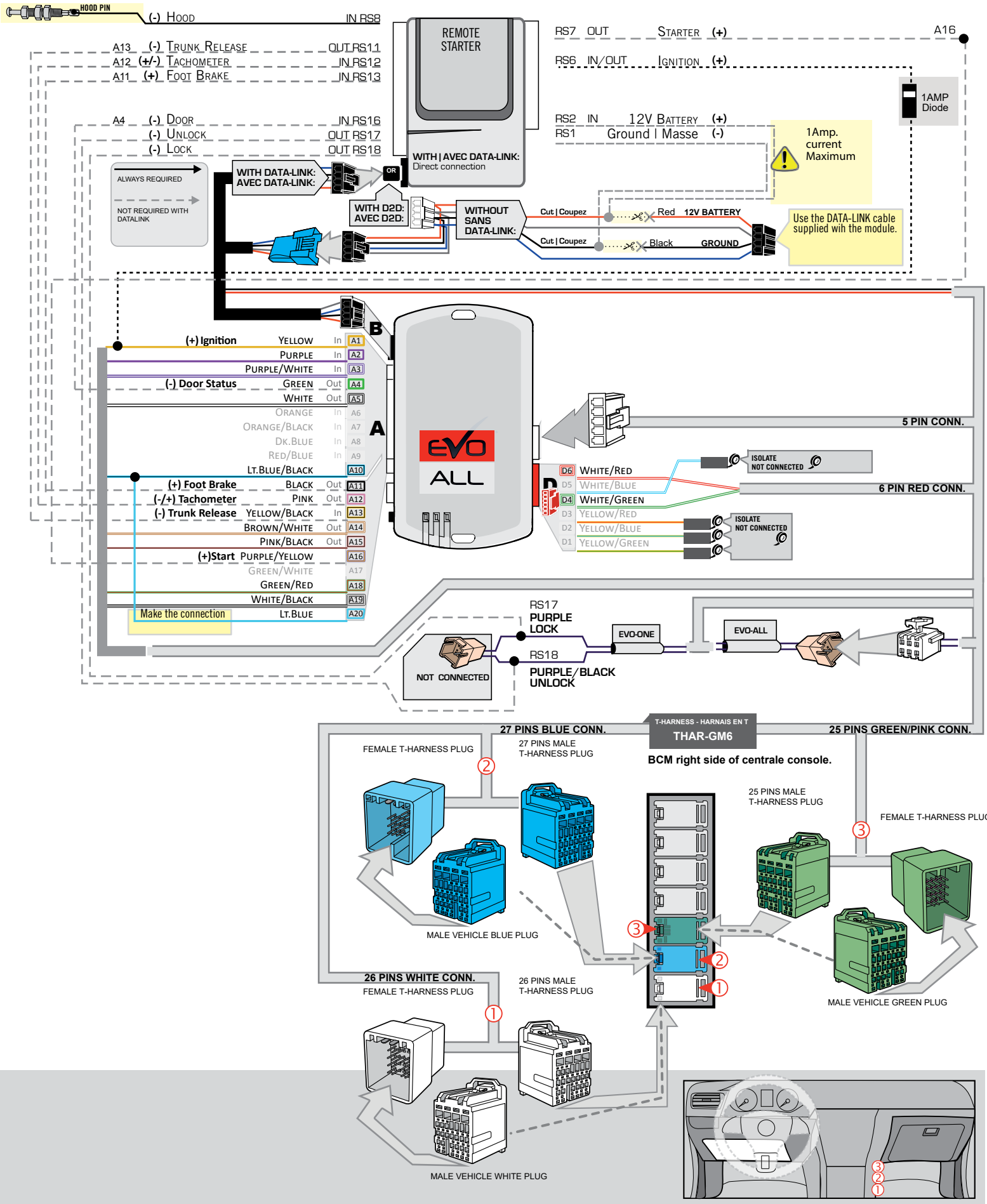

KEY BYPASS PROGRAMMING PROCEDURE 1/3

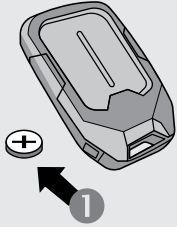

1 Remove the battery from the OEM remote.

2 Place the OEM remote into the transmitter pocket of the center console.

Refer to vehicle user guide for keyport location.

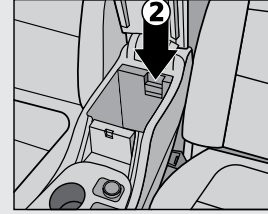

1

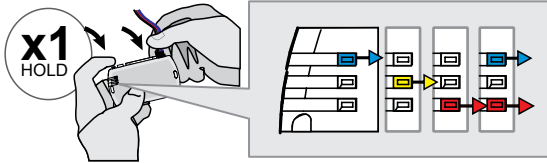

Press and hold the programming button:
Connect the 4-PIN Data-link harness (Black connector).

↳The Blue, Red, Yellow and Blue & Red LEDs will alternatively illuminate.

2

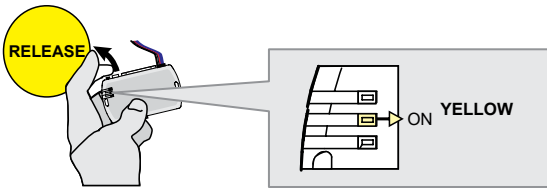

Release the programming button when the LED is YELLOW.

If the LED is not solid YELLOW disconnect the 4-Pin connector (Data-Link) and go back to step 1.

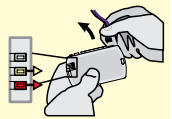

3

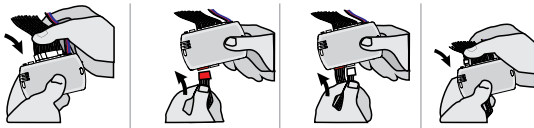

Insert the required remaining connectors.

4

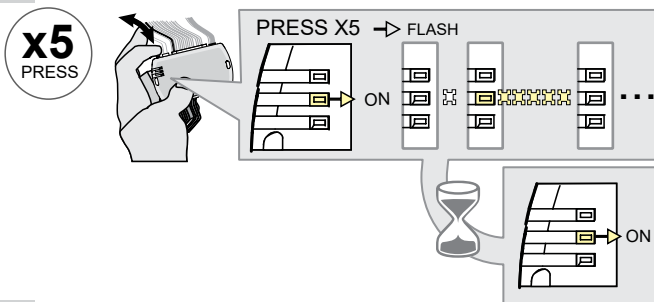

Press and release the programming button five (5x) times.

↳The YELLOW LED will flash 5 times each second.

↳**WAIT** for the YELLOW LED to turn ON solide.

5

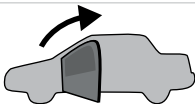

Open the driver door.

6

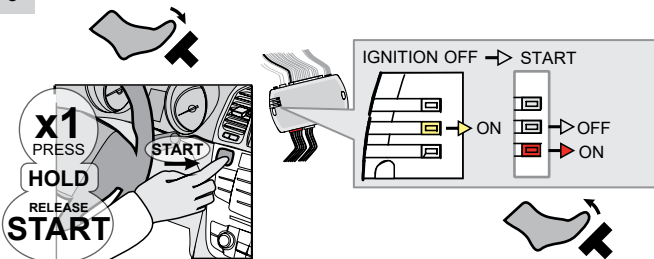

Press the foot-brake pedal.

Press the Push-to-Start button until the engine start.

Release the foot-brake pedal.

↳The RED LED will turn ON.
↳The YELLOW LED will turn OFF.

KEY BYPASS PROGRAMMING PROCEDURE 2/3

7



Press the Push-to-Start button until the engine turn OFF.

8

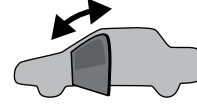

Close and open the driver door.

9

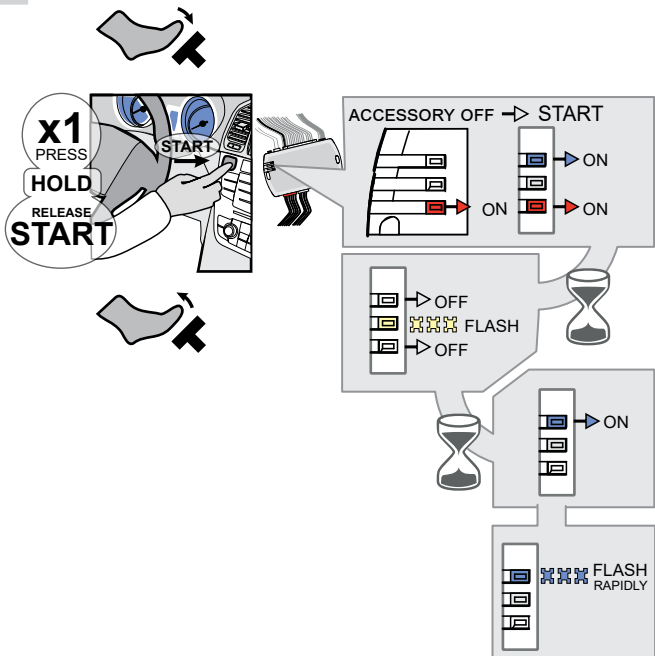

Press the foot-brake pedal.

Press the Push-to-Start button until the engine start.

Release the foot-brake pedal.

- ↳ The BLUE LED will turn ON.
- ↳ The BLUE LED will turn OFF. The RED LED will turn OFF.
- ↳ The YELLOW LED will flash rapidly
- ↳ The BLUE LED will turn ON.
- ↳ The BLUE LED will flash rapidly

10

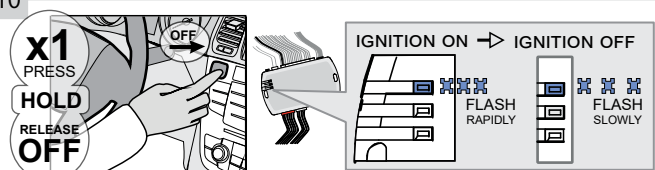

Press the Push-to-Start button until the engine turn OFF.

- ↳ The BLUE LED will flash slowly

11

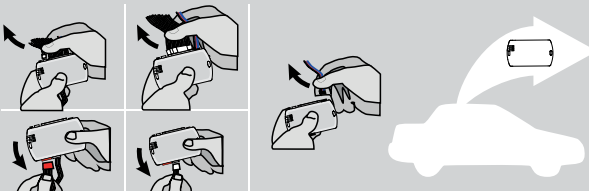

Disconnect all the connectors and after the Data-Link (4-pins) connector.

12

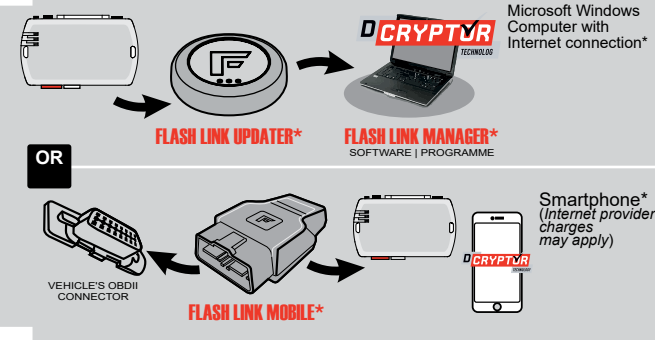

Use the tool: FLASH LINK UPDATER or FLASH LINK MOBILE to visit the DCryptor menu.

***Parts required (not included)**

KEY BYPASS PROGRAMMING PROCEDURE 3/3

13

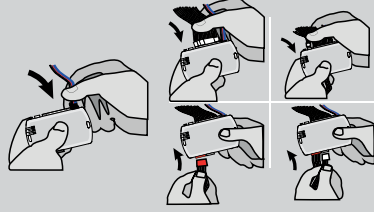
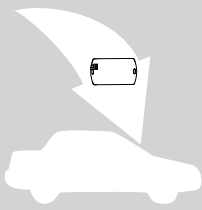

AFTER DCRYPTOR PROGRAMMING COMPLETED
Go back to the vehicle and **reconnect** the 4-Pin (Data-Link) connector and after, all the remaining connector.



The module is now programmed.



REMOTE STARTER / ALARM VERIFICATION PROCEDURE

Test the remote starter. Remote start the vehicle.

REMOTE STARTER FUNCTIONALITY



All doors must be closed.

Remote start the vehicle.



Press the Unlock button of the remote car starter.

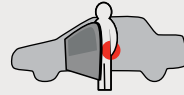

Enter the vehicle with the Intelligent Access Key.

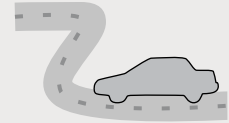

The vehicle can now be put in to gear and driven.



If the vehicle is not unlocked the module will shut down the remote-starter and the vehicle as soon as any door is opened.

THAR-GM6

THARNNESS INSTALLATION

ADDENDUM - SUGGESTED WIRING CONFIGURATION

VEHICLE	YEARS	Vehicle functions supported in this diagram (functional if equipped)														
		Immobilizer bypass	T-Harness	Lock	Unlock	Arm	Disarm	Trunk (open)	RAP Disable	Tachometer	Heated Seats	Door Status	Trunk Status (Data-Link Only/Data-Link Seulement)	Hand-Brake Status (Data-Link Only/Data-Link Seulement)	Foot-Brake Status	OEM Remote monitoring
CHEVROLET																
Bolt	Push-To-Start	2016-2019	•	•	•	•	•	•	•	•	•	•	•	•	•	•



FIRMWARE VERSION

70.[41]

GM MINIMUM

To add the firmware version and the options, use the **FLASH LINK UPDATER** or **FLASH LINK MOBILE** tool, sold separately.

IF THE VEHICLE IS NOT EQUIPPED WITH FUNCTIONAL HOOD PIN:	A11	OFF	Hood trigger (Output Status).
--	------------	-----	-------------------------------

	Program bypass option:	UNIT OPTION	DESCRIPTION
		C1	OEM Remote status (Lock/Unlock) monitoring
		D6	Push-to-Start

	Program bypass option (Vehicle hybrid only):	UNIT OPTION	DESCRIPTION
		D4	Hybrid mode (Vehicle hybrid only)

	ATTENTION!	 <p>DATE: XX-XX</p>	E5	OFF	<p>SPECIAL FUNCTIONS: BY DEFAULT DEACTIVATED</p> <p style="color: red; font-weight: bold;">MANUFACTURED MODULES BETWEEN: 04/2018 TO 04/2019</p>
--	------------	--	-----------	-----	--

Parts required (Not included)

1X 1Amp Diode

MANDATORY INSTALL	<p>*HOOD PIN</p> <p> HOOD STATUS: THE HOOD PIN SWITCH MUST BE INSTALLED IF THE VEHICLE CAN BE REMOTE STARTED WITH THE HOOD OPEN, SET FUNCTION A11 TO OFF.</p>	A11	OFF	<p>Notice: the installation of safety elements are mandatory. The hood pin is an essential security element and must be installed.</p>	<p>THIS MODULE MUST BE INSTALLED BY A QUALIFIED TECHNICIAN. A WRONG CONNECTION CAN CAUSE PERMANENT DAMAGE TO THE VEHICLE.</p>
-------------------	---	------------	-----	---	---

DESCRIPTION



BCM

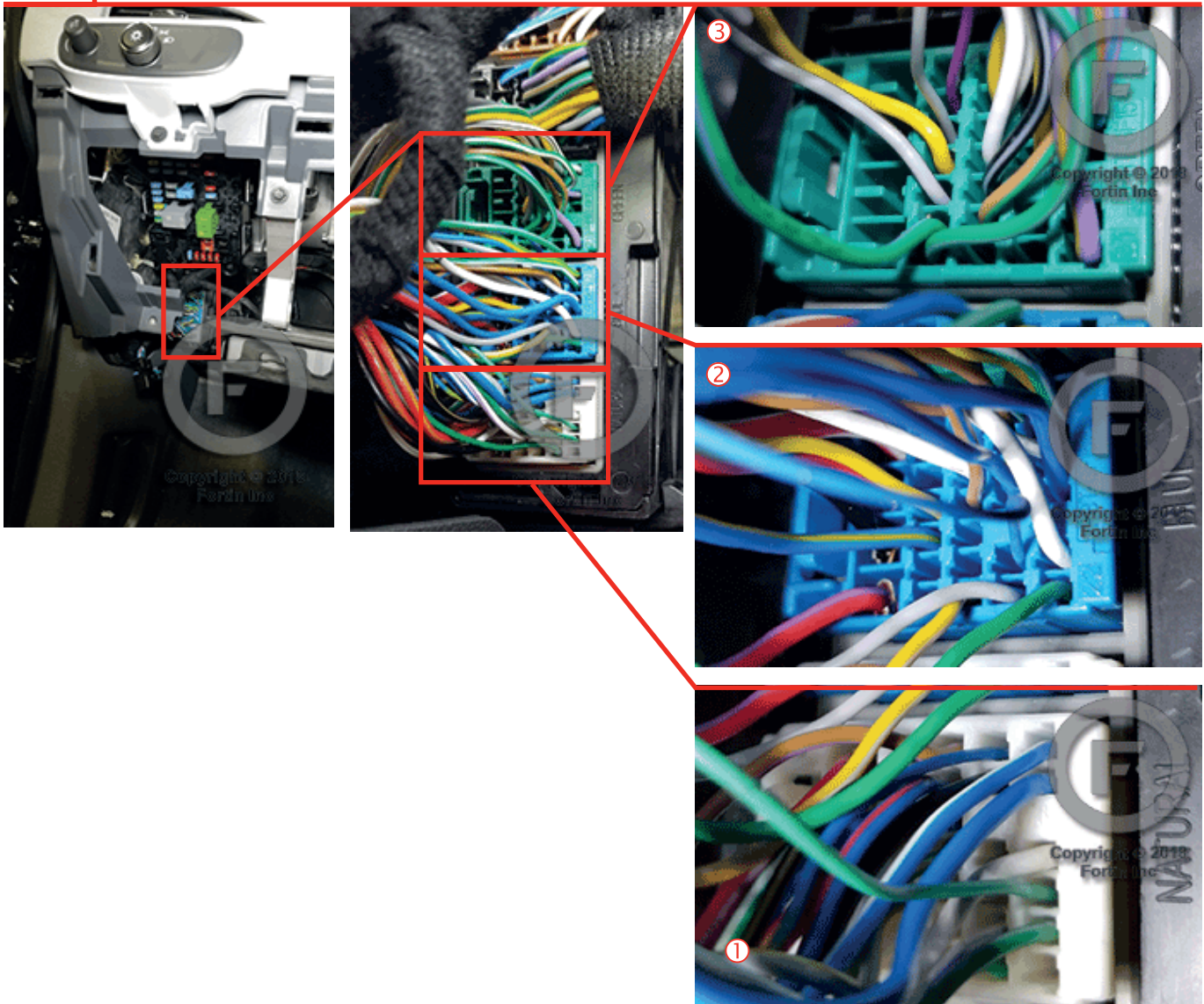

AUTOMATIC TRANSMISSION WIRING CONNECTION

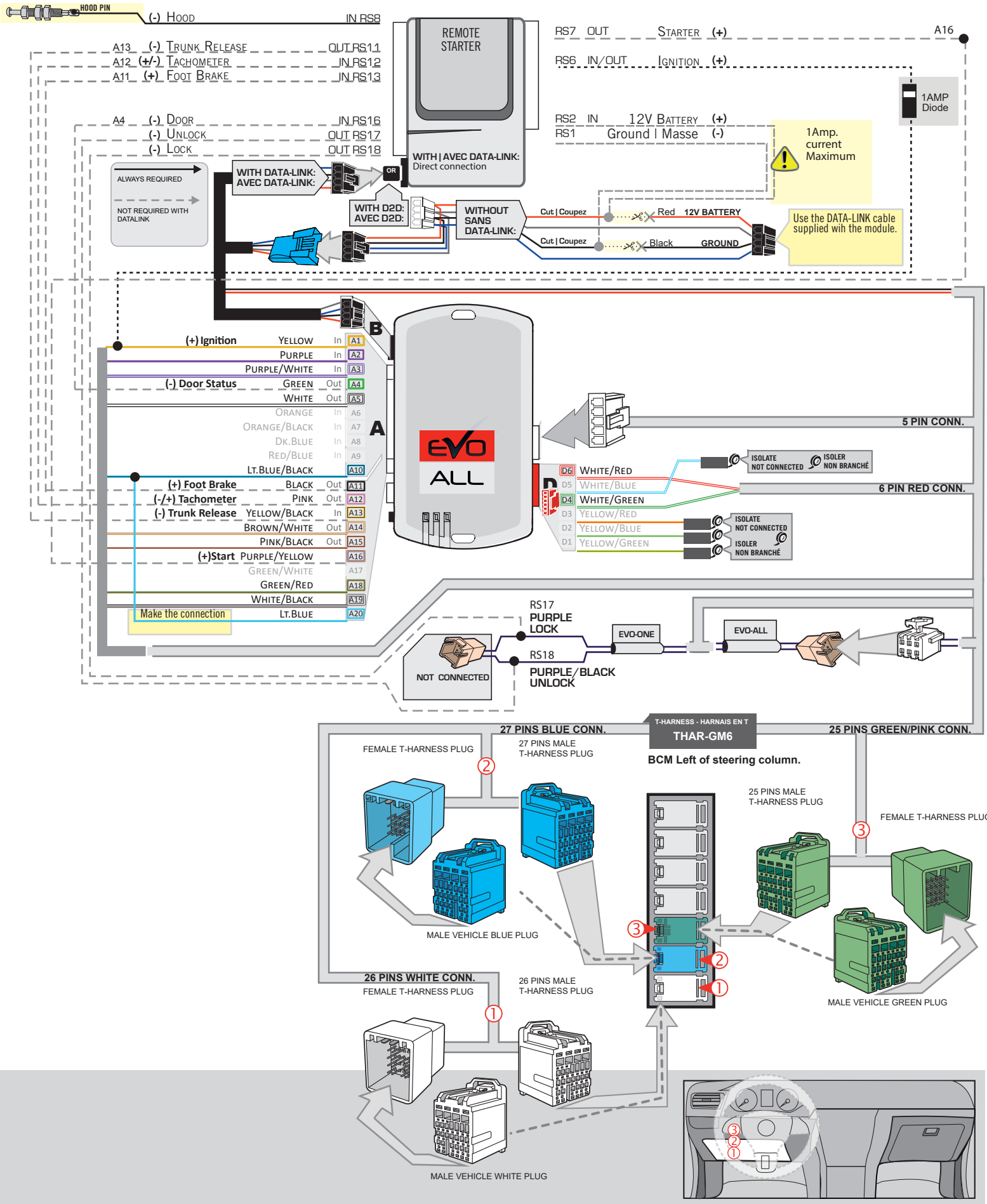

KEY BYPASS PROGRAMMING PROCEDURE 1/3



- 1** Remove the battery from the OEM remote.
- 2** Place the OEM remote into the center console.
Refer to vehicle user guide for keyport location.

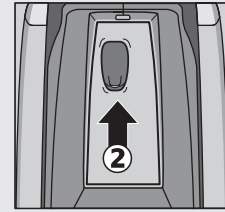

1

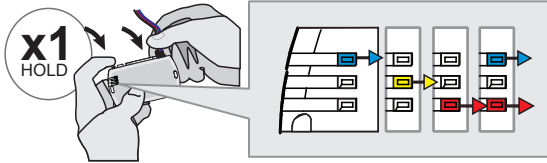

Press and hold the programming button:
Connect the 4-PIN Data-link harness (Black connector).

↳The Blue, Red, Yellow and Blue & Red LEDs will alternatively illuminate.

2

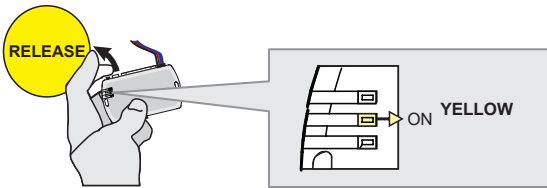

Release the programming button when the LED is YELLOW.

If the LED is not solid YELLOW disconnect the 4-Pin connector (Data-Link) and go back to step 1.

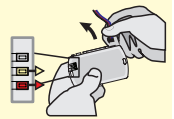

3

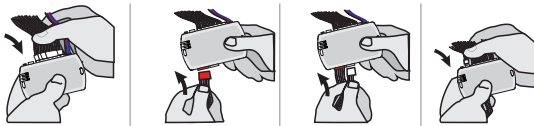

Insert the required remaining connectors.

4

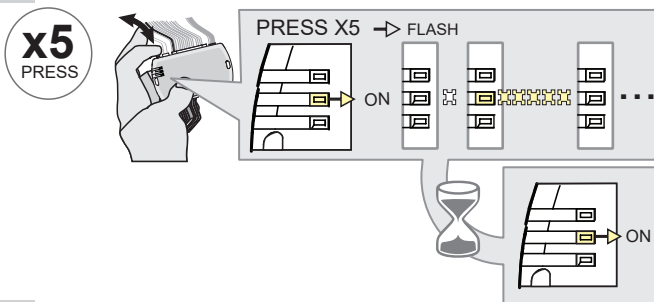

Press and release the programming button five (5x) times.

↳The YELLOW LED will flash 5 times each second.

↳**WAIT** for the YELLOW LED to turn ON solide.

5

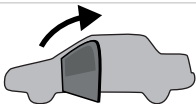

Open the driver door.

6

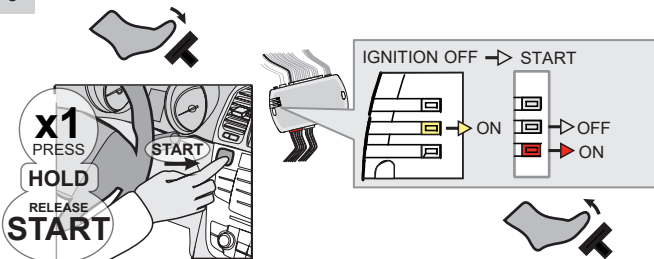

Press the foot-brake pedal.

Press the Push-to-Start button until the engine start.

Release the foot-brake pedal.

↳The RED LED will turn ON.
↳The YELLOW LED will turn OFF.

KEY BYPASS PROGRAMMING PROCEDURE 2/3

7



Press the Push-to-Start button until the engine turn OFF.

8

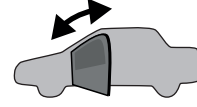

Close and open the driver door.

9

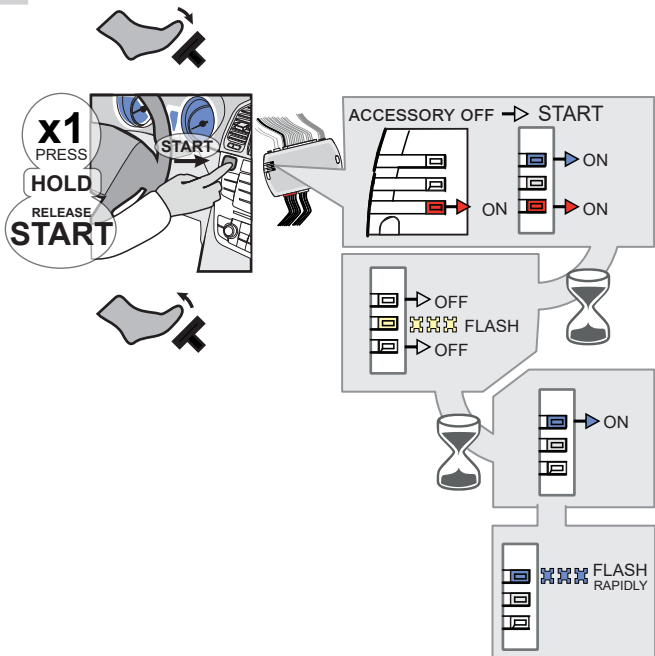

Press the foot-brake pedal.

Press the Push-to-Start button until the engine start.

Release the foot-brake pedal.

- ↳ The BLUE LED will turn ON.
- ↳ The BLUE LED will turn OFF. The RED LED will turn OFF.
- ↳ The YELLOW LED will flash rapidly
- ↳ The BLUE LED will turn ON.
- ↳ The BLUE LED will flash rapidly

10

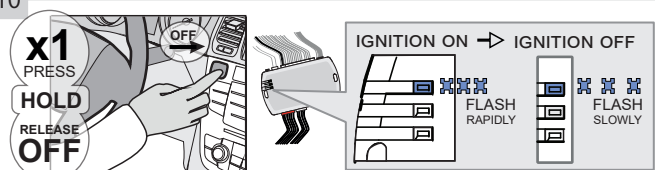

Press the Push-to-Start button until the engine turn OFF.

- ↳ The BLUE LED will flash slowly

11

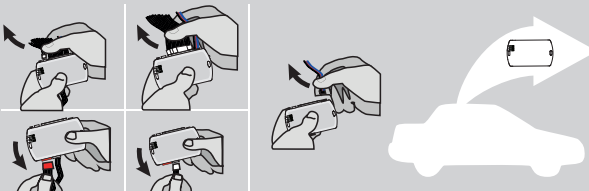

Disconnect all the connectors and after the Data-Link (4-pins) connector.

12

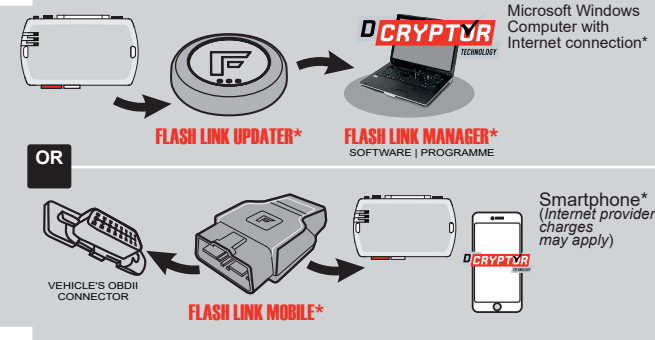

Use the tool: FLASH LINK UPDATER or FLASH LINK MOBILE to visit the DCryptor menu.

*Parts required (not included)

KEY BYPASS PROGRAMMING PROCEDURE 3/3

13

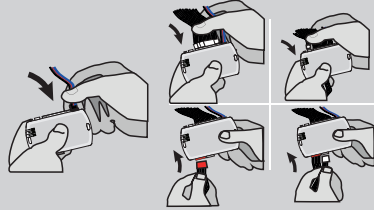
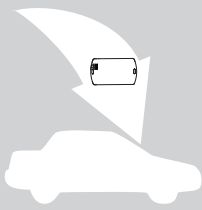

AFTER DCRYPTOR PROGRAMMING COMPLETED
Go back to the vehicle and **reconnect** the 4-Pin (Data-Link) connector and after, all the remaining connector.



The module is now programmed.



REMOTE STARTER / ALARM VERIFICATION PROCEDURE

Test the remote starter. Remote start the vehicle.

REMOTE STARTER FUNCTIONALITY



All doors must be closed.

Remote start the vehicle.



Press the Unlock button of the remote car starter or the OEM remote.



Enter the vehicle with the Intelligent Access Key.

The vehicle can now be put in to gear and driven.



If the vehicle is not unlocked the module will shut down the remote-starter and the vehicle as soon as any door is opened.

THAR-GM6

THARNNESS INSTALLATION

ADDENDUM - SUGGESTED WIRING CONFIGURATION

VEHICLE	YEARS	Vehicle functions supported in this diagram (functional if equipped)																
		Immobilizer bypass	Lock	Unlock	Arm	Disarm	Trunk (open)	Parking Light	RAP Disable	Tachometer	Heated Seats	Door Status	Trunk Status (Data-Link Only,Data-Link Seule-ment)	Hand-Brake Status (Data-Link Only,Data-Link Seule-ment)	Foot-Brake Status	OEM Remote Monitoring		
CHEVROLET																		
Camaro	Push-To-Start **	2016-2019	•	•	•	•	•	•	•	•	•	•	•	•	•	•	•	•

NOTES
****Manuelle Transmission, Transmission Manuelle** Remote starter with compatible Data-Link required

FIRMWARE VERSION

70.[41]
 GM MINIMUM

To add the firmware version and the options, use the **FLASH LINK UPDATER** or **FLASH LINK MOBILE** tool, sold separately.

IF THE VEHICLE IS NOT EQUIPPED WITH FUNCTIONAL HOOD PIN:

A11 **OFF** Hood trigger (Output Status).

UNIT OPTION	DESCRIPTION
C1	OEM Remote status (Lock/Unlock) monitoring
D6	Push-to-Start

Program bypass option:

ATTENTION!   DATE: XX-XX

E5 **OFF** **SPECIAL FUNCTIONS: BY DEFAULT DEACTIVATED**

ON **MANUFACTURED MODULES BETWEEN: 04/2018 TO 04/2019**

- Parts required (Not included)**
-  1X 1Amp Diode
 - 1X Fuse (manual transmission)
 - 1X 180 Ohm Resistor (manual transmission)

MANDATORY INSTALL



HOOD STATUS: THE HOOD PIN SWITCH MUST BE INSTALLED IF THE VEHICLE CAN BE REMOTE STARTED WITH THE HOOD OPEN, SET FUNCTION **A11** TO OFF.

A11 **OFF**

Notice: the installation of safety elements are mandatory. The hood pin is an essential security element and must be installed.

THIS MODULE MUST BE INSTALLED BY A QUALIFIED TECHNICIAN. A WRONG CONNECTION CAN CAUSE PERMANENT DAMAGE TO THE VEHICLE.

DESCRIPTION

BCM located on left side of the steering column

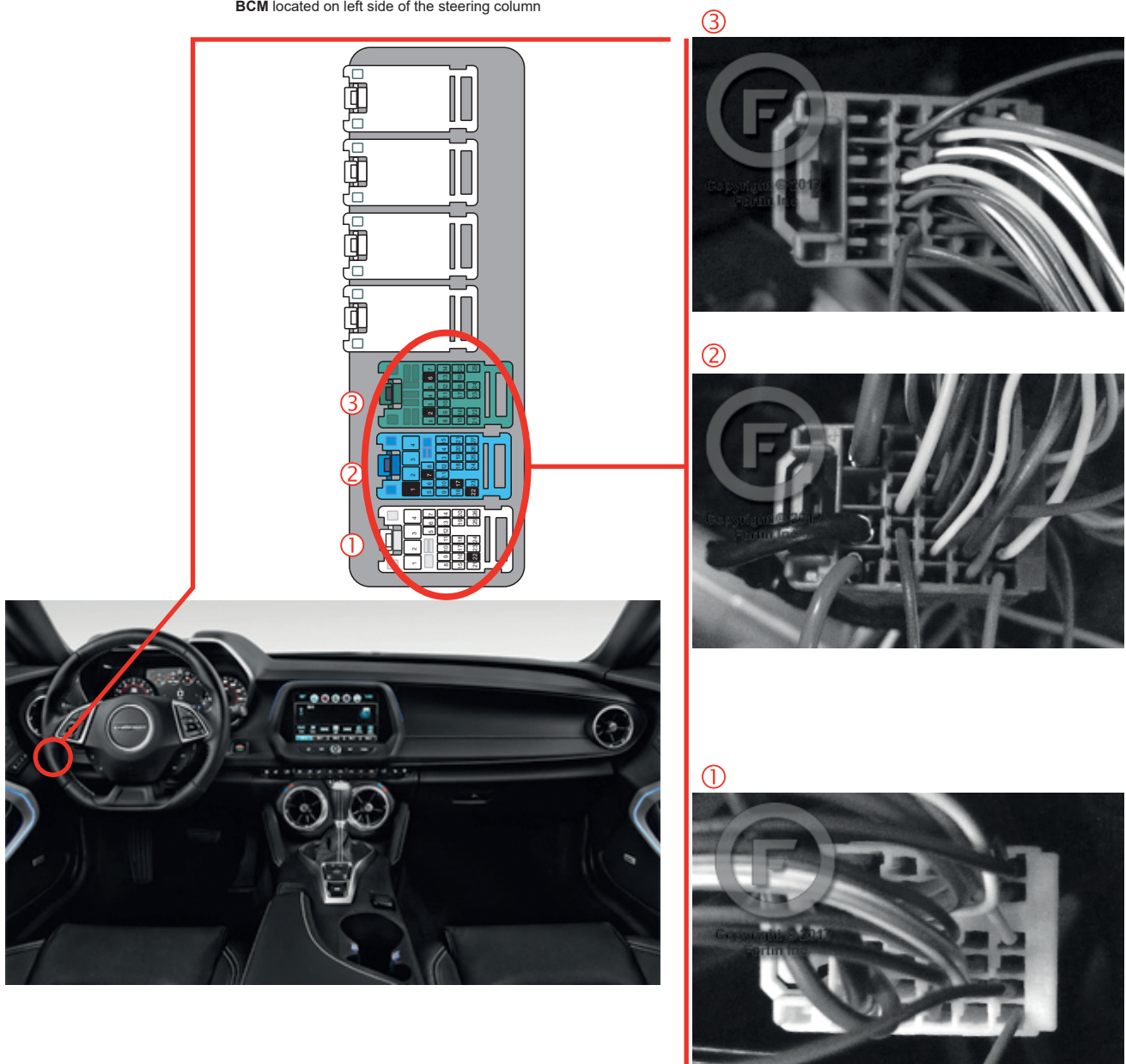

AUTOMATIC TRANSMISSION WIRING CONNECTION

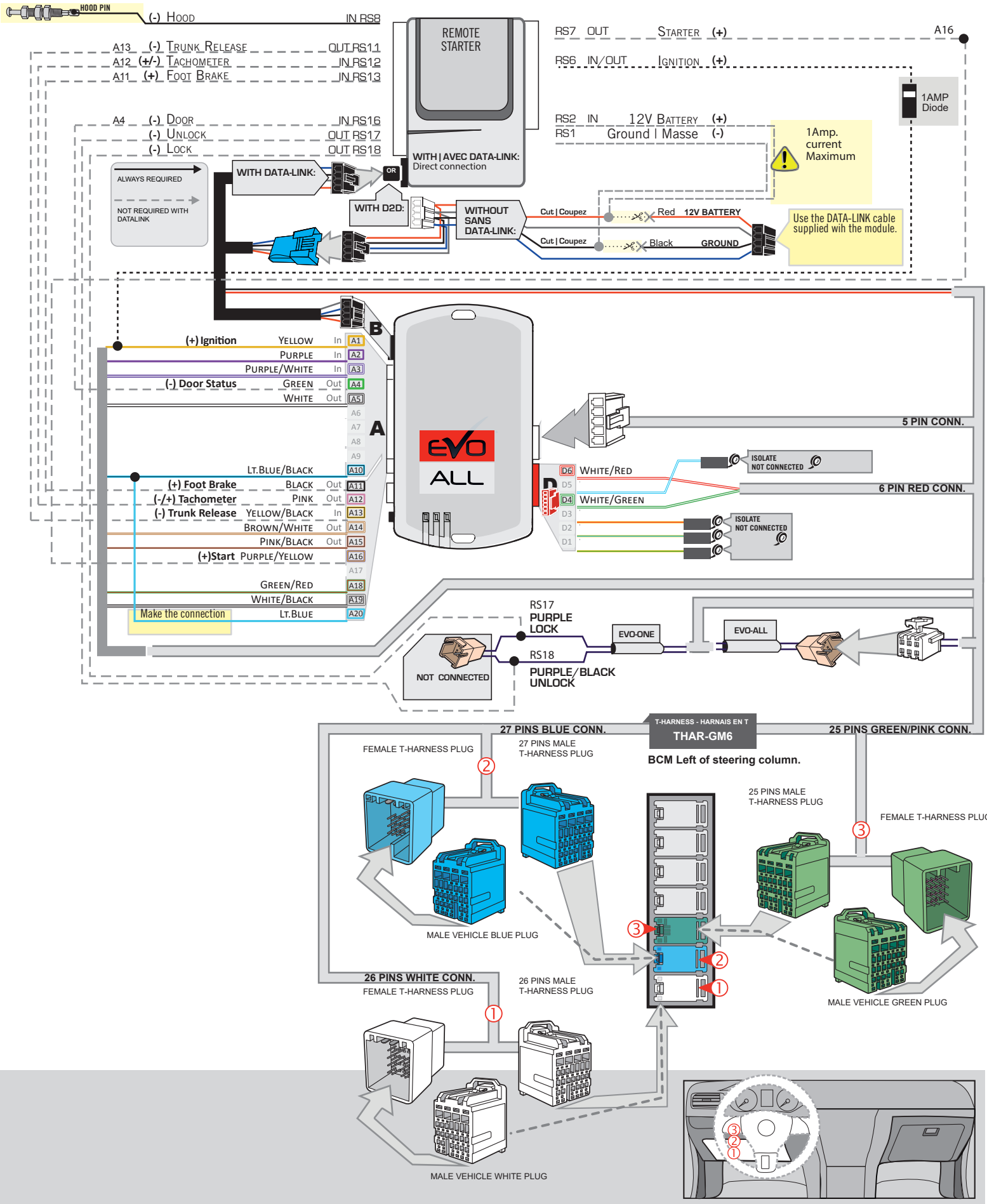

MANUAL TRANSMISSION WIRING CONNECTION

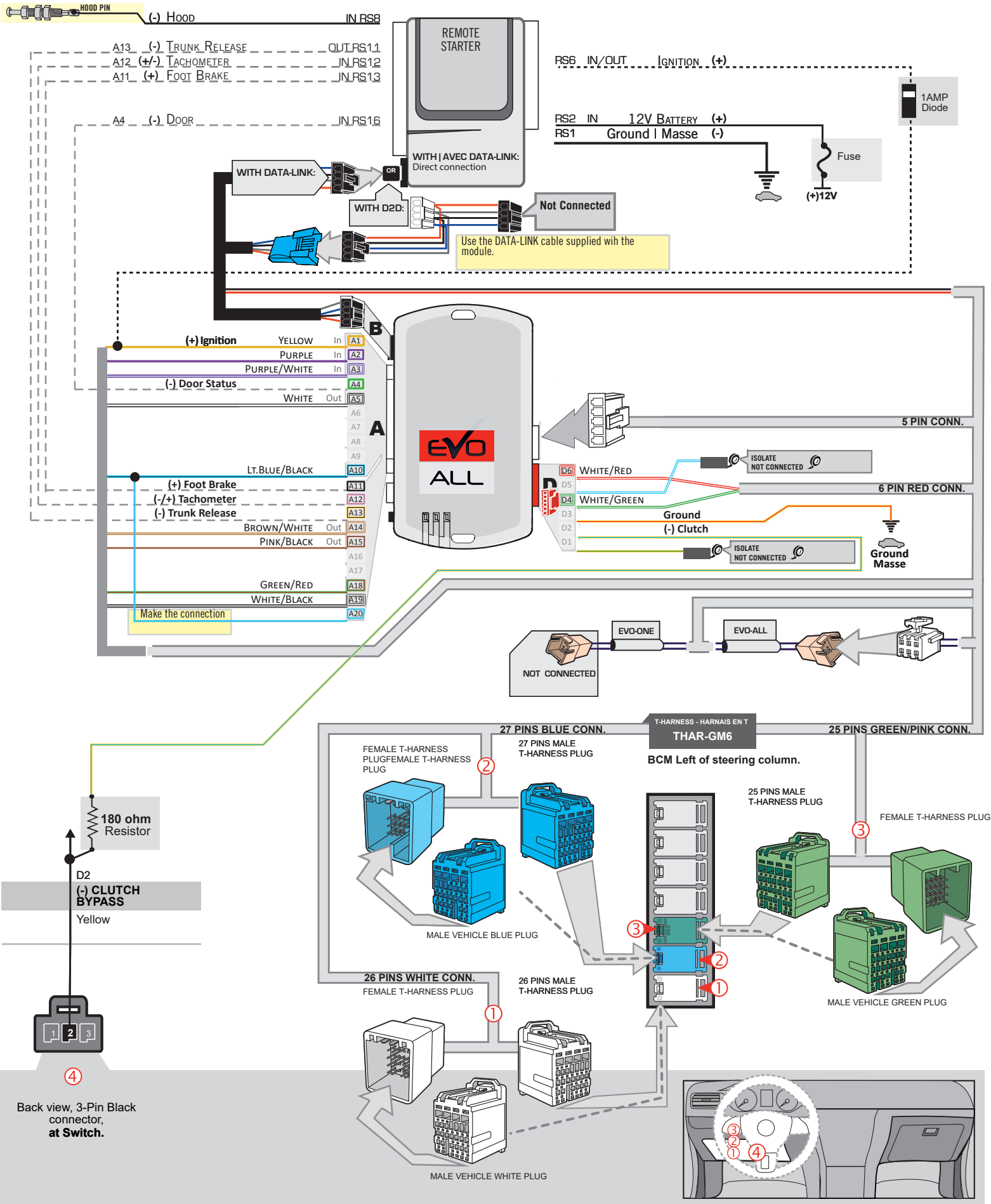

KEY BYPASS PROGRAMMING PROCEDURE 1/3

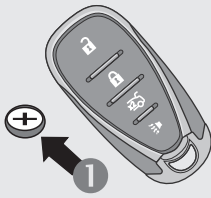

1 Remove the battery from the OEM remote.

2 Place the OEM remotes in to the center console.

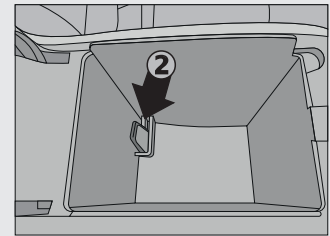

1

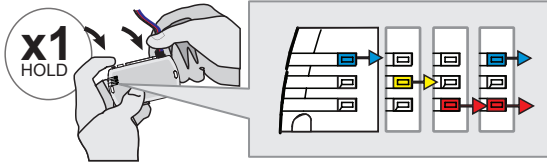

Press and hold the programming button:
Connect the 4-PIN Data-link harness (Black connector).

↳The Blue, Red, Yellow and Blue & Red LEDs will alternatively illuminate.

2

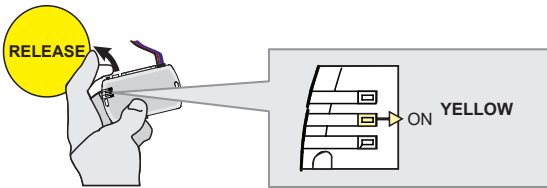

Release the programming button when the LED is YELLOW.

If the LED is not solid YELLOW disconnect the 4-Pin connector (Data-Link) and go back to step 1.

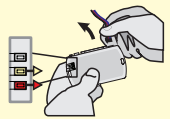

3

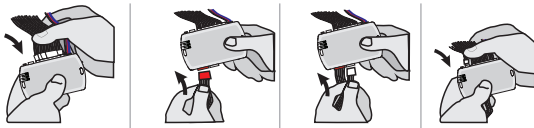

Insert the required remaining connectors.

4

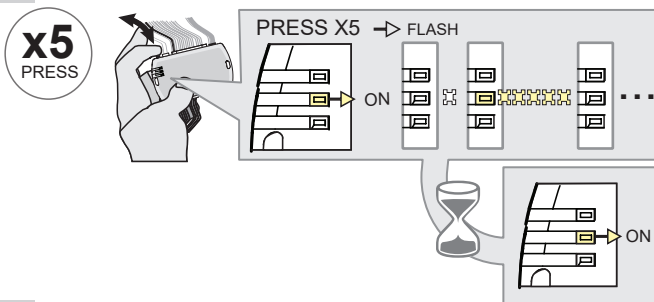

Press and release the programming button five (5x) times.

↳The YELLOW LED will flash 5 times each second.

↳**WAIT** for the YELLOW LED to turn ON solide.

5

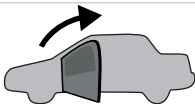

Open the driver door.

6

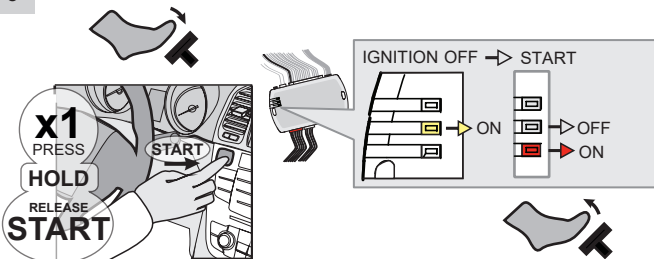

Press the foot-brake pedal.

Press the Push-to-Start button until the engine start.

Release the foot-brake pedal.

↳The RED LED will turn ON.
 ↳The YELLOW LED will turn OFF.

KEY BYPASS PROGRAMMING PROCEDURE 2/3

7



Press the Push-to-Start button until the engine turn OFF.

8

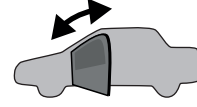

Close and open the driver door.

9

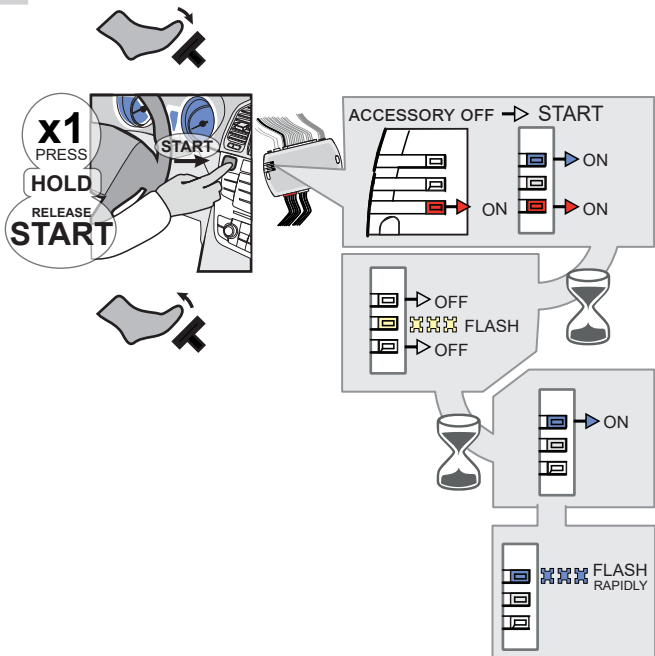

Press the foot-brake pedal.

Press the Push-to-Start button until the engine start.

Release the foot-brake pedal.

- ↳ The BLUE LED will turn ON.
- ↳ The BLUE LED will turn OFF. The RED LED will turn OFF.
- ↳ The YELLOW LED will flash rapidly
- ↳ The BLUE LED will turn ON.
- ↳ The BLUE LED will flash rapidly

10

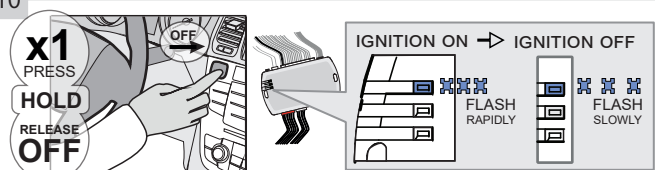

Press the Push-to-Start button until the engine turn OFF.

- ↳ The BLUE LED will flash slowly

11

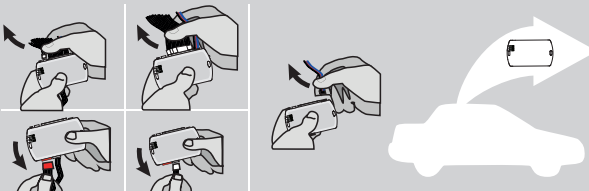

Disconnect all the connectors and after the Data-Link (4-pins) connector.

12

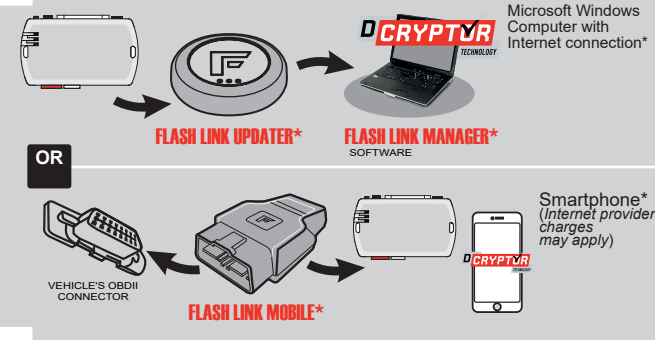

Microsoft Windows Computer with Internet connection*

FLASH LINK UPDATER* **FLASH LINK MANAGER*** SOFTWARE

OR

FLASH LINK MOBILE*

Smartphone* (Internet provider charges may apply)

Use the tool: FLASH LINK UPDATER or FLASH LINK MOBILE to visit the DCryptor menu.

*Parts required (not included)

KEY BYPASS PROGRAMMING PROCEDURE 3/3

13

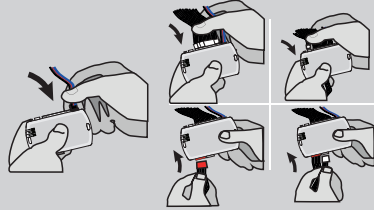
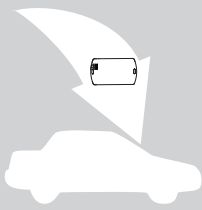

AFTER DCRYPTOR PROGRAMMING COMPLETED
Go back to the vehicle and **reconnect** the 4-Pin (Data-Link) connector and after, all the remaining connector.



The module is now programmed.



REMOTE STARTER / ALARM VERIFICATION PROCEDURE

Test the remote starter. Remote start the vehicle.

REMOTE STARTER FUNCTIONALITY



All doors must be closed.



Remote start the vehicle.



Unlock the doors with either:

- The OEM remote
- The remote-starter remote
- Or the proximity remote



Enter the vehicle with the Intelligent Key.



The vehicle can now be put in to gear and driven.

If the vehicle is not unlocked with one of these conditions the remote-starter will shut down as soon as any door is opened.



THAR-GM6
THARNNESS INSTALLATION

ADDENDUM - SUGGESTED WIRING CONFIGURATION



Vehicle functions supported in this diagram (functional if equipped)

VEHICLE	YEARS	Immobilizer bypass	Lock	Unlock	Arm	Disarm	Trunk (open)	RAP Disable	Tachometer	Door Status	Trunk Status (Data-Link Only, Data-Link Seulement)	Hood Status*	Hand-Brake Status (Data-Link Only, Data-Link Seulement)	Foot-Brake Status	Push-to-Start Control	OEM Remote monitoring
CADILLAC																
ATS	Push-to-start**	2013-2018	•	•	•	•	•	•	•	•	•	•	•	•	•	•
CTS	Push-to-start**	2014-2016	•	•	•	•	•	•	•	•	•	•	•	•	•	•
CTS-V	Push-to-start	2013-2016	•	•	•	•	•	•	•	•	•	•	•	•	•	•
Escalade	Push-to-start**	2015-2019	•	•	•	•	•	•	•	•	•	•	•	•	•	•
CHEVROLET																
Tahoe	Push-to-start**	2015-2019	•	•	•	•	•	•	•	•	•	•	•	•	•	•
Suburban	Push-to-start**	2015-2019	•	•	•	•	•	•	•	•	•	•	•	•	•	•
GMC																
Yukon	Push-to-start**	2015-2019	•	•	•	•	•	•	•	•	•	•	•	•	•	•
	XL Push-to-start	2015	•	•	•	•	•	•	•	•	•	•	•	•	•	•

FIRMWARE VERSION

70.[41]

GM MINIMUM

To add the firmware version and the options, use the **FLASH LINK UPDATER** or **FLASH LINK MOBILE** tool, sold separately.

IF THE VEHICLE IS NOT EQUIPPED WITH FUNCTIONAL HOOD PIN:	A11	OFF	Hood trigger (Output Status).
---	-----	-----	-------------------------------

		UNIT OPTION	DESCRIPTION
	Program bypass option:	C1	OEM Remote status (Lock/Unlock) monitoring
		D6	Push-to-Start

	ATTENTION!	<p style="font-size: 10px; color: red;">DATE: XX-XX</p>	E5	<div style="text-align: center; background-color: red; color: white; padding: 5px; margin-bottom: 5px;">OFF</div> SPECIAL FUNCTIONS: BY DEFAULT DEACTIVATED
				<div style="text-align: center; background-color: green; color: white; padding: 5px; margin-bottom: 5px;">ON</div> MANUFACTURED MODULES BETWEEN: 04/2018 TO 04/2019

NOTES

****Manuelle Transmission.** Remote starter with compatible ata-Link required

<p style="background-color: red; color: white; padding: 2px; margin-bottom: 5px;">MANDATORY INSTALL</p> <p>*HOOD PIN</p> <p>HOOD STATUS: THE HOOD PIN SWITCH MUST BE INSTALLED IF THE VEHICLE CAN BE REMOTE STARTED WITH THE HOOD OPEN, SET FUNCTION A11 TO OFF.</p>	A11	OFF	<p style="font-size: 10px; color: red;">Notice: the installation of safety elements are mandatory. The hood pin is an essential security element and must be installed.</p>	<p style="font-size: 10px; color: red;">THIS MODULE MUST BE INSTALLED BY A QUALIFIED TECHNICIAN. A WRONG CONNECTION CAN CAUSE PERMANENT DAMAGE TO THE VEHICLE.</p>
---	-----	-----	---	--

DESCRIPTION



Parts required (Not included)
 1X 1Amp Diode
 1X Fuse (manual transmission)
 1X 180 Ohm Resistor (manual transmission)



BCM		ATS
CTS		
Escalade Tahoe Suburban Yukon	Under driver dash	Behind glove box

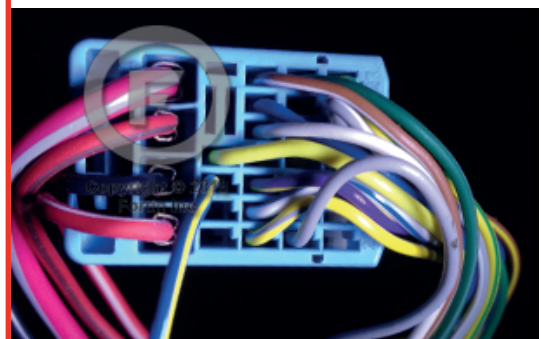
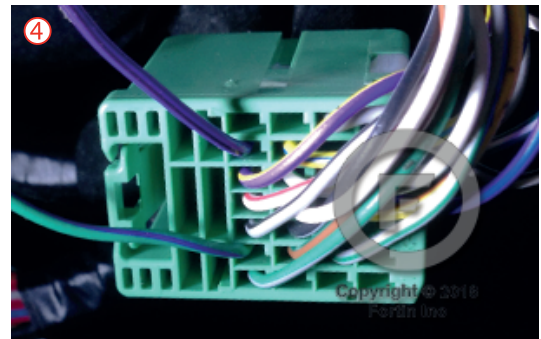
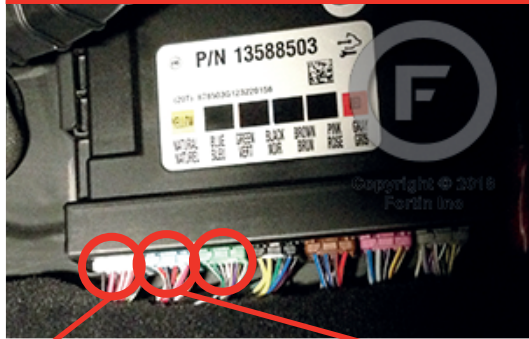

AUTOMATIC TRANSMISSION WIRING CONNECTION

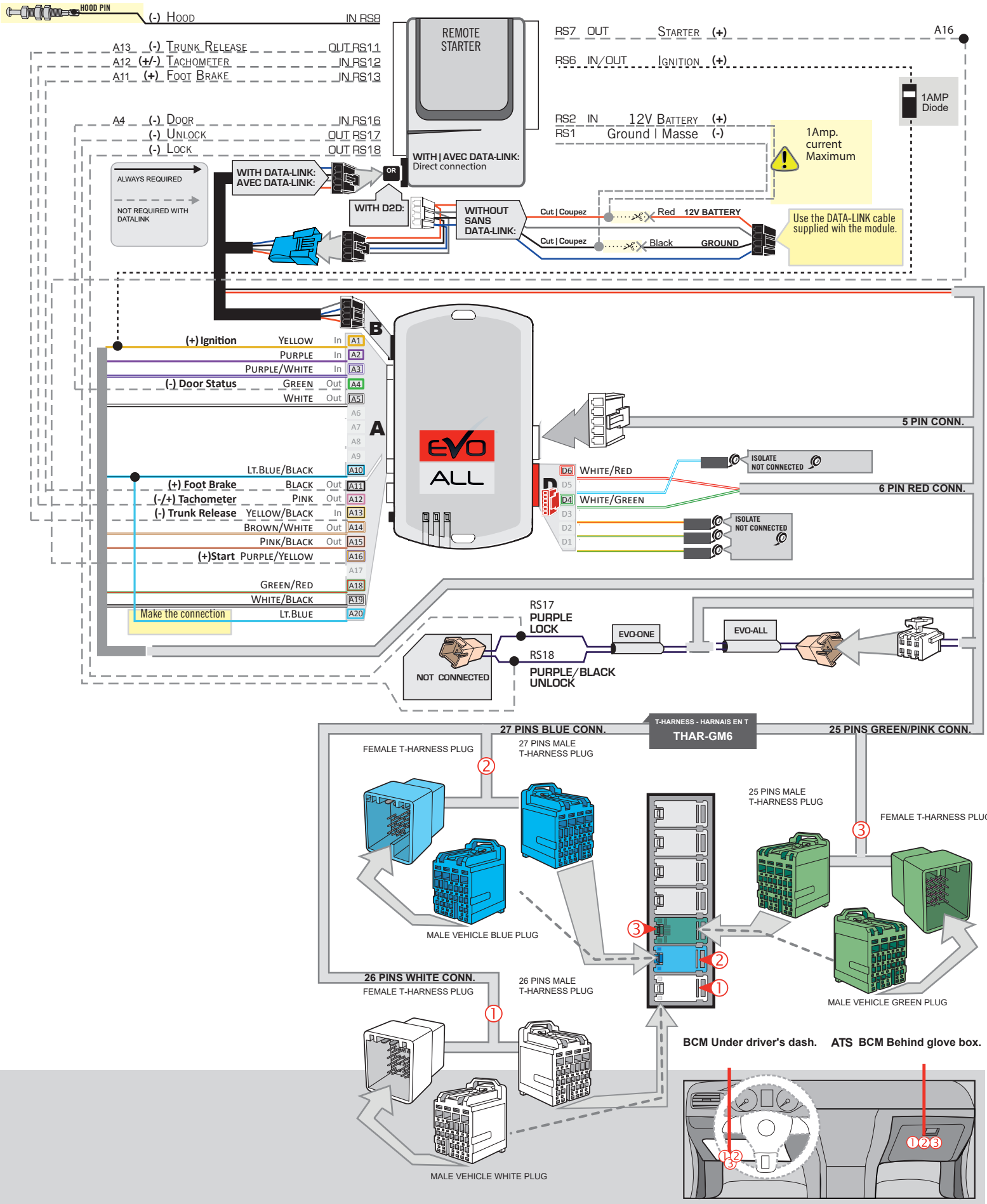

MANUAL TRANSMISSION WIRING CONNECTION

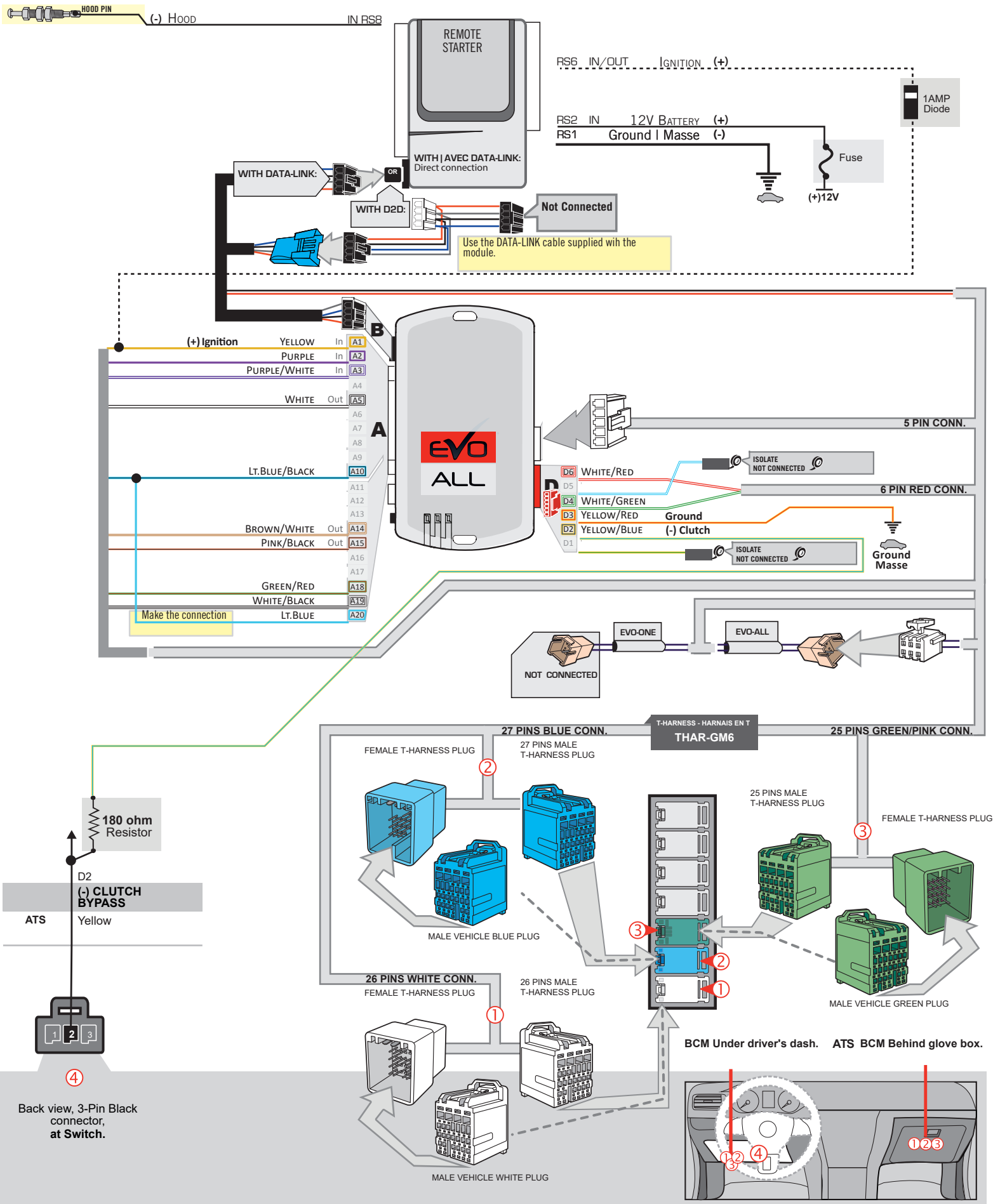

KEY BYPASS PROGRAMMING PROCEDURE 1/3

1 Remove the battery from the OEM remote.

2 Place the OEM remote in the **back** cup holder in the center console.

Refer to vehicle user guide for keyport location.



ATS

1 Remove the battery from the OEM remote.

2 Place the transmitter in the transmitter pocket, which is inside the **centre** console storage area.

Refer to vehicle user guide for keyport location.

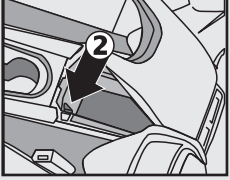

1

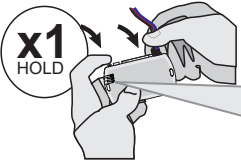

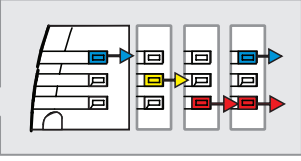

Press and hold the programming button:
Connect the 4-PIN Data-link harness (Black connector).

↳The Blue, Red, Yellow and Blue & Red LEDs will alternatively illuminate.

2

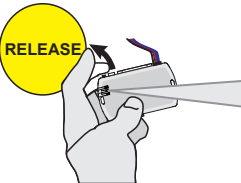

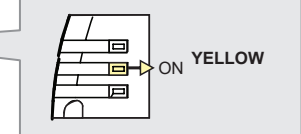

Release the programming button when the LED is **YELLOW**.

If the LED is not solid YELLOW disconnect the 4-Pin connector (Data-Link) and go back to step 1.

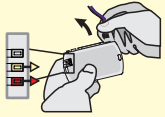

3

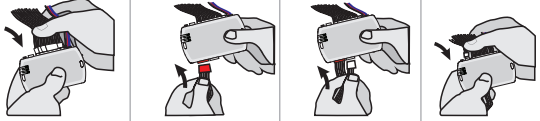

Insert the required remaining connectors.

4



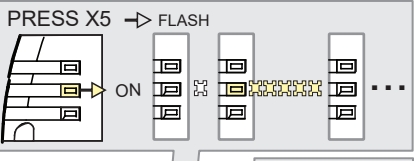

Press and release the programming button five (5x) times.

↳The YELLOW LED will flash 5 times each second.

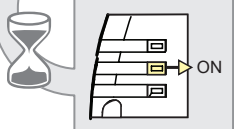

↳WAIT for the YELLOW LED to turn ON solide.

5

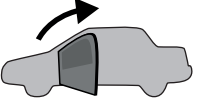

Open the driver door.

6



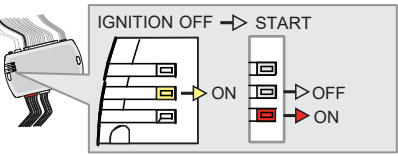

Press the foot-brake pedal.

Press the Push-to-Start button until the engine start.

Release the foot-brake pedal.

↳The RED LED will turn ON.
↳The YELLOW LED will turn OFF.



KEY BYPASS PROGRAMMING PROCEDURE 2/3

7



Press the Push-to-Start button until the engine turn OFF.

8

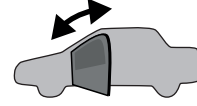

Close and open the driver door.

9

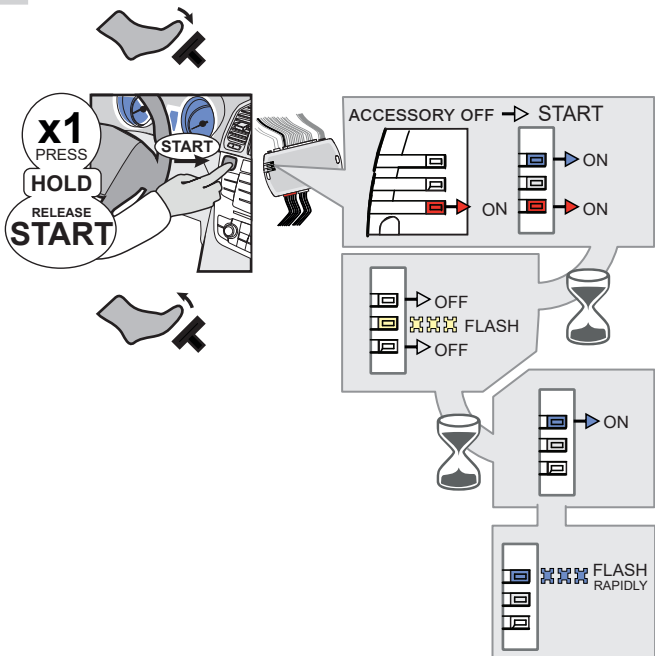

Press the foot-brake pedal.

Press the Push-to-Start button until the engine start.

Release the foot-brake pedal.

- ↳ The BLUE LED will turn ON.
- ↳ The BLUE LED will turn OFF. The RED LED will turn OFF.
- ↳ The YELLOW LED will flash rapidly
- ↳ The BLUE LED will turn ON.
- ↳ The BLUE LED will flash rapidly

10

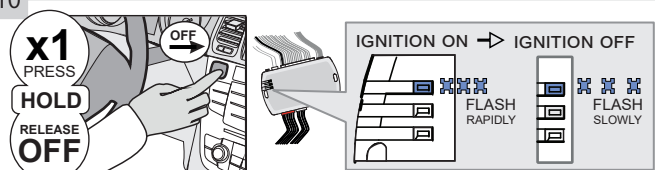

Press the Push-to-Start button until the engine turn OFF.

- ↳ The BLUE LED will flash slowly

11

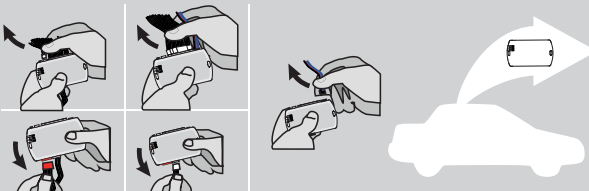

Disconnect all the connectors and after the Data-Link (4-pins) connector.

12

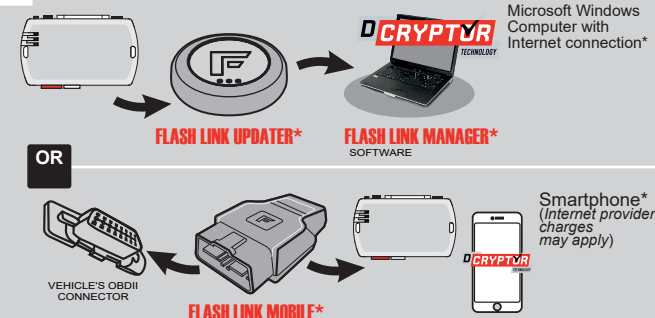

Microsoft Windows Computer with Internet connection*

FLASH LINK UPDATER* **FLASH LINK MANAGER*** SOFTWARE

OR

VEHICLE'S OBDII CONNECTOR **FLASH LINK MOBILE*** Smartphone* (Internet provider charges may apply)

Use the tool: FLASH LINK UPDATER or FLASH LINK MOBILE to visit the DCRYPTOR menu.

*Parts required (not included)

KEY BYPASS PROGRAMMING PROCEDURE 3/3

13

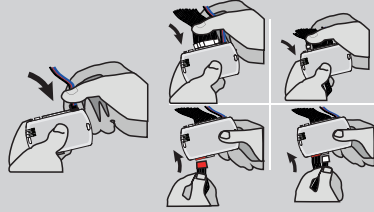
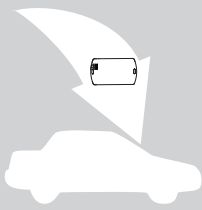

AFTER DCRYPTOR PROGRAMMING COMPLETED
Go back to the vehicle and **reconnect** the 4-Pin (Data-Link) connector and after, all the remaining connector.



The module is now programmed.



REMOTE STARTER / ALARM VERIFICATION PROCEDURE

Test the remote starter. **Remote start** the vehicle.

REMOTE STARTER FUNCTIONALITY |



All doors must be closed.



Remote start the vehicle.



Unlock the doors with either:

- The OEM remote
- The remote-starter remote
- Or the proximity remote



Enter the vehicle with the Intelligent Key.



The vehicle can now be put in to gear and driven.

If the vehicle is not unlocked with one of these conditions the remote-starter will shut down as soon as any door is opened.



THAR-GM6

THARNNESS INSTALLATION

ADDENDUM - SUGGESTED WIRING CONFIGURATION

			Vehicle functions supported in this diagram (functional if equipped)															
VEHICLE	YEARS		Immobilizer bypass	Lock	Unlock	Arm	Disarm	Trunk (open)	Parking Light	RAP Disable	Tachometer	Heated Seats	Door Status	Hood Status*	Trunk Status (Data-Link Only,Data-Link Seulement)	Hand-Brake Status (Data-Link Only,Data-Link Seulement)	Foot-Brake Status	OEM Remote Monitoring
																		
CHEVROLET																		
Corvette	Push-To-Start	2014-2019	•	•	•	•	•	•	•	•	•	•	•	•	•	•	•	•



FIRMWARE VERSION



70.[41]

GM MINIMUM

To add the firmware version and the options, use the **FLASH LINK UPDATER** or **FLASH LINK MOBILE** tool, sold separately.

<p>IF THE VEHICLE IS NOT EQUIPPED WITH FUNCTIONAL HOOD PIN:</p>	A11	OFF	Hood trigger (Output Status).
--	-----	------------	-------------------------------

		UNIT OPTION	DESCRIPTION
	<p>Program bypass option:</p>	C1	OEM Remote status (Lock/Unlock) monitoring
		D6	Push-to-Start

	ATTENTION!	 <p style="font-size: 10px; color: red;">DATE: XX-XX</p>	E5	OFF	<p>SPECIAL FUNCTIONS: BY DEFAULT DEACTIVATED</p>
				ON	<p>MANUFACTURED MODULES BETWEEN: 04/2018 TO 04/2019</p>

 **Parts required (Not included)**

1X 1Amp Diode

MANDATORY INSTALL

*HOOD PIN



HOOD STATUS: THE HOOD PIN SWITCH MUST BE INSTALLED IF THE VEHICLE CAN BE REMOTE STARTED WITH THE HOOD OPEN, SET FUNCTION A11 TO OFF.

A11

OFF

Notice: the installation of safety elements are mandatory. The hood pin is an essential security element and must be installed.

THIS MODULE MUST BE INSTALLED BY A QUALIFIED TECHNICIAN. A WRONG CONNECTION CAN CAUSE PERMANENT DAMAGE TO THE VEHICLE.

DESCRIPTION



At the BCM



③

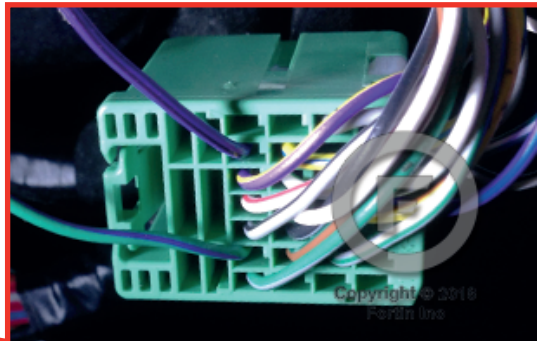

①



②

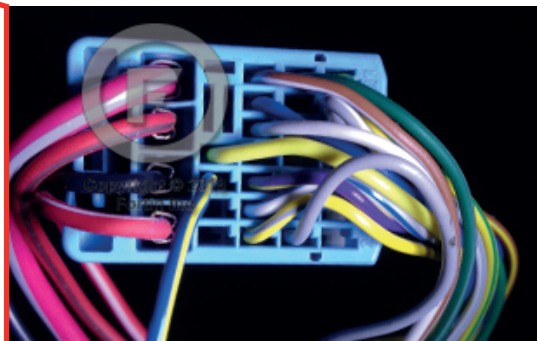

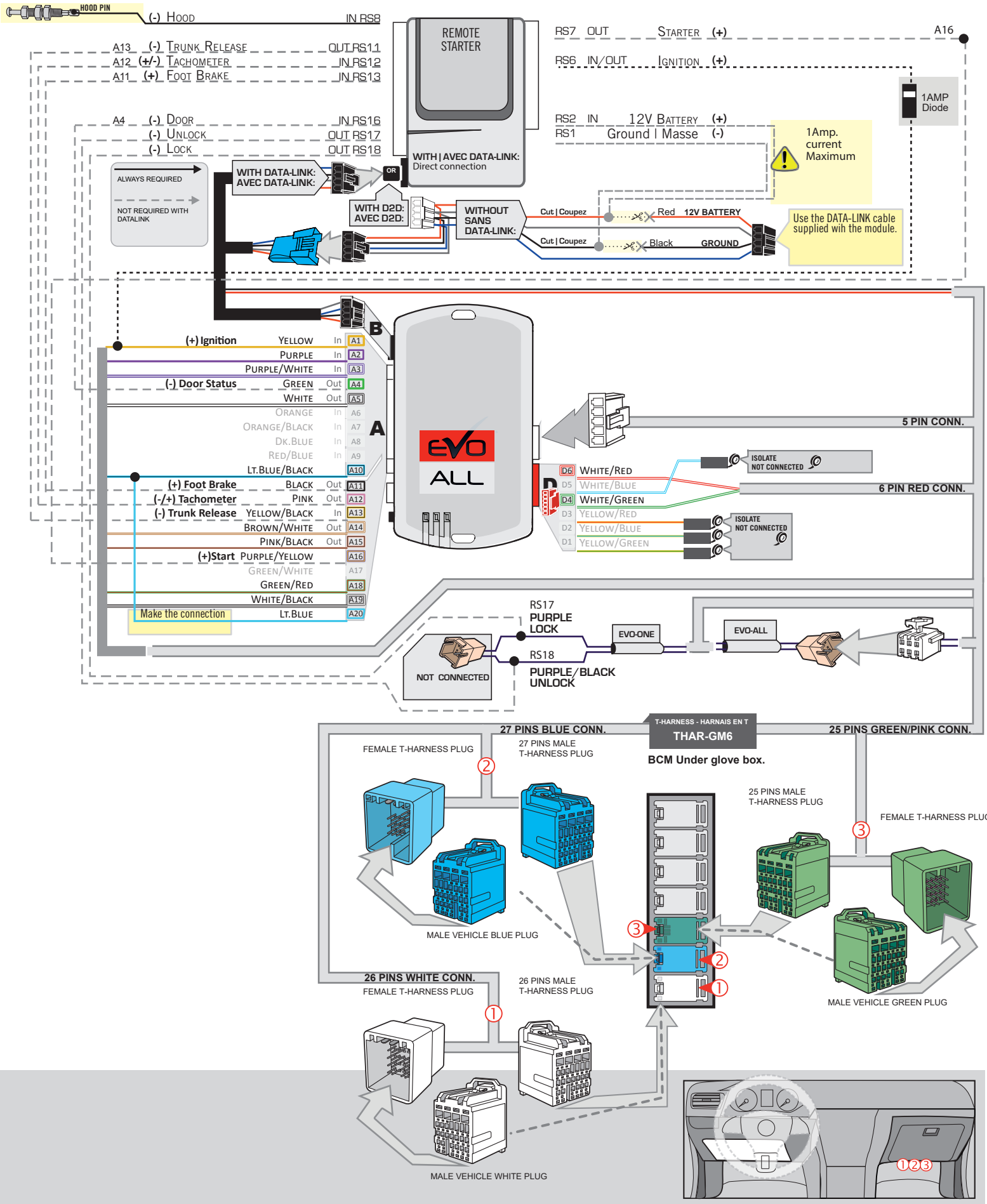

AUTOMATIC TRANSMISSION WIRING CONNECTION

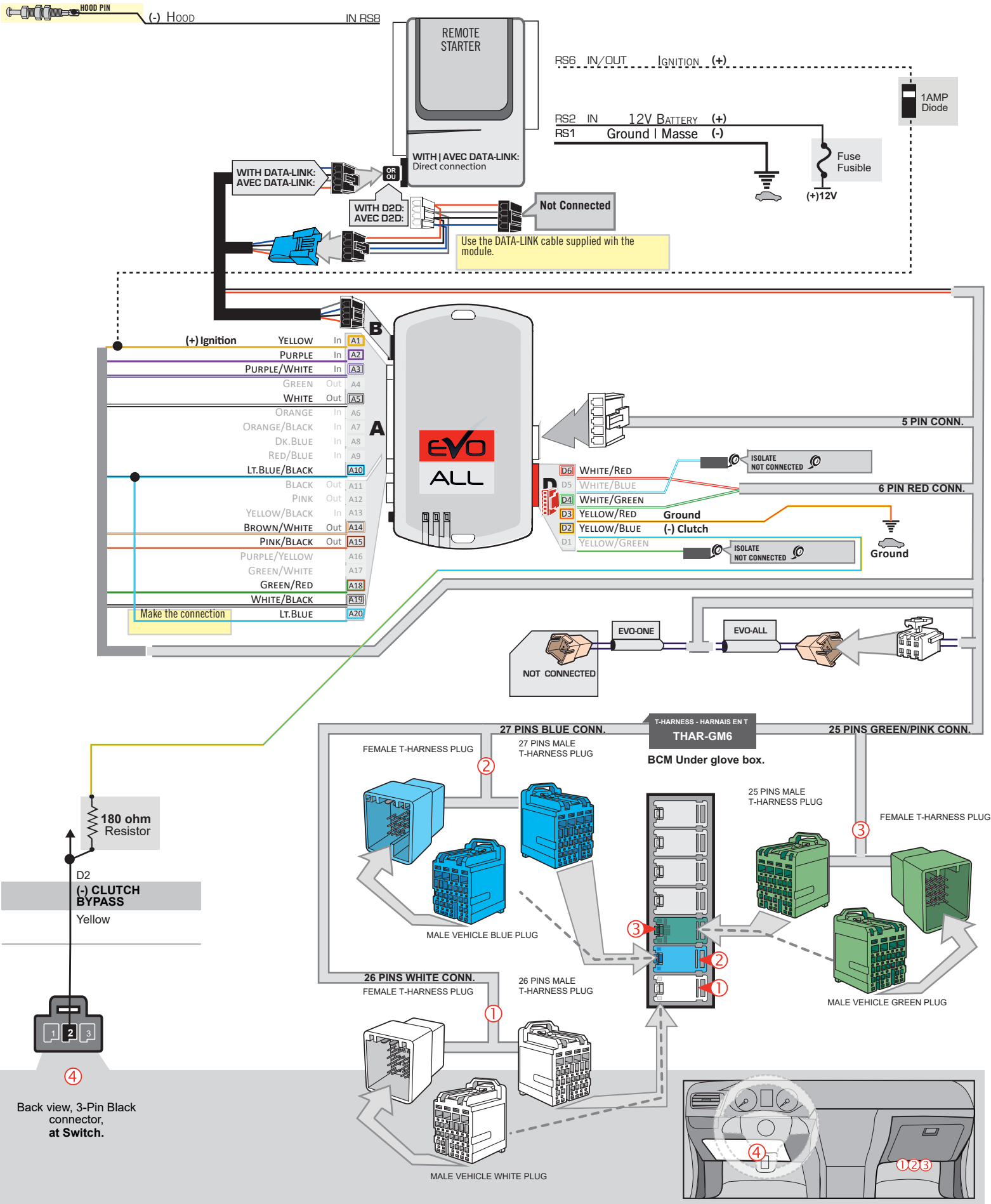

MANUAL TRANSMISSION WIRING CONNECTION

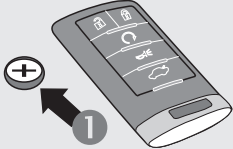
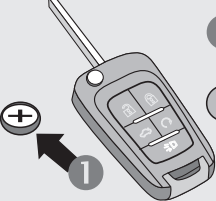

KEY BYPASS PROGRAMMING PROCEDURE 1/3

FIRST GENERATION	 <p>1 Remove the battery from the OEM remote.</p> <p>2 First generation OEM remotes: Place the OEM remotes in the key older.</p>	
SECOND GENERATION	 <p>1 Remove the battery from the OEM remote.</p> <p>2 Second generation OEM remotes: Place the OEM remotes in to the center console.</p>	

1

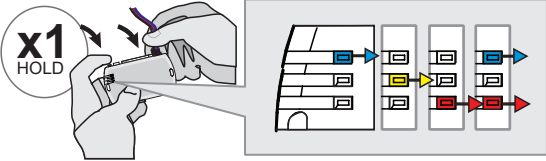

Press and hold the programming button:
Connect the 4-PIN Data-link harness (Black connector).

↳The Blue, Red, Yellow and Blue & Red LEDs will alternatively illuminate.

2

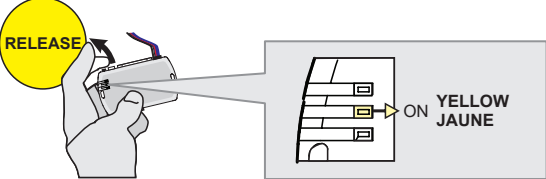

Release the programming button when the LED is YELLOW.

If the LED is not solid YELLOW disconnect the 4-Pin connector (Data-Link) and go back to step 1.

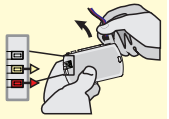

3

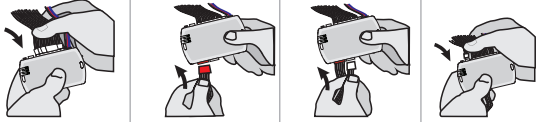

Insert the required remaining connectors.

4

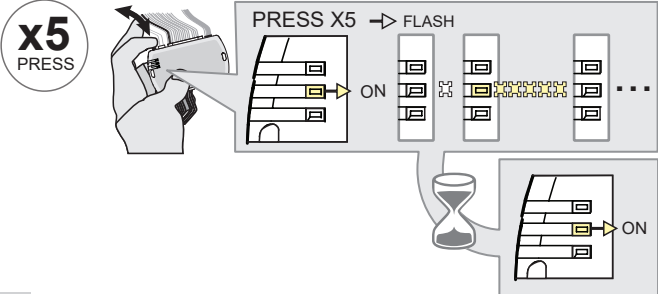

Press and release the programming button five (5x) times.

↳The YELLOW LED will flash 5 times each second.

↳**WAIT** for the YELLOW LED to turn ON solide.

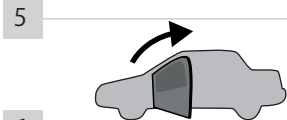

Open the driver door.

6

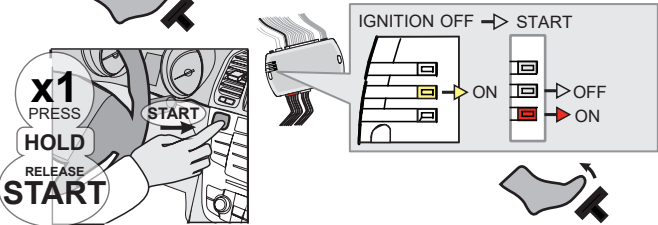

Press the foot-brake pedal.

Press the Push-to-Start button until the engine start.

Release the foot-brake pedal.

↳The RED LED will turn ON.
 ↳The YELLOW LED will turn OFF.

KEY BYPASS PROGRAMMING PROCEDURE 2/3

7



Press the Push-to-Start button until the engine turn OFF.

8

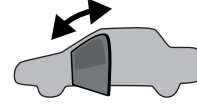

Close and open the driver door.

9

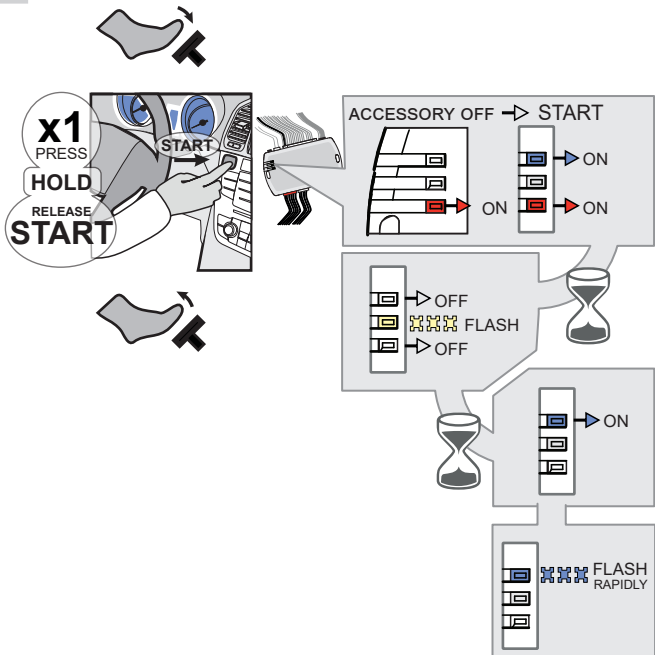

Press the foot-brake pedal.

Press the Push-to-Start button until the engine start.

Release the foot-brake pedal.

- ↳ The BLUE LED will turn ON.
- ↳ The BLUE LED will turn OFF. The RED LED will turn OFF.
- ↳ The YELLOW LED will flash rapidly
- ↳ The BLUE LED will turn ON.
- ↳ The BLUE LED will flash rapidly

10

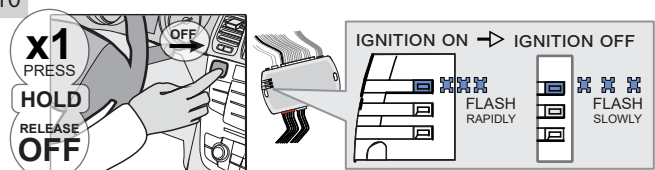

Press the Push-to-Start button until the engine turn OFF.

- ↳ The BLUE LED will flash slowly

11

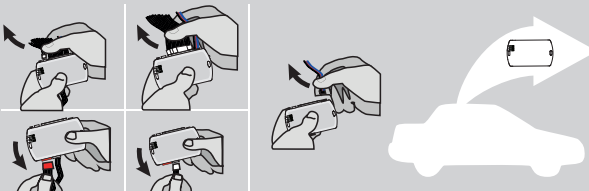

Disconnect all the connectors and after the Data-Link (4-pins) connector.

12

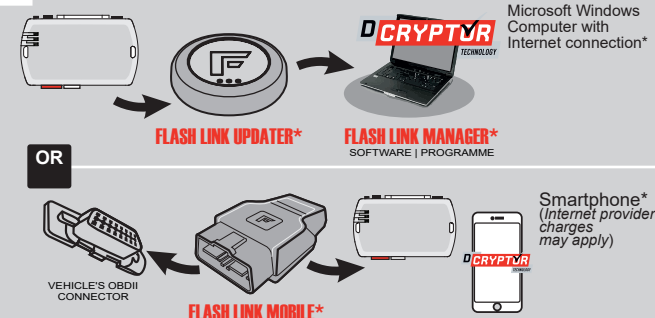

Use the tool: FLASH LINK UPDATER or FLASH LINK MOBILE to visit the DCryptor menu.

***Parts required (not included)**

KEY BYPASS PROGRAMMING PROCEDURE 3/3

13

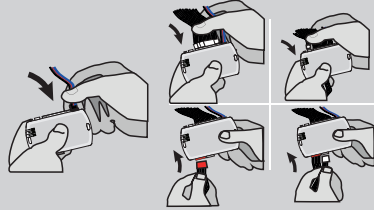
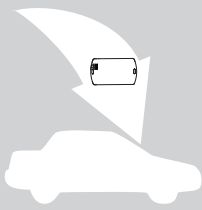

AFTER DCRYPTOR PROGRAMMING COMPLETED
Go back to the vehicle and **reconnect** the 4-Pin (Data-Link) connector and after, all the remaining connector.



The module is now programmed.



REMOTE STARTER / ALARM VERIFICATION PROCEDURE

Test the remote starter. Remote start the vehicle.

REMOTE STARTER FUNCTIONALITY



All doors must be closed.

Remote start the vehicle.



Press the Unlock button of the remote car starter.



Enter the vehicle with the Intelligent Access Key.

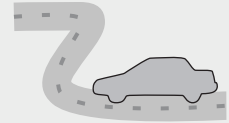

The vehicle can now be put in to gear and driven.



If the vehicle is not unlocked the module will shut down the remote-starter and the vehicle as soon as any door is opened.

DESCRIPTION



BCM

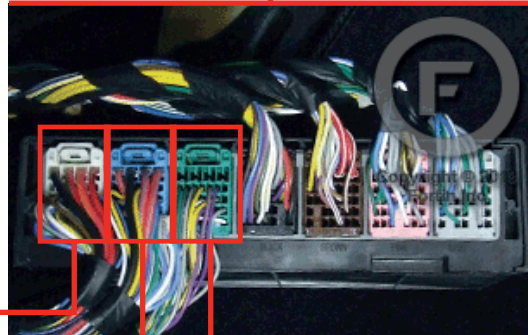

①



②

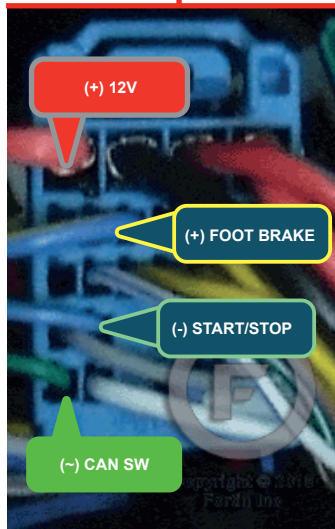

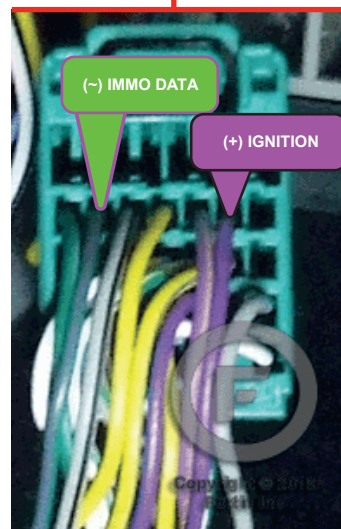

③

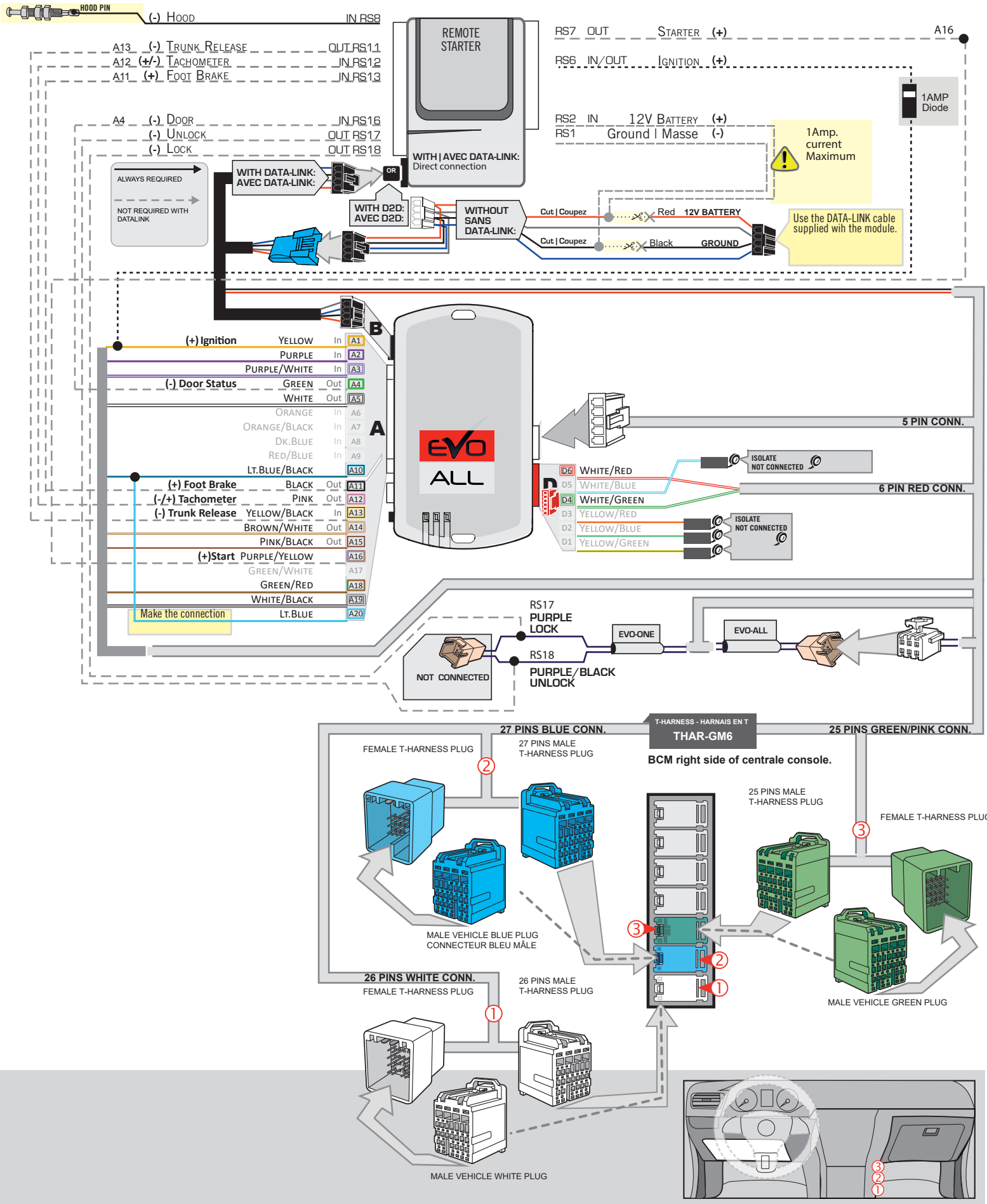

AUTOMATIC TRANSMISSION WIRING CONNECTION

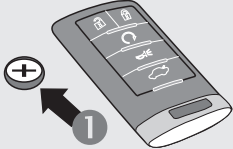
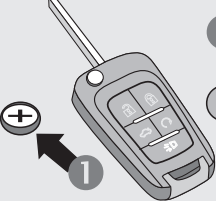

KEY BYPASS PROGRAMMING PROCEDURE 1/3

FIRST GENERATION	 <p>1 Remove the battery from the OEM remote.</p> <p>2 First generation OEM remotes: Place the OEM remotes in the key older.</p>	
SECOND GENERATION	 <p>1 Remove the battery from the OEM remote.</p> <p>2 Second generation OEM remotes: Place the OEM remotes in to the center console.</p>	

1

x1 HOLD

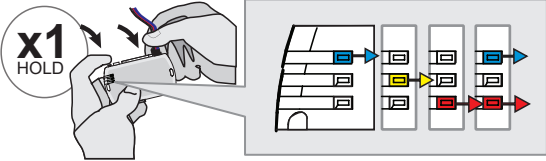

Press and hold the programming button:
Connect the 4-PIN Data-link harness (Black connector).

↳The Blue, Red, Yellow and Blue & Red LEDs will alternatively illuminate.

2

RELEASE

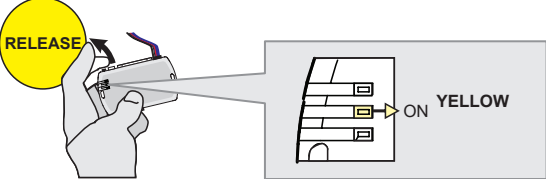

Release the programming button when the LED is **YELLOW**.

If the LED is not solid **YELLOW** disconnect the 4-Pin connector (Data-Link) and go back to step 1.

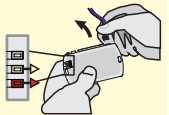

3

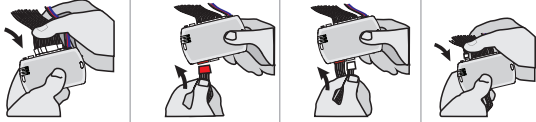

Insert the required remaining connectors.

4

x5 PRESS

PRESS X5 → FLASH

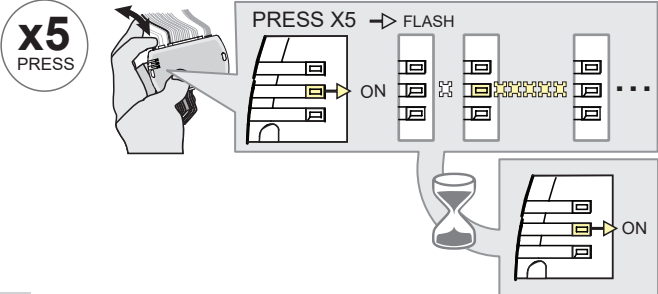

Press and release the programming button five (5x) times.

↳The **YELLOW LED** will flash 5 times each second.

↳**WAIT** for the **YELLOW LED** to turn **ON** solide.

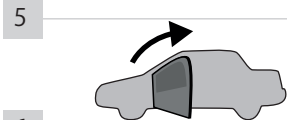

Open the driver door.

6

x1 PRESS

HOLD

RELEASE

START

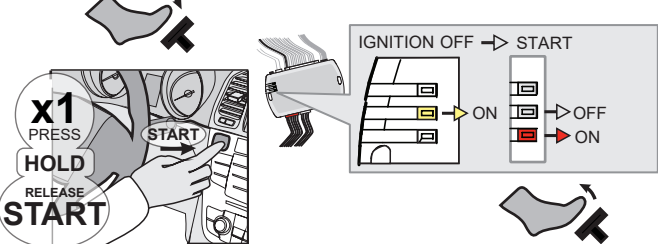

Press the foot-brake pedal.

Press the Push-to-Start button until the engine start.

Release the foot-brake pedal.

↳The **RED LED** will turn **ON**.
 ↳The **YELLOW LED** will turn **OFF**.

KEY BYPASS PROGRAMMING PROCEDURE 2/3

7



Press the Push-to-Start button until the engine turn OFF.

8

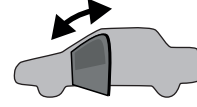

Close and open the driver door.

9

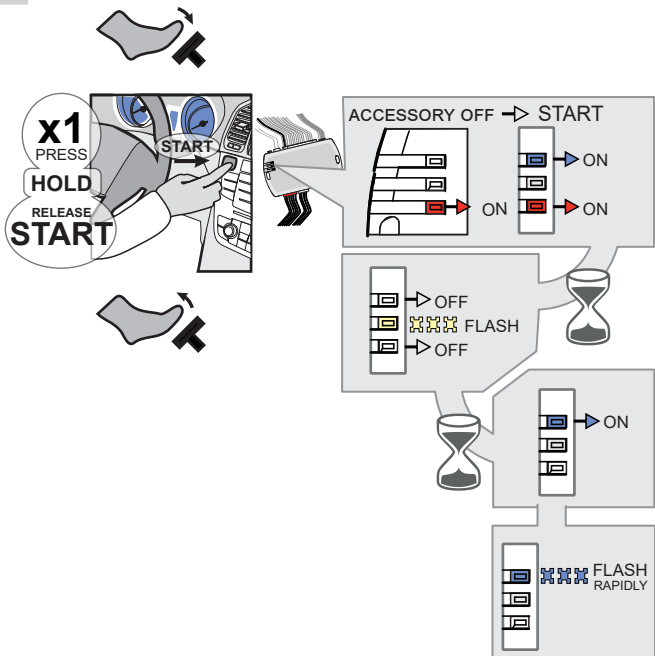

Press the foot-brake pedal.

Press the Push-to-Start button until the engine start.

Release the foot-brake pedal.

- ↳ The BLUE LED will turn ON.
- ↳ The BLUE LED will turn OFF. The RED LED will turn OFF.
- ↳ The YELLOW LED will flash rapidly
- ↳ The BLUE LED will turn ON.
- ↳ The BLUE LED will flash rapidly

10

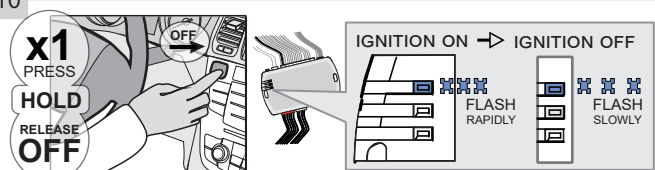

Press the Push-to-Start button until the engine turn OFF.

- ↳ The BLUE LED will flash slowly

11

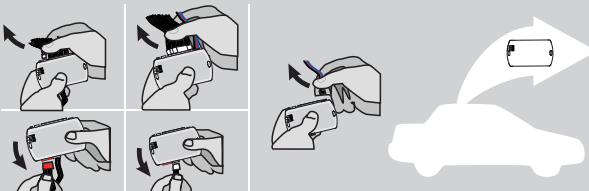

Disconnect all the connectors and after the Data-Link (4-pins) connector.

12

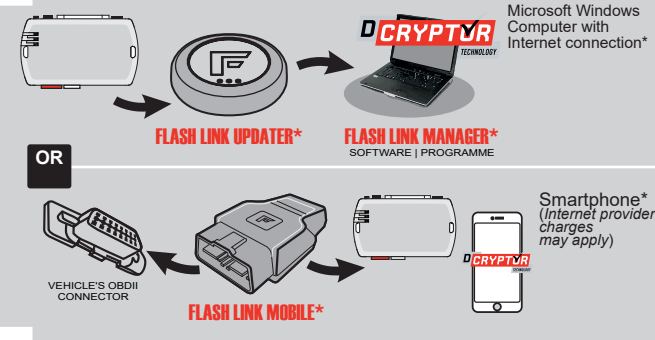

Microsoft Windows Computer with Internet connection*

FLASH LINK UPDATER* FLASH LINK MANAGER*
SOFTWARE | PROGRAMME

OR

FLASH LINK MOBILE* Smartphone*
(Internet provider charges may apply)

Use the tool: FLASH LINK UPDATER or FLASH LINK MOBILE to visit the DCryptor menu.

*Parts required (not included)

KEY BYPASS PROGRAMMING PROCEDURE 3/3

13

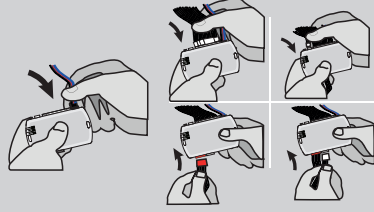
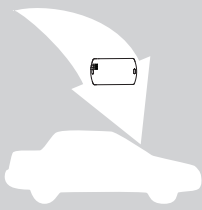

AFTER DCRYPTOR PROGRAMMING COMPLETED
Go back to the vehicle and **reconnect** the 4-Pin (Data-Link) connector and after, all the remaining connector.



The module is now programmed.



REMOTE STARTER / ALARM VERIFICATION PROCEDURE

Test the remote starter. Remote start the vehicle.

REMOTE STARTER FUNCTIONALITY



All doors must be closed.

Remote start the vehicle.



Press the Unlock button of the remote car starter.



Enter the vehicle with the Intelligent Access Key.



The vehicle can now be put in to gear and driven.





If the vehicle is not unlocked the module will shut down the remote-starter and the vehicle as soon as any door is opened.

THAR-GM6

THARNNESS INSTALLATION

ADDENDUM - SUGGESTED WIRING CONFIGURATION

VEHICLE	YEARS	Vehicle functions supported in this diagram (functional if equipped)															
		Immobilizer bypass	Lock	Unlock	Arm	Disarm	Trunk (open)	RAP Disable	Tachometer	Heated Seats	Door Status	Trunk Status (Data-Link Only, Data-Link Seulement)	Hand-Brake Status (Data-Link Only, Data-Link Seulement)	Foot-Brake Status	OEM Remote		
																	
CHEVROLET																	
Cruze	Push-To-Start**	2016-2019	•	•	•	•	•	•	•	•	•	•	•	•	•	•	•



FIRMWARE VERSION



70.[41]

GM MINIMUM

To add the firmware version and the options, use the **FLASH LINK UPDATER** or **FLASH LINK MOBILE** tool, sold separately.

IF THE VEHICLE IS NOT EQUIPPED WITH FUNCTIONAL HOOD PIN:	A11	OFF	Hood trigger (Output Status).
--	-----	-----	-------------------------------

	Program bypass option:	UNIT OPTION	DESCRIPTION
		C1	OEM Remote status (Lock/Unlock) monitoring
		D6	Push-to-Start

	ATTENTION!	 <p style="font-size: 12px;">DATE: XX-XX</p>	E5	OFF	<p>SPECIAL FUNCTIONS: BY DEFAULT DEACTIVATED</p>
				ON	<p>MANUFACTURED MODULES BETWEEN: 04/2018 TO 04/2019</p>

 **Parts required (Not included)**

1X 1Amp Diode
1X THAR-GM6

MANDATORY INSTALL	<p>*HOOD PIN </p> <p>HOOD STATUS: THE HOOD PIN SWITCH MUST BE INSTALLED IF THE VEHICLE CAN BE REMOTE STARTED WITH THE HOOD OPEN, SET FUNCTION A11 TO OFF.</p>	A11	OFF	<p>Notice: the installation of safety elements are mandatory. The hood pin is an essential security element and must be installed.</p>	<p>THIS MODULE MUST BE INSTALLED BY A QUALIFIED TECHNICIAN. A WRONG CONNECTION CAN CAUSE PERMANENT DAMAGE TO THE VEHICLE.</p>
--------------------------	--	-----	-----	---	---

DESCRIPTION



BCM, Above Driver kick panel

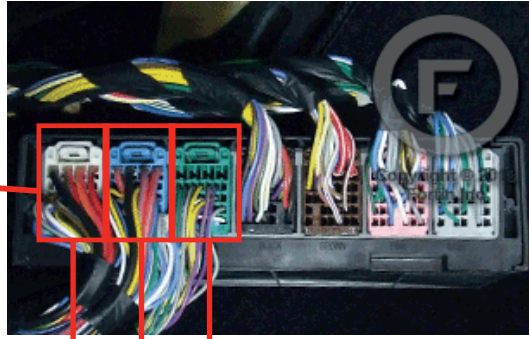

①



②

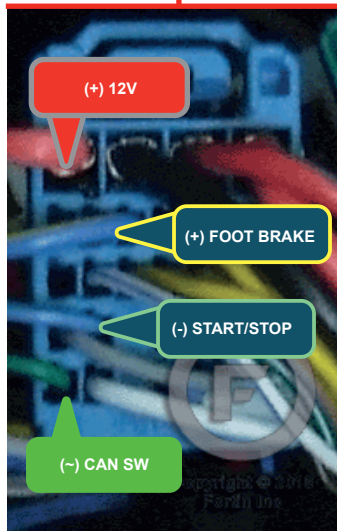

③

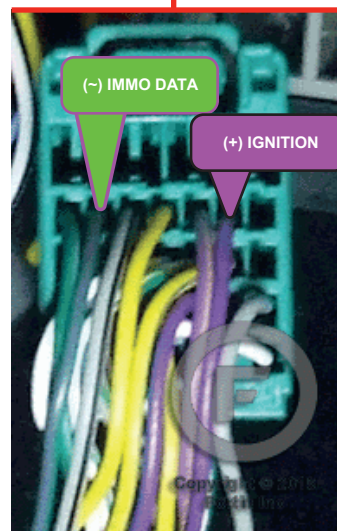

AUTOMATIC TRANSMISSION WIRING CONNECTION

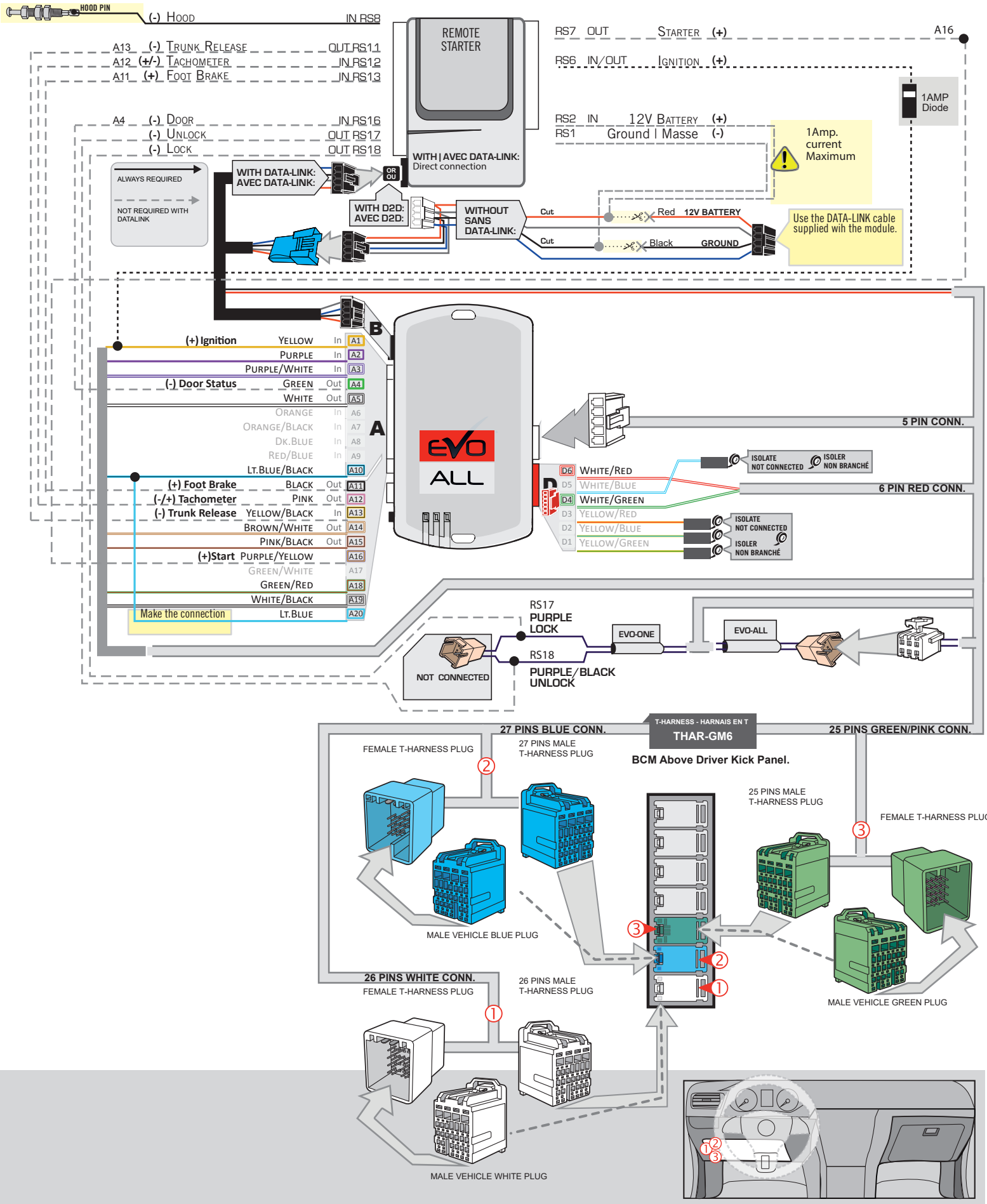

KEY BYPASS PROGRAMMING PROCEDURE 1/3

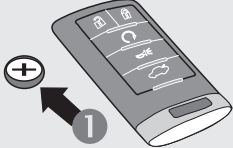
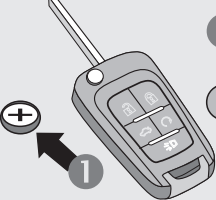
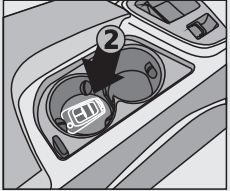
FIRST GENERATION	 <p>1 Remove the battery from the OEM remote.</p> <p>2 First generation OEM remotes: Place the OEM remotes in the key older.</p>	
SECOND GENERATION	 <p>1 Remove the battery from the OEM remote.</p> <p>2 Second generation OEM remotes: Place the OEM remotes in to the center console.</p>	

1

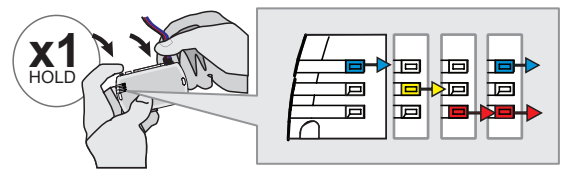

Press and hold the programming button:
Connect the 4-PIN Data-link harness (Black connector).

↳The Blue, Red, Yellow and Blue & Red LEDs will alternatively illuminate.

2

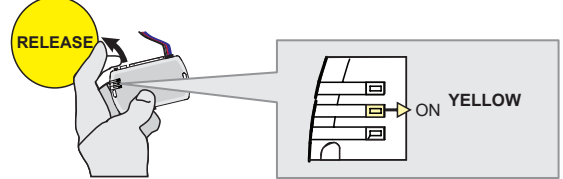

Release the programming button when the LED is YELLOW.

If the LED is not solid YELLOW disconnect the 4-Pin connector (Data-Link) and go back to step 1.



3

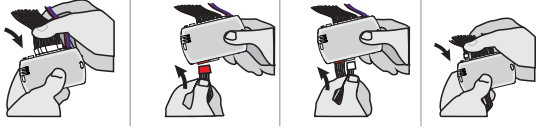

Insert the required remaining connectors.

4

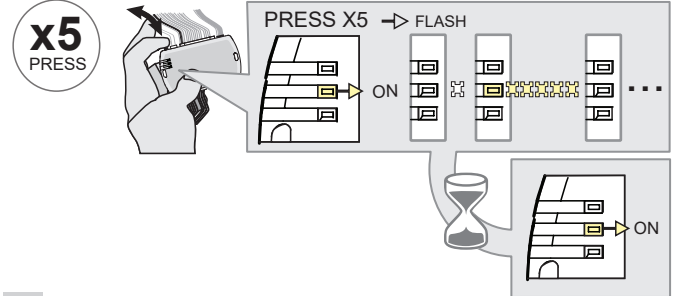

Press and release the programming button five (5x) times.

↳The YELLOW LED will flash 5 times each second.

↳**WAIT** for the YELLOW LED to turn ON solide.

5

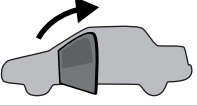

Open the driver door.

6

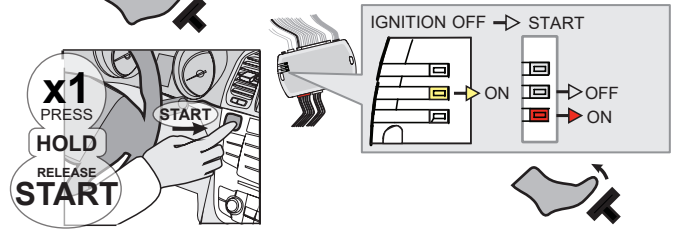

Press the foot-brake pedal.
Press the Push-to-Start button until the engine start.
Release the foot-brake pedal.

↳The RED LED will turn ON.
 ↳The YELLOW LED will turn OFF.

KEY BYPASS PROGRAMMING PROCEDURE 2/3

7



Press the Push-to-Start button until the engine turn OFF.

8

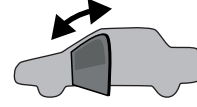

Close and open the driver door.

9

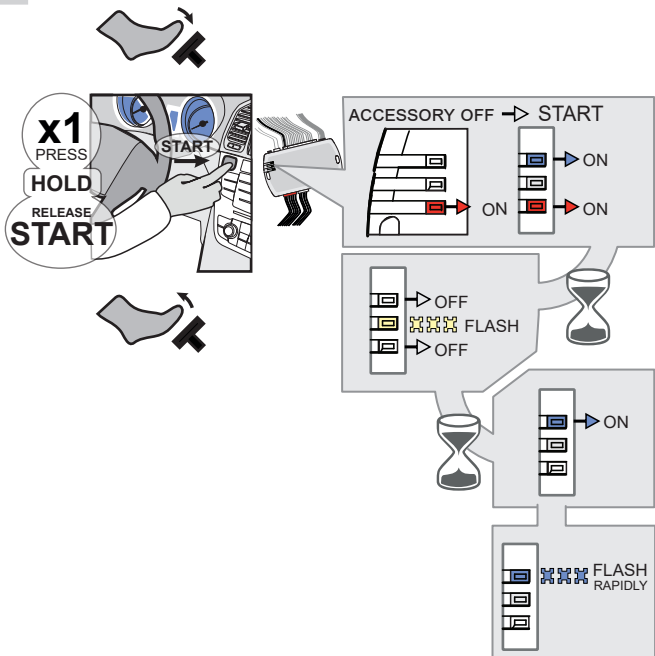

Press the foot-brake pedal.

Press the Push-to-Start button until the engine start.

Release the foot-brake pedal.

- ↳ The BLUE LED will turn ON.
- ↳ The BLUE LED will turn OFF. The RED LED will turn OFF.
- ↳ The YELLOW LED will flash rapidly
- ↳ The BLUE LED will turn ON.
- ↳ The BLUE LED will flash rapidly

10

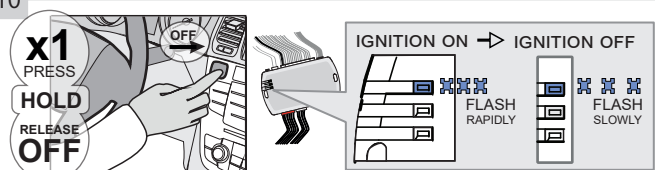

Press the Push-to-Start button until the engine turn OFF.

- ↳ The BLUE LED will flash slowly

11

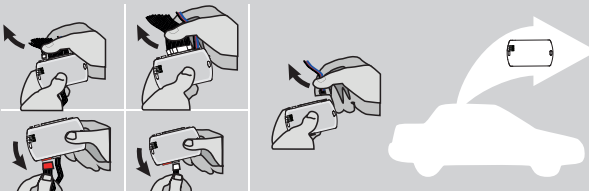

Disconnect all the connectors and after the Data-Link (4-pins) connector.

12

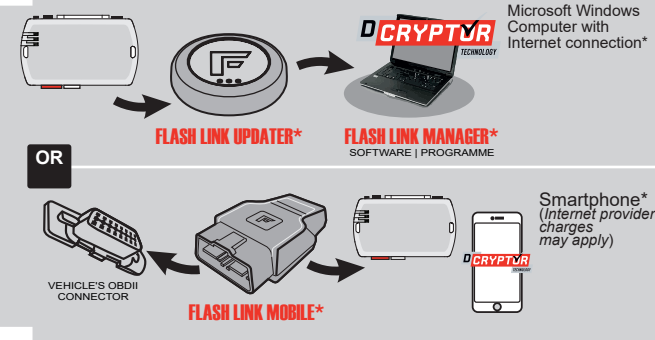

Microsoft Windows Computer with Internet connection*

FLASH LINK UPDATER* FLASH LINK MANAGER*
SOFTWARE | PROGRAMME

OR

Smartphone* (Internet provider charges may apply)

VEHICLE'S OBDII CONNECTOR FLASH LINK MOBILE*

Use the tool: FLASH LINK UPDATER or FLASH LINK MOBILE to visit the DCryptor menu.

*Parts required (not included)

KEY BYPASS PROGRAMMING PROCEDURE 3/3

13

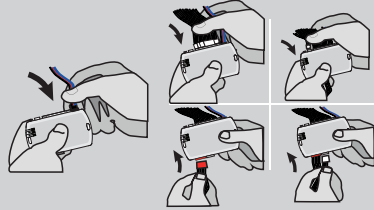
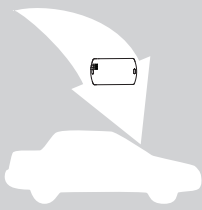

AFTER DCRYPTOR PROGRAMMING COMPLETED
Go back to the vehicle and **reconnect** the 4-Pin (Data-Link) connector and after, all the remaining connector.



The module is now programmed.



REMOTE STARTER / ALARM VERIFICATION PROCEDURE

Test the remote starter. Remote start the vehicle.

REMOTE STARTER FUNCTIONALITY



All doors must be closed.

Remote start the vehicle.



Press the Unlock button of the remote car starter.

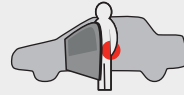

Enter the vehicle with the Intelligent Access Key.



The vehicle can now be put in to gear and driven.





If the vehicle is not unlocked the module will shut down the remote-starter and the vehicle as soon as any door is opened.

THAR-GM6

THARNNESS INSTALLATION



ADDENDUM - SUGGESTED WIRING CONFIGURATION

VEHICLE	YEARS	Vehicle functions supported in this diagram (functional if equipped)															
		Immobilizer bypass	Lock	Unlock	Arm	Disarm	Trunk (open)	Parking Lights	RAP Disable	Tachometer	Heated Seats	Door Status	Trunk Status (Data-Link Only, Data-Link Seulement)	Hand-Brake Status (Data-Link Only, Data-Link Seulement)	Foot-Brake Status	OEM Remote Monitoring	
																	
CADILLAC																	
CT6	Push-To-Start	2016-2018	•	•	•	•	•	•	•	•	•	•	•	•	•	•	•

	FIRMWARE VERSION	To add the firmware version and the options, use the FLASH LINK UPDATER or FLASH LINK MOBILE tool, sold separately.
	70.[41] GM MINIMUM	

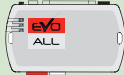
IF THE VEHICLE IS NOT EQUIPPED WITH FUNCTIONAL HOOD PIN:	A11	OFF	Hood trigger (Output Status).
---	------------	------------	-------------------------------

	Program bypass option:	UNIT OPTION	DESCRIPTION
		C1	OEM Remote status (Lock/Unlock) monitoring
		D6	Push-to-Start

	ATTENTION!		DATE: XX-XX	OFF	SPECIAL FUNCTIONS: BY DEFAULT DEACTIVATED
			E5	ON	MANUFACTURED MODULES BETWEEN: 04/2018 TO 04/2019

 **Parts required (Not included)**
1X 1Amp Diode

MANDATORY INSTALL

*HOOD PIN



HOOD STATUS: THE HOOD PIN SWITCH MUST BE INSTALLED IF THE VEHICLE CAN BE REMOTE STARTED WITH THE HOOD OPEN, SET FUNCTION **A11** TO OFF.

A11

OFF

Notice: the installation of safety elements are mandatory. The hood pin is an essential security element and must be installed.

THIS MODULE MUST BE INSTALLED BY A QUALIFIED TECHNICIAN. A WRONG CONNECTION CAN CAUSE PERMANENT DAMAGE TO THE VEHICLE.

DESCRIPTION

BCM

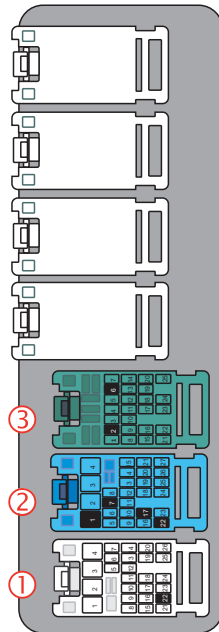

③



②

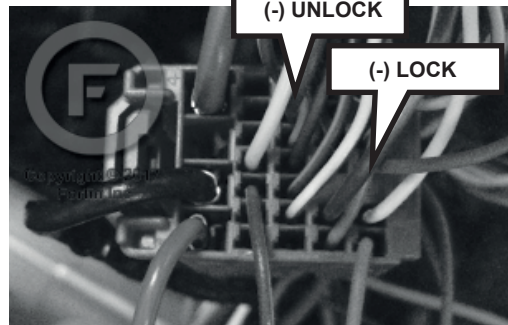

①



AUTOMATIC TRANSMISSION WIRING CONNECTION

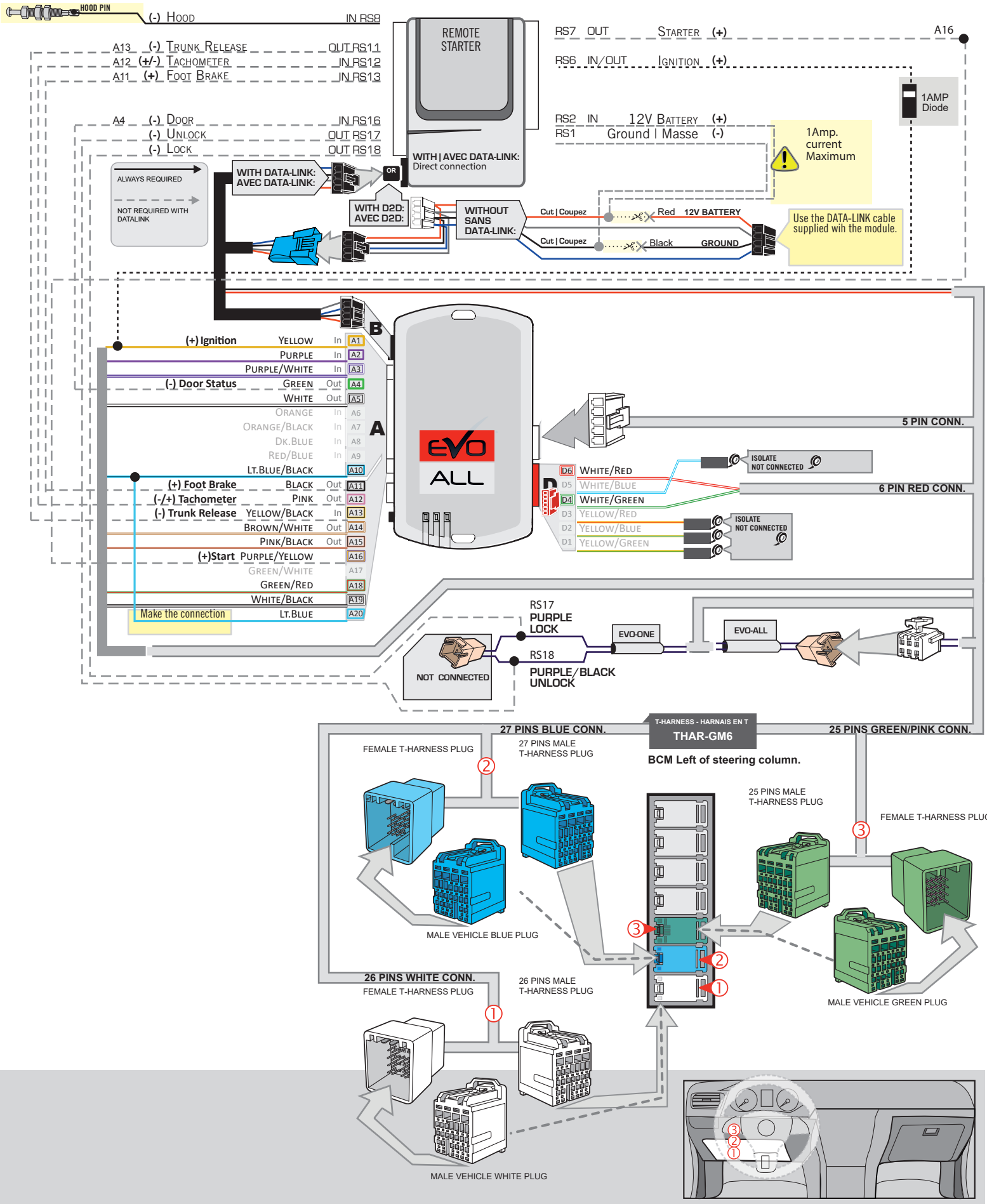

KEY BYPASS PROGRAMMING PROCEDURE 1/3

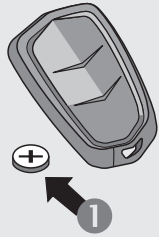

1 Remove the battery from the OEM remote.

2 Place the OEM remote into the transmitter pocket of the center console.

Refer to vehicle user guide for keyport location.

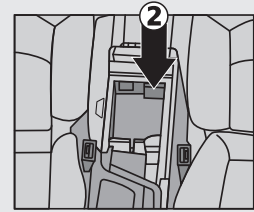

1

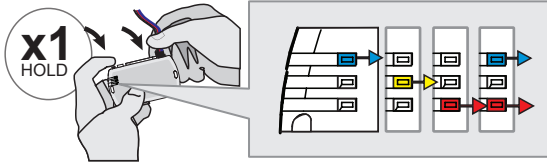

Press and hold the programming button:
Connect the 4-PIN Data-link harness (Black connector).

↳The Blue, Red, Yellow and Blue & Red LEDs will alternatively illuminate.

2

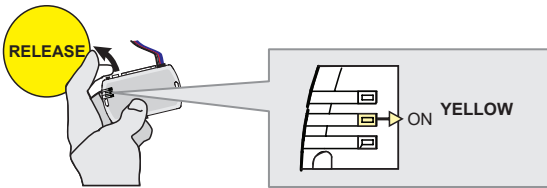

Release the programming button when the LED is YELLOW.

If the LED is not solid YELLOW disconnect the 4-Pin connector (Data-Link) and go back to step 1.

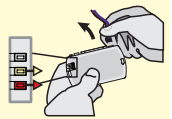

3

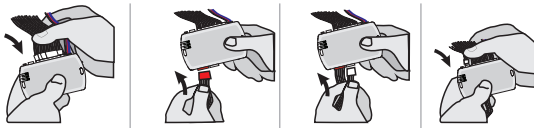

Insert the required remaining connectors.

4

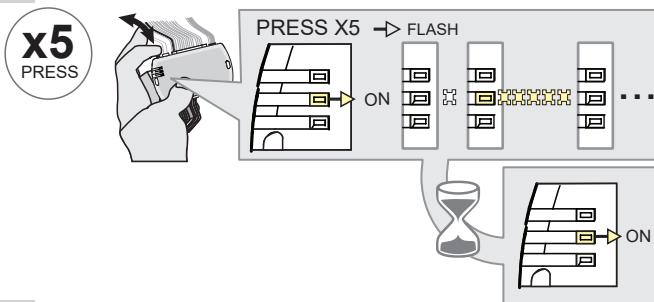

Press and release the programming button five (5x) times.

↳The YELLOW LED will flash 5 times each second.

↳**WAIT** for the YELLOW LED to turn ON solide.

5

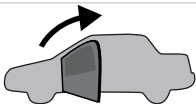

Open the driver door.

6

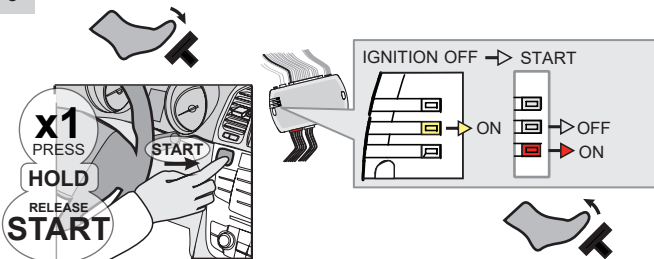

Press the foot-brake pedal.

Press the Push-to-Start button until the engine start.

Release the foot-brake pedal.

↳The RED LED will turn ON.
 ↳The YELLOW LED will turn OFF.

KEY BYPASS PROGRAMMING PROCEDURE 2/3

7



Press the Push-to-Start button until the engine turn OFF.

8

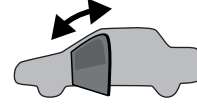

Close and open the driver door.

9

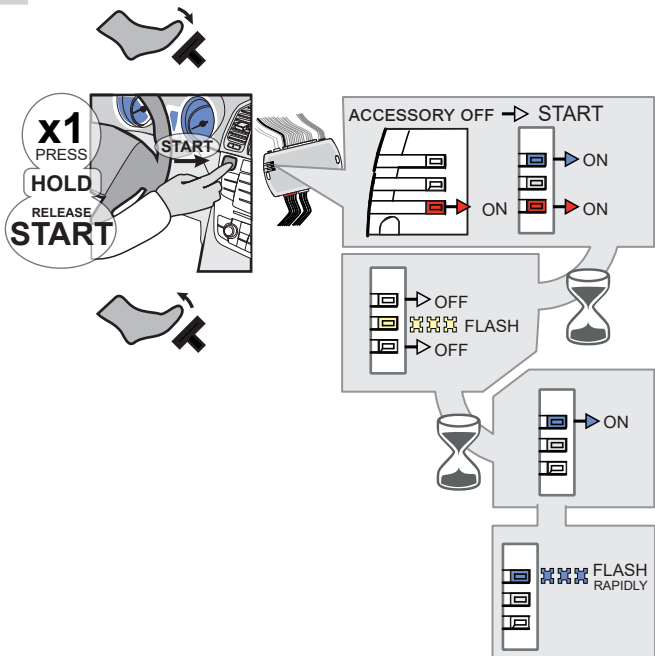

Press the foot-brake pedal.

Press the Push-to-Start button until the engine start.

Release the foot-brake pedal.

- ↳ The BLUE LED will turn ON.
- ↳ The BLUE LED will turn OFF. The RED LED will turn OFF.
- ↳ The YELLOW LED will flash rapidly
- ↳ The BLUE LED will turn ON.
- ↳ The BLUE LED will flash rapidly

10

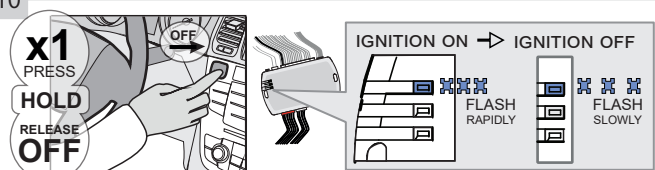

Press the Push-to-Start button until the engine turn OFF.

- ↳ The BLUE LED will flash slowly

11

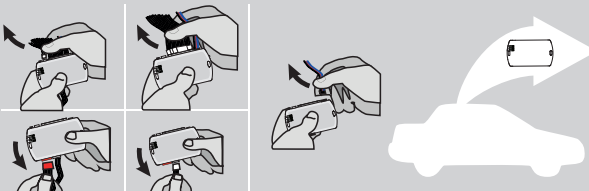

Disconnect all the connectors and after the Data-Link (4-pins) connector.

12

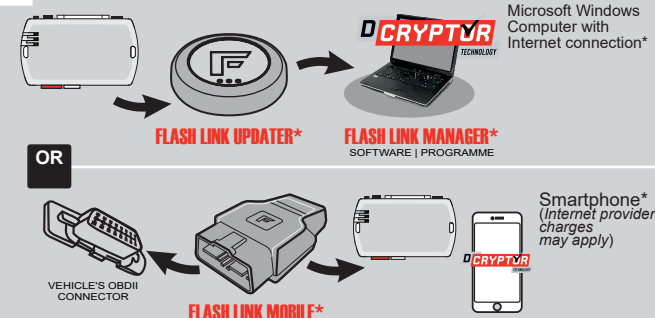

Microsoft Windows Computer with Internet connection*

FLASH LINK UPDATER* **FLASH LINK MANAGER***
SOFTWARE | PROGRAMME

OR

Smartphone* (Internet provider charges may apply)

FLASH LINK MOBILE*

Use the tool: FLASH LINK UPDATER or FLASH LINK MOBILE to visit the DCryptor menu.

*Parts required (not included)

KEY BYPASS PROGRAMMING PROCEDURE 3/3

13

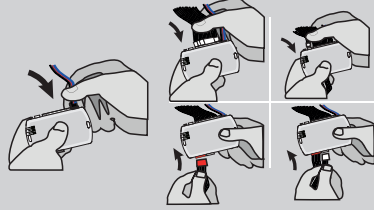
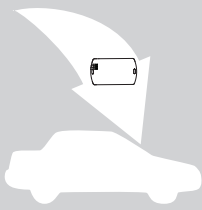

AFTER DCRYPTOR PROGRAMMING COMPLETED
Go back to the vehicle and **reconnect** the 4-Pin (Data-Link) connector and after, all the remaining connector.



The module is now programmed.



REMOTE STARTER / ALARM VERIFICATION PROCEDURE

Test the remote starter. Remote start the vehicle.

REMOTE STARTER FUNCTIONALITY



All doors must be closed.

Remote start the vehicle.



Press the Unlock button of the remote car starter or the OEM remote.

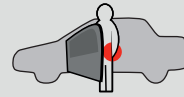

Enter the vehicle with the Intelligent Access Key.

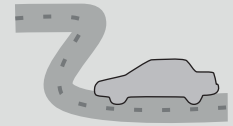

The vehicle can now be put in to gear and driven.



If the vehicle is not unlocked the module will shut down the remote-starter and the vehicle as soon as any door is opened.

THAR-GM6

THARNNESS INSTALLATION

ADDENDUM - SUGGESTED WIRING CONFIGURATION

VEHICLE	YEARS	Vehicle functions supported in this diagram (functional if equipped)													
		Immobilizer bypass	Lock	Unlock	Arm	Disarm	Trunk (open)	RAP Disable	Tachometer	Heated Seats	Door Status	Trunk Status (Data-Link Only, Data-Link Seulement)	Hand-Brake Status (Data-Link Only, Data-Link Seulement)	Foot-Brake Status	OEM Remote Monitoring
															
BUICK															
Encore GX	Push-To-Start	2020-2021	•	•	•	•	•	•	•	•	•	•	•	•	•

FIRMWARE VERSION

To add the firmware version and the options, use the **FLASH LINK UPDATER** or **FLASH LINK MOBILE** tool, sold separately.

70.[45]

GM MINIMUM

UNIT OPTION	DESCRIPTION
C1	OEM Remote status (Lock/Unlock) monitoring
A11 <input type="checkbox"/>	IF THE VEHICLE IS NOT EQUIPPED WITH FUNCTIONAL HOOD PIN: Hood trigger (Output Status).
D6	Push-to-Start Push-to-Start

ATTENTION!

DATE: XX-XX

E5 OFF

SPECIAL FUNCTIONS: BY DEFAULT DEACTIVATED

MANUFACTURED MODULES BETWEEN: 04/2018 TO 04/2019

ON

Parts required (Not included)

1X 1Amp Diode

MANDATORY INSTALL

*HOOD PIN



HOOD STATUS: THE HOOD PIN SWITCH MUST BE INSTALLED IF THE VEHICLE CAN BE REMOTE STARTED WITH THE HOOD OPEN, SET FUNCTION A11 TO OFF.

A11

Notice: the installation of safety elements are mandatory. The hood pin is an essential security element and must be installed.

THIS MODULE MUST BE INSTALLED BY A QUALIFIED TECHNICIAN. A WRONG CONNECTION CAN CAUSE PERMANENT DAMAGE TO THE VEHICLE.

DESCRIPTION



③ BCM Right side of the center console, passenger side.



②

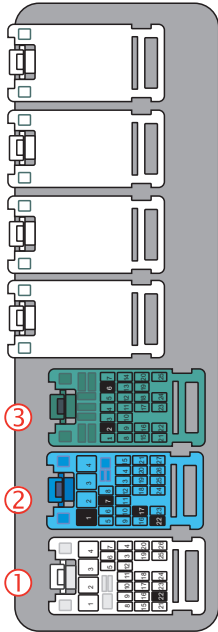
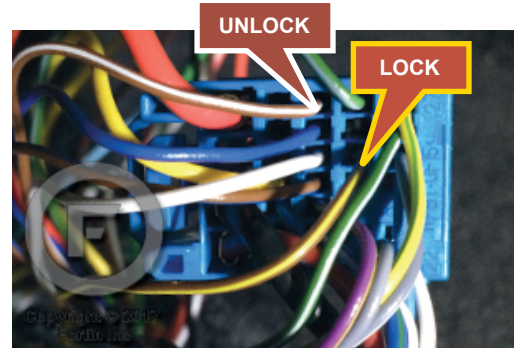
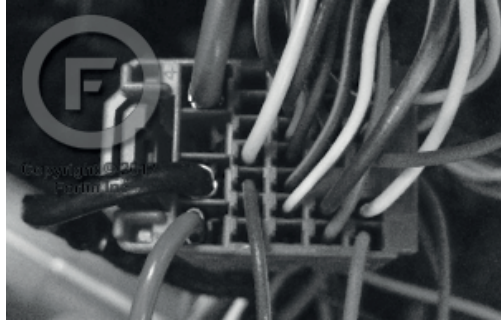

①



AUTOMATIC TRANSMISSION WIRING CONNECTION

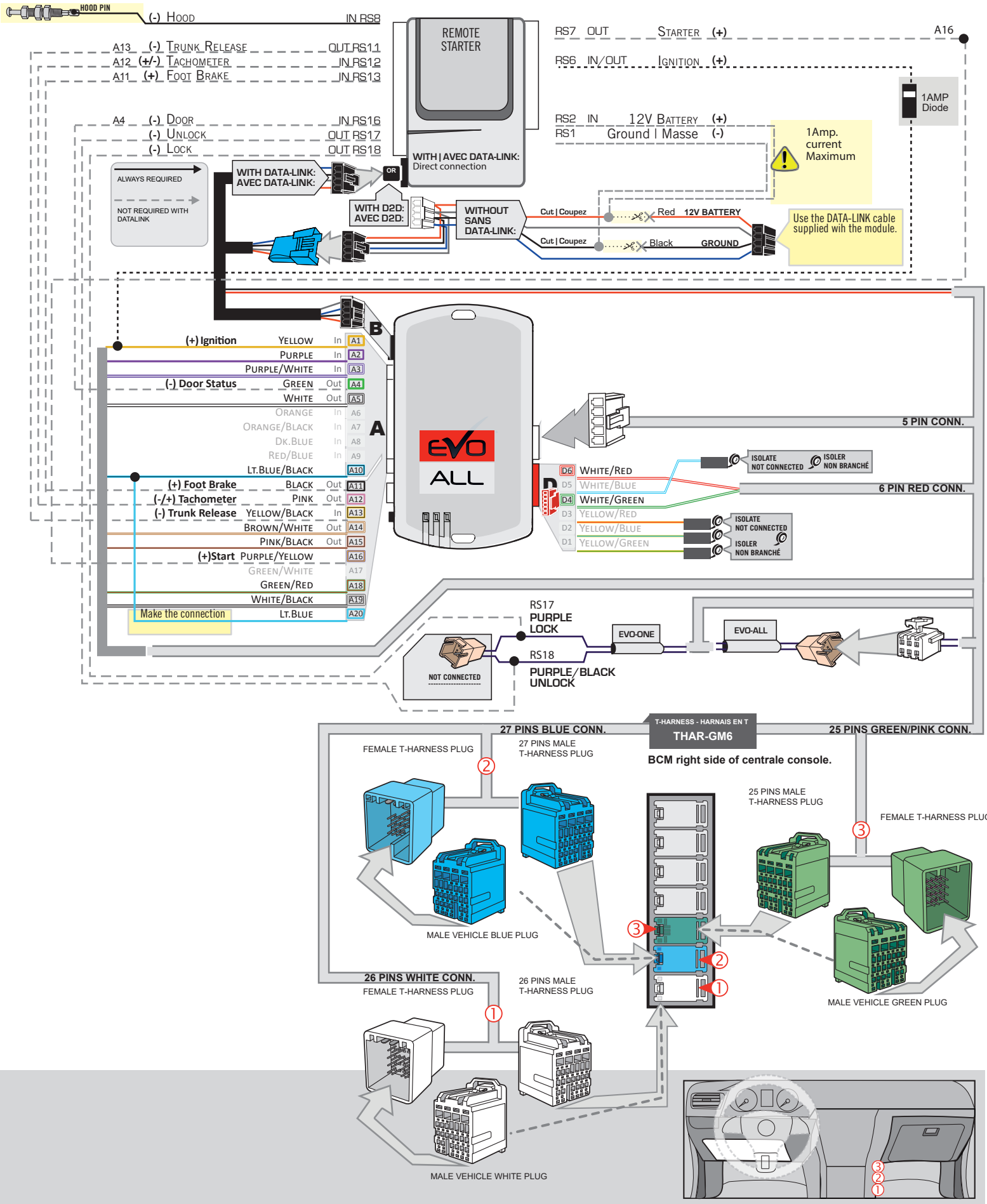

KEY BYPASS PROGRAMMING PROCEDURE 1/3

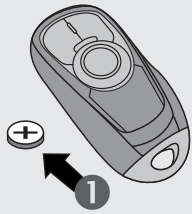

- 1 Remove the battery from the OEM remote.
- 2 Place the OEM in the remote Key reader behind cup holders in the center console.

Refer to vehicle user guide for keyport location.

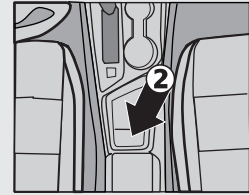

1

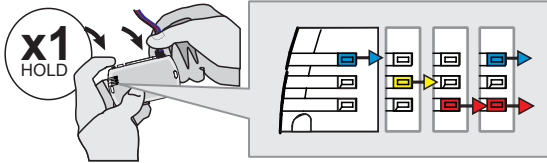

Press and hold the programming button:
Connect the 4-PIN Data-link harness (Black connector).

↳The Blue, Red, Yellow and Blue & Red LEDs will alternatively illuminate.

2

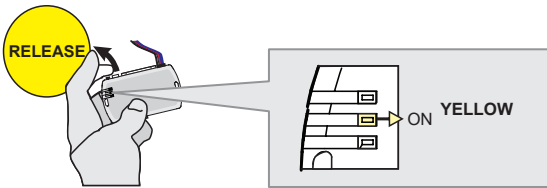

Release the programming button when the LED is YELLOW.

If the LED is not solid YELLOW disconnect the 4-Pin connector (Data-Link) and go back to step 1.

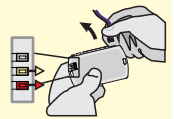

3

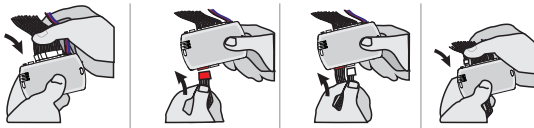

Insert the required remaining connectors.

4

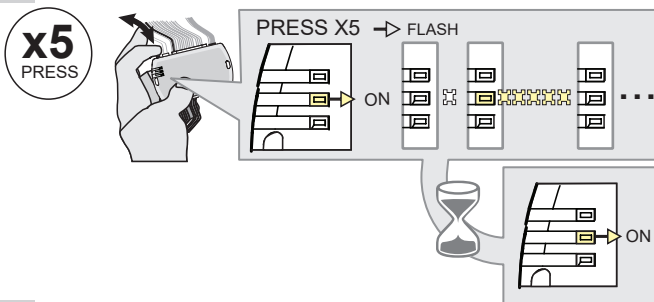

Press and release the programming button five (5x) times.

↳The YELLOW LED will flash 5 times each second.

↳WAIT for the YELLOW LED to turn ON solide.

5

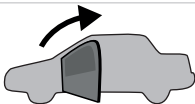

Open the driver door.

6

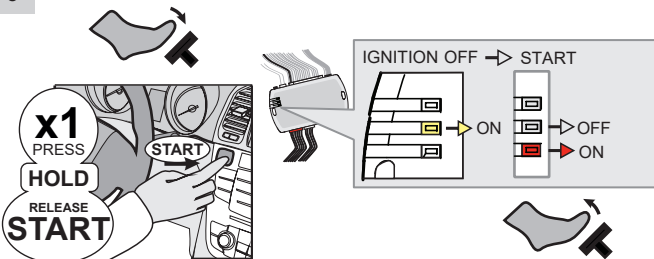

Press the foot-brake pedal.

Press the Push-to-Start button until the engine start.

Release the foot-brake pedal.

↳The RED LED will turn ON.
↳The YELLOW LED will turn OFF.

KEY BYPASS PROGRAMMING PROCEDURE 2/3 |

7



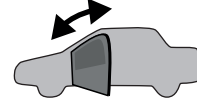

Press the Push-to-Start button until the engine turn OFF.

8

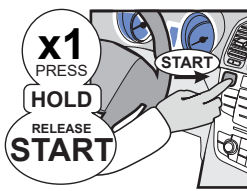
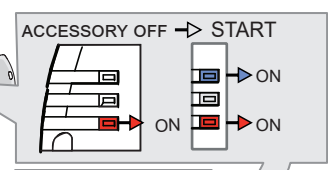
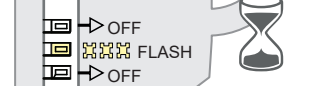

Close and open the driver door.

9

Press the foot-brake pedal.

Press the Push-to-Start button until the engine start.

Release the foot-brake pedal.

- ↳ The BLUE LED will turn ON.
- ↳ The BLUE LED will turn OFF. The RED LED will turn OFF.
- ↳ The YELLOW LED will flash rapidly
- ↳ The BLUE LED will turn ON.
- ↳ The BLUE LED will flash rapidly

10

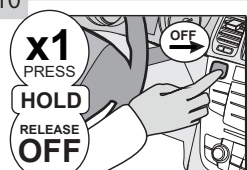
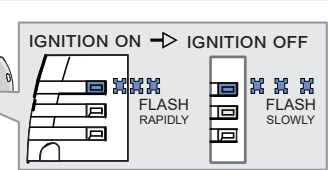
Press the Push-to-Start button until the engine turn OFF.

- ↳ The BLUE LED will flash slowly

11

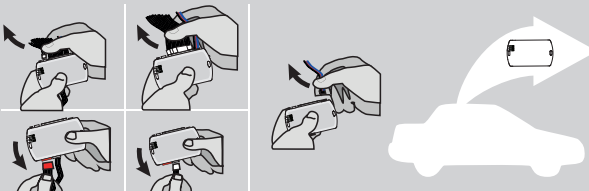

Disconnect all the connectors and after the Data-Link (4-pins) connector.

12

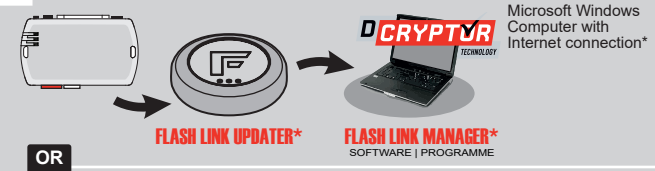

Microsoft Windows Computer with Internet connection*

FLASH LINK UPDATER* **FLASH LINK MANAGER***
SOFTWARE | PROGRAMME

OR

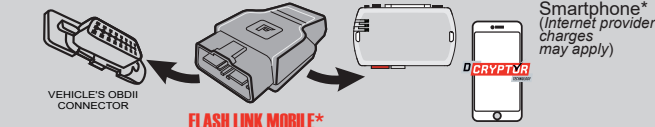

Smartphone* (Internet provider charges may apply)

FLASH LINK MOBILE*

Use the tool: FLASH LINK UPDATER or FLASH LINK MOBILE to visit the DCryptor menu.

*Parts required (not included)

13

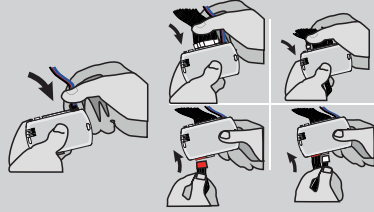
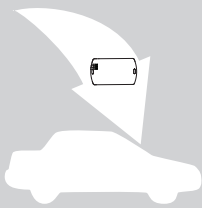

AFTER DCRYPTOR PROGRAMMING COMPLETED
Go back to the vehicle and **reconnect** the 4-Pin (Data-Link) connector and after, all the remaining connector.



The module is now programmed.



REMOTE STARTER / ALARM VERIFICATION PROCEDURE

Test the remote starter. Remote start the vehicle.

REMOTE STARTER FUNCTIONALITY |



All doors must be closed.

Remote start the vehicle.



Press the Unlock button of the remote car starter.

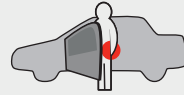

Enter the vehicle with the Intelligent Access Key.

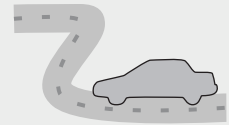

The vehicle can now be put in to gear and driven.





If the vehicle is not unlocked the module will shut down the remote-starter and the vehicle as soon as any door is opened.

THAR-GM6

THARNNESS INSTALLATION

ADDENDUM - SUGGESTED WIRING CONFIGURATION

VEHICLE	YEARS	Vehicle functions supported in this diagram (functional if equipped)													
		Immobilizer bypass	Lock	Unlock	Arm	Disarm	Trunk (open)	RAP Disable	Tachometer	Heated Seats	Door Status	Trunk Status (Data-Link Only, Data-Link Seulement)	Hand-Brake Status (Data-Link Only, Data-Link Seulement)	Foot-Brake Status	OEM Remote Monitoring
															
BUICK															
Encore	Push-To-Start	2017-2020	•	•	•	•	•	•	•	•	•	•	•	•	•
CHEVROLET															
Trax	Push-To-Start	2017-2021	•	•	•	•	•	•	•	•	•	•	•	•	•





FIRMWARE VERSION

70.[45]

GM MINIMUM

To add the firmware version and the options, use the **FLASH LINK UPDATER** or **FLASH LINK MOBILE** tool, sold separately.

	UNIT OPTION	DESCRIPTION
 <p>Program bypass option:</p>	C1	OEM Remote status (Lock/Unlock) monitoring
	A11	OFF
IF THE VEHICLE IS NOT EQUIPPED WITH FUNCTIONAL HOOD PIN:		
	D6	Push-to-Start



ATTENTION!



DATE: XX-XX

E5

OFF

ON

SPECIAL FUNCTIONS: BY DEFAULT DEACTIVATED

MANUFACTURED MODULES BETWEEN: 04/2018 TO 04/2019



Parts required (Not included)

1X 1Amp Diode

MANDATORY INSTALL

*HOOD PIN



HOOD STATUS: THE HOOD PIN SWITCH MUST BE INSTALLED IF THE VEHICLE CAN BE REMOTE STARTED WITH THE HOOD OPEN, SET FUNCTION A11 TO OFF.

A11

OFF

Notice: the installation of safety elements are mandatory. The hood pin is an essential security element and must be installed.

THIS MODULE MUST BE INSTALLED BY A QUALIFIED TECHNICIAN. A WRONG CONNECTION CAN CAUSE PERMANENT DAMAGE TO THE VEHICLE.

DESCRIPTION

BCM

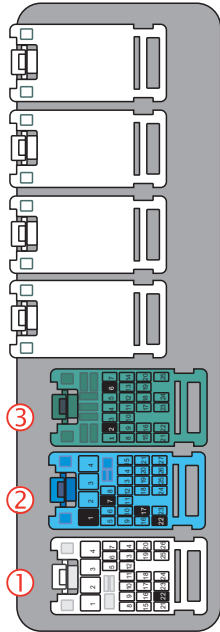
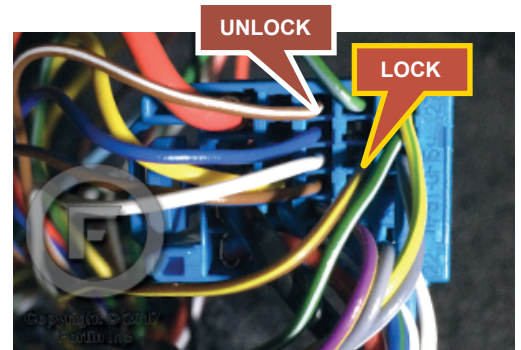
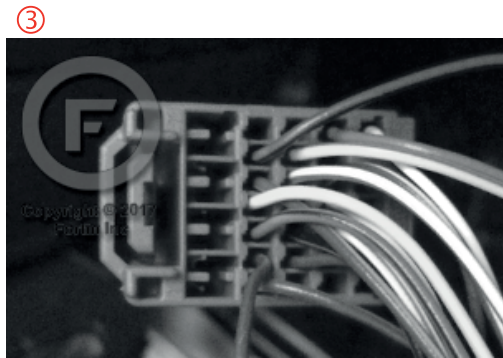

AUTOMATIC TRANSMISSION WIRING CONNECTION |

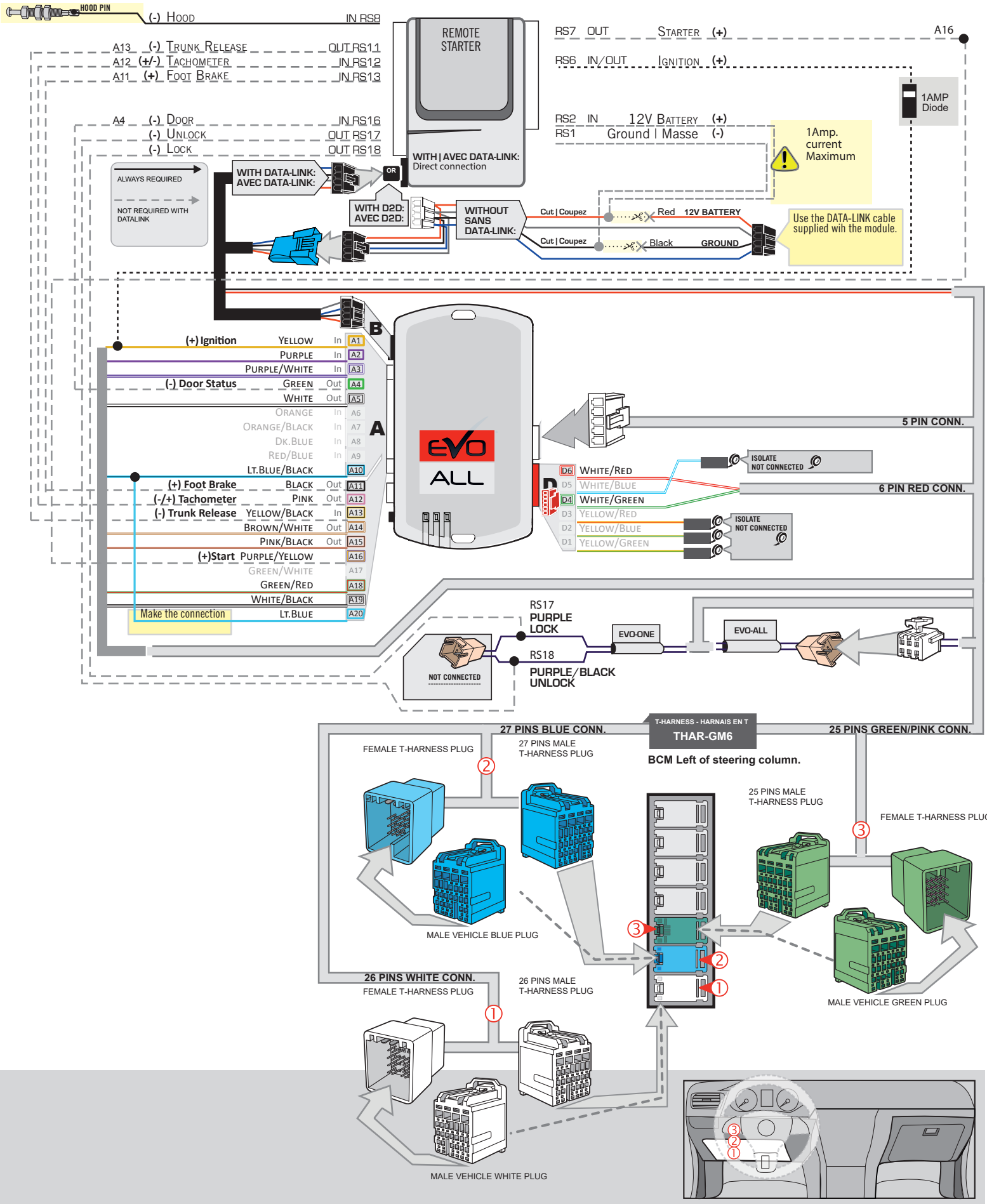

KEY BYPASS PROGRAMMING PROCEDURE 1/3

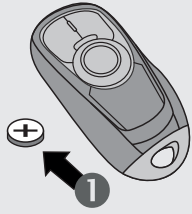

- 1** Remove the battery from the OEM remote.
- 2** Place the OEM remote in the front cup holder in the center console.
Refer to vehicle user guide for keyport location.

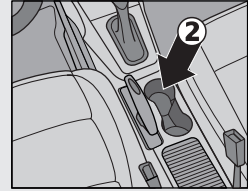

1

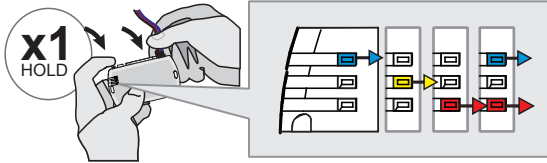

Press and hold the programming button:
Connect the 4-PIN Data-link harness (Black connector).

↳The Blue, Red, Yellow and Blue & Red LEDs will alternatively illuminate.

2

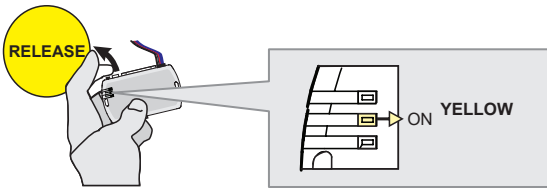

Release the programming button when the LED is YELLOW.

If the LED is not solid YELLOW disconnect the 4-Pin connector (Data-Link) and go back to step 1.

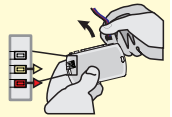

3

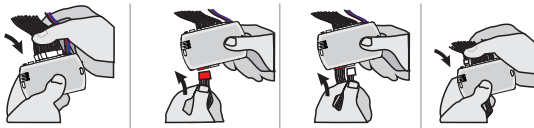

Insert the required remaining connectors.

4

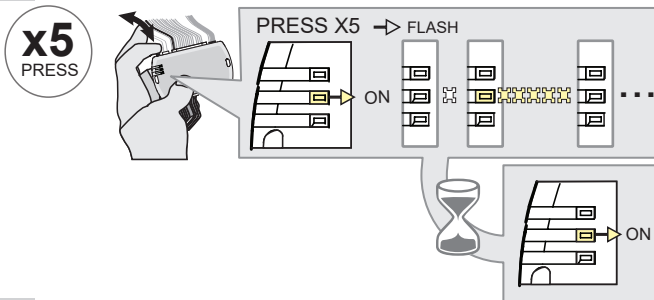

Press and release the programming button five (5x) times.

↳The YELLOW LED will flash 5 times each second.

↳**WAIT** for the YELLOW LED to turn ON solide.

5

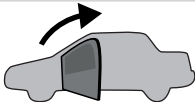

Open the driver door.

6

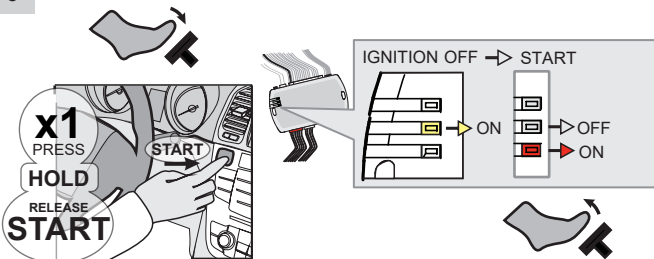

Press the foot-brake pedal.

Press the Push-to-Start button until the engine start.

Release the foot-brake pedal.

↳The RED LED will turn ON.
↳The YELLOW LED will turn OFF.

KEY BYPASS PROGRAMMING PROCEDURE 2/3

7



Press the Push-to-Start button until the engine turn OFF.

8

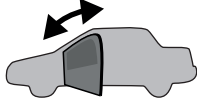

Close and open the driver door.

9

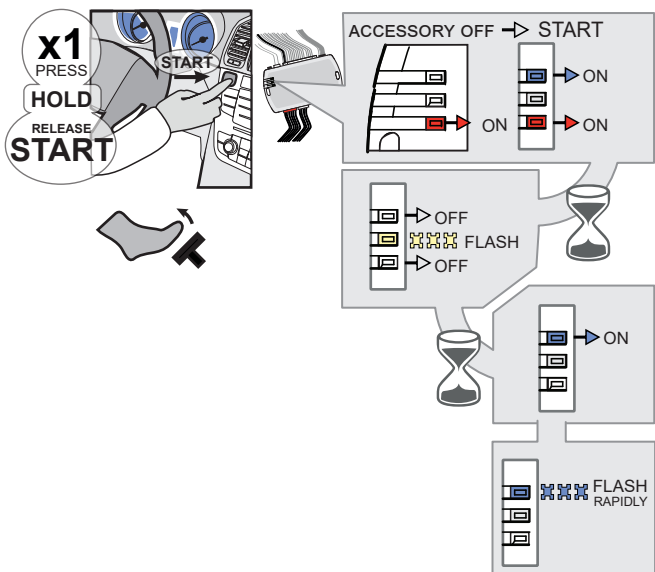

Press the foot-brake pedal.

Press the Push-to-Start button until the engine start.

Release the foot-brake pedal.

- ↳ The BLUE LED will turn ON.
- ↳ The BLUE LED will turn OFF. The RED LED will turn OFF.
- ↳ The YELLOW LED will flash rapidly
- ↳ The BLUE LED will turn ON.
- ↳ The BLUE LED will flash rapidly

10

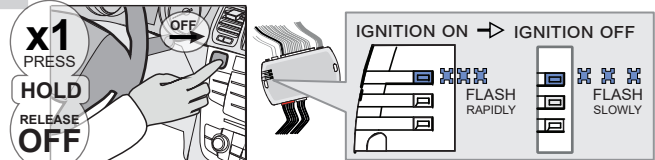

Press the Push-to-Start button until the engine turn OFF.

- ↳ The BLUE LED will flash slowly

11

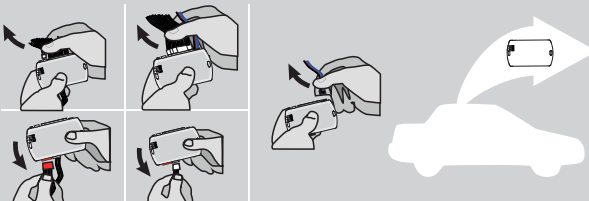

Disconnect all the connectors and after the Data-Link (4-pins) connector.

12

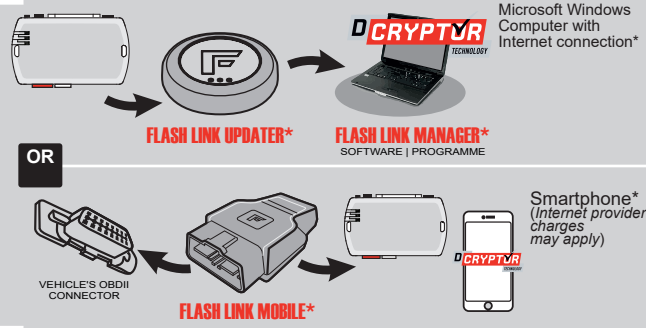

Use the tool: FLASH LINK UPDATER or FLASH LINK MOBILE to visit the DCRYPTOR menu.

*Parts required (not included)

KEY BYPASS PROGRAMMING PROCEDURE 3/3

13

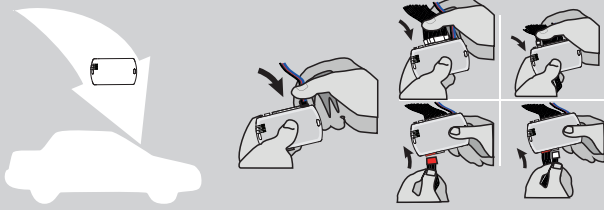

AFTER DCRYPTOR PROGRAMMING COMPLETED
Go back to the vehicle and **reconnect** the 4-Pin (Data-Link) connector and after, all the remaining connector.



The module is now programmed.



REMOTE STARTER / ALARM VERIFICATION PROCEDURE

Test the remote starter. Remote start the vehicle.

REMOTE STARTER FUNCTIONALITY



All doors must be closed.

Remote start the vehicle.



Press the Unlock button of the remote car starter.



Enter the vehicle with the Intelligent Access Key.



The vehicle can now be put in to gear and driven.



If the vehicle is not unlocked the module will shut down the remote-starter and the vehicle as soon as any door is opened.

THAR-GM6

THARNNESS INSTALLATION

ADDENDUM - SUGGESTED WIRING CONFIGURATION



Vehicle functions supported in this diagram (functional if equipped)

VEHICLE	YEARS	Immobilizer bypass	Lock	Unlock	Arm	Disarm	Trunk (open)	RAP Disable	Tachometer	Heated Seats	Door Status	Trunk Status (Data-Link Only, Data-Link Seulement)	Hand-Brake Status (Data-Link Only, Data-Link Seulement)	Foot-Brake Status	OEM Remote Monitoring
BUICK															
Envision	Push-To-Start	2017-2020	•	•	•	•	•	•	•	•	•	•	•	•	•

FIRMWARE VERSION

70.[41]

GM MINIMUM

To add the firmware version and the options, use the **FLASH LINK UPDATER** or **FLASH LINK MOBILE** tool, sold separately.

<p>IF THE VEHICLE IS NOT EQUIPPED WITH FUNCTIONAL HOOD PIN:</p>	A11	OFF	Hood trigger (Output Status).
--	------------	------------	-------------------------------

	UNIT OPTION	DESCRIPTION
<p>Program bypass option:</p>	C1	OEM Remote status (Lock/Unlock) monitoring
	D6	Push-to-Start

	ATTENTION!	<p>DATE: XX-XX</p>	E5	<p>OFF</p> <p>SPECIAL FUNCTIONS: BY DEFAULT DEACTIVATED</p> <p>ON</p> <p>MANUFACTURED MODULES BETWEEN: 04/2018 TO 04/2019</p>
--	-------------------	--------------------	-----------	---

Parts required (Not included)

1X 1Amp Diode

MANDATORY INSTALL

*HOOD PIN



HOOD STATUS: THE HOOD PIN SWITCH MUST BE INSTALLED IF THE VEHICLE CAN BE REMOTE STARTED WITH THE HOOD OPEN, SET FUNCTION A11 TO OFF.

A11

OFF

Notice: the installation of safety elements are mandatory. The hood pin is an essential security element and must be installed.

THIS MODULE MUST BE INSTALLED BY A QUALIFIED TECHNICIAN. A WRONG CONNECTION CAN CAUSE PERMANENT DAMAGE TO THE VEHICLE.

DESCRIPTION

BCM located on passenger side center console



③



②

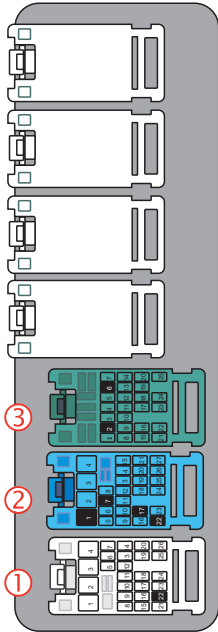
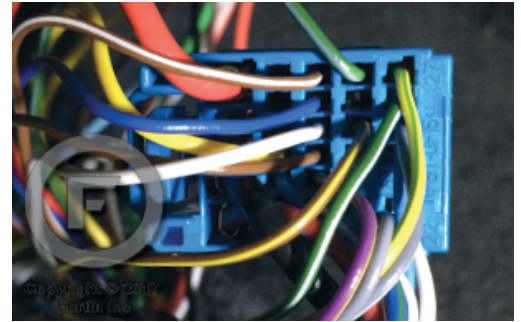
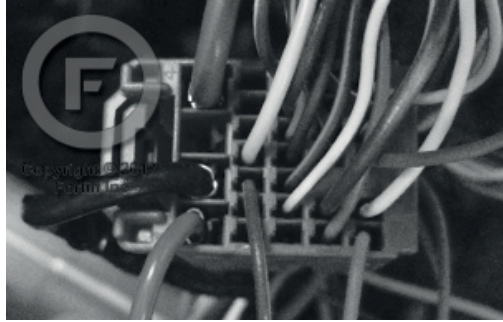

①



AUTOMATIC TRANSMISSION WIRING CONNECTION

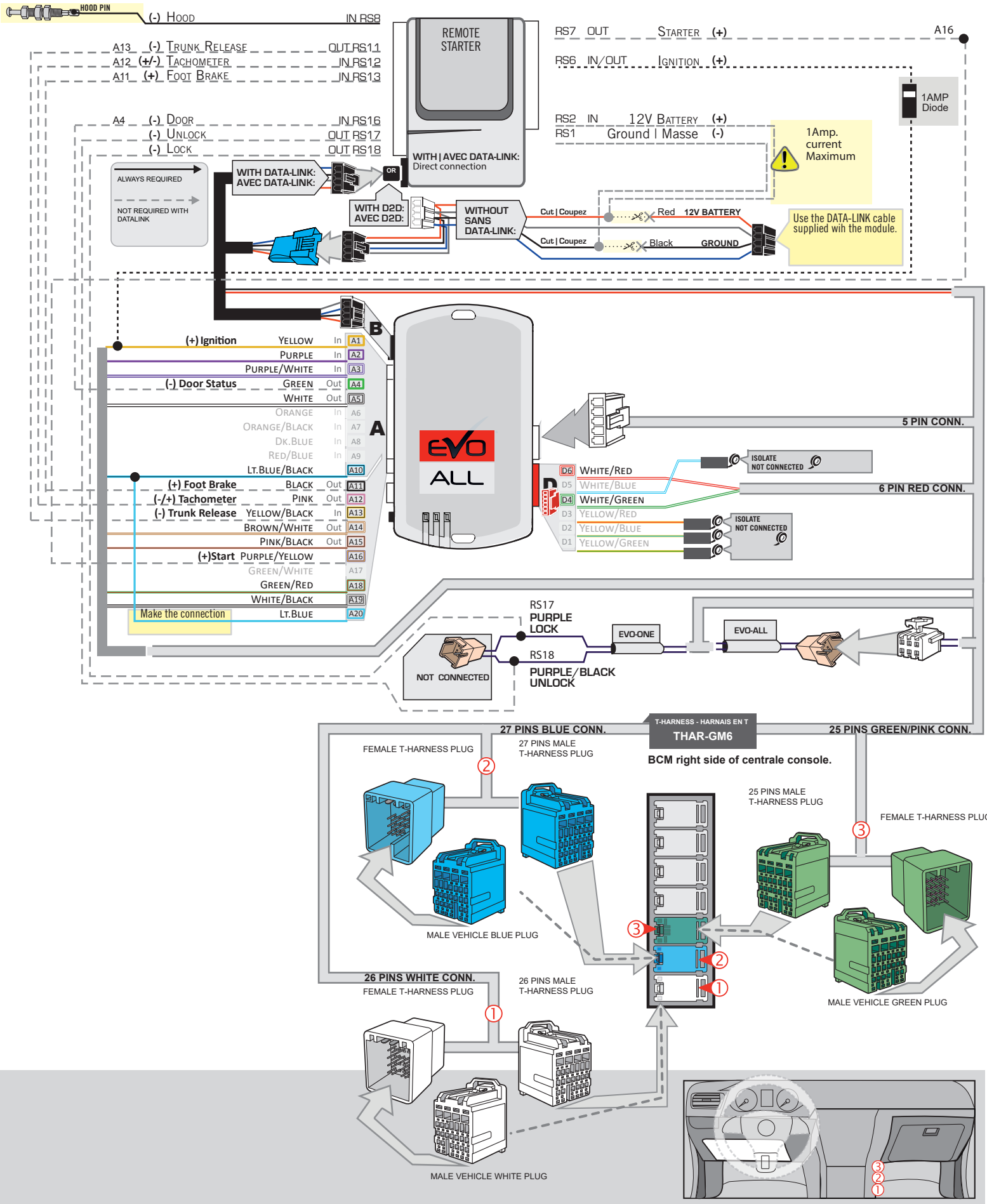

KEY BYPASS PROGRAMMING PROCEDURE 1/3

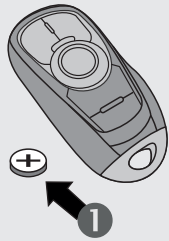

- 1** Remove the battery from the OEM remote.
- 2** Place the OEM remote in the front cup holder in the center console.
Refer to vehicle user guide for keyport location.

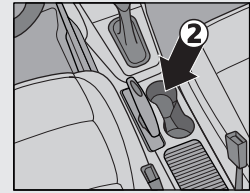

1

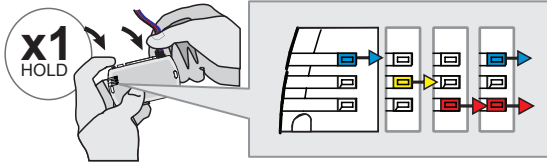

Press and hold the programming button:
Connect the 4-PIN Data-link harness (Black connector).

↳The Blue, Red, Yellow and Blue & Red LEDs will alternatively illuminate.

2

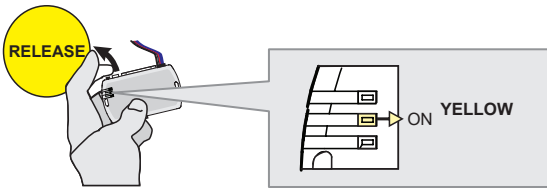

Release the programming button when the LED is YELLOW.

If the LED is not solid YELLOW disconnect the 4-Pin connector (Data-Link) and go back to step 1.

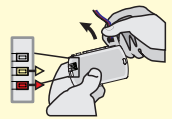

3

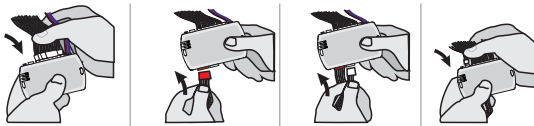

Insert the required remaining connectors.

4

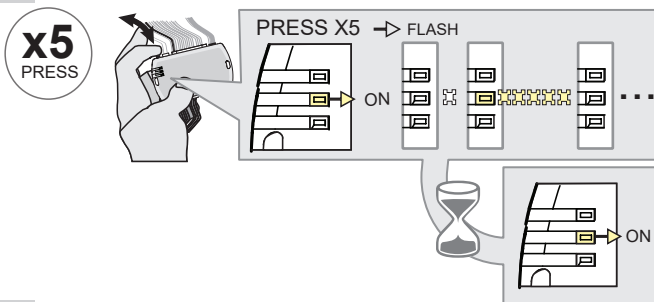

Press and release the programming button five (5x) times.

↳The YELLOW LED will flash 5 times each second.

↳**WAIT** for the YELLOW LED to turn ON solide.

5

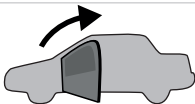

Open the driver door.

6

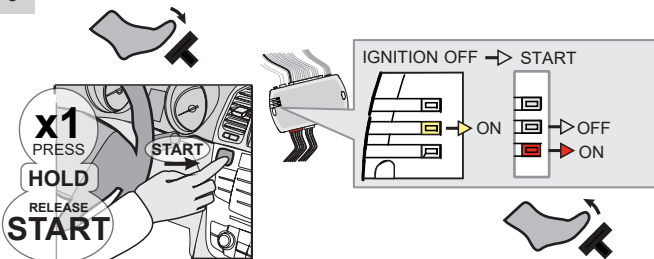

Press the foot-brake pedal.

Press the Push-to-Start button until the engine start.

Release the foot-brake pedal.

↳The RED LED will turn ON.
↳The YELLOW LED will turn OFF.

KEY BYPASS PROGRAMMING PROCEDURE 2/3

7



Press the Push-to-Start button until the engine turn OFF.

8

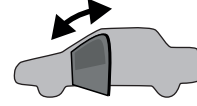

Close and open the driver door.

9

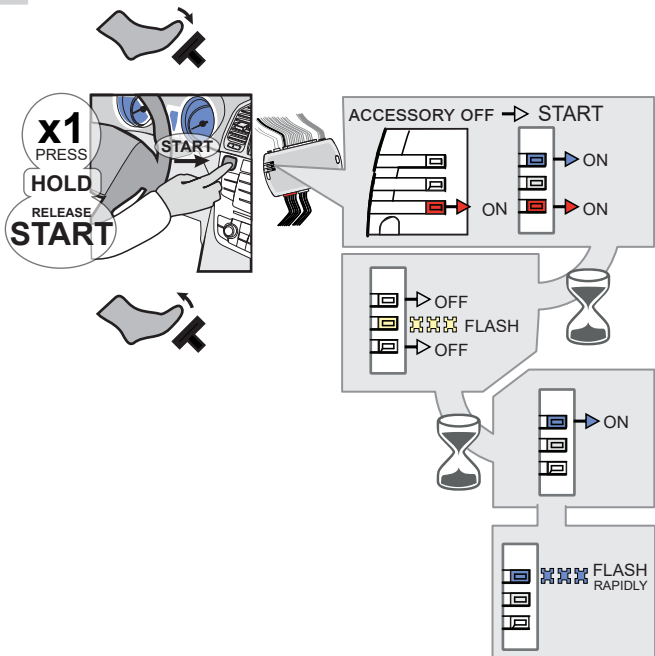

Press the foot-brake pedal.

Press the Push-to-Start button until the engine start.

Release the foot-brake pedal.

- ↳ The BLUE LED will turn ON.
- ↳ The BLUE LED will turn OFF. The RED LED will turn OFF.
- ↳ The YELLOW LED will flash rapidly
- ↳ The BLUE LED will turn ON.
- ↳ The BLUE LED will flash rapidly

10

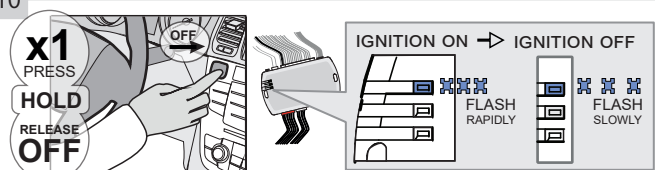

Press the Push-to-Start button until the engine turn OFF.

- ↳ The BLUE LED will flash slowly

11

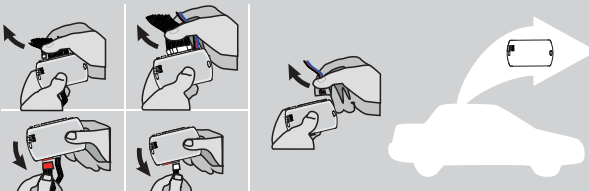

Disconnect all the connectors and after the Data-Link (4-pins) connector.

12

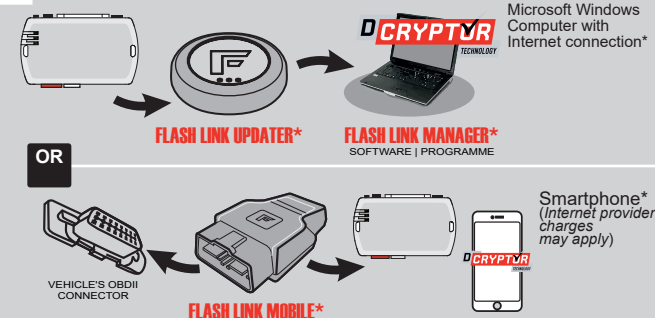

Use the tool: FLASH LINK UPDATER or FLASH LINK MOBILE to visit the DCRYPTOR menu.

*Parts required (not included)

KEY BYPASS PROGRAMMING PROCEDURE 3/3

13

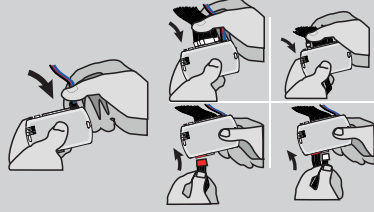
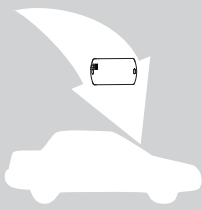

AFTER DCRYPTOR PROGRAMMING COMPLETED
Go back to the vehicle and **reconnect** the 4-Pin (Data-Link) connector and after, all the remaining connector.



The module is now programmed.



REMOTE STARTER / ALARM VERIFICATION PROCEDURE

Test the remote starter. Remote start the vehicle.

REMOTE STARTER FUNCTIONALITY



All doors must be closed.

Remote start the vehicle.



Press the Unlock button of the remote car starter.



Enter the vehicle with the Intelligent Access Key.



The vehicle can now be put in to gear and driven.



If the vehicle is not unlocked the module will shut down the remote-starter and the vehicle as soon as any door is opened.

THAR-GM6

THARNNESS INSTALLATION

ADDENDUM - SUGGESTED WIRING CONFIGURATION

VEHICLE	YEARS	Vehicle functions supported in this diagram (functional if equipped)														
		Immobilizer bypass	Lock	Unlock	Arm	Disarm	Trunk (open)	Parking Light	RAP Disable	Tachometer	Heated Seats	Door Status	Trunk Status (Data-Link Only, Data-Link Seulement)	Hand-Brake Status (Data-Link Only, Data-Link Seulement)	Foot-Brake Status	OEM Remote Monitoring
CHEVROLET																
Equinox	Push-To-Start	2018-2020	•	•	•	•	•	•	•	•	•	•	•	•	•	•



FIRMWARE VERSION

To add the firmware version and the options, use the **FLASH LINK UPDATER** or **FLASH LINK MOBILE** tool, sold separately.

70.[45]

GM MINIMUM

UNIT OPTION	DESCRIPTION
C1	OEM Remote status (Lock/Unlock) monitoring
A11	<p>IF THE VEHICLE IS NOT EQUIPPED WITH FUNCTIONAL HOOD PIN:</p> <p>OFF NON</p> <p>Hood trigger (Output Status).</p>
D6	Push-to-Start

ATTENTION!

DATE: XX-XX

E5

OFF NON

ON OUI

SPECIAL FUNCTIONS: BY DEFAULT DEACTIVATED

MANUFACTURED MODULES BETWEEN: 04/2018 TO 04/2019

Parts required (Not included)

1X 1Amp Diode

MANDATORY INSTALL

*HOOD PIN

HOOD STATUS: THE HOOD PIN SWITCH MUST BE INSTALLED IF THE VEHICLE CAN BE REMOTE STARTED WITH THE HOOD OPEN, SET FUNCTION A11 TO OFF.

A11 OFF

Notice: the installation of safety elements are mandatory. The hood pin is an essential security element and must be installed.

THIS MODULE MUST BE INSTALLED BY A QUALIFIED TECHNICIAN. A WRONG CONNECTION CAN CAUSE PERMANENT DAMAGE TO THE VEHICLE.

DESCRIPTION

BCM



Centrale console

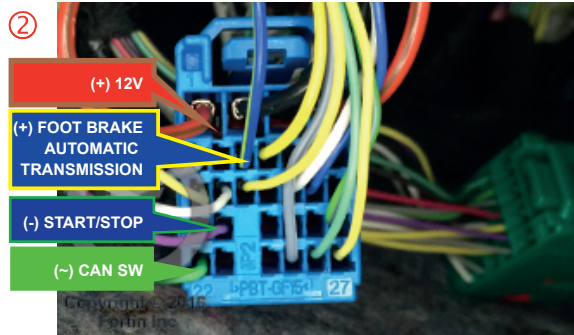
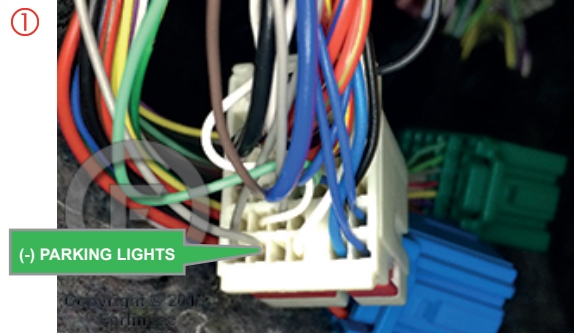

(-) PARKING LIGHTS

- (+) 12V
- (+) FOOT BRAKE AUTOMATIC TRANSMISSION
- (-) START/STOP
- (-) CAN SW

(-) IMMO DATA

(+) IGNITION

AUTOMATIC TRANSMISSION WIRING CONNECTION

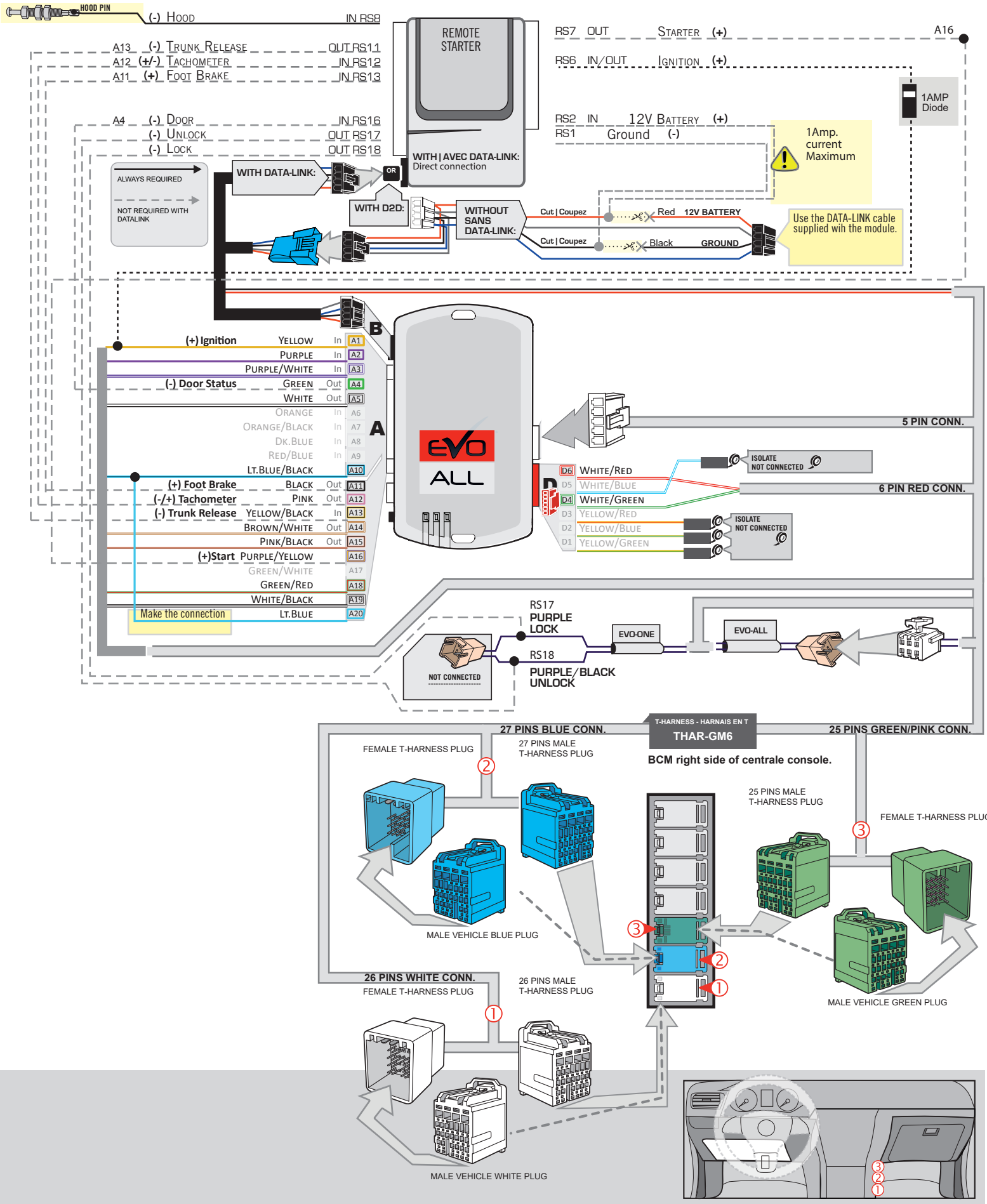

KEY BYPASS PROGRAMMING PROCEDURE 1/3

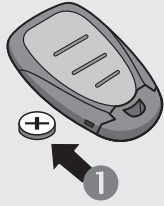

- 1** Remove the battery from the OEM remote.
- 2** Place the OEM remote in the front cup holder in the center console.
Refer to vehicle user guide for keyport location.

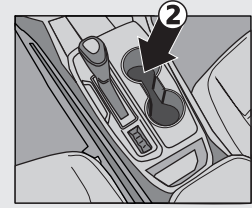

1

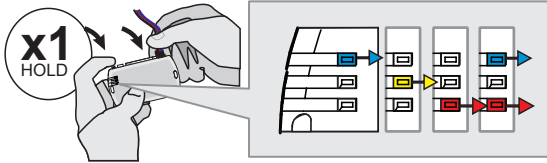

Press and hold the programming button:
Connect the 4-PIN Data-link harness (Black connector).

↳The Blue, Red, Yellow and Blue & Red LEDs will alternatively illuminate.

2

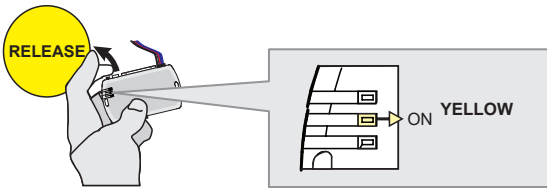

Release the programming button when the LED is YELLOW.

If the LED is not solid YELLOW disconnect the 4-Pin connector (Data-Link) and go back to step 1.

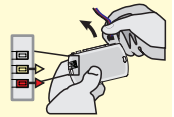

3

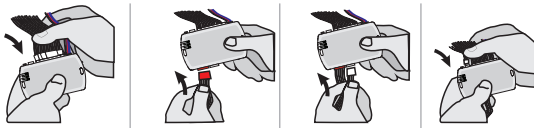

Insert the required remaining connectors.

4

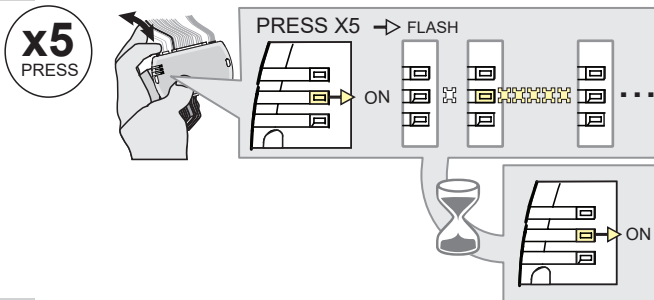

Press and release the programming button five (5x) times.

↳The YELLOW LED will flash 5 times each second.

↳**WAIT** for the YELLOW LED to turn ON solide.

5

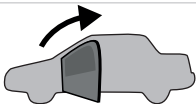

Open the driver door.

6

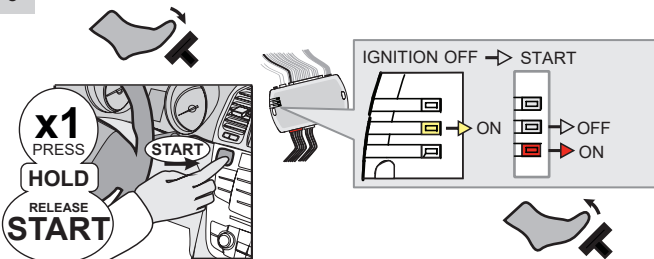

Press the foot-brake pedal.

Press the Push-to-Start button until the engine start.

Release the foot-brake pedal.

↳The RED LED will turn ON.
↳The YELLOW LED will turn OFF.

KEY BYPASS PROGRAMMING PROCEDURE 2/3 |

7



Press the Push-to-Start button until the engine turn OFF.

8

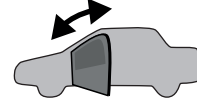

Close and open the driver door.

9

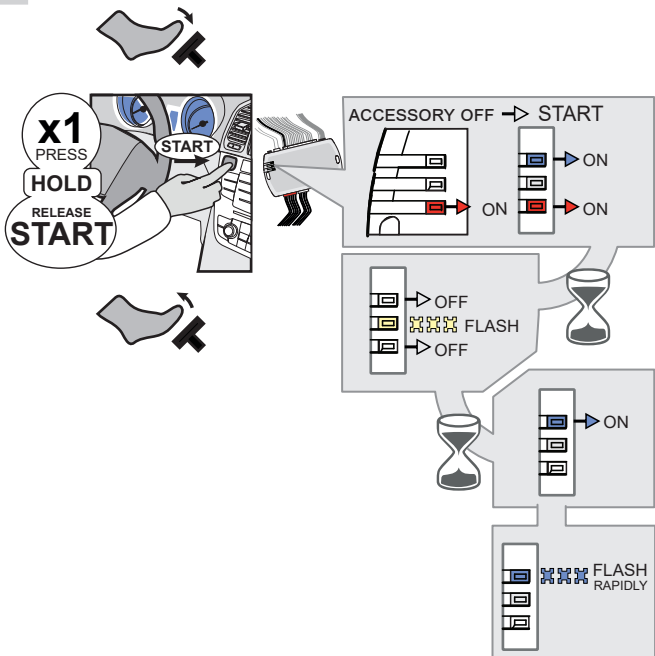

Press the foot-brake pedal.

Press the Push-to-Start button until the engine start.

Release the foot-brake pedal.

- ↳ The BLUE LED will turn ON.
- ↳ The BLUE LED will turn OFF. The RED LED will turn OFF.
- ↳ The YELLOW LED will flash rapidly
- ↳ The BLUE LED will turn ON.
- ↳ The BLUE LED will flash rapidly

10

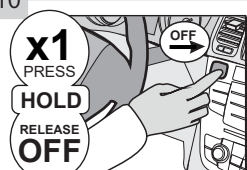

Press the Push-to-Start button until the engine turn OFF.

- ↳ The BLUE LED will flash slowly

11

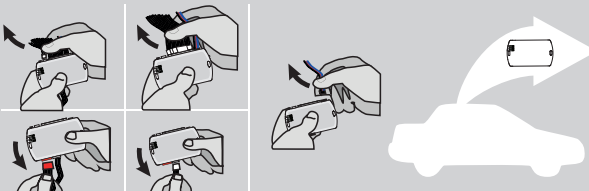

Disconnect all the connectors and after the Data-Link (4-pins) connector.

12

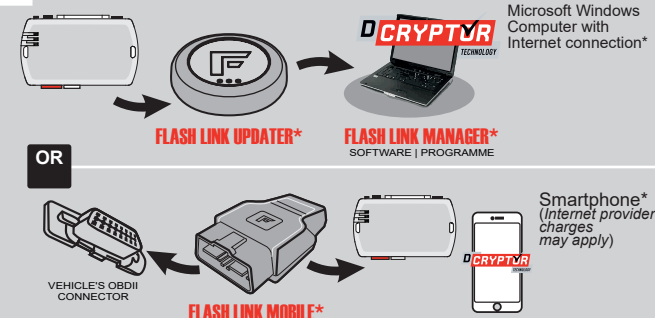

Use the tool: FLASH LINK UPDATER or FLASH LINK MOBILE to visit the DCRYPTOR menu.

***Parts required (not included)**

13

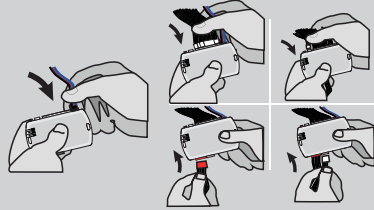
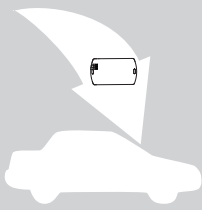

AFTER DCRYPTOR PROGRAMMING COMPLETED
Go back to the vehicle and **reconnect** the 4-Pin (Data-Link) connector and after, all the remaining connector.



The module is now programmed.



REMOTE STARTER / ALARM VERIFICATION PROCEDURE

Test the remote starter. Remote start the vehicle.

REMOTE STARTER FUNCTIONALITY |



All doors must be closed.

Remote start the vehicle.



Press the Unlock button of the remote car starter.



Enter the vehicle with the Intelligent Access Key.

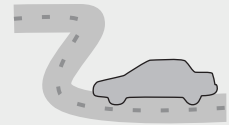

The vehicle can now be put in to gear and driven.



If the vehicle is not unlocked the module will shut down the remote-starter and the vehicle as soon as any door is opened.

THAR-GM6

THARNNESS INSTALLATION

ADDENDUM - SUGGESTED WIRING CONFIGURATION



Vehicle functions supported in this diagram (functional if equipped)

VEHICLE	YEARS	Immobilizer bypass	Lock	Unlock	Arm	Disarm	Trunk (open)	RAP Disable	Tachometer	Heated Seats	Door Status	Trunk Status (Data-Link Only,Data-Link Seulement)	Hand-Brake Status (Data-Link Only,Data-Link Seulement)	Foot-Brake Status	OEM Remote Monitoring
BUICK Lacrosse	Push-To-Start 2017-2018	•	•	•	•	•	•	•	•	•	•	•	•	•	•

FIRMWARE VERSION

70.[41]

GM MINIMUM

To add the firmware version and the options, use the **FLASH LINK UPDATER** or **FLASH LINK MOBILE** tool, sold separately.

<p>IF THE VEHICLE IS NOT EQUIPPED WITH FUNCTIONAL HOOD PIN:</p>	A11	OFF	<p>Hood trigger (Output Status).</p> <p>Contact de capot (état de sortie).</p>
--	------------	------------	--

	Program bypass option:	UNIT OPTION	DESCRIPTION
		C1	OEM Remote status (Lock/Unlock) monitoring
		D6	Push-to-Start

	ATTENTION!	<p>DATE: XX-XX</p>	<table border="1" style="width: 100%; border-collapse: collapse;"> <tr> <td style="width: 10%; text-align: center; font-size: 24px; color: red;">E5</td> <td style="width: 10%; text-align: center; background-color: red; color: white; padding: 5px;">OFF</td> <td style="width: 80%;"> <p>SPECIAL FUNCTIONS: BY DEFAULT DEACTIVATED</p> </td> </tr> <tr> <td></td> <td style="text-align: center; background-color: green; color: white; padding: 5px;">ON</td> <td> <p>MANUFACTURED MODULES BETWEEN: 04/2018 TO 04/2019</p> </td> </tr> </table>	E5	OFF	<p>SPECIAL FUNCTIONS: BY DEFAULT DEACTIVATED</p>		ON	<p>MANUFACTURED MODULES BETWEEN: 04/2018 TO 04/2019</p>
E5	OFF	<p>SPECIAL FUNCTIONS: BY DEFAULT DEACTIVATED</p>							
	ON	<p>MANUFACTURED MODULES BETWEEN: 04/2018 TO 04/2019</p>							

Parts required (Not included)

1X 1Amp Diode

MANDATORY INSTALL

*HOOD PIN



HOOD STATUS: THE HOOD PIN SWITCH MUST BE INSTALLED IF THE VEHICLE CAN BE REMOTE STARTED WITH THE HOOD OPEN, SET FUNCTION A11 TO OFF.

A11	OFF
------------	------------

Notice: the installation of safety elements are mandatory. The hood pin is an essential security element and must be installed.

THIS MODULE MUST BE INSTALLED BY A QUALIFIED TECHNICIAN. A WRONG CONNECTION CAN CAUSE PERMANENT DAMAGE TO THE VEHICLE.

DESCRIPTION

BCM located on passenger side center console

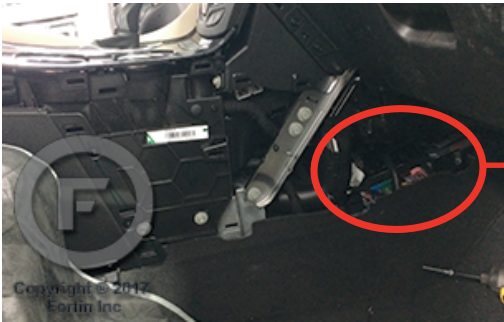

③



②



①

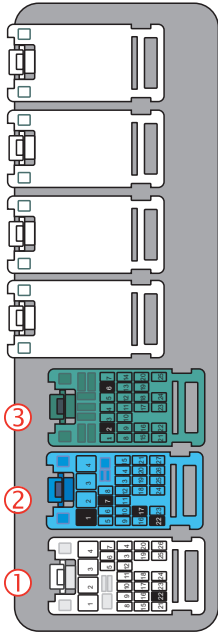

AUTOMATIC TRANSMISSION WIRING CONNECTION

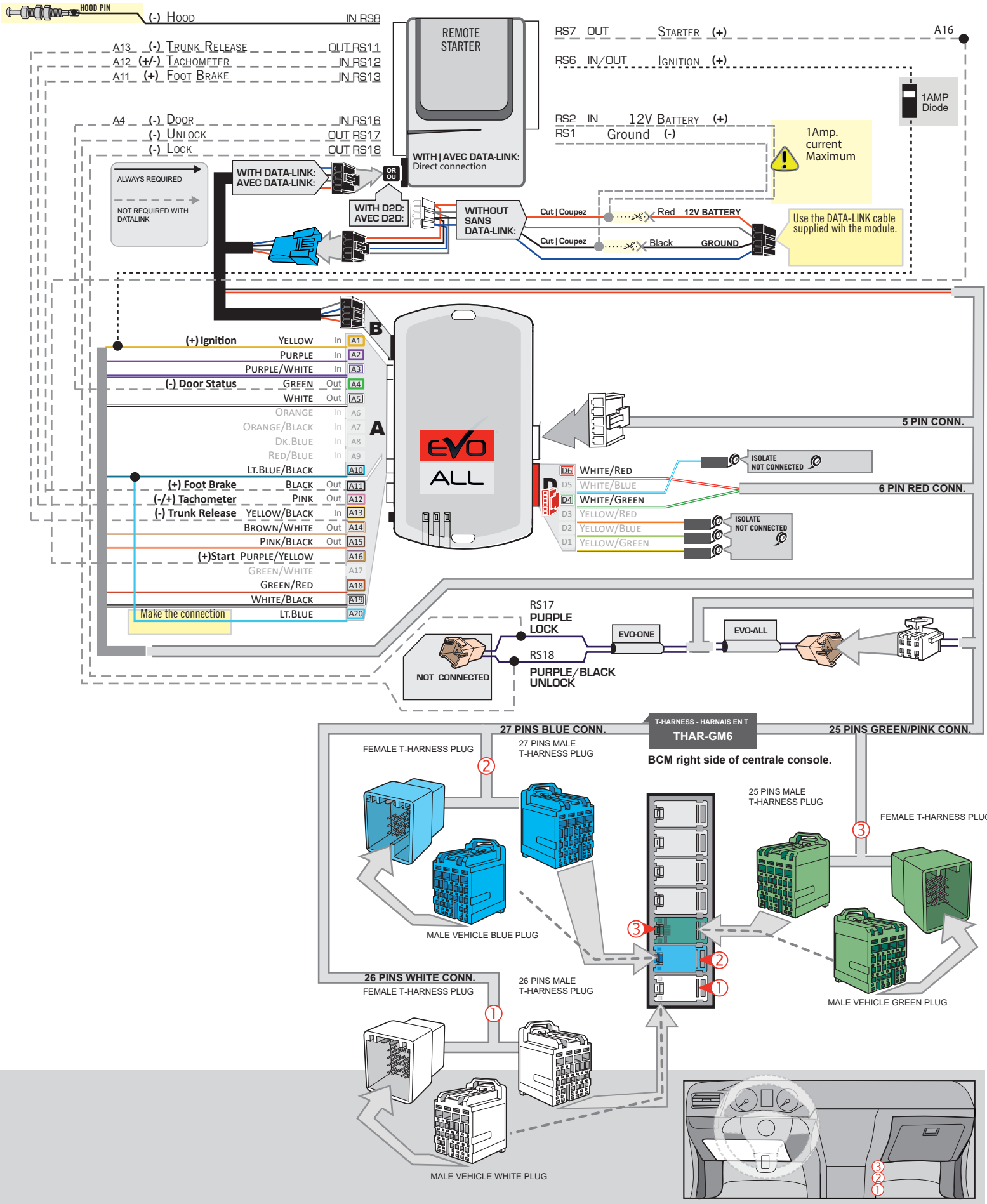

KEY BYPASS PROGRAMMING PROCEDURE 1/3

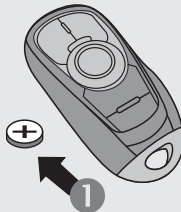

1 Remove the battery from the OEM remote.

2 Place the OEM remote into the transmitter pocket of the center console.

Refer to vehicle user guide for keyport location.

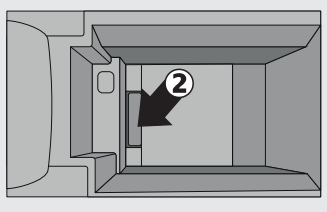

1

x1 HOLD

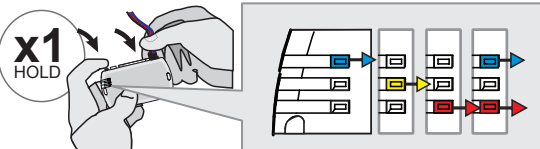

Press and hold the programming button:
Connect the 4-PIN Data-link harness (Black connector).

↳The Blue, Red, Yellow and Blue & Red LEDs will alternatively illuminate.

2

RELEASE

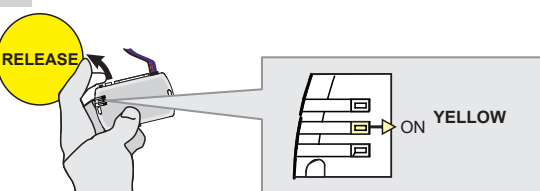

Release the programming button when the LED is **YELLOW**.

If the LED is not solid YELLOW disconnect the 4-Pin connector (Data-Link) and go back to step 1.

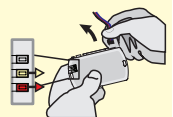

3

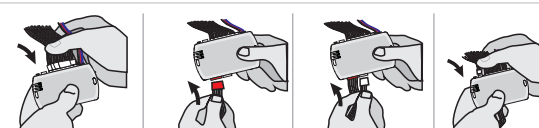

Insert the required remaining connectors.

4

x5 PRESS

PRESS X5 → FLASH

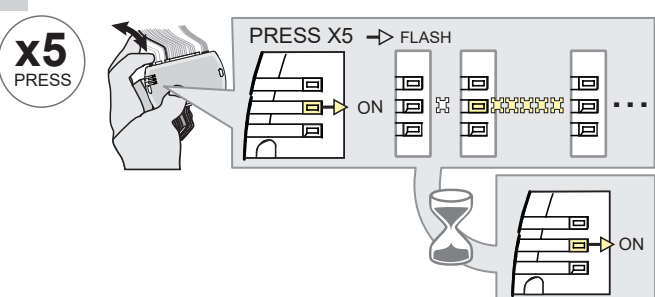

Press and release the programming button five (5x) times.

↳The **YELLOW LED** will flash 5 times each second.

↳**WAIT** for the **YELLOW LED** to turn **ON** solide.

5

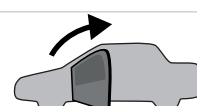

Open the driver door.

6

x1 PRESS

HOLD

RELEASE

START

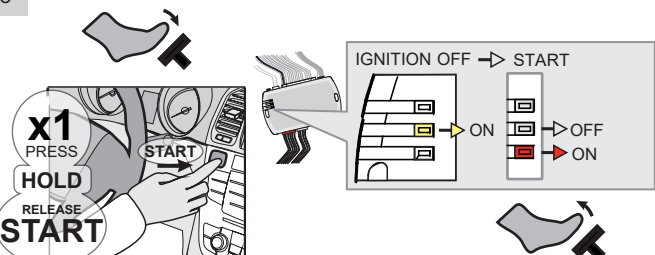

Press the foot-brake pedal.

Press the Push-to-Start button until the engine start.

Release the foot-brake pedal.

↳The **RED LED** will turn **ON**.
 ↳The **YELLOW LED** will turn **OFF**.

KEY BYPASS PROGRAMMING PROCEDURE 2/3

7



Press the Push-to-Start button until the engine turn OFF.

8

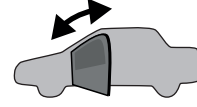

Close and open the driver door.

9

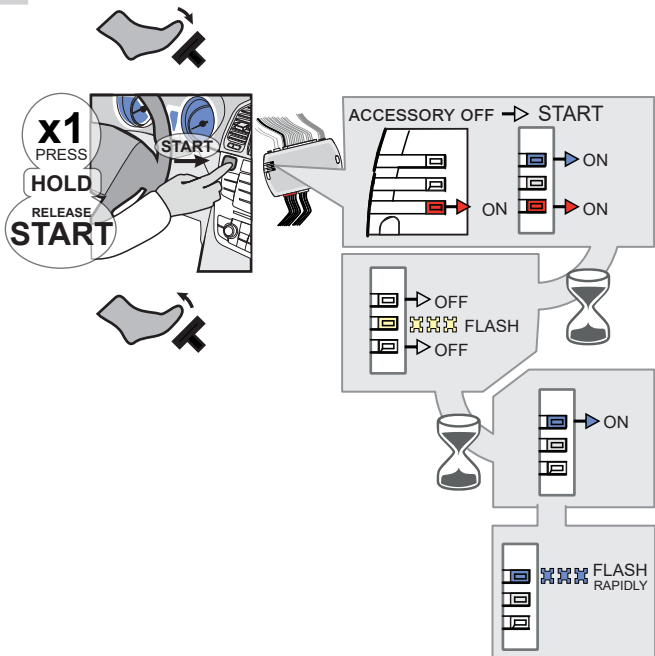

Press the foot-brake pedal.

Press the Push-to-Start button until the engine start.

Release the foot-brake pedal.

- ↳ The BLUE LED will turn ON.
- ↳ The BLUE LED will turn OFF. The RED LED will turn OFF.
- ↳ The YELLOW LED will flash rapidly
- ↳ The BLUE LED will turn ON.
- ↳ The BLUE LED will flash rapidly

10

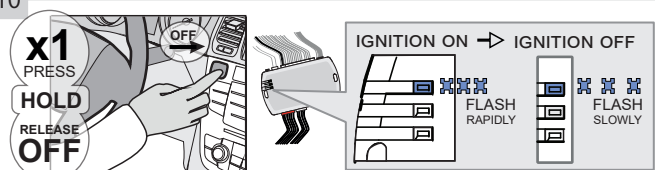

Press the Push-to-Start button until the engine turn OFF.

- ↳ The BLUE LED will flash slowly

11

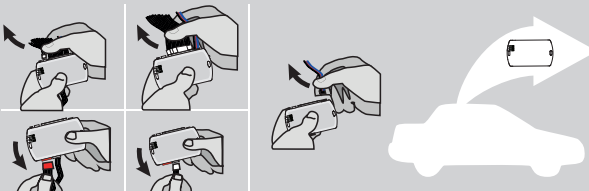

Disconnect all the connectors and after the Data-Link (4-pins) connector.

12

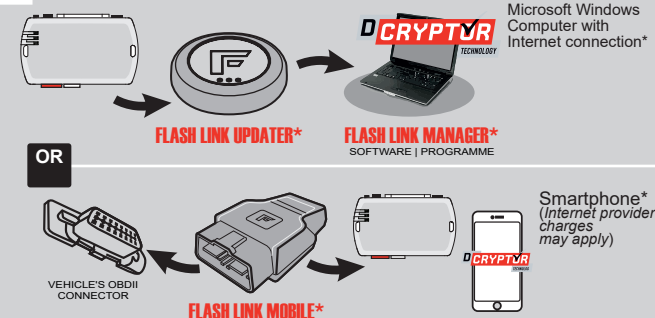

Use the tool: FLASH LINK UPDATER or FLASH LINK MOBILE to visit the DCRYPTOR menu.

*Parts required (not included)

KEY BYPASS PROGRAMMING PROCEDURE 3/3

13

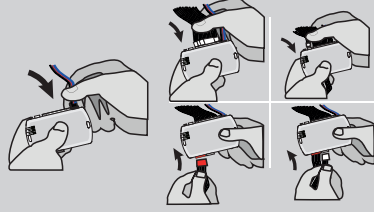
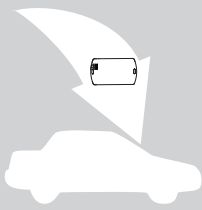

AFTER DCRYPTOR PROGRAMMING COMPLETED
Go back to the vehicle and **reconnect** the 4-Pin (Data-Link) connector and after, all the remaining connector.



The module is now programmed.



REMOTE STARTER / ALARM VERIFICATION PROCEDURE

Test the remote starter. Remote start the vehicle.

REMOTE STARTER FUNCTIONALITY



All doors must be closed.

Remote start the vehicle.



Press the Unlock button of the remote car starter.



Enter the vehicle with the Intelligent Access Key.



The vehicle can now be put in to gear and driven.



If the vehicle is not unlocked the module will shut down the remote-starter and the vehicle as soon as any door is opened.

THAR-GM6
THARNNESS INSTALLATION

ADDENDUM - SUGGESTED WIRING CONFIGURATION

VEHICLE	YEARS	Vehicle functions supported in this diagram (functional if equipped)															
		Immobilizer bypass	Lock	Unlock	Arm	Disarm	Trunk (open)	Parking Light	RAP Disable	Tachometer	Heated Seats	Door Status	Trunk Status (Data-Link Only, Data-Link Seulement)	Hand-Brake Status (Data-Link Only, Data-Link Seulement)	Foot-Brake Status	OEM Remote Monitoring	
BUICK																	
Verano	Push-To-Start	2012-2017	•	•	•	•	•	•	•	•	•	•	•	•	•	•	•
CHEVROLET																	
Blazer	Push-To-Start	2019-2020	•	•	•	•	•	•	•	•	•	•	•	•	•	•	•
Malibu	Push-To-Start	2016-2020	•	•	•	•	•	•	•	•	•	•	•	•	•	•	•
Traverse	Push-To-Start	2018-2020	•	•	•	•	•	•	•	•	•	•	•	•	•	•	•
GMC																	
Terrain	Push-To-Start	2018-2020	•	•	•	•	•	•	•	•	•	•	•	•	•	•	•

FIRMWARE VERSION

70.[41]

GM MINIMUM

To add the firmware version and the options, use the **FLASH LINK UPDATER** or **FLASH LINK MOBILE** tool, sold separately.

IF THE VEHICLE IS NOT EQUIPPED WITH FUNCTIONAL HOOD PIN:	A11	OFF	Hood trigger (Output Status).
--	-----	-----	-------------------------------

	Program bypass option:	UNIT OPTION	DESCRIPTION
		C1	OEM Remote status (Lock/Unlock) monitoring
		D6	Push-to-Start

	ATTENTION!	<p>DATE: XX-XX</p>	E5	OFF	SPECIAL FUNCTIONS: BY DEFAULT DEACTIVATED
				ON	MANUFACTURED MODULES BETWEEN: 04/2018 TO 04/2019

Parts required (Not included)

1X 1Amp Diode

MANDATORY INSTALL	*HOOD PIN	HOOD STATUS: THE HOOD PIN SWITCH MUST BE INSTALLED IF THE VEHICLE CAN BE REMOTE STARTED WITH THE HOOD OPEN, SET FUNCTION A11 TO OFF.		
	<table border="1" style="width: 100px; margin: auto;"> <tr> <td style="width: 50%; text-align: center; font-size: 24px; font-weight: bold;">A11</td> <td style="width: 50%; text-align: center; background-color: red; color: white; font-weight: bold;">OFF</td> </tr> </table>	A11	OFF	Notice: the installation of safety elements are mandatory. The hood pin is an essential security element and must be installed.
A11	OFF			
		THIS MODULE MUST BE INSTALLED BY A QUALIFIED TECHNICIAN. A WRONG CONNECTION CAN CAUSE PERMANENT DAMAGE TO THE VEHICLE.		

DESCRIPTION

BCM



Centrale console

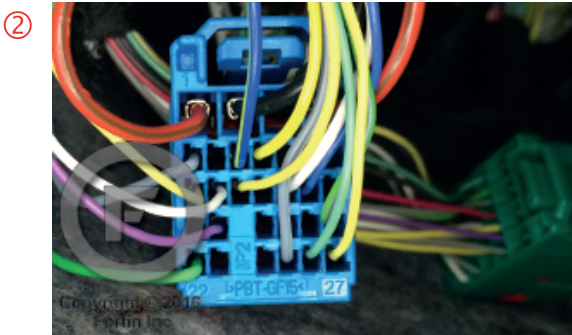
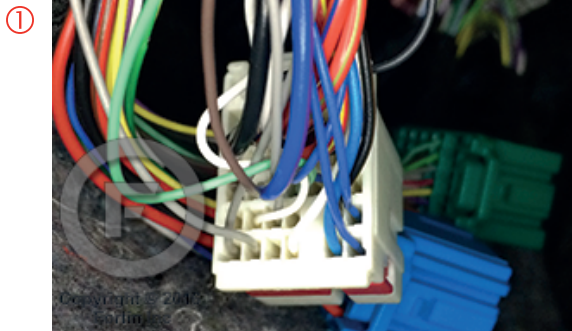

AUTOMATIC TRANSMISSION WIRING CONNECTION

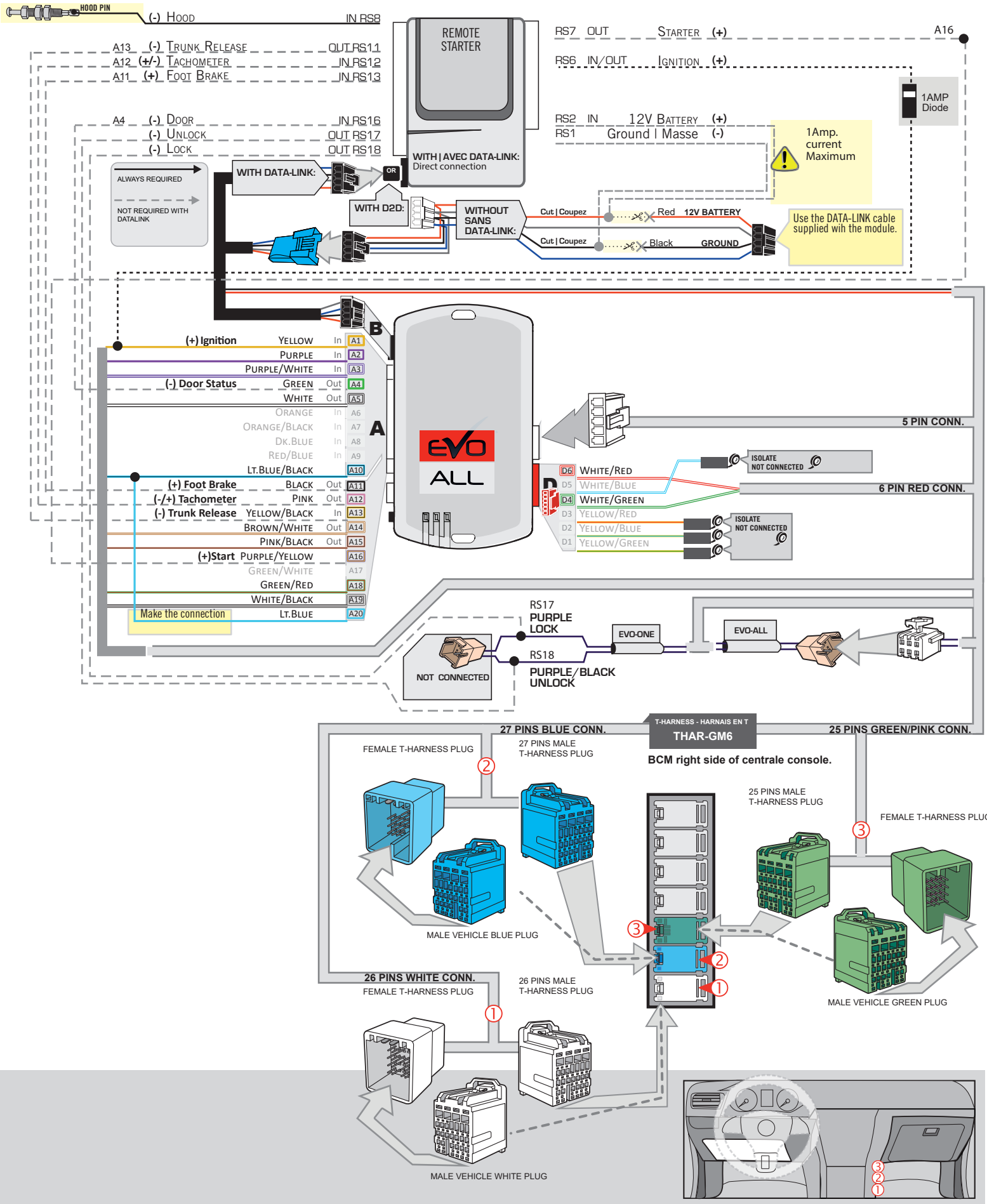

KEY BYPASS PROGRAMMING PROCEDURE 1/3

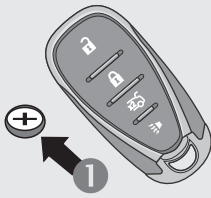

1 Remove the battery from the OEM remote.

2 Place the OEM remotes in to the center console.

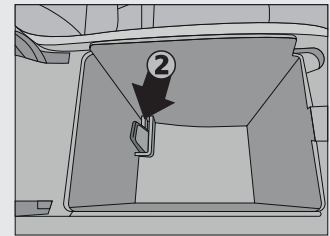

1

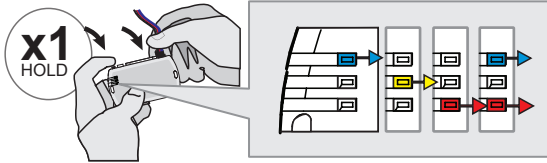

Press and hold the programming button:
Connect the 4-PIN Data-link harness (Black connector).

↳The Blue, Red, Yellow and Blue & Red LEDs will alternatively illuminate.

2

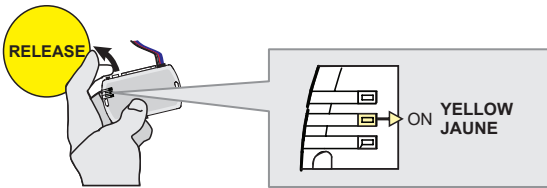

Release the programming button when the LED is YELLOW.

If the LED is not solid YELLOW disconnect the 4-Pin connector (Data-Link) and go back to step 1.

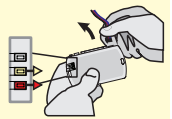

3

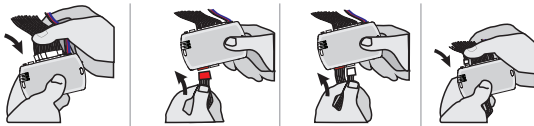

Insert the required remaining connectors.

4

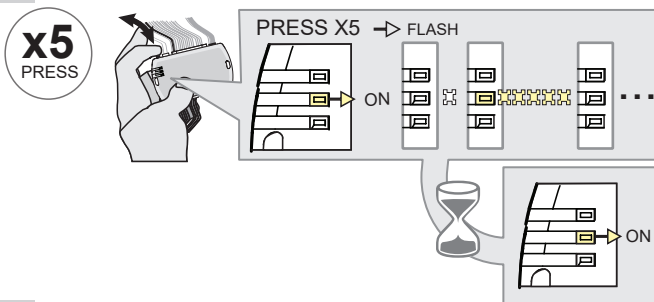

Press and release the programming button five (5x) times.

↳The YELLOW LED will flash 5 times each second.

↳WAIT for the YELLOW LED to turn ON solide.

5

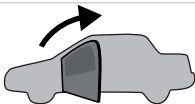

Open the driver door.

6

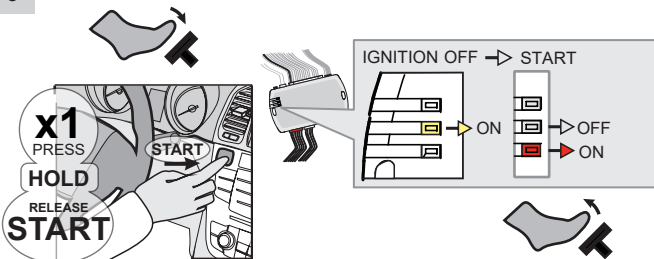

Press the foot-brake pedal.

Press the Push-to-Start button until the engine start.

Release the foot-brake pedal.

↳The RED LED will turn ON.
↳The YELLOW LED will turn OFF.

KEY BYPASS PROGRAMMING PROCEDURE 2/3

7



Press the Push-to-Start button until the engine turn OFF.

8

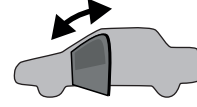

Close and open the driver door.

9

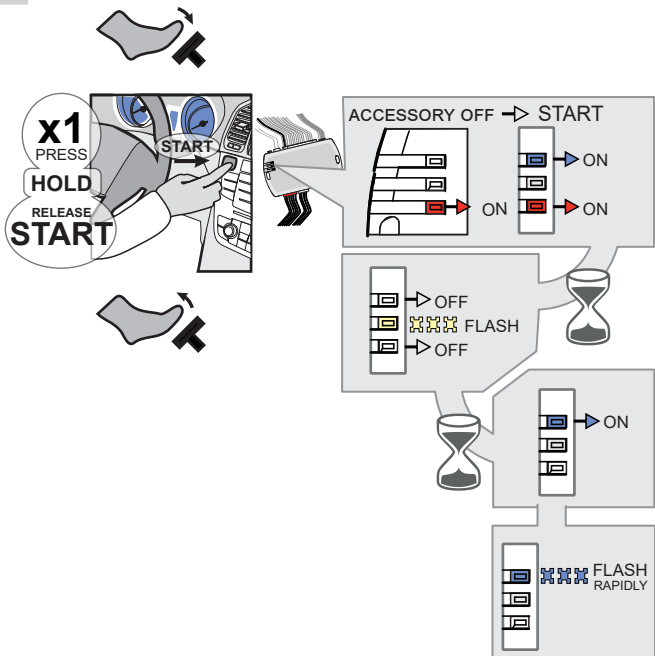

Press the foot-brake pedal.

Press the Push-to-Start button until the engine start.

Release the foot-brake pedal.

- ↳ The BLUE LED will turn ON.
- ↳ The BLUE LED will turn OFF. The RED LED will turn OFF.
- ↳ The YELLOW LED will flash rapidly
- ↳ The BLUE LED will turn ON.
- ↳ The BLUE LED will flash rapidly

10

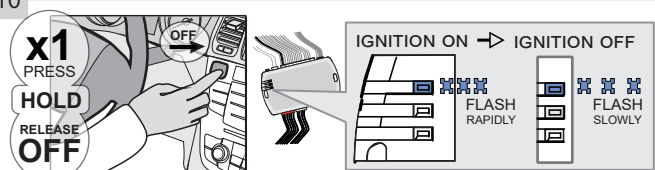

Press the Push-to-Start button until the engine turn OFF.

- ↳ The BLUE LED will flash slowly

11

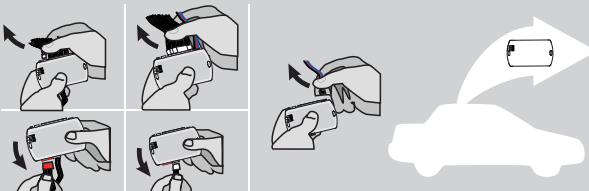

Disconnect all the connectors and after the Data-Link (4-pins) connector.

12

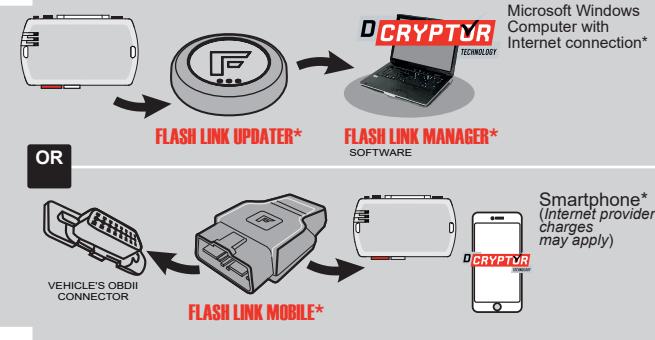

Use the tool: FLASH LINK UPDATER or FLASH LINK MOBILE to visit the DCRYPTOR menu.

*Parts required (not included)

13

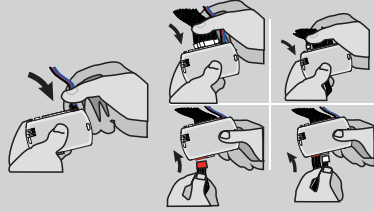
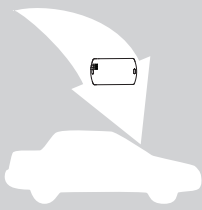

AFTER DCRYPTOR PROGRAMMING COMPLETED
Go back to the vehicle and **reconnect** the 4-Pin (Data-Link) connector and after, all the remaining connector.



The module is now programmed.



REMOTE STARTER / ALARM VERIFICATION PROCEDURE

Test the remote starter. Remote start the vehicle.

REMOTE STARTER FUNCTIONALITY |



All doors must be closed.



Remote start the vehicle.



Unlock the doors with either:

- The OEM remote
- The remote-starter remote
- Or the proximity remote



Enter the vehicle with the Intelligent Key.



The vehicle can now be put in to gear and driven.

If the vehicle is not unlocked with one of these conditions the remote-starter will shut down as soon as any door is opened.





THAR-GM6

THARNNESS
INSTALLATION

ADDENDUM - SUGGESTED WIRING CONFIGURATION

VEHICLE	YEARS	Vehicle functions supported in this diagram (functional if equipped)												
		Immobilizer bypass	Lock	Unlock	Arm	Disarm	RAP Disable	Tachometer	Heated Seats	Door Status	Hand-Brake Status (Data-Link Only, Data-Link Seule-ment)	Foot-Brake Status	OEM Remote	
														
GMC														
Sierra 1500	Push-To-Start	2019-2020	•	•	•	•	•	•	•	•	•	•	•	•

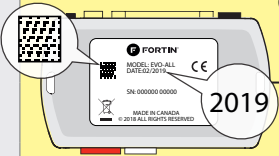
	COMPATIBLE MODULE REQUIRED:	QR CODE ON THE LABEL MANUFACTURED AFTER: 2019	FIRMWARE VERSION 70.[40] GM MINIMUM	To add the firmware version and the options, use the FLASH LINK UPDATER or FLASH LINK MOBILE tool, sold separately.
		DATE: 2019		

	IF THE VEHICLE IS NOT EQUIPPED WITH FUNCTIONAL HOOD PIN:	A11	<input type="checkbox"/> OFF	Hood trigger (Output Status).

Program bypass option:	UNIT OPTION	DESCRIPTION
	C1	OEM Remote status (Lock/Unlock) monitoring
	D6	Push-to-Start

	ATTENTION!	 DATE: XX-XX	E5	<input type="checkbox"/> OFF	SPECIAL FUNCTIONS: BY DEFAULT DEACTIVATED
				<input type="checkbox"/> ON	MANUFACTURED MODULES BETWEEN: 04/2018 TO 04/2019

Parts required (Not included)
 1X 1Amp Diode
 1X THAR-GM6

MANDATORY INSTALL	*HOOD PIN 	HOOD STATUS: THE HOOD PIN SWITCH MUST BE INSTALLED IF THE VEHICLE CAN BE REMOTE STARTED WITH THE HOOD OPEN, SET FUNCTION A11 TO OFF.	<input type="checkbox"/> OFF	Notice: the installation of safety elements are mandatory. The hood pin is an essential security element and must be installed.	THIS MODULE MUST BE INSTALLED BY A QUALIFIED TECHNICIAN. A WRONG CONNECTION CAN CAUSE PERMANENT DAMAGE TO THE VEHICLE.
--------------------------	--	--	------------------------------	--	--

DESCRIPTION

BCM, Above Driver kick panel

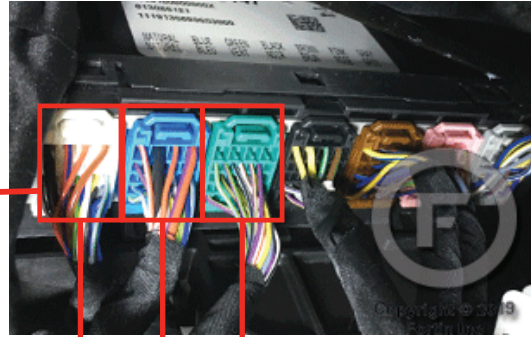

①

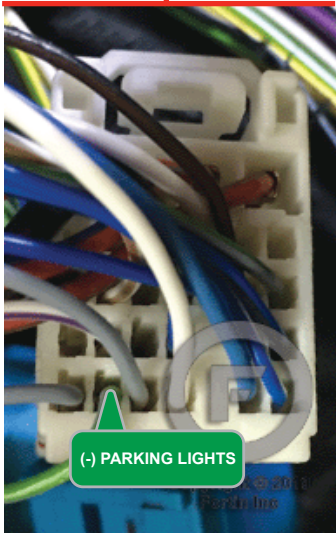

②

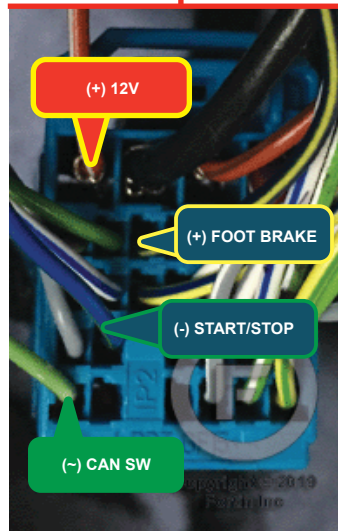

③

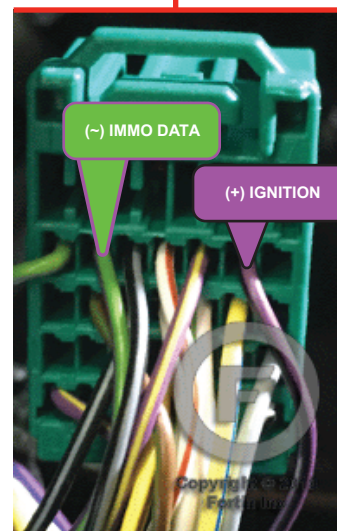

AUTOMATIC TRANSMISSION WIRING CONNECTION

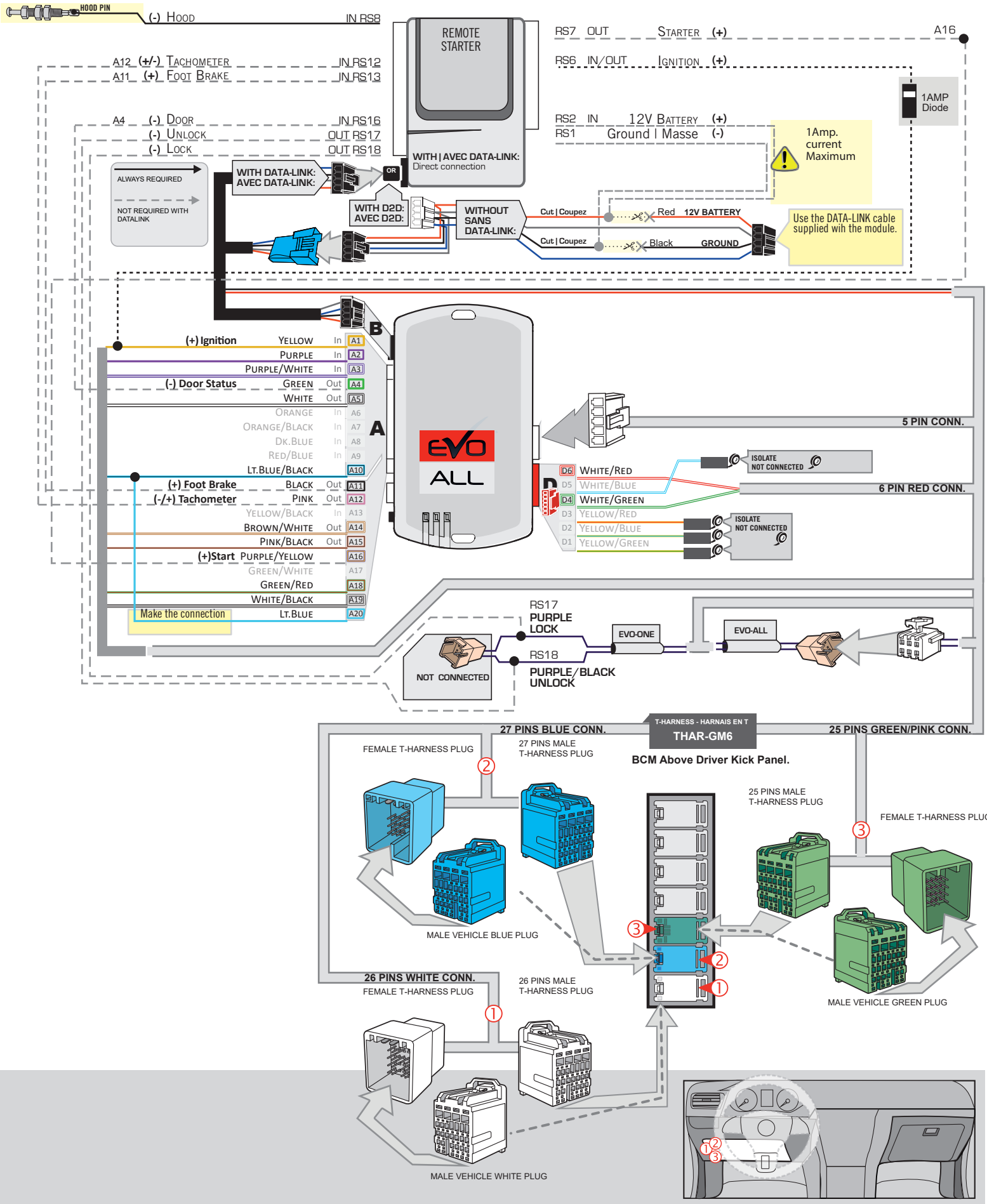

KEY BYPASS PROGRAMMING PROCEDURE 1/3

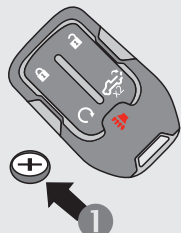

1 Remove the battery from the OEM remote.

2 Place the OEM remotes in to the center console.

1 Remove the battery from the OEM remote.

2 Place the transmitter in the cupholder

Refer to vehicle user guide for keyport location.

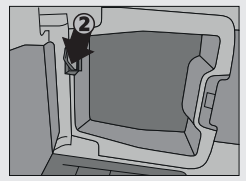
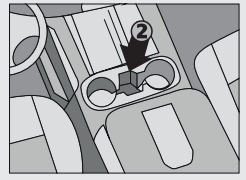
1

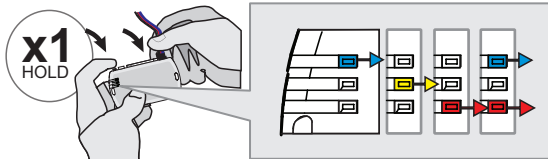

Press and hold the programming button:
Connect the 4-PIN Data-link harness (Black connector).

↳The Blue, Red, Yellow and Blue & Red LEDs will alternatively illuminate.

2

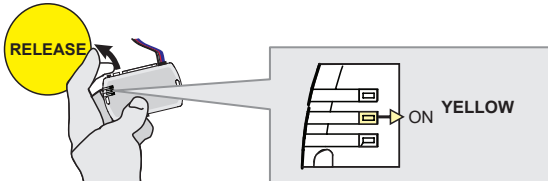

Release the programming button when the LED is YELLOW.

If the LED is not solid YELLOW disconnect the 4-Pin connector (Data-Link) and go back to step 1.



3

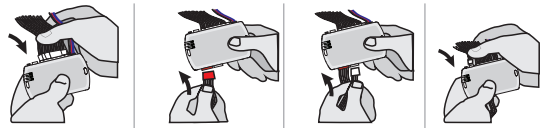

Insert the required remaining connectors.

4

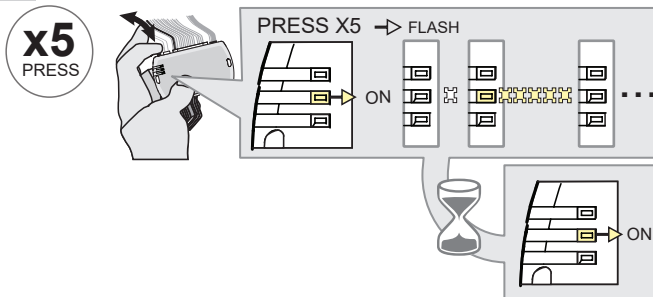

Press and release the programming button five (5x) times.

↳The YELLOW LED will flash 5 times each second.

↳WAIT for the YELLOW LED to turn ON solide.

5

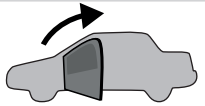

Open the driver door.

6

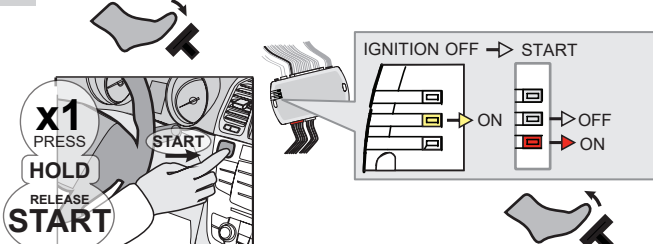

Press the foot-brake pedal.

Press the Push-to-Start button until the engine start.

Release the foot-brake pedal.

*↳The RED LED will turn ON.
 ↳The YELLOW LED will turn OFF.*

KEY BYPASS PROGRAMMING PROCEDURE 2/3

7

Press the Push-to-Start button until the engine turn OFF.

8

Close and open the driver door.

9

Press the foot-brake pedal.

Press the Push-to-Start button until the engine start.

Release the foot-brake pedal.

- ↳ The BLUE LED will turn ON.
- ↳ The BLUE LED will turn OFF. The RED LED will turn OFF.
- ↳ The YELLOW LED will flash rapidly
- ↳ The BLUE LED will turn ON.
- ↳ The BLUE LED will flash rapidly

10

Press the Push-to-Start button until the engine turn OFF.

- ↳ The BLUE LED will flash slowly

11

Disconnect all the connectors and after the Data-Link (4-pins) connector.

12

Use the tool: FLASH LINK UPDATER or FLASH LINK MOBILE to visit the DCRYPTOR menu.

*Parts required (not included)

KEY BYPASS PROGRAMMING PROCEDURE 3/3

13

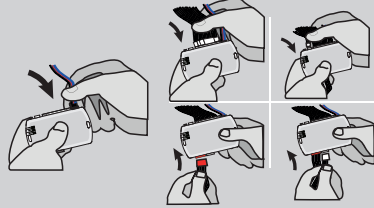
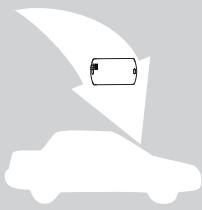

AFTER DCRYPTOR PROGRAMMING COMPLETED
Go back to the vehicle and **reconnect** the 4-Pin (Data-Link) connector and after, all the remaining connector.



The module is now programmed.



REMOTE STARTER / ALARM VERIFICATION PROCEDURE

Test the remote starter. **Remote start** the vehicle.

REMOTE STARTER FUNCTIONALITY



All doors must be closed.

Remote start the vehicle.



Press the Unlock button of the remote car starter.

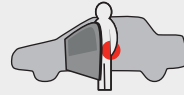

Enter the vehicle with the Intelligent Access Key.



The vehicle can now be put in to gear and driven.



If the vehicle is not unlocked the module will shut down the remote-starter and the vehicle as soon as any door is opened.

THAR-GM6

THARNNESS INSTALLATION

ADDENDUM - SUGGESTED WIRING CONFIGURATION



Vehicle functions supported in this diagram (functional if eq

VEHICLE	YEARS	Immobilizer bypass	Lock	Unlock	Arm	Disarm	RAP Disable	Tachometer	Heated Seats	Door Status	Hand-Brake Status	Foot-Brake Status	OEM Remote Monitoring
CHEVROLET													
Silverado 2500	Push-To-Start	2020-2021	•	•	•	•	•	•	•	•	•	•	•
GMC													
Sierra 2500	Push-To-Start	2020-2021	•	•	•	•	•	•	•	•	•	•	•

FIRMWARE VERSION

70.[45]

GM MINIMUM

To add the firmware version and the options, use the **FLASH LINK UPDATER** or **FLASH LINK MOBILE** tool, sold separately.

	UNIT OPTION		DESCRIPTION
	C1		OEM Remote status (Lock/Unlock) monitoring
IF THE VEHICLE IS NOT EQUIPPED WITH FUNCTIONAL HOOD PIN:			
	A11	OFF	Hood trigger (Output Status).
	D6		Push-to-Start

ATTENTION!

DATE: XX-XX

E5

OFF

SPECIAL FUNCTIONS: BY DEFAULT DEACTIVATED

MANUFACTURED MODULES BETWEEN: 04/2018 TO 04/2019

Parts required (Not included)

1X 1Amp Diode

MANDATORY INSTALL

*HOOD PIN



HOOD STATUS: THE HOOD PIN SWITCH MUST BE INSTALLED IF THE VEHICLE CAN BE REMOTE STARTED WITH THE HOOD OPEN, SET FUNCTION A11 TO OFF.

A11

OFF

Notice: the installation of safety elements are mandatory. The hood pin is an essential security element and must be installed.

THIS MODULE MUST BE INSTALLED BY A QUALIFIED TECHNICIAN. A WRONG CONNECTION CAN CAUSE PERMANENT DAMAGE TO THE VEHICLE.

DESCRIPTION

BCM

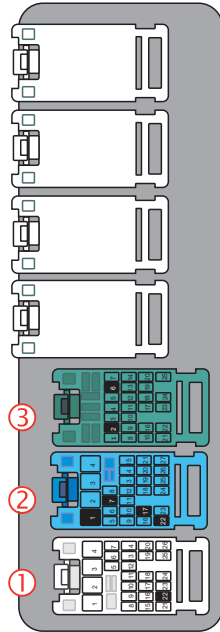

AUTOMATIC TRANSMISSION WIRING CONNECTION

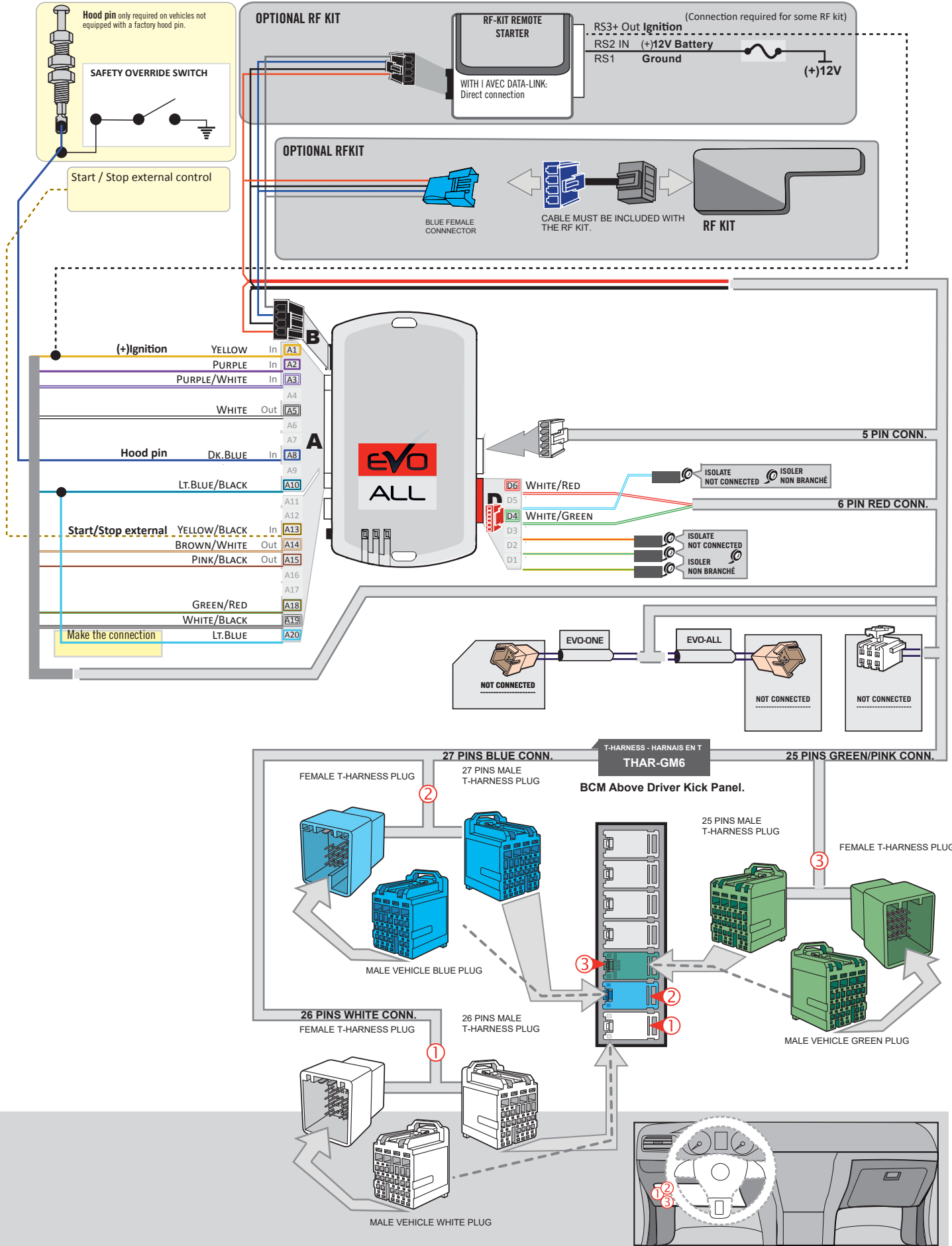

KEY BYPASS PROGRAMMING PROCEDURE 1/3

SIERRA SILVERADO

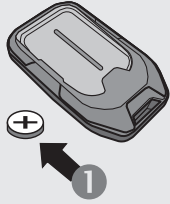

- 1** Remove the battery from the OEM remote.
- 2** Place the OEM remote in the middle part of the cup holder in the center console.

Refer to vehicle user guide for keyport location.

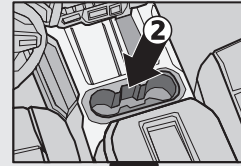

OR

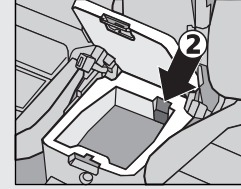

- 1** Remove the battery from the OEM remote.
- 2** Place the transmitter in the transmitter pocket, which is inside the **centre** console storage area.

Refer to vehicle user guide for keyport location.

1

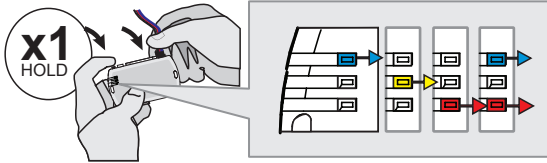

Press and hold the programming button:
Connect the 4-PIN Data-link harness (Black connector).

↳The Blue, Red, Yellow and Blue & Red LEDs will alternatively illuminate.

2

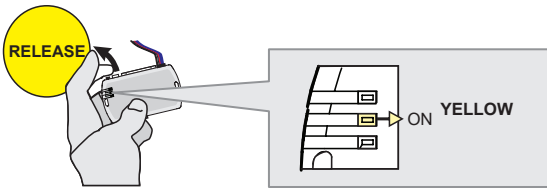

Release the programming button when the LED is **YELLOW**.

If the LED is not solid YELLOW disconnect the 4-Pin connector (Data-Link) and go back to step 1.

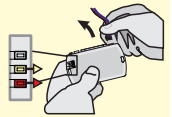

3

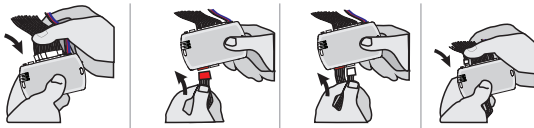

Insert the required remaining connectors.

4

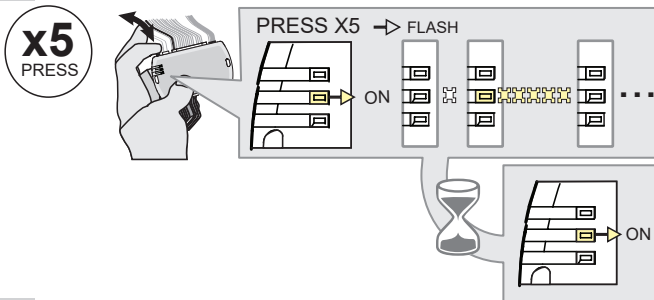

Press and release the programming button five (5x) times.

↳The YELLOW LED will flash 5 times each second.

↳WAIT for the YELLOW LED to turn ON solide.

5

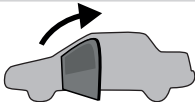

Open the driver door.

6

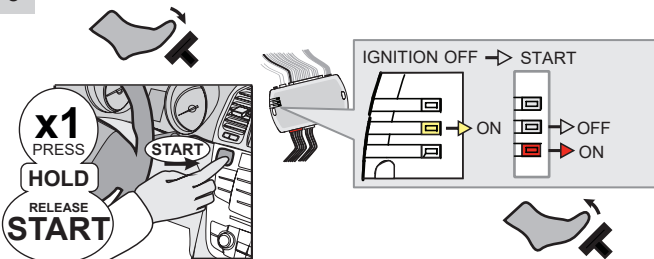

Press the foot-brake pedal.

Press the Push-to-Start button until the engine start.

Release the foot-brake pedal.

*↳The RED LED will turn ON.
↳The YELLOW LED will turn OFF.*

KEY BYPASS PROGRAMMING PROCEDURE 2/3 |

7



Press the Push-to-Start button until the engine turn OFF.

8

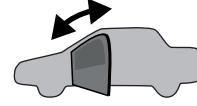

Close and open the driver door.

9

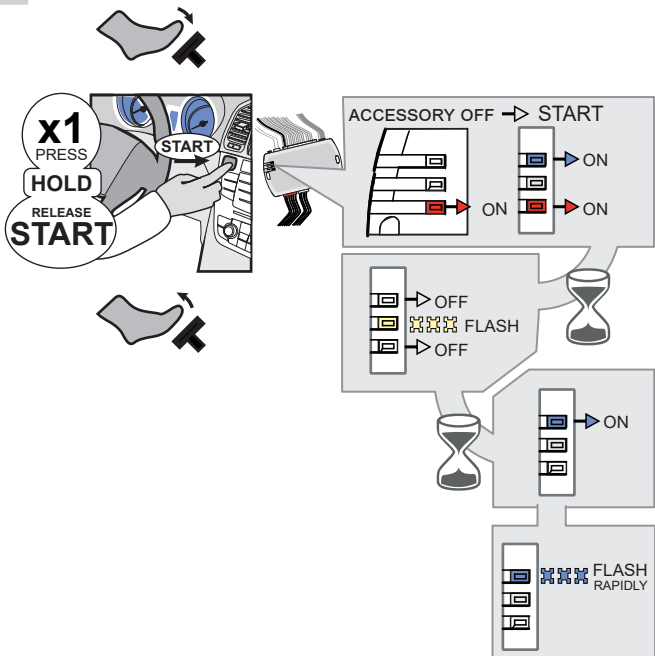

Press the foot-brake pedal.

Press the Push-to-Start button until the engine start.

Release the foot-brake pedal.

- ↳ The BLUE LED will turn ON.
- ↳ The BLUE LED will turn OFF. The RED LED will turn OFF.
- ↳ The YELLOW LED will flash rapidly
- ↳ The BLUE LED will turn ON.
- ↳ The BLUE LED will flash rapidly

10

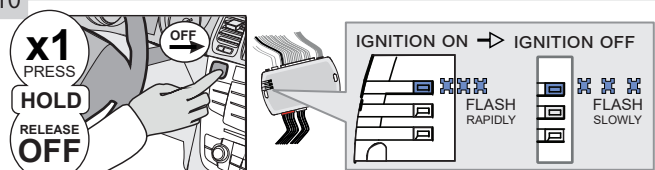

Press the Push-to-Start button until the engine turn OFF.

- ↳ The BLUE LED will flash slowly

11

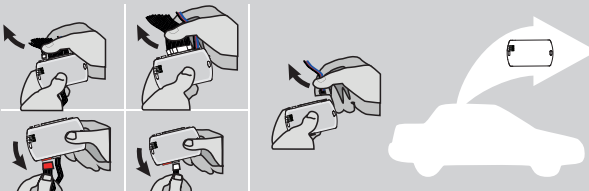

Disconnect all the connectors and after the Data-Link (4-pins) connector.

12

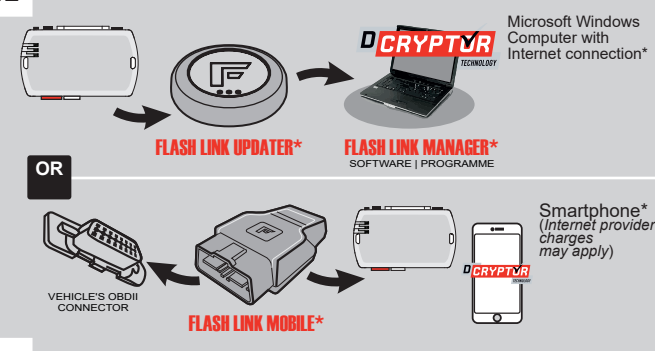

Use the tool: FLASH LINK UPDATER or FLASH LINK MOBILE to visit the DCryptor menu.

***Parts required (not included)**

13

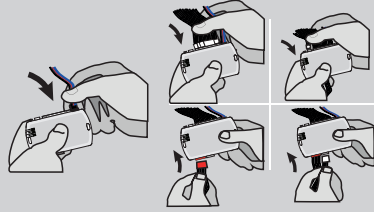
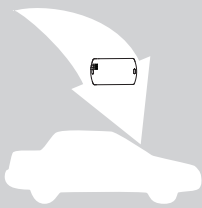

AFTER DCRYPTOR PROGRAMMING COMPLETED
Go back to the vehicle and **reconnect** the 4-Pin (Data-Link) connector and after, all the remaining connector.



The module is now programmed.



REMOTE STARTER / ALARM VERIFICATION PROCEDURE

Test the remote starter. Remote start the vehicle.

REMOTE STARTER FUNCTIONALITY |



All doors must be closed.

Remote start the vehicle.



Press the Unlock button of the remote car starter or the OEM remote.



Enter the vehicle with the Intelligent Access Key.

The vehicle can now be put in to gear and driven.





If the vehicle is not unlocked the module will shut down the remote-starter and the vehicle as soon as any door is opened.

THAR-GM6

**THARNESS
INSTALLATION**

ADDENDUM - SUGGESTED WIRING CONFIGURATION

VEHICLE	YEARS	Vehicle functions supported in this diagram (functional if equipped)												
		Immobilizer bypass	Lock	Unlock	Arm	Disarm	RAP Disable	Tachometer	Heated Seats	Door Status	Hand-Brake Status (Data-Link Only, Data-Link Seule-ment)	Foot-Brake Status	OEM Remote	
														
CHEVROLET														
Silverado 1500	Push-To-Start**	2019	•	•	•	•	•	•	•	•	•	•	•	•



FIRMWARE VERSION

70.[41]

GM MINIMUM

To add the firmware version and the options, use the **FLASH LINK UPDATER** or **FLASH LINK MOBILE** tool, sold separately.

IF THE VEHICLE IS NOT EQUIPPED WITH FUNCTIONAL HOOD PIN:

A11

OFF

Hood trigger (Output Status).

	Program bypass option:	UNIT OPTION	DESCRIPTION
		C1	OEM Remote status (Lock/Unlock) monitoring
		D6	Push-to-Start



ATTENTION!



DATE: XX-XX

E5

OFF

/

ON

SPECIAL FUNCTIONS:
BY DEFAULT DEACTIVATED

MANUFACTURED MODULES BETWEEN: 04/2018 TO 04/2019

 **Parts required (Not included)**

1X 1Amp Diode
1X THAR-GM6

MANDATORY INSTALL

***HOOD PIN**



HOOD STATUS: THE HOOD PIN SWITCH MUST BE INSTALLED IF THE VEHICLE CAN BE REMOTE STARTED WITH THE HOOD OPEN, SET FUNCTION A11 TO OFF.

A11

OFF

Notice: the installation of safety elements are mandatory. The hood pin is an essential security element and must be installed.

THIS MODULE MUST BE INSTALLED BY A QUALIFIED TECHNICIAN. A WRONG CONNECTION CAN CAUSE PERMANENT DAMAGE TO THE VEHICLE.

DESCRIPTION

BCM, Above Driver kick panel

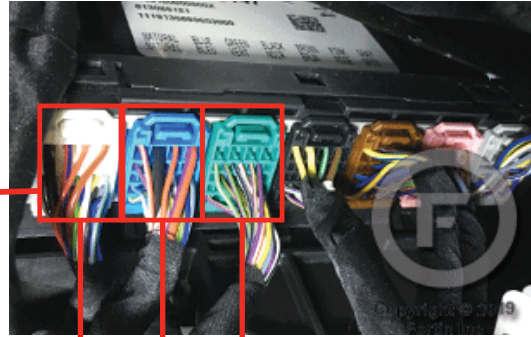

①



②

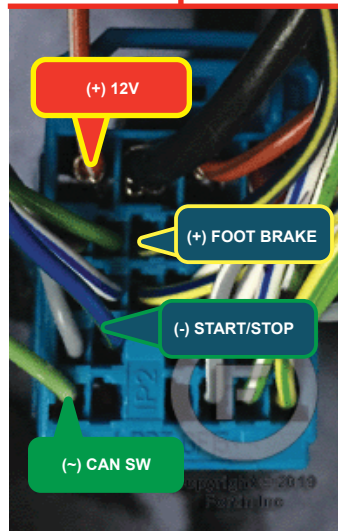

③

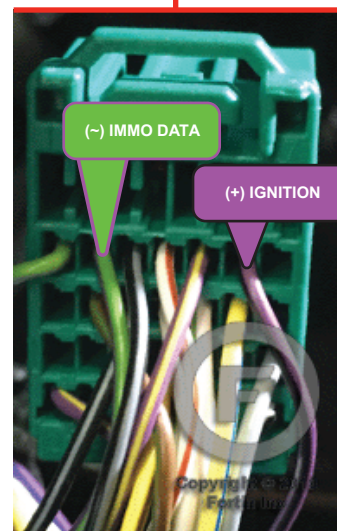

AUTOMATIC TRANSMISSION WIRING CONNECTION

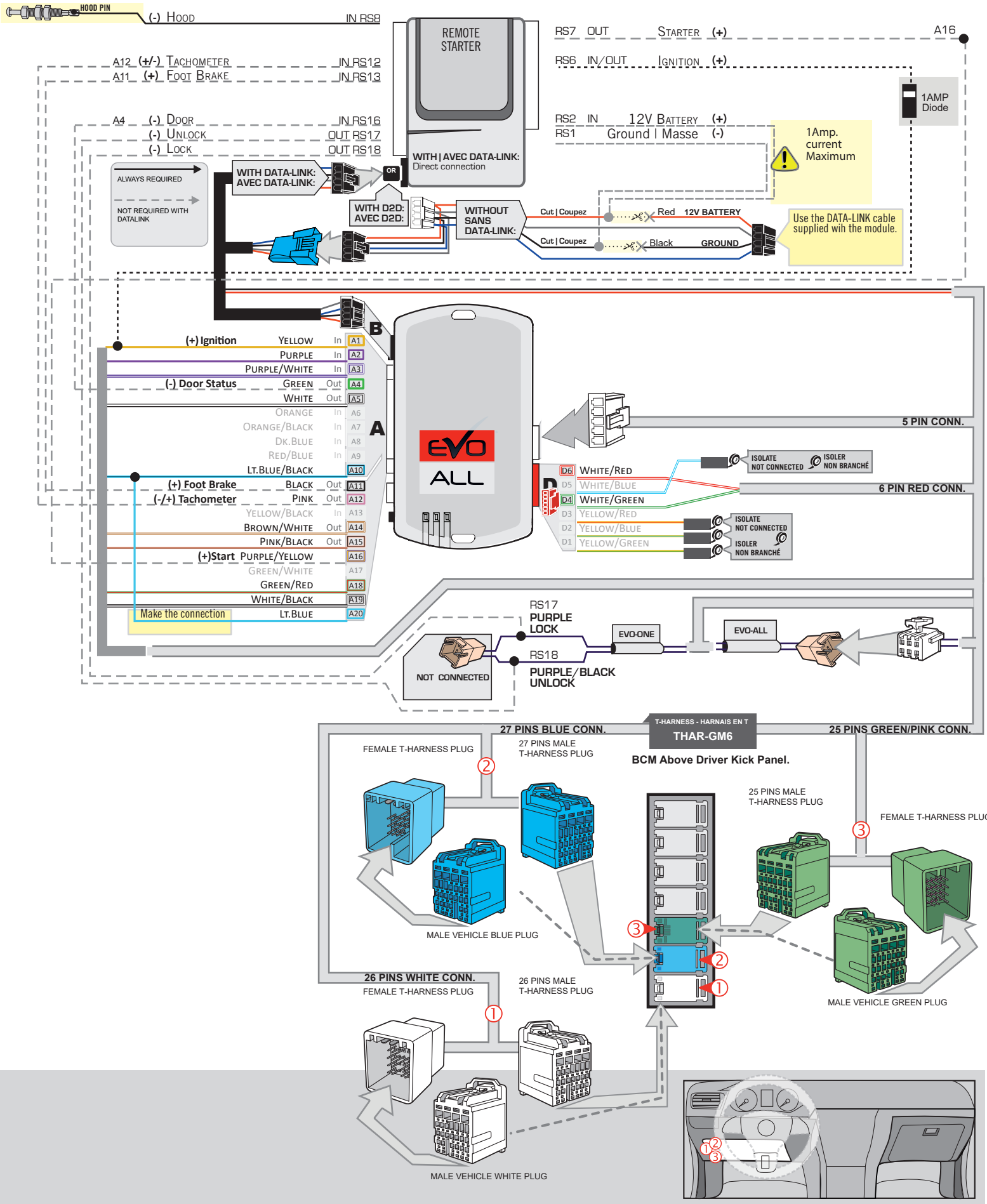

KEY BYPASS PROGRAMMING PROCEDURE 1/3

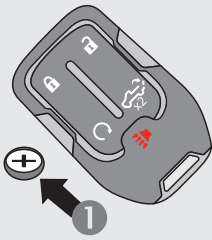

1 Remove the battery from the OEM remote.

2 Place the OEM remotes in to the center console.

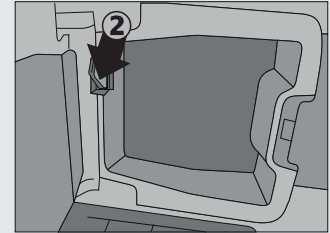

1

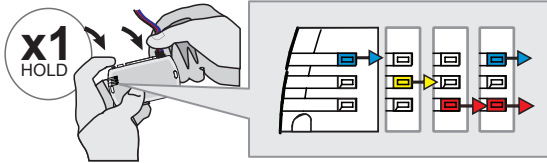

Press and hold the programming button:
Connect the 4-PIN Data-link harness (Black connector).

↳The Blue, Red, Yellow and Blue & Red LEDs will alternatively illuminate.

2

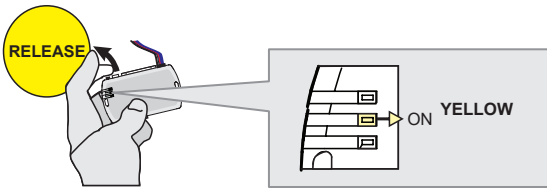

Release the programming button when the LED is YELLOW.

If the LED is not solid YELLOW disconnect the 4-Pin connector (Data-Link) and go back to step 1.

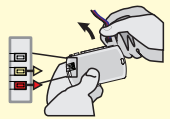

3

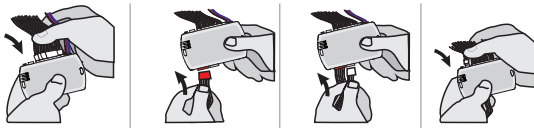

Insert the required remaining connectors.

4

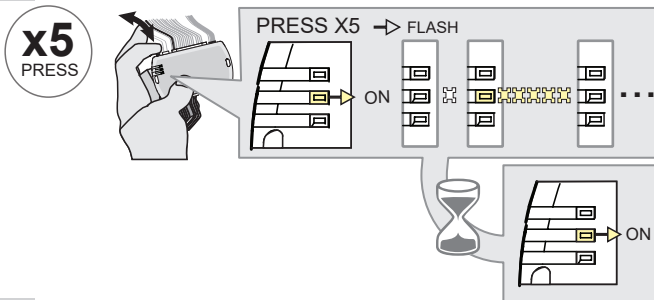

Press and release the programming button five (5x) times.

↳The YELLOW LED will flash 5 times each second.

↳WAIT for the YELLOW LED to turn ON solide.

5

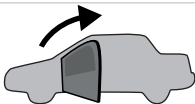

Open the driver door.

6

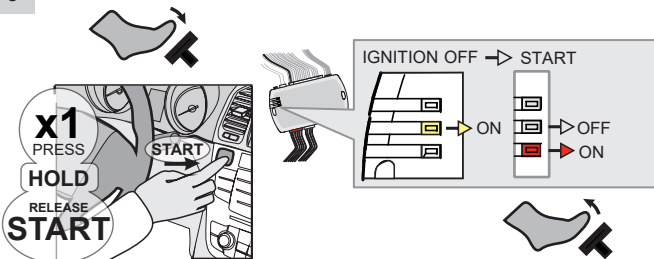

Press the foot-brake pedal.

Press the Push-to-Start button until the engine start.

Release the foot-brake pedal.

↳The RED LED will turn ON.
 ↳The YELLOW LED will turn OFF.

KEY BYPASS PROGRAMMING PROCEDURE 2/3

7



Press the Push-to-Start button until the engine turn OFF.

8

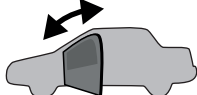

Close and open the driver door.

9

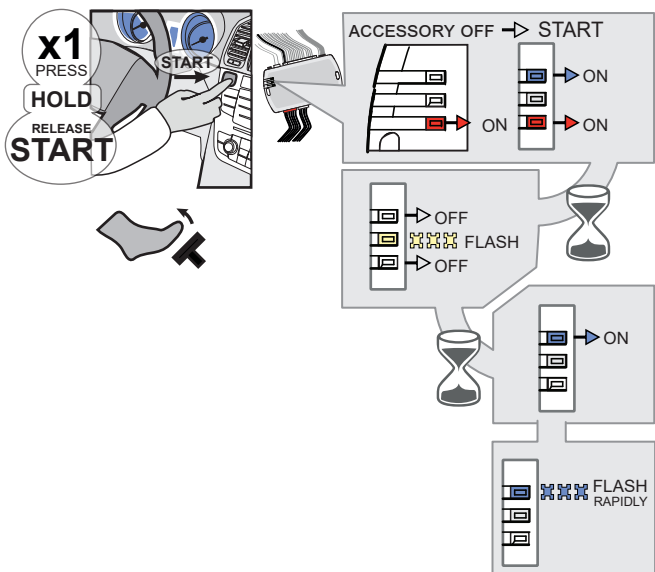

Press the foot-brake pedal.

Press the Push-to-Start button until the engine start.

Release the foot-brake pedal.

- ↳ The BLUE LED will turn ON.
- ↳ The BLUE LED will turn OFF. The RED LED will turn OFF.
- ↳ The YELLOW LED will flash rapidly
- ↳ The BLUE LED will turn ON.
- ↳ The BLUE LED will flash rapidly

10

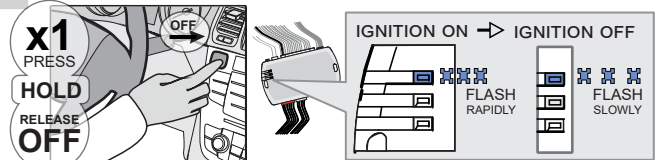

Press the Push-to-Start button until the engine turn OFF.

- ↳ The BLUE LED will flash slowly

11

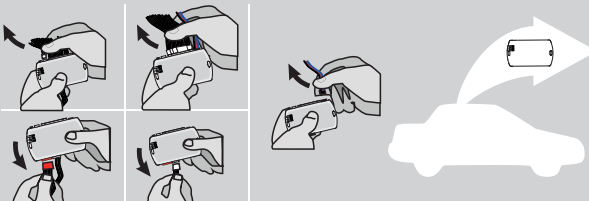

Disconnect all the connectors and after the Data-Link (4-pins) connector.

12

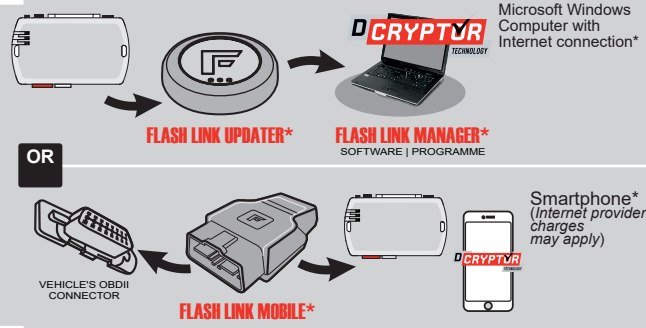

Use the tool: FLASH LINK UPDATER or FLASH LINK MOBILE to visit the DCRYPTOR menu.

*Parts required (not included)

KEY BYPASS PROGRAMMING PROCEDURE 3/3

13

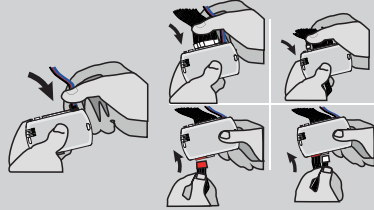
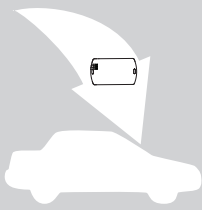

AFTER DCRYPTOR PROGRAMMING COMPLETED
Go back to the vehicle and **reconnect** the 4-Pin (Data-Link) connector and after, all the remaining connector.



The module is now programmed.



REMOTE STARTER / ALARM VERIFICATION PROCEDURE

Test the remote starter. Remote start the vehicle.

REMOTE STARTER FUNCTIONALITY



All doors must be closed.

Remote start the vehicle.



Press the Unlock button of the remote car starter.

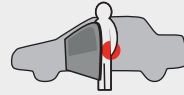

Enter the vehicle with the Intelligent Access Key.



The vehicle can now be put in to gear and driven.



If the vehicle is not unlocked the module will shut down the remote-starter and the vehicle as soon as any door is opened.

THAR-GM6

THARNNESS INSTALLATION

ADDENDUM - SUGGESTED WIRING CONFIGURATION

VEHICLE	YEARS	Vehicle functions supported in this diagram (functional if equipped)													
		Immobilizer bypass	Lock	Unlock	Arm	Disarm	Trunk (open)	RAP Disable	Tachometer	Heated Seats	Door Status	Trunk Status (Data-Link Only, Data-Link Seule-ment)	Hand-Brake Status (Data-Link Only, Data-Link Seule-ment)	Foot-Brake Status	OEM Remote Monitoring
CHEVROLET															
Sonic	Push-To-Start	2017-2018	•	•	•	•	•	•	•	•	•	•	•	•	•
Spark	Push-To-Start	2016-2021	•	•	•	•	•	•	•	•	•	•	•	•	•

FIRMWARE VERSION

70.[45]

GM MINIMUM

To add the firmware version and the options, use the **FLASH LINK UPDATER** or **FLASH LINK MOBILE** tool, sold separately.

	UNIT OPTION		DESCRIPTION
<p>Program bypass option:</p>	C1		OEM Remote status (Lock/Unlock) monitoring
	IF THE VEHICLE IS NOT EQUIPPED WITH FUNCTIONAL HOOD PIN:		
	A11	OFF	Hood trigger (Output Status).
	D6		Push-to-Start

ATTENTION!

DATE: XX-XX

E5

SPECIAL FUNCTIONS:
BY DEFAULT DEACTIVATED

MANUFACTURED MODULES BETWEEN: 04/2018 TO 04/2019

Parts required (Not included)

1X 1Amp Diode

MANDATORY INSTALL

*HOOD PIN



HOOD STATUS: THE HOOD PIN SWITCH MUST BE INSTALLED IF THE VEHICLE CAN BE REMOTE STARTED WITH THE HOOD OPEN, SET FUNCTION A11 TO OFF.

A11

OFF

Notice: the installation of safety elements are mandatory. The hood pin is an essential security element and must be installed.

THIS MODULE MUST BE INSTALLED BY A QUALIFIED TECHNICIAN. A WRONG CONNECTION CAN CAUSE PERMANENT DAMAGE TO THE VEHICLE.

DESCRIPTION

BCM



③



②

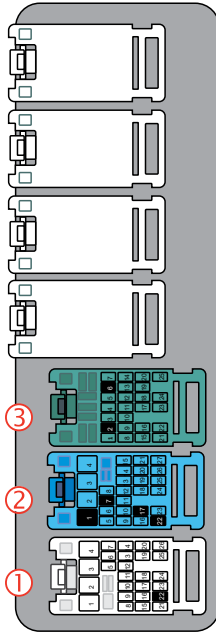
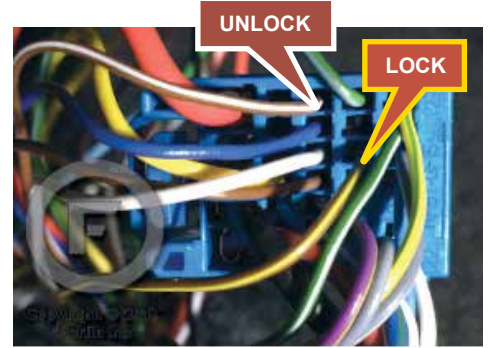
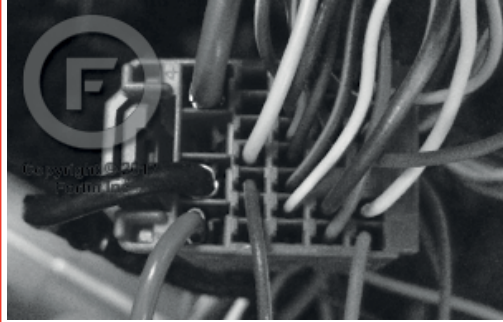

①



AUTOMATIC TRANSMISSION WIRING CONNECTION

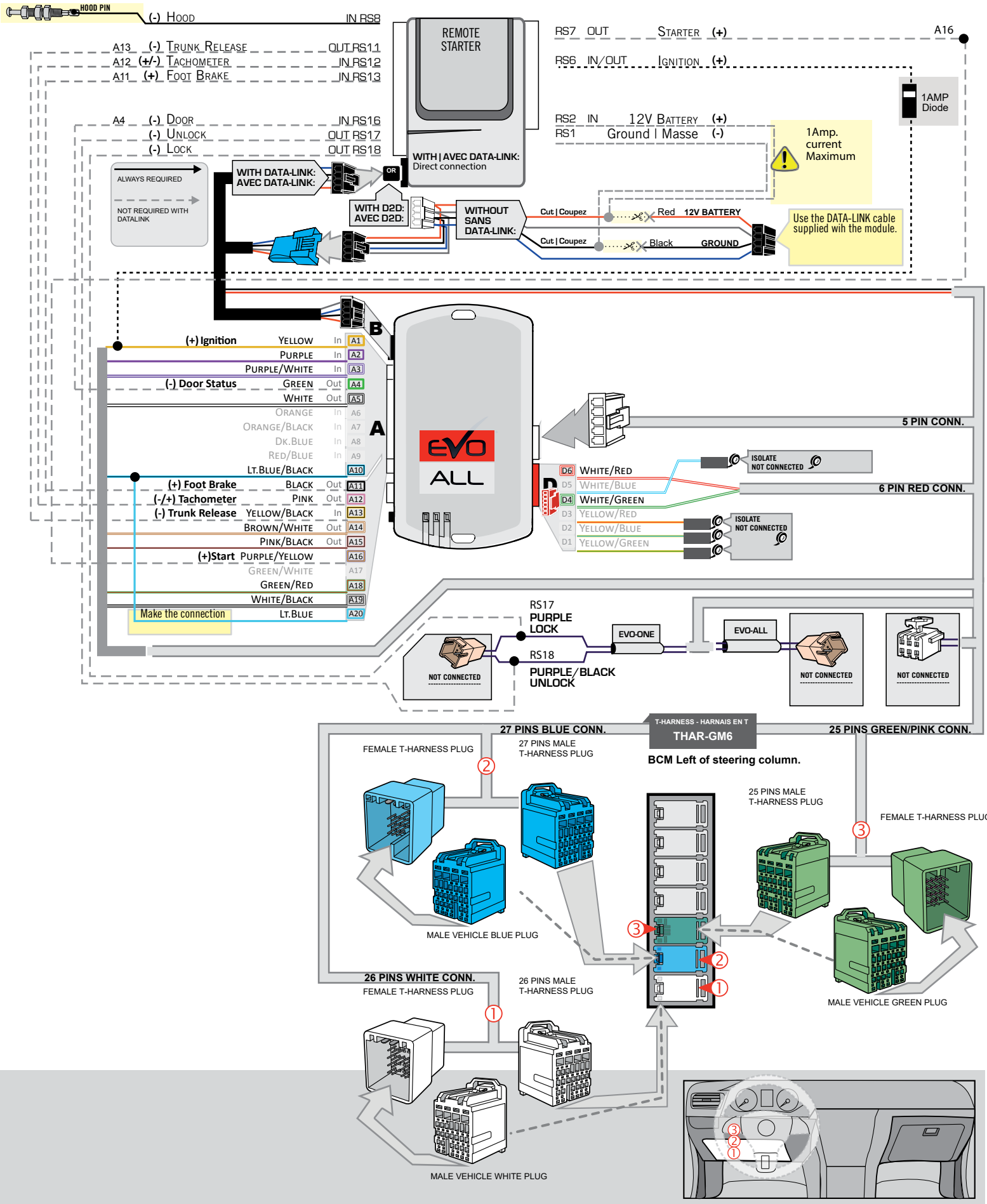

KEY BYPASS PROGRAMMING PROCEDURE 1/3

SONIC



- 1** Remove the battery from the OEM remote.
- 2** Place the OEM remote in the front cup holder in the center console.

Refer to vehicle user guide for keyport location.

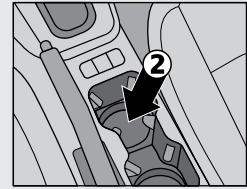

SPARK

- 1** Remove the battery from the OEM remote.
- 2** Place the transmitter in the transmitter pocket, which is inside the centre console storage area.

Refer to vehicle user guide for keyport location.

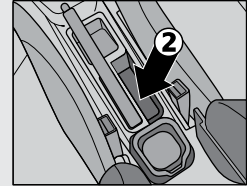

1

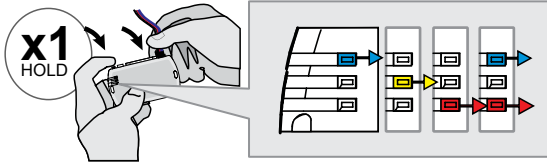

Press and hold the programming button:
Connect the 4-PIN Data-link harness (Black connector).

↳The Blue, Red, Yellow and Blue & Red LEDs will alternatively illuminate.

2

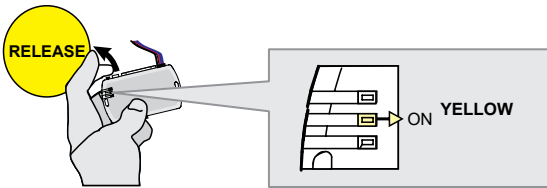

Release the programming button when the LED is YELLOW.

If the LED is not solid YELLOW disconnect the 4-Pin connector (Data-Link) and go back to step 1.

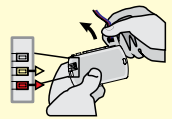

3

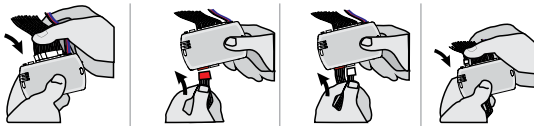

Insert the required remaining connectors.

4

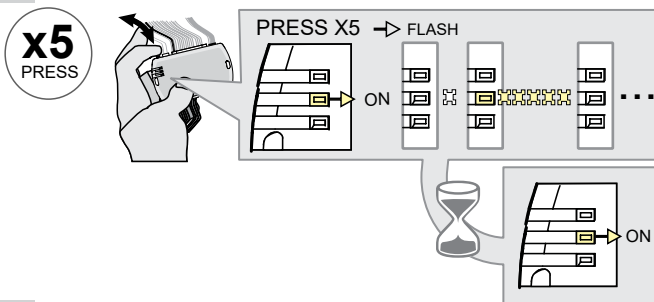

Press and release the programming button five (5x) times.

↳The YELLOW LED will flash 5 times each second.

↳**WAIT** for the YELLOW LED to turn ON solide.

5

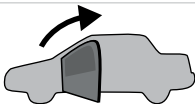

Open the driver door.

6

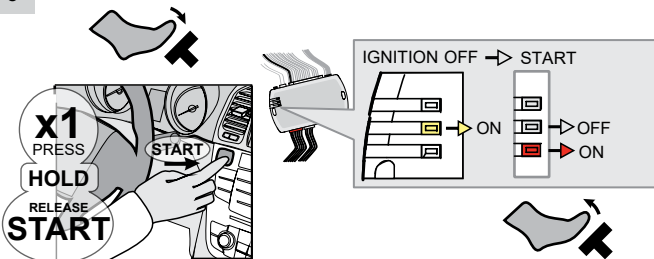

Press the foot-brake pedal.

Press the Push-to-Start button until the engine start.

Release the foot-brake pedal.

↳The RED LED will turn ON.
 ↳The YELLOW LED will turn OFF.

KEY BYPASS PROGRAMMING PROCEDURE 2/3

7



Press the Push-to-Start button until the engine turn OFF.

8

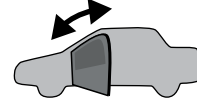

Close and open the driver door.

9

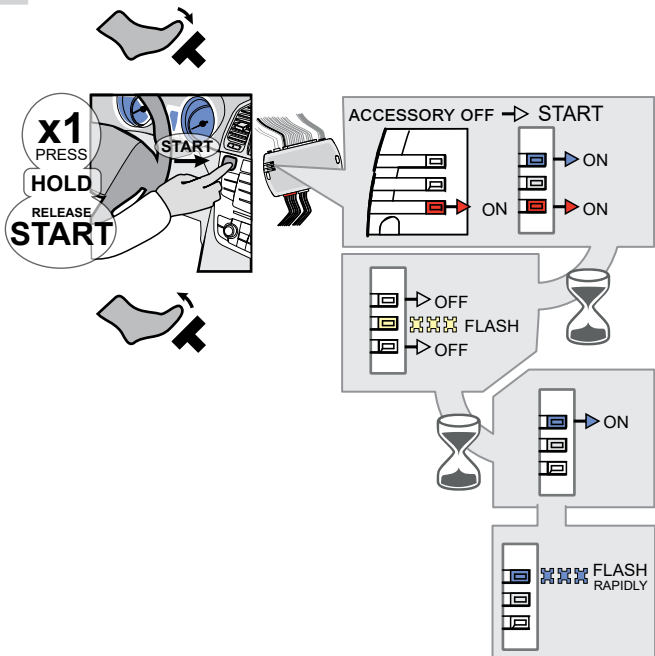

Press the foot-brake pedal.

Press the Push-to-Start button until the engine start.

Release the foot-brake pedal.

- ↳ The BLUE LED will turn ON.
- ↳ The BLUE LED will turn OFF. The RED LED will turn OFF.
- ↳ The YELLOW LED will flash rapidly
- ↳ The BLUE LED will turn ON.
- ↳ The BLUE LED will flash rapidly

10

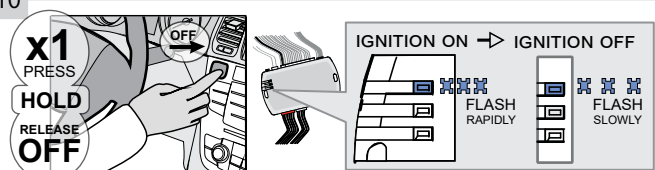

Press the Push-to-Start button until the engine turn OFF.

- ↳ The BLUE LED will flash slowly

11

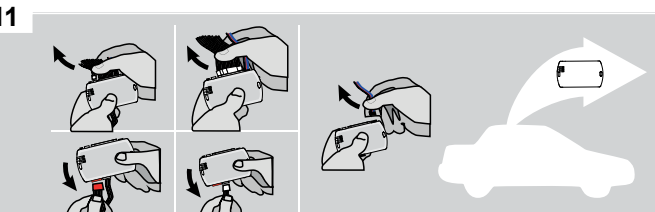

Disconnect all the connectors and after the Data-Link (4-pins) connector.

12

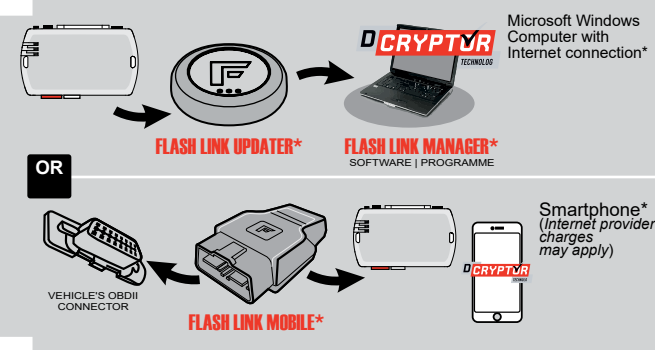

Microsoft Windows Computer with Internet connection*

Flash Link Updater* | Flash Link Manager* (SOFTWARE | PROGRAMME)

OR

Flash Link Mobile* | Smartphone* (Internet provider charges may apply)

Use the tool: FLASH LINK UPDATER or FLASH LINK MOBILE to visit the DCryptor menu.

*Parts required (not included)

KEY BYPASS PROGRAMMING PROCEDURE 3/3

13

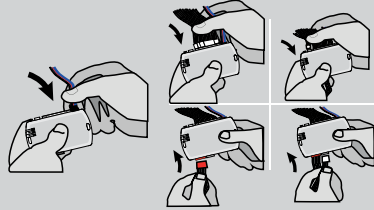
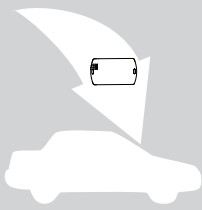

AFTER DCRYPTOR PROGRAMMING COMPLETED
Go back to the vehicle and **reconnect** the 4-Pin (Data-Link) connector and after, all the remaining connector.



The module is now programmed.



REMOTE STARTER / ALARM VERIFICATION PROCEDURE

Test the remote starter. Remote start the vehicle.

REMOTE STARTER FUNCTIONALITY



All doors must be closed.

Remote start the vehicle.



Press the Unlock button of the remote car starter or the OEM remote.

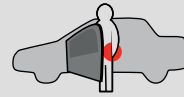

Enter the vehicle with the Intelligent Access Key.

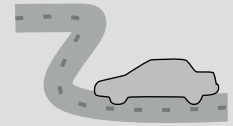

The vehicle can now be put in to gear and driven.



If the vehicle is not unlocked the module will shut down the remote-starter and the vehicle as soon as any door is opened.

THAR-GM6

THARNNESS INSTALLATION

ADDENDUM - SUGGESTED WIRING CONFIGURATION



Vehicle functions supported in this diagram (functional if equipped)

VEHICLE	YEARS	Immobilizer bypass	T-Harness	Lock	Unlock	Arm	Disarm	Trunk (open)	RAP Disable	Tachometer	Heated Seats	Door Status	Trunk Status (Data-Link Only/Data-Link Seulement)	Hand-Brake Status (Data-Link Only/Data-Link Seulement)	Foot-Brake Status	OEM Remote monitoring
CHEVROLET																
Volt	Push-To-Start	2016-2019	•	•	•	•	•	•	•	•	•	•	•	•	•	•



FIRMWARE VERSION

70.[41]

GM MINIMUM

To add the firmware version and the options, use the **FLASH LINK UPDATER** or **FLASH LINK MOBILE** tool, sold separately.

IF THE VEHICLE IS NOT EQUIPPED WITH FUNCTIONAL HOOD PIN:

	A11	OFF	Hood trigger (Output Status).
--	------------	------------	-------------------------------

	Program bypass option:	UNIT OPTION	DESCRIPTION
		C1	OEM Remote status (Lock/Unlock) monitoring
		D6	Push-to-Start

	Program bypass option (Vehicle hybrid only):	UNIT OPTION	DESCRIPTION
		D4	Hybrid mode (Vehicle hybrid only)



ATTENTION!



DATE: XX-XX

E5

SPECIAL FUNCTIONS: BY DEFAULT DEACTIVATED

MANUFACTURED MODULES BETWEEN: 04/2018 TO 04/2019

OFF

ON

 **Parts required (Not included)**

1X 1Amp Diode

MANDATORY INSTALL

***HOOD PIN**  **HOOD STATUS: THE HOOD PIN SWITCH MUST BE INSTALLED IF THE VEHICLE CAN BE REMOTE STARTED WITH THE HOOD OPEN, SET FUNCTION A11 TO OFF.**

A11	OFF
------------	------------

Notice: the installation of safety elements are mandatory. The hood pin is an essential security element and must be installed.

THIS MODULE MUST BE INSTALLED BY A QUALIFIED TECHNICIAN. A WRONG CONNECTION CAN CAUSE PERMANENT DAMAGE TO THE VEHICLE.

DESCRIPTION

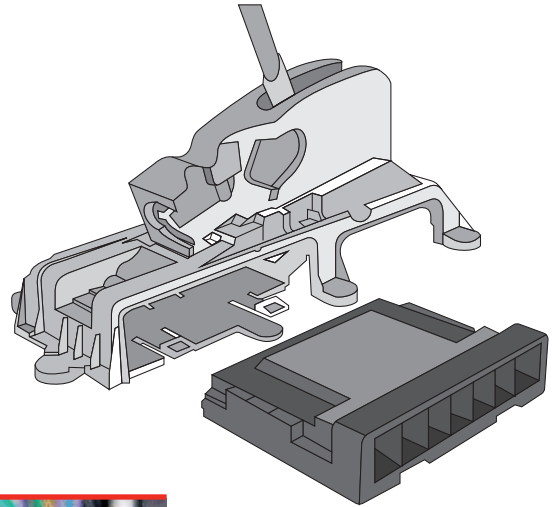

BCM

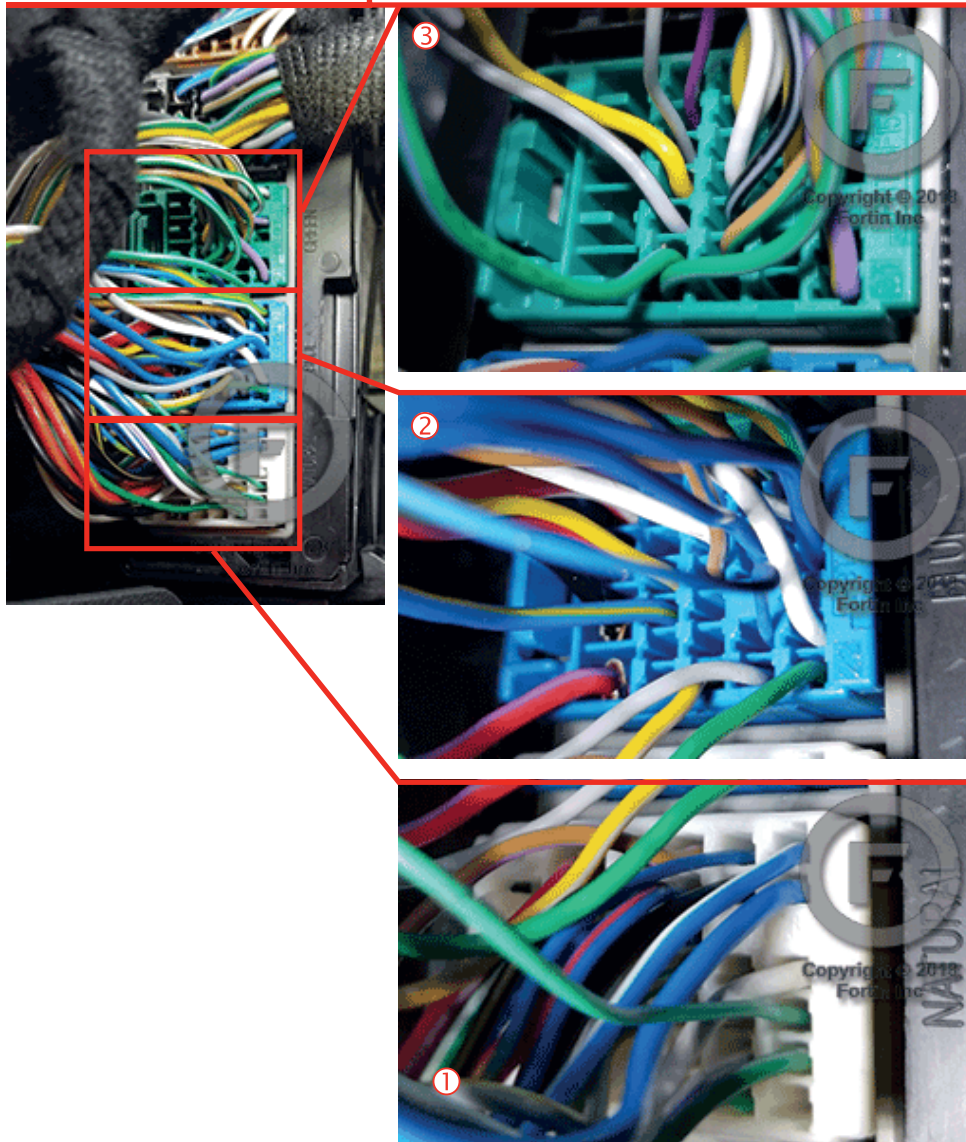

AUTOMATIC TRANSMISSION WIRING CONNECTION

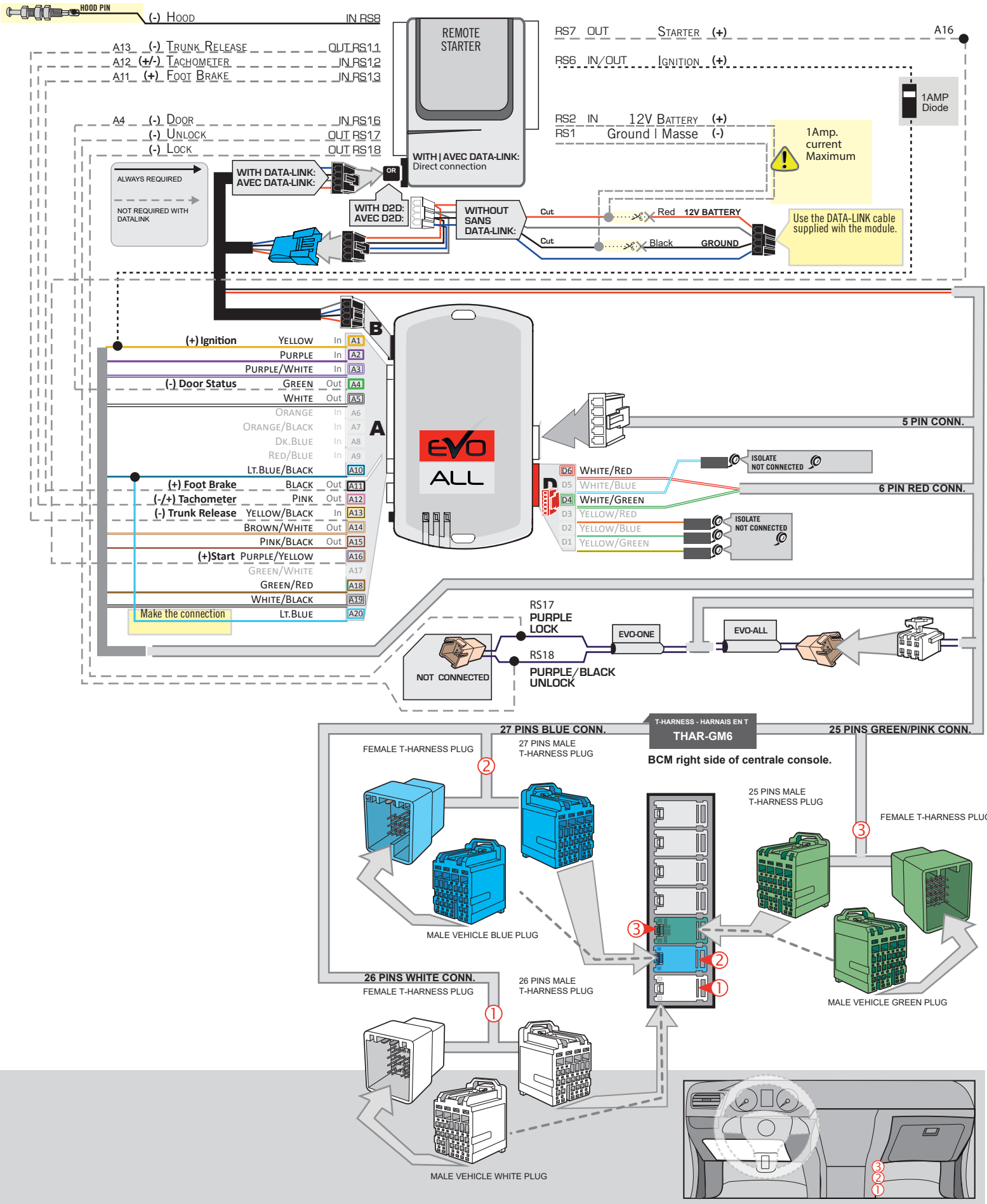

KEY BYPASS PROGRAMMING PROCEDURE 1/3



- 1** Remove the battery from the OEM remote.
- 2** Place the OEM remote into the center console.
Refer to vehicle user guide for keyport location.

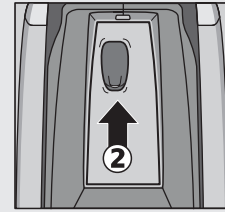

1

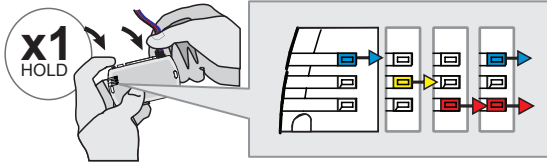

Press and hold the programming button:
Connect the 4-PIN Data-link harness (Black connector).

↳The Blue, Red, Yellow and Blue & Red LEDs will alternatively illuminate.

2

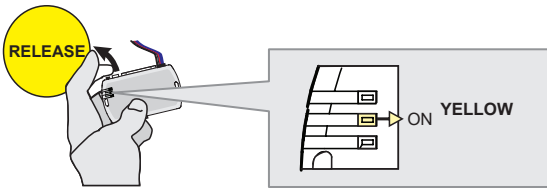

Release the programming button when the LED is YELLOW.

If the LED is not solid YELLOW disconnect the 4-Pin connector (Data-Link) and go back to step 1.

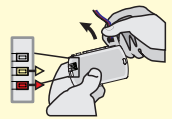

3

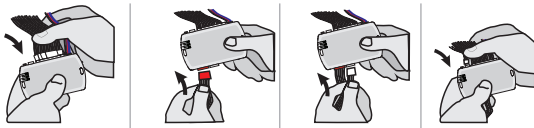

Insert the required remaining connectors.

4

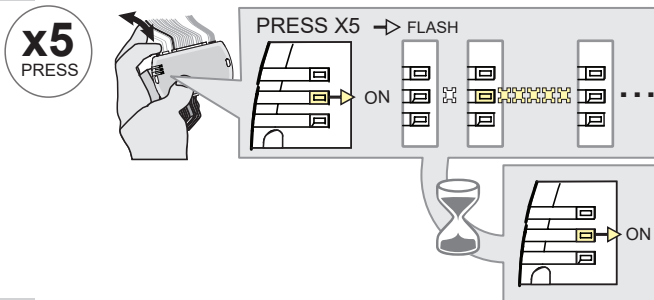

Press and release the programming button five (5x) times.

↳The YELLOW LED will flash 5 times each second.

↳**WAIT** for the YELLOW LED to turn ON solide.

5

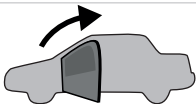

Open the driver door.

6

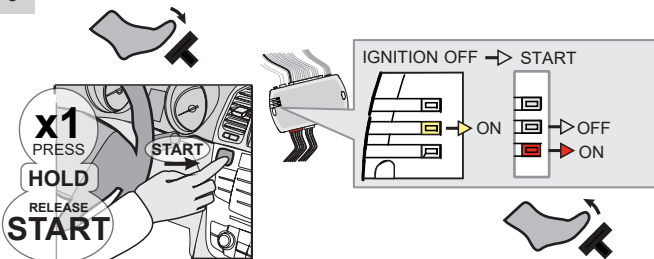

Press the foot-brake pedal.

Press the Push-to-Start button until the engine start.

Release the foot-brake pedal.

↳The RED LED will turn ON.
↳The YELLOW LED will turn OFF.

KEY BYPASS PROGRAMMING PROCEDURE 2/3

7



Press the Push-to-Start button until the engine turn OFF.

8

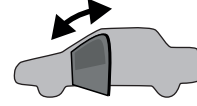

Close and open the driver door.

9

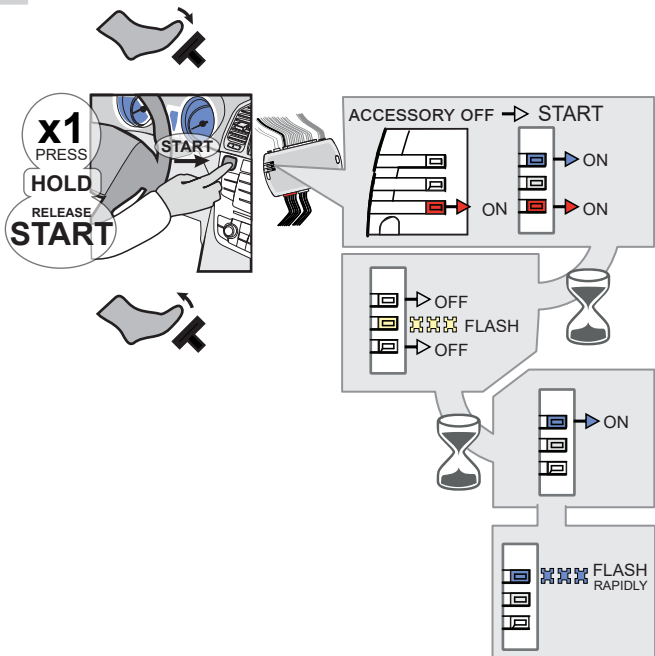

Press the foot-brake pedal.

Press the Push-to-Start button until the engine start.

Release the foot-brake pedal.

- ↳ The BLUE LED will turn ON.
- ↳ The BLUE LED will turn OFF. The RED LED will turn OFF.
- ↳ The YELLOW LED will flash rapidly
- ↳ The BLUE LED will turn ON.
- ↳ The BLUE LED will flash rapidly

10

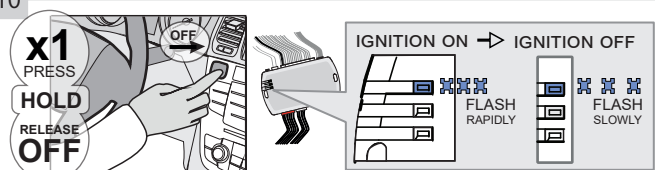

Press the Push-to-Start button until the engine turn OFF.

- ↳ The BLUE LED will flash slowly

11

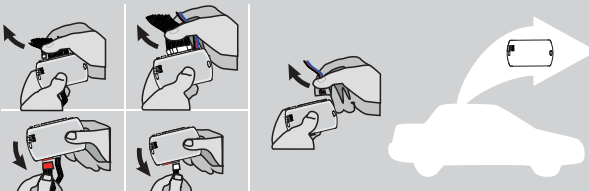

Disconnect all the connectors and after the Data-Link (4-pins) connector.

12

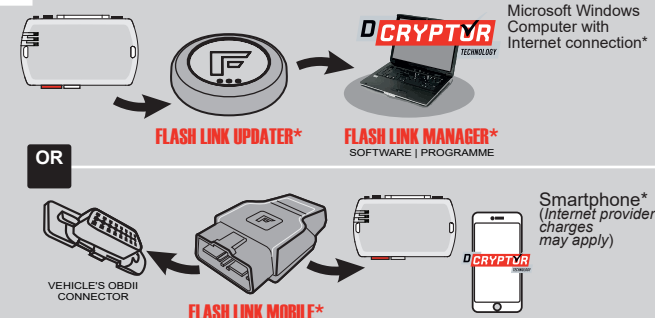

Use the tool: FLASH LINK UPDATER or FLASH LINK MOBILE to visit the DCRYPTOR menu.

***Parts required (not included)**

KEY BYPASS PROGRAMMING PROCEDURE 3/3

13

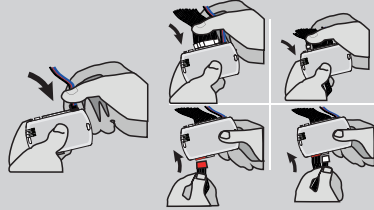
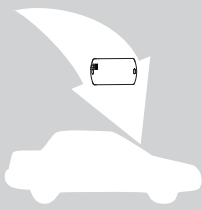

AFTER DCRYPTOR PROGRAMMING COMPLETED
Go back to the vehicle and **reconnect** the 4-Pin (Data-Link) connector and after, all the remaining connector.



The module is now programmed.



REMOTE STARTER / ALARM VERIFICATION PROCEDURE

Test the remote starter. Remote start the vehicle.

REMOTE STARTER FUNCTIONALITY



All doors must be closed.

Remote start the vehicle.



Press the Unlock button of the remote car starter or the OEM remote.

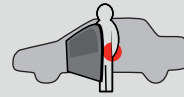

Enter the vehicle with the Intelligent Access Key.

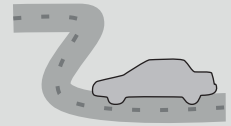

The vehicle can now be put in to gear and driven.



If the vehicle is not unlocked the module will shut down the remote-starter and the vehicle as soon as any door is opened.

THAR-GM6

THARNNESS INSTALLATION

ADDENDUM - SUGGESTED WIRING CONFIGURATION



Vehicle functions supported in this diagram (functional if equipped)

VEHICLE	YEARS	Immobilizer bypass	Lock	Unlock	Arm	Disarm	Trunk (open)	RAP Disable	Tachometer	Heated Seats	Door Status	Trunk Status (Data-Link Only,Data-Link Seule-ment)	Hand-Brake Status (Data-Link Only,Data-Link Seule-ment)	Foot-Brake Status	OEM Remote Monitoring
CADILLAC															
Escalade	Push-To-Start	2020-2021	•	•	•	•	•	•	•	•	•	•	•	•	•
XT4	Push-To-Start	2019-2021	•	•	•	•	•	•	•	•	•	•	•	•	•
XT5	Push-To-Start	2017-2021	•	•	•	•	•	•	•	•	•	•	•	•	•
XT6	Push-To-Start	2020-2021	•	•	•	•	•	•	•	•	•	•	•	•	•

FIRMWARE VERSION

70.[45]

GM MINIMUM

To add the firmware version and the options, use the **FLASH LINK UPDATER** or **FLASH LINK MOBILE** tool, sold separately.

	UNIT OPTION		DESCRIPTION
<p>Program bypass option:</p>	C1		OEM Remote status (Lock/Unlock) monitoring
	<p>IF THE VEHICLE IS NOT EQUIPPED WITH FUNCTIONAL HOOD PIN:</p>		
	A11	OFF	Hood trigger (Output Status).
	D6		Push-to-Start

ATTENTION!

DATE: XX-XX

E5

OFF

ON

SPECIAL FUNCTIONS: BY DEFAULT DEACTIVATED

MANUFACTURED MODULES BETWEEN: 04/2018 TO 04/2019

Parts required (Not included)

1X 1Amp Diode

MANDATORY INSTALL

*HOOD PIN



HOOD STATUS: THE HOOD PIN SWITCH MUST BE INSTALLED IF THE VEHICLE CAN BE REMOTE STARTED WITH THE HOOD OPEN, SET FUNCTION A11 TO OFF.

A11

OFF

Notice: the installation of safety elements are mandatory. The hood pin is an essential security element and must be installed.

THIS MODULE MUST BE INSTALLED BY A QUALIFIED TECHNICIAN. A WRONG CONNECTION CAN CAUSE PERMANENT DAMAGE TO THE VEHICLE.

DESCRIPTION

BCM located on passenger side center console



③

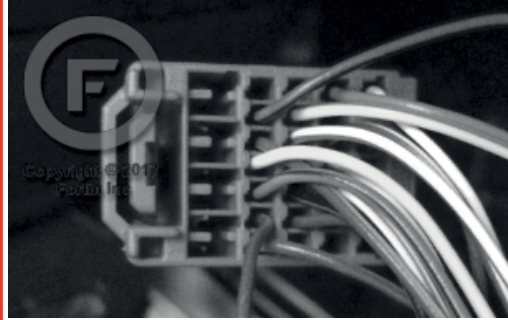

②

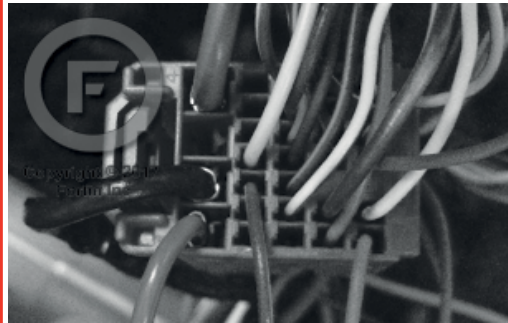

①

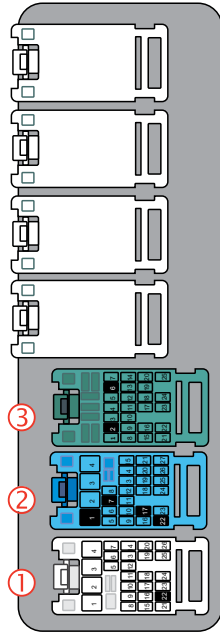

AUTOMATIC TRANSMISSION WIRING CONNECTION

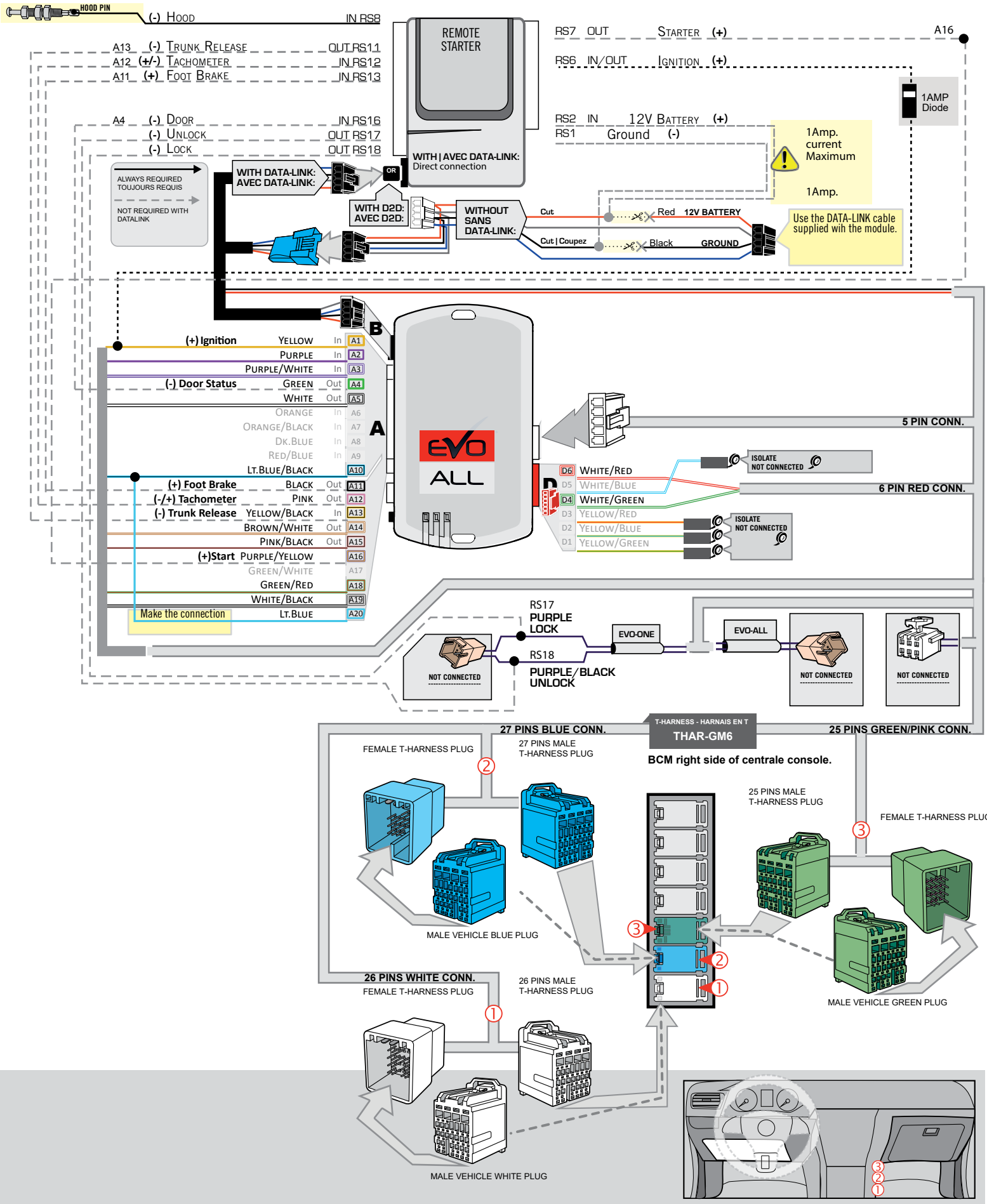

KEY BYPASS PROGRAMMING PROCEDURE 1/3

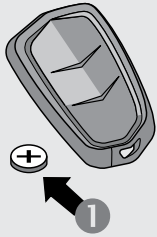

- 1 Remove the battery from the OEM remote.
- 2 Place the OEM remote into the transmitter pocket of the center console.
Refer to vehicle user guide for keyport location.

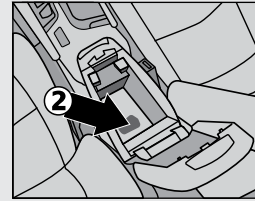

1

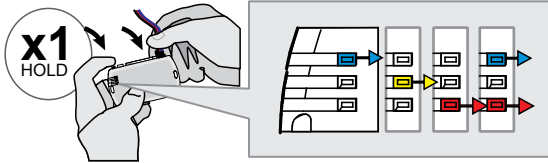

Press and hold the programming button:
Connect the 4-PIN Data-link harness (Black connector).

↳The Blue, Red, Yellow and Blue & Red LEDs will alternatively illuminate.

2

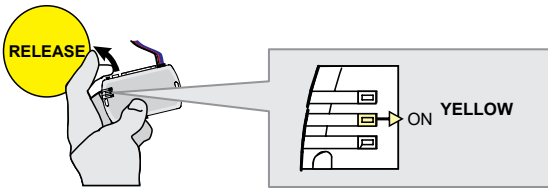

Release the programming button when the LED is YELLOW.

If the LED is not solid YELLOW disconnect the 4-Pin connector (Data-Link) and go back to step 1.

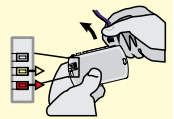

3

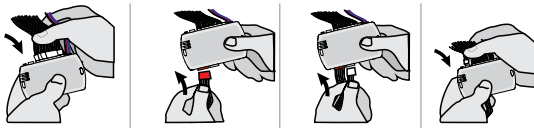

Insert the required remaining connectors.

4

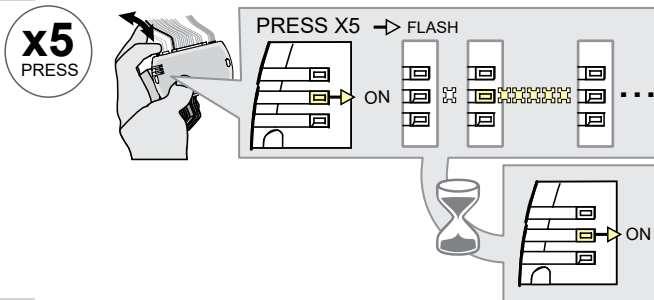

Press and release the programming button five (5x) times.

↳The YELLOW LED will flash 5 times each second.

↳**WAIT** for the YELLOW LED to turn ON solide.

5

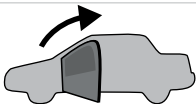

Open the driver door.

6

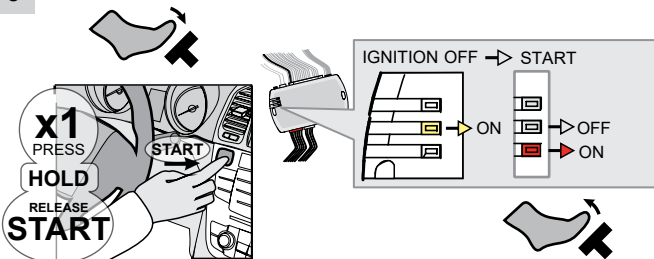

Press the foot-brake pedal.

Press the Push-to-Start button until the engine start.

Release the foot-brake pedal.

↳The RED LED will turn ON.
↳The YELLOW LED will turn OFF.

KEY BYPASS PROGRAMMING PROCEDURE 2/3

7



Press the Push-to-Start button until the engine turn OFF.

8

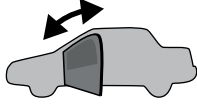

Close and open the driver door.

9



Press the foot-brake pedal.

Press the Push-to-Start button until the engine start.

Release the foot-brake pedal.

ACCESSORY OFF → START

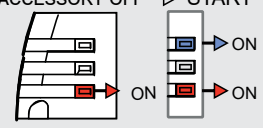

→ OFF

FLASH

→ OFF



→ ON

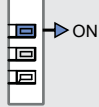

↳ The BLUE LED will turn ON.

↳ The BLUE LED will turn OFF. The RED LED will turn OFF.

↳ The YELLOW LED will flash rapidly

↳ The BLUE LED will turn ON.

FLASH RAPIDLY

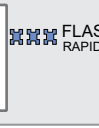

↳ The BLUE LED will flash rapidly

10



Press the Push-to-Start button until the engine turn OFF.

IGNITION ON → IGNITION OFF

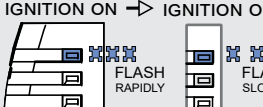

FLASH SLOWLY



↳ The BLUE LED will flash slowly

11

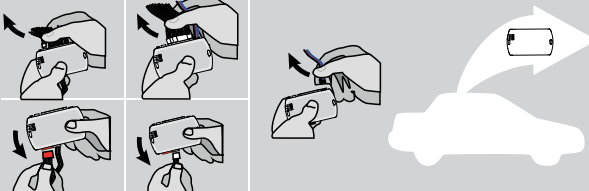

Disconnect all the connectors and after the Data-Link (4-pins) connector.

12



FLASH LINK UPDATER*



Microsoft Windows Computer with Internet connection*

FLASH LINK MANAGER*

SOFTWARE | PROGRAMME

OR

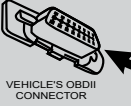

VEHICLE'S OBDII CONNECTOR

FLASH LINK MOBILE*



Smartphone* (Internet provider charges may apply)

FLASH LINK MOBILE*

Use the tool: FLASH LINK UPDATER or FLASH LINK MOBILE to visit the DCryptor menu.

*Parts required (not included)

KEY BYPASS PROGRAMMING PROCEDURE 3/3

13

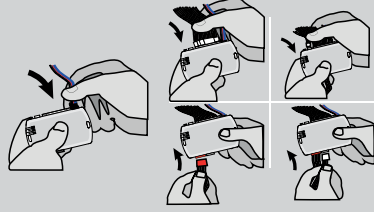
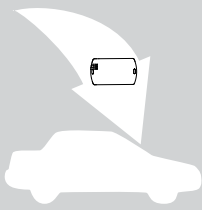

AFTER DCRYPTOR PROGRAMMING COMPLETED
Go back to the vehicle and **reconnect** the 4-Pin (Data-Link) connector and after, all the remaining connector.



The module is now programmed.



REMOTE STARTER / ALARM VERIFICATION PROCEDURE

Test the remote starter. Remote start the vehicle.

REMOTE STARTER FUNCTIONALITY



All doors must be closed.

Remote start the vehicle.



Press the Unlock button of the remote car starter.

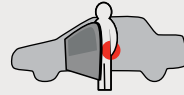

Enter the vehicle with the Intelligent Access Key.

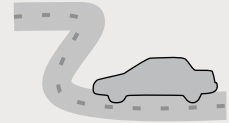

The vehicle can now be put in to gear and driven.



If the vehicle is not unlocked the module will shut down the remote-starter and the vehicle as soon as any door is opened.

THARNESS STAND ALONE INSTALLATION

THAR-GM6

ADDENDUM - SUGGESTED WIRING CONFIGURATION



ONLY COMPATIBLE WITH AUTOMATIC TRANSMISSION VEHICLES.



Vehicle functions supported in this diagram (functional if equipped)

VEHICLE	YEARS	Immobilizer bypass	Lock	Unlock	Arm	Disarm	Trunk (open)	RAP Disable	Tachometer	Door Status	Trunk Status	Hand-Brake Status	Foot-Brake Status	OEM Remote Monitoring
GMC														
Acadia	Push-To-Start	2017-2020	•	•	•	•	•	•	•	•	•	•	•	•

FIRMWARE VERSION

70.[41]

GM MINIMUM

To add the firmware version and the options, use the **FLASH LINK UPDATER** or **FLASH LINK MOBILE** tool, sold separately.

<p>IF THE VEHICLE IS NOT EQUIPPED WITH FUNCTIONAL HOOD PIN:</p>	A11	OFF	Hood trigger (Output Status).
--	------------	------------	-------------------------------

	<p>Program bypass option:</p>	UNIT OPTION	DESCRIPTION
		C1	OEM Remote status (Lock/Unlock) monitoring

	<p>Program bypass option:</p>	UNIT OPTION	DESCRIPTION
		D6	Push-to-Start

ATTENTION!

DATE: XX-XX

E5

OFF

ON

SPECIAL FUNCTIONS: BY DEFAULT DEACTIVATED

MANUFACTURED MODULES BETWEEN: 04/2018 TO 04/2019

- Parts required (Not included)**
- 1X 5 Amp Fuse
 - 1X 1k Ohm Resistor

MANDATORY INSTALL

*HOOD PIN



HOOD STATUS: THE HOOD PIN SWITCH MUST BE INSTALLED IF THE VEHICLE CAN BE REMOTE STARTED WITH THE HOOD OPEN, SET FUNCTION A11 TO OFF.

A11

OFF

Notice: the installation of safety elements are mandatory. The hood pin is an essential security element and must be installed.

THIS MODULE MUST BE INSTALLED BY A QUALIFIED TECHNICIAN. A WRONG CONNECTION CAN CAUSE PERMANENT DAMAGE TO THE VEHICLE.

PARTS REQUIRED (NOT INCLUDED)

1x **FLASH LINK UPDATER**
 1x **FLASH LINK MANAGER**
SOFTWARE | PROGRAMME
 1x Microsoft Windows Computer with Internet connection

OR

1x **FLASH LINK MOBILE**
 1x **FLASH LINK MOBILE APP**
Smartphone Android or iOS with Internet connection (provider charges may apply).

MANDATORY

HOOD PIN 

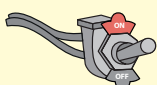



REMOTE START SAFETY OVERRIDE SWITCH 

VALET SWITCH

Part #: RSPB available, Sold separately.

Notice: the installation of safety elements are mandatory. The hood pin and the valet switch are essential security elements and must be installed.

STAND ALONE CONFIGURATION

	Program bypass option	UNIT OPTION	DESCRIPTION
	OEM Remote Stand Alone Remote Starter:	D1.10 	By default, LOCK, LOCK, LOCK
		D1.1 	Par défaut, VERROUILLE,VERROUILLE,VERROUILLE
	Program bypass option with oem remote:	C1	OEM Remote Monitoring
	Program bypass option with RF KIT antenna:	H1 to H6	Supported RF Kits and select RF Kit

REMOTE STARTER FUNCTIONALITY



All doors must be closed.

3X 

Press the OEM remote's Lock button 3x to remote-start (or remote-stop) the vehicle.



START 

The vehicle will START.

REMOTE STARTER DIAGNOSTICS
MODULE RED LED

x2 flash :	Brake ON
x3 flash :	No tach
x4 flash :	Ignition before start
x5 flash :	Hood Open

REMOTE STARTER WARNING CARD



CUT THIS WARNING CARD AND STICK IT ON A VISIBLE PLACE:
 or use the package RSPB, Sold separately.

WARNING



REMOTE STARTER

THE VEHICLE CAN BE STARTED BY EITHER: PRESSING THE LOCK BUTTON ON THE OEM REMOTE 3 TIMES CONSECUTIVELY OR BY A SMARTPHONE. **TURN ON** THE SAFETY SWITCH LOCATED UNDER THE DASHBOARD BEFORE WORKING ON THE VEHICLE.

DESCRIPTION

BCM located on passenger side center console



③



②

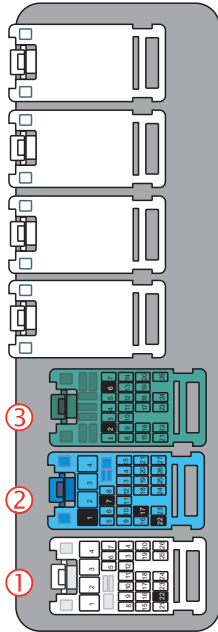
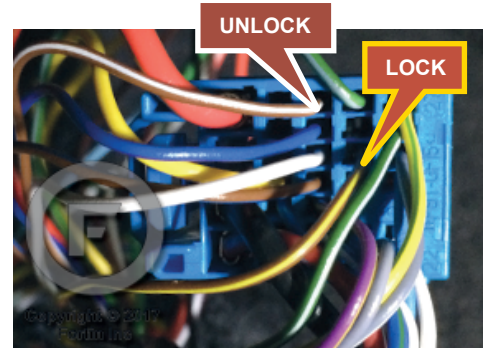
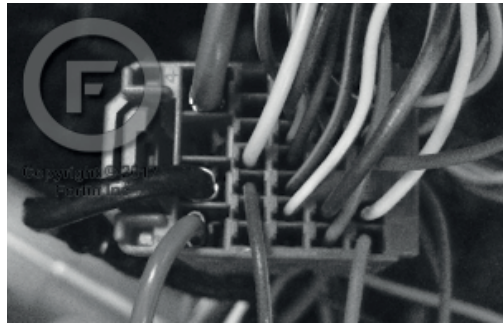

①



AUTOMATIC TRANSMISSION WIRING CONNECTION

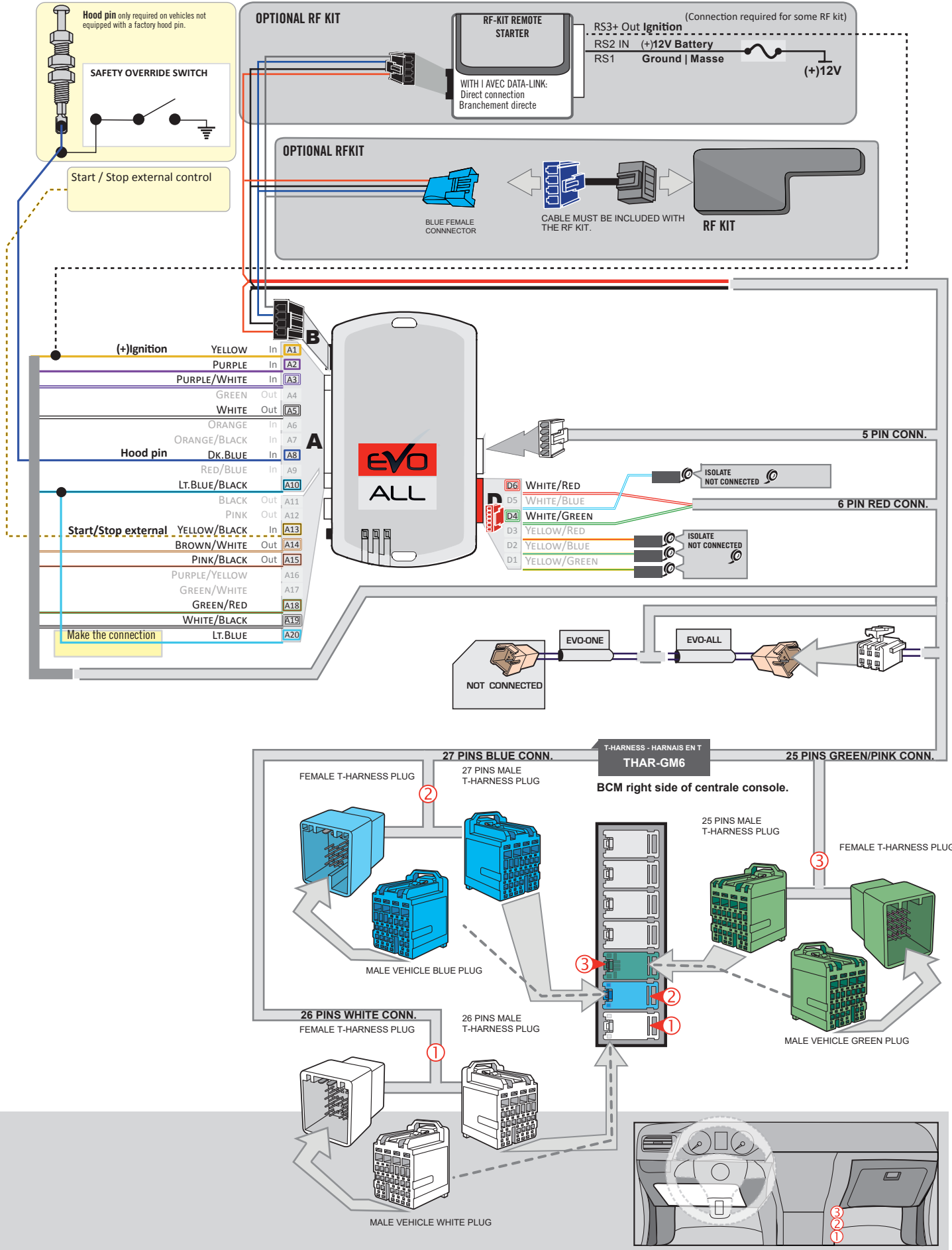

KEY BYPASS PROGRAMMING PROCEDURE 1/3

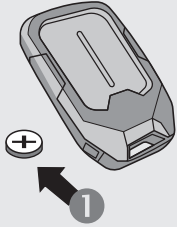

1 Remove the battery from the OEM remote.

2 Place the OEM remote into the transmitter pocket of the center console.

Refer to vehicle user guide for keyport location.

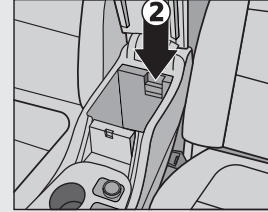

1

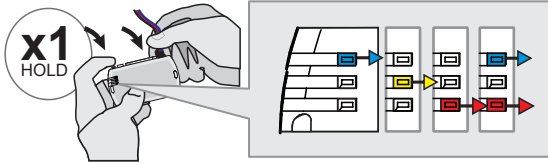

Press and hold the programming button:
Connect the 4-PIN Data-link harness (Black connector).

↳The Blue, Red, Yellow and Blue & Red LEDs will alternatively illuminate.

2

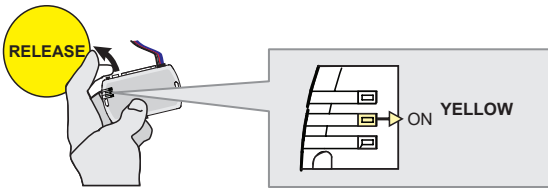

Release the programming button when the LED is **YELLOW**.

If the LED is not solid YELLOW disconnect the 4-Pin connector (Data-Link) and go back to step 1.

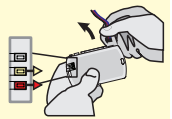

3

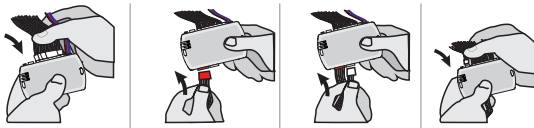

Insert the required remaining connectors.

4

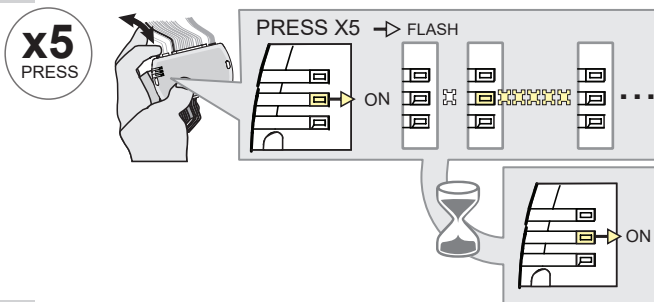

Press and release the programming button five (5x) times.

↳The YELLOW LED will flash 5 times each second.

↳WAIT for the YELLOW LED to turn ON solide.

5

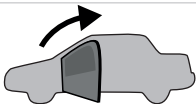

Open the driver door.

6

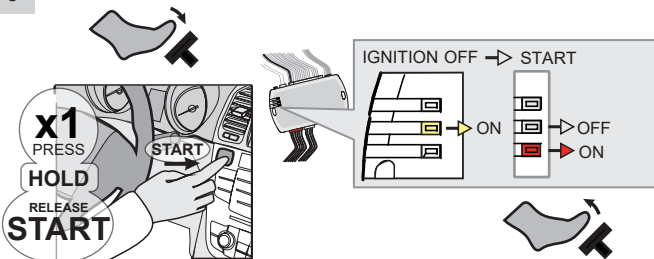

Press the foot-brake pedal.

Press the Push-to-Start button until the engine start.

Release the foot-brake pedal.

*↳The RED LED will turn ON.
↳The YELLOW LED will turn OFF.*

KEY BYPASS PROGRAMMING PROCEDURE 2/3

7



Press the Push-to-Start button until the engine turn OFF.

8

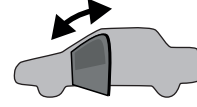

Close and open the driver door.

9

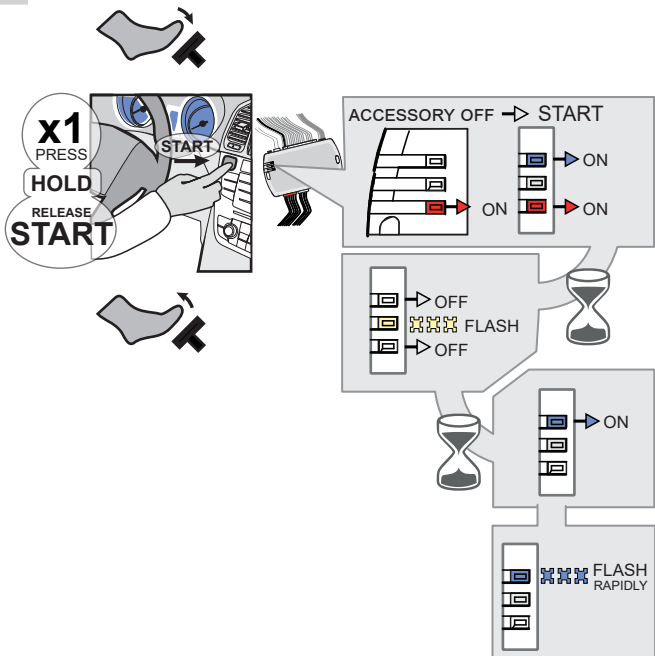

Press the foot-brake pedal.

Press the Push-to-Start button until the engine start.

Release the foot-brake pedal.

- ↳ The BLUE LED will turn ON.
- ↳ The BLUE LED will turn OFF. The RED LED will turn OFF.
- ↳ The YELLOW LED will flash rapidly
- ↳ The BLUE LED will turn ON.
- ↳ The BLUE LED will flash rapidly

10

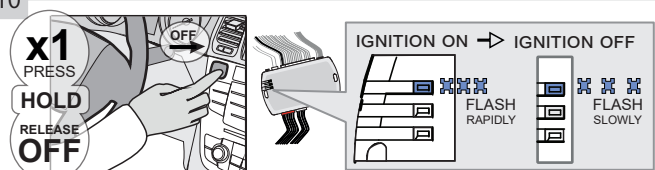

Press the Push-to-Start button until the engine turn OFF.

- ↳ The BLUE LED will flash slowly

11

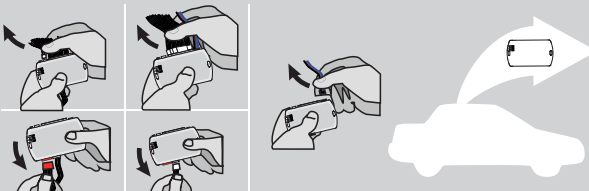

Disconnect all the connectors and after the Data-Link (4-pins) connector.

12

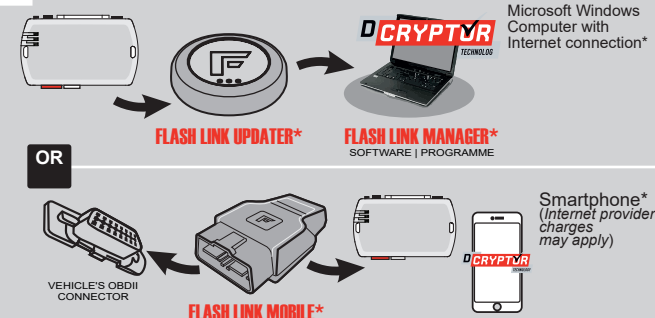

Use the tool: FLASH LINK UPDATER or FLASH LINK MOBILE to visit the DCRYPTOR menu.

***Parts required (not included)**

KEY BYPASS PROGRAMMING PROCEDURE 3/3

13

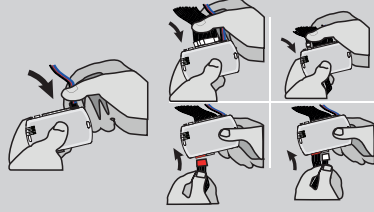
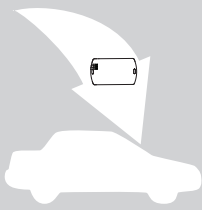

AFTER DCRYPTOR PROGRAMMING COMPLETED
Go back to the vehicle and **reconnect** the 4-Pin (Data-Link) connector and after, all the remaining connector.



The module is now programmed.



REMOTE STARTER / ALARM VERIFICATION PROCEDURE

Test the remote starter. Remote start the vehicle.

REMOTE STARTER FUNCTIONALITY



All doors must be closed.

Remote start the vehicle.



Press the Unlock button of the remote car starter.



Enter the vehicle with the Intelligent Access Key.



The vehicle can now be put in to gear and driven.



If the vehicle is not unlocked the module will shut down the remote-starter and the vehicle as soon as any door is opened.

THARNESS STAND ALONE INSTALLATION

THAR-GM6

ADDENDUM - SUGGESTED WIRING CONFIGURATION



ONLY COMPATIBLE WITH AUTOMATIC TRANSMISSION VEHICLES.



VEHICLE	YEARS	Vehicle functions supported in this diagram (functional if equipped)														
		Immobilizer bypass	T-Harness	Lock	Unlock	Arm	Disarm	Trunk (open)	RAP Disable	Tachometer	Heated Seats	Door Status	Trunk Status	Hand-Brake Status	Foot-Brake Status	OEM Remote Monitoring
CHEVROLET																
Bolt	Push-To-Start	2016-2019	•	•	•	•	•	•	•	•	•	•	•	•	•	•

FIRMWARE VERSION

70.[41]

GM MINIMUM

To add the firmware version and the options, use the **FLASH LINK UPDATER** or **FLASH LINK MOBILE** tool, sold separately.

IF THE VEHICLE IS NOT EQUIPPED WITH FUNCTIONAL HOOD PIN:	A11	OFF	Hood trigger (Output Status).
--	-----	-----	-------------------------------

	UNIT OPTION	DESCRIPTION
<p>Program bypass option:</p>	C1	OEM Remote status (Lock/Unlock) monitoring
	D6	Push-to-Start

	UNIT OPTION	DESCRIPTION
<p>Program bypass option (Vehicle hybrid only):</p>	D4	Hybrid mode (Vehicle hybrid only)

	ATTENTION!	<p>DATE: XX-XX</p>	OFF	<p>SPECIAL FUNCTIONS: BY DEFAULT DEACTIVATED</p>
			ON	<p>MANUFACTURED MODULES BETWEEN: 04/2018 TO 04/2019</p>

- Parts required (Not included)**
- 1X 5 Amp Fuse
 - 1X 1k Ohm Resistor

MANDATORY INSTALL

***HOOD PIN** **HOOD STATUS:** THE HOOD PIN SWITCH MUST BE INSTALLED IF THE VEHICLE CAN BE REMOTE STARTED WITH THE HOOD OPEN, SET FUNCTION A11 TO OFF.

A11	OFF
-----	-----

Notice: the installation of safety elements are mandatory. The hood pin is an essential security element and must be installed.

THIS MODULE MUST BE INSTALLED BY A QUALIFIED TECHNICIAN. A WRONG CONNECTION CAN CAUSE PERMANENT DAMAGE TO THE VEHICLE.

PARTS REQUIRED (NOT INCLUDED)

1x **FLASH LINK UPDATER,**
 1x **FLASH LINK MANAGER**
 SOFTWARE | PROGRAMME
 1x Microsoft Windows Computer with Internet connection

OR

1x **FLASH LINK MOBILE**
 1x **FLASH LINK MOBILE APP**
 Smartphone *Android* or *iOS* with Internet connection (*provider charges may apply*).

MANDATORY

HOOD PIN



REMOTE START SAFETY OVERRIDE SWITCH

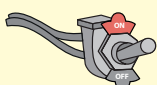





VALET SWITCH

Part #: RSPB available, Sold separately.

Notice: the installation of safety elements are mandatory. The hood pin and the valet switch are essential security elements and must be installed.

STAND ALONE CONFIGURATION

	Program bypass option	UNIT OPTION	DESCRIPTION
	OEM Remote Stand Alone Remote Starter:	D1.10 	By default, LOCK, LOCK, LOCK
		D1.1 	Par défaut, VERROUILLE,VERROUILLE,VERROUILLE
	Program bypass option with oem remote:	C1	OEM Remote Monitoring
	Program bypass option with RF KIT antenna:	H1 to H6	Supported RF Kits and select RF Kit

REMOTE STARTER FUNCTIONALITY



All doors must be closed.

3X 

Press the OEM remote's Lock button 3x to remote-start (or remote-stop) the vehicle.



The vehicle will START.

REMOTE STARTER DIAGNOSTICS
MODULE RED LED

x2 flash :	Brake ON
x3 flash :	No tach
x4 flash :	Ignition before start
x5 flash :	Hood Open

REMOTE STARTER WARNING CARD



CUT THIS WARNING CARD AND STICK IT ON A VISIBLE PLACE:
 or use the package RSPB, Sold separately.

WARNING



REMOTE STARTER

THE VEHICLE CAN BE STARTED BY EITHER: PRESSING THE LOCK BUTTON ON THE OEM REMOTE 3 TIMES CONSECUTIVELY OR BY A SMARTPHONE. **TURN ON** THE SAFETY SWITCH LOCATED UNDER THE DASHBOARD BEFORE WORKING ON THE VEHICLE.

DESCRIPTION



BCM

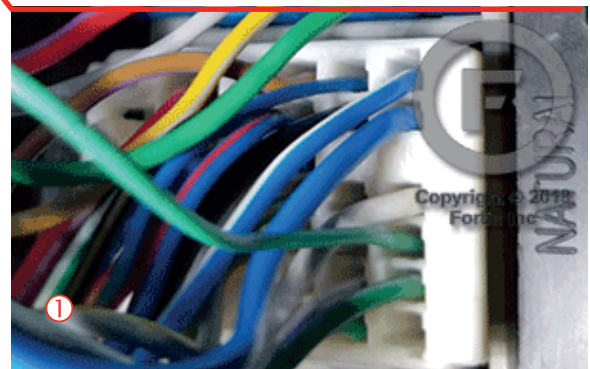
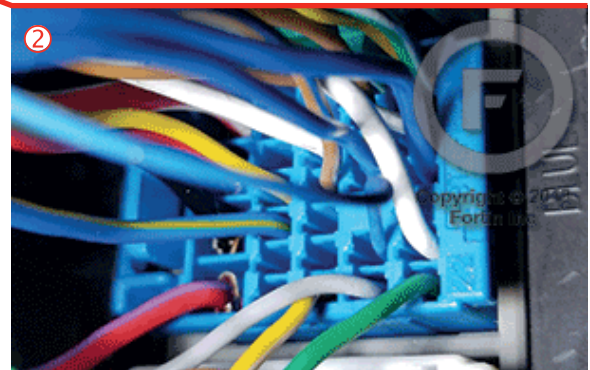
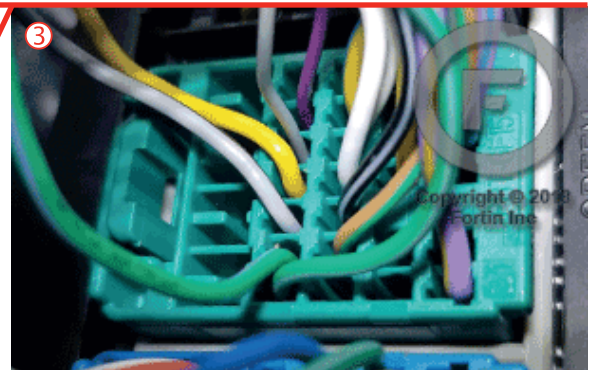
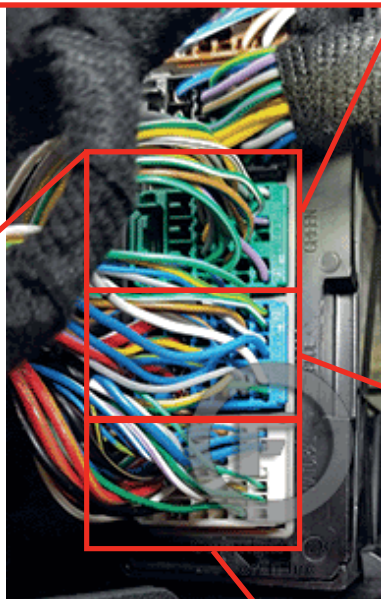
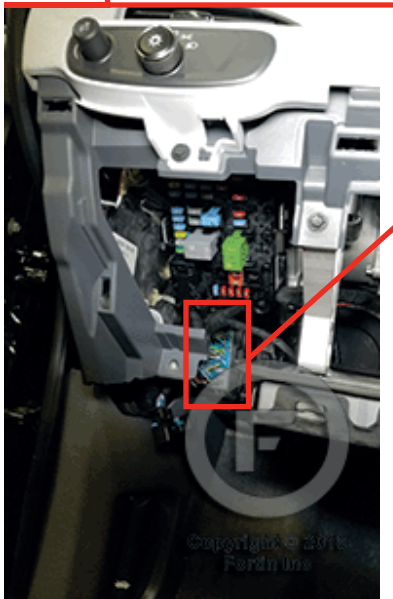

AUTOMATIC TRANSMISSION WIRING CONNECTION

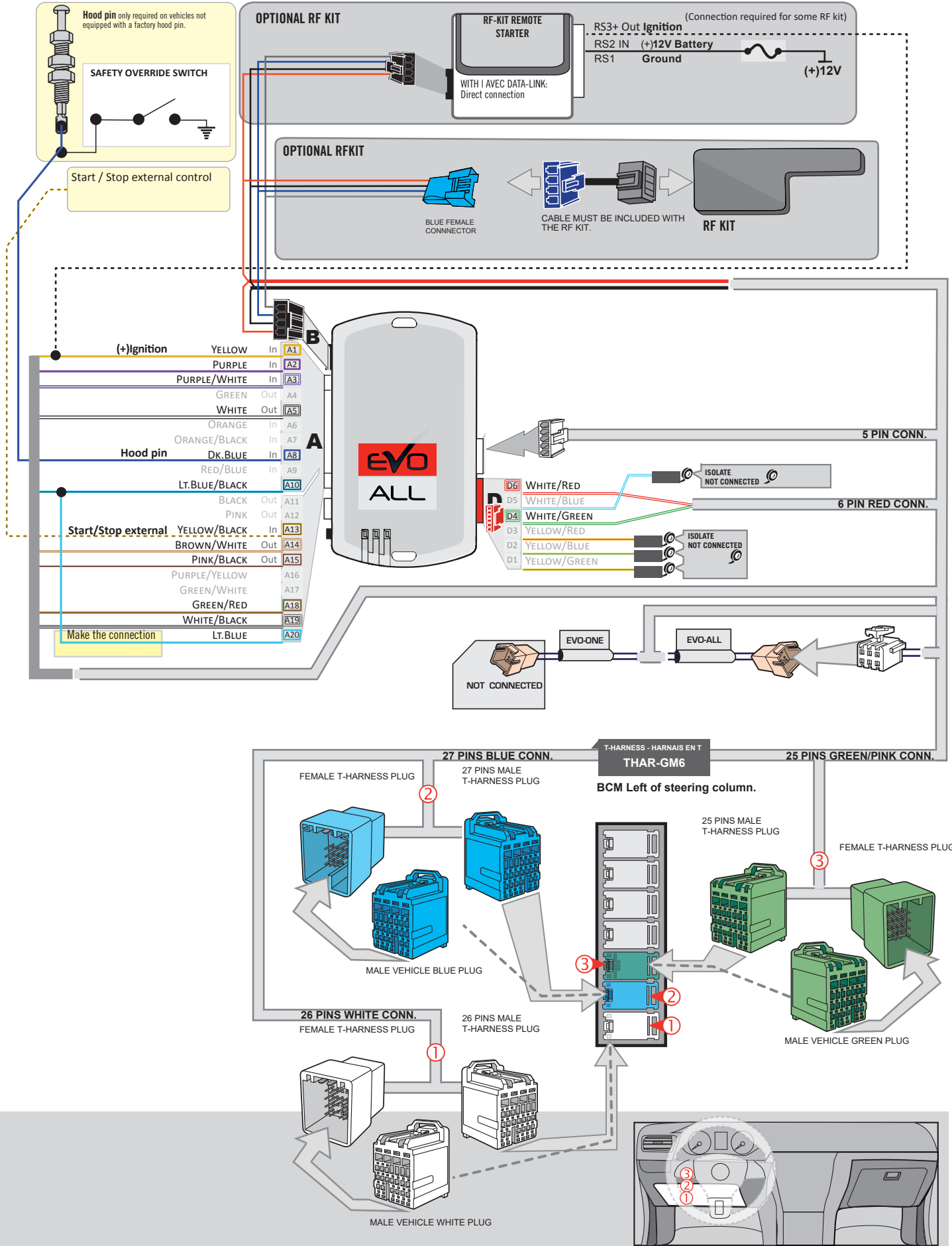

KEY BYPASS PROGRAMMING PROCEDURE 1/3



- 1** Remove the battery from the OEM remote.
- 2** Place the OEM remote into the center console.
Refer to vehicle user guide for keyport location.

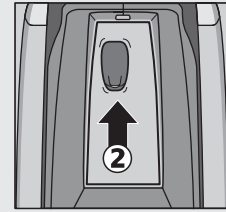

1

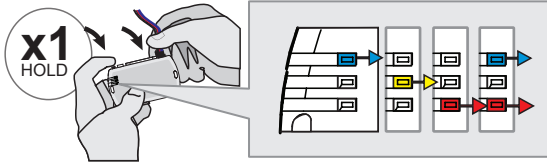

Press and hold the programming button:
Connect the 4-PIN Data-link harness (Black connector).

↳The Blue, Red, Yellow and Blue & Red LEDs will alternatively illuminate.

2

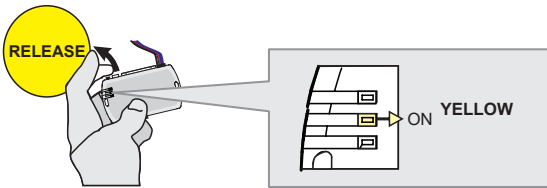

Release the programming button when the LED is YELLOW.

If the LED is not solid YELLOW disconnect the 4-Pin connector (Data-Link) and go back to step 1.

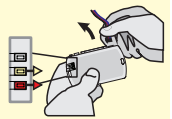

3

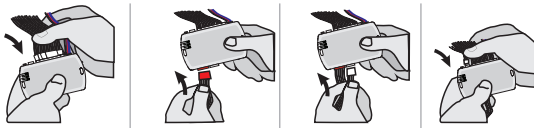

Insert the required remaining connectors.

4

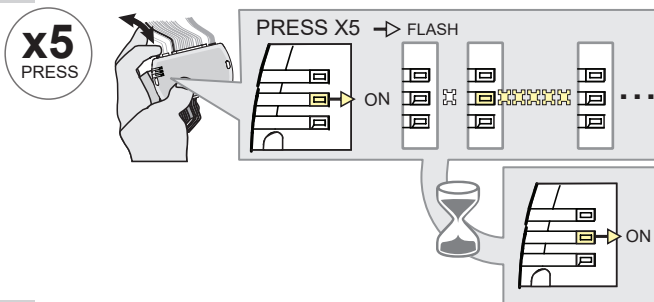

Press and release the programming button five (5x) times.

↳The YELLOW LED will flash 5 times each second.

↳**WAIT** for the YELLOW LED to turn ON solide.

5

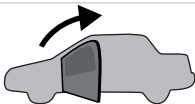

Open the driver door.

6

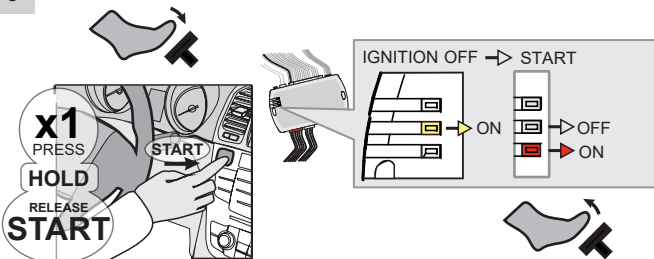

Press the foot-brake pedal.

Press the Push-to-Start button until the engine start.

Release the foot-brake pedal.

↳The RED LED will turn ON.
↳The YELLOW LED will turn OFF.

KEY BYPASS PROGRAMMING PROCEDURE 2/3

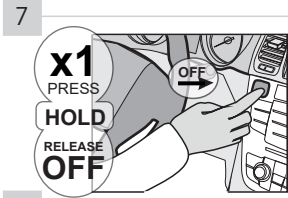

Press the Push-to-Start button until the engine turn OFF.

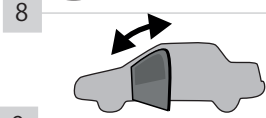

Close and open the driver door.

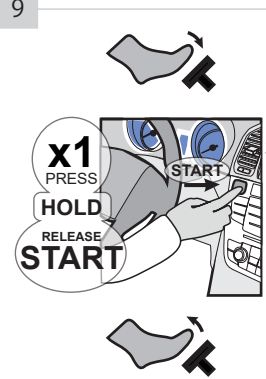

Press the foot-brake pedal.

Press the Push-to-Start button until the engine start.

Release the foot-brake pedal.

↳ The BLUE LED will turn ON.

↳ The BLUE LED will turn OFF. The RED LED will turn OFF.

↳ The YELLOW LED will flash rapidly

↳ The BLUE LED will turn ON.

↳ The BLUE LED will flash rapidly

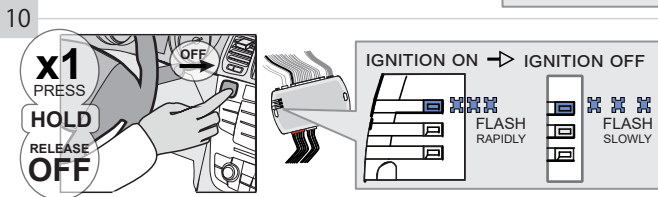

Press the Push-to-Start button until the engine turn OFF.

↳ The BLUE LED will flash slowly

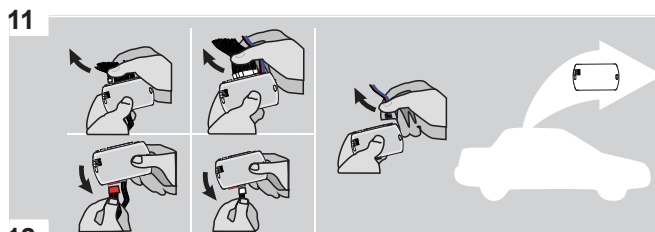

Disconnect all the connectors and after the Data-Link (4-pins) connector.

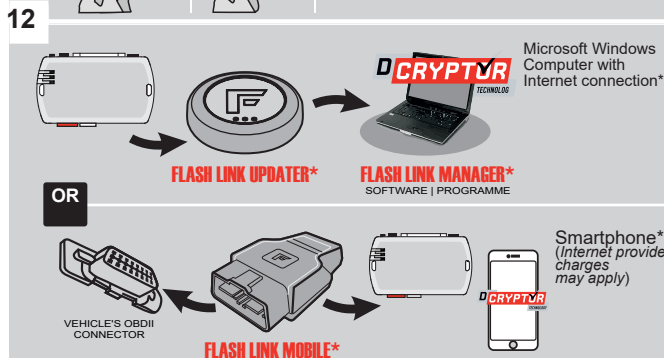

Use the tool: FLASH LINK UPDATER or FLASH LINK MOBILE to visit the DCryptor menu.

*Parts required (not included)

KEY BYPASS PROGRAMMING PROCEDURE 3/3

13

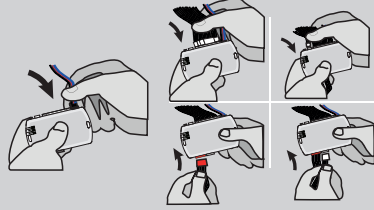
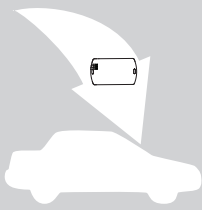

AFTER DCRYPTOR PROGRAMMING COMPLETED
Go back to the vehicle and **reconnect** the 4-Pin (Data-Link) connector and after, all the remaining connector.



The module is now programmed.



REMOTE STARTER / ALARM VERIFICATION PROCEDURE

Test the remote starter. Remote start the vehicle.

REMOTE STARTER FUNCTIONALITY



All doors must be closed.

Remote start the vehicle.



Press the Unlock button of the remote car starter or the OEM remote.



Enter the vehicle with the Intelligent Access Key.

The vehicle can now be put in to gear and driven.



If the vehicle is not unlocked the module will shut down the remote-starter and the vehicle as soon as any door is opened.

THAR-GM6

THARNNESS STAND ALONE INSTALLATION

ADDENDUM - SUGGESTED WIRING CONFIGURATION



ONLY COMPATIBLE WITH AUTOMATIC TRANSMISSION VEHICLES.



Vehicle functions supported in this diagram (functional if equipped)

VEHICLE	YEARS	Immobilizer bypass	Lock	Unlock	Arm	Disarm	Parking Lights	Trunk (open)	RAP Disable	Tachometer	Heated Seats	Door Status	Trunk Status	Hand-Brake Status	Foot-Brake Status	OEM Remote Monitoring
CADILLAC																
CT6	Push-To-Start	2016-2018	•	•	•	•	•	•	•	•	•	•	•	•	•	•

FIRMWARE VERSION

70.[41]

GM MINIMUM

To add the firmware version and the options, use the **FLASH LINK UPDATER** or **FLASH LINK MOBILE** tool, sold separately.

<p>IF THE VEHICLE IS NOT EQUIPPED WITH FUNCTIONAL HOOD PIN:</p>	A11	OFF	Hood trigger (Output Status).
--	------------	------------	-------------------------------

	Program bypass option:	UNIT OPTION	DESCRIPTION
		C1	OEM Remote status (Lock/Unlock) monitoring

	Program bypass option:	UNIT OPTION	DESCRIPTION
		D6	Push-to-Start

	ATTENTION!	E5	OFF	<p>SPECIAL FUNCTIONS: BY DEFAULT DEACTIVATED</p> <p>MANUFACTURED MODULES BETWEEN: 04/2018 TO 04/2019</p>
--	-------------------	-----------	------------	--

Parts required (Not included)
1X THAR-GM6

MANDATORY INSTALL

***HOOD PIN** **HOOD STATUS: THE HOOD PIN SWITCH MUST BE INSTALLED IF THE VEHICLE CAN BE REMOTE STARTED WITH THE HOOD OPEN, SET FUNCTION A11 TO OFF.**

A11

OFF

Notice: the installation of safety elements are mandatory. The hood pin is an essential security element and must be installed.

THIS MODULE MUST BE INSTALLED BY A QUALIFIED TECHNICIAN. A WRONG CONNECTION CAN CAUSE PERMANENT DAMAGE TO THE VEHICLE.

PARTS REQUIRED (NOT INCLUDED)

1x **FLASH LINK UPDATER,**
 1x **FLASH LINK MANAGER**
 SOFTWARE | PROGRAMME
 1x Microsoft Windows Computer with Internet connection

OR

1x **FLASH LINK MOBILE**
 1x **FLASH LINK MOBILE APP**
 Smartphone *Android* or *iOS* with Internet connection (*provider charges may apply*).

MANDATORY

HOOD PIN



REMOTE START SAFETY OVERRIDE SWITCH

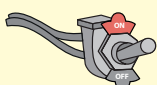





VALET SWITCH

Part #: RSPB available, Sold separately.

Notice: the installation of safety elements are mandatory. The hood pin and the valet switch are essential security elements and must be installed.

STAND ALONE CONFIGURATION

	Program bypass option	UNIT OPTION	DESCRIPTION
	OEM Remote Stand Alone Remote Starter:	D1.10 	By default, LOCK, LOCK, LOCK Par défaut, VERROUILLE, VERROUILLE, VERROUILLE
		D1.1 	
	Program bypass option with oem remote:	C1	OEM Remote Monitoring
	Program bypass option with RF KIT antenna:	H1 to H6	Supported RF Kits and select RF Kit

REMOTE STARTER FUNCTIONALITY



All doors must be closed.

3X 

Press the OEM remote's Lock button 3x to remote-start (or remote-stop) the vehicle.



The vehicle will START.

REMOTE STARTER DIAGNOSTICS
MODULE RED LED

x2 flash :	Brake ON
x3 flash :	No tach
x4 flash :	Ignition before start
x5 flash :	Hood Open

REMOTE STARTER WARNING CARD



CUT THIS WARNING CARD AND STICK IT ON A VISIBLE PLACE:
 or use the package **RSPB**, Sold separately.

WARNING | ATTENTION

REMOTE STARTER

THE VEHICLE CAN BE STARTED BY EITHER: PRESSING THE LOCK BUTTON ON THE OEM REMOTE 3 TIMES CONSECUTIVELY OR BY A SMARTPHONE. **TURN ON** THE SAFETY SWITCH LOCATED UNDER THE DASHBOARD BEFORE WORKING ON THE VEHICLE.

DESCRIPTION

BCM

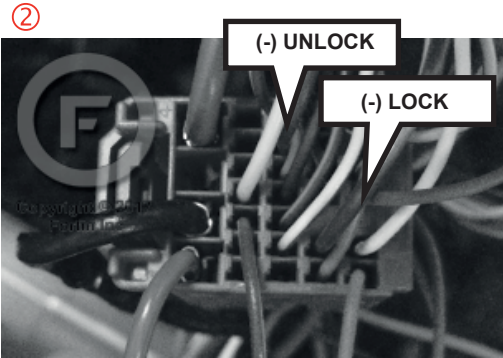
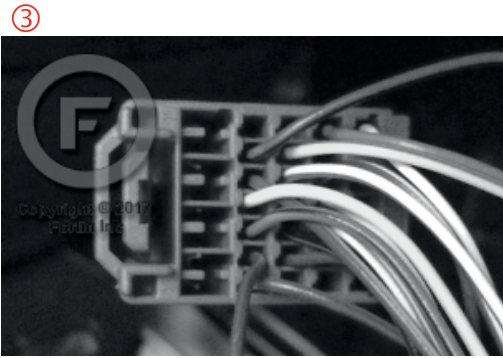
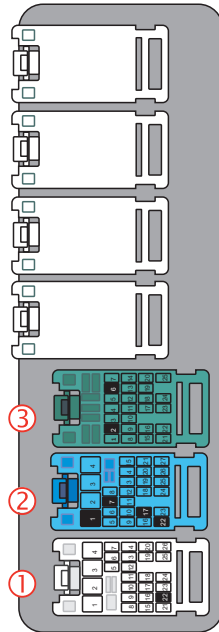

AUTOMATIC TRANSMISSION WIRING CONNECTION

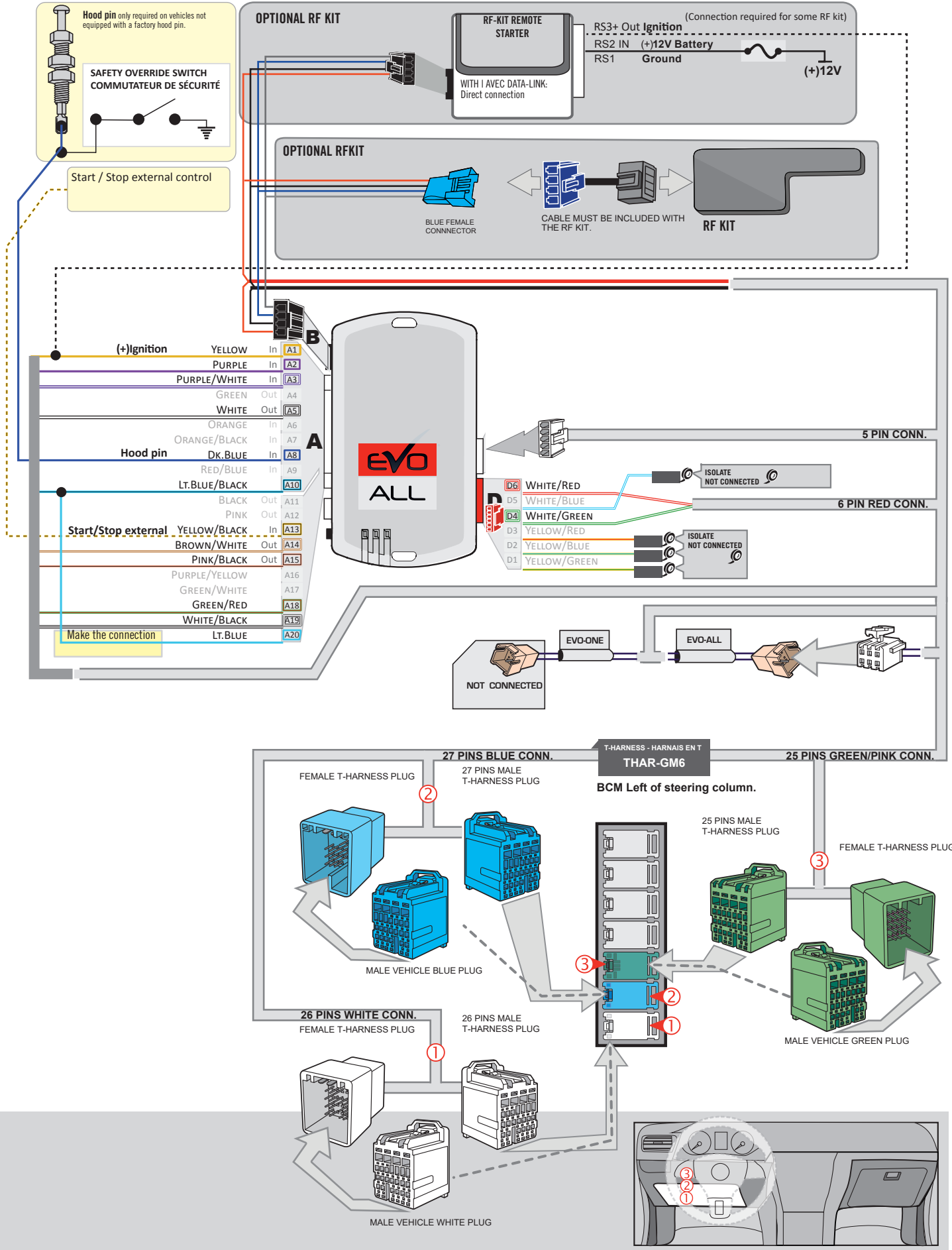

KEY BYPASS PROGRAMMING PROCEDURE 1/3

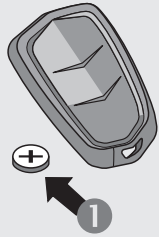

1 Remove the battery from the OEM remote.

2 Place the OEM remote into the transmitter pocket of the center console.

Refer to vehicle user guide for keyport location.

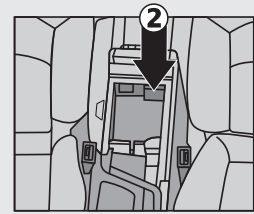

1

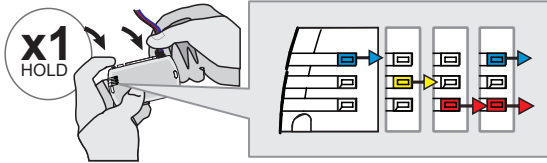

Press and hold the programming button:
Connect the 4-PIN Data-link harness (Black connector).

↳The Blue, Red, Yellow and Blue & Red LEDs will alternatively illuminate.

2

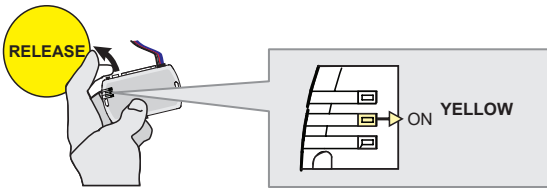

Release the programming button when the LED is YELLOW.

If the LED is not solid YELLOW disconnect the 4-Pin connector (Data-Link) and go back to step 1.

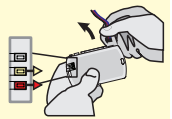

3

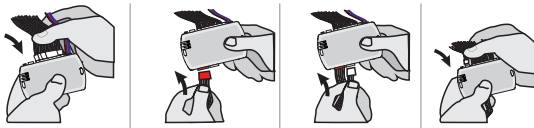

Insert the required remaining connectors.

4

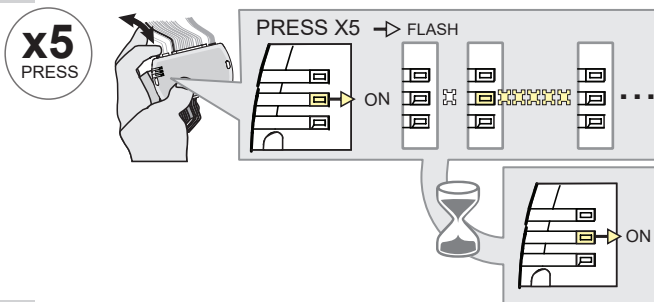

Press and release the programming button five (5x) times.

↳The YELLOW LED will flash 5 times each second.

↳**WAIT** for the YELLOW LED to turn ON solide.

5

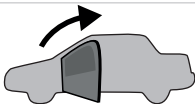

Open the driver door.

6

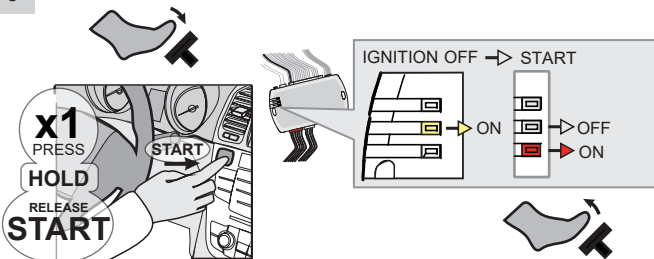

Press the foot-brake pedal.

Press the Push-to-Start button until the engine start.

Release the foot-brake pedal.

↳The RED LED will turn ON.
 ↳The YELLOW LED will turn OFF.

KEY BYPASS PROGRAMMING PROCEDURE 2/3

7



Press the Push-to-Start button until the engine turn OFF.

8

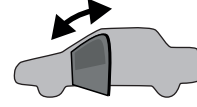

Close and open the driver door.

9

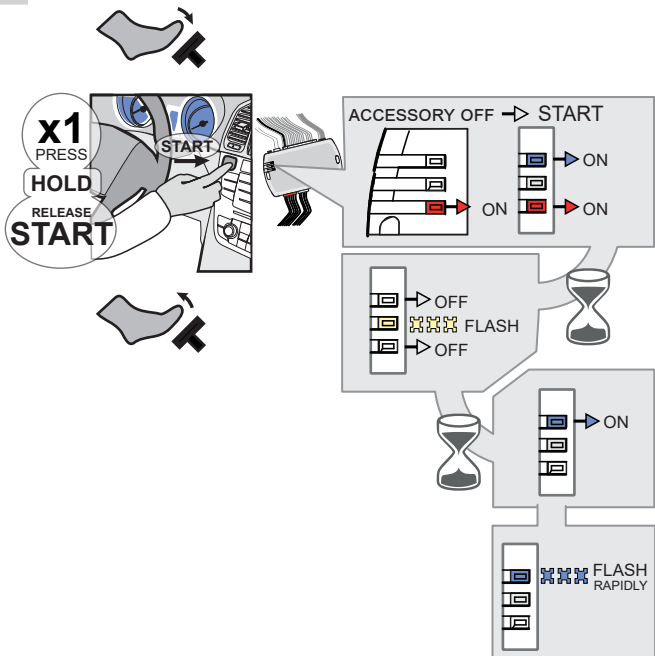

Press the foot-brake pedal.

Press the Push-to-Start button until the engine start.

Release the foot-brake pedal.

- ↳ The BLUE LED will turn ON.
- ↳ The BLUE LED will turn OFF. The RED LED will turn OFF.
- ↳ The YELLOW LED will flash rapidly
- ↳ The BLUE LED will turn ON.
- ↳ The BLUE LED will flash rapidly

10

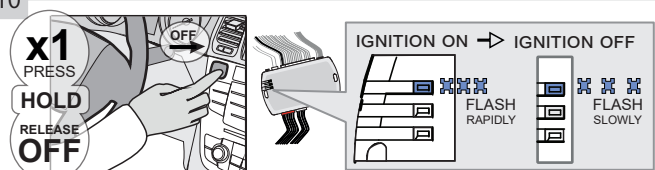

Press the Push-to-Start button until the engine turn OFF.

- ↳ The BLUE LED will flash slowly

11

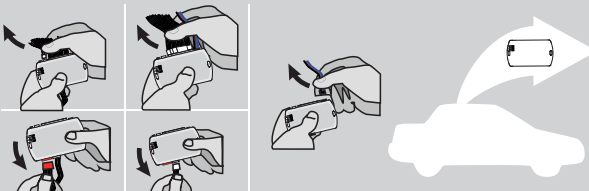

Disconnect all the connectors and after the Data-Link (4-pins) connector.

12

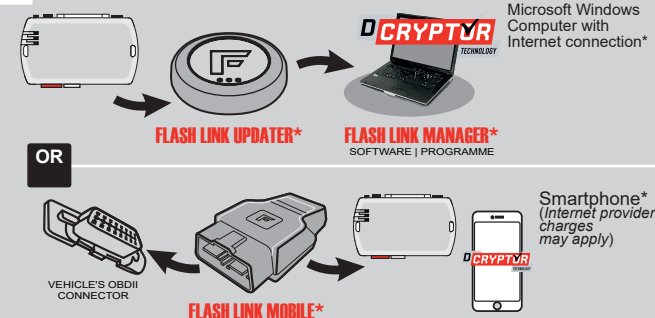

Microsoft Windows Computer with Internet connection*

FLASH LINK UPDATER* **FLASH LINK MANAGER***
SOFTWARE | PROGRAMME

OR

Smartphone* (Internet provider charges may apply)

FLASH LINK MOBILE*

Use the tool: FLASH LINK UPDATER or FLASH LINK MOBILE to visit the DCryptor menu.

*Parts required (not included)

KEY BYPASS PROGRAMMING PROCEDURE 3/3

13

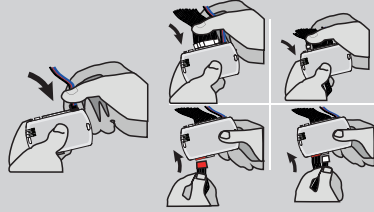
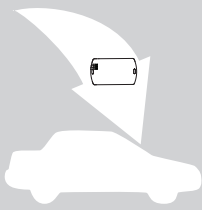

AFTER DCRYPTOR PROGRAMMING COMPLETED
Go back to the vehicle and **reconnect** the 4-Pin (Data-Link) connector and after, all the remaining connector.



The module is now programmed.



REMOTE STARTER / ALARM VERIFICATION PROCEDURE

Test the remote starter. Remote start the vehicle.

REMOTE STARTER FUNCTIONALITY



All doors must be closed.

Remote start the vehicle.



Press the Unlock button of the remote car starter or the OEM remote.



Enter the vehicle with the Intelligent Access Key.

The vehicle can now be put in to gear and driven.



If the vehicle is not unlocked the module will shut down the remote-starter and the vehicle as soon as any door is opened.

THAR-GM6

THARNNESS STAND ALONE INSTALLATION

ADDENDUM - SUGGESTED WIRING CONFIGURATION



ONLY COMPATIBLE WITH AUTOMATIC TRANSMISSION VEHICLES.

VEHICLE		YEARS	Vehicle functions supported in this diagram (functional if equipped)														
			Immobilizer bypass	Lock	Unlock	Arm	Disarm	Trunk (open)	Parking Light	RAP Disable	Tachometer	Heated Seats	Door Status	Trunk Status	Hand-Brake Status	Foot-Brake Status	OEM Remote Monitoring
CHEVROLET																	
Camaro	Push-To-Start	2016-2019	•	•	•	•	•	•	•	•	•	•	•	•	•	•	•

FIRMWARE VERSION

70.[41]

GM MINIMUM

To add the firmware version and the options, use the **FLASH LINK UPDATER** or **FLASH LINK MOBILE** tool, sold separately.

<p>IF THE VEHICLE IS NOT EQUIPPED WITH FUNCTIONAL HOOD PIN:</p>	A11	<div style="background-color: red; color: white; padding: 5px; width: 30px; height: 30px; margin: 0 auto;">OFF</div>	<p>Hood trigger (Output Status).</p>
--	-----	--	--------------------------------------

	Program bypass option:	UNIT OPTION	DESCRIPTION
		C1	OEM Remote status (Lock/Unlock) monitoring
		D6	Push-to-Start

	<p>ATTENTION!</p>	<p>DATE: XX-XX</p>	E5	<div style="background-color: red; color: white; padding: 5px; width: 30px; height: 30px; margin: 0 auto;">OFF</div>	<p>SPECIAL FUNCTIONS: BY DEFAULT DEACTIVATED</p>
				<div style="background-color: green; color: white; padding: 5px; width: 30px; height: 30px; margin: 0 auto;">ON</div>	<p>MANUFACTURED MODULES BETWEEN: 04/2018 TO 04/2019</p>

Parts required (Not included)

1X THAR-GM6

MANDATORY INSTALL

<p>*HOOD PIN</p>	<p>HOOD STATUS: THE HOOD PIN SWITCH MUST BE INSTALLED IF THE VEHICLE CAN BE REMOTE STARTED WITH THE HOOD OPEN, SET FUNCTION A11 TO OFF.</p>	A11	<div style="background-color: red; color: white; padding: 5px; width: 30px; height: 30px; margin: 0 auto;">OFF</div>	<p>Notice: the installation of safety elements are mandatory. The hood pin is an essential security element and must be installed.</p>
------------------	--	-----	--	---

THIS MODULE MUST BE INSTALLED BY A QUALIFIED TECHNICIAN. A WRONG CONNECTION CAN CAUSE PERMANENT DAMAGE TO THE VEHICLE.

PARTS REQUIRED (NOT INCLUDED)

1x **FLASH LINK UPDATER,**
 1x **FLASH LINK MANAGER**
 SOFTWARE | PROGRAMME
 1x Microsoft Windows Computer with Internet connection

OR

1x **FLASH LINK MOBILE**
 1x **FLASH LINK MOBILE APP**
 Smartphone *Android* or *iOS* with Internet connection (*provider charges may apply*).

MANDATORY

HOOD PIN



REMOTE START SAFETY OVERRIDE SWITCH

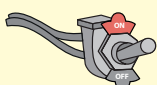





VALET SWITCH

Part #: RSPB available, Sold separately.

Notice: the installation of safety elements are mandatory. The hood pin and the valet switch are essential security elements and must be installed.

STAND ALONE CONFIGURATION

	Program bypass option	UNIT OPTION	DESCRIPTION
	OEM Remote Stand Alone Remote Starter:	D1.10 	By default, LOCK, LOCK, LOCK
		D1.1 	Par défaut, VERROUILLE,VERROUILLE,VERROUILLE
	Program bypass option with oem remote:	C1	OEM Remote Monitoring
	Program bypass option with RF KIT antenna:	H1 to H6	Supported RF Kits and select RF Kit

REMOTE STARTER FUNCTIONALITY



All doors must be closed.

3X 

Press the OEM remote's Lock button 3x to remote-start (or remote-stop) the vehicle.



The vehicle will START.

REMOTE STARTER DIAGNOSTICS
MODULE RED LED

x2 flash :	Brake ON
x3 flash :	No tach
x4 flash :	Ignition before start
x5 flash :	Hood Open

REMOTE STARTER WARNING CARD



CUT THIS WARNING CARD AND STICK IT ON A VISIBLE PLACE:
 or use the package **RSPB**, Sold separately.

WARNING | ATTENTION

REMOTE STARTER

THE VEHICLE CAN BE STARTED BY EITHER: PRESSING THE LOCK BUTTON ON THE OEM REMOTE 3 TIMES CONSECUTIVELY OR BY A SMARTPHONE. **TURN ON** THE SAFETY SWITCH LOCATED UNDER THE DASHBOARD BEFORE WORKING ON THE VEHICLE.

DESCRIPTION

BCM located on left side of the steering column

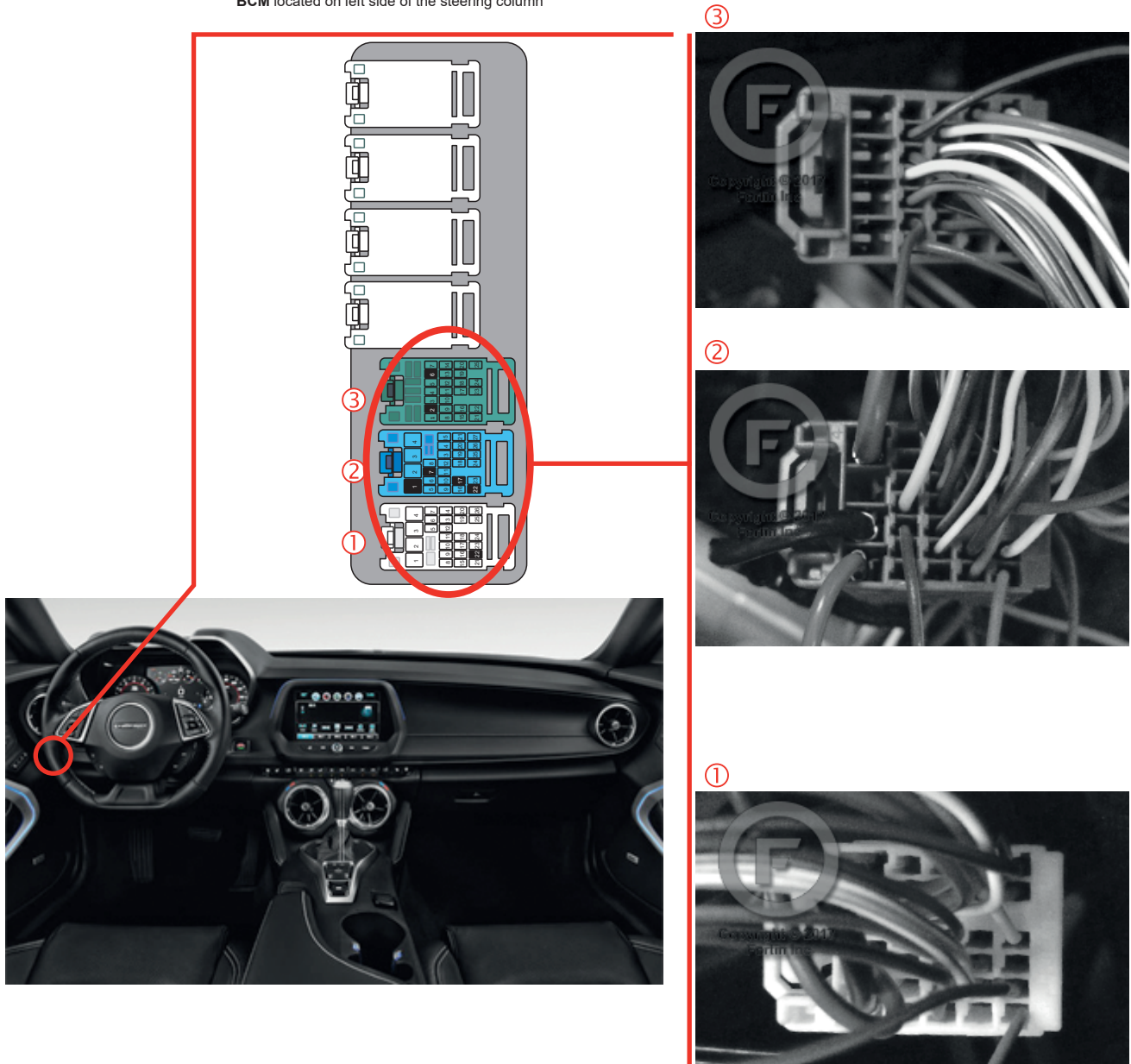

AUTOMATIC TRANSMISSION WIRING CONNECTION

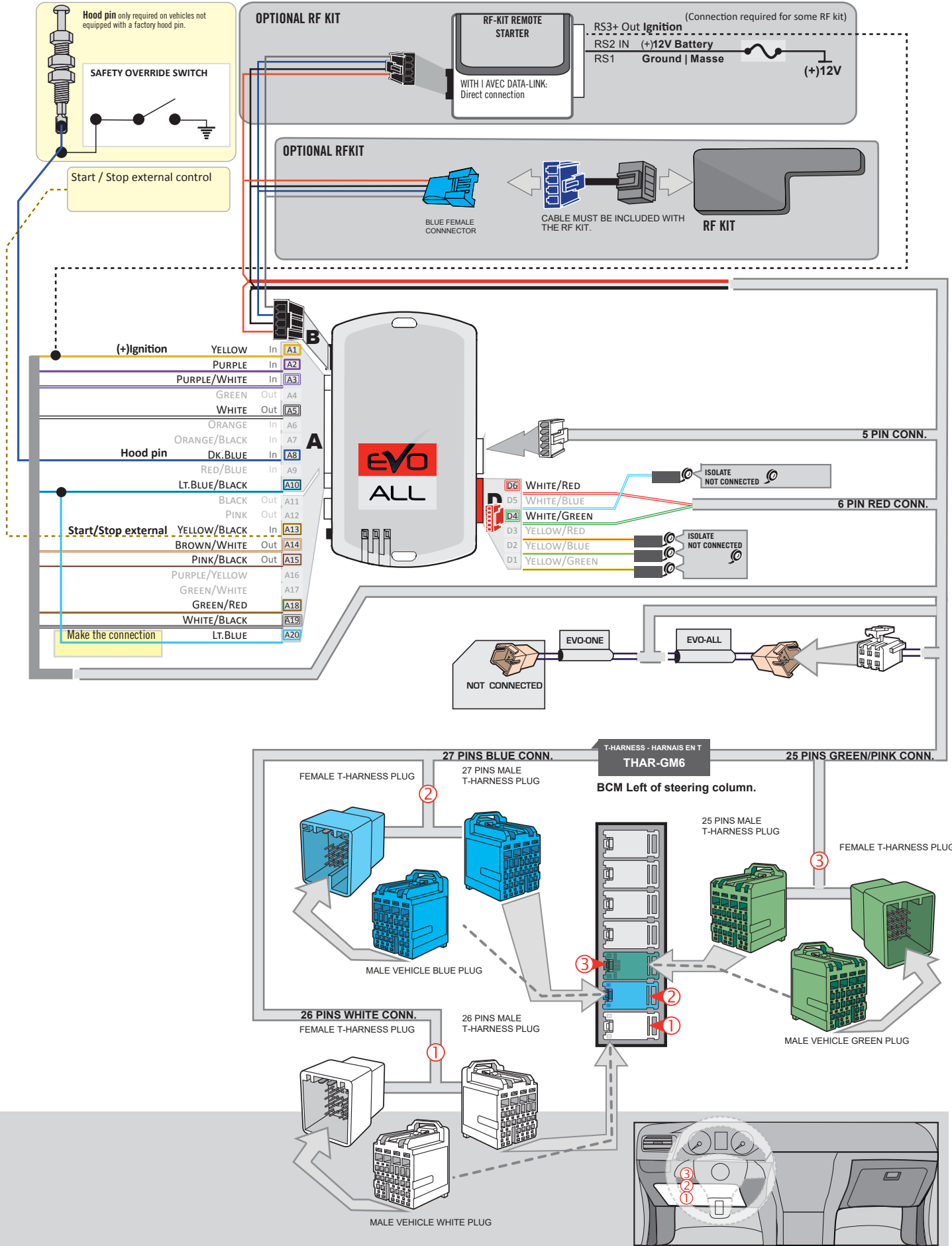

KEY BYPASS PROGRAMMING PROCEDURE 1/3

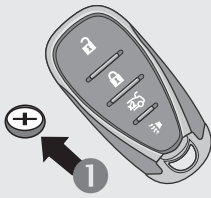

1 Remove the battery from the OEM remote.

2 Place the OEM remotes in to the center console.

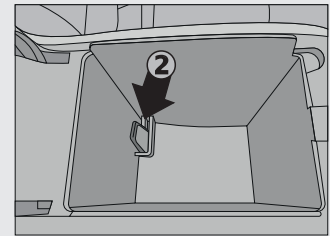

1

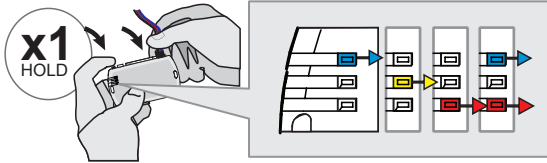

Press and hold the programming button:
Connect the 4-PIN Data-link harness (Black connector).

↳The Blue, Red, Yellow and Blue & Red LEDs will alternatively illuminate.

2

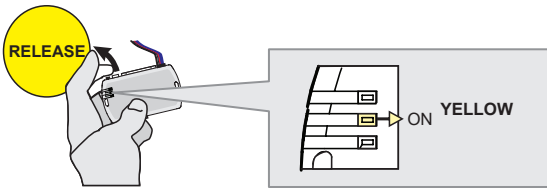

Release the programming button when the LED is YELLOW.

If the LED is not solid YELLOW disconnect the 4-Pin connector (Data-Link) and go back to step 1.

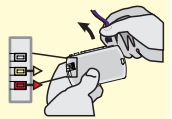

3

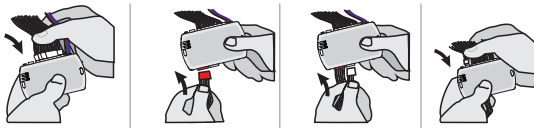

Insert the required remaining connectors.

4

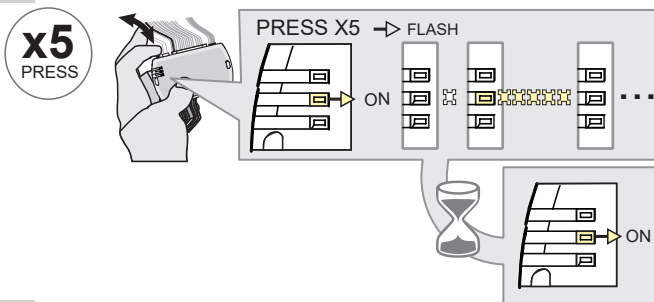

Press and release the programming button five (5x) times.

↳The YELLOW LED will flash 5 times each second.

↳**WAIT** for the YELLOW LED to turn ON solide.

5

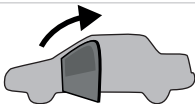

Open the driver door.

6

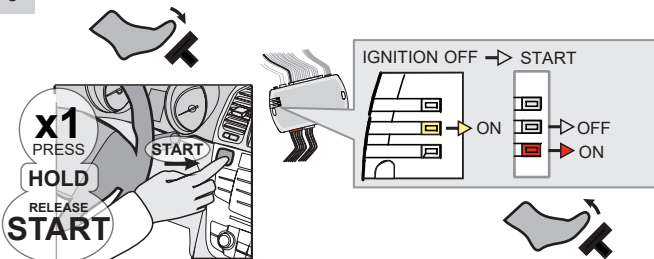

Press the foot-brake pedal.

Press the Push-to-Start button until the engine start.

Release the foot-brake pedal.

↳The RED LED will turn ON.
↳The YELLOW LED will turn OFF.

KEY BYPASS PROGRAMMING PROCEDURE 2/3

7



Press the Push-to-Start button until the engine turn OFF.

8

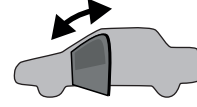

Close and open the driver door.

9

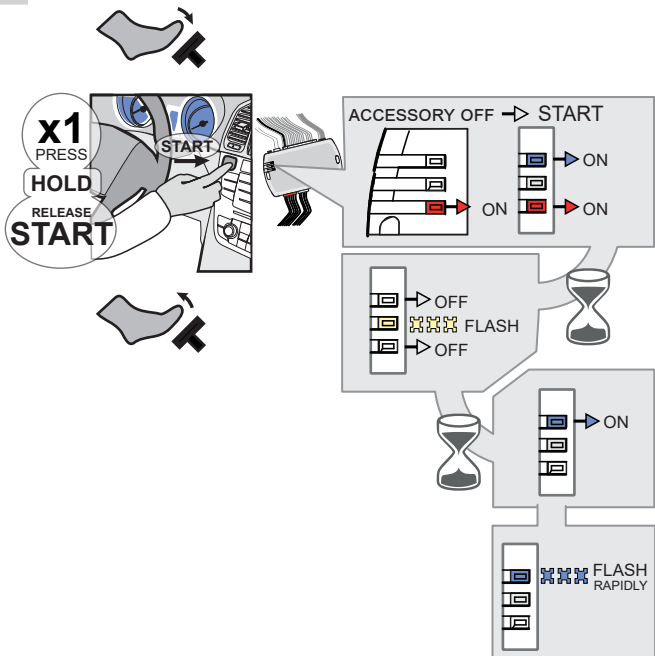

Press the foot-brake pedal.

Press the Push-to-Start button until the engine start.

Release the foot-brake pedal.

- ↳ The BLUE LED will turn ON.
- ↳ The BLUE LED will turn OFF. The RED LED will turn OFF.
- ↳ The YELLOW LED will flash rapidly
- ↳ The BLUE LED will turn ON.
- ↳ The BLUE LED will flash rapidly

10

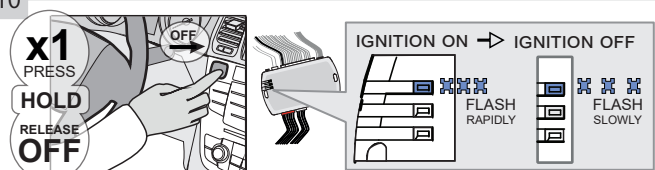

Press the Push-to-Start button until the engine turn OFF.

- ↳ The BLUE LED will flash slowly

11

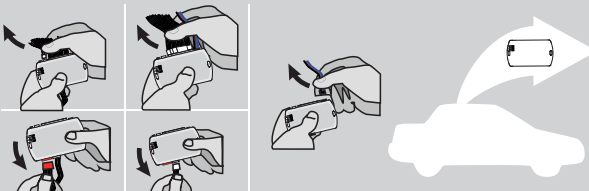

Disconnect all the connectors and after the Data-Link (4-pins) connector.

12

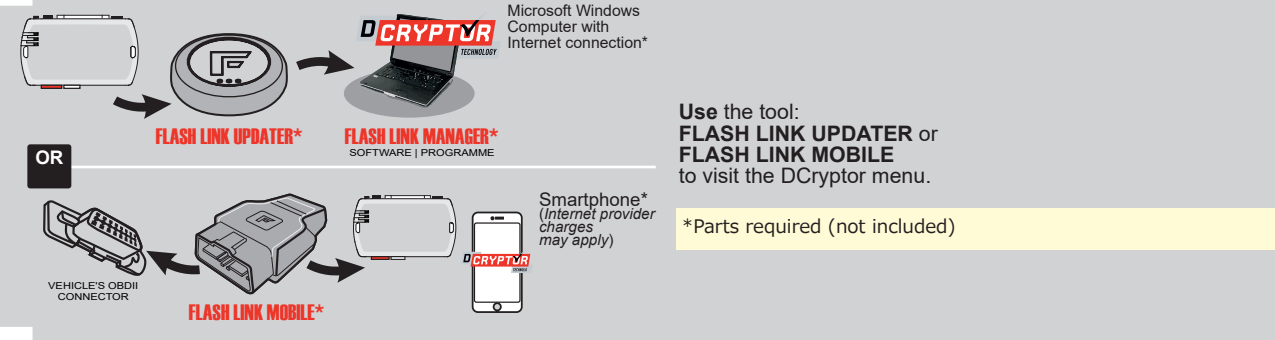

Use the tool: FLASH LINK UPDATER or FLASH LINK MOBILE to visit the DCryptor menu.

***Parts required (not included)**

KEY BYPASS PROGRAMMING PROCEDURE 3/3

13

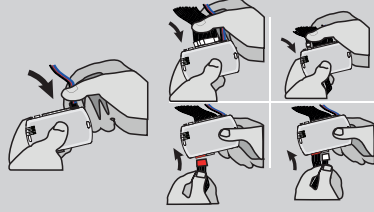
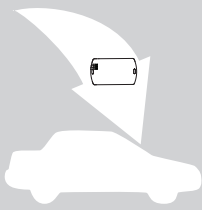

AFTER DCRYPTOR PROGRAMMING COMPLETED
Go back to the vehicle and **reconnect** the 4-Pin (Data-Link) connector and after, all the remaining connector.



The module is now programmed.



REMOTE STARTER / ALARM VERIFICATION PROCEDURE

Test the remote starter. Remote start the vehicle.

REMOTE STARTER FUNCTIONALITY



All doors must be closed.



Remote start the vehicle.



Unlock the doors with either:

- The OEM remote
- The remote-starter remote
- Or the proximity remote

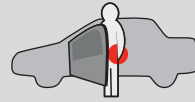

Enter the vehicle with the Intelligent Key.



The vehicle can now be put in to gear and driven.

If the vehicle is not unlocked with one of these conditions the remote-starter will shut down as soon as any door is opened.



THAR-GM6

THARNNESS STAND ALONE INSTALLATION



ONLY COMPATIBLE WITH AUTOMATIC TRANSMISSION VEHICLES.



Vehicle functions supported in this diagram (functional if equipped)

VEHICLE	YEARS	Immobilizer bypass	Lock	Unlock	Arm	Disarm	Trunk (open)	RAP Disable	Tachometer	Door Status	Trunk Status	Hood Status*	Hand-Brake Status	Foot-Brake Status	Push-to-Start Control	OEM Remote monitoring
CADILLAC																
ATS	Push-to-start (AT) 2013-2018	•	•	•	•	•	•	•	•	•	•	•	•	•	•	•
CTS	Push-to-start (AT) 2014-2016	•	•	•	•	•	•	•	•	•	•	•	•	•	•	•
CTS-V	Push-to-start (AT) 2013-2016	•	•	•	•	•	•	•	•	•	•	•	•	•	•	•
Escalade	Push-to-start (AT) 2015-2019	•	•	•	•	•	•	•	•	•	•	•	•	•	•	•
CHEVROLET																
Tahoe	Push-to-start (AT) 2015-2019	•	•	•	•	•	•	•	•	•	•	•	•	•	•	•
Suburban	Push-to-start (AT) 2015-2019	•	•	•	•	•	•	•	•	•	•	•	•	•	•	•
GMC																
Yukon	Push-to-start (AT) 2015-2019	•	•	•	•	•	•	•	•	•	•	•	•	•	•	•

FIRMWARE VERSION

70.[41]

GM MINIMUM

To add the firmware version and the options, use the **FLASH LINK UPDATER** or **FLASH LINK MOBILE** tool, sold separately.

<p>IF THE VEHICLE IS NOT EQUIPPED WITH FUNCTIONAL HOOD PIN:</p>	A11	OFF	Hood trigger (Output Status).
<p>Program bypass option:</p>	UNIT OPTION		
	C1	OEM Remote status (Lock/Unlock) monitoring	
	D6	Push-to-Start	

ATTENTION!

DATE: XX-XX

E5

OFF

SPECIAL FUNCTIONS: BY DEFAULT DEACTIVATED

MANUFACTURED MODULES BETWEEN: 04/2018 TO 04/2019

- Parts required (Not included)**
- 1X Fuse
 - 1X 1 K Ohm Resistor
 - 1X 180 Ohm Resistor

***HOOD PIN**

MANDATORY INSTALL

HOOD STATUS: THE HOOD PIN SWITCH MUST BE INSTALLED IF THE VEHICLE CAN BE REMOTE STARTED WITH THE HOOD OPEN, SET FUNCTION A11 TO OFF.

A11

OFF

Notice: the installation of safety elements are mandatory. The hood pin is an essential security element and must be installed.

THIS MODULE MUST BE INSTALLED BY A QUALIFIED TECHNICIAN. A WRONG CONNECTION CAN CAUSE PERMANENT DAMAGE TO THE VEHICLE.

PARTS REQUIRED (NOT INCLUDED)

1x **FLASH LINK UPDATER**
 1x **FLASH LINK MANAGER**
 SOFTWARE
 1x Microsoft Windows Computer with Internet connection

OR

1x **FLASH LINK MOBILE**
 1x **FLASH LINK MOBILE APP**
 Smartphone *Android* or *iOS* with Internet connection (*provider charges may apply*).
 1x

MANDATORY

HOOD PIN



REMOTE START SAFETY OVERRIDE SWITCH

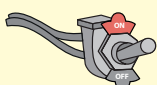





VALET SWITCH

Part #: RSPB available, Sold separately.

Notice: the installation of safety elements are mandatory. The hood pin and the valet switch are essential security elements and must be installed.

STAND ALONE CONFIGURATION

	Program bypass option	UNIT OPTION	DESCRIPTION
	OEM Remote Stand Alone Remote Starter:	D1.10 	By default, LOCK, LOCK, LOCK Par défaut, VERROUILLE,VERROUILLE,VERROUILLE
		D1.1 	
	Program bypass option with oem remote:	C1	OEM Remote Monitoring
	Program bypass option with RF KIT antenna:	H1 to H6	Supported RF Kits and select RF Kit

REMOTE STARTER FUNCTIONALITY



All doors must be closed.

3X 

Press the OEM remote's Lock button 3x to remote-start (or remote-stop) the vehicle.



START 

The vehicle will START.

REMOTE STARTER DIAGNOSTICS
MODULE RED LED

x2 flash :	Brake ON
x3 flash :	No tach
x4 flash :	Ignition before start
x5 flash :	Hood Open

REMOTE STARTER WARNING CARD



CUT THIS WARNING CARD AND STICK IT ON A VISIBLE PLACE:
 or use the package **RSPB**, Sold separately.

WARNING



REMOTE STARTER

THE VEHICLE CAN BE STARTED BY EITHER: PRESSING THE LOCK BUTTON ON THE OEM REMOTE 3 TIMES CONSECUTIVELY OR BY A SMARTPHONE. **TURN ON** THE SAFETY SWITCH LOCATED UNDER THE DASHBOARD BEFORE WORKING ON THE VEHICLE.

DESCRIPTION



BCM

CTS		ATS
Escalade Tahoe Suburban Yukon	Under driver dash	Behind glove box

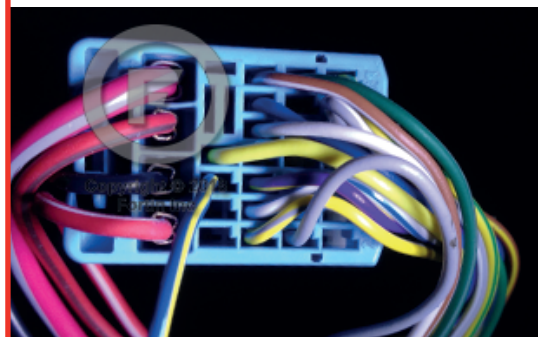
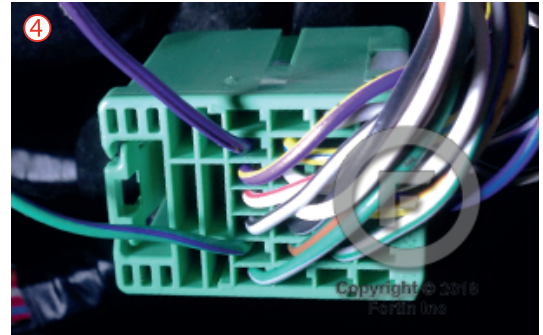

AUTOMATIC TRANSMISSION WIRING CONNECTION

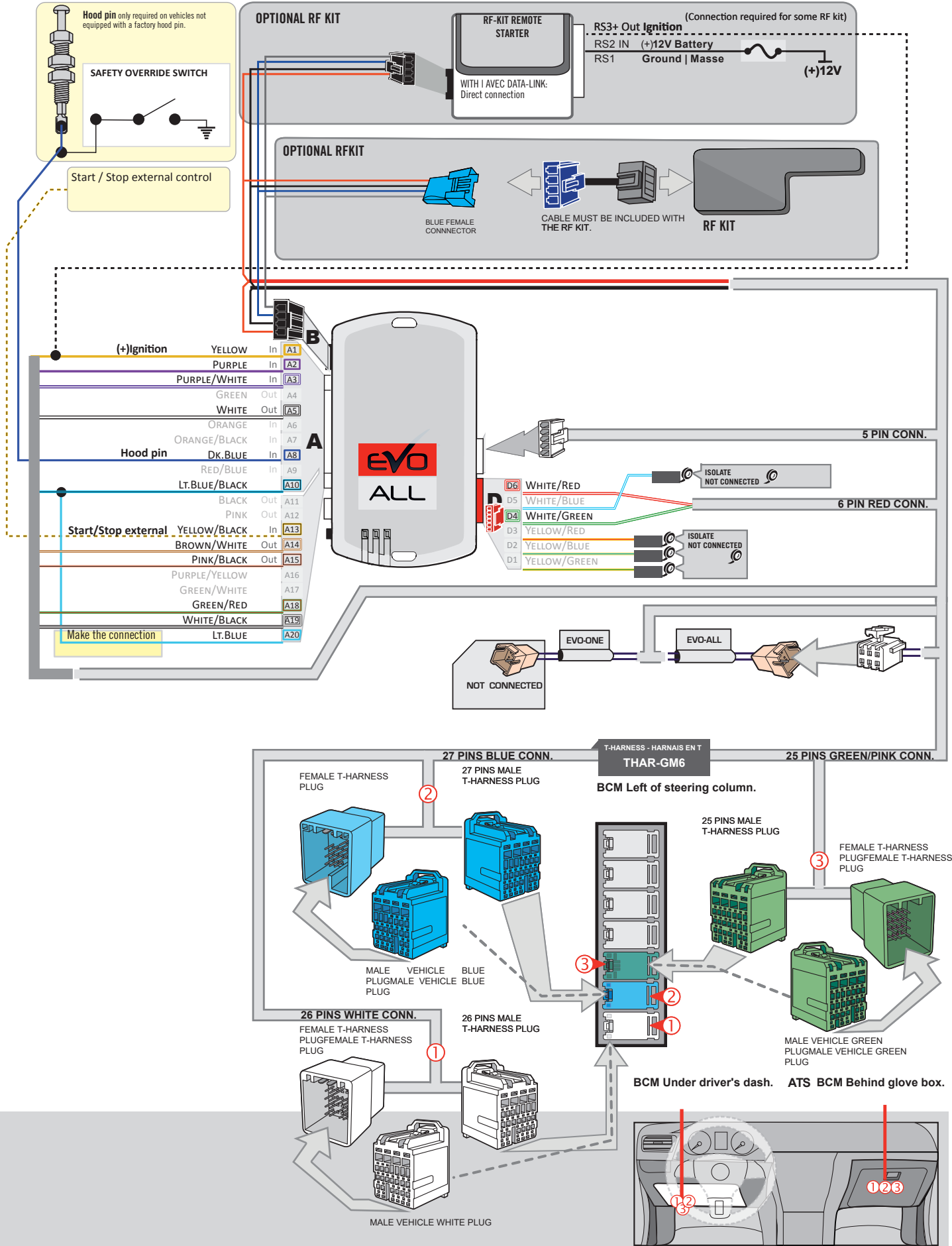

KEY BYPASS PROGRAMMING PROCEDURE 1/3

1 Remove the battery from the OEM remote.

2 Place the OEM remote in the **back** cup holder in the center console.

Refer to vehicle user guide for keyport location.



ATS

1 Remove the battery from the OEM remote.

2 Place the transmitter in the transmitter pocket, which is inside the **centre** console storage area.

Refer to vehicle user guide for keyport location.

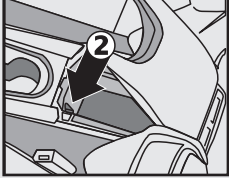

1

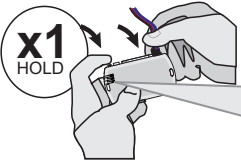

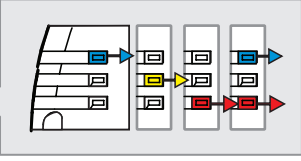

Press and hold the programming button:
Connect the 4-PIN Data-link harness (Black connector).

↳The Blue, Red, Yellow and Blue & Red LEDs will alternatively illuminate.

2

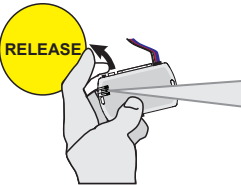

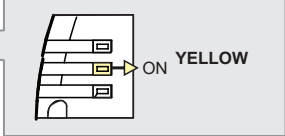

Release the programming button when the LED is **YELLOW**.

If the LED is not solid YELLOW disconnect the 4-Pin connector (Data-Link) and go back to step 1.

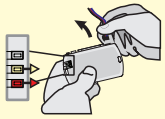

3

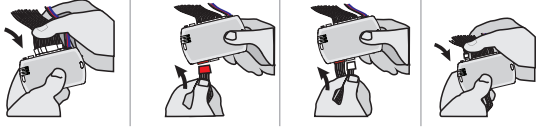

Insert the required remaining connectors.

4



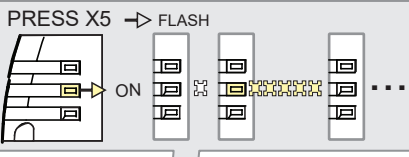

Press and release the programming button five (5x) times.

↳The YELLOW LED will flash 5 times each second.

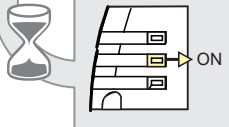

↳WAIT for the YELLOW LED to turn ON solide.

5

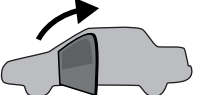

Open the driver door.

6



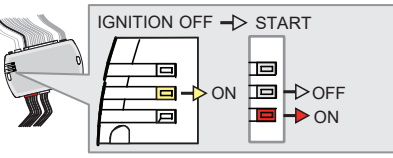

Press the foot-brake pedal.

Press the Push-to-Start button until the engine start.

Release the foot-brake pedal.

↳The RED LED will turn ON.
↳The YELLOW LED will turn OFF.



KEY BYPASS PROGRAMMING PROCEDURE 2/3

7



Press the Push-to-Start button until the engine turn OFF.

8

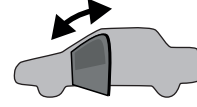

Close and open the driver door.

9

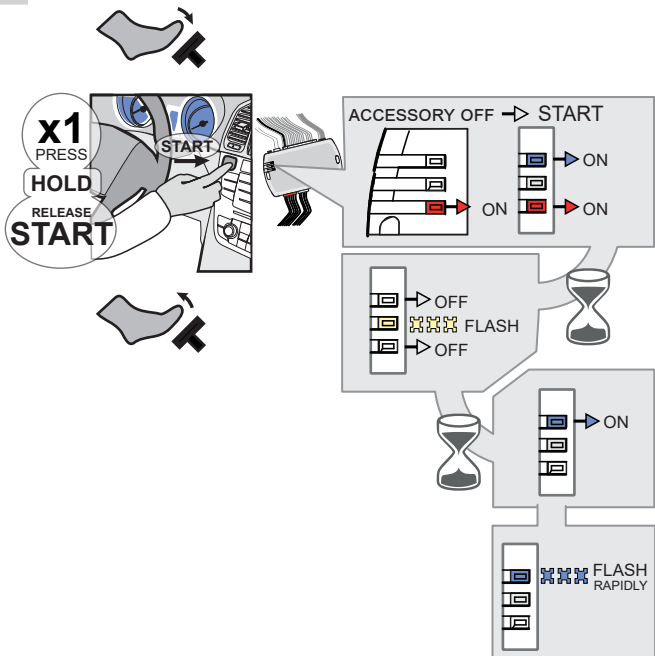

Press the foot-brake pedal.

Press the Push-to-Start button until the engine start.

Release the foot-brake pedal.

- ↳ The BLUE LED will turn ON.
- ↳ The BLUE LED will turn OFF. The RED LED will turn OFF.
- ↳ The YELLOW LED will flash rapidly
- ↳ The BLUE LED will turn ON.
- ↳ The BLUE LED will flash rapidly

10

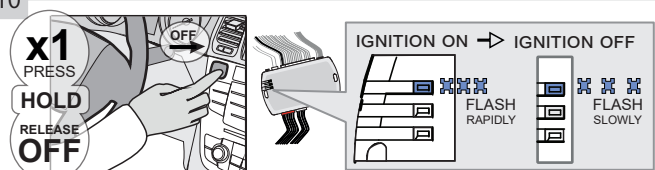

Press the Push-to-Start button until the engine turn OFF.

- ↳ The BLUE LED will flash slowly

11

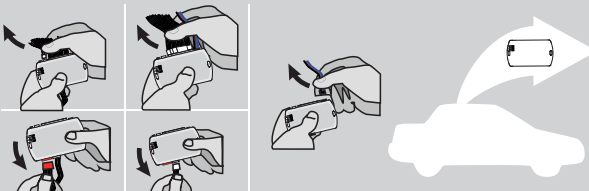

Disconnect all the connectors and after the Data-Link (4-pins) connector.

12

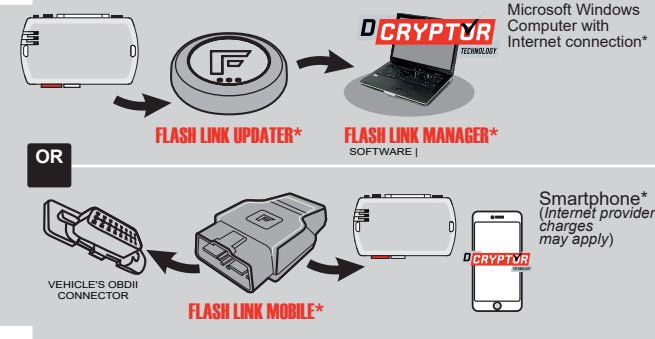

Use the tool: FLASH LINK UPDATER or FLASH LINK MOBILE to visit the DCRYPTOR menu.

***Parts required (not included)**

KEY BYPASS PROGRAMMING PROCEDURE 3/3

13

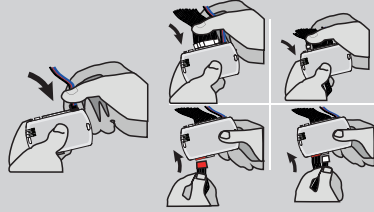
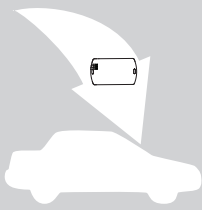

AFTER DCRYPTOR PROGRAMMING COMPLETED
Go back to the vehicle and **reconnect** the 4-Pin (Data-Link) connector and after, all the remaining connector.



The module is now programmed.



REMOTE STARTER / ALARM VERIFICATION PROCEDURE

Test the remote starter. Remote start the vehicle.

REMOTE STARTER FUNCTIONALITY



All doors must be closed.



Remote start the vehicle.



Unlock the doors with either:

- The OEM remote
- The remote-starter remote
- Or the proximity remote

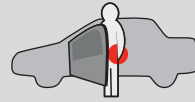

Enter the vehicle with the Intelligent Key.



The vehicle can now be put in to gear and driven.

If the vehicle is not unlocked with one of these conditions the remote-starter will shut down as soon as any door is opened.



THARNNESS STAND ALONE INSTALLATION

THAR-GM6

ADDENDUM - SUGGESTED WIRING CONFIGURATION



ONLY COMPATIBLE WITH AUTOMATIC TRANSMISSION VEHICLES.

VEHICLE	YEARS	Vehicle functions supported in this diagram (functional if equipped)													
		Immobilizer bypass	Lock	Unlock	Arm	Disarm	Trunk (open)	RAP Disable	Tachometer	Heated Seats	Door Status	Trunk Status	Hand-Brake Status	Foot-Brake Status	OEM Remote Monitoring
															
Sonic	Push-To-Start	2017-2018	•	•	•	•	•	•	•	•	•	•	•	•	•
Spark	Push-To-Start	2016-2021	•	•	•	•	•	•	•	•	•	•	•	•	•





FIRMWARE VERSION

70.[45]

GM MINIMUM

To add the firmware version and the options, use the **FLASH LINK UPDATER** or **FLASH LINK MOBILE** tool, sold separately.

	UNIT OPTION		DESCRIPTION
 <p>Program bypass option:</p>	C1		OEM Remote status (Lock/Unlock) monitoring
<p>IF THE VEHICLE IS NOT EQUIPPED WITH FUNCTIONAL HOOD PIN:</p>	A11	OFF	Hood trigger (Output Status).
	D6		Push-to-Start



ATTENTION!



DATE: XX-XX

E5

OFF

ON

SPECIAL FUNCTIONS: BY DEFAULT DEACTIVATED

MANUFACTURED MODULES BETWEEN: 04/2018 TO 04/2019

 **Parts required (Not included)**
1X THAR-GM6

MANDATORY INSTALL

*HOOD PIN



HOOD STATUS: THE HOOD PIN SWITCH MUST BE INSTALLED IF THE VEHICLE CAN BE REMOTE STARTED WITH THE HOOD OPEN, SET FUNCTION **A11** TO OFF.

A11

OFF

Notice: the installation of safety elements are mandatory. The hood pin is an essential security element and must be installed.

THIS MODULE MUST BE INSTALLED BY A QUALIFIED TECHNICIAN. A WRONG CONNECTION CAN CAUSE PERMANENT DAMAGE TO THE VEHICLE.

PARTS REQUIRED (NOT INCLUDED)

1x **FLASH LINK UPDATER,**
 1x **FLASH LINK MANAGER**
SOFTWARE | PROGRAMME
 1x Microsoft Windows Computer with Internet connection

OR

1x **FLASH LINK MOBILE**
 1x **FLASH LINK MOBILE APP**
Smartphone Android or iOS with Internet connection (provider charges may apply).

MANDATORY

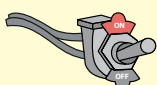



HOOD PIN  REMOTE START SAFETY OVERRIDE SWITCH 

VALET SWITCH

Part #: RSPB available, Sold separately.

Notice: the installation of safety elements are mandatory. The hood pin and the valet switch are essential security elements and must be installed.



STAND ALONE CONFIGURATION | CONFIGURATION EN DÉMARREUR AUTONOME

	Program bypass option	UNIT OPTION	DESCRIPTION
	OEM Remote Stand Alone Remote Starter:	D1.10 	By default, LOCK, LOCK, LOCK Par défaut, VERROUILLE,VERROUILLE,VERROUILLE
		D1.1 	
	Program bypass option with oem remote:	C1	OEM Remote Monitoring
	Program bypass option with RF KIT antenna:	H1 to H6	Supported RF Kits and select RF Kit

REMOTE STARTER FUNCTIONALITY |



All doors must be closed.

3X  

Press the OEM remote's Lock button 3x to remote-start (or remote-stop) the vehicle.



The vehicle will START.

REMOTE STARTER DIAGNOSTICS
MODULE RED LED

x2 flash :	Brake ON
x3 flash :	No tach
x4 flash :	Ignition before start
x5 flash :	Hood Open

REMOTE STARTER WARNING CARD



CUT THIS WARNING CARD AND STICK IT ON A VISIBLE PLACE:
 or use the package RSPB, Sold separately.

WARNING

REMOTE STARTER

THE VEHICLE CAN BE STARTED BY EITHER: PRESSING THE LOCK BUTTON ON THE OEM REMOTE 3 TIMES CONSECUTIVELY OR BY A SMARTPHONE. **TURN ON** THE SAFETY SWITCH LOCATED UNDER THE DASHBOARD BEFORE WORKING ON THE VEHICLE.

DESCRIPTION

BCM

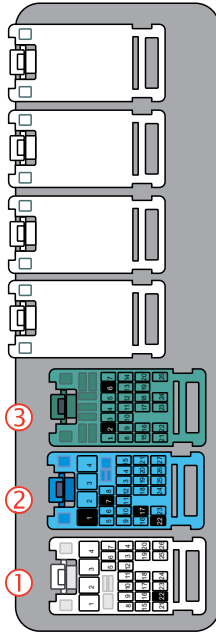

③



②

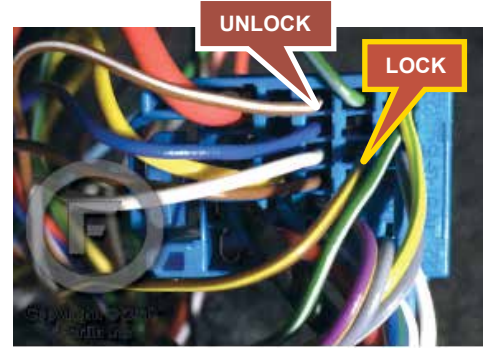
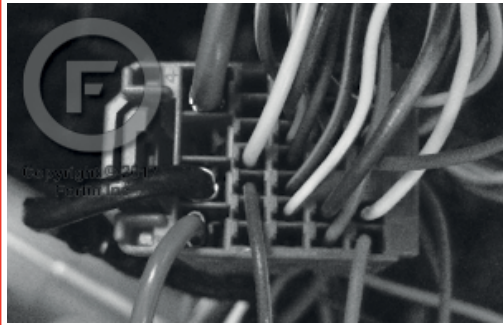

①



AUTOMATIC TRANSMISSION WIRING CONNECTION

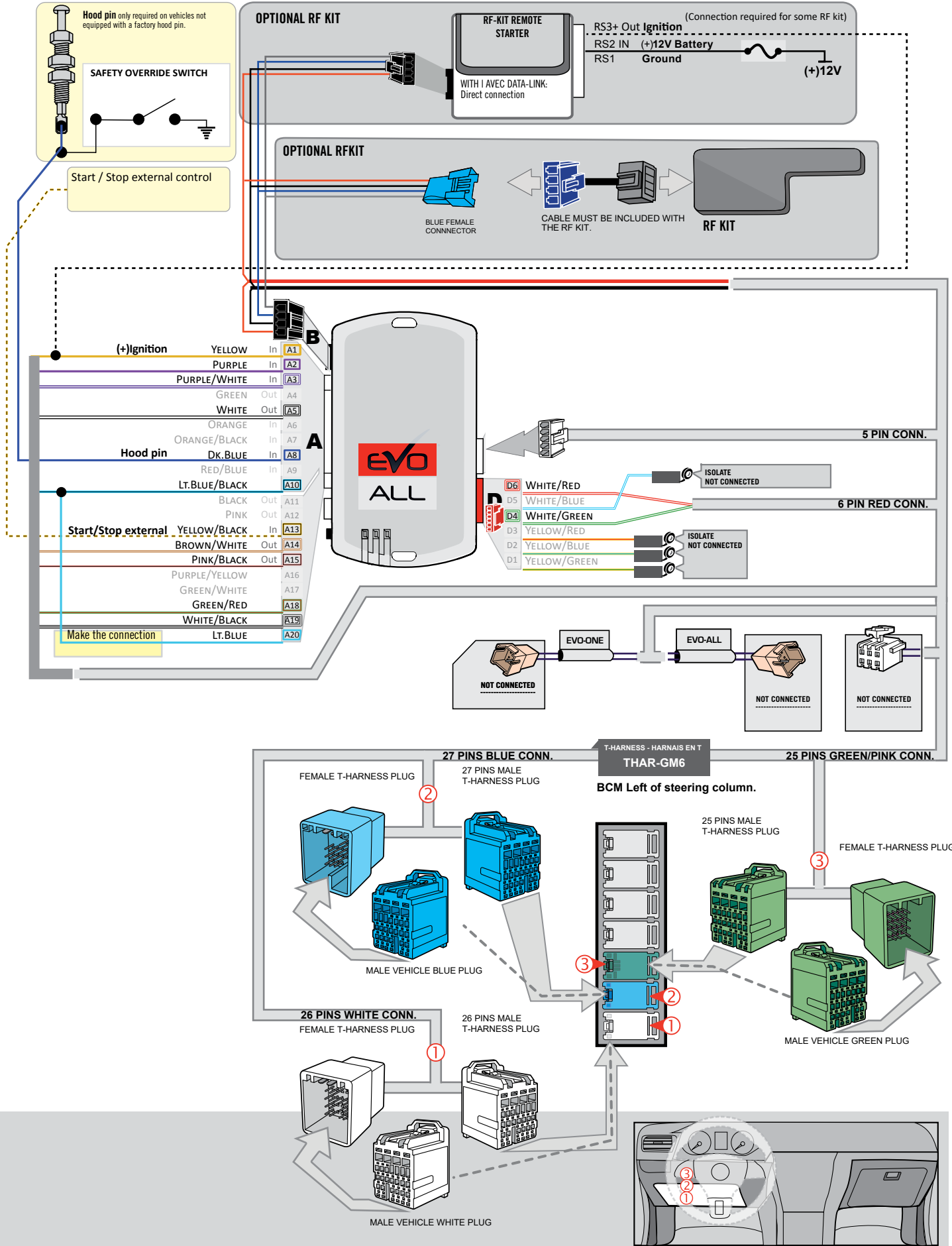

KEY BYPASS PROGRAMMING PROCEDURE 1/3

SONIC



- 1** Remove the battery from the OEM remote.
- 2** Place the OEM remote in the **front** cup holder in the center console.

Refer to vehicle user guide for keyport location.

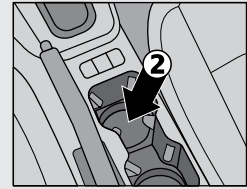

SPARK

- 1** Remove the battery from the OEM remote.
- 2** Place the transmitter in the transmitter pocket, which is inside the **centre** console storage area.

Refer to vehicle user guide for keyport location.

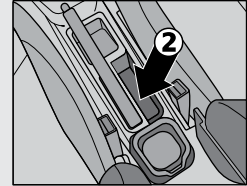

1

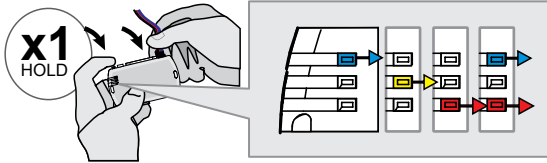

Press and hold the programming button:
Connect the 4-PIN Data-link harness (Black connector).

↳The Blue, Red, Yellow and Blue & Red LEDs will alternatively illuminate.

2

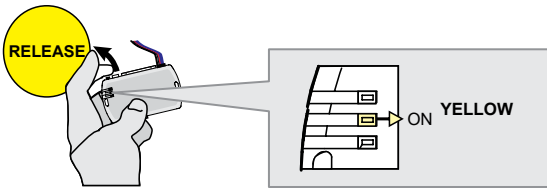

Release the programming button when the LED is **YELLOW**.

If the LED is not solid YELLOW disconnect the 4-Pin connector (Data-Link) and go back to step 1.

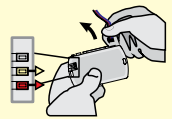

3

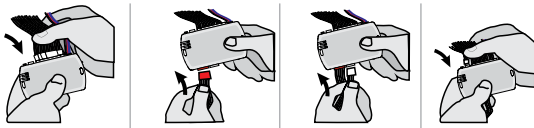

Insert the required remaining connectors.

4

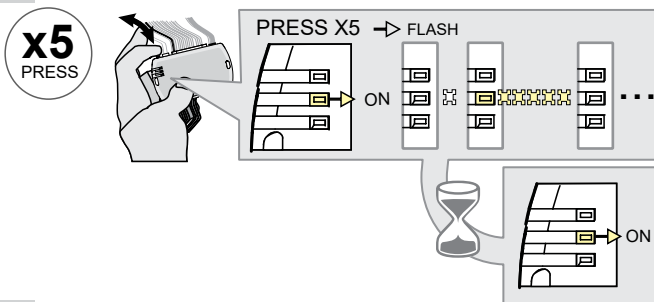

Press and release the programming button five (5x) times.

↳The **YELLOW LED** will flash 5 times each second.

↳**WAIT** for the **YELLOW LED** to turn ON solide.

5

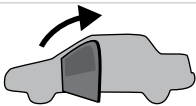

Open the driver door.

6

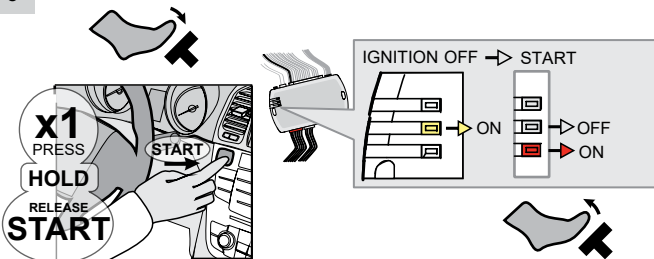

Press the foot-brake pedal.

Press the Push-to-Start button until the engine start.

Release the foot-brake pedal.

↳The **RED LED** will turn ON.
 ↳The **YELLOW LED** will turn OFF.

KEY BYPASS PROGRAMMING PROCEDURE 2/3

7



Press the Push-to-Start button until the engine turn OFF.

8

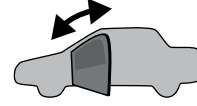

Close and open the driver door.

9

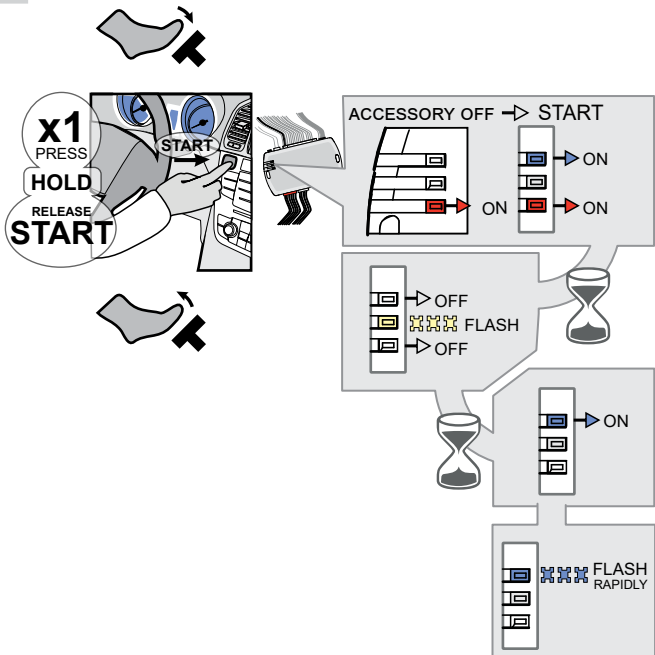

Press the foot-brake pedal.

Press the Push-to-Start button until the engine start.

Release the foot-brake pedal.

- ↳ The BLUE LED will turn ON.
- ↳ The BLUE LED will turn OFF. The RED LED will turn OFF.
- ↳ The YELLOW LED will flash rapidly
- ↳ The BLUE LED will turn ON.
- ↳ The BLUE LED will flash rapidly

10

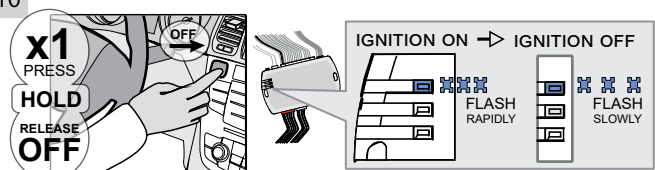

Press the Push-to-Start button until the engine turn OFF.

- ↳ The BLUE LED will flash slowly

11

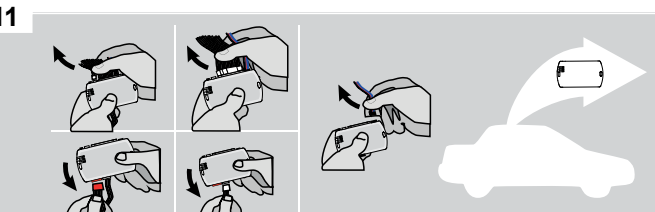

Disconnect all the connectors and after the Data-Link (4-pins) connector.

12

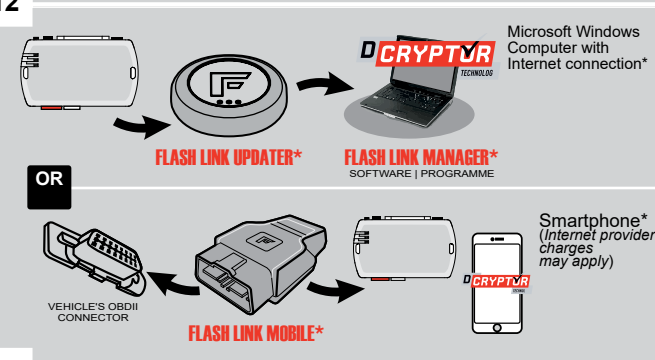

Use the tool: FLASH LINK UPDATER or FLASH LINK MOBILE to visit the DCryptor menu.

***Parts required (not included)**

KEY BYPASS PROGRAMMING PROCEDURE 3/3

13

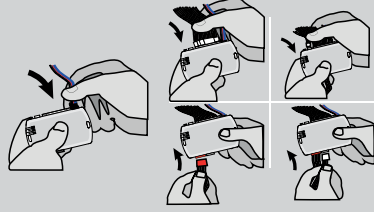
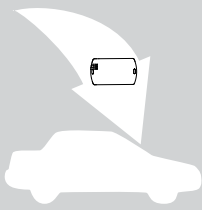

AFTER DCRYPTOR PROGRAMMING COMPLETED
 Go back to the vehicle and **reconnect** the 4-Pin (Data-Link) connector and after, all the remaining connector.



The module is now programmed.



REMOTE STARTER / ALARM VERIFICATION PROCEDURE

Test the remote starter. Remote start the vehicle.

REMOTE STARTER FUNCTIONALITY

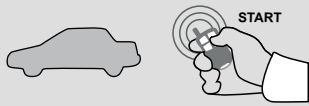

All doors must be closed.

Remote start the vehicle.



Press the Unlock button of the remote car starter or the OEM remote.

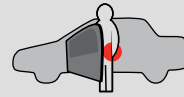

Enter the vehicle with the Intelligent Access Key.



The vehicle can now be put in to gear and driven.



If the vehicle is not unlocked the module will shut down the remote-starter and the vehicle as soon as any door is opened.

THAR-GM6

THARNNESS STAND ALONE INSTALLATION

ADDENDUM - SUGGESTED WIRING CONFIGURATION



ONLY COMPATIBLE WITH AUTOMATIC TRANSMISSION VEHICLES.



Vehicle functions supported in this diagram (functional if equipped)

VEHICLE	YEARS	Immobilizer bypass	Lock	Unlock	Arm	Disarm	Trunk (open)	Parking Light	RAP Disable	Tachometer	Heated Seats	Door Status	Hood Status	Trunk Status	Hand-Brake Status	Foot-Brake Status	OEM Remote Monitoring
CHEVROLET																	
Corvette	Push-To-Start	2014-2019	•	•	•	•	•	•	•	•	•	•	•	•	•	•	•

FIRMWARE VERSION

70.[41]

GM MINIMUM

To add the firmware version and the options, use the **FLASH LINK UPDATER** or **FLASH LINK MOBILE** tool, sold separately.

<p>IF THE VEHICLE IS NOT EQUIPPED WITH FUNCTIONAL HOOD PIN:</p>	A11	<div style="background-color: red; color: white; padding: 5px; width: 30px; height: 30px; margin: 0 auto;">OFF NON</div>	<p>Hood trigger (Output Status).</p>
--	-----	--	--------------------------------------

		UNIT OPTION	DESCRIPTION
	Program bypass option:	C1	OEM Remote status (Lock/Unlock) monitoring
		D6	Push-to-Start

	ATTENTION!	<p>DATE: XX-XX</p>	E5	<div style="background-color: red; color: white; padding: 5px; width: 30px; height: 30px; margin: 0 auto;">OFF</div>	<p>SPECIAL FUNCTIONS: BY DEFAULT DEACTIVATED</p>
				<div style="background-color: green; color: white; padding: 5px; width: 30px; height: 30px; margin: 0 auto;">ON</div>	<p>MANUFACTURED MODULES BETWEEN: 04/2018 TO 04/2019</p>

Parts required (Not included)

1X THAR-GM6

MANDATORY INSTALL

***HOOD PIN**

HOOD STATUS: THE HOOD PIN SWITCH MUST BE INSTALLED IF THE VEHICLE CAN BE REMOTE STARTED WITH THE HOOD OPEN, SET FUNCTION **A11** TO OFF.

A11

OFF

Notice: the installation of safety elements are mandatory. The hood pin is an essential security element and must be installed.

THIS MODULE MUST BE INSTALLED BY A QUALIFIED TECHNICIAN. A WRONG CONNECTION CAN CAUSE PERMANENT DAMAGE TO THE VEHICLE.

PARTS REQUIRED (NOT INCLUDED)

1x **FLASH LINK UPDATER**
 1x **FLASH LINK MANAGER**
SOFTWARE | PROGRAMME
 1x Microsoft Windows Computer with Internet connection

OR

1x **FLASH LINK MOBILE**
 1x **FLASH LINK MOBILE APP**
Smartphone Android or iOS with Internet connection (provider charges may apply).

MANDATORY

HOOD PIN



REMOTE START SAFETY OVERRIDE SWITCH

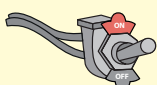





VALET SWITCH

Part #: RSPB available, Sold separately.

Notice: the installation of safety elements are mandatory. The hood pin and the valet switch are essential security elements and must be installed.

STAND ALONE CONFIGURATION

	Program bypass option	UNIT OPTION	DESCRIPTION
	OEM Remote Stand Alone Remote Starter:	D1.10 	By default, LOCK, LOCK, LOCK
		D1.1 	Par défaut, VERROUILLE,VERROUILLE,VERROUILLE
	Program bypass option with oem remote:	C1	OEM Remote Monitoring
	Program bypass option with RF KIT antenna:	H1 to H6	Supported RF Kits and select RF Kit

REMOTE STARTER FUNCTIONALITY



All doors must be closed.

3X 

Press the OEM remote's Lock button 3x to remote-start (or remote-stop) the vehicle.



START 

The vehicle will START.

REMOTE STARTER DIAGNOSTICS
MODULE RED LED

x2 flash :	Brake ON
x3 flash :	No tach
x4 flash :	Ignition before start
x5 flash :	Hood Open

REMOTE STARTER WARNING CARD



CUT THIS WARNING CARD AND STICK IT ON A VISIBLE PLACE:
 or use the package RSPB, Sold separately.

WARNING



REMOTE STARTER

THE VEHICLE CAN BE STARTED BY EITHER: PRESSING THE LOCK BUTTON ON THE OEM REMOTE 3 TIMES CONSECUTIVELY OR BY A SMARTPHONE. **TURN ON** THE SAFETY SWITCH LOCATED UNDER THE DASHBOARD BEFORE WORKING ON THE VEHICLE.

DESCRIPTION



At the BCM



③

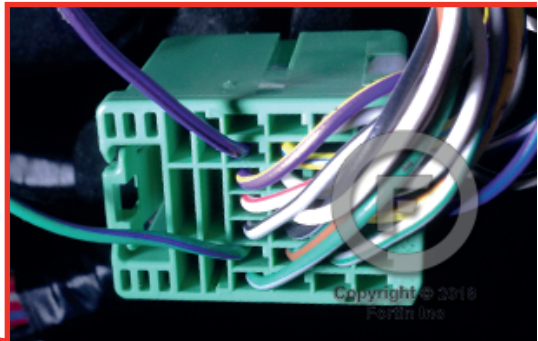

①



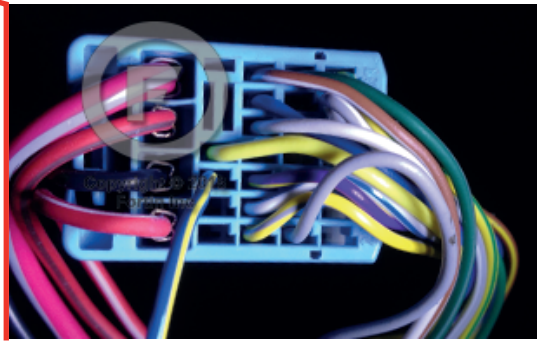

②

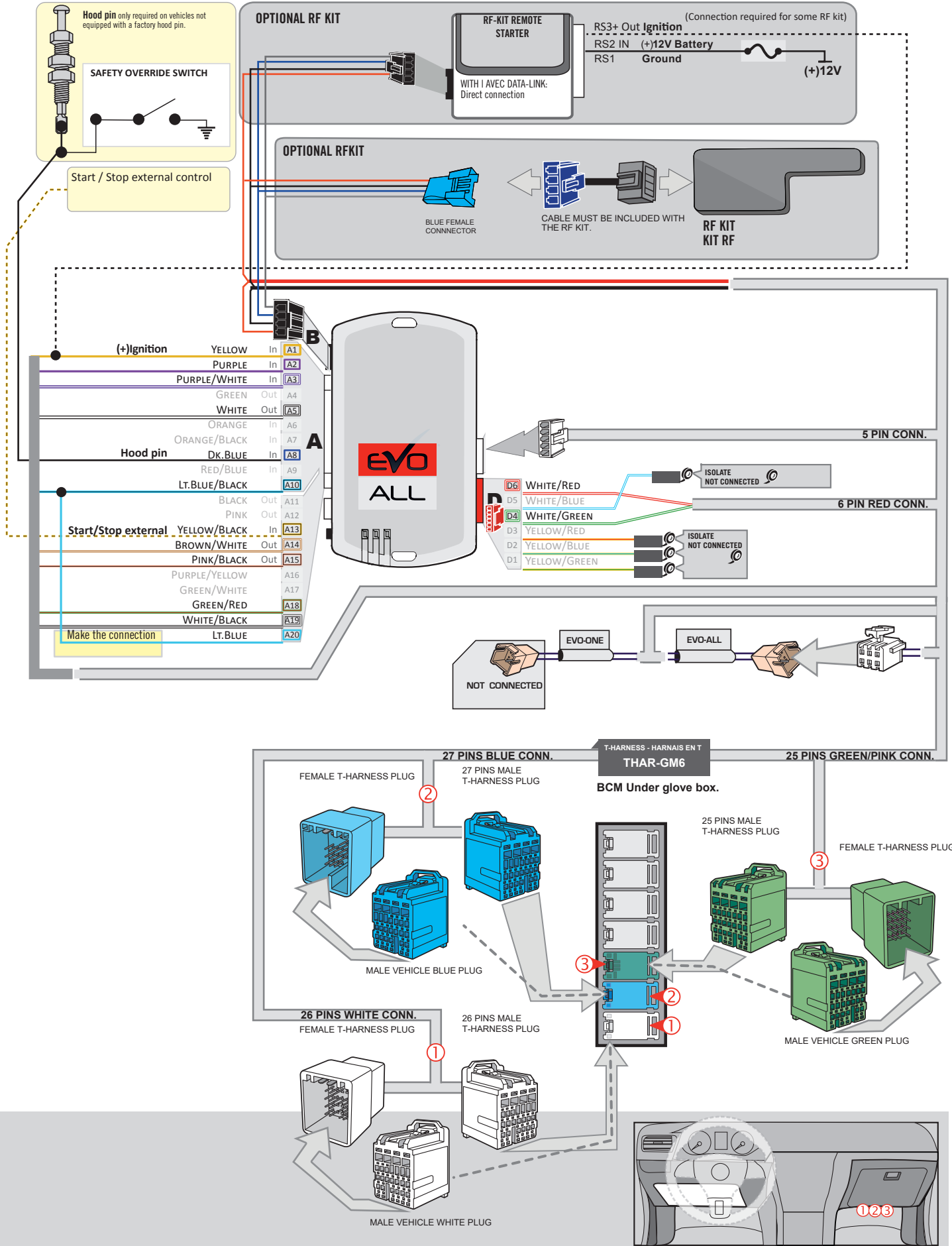

AUTOMATIC TRANSMISSION WIRING CONNECTION

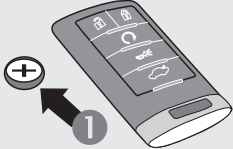
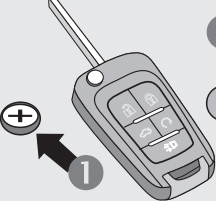

KEY BYPASS PROGRAMMING PROCEDURE 1/3

FIRST GENERATION	 <p>1 Remove the battery from the OEM remote.</p> <p>2 First generation OEM remotes: Place the OEM remotes in the key older.</p>	
SECOND GENERATION	 <p>1 Remove the battery from the OEM remote.</p> <p>2 Second generation OEM remotes: Place the OEM remotes in to the center console.</p>	

1

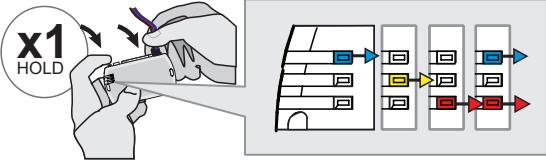

Press and hold the programming button:
Connect the 4-PIN Data-link harness (Black connector).

↳The Blue, Red, Yellow and Blue & Red LEDs will alternatively illuminate.

2

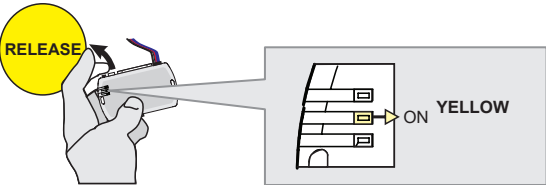

Release the programming button when the LED is YELLOW.

If the LED is not solid YELLOW disconnect the 4-Pin connector (Data-Link) and go back to step 1.

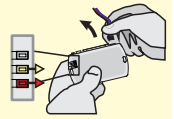

3

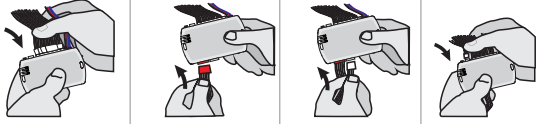

Insert the required remaining connectors.

4

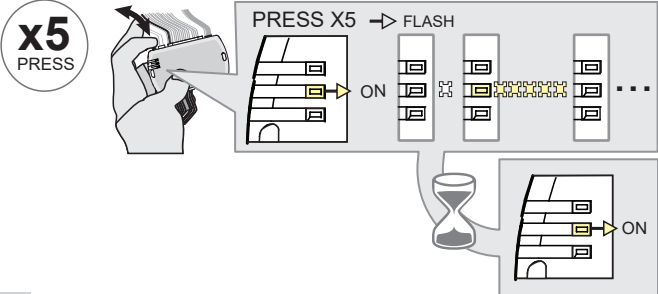

Press and release the programming button five (5x) times.

↳The YELLOW LED will flash 5 times each second.

↳WAIT for the YELLOW LED to turn ON solide.

5

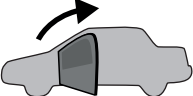

Open the driver door.

6

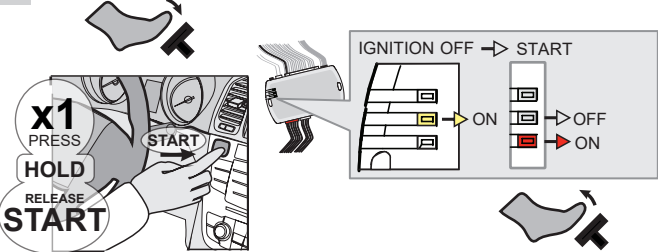

Press the foot-brake pedal.

Press the Push-to-Start button until the engine start.

Release the foot-brake pedal.

↳The RED LED will turn ON.
 ↳The YELLOW LED will turn OFF.

KEY BYPASS PROGRAMMING PROCEDURE 2/3

7



Press the Push-to-Start button until the engine turn OFF.

8

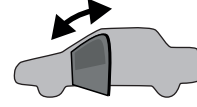

Close and open the driver door.

9

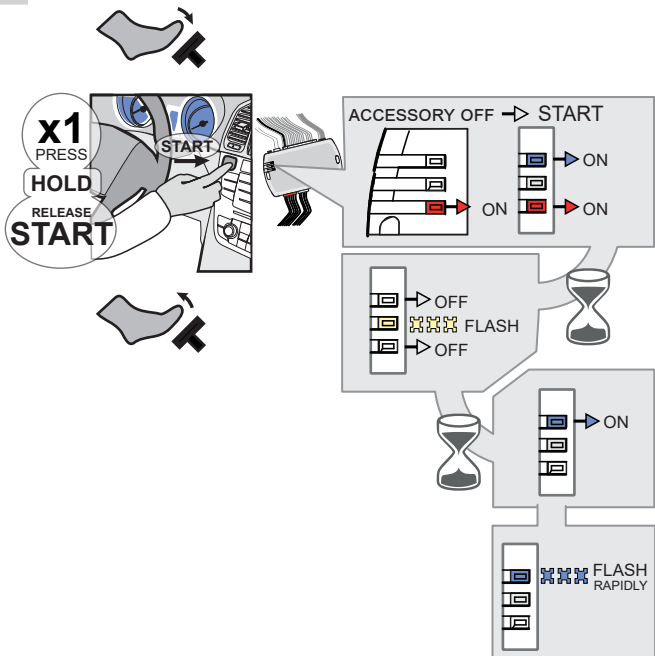

Press the foot-brake pedal.

Press the Push-to-Start button until the engine start.

Release the foot-brake pedal.

- ↳ The BLUE LED will turn ON.
- ↳ The BLUE LED will turn OFF. The RED LED will turn OFF.
- ↳ The YELLOW LED will flash rapidly
- ↳ The BLUE LED will turn ON.
- ↳ The BLUE LED will flash rapidly

10

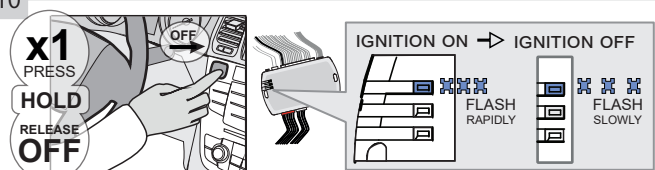

Press the Push-to-Start button until the engine turn OFF.

- ↳ The BLUE LED will flash slowly

11

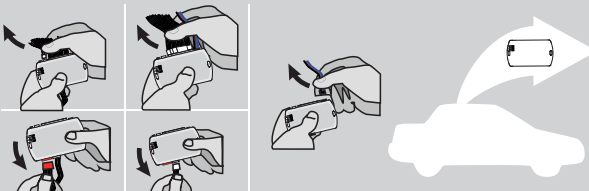

Disconnect all the connectors and after the Data-Link (4-pins) connector.

12

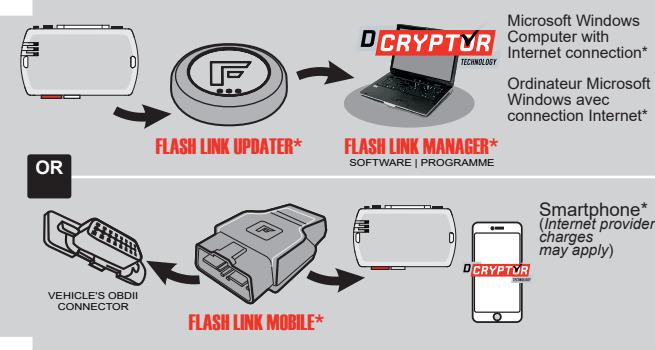

Use the tool: FLASH LINK UPDATER or FLASH LINK MOBILE to visit the DCRYPTOR menu.

***Parts required (not included)**

KEY BYPASS PROGRAMMING PROCEDURE 3/3

13

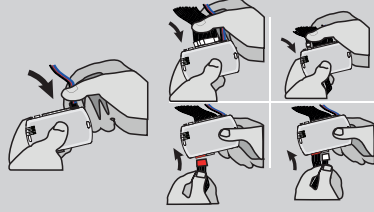
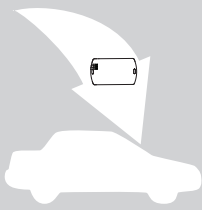

AFTER DCRYPTOR PROGRAMMING COMPLETED
Go back to the vehicle and **reconnect** the 4-Pin (Data-Link) connector and after, all the remaining connector.



The module is now programmed.



REMOTE STARTER / ALARM VERIFICATION PROCEDURE

Test the remote starter. Remote start the vehicle.

REMOTE STARTER FUNCTIONALITY



All doors must be closed.

Remote start the vehicle.



Press the Unlock button of the remote car starter.



Enter the vehicle with the Intelligent Access Key.



The vehicle can now be put in to gear and driven.



If the vehicle is not unlocked the module will shut down the remote-starter and the vehicle as soon as any door is opened.

THAR-GM6

THARNNESS STAND ALONE INSTALLATION

ADDENDUM - SUGGESTED WIRING CONFIGURATION



ONLY COMPATIBLE WITH AUTOMATIC TRANSMISSION VEHICLES.

VEHICLE	YEARS	Vehicle functions supported in this diagram (functional if equipped)															
		Immobilizer bypass	Lock	Unlock	Arm	Disarm	Trunk (open)	RAP Disable	Tachometer	Heated Seats	Door Status	Trunk Status	Hand-Brake Status	Foot-Brake Status	OEM Remote Monitoring		
																	
CHEVROLET																	
Cruze	Push-To-Start	2012-2015	•	•	•	•	•	•	•	•	•	•	•	•	•	•	•



FIRMWARE VERSION

70.[41]

GM MINIMUM

To add the firmware version and the options, use the **FLASH LINK UPDATER** or **FLASH LINK MOBILE** tool, sold separately.

<p>IF THE VEHICLE IS NOT EQUIPPED WITH FUNCTIONAL HOOD PIN:</p>	A11	OFF	Hood trigger (Output Status).
--	-----	-----	-------------------------------

	Program bypass option:	UNIT OPTION	DESCRIPTION
		C1	OEM Remote status (Lock/Unlock) monitoring
		D6	Push-to-Start

	ATTENTION!	 <p>DATE: XX-XX</p>	<table border="1" style="width: 100%; border-collapse: collapse;"> <tr> <td style="text-align: center; font-size: 24px; font-weight: bold;">E5</td> <td style="text-align: center; background-color: #d9534f; color: white; padding: 5px;">OFF</td> </tr> <tr> <td></td> <td style="text-align: center; background-color: #5cb85c; color: white; padding: 5px;">ON</td> </tr> </table>	E5	OFF		ON	<p>SPECIAL FUNCTIONS: BY DEFAULT DEACTIVATED</p> <p>MANUFACTURED MODULES BETWEEN: 04/2018 TO 04/2019</p>
E5	OFF							
	ON							



Parts required (Not included)

1X THAR-GM6

MANDATORY INSTALL

*HOOD PIN



HOOD STATUS: THE HOOD PIN SWITCH MUST BE INSTALLED IF THE VEHICLE CAN BE REMOTE STARTED WITH THE HOOD OPEN, SET FUNCTION **A11** TO OFF.

A11	OFF
-----	-----

Notice: the installation of safety elements are mandatory. The hood pin is an essential security element and must be installed.

THIS MODULE MUST BE INSTALLED BY A QUALIFIED TECHNICIAN. A WRONG CONNECTION CAN CAUSE PERMANENT DAMAGE TO THE VEHICLE.

PARTS REQUIRED (NOT INCLUDED)

1x **FLASH LINK UPDATER**
 1x **FLASH LINK MANAGER**
SOFTWARE | PROGRAMME
 1x Microsoft Windows Computer with Internet connection

OR

1x **FLASH LINK MOBILE**
 1x **FLASH LINK MOBILE APP**
Smartphone Android or iOS with Internet connection (provider charges may apply).

MANDATORY

HOOD PIN



REMOTE START SAFETY OVERRIDE SWITCH

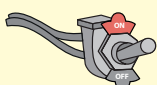





VALET SWITCH

Part #: RSPB available, Sold separately.

Notice: the installation of safety elements are mandatory. The hood pin and the valet switch are essential security elements and must be installed.

STAND ALONE CONFIGURATION

	Program bypass option	UNIT OPTION	DESCRIPTION
	OEM Remote Stand Alone Remote Starter:	D1.10 	By default, LOCK, LOCK, LOCK Par défaut, VERROUILLE,VERROUILLE,VERROUILLE
		D1.1 	
	Program bypass option with oem remote:	C1	OEM Remote Monitoring
	Program bypass option with RF KIT antenna:	H1 to H6	Supported RF Kits and select RF Kit

REMOTE STARTER FUNCTIONALITY



All doors must be closed.

3X 

Press the OEM remote's Lock button 3x to remote-start (or remote-stop) the vehicle.



START

The vehicle will START.

REMOTE STARTER DIAGNOSTICS
MODULE RED LED

x2 flash :	Brake ON
x3 flash :	No tach
x4 flash :	Ignition before start
x5 flash :	Hood Open

REMOTE STARTER WARNING CARD



CUT THIS WARNING CARD AND STICK IT ON A VISIBLE PLACE:
 or use the package RSPB, Sold separately.

WARNING

REMOTE STARTER

THE VEHICLE CAN BE STARTED BY EITHER: PRESSING THE LOCK BUTTON ON THE OEM REMOTE 3 TIMES CONSECUTIVELY OR BY A SMARTPHONE. **TURN ON** THE SAFETY SWITCH LOCATED UNDER THE DASHBOARD BEFORE WORKING ON THE VEHICLE.

DESCRIPTION



BCM

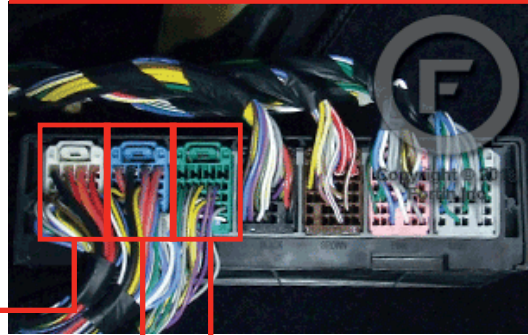

①



②

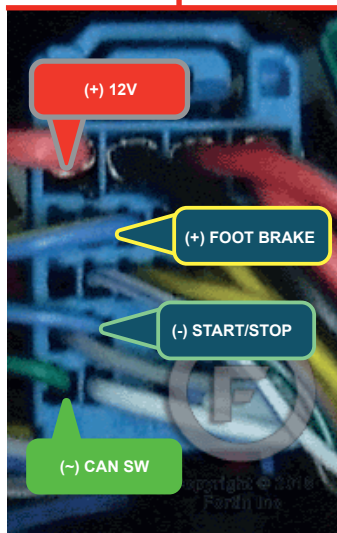

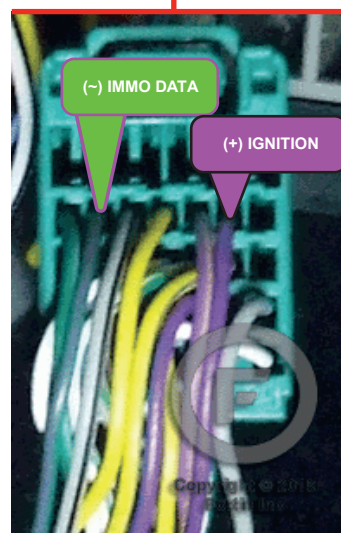

③

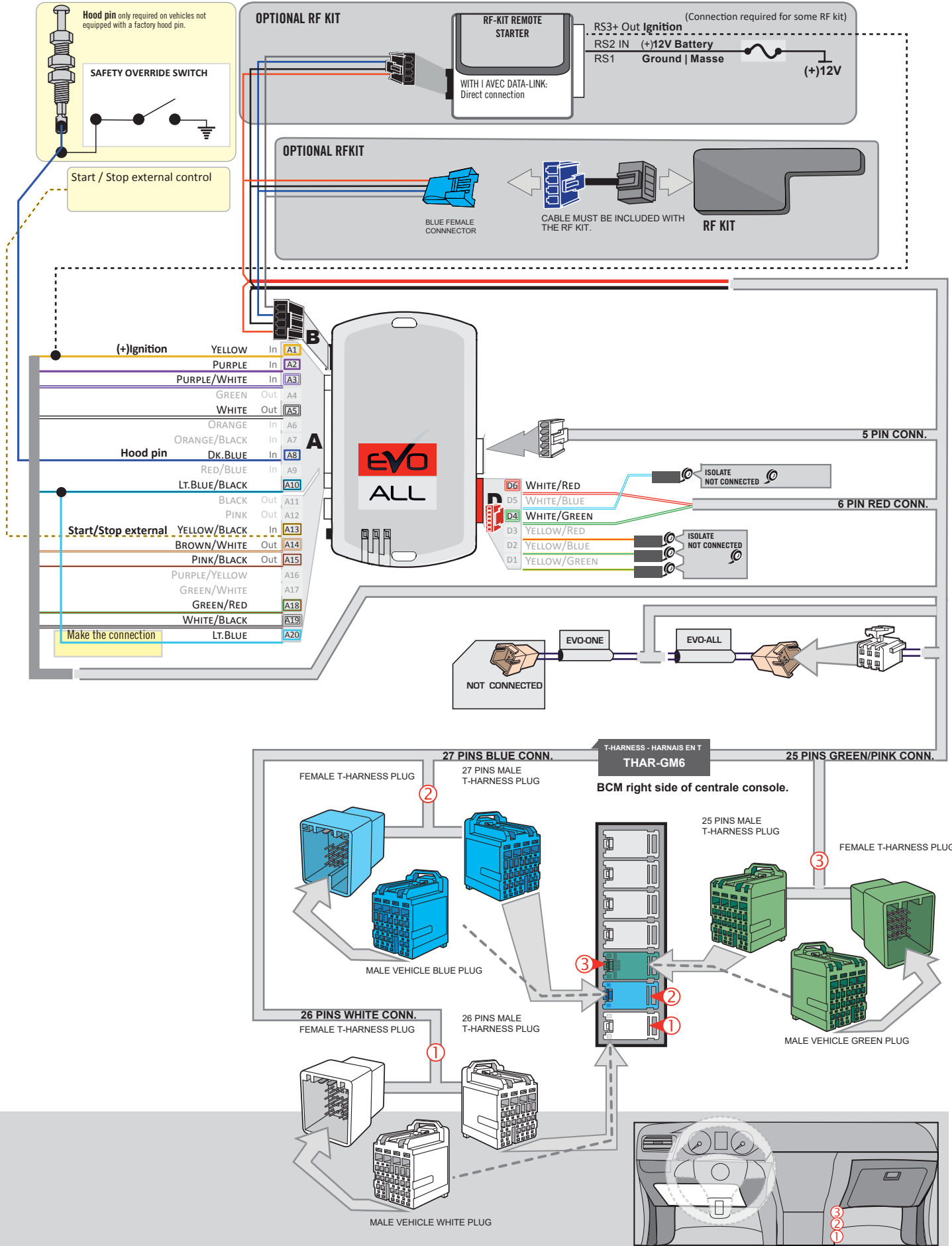

AUTOMATIC TRANSMISSION WIRING CONNECTION

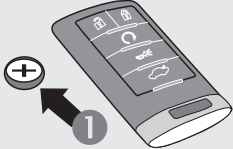
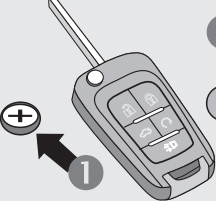

KEY BYPASS PROGRAMMING PROCEDURE 1/3

FIRST GENERATION	 <p>1 Remove the battery from the OEM remote.</p> <p>2 First generation OEM remotes: Place the OEM remotes in the key older.</p>	
SECOND GENERATION	 <p>1 Remove the battery from the OEM remote.</p> <p>2 Second generation OEM remotes: Place the OEM remotes in to the center console.</p>	

1

x1 HOLD

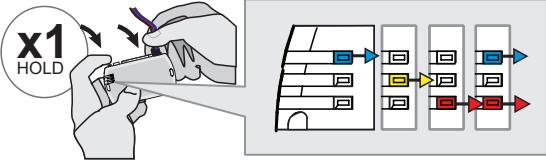

Press and hold the programming button:
Connect the 4-PIN Data-link harness (Black connector).
 ↳The Blue, Red, Yellow and Blue & Red LEDs will alternatively illuminate.

2

RELEASE

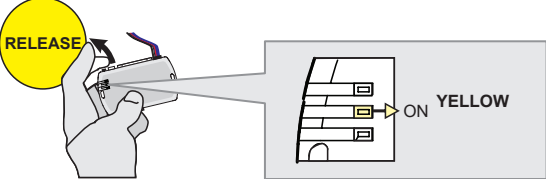

Release the programming button when the LED is YELLOW.
 If the LED is not solid YELLOW disconnect the 4-Pin connector (Data-Link) and go back to step 1.

3

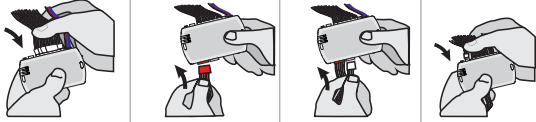

Insert the required remaining connectors.

4

x5 PRESS

PRESS X5 → FLASH

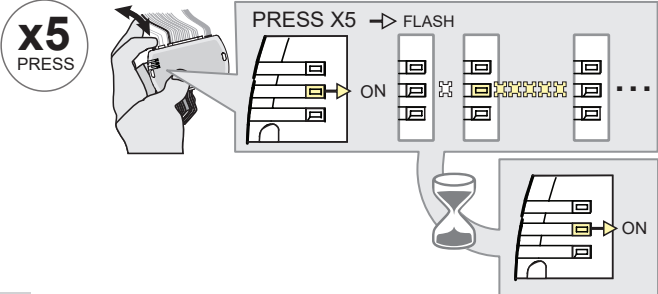

Press and release the programming button five (5x) times.
 ↳The YELLOW LED will flash 5 times each second.
 ↳**WAIT** for the YELLOW LED to turn ON solide.

5

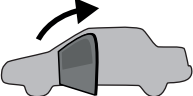

Open the driver door.

6

x1 PRESS
HOLD
RELEASE
START

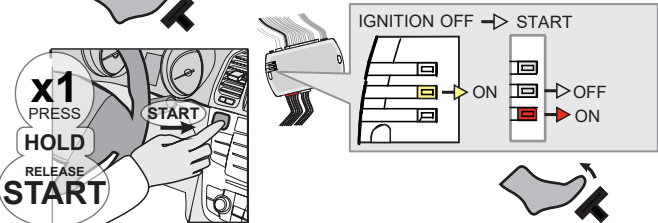

Press the foot-brake pedal.
Press the Push-to-Start button until the engine start.
Release the foot-brake pedal.
 ↳The RED LED will turn ON.
 ↳The YELLOW LED will turn OFF.

KEY BYPASS PROGRAMMING PROCEDURE 2/3

7



Press the Push-to-Start button until the engine turn OFF.

8

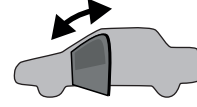

Close and open the driver door.

9

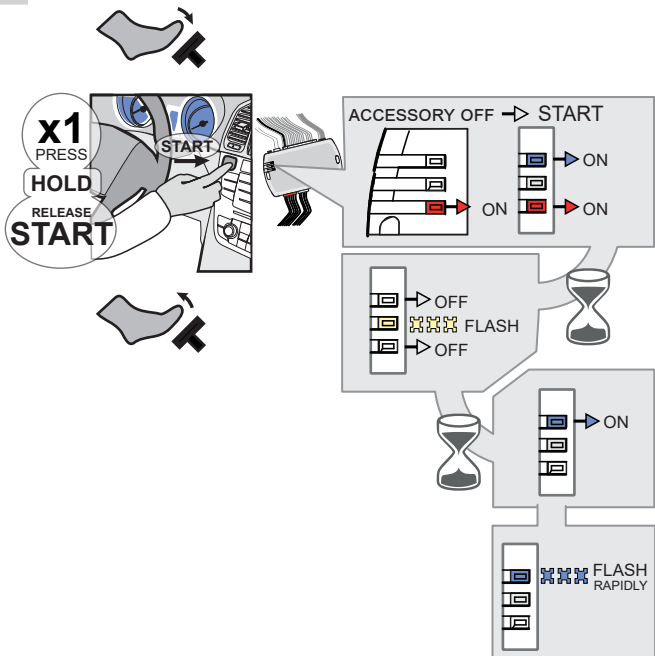

Press the foot-brake pedal.

Press the Push-to-Start button until the engine start.

Release the foot-brake pedal.

- ↳ The BLUE LED will turn ON.
- ↳ The BLUE LED will turn OFF. The RED LED will turn OFF.
- ↳ The YELLOW LED will flash rapidly
- ↳ The BLUE LED will turn ON.
- ↳ The BLUE LED will flash rapidly

10

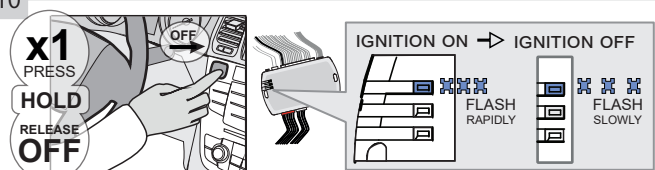

Press the Push-to-Start button until the engine turn OFF.

- ↳ The BLUE LED will flash slowly

11

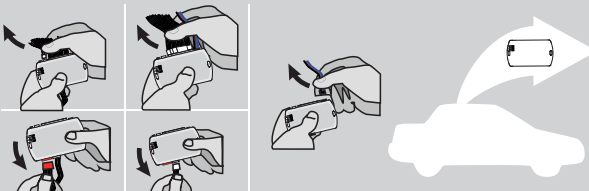

Disconnect all the connectors and after the Data-Link (4-pins) connector.

12

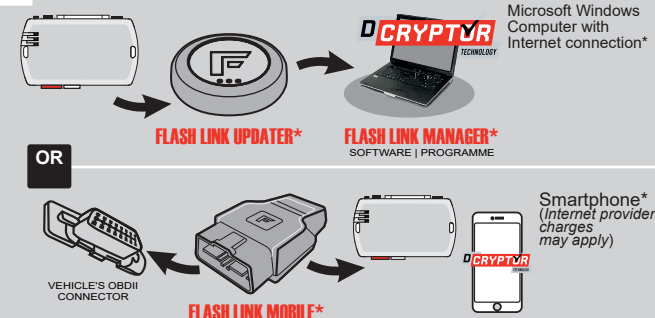

Microsoft Windows Computer with Internet connection*

FLASH LINK UPDATER* FLASH LINK MANAGER*
SOFTWARE | PROGRAMME

OR

Smartphone* (Internet provider charges may apply)

VEHICLE'S OBDII CONNECTOR FLASH LINK MOBILE*

Use the tool: FLASH LINK UPDATER or FLASH LINK MOBILE to visit the DCryptor menu.

*Parts required (not included)

KEY BYPASS PROGRAMMING PROCEDURE 3/3

13

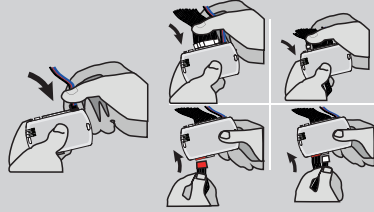
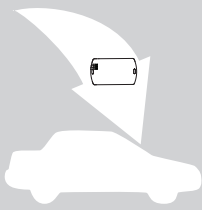

AFTER DCRYPTOR PROGRAMMING COMPLETED
Go back to the vehicle and **reconnect** the 4-Pin (Data-Link) connector and after, all the remaining connector.



The module is now programmed.



REMOTE STARTER / ALARM VERIFICATION PROCEDURE

Test the remote starter. Remote start the vehicle.

REMOTE STARTER FUNCTIONALITY



All doors must be closed.

Remote start the vehicle.



Press the Unlock button of the remote car starter.



Enter the vehicle with the Intelligent Access Key.



The vehicle can now be put in to gear and driven.



If the vehicle is not unlocked the module will shut down the remote-starter and the vehicle as soon as any door is opened.

THAR-GM6

THARNNESS STAND ALONE INSTALLATION

ADDENDUM - SUGGESTED WIRING CONFIGURATION



ONLY COMPATIBLE WITH AUTOMATIC TRANSMISSION VEHICLES.



Vehicle functions supported in this diagram (functional if equipped)

VEHICLE	YEARS	Immobilizer bypass	Lock	Unlock	Arm	Disarm	Trunk (open)	RAP Disable	Tachometer	Heated Seats	Door Status	Trunk Status	Hand-Brake Status	Foot-Brake Status	OEM Remote Monitoring
CHEVROLET															
Cruze	Push-To-Start	2016-2019	•	•	•	•	•	•	•	•	•	•	•	•	•

FIRMWARE VERSION

70.[41]

GM MINIMUM

To add the firmware version and the options, use the **FLASH LINK UPDATER** or **FLASH LINK MOBILE** tool, sold separately.

<p style="color: red; font-weight: bold;">IF THE VEHICLE IS NOT EQUIPPED WITH FUNCTIONAL HOOD PIN:</p>	A11	OFF	Hood trigger (Output Status).
--	-----	-----	-------------------------------

	Program bypass option:	UNIT OPTION	DESCRIPTION
		C1	OEM Remote status (Lock/Unlock) monitoring
		D6	Push-to-Start

	ATTENTION!	<p style="font-size: 10px;">DATE: XX-XX</p>	E5	OFF	<p>SPECIAL FUNCTIONS: BY DEFAULT DEACTIVATED</p>
				ON	<p>MANUFACTURED MODULES BETWEEN: 04/2018 TO 04/2019 M</p>

Parts required (Not included)

1X THAR-GM6

MANDATORY INSTALL

*HOOD PIN



HOOD STATUS: THE HOOD PIN SWITCH MUST BE INSTALLED IF THE VEHICLE CAN BE REMOTE STARTED WITH THE HOOD OPEN, SET FUNCTION A11 TO OFF.

A11

OFF

Notice: the installation of safety elements are mandatory. The hood pin is an essential security element and must be installed.

THIS MODULE MUST BE INSTALLED BY A QUALIFIED TECHNICIAN. A WRONG CONNECTION CAN CAUSE PERMANENT DAMAGE TO THE VEHICLE.

PARTS REQUIRED (NOT INCLUDED)

1x **FLASH LINK UPDATER,**
 1x **FLASH LINK MANAGER**
 SOFTWARE | PROGRAMME
 1x Microsoft Windows Computer with Internet connection

OR

1x **FLASH LINK MOBILE**
 1x **FLASH LINK MOBILE APP**
 Smartphone *Android* or *iOS* with Internet connection (*provider charges may apply*).

MANDATORY

HOOD PIN



REMOTE START SAFETY OVERRIDE SWITCH

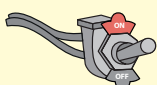





VALET SWITCH

Part #: RSPB available, Sold separately.

Notice: the installation of safety elements are mandatory. The hood pin and the valet switch are essential security elements and must be installed.

STAND ALONE CONFIGURATION

	Program bypass option	UNIT OPTION	DESCRIPTION
	OEM Remote Stand Alone Remote Starter:	D1.10 	By default, LOCK, LOCK, LOCK Par défaut, VERROUILLE,VERROUILLE,VERROUILLE
		D1.1 	
	Program bypass option with oem remote:	C1	OEM Remote Monitoring
	Program bypass option with RF KIT antenna:	H1 to H6	Supported RF Kits and select RF Kit

REMOTE STARTER FUNCTIONALITY



All doors must be closed.

3X 

Press the OEM remote's Lock button 3x to remote-start (or remote-stop) the vehicle.



START

The vehicle will START.

REMOTE STARTER DIAGNOSTICS
MODULE RED LED

x2 flash :	Brake ON
x3 flash :	No tach
x4 flash :	Ignition before start
x5 flash :	Hood Open

REMOTE STARTER WARNING CARD



CUT THIS WARNING CARD AND STICK IT ON A VISIBLE PLACE:
 or use the package **RSPB**, Sold separately.

WARNING | ATTENTION

REMOTE STARTER

THE VEHICLE CAN BE STARTED BY EITHER: PRESSING THE LOCK BUTTON ON THE OEM REMOTE 3 TIMES CONSECUTIVELY OR BY A SMARTPHONE. **TURN ON** THE SAFETY SWITCH LOCATED UNDER THE DASHBOARD BEFORE WORKING ON THE VEHICLE.

DESCRIPTION



BCM, Above Driver kick panel

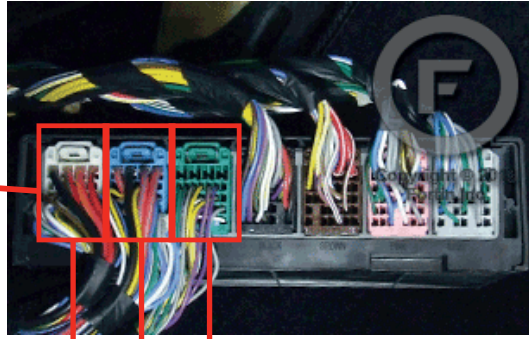

①



②

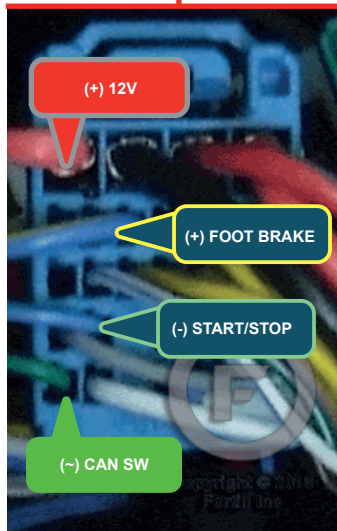

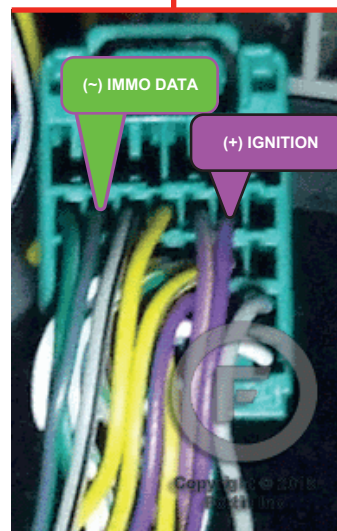

③

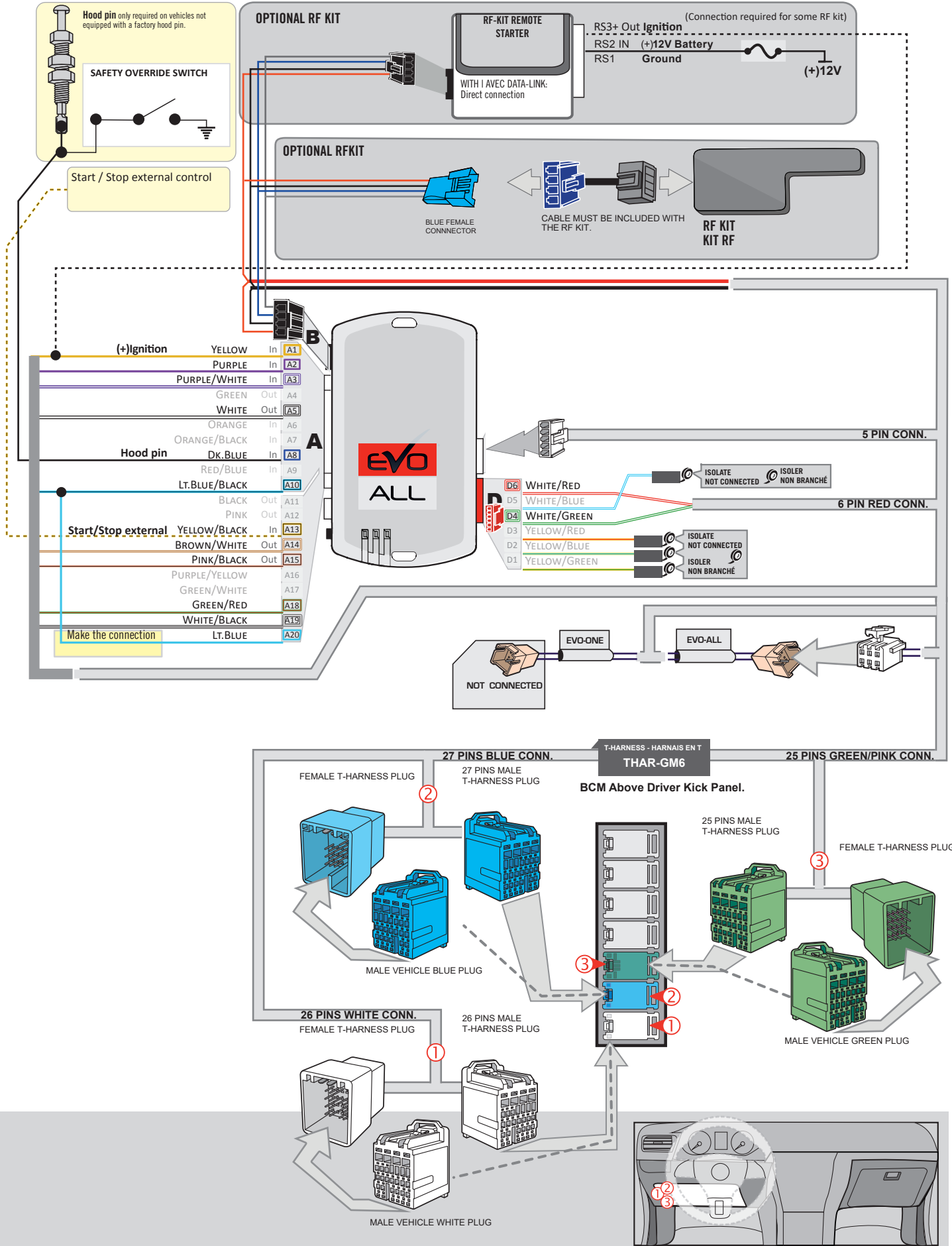

AUTOMATIC TRANSMISSION WIRING CONNECTION

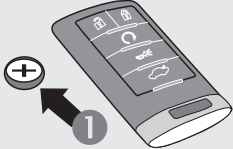
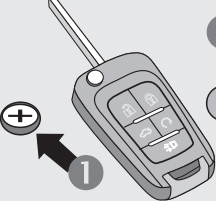

KEY BYPASS PROGRAMMING PROCEDURE 1/3

FIRST GENERATION	 <p>1 Remove the battery from the OEM remote.</p> <p>2 First generation OEM remotes: Place the OEM remotes in the key older.</p>	
SECOND GENERATION	 <p>1 Remove the battery from the OEM remote.</p> <p>2 Second generation OEM remotes: Place the OEM remotes in to the center console.</p>	

1

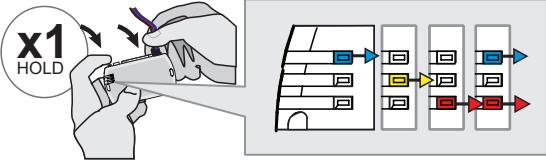

Press and hold the programming button:
Connect the 4-PIN Data-link harness (Black connector).

↳The Blue, Red, Yellow and Blue & Red LEDs will alternatively illuminate.

2

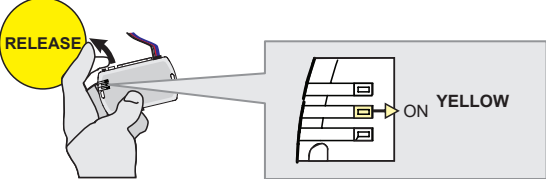

Release the programming button when the LED is YELLOW.

If the LED is not solid YELLOW disconnect the 4-Pin connector (Data-Link) and go back to step 1.

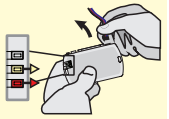

3

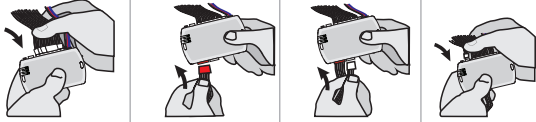

Insert the required remaining connectors.

4

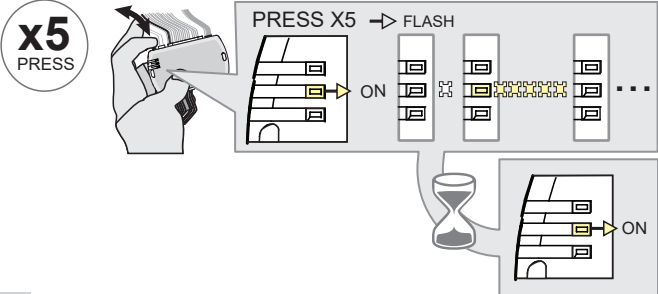

Press and release the programming button five (5x) times.

↳The YELLOW LED will flash 5 times each second.

↳WAIT for the YELLOW LED to turn ON solide.

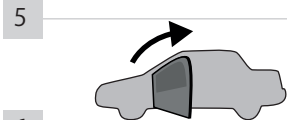

Open the driver door.

6

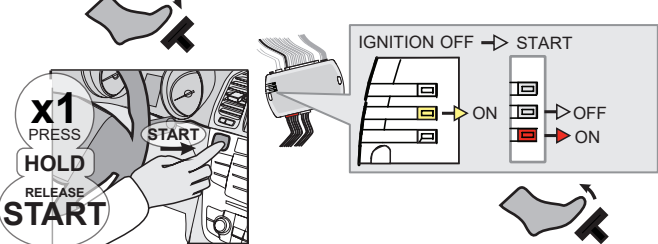

Press the foot-brake pedal.

Press the Push-to-Start button until the engine start.

Release the foot-brake pedal.

↳The RED LED will turn ON.
 ↳The YELLOW LED will turn OFF.

KEY BYPASS PROGRAMMING PROCEDURE 2/3

7



Press the Push-to-Start button until the engine turn OFF.

8

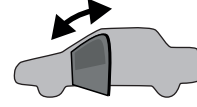

Close and open the driver door.

9

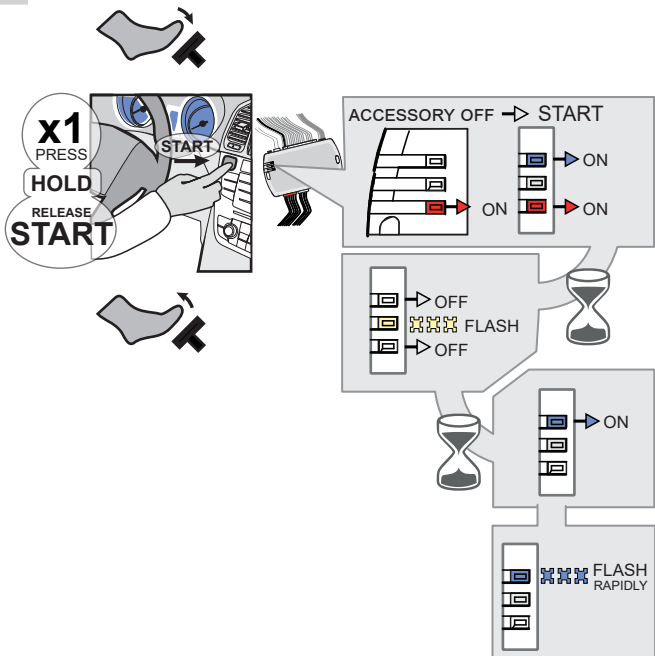

Press the foot-brake pedal.

Press the Push-to-Start button until the engine start.

Release the foot-brake pedal.

- ↳ The BLUE LED will turn ON.
- ↳ The BLUE LED will turn OFF. The RED LED will turn OFF.
- ↳ The YELLOW LED will flash rapidly
- ↳ The BLUE LED will turn ON.
- ↳ The BLUE LED will flash rapidly

10

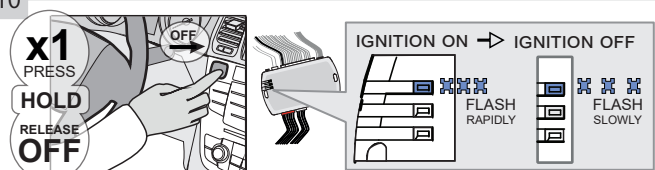

Press the Push-to-Start button until the engine turn OFF.

- ↳ The BLUE LED will flash slowly

11

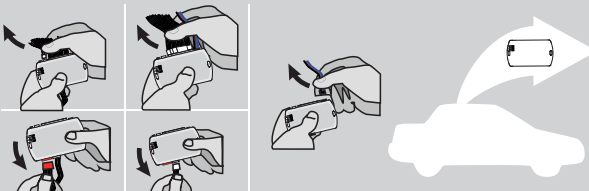

Disconnect all the connectors and after the Data-Link (4-pins) connector.

12

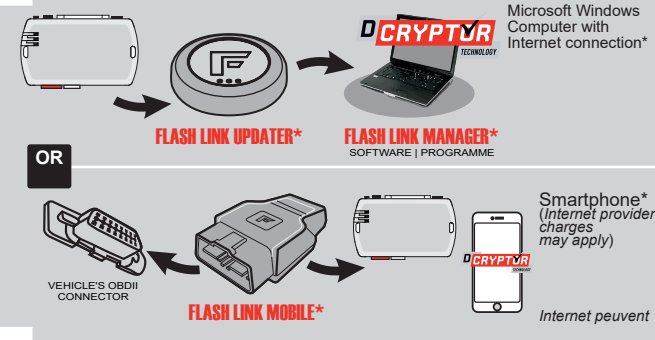

Microsoft Windows Computer with Internet connection*

Smartphone* (Internet provider charges may apply)

Internet peuvnt

Use the tool: FLASH LINK UPDATER or FLASH LINK MOBILE to visit the DCryptor menu.

*Parts required (not included)

KEY BYPASS PROGRAMMING PROCEDURE 3/3

13

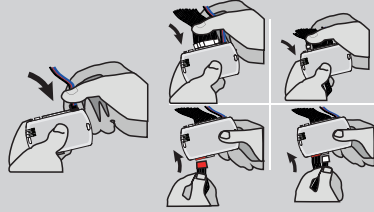
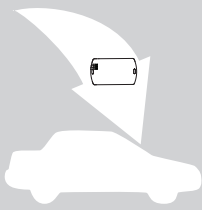

AFTER DCRYPTOR PROGRAMMING COMPLETED
Go back to the vehicle and **reconnect** the 4-Pin (Data-Link) connector and after, all the remaining connector.



The module is now programmed.



REMOTE STARTER / ALARM VERIFICATION PROCEDURE

Test the remote starter. Remote start the vehicle.

REMOTE STARTER FUNCTIONALITY



All doors must be closed.

Remote start the vehicle.



Press the Unlock button of the remote car starter.



Enter the vehicle with the Intelligent Access Key.



The vehicle can now be put in to gear and driven.



If the vehicle is not unlocked the module will shut down the remote-starter and the vehicle as soon as any door is opened.

THAR-GM6

THARNNESS STAND ALONE INSTALLATION

ADDENDUM - SUGGESTED WIRING CONFIGURATION



ONLY COMPATIBLE WITH AUTOMATIC TRANSMISSION VEHICLES.



Vehicle functions supported in this diagram (functional if equipped)

VEHICLE

YEARS

Immobilizer bypass

Lock

Unlock

Arm

Disarm

Trunk (open)

RAP Disable

Tachometer

Heated Seats

Door Status

Trunk Status

Hand-Brake Status

Foot-Brake Status

OEM Remote Monitoring

BUICK

Encore GX

Push-To-Start

2020-2021

•

•

•

•

•

•

•

•

•

•

•

•

•

•



FIRMWARE VERSION

70.[45]

GM MINIMUM

To add the firmware version and the options, use the **FLASH LINK UPDATER** or **FLASH LINK MOBILE** tool, sold separately.



Program bypass option:

UNIT OPTION

DESCRIPTION

C1

OEM Remote status (Lock/Unlock) monitoring

IF THE VEHICLE IS NOT EQUIPPED WITH FUNCTIONAL HOOD PIN:

A11

OFF

Hood trigger (Output Status).

D6

Push-to-Start



ATTENTION!

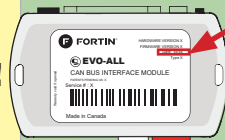

DATE: XX-XX

E5

OFF

SPECIAL FUNCTIONS: BY DEFAULT DEACTIVATED

ON

MANUFACTURED MODULES BETWEEN: 04/2018 TO 04/2019



Parts required (Not included)

1X THAR-GM6

MANDATORY INSTALL

*HOOD PIN



HOOD STATUS: THE HOOD PIN SWITCH MUST BE INSTALLED IF THE VEHICLE CAN BE REMOTE STARTED WITH THE HOOD OPEN, SET FUNCTION **A11** TO OFF.

A11

OFF

Notice: the installation of safety elements are mandatory. The hood pin is an essential security element and must be installed.

THIS MODULE MUST BE INSTALLED BY A QUALIFIED TECHNICIAN. A WRONG CONNECTION CAN CAUSE PERMANENT DAMAGE TO THE VEHICLE.

PARTS REQUIRED (NOT INCLUDED)

1x **FLASH LINK UPDATER**
 1x **FLASH LINK MANAGER**
SOFTWARE | PROGRAMME
 1x Microsoft Windows Computer with Internet connection

OR

1x **FLASH LINK MOBILE**
 1x **FLASH LINK MOBILE APP**
Smartphone Android or iOS with Internet connection (provider charges may apply).

MANDATORY

HOOD PIN



REMOTE START SAFETY OVERRIDE SWITCH

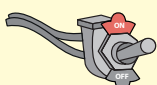





VALET SWITCH

Part #: RSPB available, Sold separately.

Notice: the installation of safety elements are mandatory. The hood pin and the valet switch are essential security elements and must be installed.

STAND ALONE CONFIGURATION

	Program bypass option	UNIT OPTION	DESCRIPTION
	OEM Remote Stand Alone Remote Starter:	D1.10 	By default, LOCK, LOCK, LOCK
		D1.1 	Par défaut, VERROUILLE,VERROUILLE,VERROUILLE
	Program bypass option with oem remote:	C1	OEM Remote Monitoring
	Program bypass option with RF KIT antenna:	H1 to H6	Supported RF Kits and select RF Kit

REMOTE STARTER FUNCTIONALITY



All doors must be closed.

3X 

Press the OEM remote's Lock button 3x to remote-start (or remote-stop) the vehicle.



START 

The vehicle will START.

REMOTE STARTER DIAGNOSTICS
MODULE RED LED

x2 flash :	Brake ON
x3 flash :	No tach
x4 flash :	Ignition before start
x5 flash :	Hood Open

REMOTE STARTER WARNING CARD



CUT THIS WARNING CARD AND STICK IT ON A VISIBLE PLACE:
 or use the package RSPB, Sold separately.

WARNING

REMOTE STARTER

THE VEHICLE CAN BE STARTED BY EITHER: PRESSING THE LOCK BUTTON ON THE OEM REMOTE 3 TIMES CONSECUTIVELY OR BY A SMARTPHONE. **TURN ON** THE SAFETY SWITCH LOCATED UNDER THE DASHBOARD BEFORE WORKING ON THE VEHICLE.

DESCRIPTION



③ BCM Right side of the center console, passenger side.



②

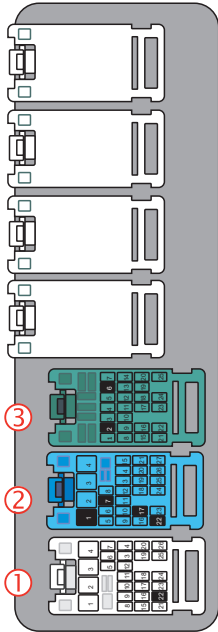
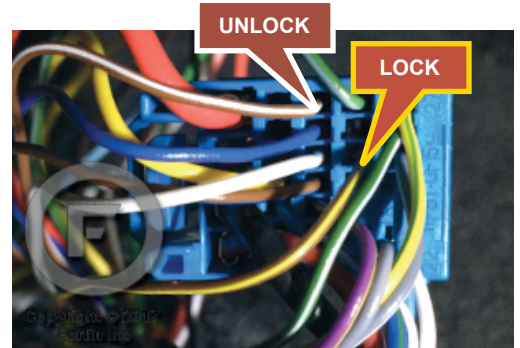
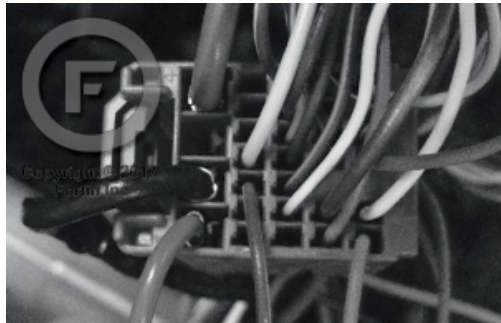

①



AUTOMATIC TRANSMISSION WIRING CONNECTION

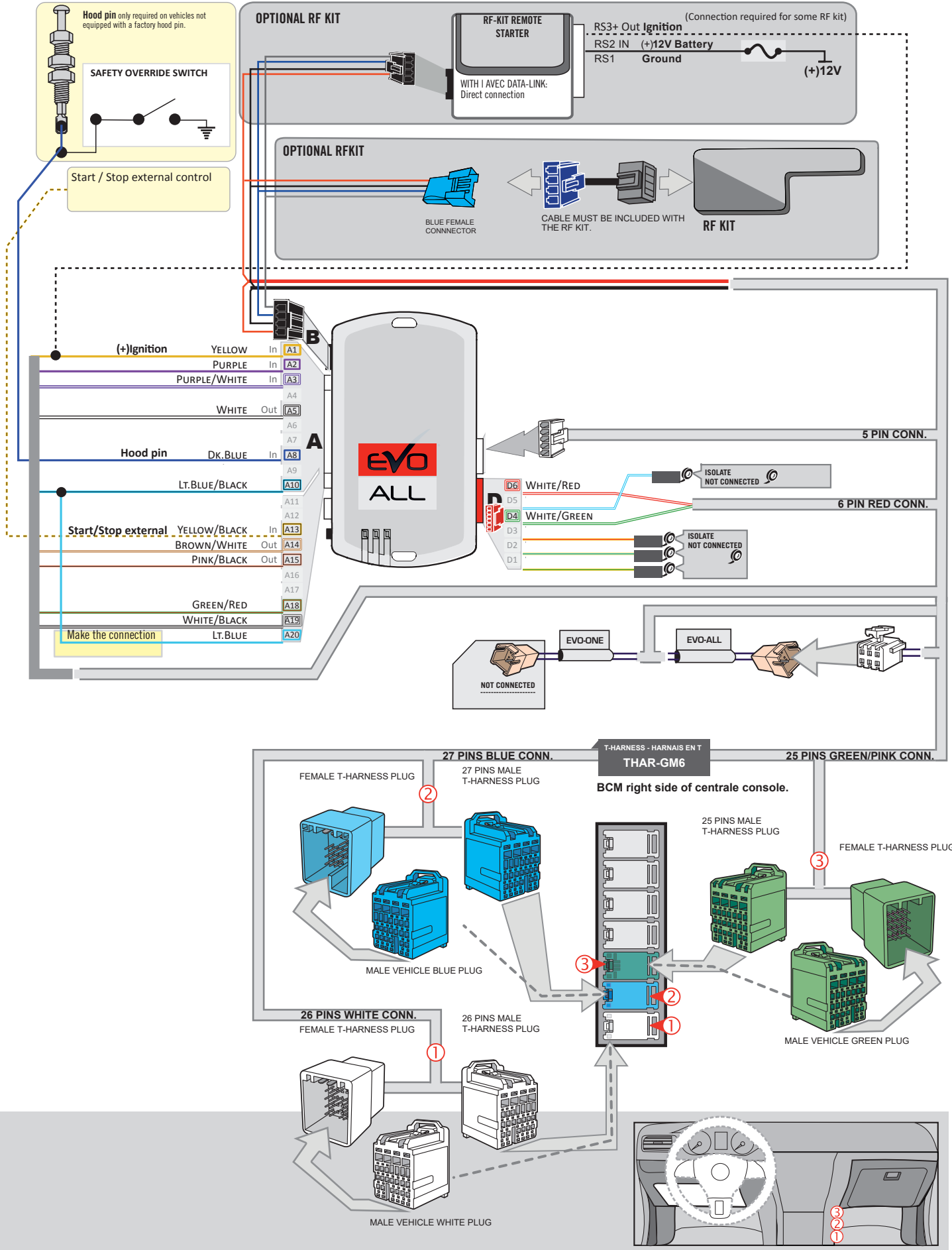

KEY BYPASS PROGRAMMING PROCEDURE 1/3

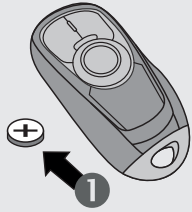

- 1** Remove the battery from the OEM remote.
- 2** Place the OEM in the remote Key reader behind cup holders in the center console.

Refer to vehicle user guide for keyport location.

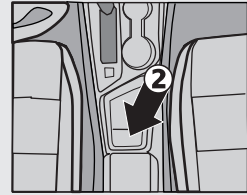

1

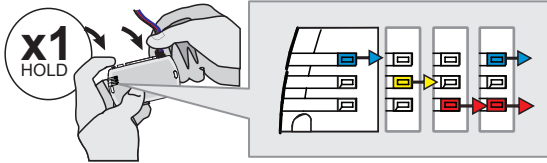

Press and hold the programming button:
Connect the 4-PIN Data-link harness (Black connector).

↳The Blue, Red, Yellow and Blue & Red LEDs will alternatively illuminate.

2

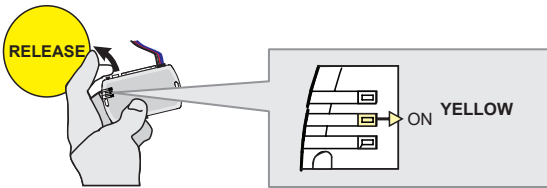

Release the programming button when the LED is **YELLOW**.

If the LED is not solid **YELLOW** disconnect the 4-Pin connector (Data-Link) and go back to step 1.

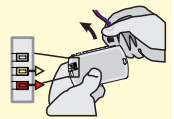

3

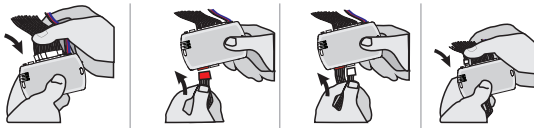

Insert the required remaining connectors.

4

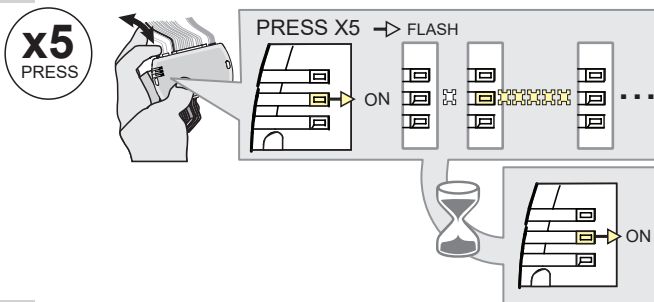

Press and release the programming button five (5x) times.

↳The **YELLOW LED** will flash 5 times each second.

↳**WAIT** for the **YELLOW LED** to turn ON solide.

5

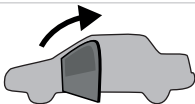

Open the driver door.

6

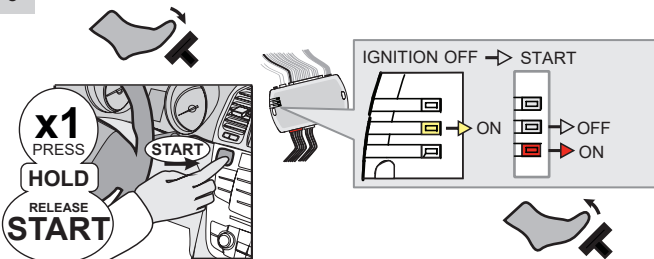

Press the foot-brake pedal.

Press the Push-to-Start button until the engine start.

Release the foot-brake pedal.

↳The **RED LED** will turn ON.
 ↳The **YELLOW LED** will turn OFF.

KEY BYPASS PROGRAMMING PROCEDURE 2/3 |

7



Press the Push-to-Start button until the engine turn OFF.

8

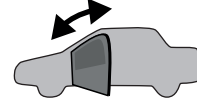

Close and open the driver door.

9

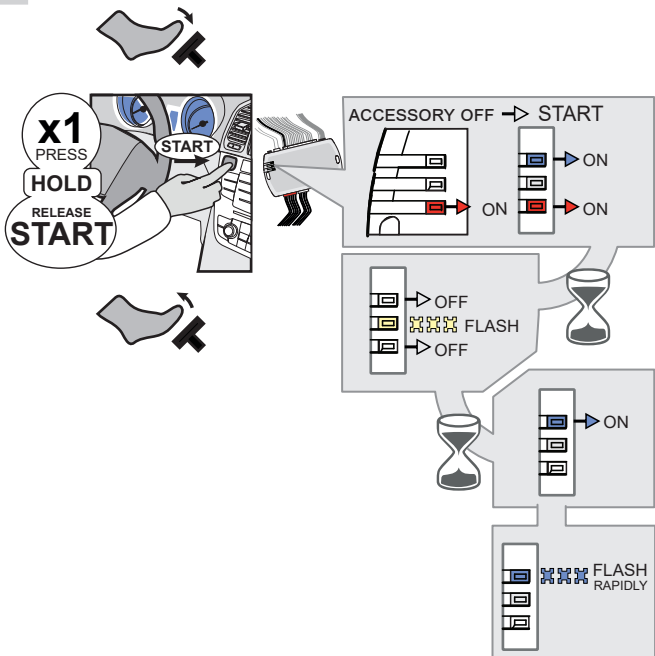

Press the foot-brake pedal.

Press the Push-to-Start button until the engine start.

Release the foot-brake pedal.

- ↳ The BLUE LED will turn ON.
- ↳ The BLUE LED will turn OFF. The RED LED will turn OFF.
- ↳ The YELLOW LED will flash rapidly
- ↳ The BLUE LED will turn ON.
- ↳ The BLUE LED will flash rapidly

10

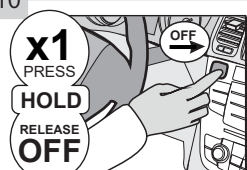

Press the Push-to-Start button until the engine turn OFF.

- ↳ The BLUE LED will flash slowly

11

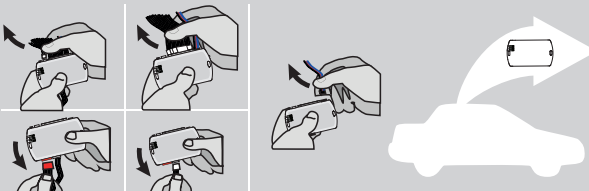

Disconnect all the connectors and after the Data-Link (4-pins) connector.

12

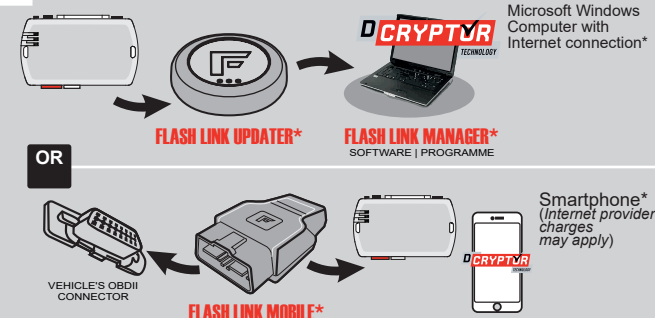

Use the tool: FLASH LINK UPDATER or FLASH LINK MOBILE to visit the DCRYPTOR menu.

***Parts required (not included)**

13

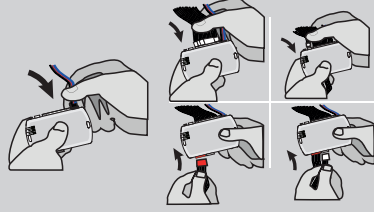
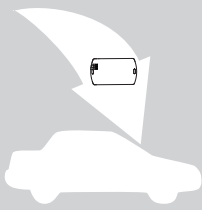

AFTER DCRYPTOR PROGRAMMING COMPLETED
Go back to the vehicle and **reconnect** the 4-Pin (Data-Link) connector and after, all the remaining connector.



The module is now programmed.



REMOTE STARTER / ALARM VERIFICATION

Test the remote starter. Remote start the vehicle.

REMOTE STARTER FUNCTIONALITY |



All doors must be closed.

Remote start the vehicle.



Press the Unlock button of the remote car starter.



Enter the vehicle with the Intelligent Access Key.

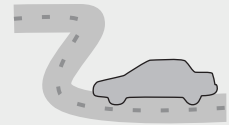

The vehicle can now be put in to gear and driven.



If the vehicle is not unlocked the module will shut down the remote-starter and the vehicle as soon as any door is opened.

THARNESS STAND ALONE INSTALLATION

THAR-GM6

ADDENDUM - SUGGESTED WIRING CONFIGURATION



ONLY COMPATIBLE WITH AUTOMATIC TRANSMISSION VEHICLES.



VEHICLE

YEARS

Vehicle functions supported in this diagram (functional if equipped)

VEHICLE	YEARS	Immobilizer bypass	Lock	Unlock	Arm	Disarm	Trunk (open)	RAP Disable	Tachometer	Heated Seats	Door Status	Trunk Status	Hand-Brake Status	Foot-Brake Status	OEM Remote Monitoring
BUICK															
Encore	Push-To-Start	2017-2020	•	•	•	•	•	•	•	•	•	•	•	•	•
CHEVROLET															
Trax	Push-To-Start	2017-2021	•	•	•	•	•	•	•	•	•	•	•	•	•



FIRMWARE VERSION

70.[45]

GM MINIMUM

To add the firmware version and the options, use the **FLASH LINK UPDATER** or **FLASH LINK MOBILE** tool, sold separately.



Program bypass option:

UNIT OPTION

DESCRIPTION

C1

OEM Remote status (Lock/Unlock) monitoring

IF THE VEHICLE IS NOT EQUIPPED WITH FUNCTIONAL HOOD PIN:

A11

OFF

Hood trigger (Output Status).

D6

Push-to-Start



ATTENTION!

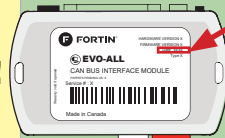

DATE: XX-XX

E5

OFF

SPECIAL FUNCTIONS: BY DEFAULT DEACTIVATED

ON

MANUFACTURED MODULES BETWEEN: 04/2018 TO 04/2019



Parts required (Not included)

1X THAR-GM6

MANDATORY INSTALL

*HOOD PIN



HOOD STATUS: THE HOOD PIN SWITCH MUST BE INSTALLED IF THE VEHICLE CAN BE REMOTE STARTED WITH THE HOOD OPEN, SET FUNCTION **A11** TO OFF.

A11

OFF

Notice: the installation of safety elements are mandatory. The hood pin is an essential security element and must be installed.

THIS MODULE MUST BE INSTALLED BY A QUALIFIED TECHNICIAN. A WRONG CONNECTION CAN CAUSE PERMANENT DAMAGE TO THE VEHICLE.

PARTS REQUIRED (NOT INCLUDED)

1x **FLASH LINK UPDATER**
 1x **FLASH LINK MANAGER**
SOFTWARE | PROGRAMME
 1x Microsoft Windows Computer with Internet connection

OR

1x **FLASH LINK MOBILE**
 1x **FLASH LINK MOBILE APP**
Smartphone Android or iOS with Internet connection (provider charges may apply).

MANDATORY

HOOD PIN



REMOTE START SAFETY OVERRIDE SWITCH

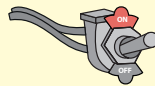

VALET SWITCH

Part #: RSPB available, Sold separately.

Notice: the installation of safety elements are mandatory. The hood pin and the valet switch are essential security elements and must be installed.

STAND ALONE CONFIGURATION

	Program bypass option	UNIT OPTION	DESCRIPTION
	OEM Remote Stand Alone Remote Starter:	D1.10	By default, LOCK, LOCK, LOCK
		D1.1	Par défaut, VERROUILLE,VERROUILLE,VERROUILLE
	Program bypass option with oem remote:	C1	OEM Remote Monitoring
	Program bypass option with RF KIT antenna:	H1 to H6	Supported RF Kits and select RF Kit

REMOTE STARTER FUNCTIONALITY

All doors must be closed.

3X

Press the OEM remote's Lock button 3x to remote-start (or remote-stop) the vehicle.

The vehicle will START.

REMOTE STARTER DIAGNOSTICS
MODULE RED LED

x2 flash :	Brake ON
x3 flash :	No tach
x4 flash :	Ignition before start
x5 flash :	Hood Open

REMOTE STARTER WARNING CARD



CUT THIS WARNING CARD AND STICK IT ON A VISIBLE PLACE:
 or use the package RSPB, Sold separately.

WARNING | ATTENTION

REMOTE STARTER

THE VEHICLE CAN BE STARTED BY EITHER: PRESSING THE LOCK BUTTON ON THE OEM REMOTE 3 TIMES CONSECUTIVELY OR BY A SMARTPHONE. **TURN ON** THE SAFETY SWITCH LOCATED UNDER THE DASHBOARD BEFORE WORKING ON THE VEHICLE.

DESCRIPTION

BCM

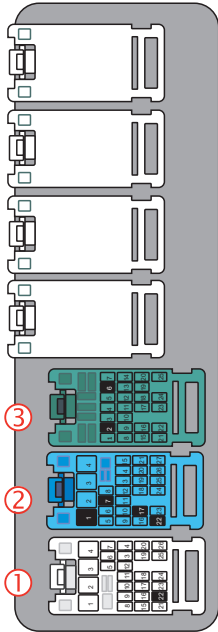
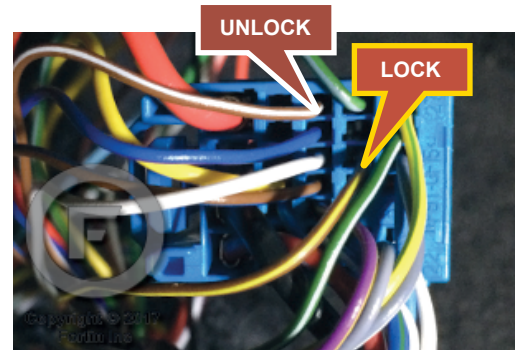
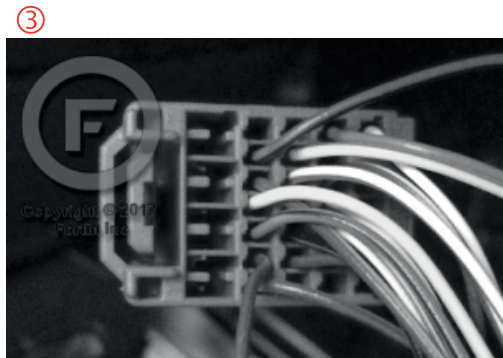

AUTOMATIC TRANSMISSION WIRING CONNECTION

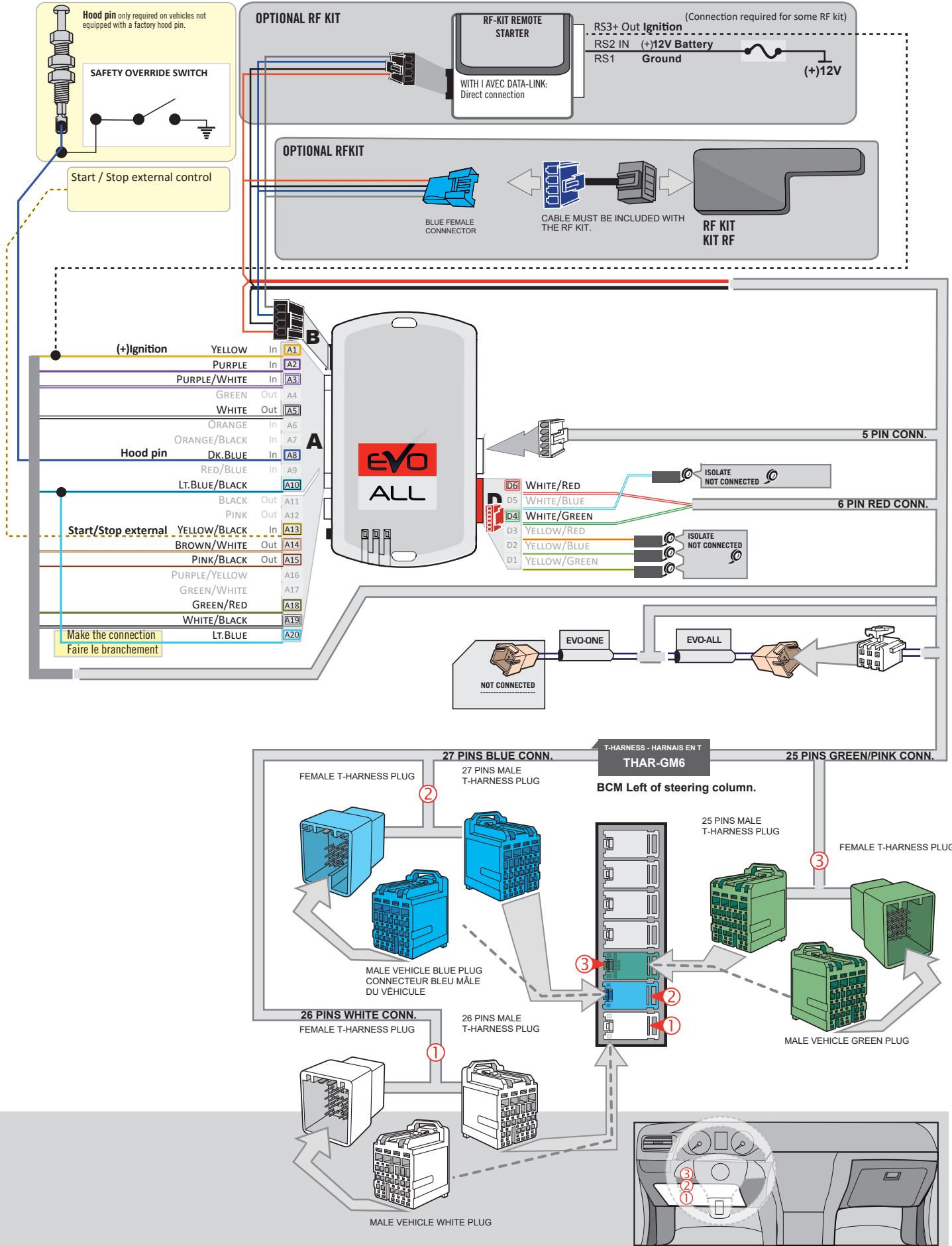

KEY BYPASS PROGRAMMING PROCEDURE 1/3

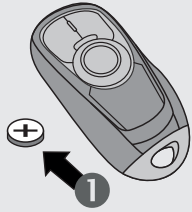

- 1** Remove the battery from the OEM remote.
- 2** Place the OEM remote in the front cup holder in the center console.
Refer to vehicle user guide for keyport location.

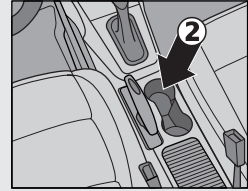

1

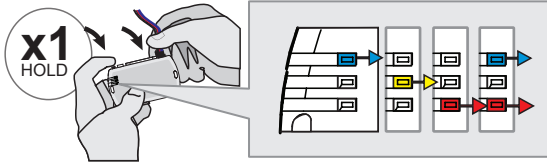

Press and hold the programming button:
Connect the 4-PIN Data-link harness (Black connector).

↳The Blue, Red, Yellow and Blue & Red LEDs will alternatively illuminate.

2

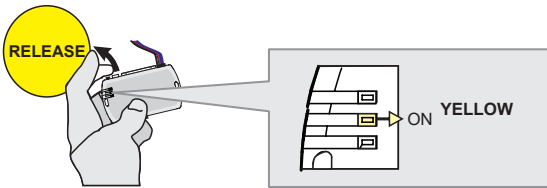

Release the programming button when the LED is YELLOW.

If the LED is not solid YELLOW disconnect the 4-Pin connector (Data-Link) and go back to step 1.

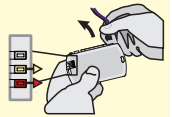

3

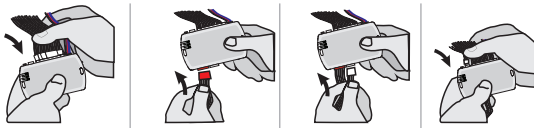

Insert the required remaining connectors.

4

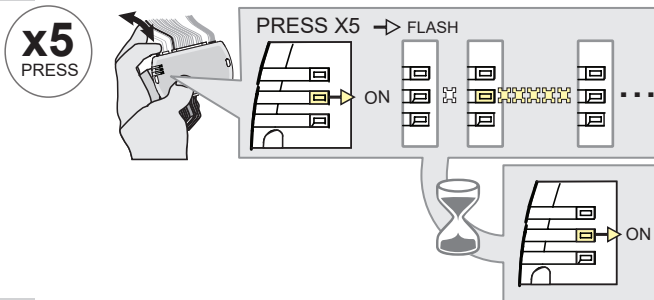

Press and release the programming button five (5x) times.

↳The YELLOW LED will flash 5 times each second.

↳**WAIT** for the YELLOW LED to turn ON solide.

5

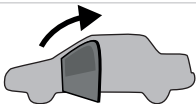

Open the driver door.

6

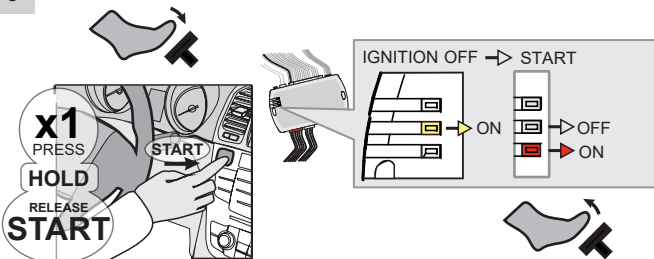

Press the foot-brake pedal.

Press the Push-to-Start button until the engine start.

Release the foot-brake pedal.

↳The RED LED will turn ON.
↳The YELLOW LED will turn OFF.

KEY BYPASS PROGRAMMING PROCEDURE 2/3

7



Press the Push-to-Start button until the engine turn OFF.

8

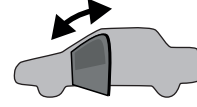

Close and open the driver door.

9

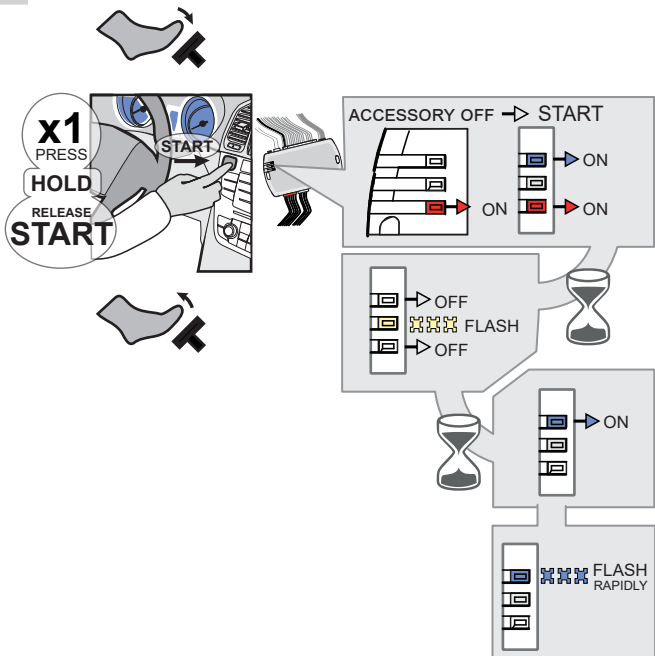

Press the foot-brake pedal.

Press the Push-to-Start button until the engine start.

Release the foot-brake pedal.

- ↳ The BLUE LED will turn ON.
- ↳ The BLUE LED will turn OFF. The RED LED will turn OFF.
- ↳ The YELLOW LED will flash rapidly
- ↳ The BLUE LED will turn ON.
- ↳ The BLUE LED will flash rapidly

10

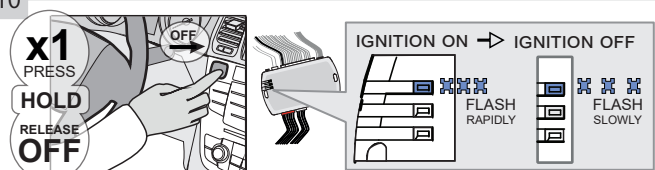

Press the Push-to-Start button until the engine turn OFF.

- ↳ The BLUE LED will flash slowly

11

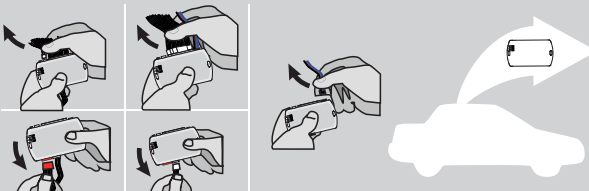

Disconnect all the connectors and after the Data-Link (4-pins) connector.

12

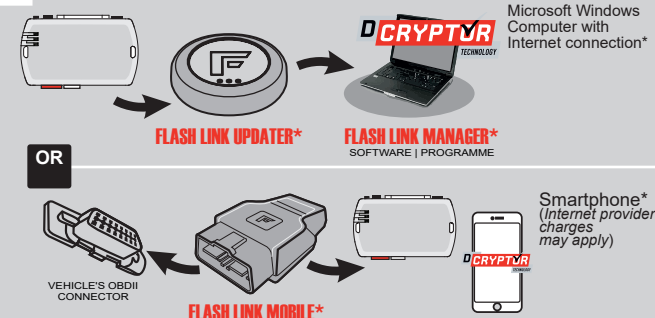

Use the tool: FLASH LINK UPDATER or FLASH LINK MOBILE to visit the DCryptor menu.

*Parts required (not included)

KEY BYPASS PROGRAMMING PROCEDURE 3/3

13

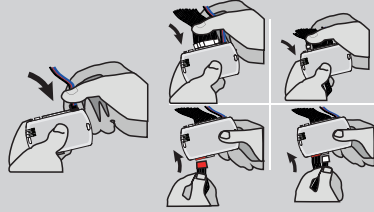
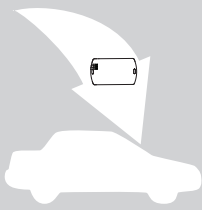

AFTER DCRYPTOR PROGRAMMING COMPLETED
Go back to the vehicle and **reconnect** the 4-Pin (Data-Link) connector and after, all the remaining connector.



The module is now programmed.



REMOTE STARTER / ALARM VERIFICATION PROCEDURE

Test the remote starter. Remote start the vehicle.

REMOTE STARTER FUNCTIONALITY



All doors must be closed.

Remote start the vehicle.



Press the Unlock button of the remote car starter.



Enter the vehicle with the Intelligent Access Key.



The vehicle can now be put in to gear and driven.



If the vehicle is not unlocked the module will shut down the remote-starter and the vehicle as soon as any door is opened.

THAR-GM6

THARNNESS STAND ALONE INSTALLATION

ADDENDUM - SUGGESTED WIRING CONFIGURATION



ONLY COMPATIBLE WITH AUTOMATIC TRANSMISSION VEHICLES.



VEHICLE

YEARS

Vehicle functions supported in this diagram (functional if equipped)

BUICK

Envision	Push-To-Start	2017-2020	•	•	•	•	•	•	•	•	•	•	•	•	•	•	•	•	•
----------	---------------	-----------	---	---	---	---	---	---	---	---	---	---	---	---	---	---	---	---	---



FIRMWARE VERSION

70.[41]

GM MINIMUM

To add the firmware version and the options, use the **FLASH LINK UPDATER** or **FLASH LINK MOBILE** tool, sold separately.

IF THE VEHICLE IS NOT EQUIPPED WITH FUNCTIONAL HOOD PIN:

A11

OFF

Hood trigger (Output Status).



Program bypass option:

UNIT OPTION

DESCRIPTION

C1

OEM Remote status (Lock/Unlock) monitoring



Program bypass option:

UNIT OPTION

DESCRIPTION

D6

Push-to-Start



ATTENTION!

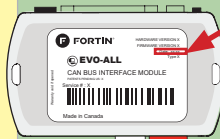

DATE: XX-XX

E5

OFF

SPECIAL FUNCTIONS: BY DEFAULT DEACTIVATED

ON

MANUFACTURED MODULES BETWEEN: 04/2018 TO 04/2019



Parts required (Not included)

- 1X 5 Amp Fuse
- 1X 1k Ohm Resistor

MANDATORY INSTALL

*HOOD PIN



HOOD STATUS: THE HOOD PIN SWITCH MUST BE INSTALLED IF THE VEHICLE CAN BE REMOTE STARTED WITH THE HOOD OPEN, SET FUNCTION A11 TO OFF.

A11

OFF

Notice: the installation of safety elements are mandatory. The hood pin is an essential security element and must be installed.

THIS MODULE MUST BE INSTALLED BY A QUALIFIED TECHNICIAN. A WRONG CONNECTION CAN CAUSE PERMANENT DAMAGE TO THE VEHICLE.

PARTS REQUIRED (NOT INCLUDED)

1x **FLASH LINK UPDATER,**
 1x **FLASH LINK MANAGER**
SOFTWARE | PROGRAMME
 1x Microsoft Windows Computer with Internet connection

OR

1x **FLASH LINK MOBILE**
 1x **FLASH LINK MOBILE APP**
Smartphone Android or iOS with Internet connection (provider charges may apply).

MANDATORY

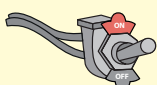



HOOD PIN  REMOTE START SAFETY OVERRIDE SWITCH 

VALET SWITCH

Part #: RSPB available, Sold separately.

Notice: the installation of safety elements are mandatory. The hood pin and the valet switch are essential security elements and must be installed.

STAND ALONE CONFIGURATION

	Program bypass option	UNIT OPTION	DESCRIPTION
	OEM Remote Stand Alone Remote Starter:	D1.10 	By default, LOCK, LOCK, LOCK
		D1.1 	Par défaut, VERROUILLE,VERROUILLE,VERROUILLE
	Program bypass option with oem remote:	C1	OEM Remote Monitoring
	Program bypass option with RF KIT antenna:	H1 to H6	Supported RF Kits and select RF Kit

REMOTE STARTER FUNCTIONALITY



All doors must be closed.

3X 

Press the OEM remote's Lock button 3x to remote-start (or remote-stop) the vehicle.



START 

The vehicle will START.

REMOTE STARTER DIAGNOSTICS
MODULE RED LED

x2 flash :	Brake ON
x3 flash :	No tach
x4 flash :	Ignition before start
x5 flash :	Hood Open

REMOTE STARTER WARNING CARD



CUT THIS WARNING CARD AND STICK IT ON A VISIBLE PLACE:
 or use the package RSPB, Sold separately.

WARNING | ATTENTION

REMOTE STARTER

THE VEHICLE CAN BE STARTED BY EITHER: PRESSING THE LOCK BUTTON ON THE OEM REMOTE 3 TIMES CONSECUTIVELY OR BY A SMARTPHONE. **TURN ON** THE SAFETY SWITCH LOCATED UNDER THE DASHBOARD BEFORE WORKING ON THE VEHICLE.

DESCRIPTION

BCM located on passenger side center console

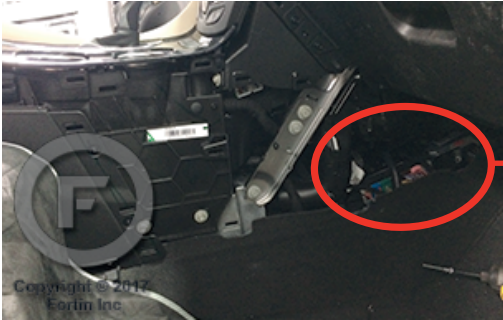

③



②

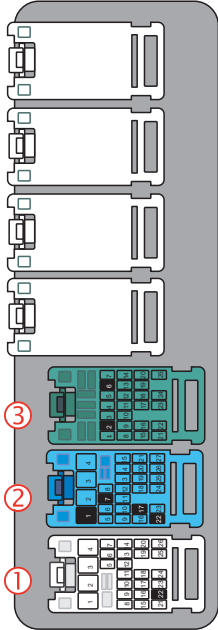
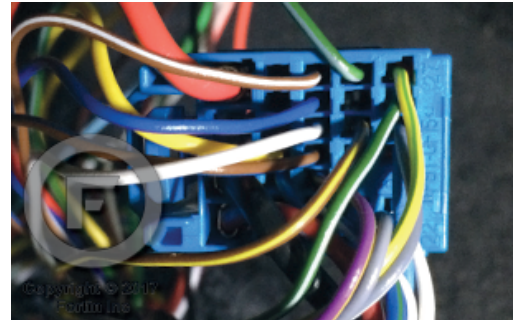

①



AUTOMATIC TRANSMISSION WIRING CONNECTION

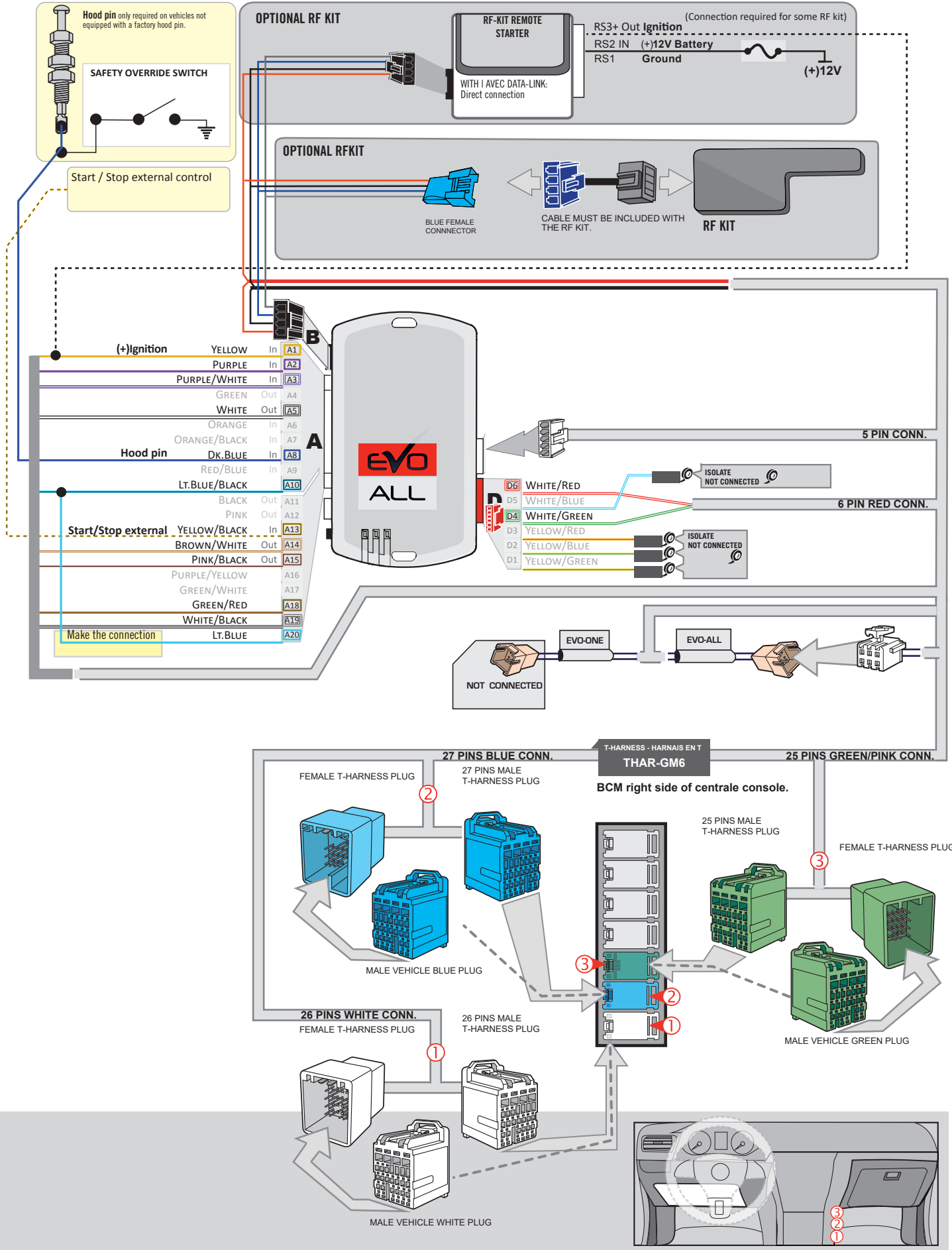

KEY BYPASS PROGRAMMING PROCEDURE 1/3

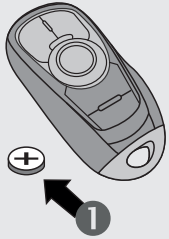

- 1** Remove the battery from the OEM remote.
- 2** Place the OEM remote in the front cup holder in the center console.
Refer to vehicle user guide for keyport location.

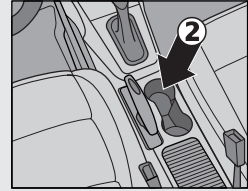

1

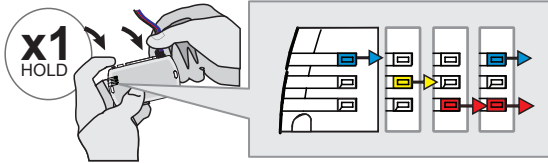

Press and hold the programming button:
Connect the 4-PIN Data-link harness (Black connector).

↳The Blue, Red, Yellow and Blue & Red LEDs will alternatively illuminate.

2

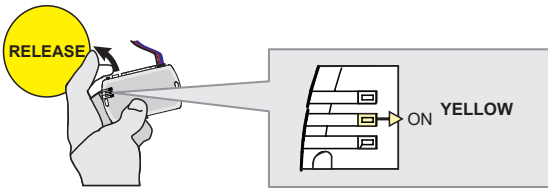

Release the programming button when the LED is YELLOW.

If the LED is not solid YELLOW disconnect the 4-Pin connector (Data-Link) and go back to step 1.

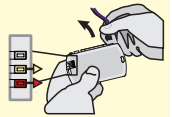

3

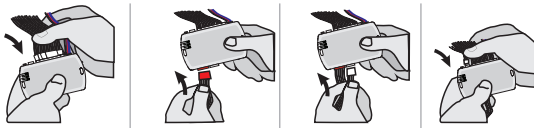

Insert the required remaining connectors.

4

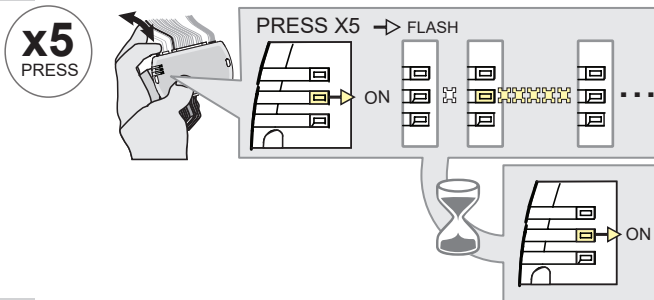

Press and release the programming button five (5x) times.

↳The YELLOW LED will flash 5 times each second.

↳**WAIT** for the YELLOW LED to turn ON solide.

5

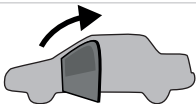

Open the driver door.

6

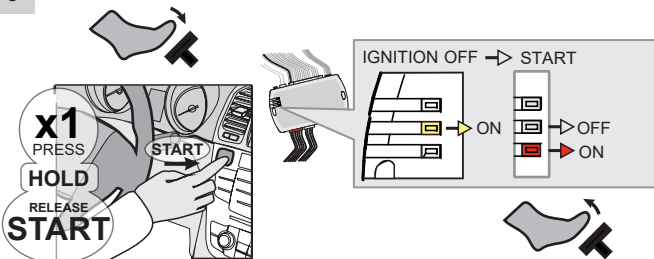

Press the foot-brake pedal.

Press the Push-to-Start button until the engine start.

Release the foot-brake pedal.

↳The RED LED will turn ON.
↳The YELLOW LED will turn OFF.

KEY BYPASS PROGRAMMING PROCEDURE 2/3

7



Press the Push-to-Start button until the engine turn OFF.

8

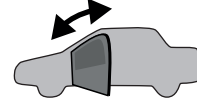

Close and open the driver door.

9

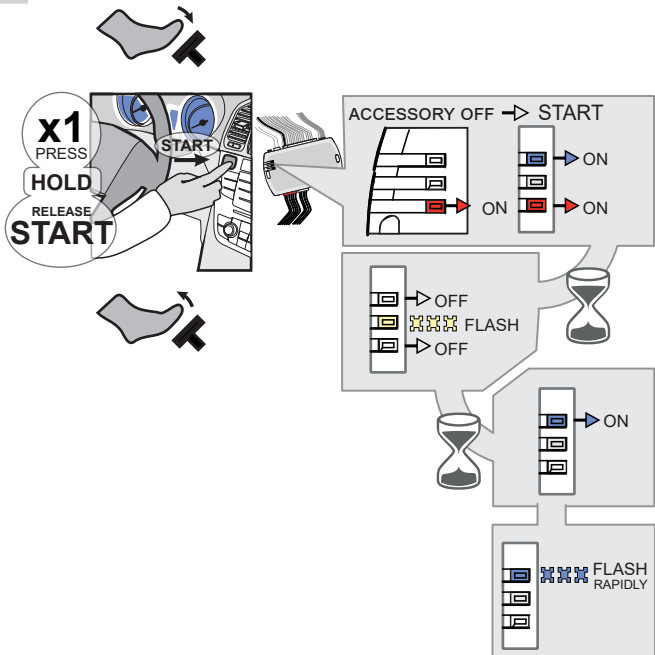

Press the foot-brake pedal.

Press the Push-to-Start button until the engine start.

Release the foot-brake pedal.

- ↳ The BLUE LED will turn ON.
- ↳ The BLUE LED will turn OFF. The RED LED will turn OFF.
- ↳ The YELLOW LED will flash rapidly
- ↳ The BLUE LED will turn ON.
- ↳ The BLUE LED will flash rapidly

10

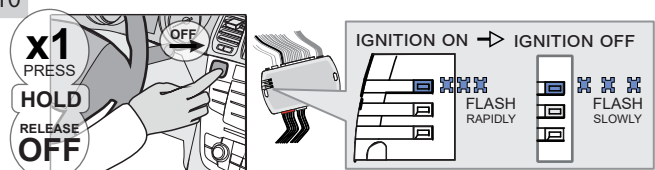

Press the Push-to-Start button until the engine turn OFF.

- ↳ The BLUE LED will flash slowly

11

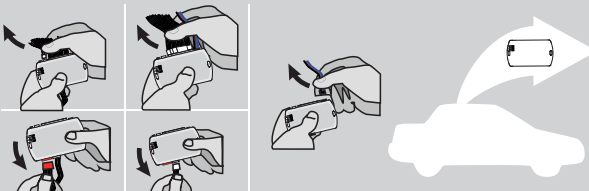

Disconnect all the connectors and after the Data-Link (4-pins) connector.

12

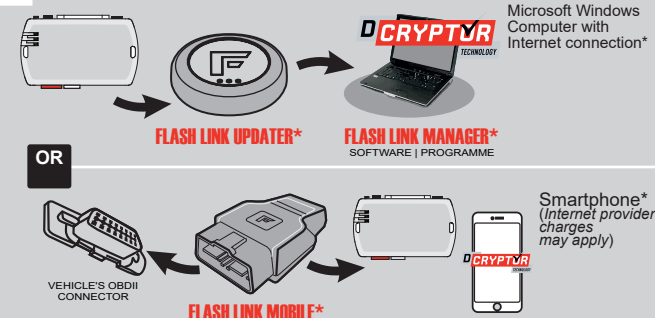

Use the tool: FLASH LINK UPDATER or FLASH LINK MOBILE to visit the DCryptor menu.

***Parts required (not included)**

KEY BYPASS PROGRAMMING PROCEDURE 3/3

13

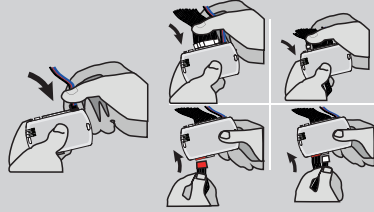
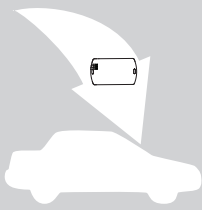

AFTER DCRYPTOR PROGRAMMING COMPLETED
Go back to the vehicle and **reconnect** the 4-Pin (Data-Link) connector and after, all the remaining connector.



The module is now programmed.



REMOTE STARTER / ALARM VERIFICATION PROCEDURE

Test the remote starter. Remote start the vehicle.

REMOTE STARTER FUNCTIONALITY



All doors must be closed.

Remote start the vehicle.



Press the Unlock button of the remote car starter.



Enter the vehicle with the Intelligent Access Key.



The vehicle can now be put in to gear and driven.



If the vehicle is not unlocked the module will shut down the remote-starter and the vehicle as soon as any door is opened.

THAR-GM6

THARNNESS STAND ALONE INSTALLATION

ADDENDUM - SUGGESTED WIRING CONFIGURATION



ONLY COMPATIBLE WITH AUTOMATIC TRANSMISSION VEHICLES.



Vehicle functions supported in this diagram (functional if equipped)

VEHICLE	YEARS	Immobilizer bypass	Lock	Unlock	Arm	Disarm	Trunk (open)	Parking Light	RAP Disable	Tachometer	Heated Seats	Door Status	Trunk Status	Hand-Brake Status	Foot-Brake Status	OEM Remote Monitoring
CHEVROLET																
Equinox	Push-To-Start	2018-2020	•	•	•	•	•	•	•	•	•	•	•	•	•	•

FIRMWARE VERSION

70.[45]

GM MINIMUM

To add the firmware version and the options, use the **FLASH LINK UPDATER** or **FLASH LINK MOBILE** tool, sold separately.

	PROGRAM BYPASS OPTION:	UNIT OPTION	DESCRIPTION
		C1	OEM Remote status (Lock/Unlock) monitoring
	IF THE VEHICLE IS NOT EQUIPPED WITH FUNCTIONAL HOOD PIN:	A11	OFF
		D6	Push-to-Start

ATTENTION!

DATE: XX-XX

E5

OFF

ON

SPECIAL FUNCTIONS: BY DEFAULT DEACTIVATED

MANUFACTURED MODULES BETWEEN: 04/2018 TO 04/2019

Parts required (Not included)

1X THAR-GM6

MANDATORY INSTALL

*HOOD PIN



HOOD STATUS: THE HOOD PIN SWITCH MUST BE INSTALLED IF THE VEHICLE CAN BE REMOTE STARTED WITH THE HOOD OPEN, SET FUNCTION **A11** TO OFF.

A11

OFF

Notice: the installation of safety elements are mandatory. The hood pin is an essential security element and must be installed.

THIS MODULE MUST BE INSTALLED BY A QUALIFIED TECHNICIAN. A WRONG CONNECTION CAN CAUSE PERMANENT DAMAGE TO THE VEHICLE.

PARTS REQUIRED (NOT INCLUDED)

1x **FLASH LINK UPDATER,**
 1x **FLASH LINK MANAGER**
 SOFTWARE | PROGRAMME
 1x Microsoft Windows Computer with Internet connection

OR

1x **FLASH LINK MOBILE**
 1x **FLASH LINK MOBILE APP**
 Smartphone *Android* or *iOS* with Internet connection (*provider charges may apply*).

MANDATORY

HOOD PIN



REMOTE START SAFETY OVERRIDE SWITCH

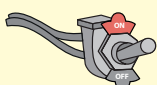





VALET SWITCH

Part #: RSPB available, Sold separately.

Notice: the installation of safety elements are mandatory. The hood pin and the valet switch are essential security elements and must be installed.

STAND ALONE CONFIGURATION

	Program bypass option	UNIT OPTION	DESCRIPTION
	OEM Remote Stand Alone Remote Starter:	D1.10 	By default, LOCK, LOCK, LOCK Par défaut, VERROUILLE, VERROUILLE, VERROUILLE
		D1.1 	
	Program bypass option with oem remote:	C1	OEM Remote Monitoring
	Program bypass option with RF KIT antenna:	H1 to H6	Supported RF Kits and select RF Kit

REMOTE STARTER FUNCTIONALITY



All doors must be closed.

3X 

Press the OEM remote's Lock button 3x to remote-start (or remote-stop) the vehicle.



START

The vehicle will START.

REMOTE STARTER DIAGNOSTICS
MODULE RED LED

x2 flash :	Brake ON
x3 flash :	No tach
x4 flash :	Ignition before start
x5 flash :	Hood Open

REMOTE STARTER WARNING CARD



CUT THIS WARNING CARD AND STICK IT ON A VISIBLE PLACE:
 or use the package **RSPB**, Sold separately.

WARNING | ATTENTION



REMOTE STARTER

THE VEHICLE CAN BE STARTED BY EITHER: PRESSING THE LOCK BUTTON ON THE OEM REMOTE 3 TIMES CONSECUTIVELY OR BY A SMARTPHONE. **TURN ON** THE SAFETY SWITCH LOCATED UNDER THE DASHBOARD BEFORE WORKING ON THE VEHICLE.

DESCRIPTION

BCM

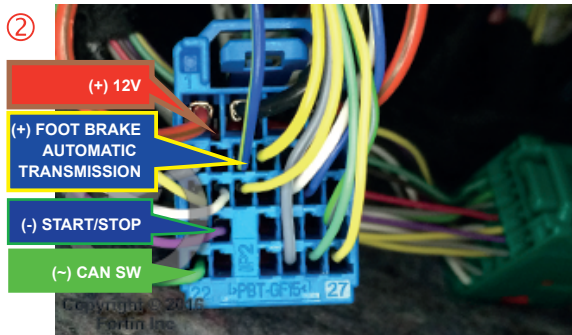
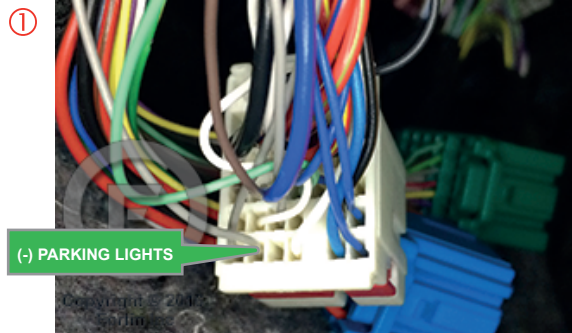

AUTOMATIC TRANSMISSION WIRING CONNECTION

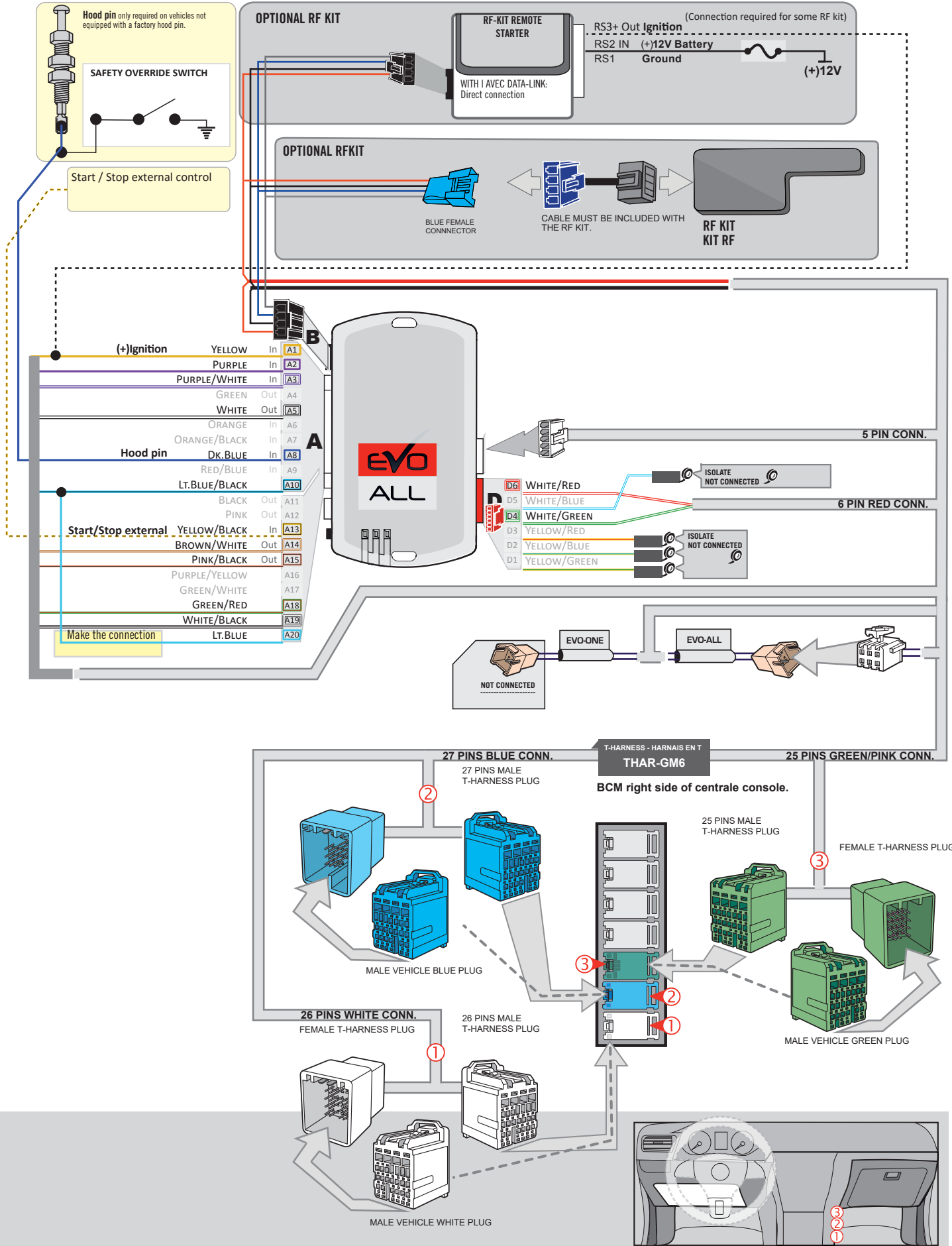

KEY BYPASS PROGRAMMING PROCEDURE 1/3



- 1** Remove the battery from the OEM remote.
- 2** Place the OEM remote in the front cup holder in the center console.
Refer to vehicle user guide for keyport location.

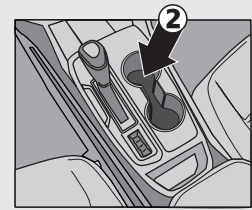

1

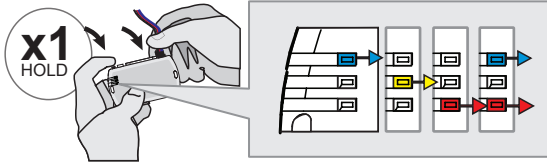

Press and hold the programming button:
Connect the 4-PIN Data-link harness (Black connector).

↳The Blue, Red, Yellow and Blue & Red LEDs will alternatively illuminate.

2

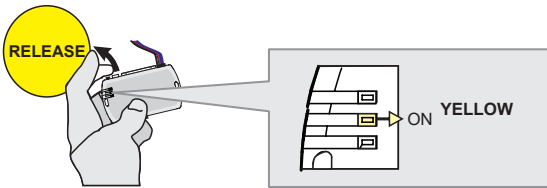

Release the programming button when the LED is YELLOW.

If the LED is not solid YELLOW disconnect the 4-Pin connector (Data-Link) and go back to step 1.

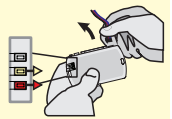

3

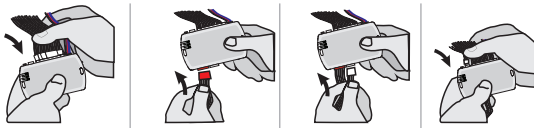

Insert the required remaining connectors.

4

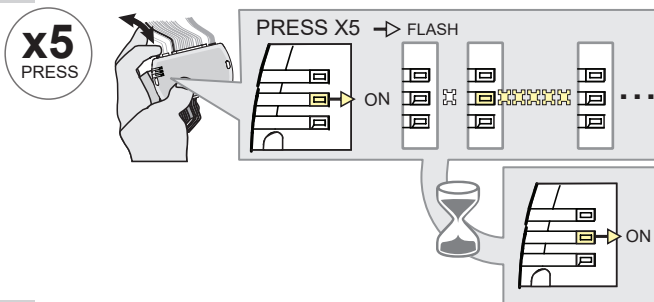

Press and release the programming button five (5x) times.

↳The YELLOW LED will flash 5 times each second.

↳**WAIT** for the YELLOW LED to turn ON solide.

5

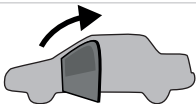

Open the driver door.

6

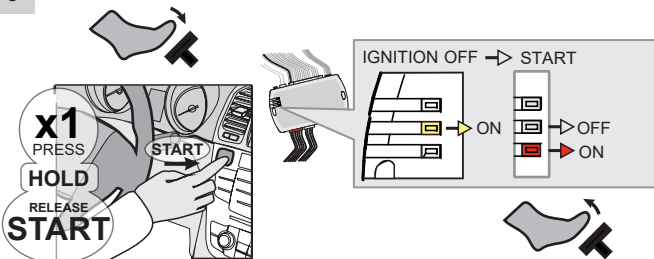

Press the foot-brake pedal.

Press the Push-to-Start button until the engine start.

Release the foot-brake pedal.

↳The RED LED will turn ON.
↳The YELLOW LED will turn OFF.

KEY BYPASS PROGRAMMING PROCEDURE 2/3

7



Press the Push-to-Start button until the engine turn OFF.

8

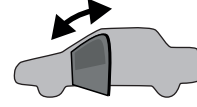

Close and open the driver door.

9

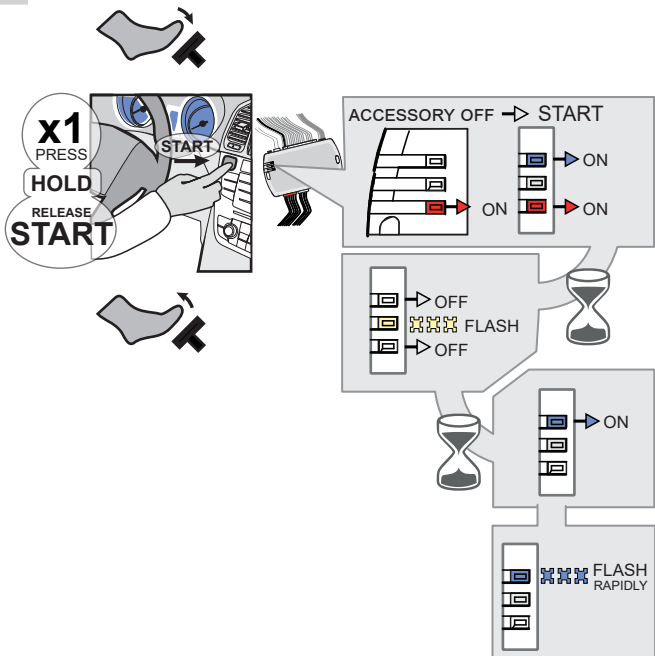

Press the foot-brake pedal.

Press the Push-to-Start button until the engine start.

Release the foot-brake pedal.

- ↳ The BLUE LED will turn ON.
- ↳ The BLUE LED will turn OFF. The RED LED will turn OFF.
- ↳ The YELLOW LED will flash rapidly
- ↳ The BLUE LED will turn ON.
- ↳ The BLUE LED will flash rapidly

10

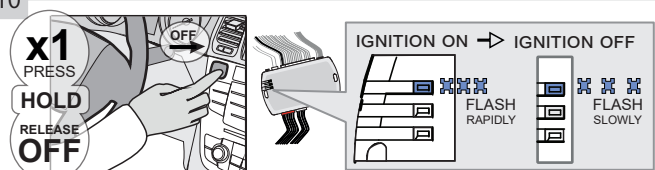

Press the Push-to-Start button until the engine turn OFF.

- ↳ The BLUE LED will flash slowly

11

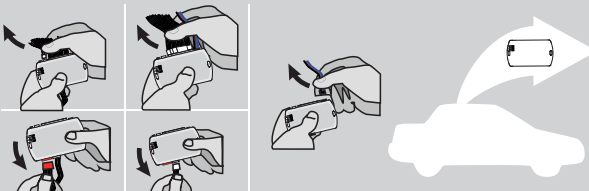

Disconnect all the connectors and after the Data-Link (4-pins) connector.

12

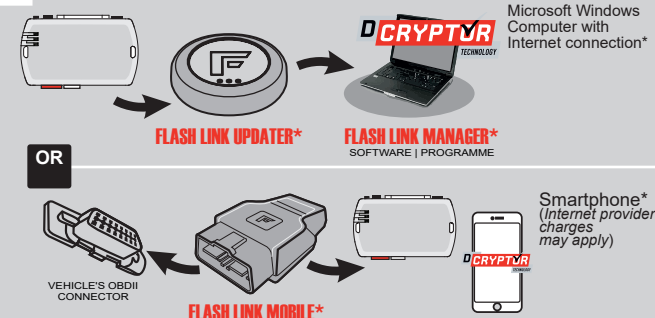

Use the tool: FLASH LINK UPDATER or FLASH LINK MOBILE to visit the DCRYPTOR menu.

***Parts required (not included)**

KEY BYPASS PROGRAMMING PROCEDURE 3/3

13

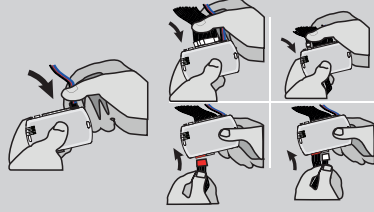
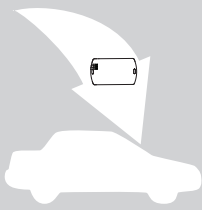

AFTER DCRYPTOR PROGRAMMING COMPLETED
Go back to the vehicle and **reconnect** the 4-Pin (Data-Link) connector and after, all the remaining connector.



The module is now programmed.



REMOTE STARTER / ALARM VERIFICATION PROCEDURE

Test the remote starter. Remote start the vehicle.

REMOTE STARTER FUNCTIONALITY



All doors must be closed.

Remote start the vehicle.



Press the Unlock button of the remote car starter.



Enter the vehicle with the Intelligent Access Key.



The vehicle can now be put in to gear and driven.



If the vehicle is not unlocked the module will shut down the remote-starter and the vehicle as soon as any door is opened.

THAR-GM6

THARNESS STAND ALONE INSTALLATION

ADDENDUM - SUGGESTED WIRING CONFIGURATION



ONLY COMPATIBLE WITH AUTOMATIC TRANSMISSION VEHICLES.



VEHICLE	YEARS	Vehicle functions supported in this diagram (functional if equipped)														
		Immobilizer bypass	Lock	Unlock	Arm	Disarm	Trunk (open)	RAP Disable	Tachometer	Heated Seats	Door Status	Trunk Status	Hand-Brake Status	Foot-Brake Status	OEM Remote Monitoring	
BUICK																
Lacrosse	Push-To-Start	2017-2018	•	•	•	•	•	•	•	•	•	•	•	•	•	•

FIRMWARE VERSION

70.[41]

GM MINIMUM

To add the firmware version and the options, use the **FLASH LINK UPDATER** or **FLASH LINK MOBILE** tool, sold separately.

<p>IF THE VEHICLE IS NOT EQUIPPED WITH FUNCTIONAL HOOD PIN:</p>	A11	OFF	Hood trigger (Output Status).
--	------------	------------	-------------------------------

	Program bypass option:	UNIT OPTION	DESCRIPTION
		C1	OEM Remote status (Lock/Unlock) monitoring

	Program bypass option:	UNIT OPTION	DESCRIPTION
		D6	Push-to-Start

	ATTENTION!	<p>DATE: XX-XX</p>	E5	OFF	<p>SPECIAL FUNCTIONS: BY DEFAULT DEACTIVATED</p> <p>MANUFACTURED MODULES BETWEEN: 04/2018 TO 04/2019</p>
--	-------------------	--------------------	-----------	------------	--



Parts required (Not included)

1X THAR-GM6

MANDATORY INSTALL

***HOOD PIN**



HOOD STATUS: THE HOOD PIN SWITCH MUST BE INSTALLED IF THE VEHICLE CAN BE REMOTE STARTED WITH THE HOOD OPEN, SET FUNCTION A11 TO OFF.

A11

OFF

Notice: the installation of safety elements are mandatory. The hood pin is an essential security element and must be installed.

THIS MODULE MUST BE INSTALLED BY A QUALIFIED TECHNICIAN. A WRONG CONNECTION CAN CAUSE PERMANENT DAMAGE TO THE VEHICLE.

PARTS REQUIRED (NOT INCLUDED)

1x **FLASH LINK UPDATER,**
 1x **FLASH LINK MANAGER**
 SOFTWARE | PROGRAMME
 1x Microsoft Windows Computer with Internet connection

OR

1x **FLASH LINK MOBILE**
 1x **FLASH LINK MOBILE APP**
 Smartphone *Android* or *iOS* with Internet connection (*provider charges may apply*).

MANDATORY

HOOD PIN



REMOTE START SAFETY OVERRIDE SWITCH

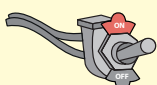





VALET SWITCH

Part #: RSPB available, Sold separately.

Notice: the installation of safety elements are mandatory. The hood pin and the valet switch are essential security elements and must be installed.



STAND ALONE CONFIGURATION

	Program bypass option	UNIT OPTION	DESCRIPTION
	OEM Remote Stand Alone Remote Starter:	D1.10 	By default, LOCK, LOCK, LOCK Par défaut, VERROUILLE,VERROUILLE,VERROUILLE
		D1.1 	
	Program bypass option with oem remote:	C1	OEM Remote Monitoring
	Program bypass option with RF KIT antenna:	H1 to H6	Supported RF Kits and select RF Kit

REMOTE STARTER FUNCTIONALITY



All doors must be closed.

3X  

Press the OEM remote's Lock button 3x to remote-start (or remote-stop) the vehicle.



The vehicle will START.

REMOTE STARTER DIAGNOSTICS
MODULE RED LED

x2 flash :	Brake ON
x3 flash :	No tach
x4 flash :	Ignition before start
x5 flash :	Hood Open

REMOTE STARTER WARNING CARD



CUT THIS WARNING CARD AND STICK IT ON A VISIBLE PLACE:
 or use the package **RSPB**, Sold separately.

WARNING



REMOTE STARTER

THE VEHICLE CAN BE STARTED BY EITHER: PRESSING THE LOCK BUTTON ON THE OEM REMOTE 3 TIMES CONSECUTIVELY OR BY A SMARTPHONE. **TURN ON** THE SAFETY SWITCH LOCATED UNDER THE DASHBOARD BEFORE WORKING ON THE VEHICLE.

DESCRIPTION

BCM located on passenger side center console



③



②

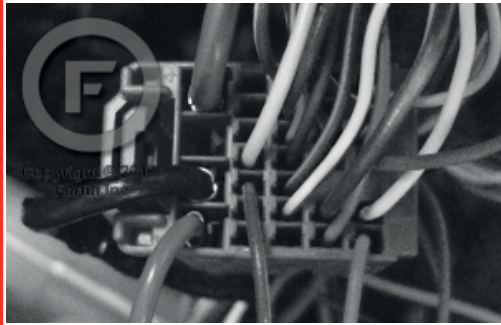

①

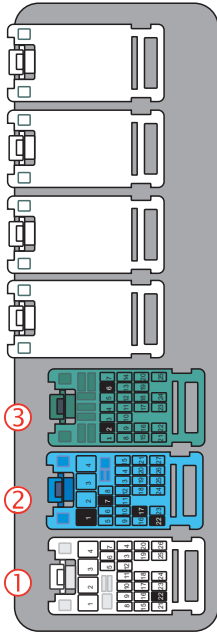

AUTOMATIC TRANSMISSION WIRING CONNECTION

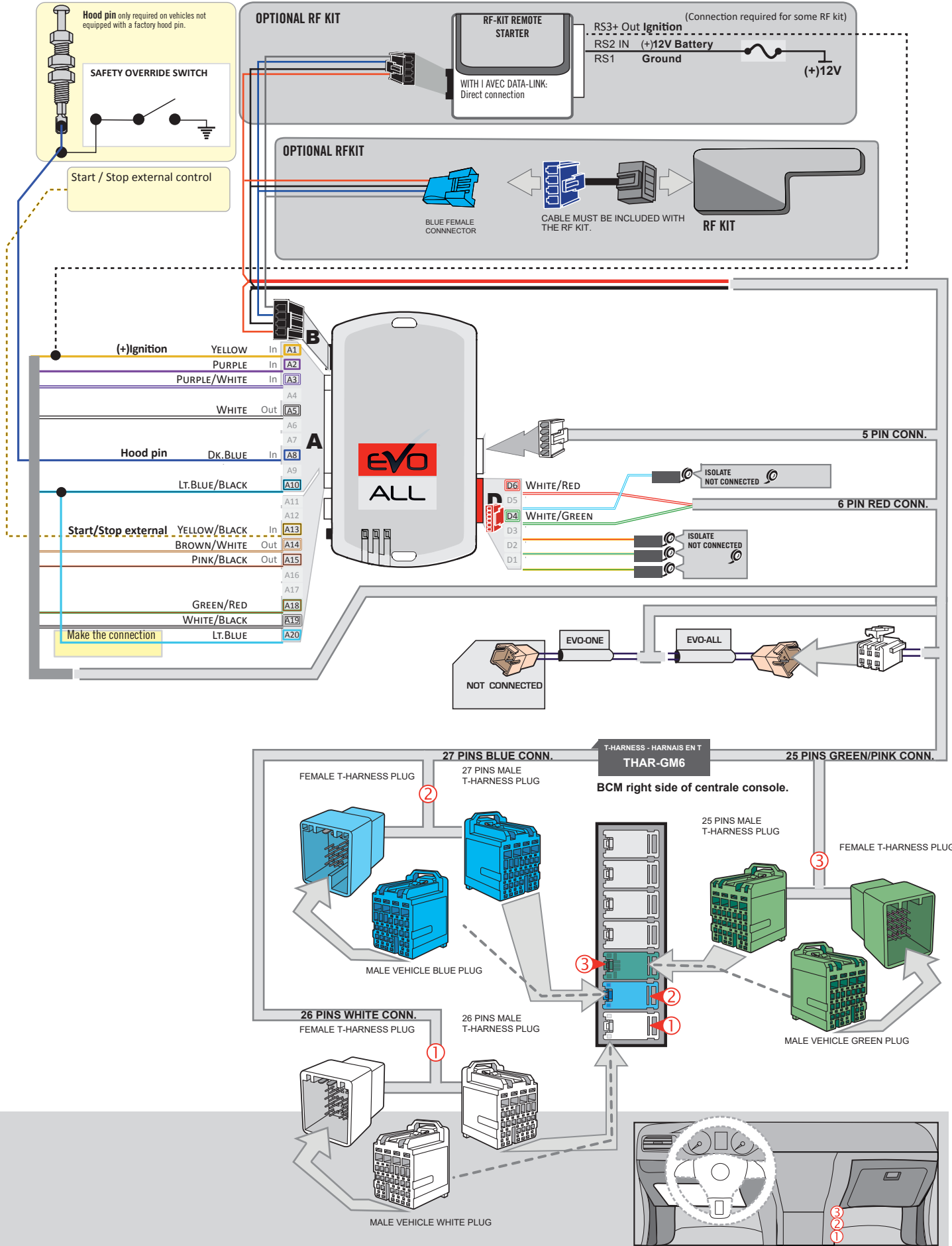

KEY BYPASS PROGRAMMING PROCEDURE 1/3

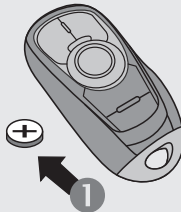

1 Remove the battery from the OEM remote.

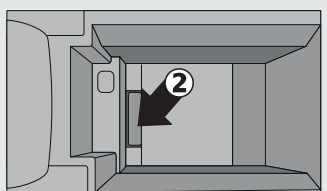

2 Place the OEM remote into the transmitter pocket of the center console.
Refer to vehicle user guide for keyport location.

1

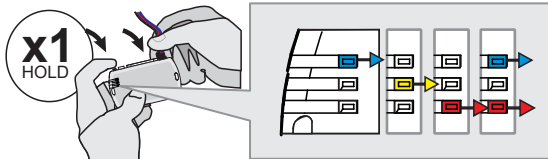

x1 HOLD

Press and hold the programming button:
Connect the 4-PIN Data-link harness (Black connector).

↳The Blue, Red, Yellow and Blue & Red LEDs will alternatively illuminate.

2

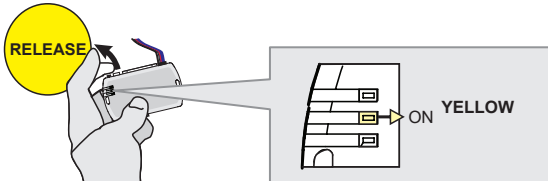

RELEASE

Release the programming button when the LED is **YELLOW**.

If the LED is not solid YELLOW disconnect the 4-Pin connector (Data-Link) and go back to step 1.

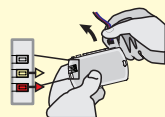

3

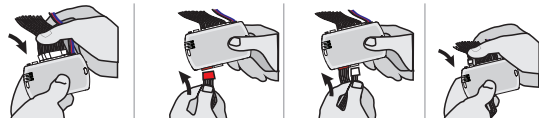

Insert the required remaining connectors.

4

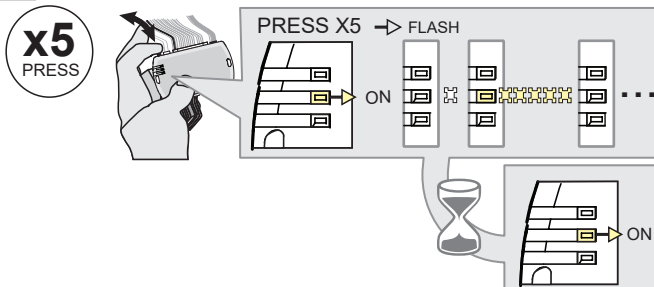

x5 PRESS

Press and release the programming button five (5x) times.

↳The YELLOW LED will flash 5 times each second.

↳**WAIT** for the YELLOW LED to turn ON solide.

5



Open the driver door.

6

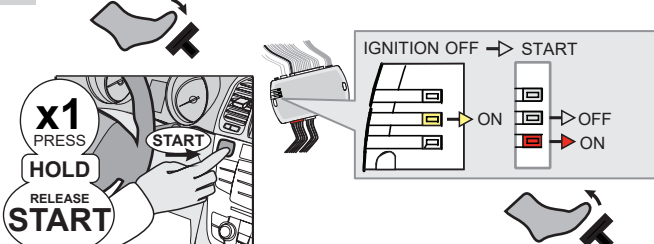

x1 PRESS
HOLD
RELEASE
START

Press the foot-brake pedal.
Press the Push-to-Start button until the engine start.
Release the foot-brake pedal.

↳The RED LED will turn ON.
↳The YELLOW LED will turn OFF.

KEY BYPASS PROGRAMMING PROCEDURE 2/3 | PROCÉDURE DE PROGRAMMATION CONTOURNEMENT DE CLÉ 2/3

7



Press the Push-to-Start button until the engine turn OFF.

8

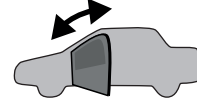

Close and open the driver door.

9

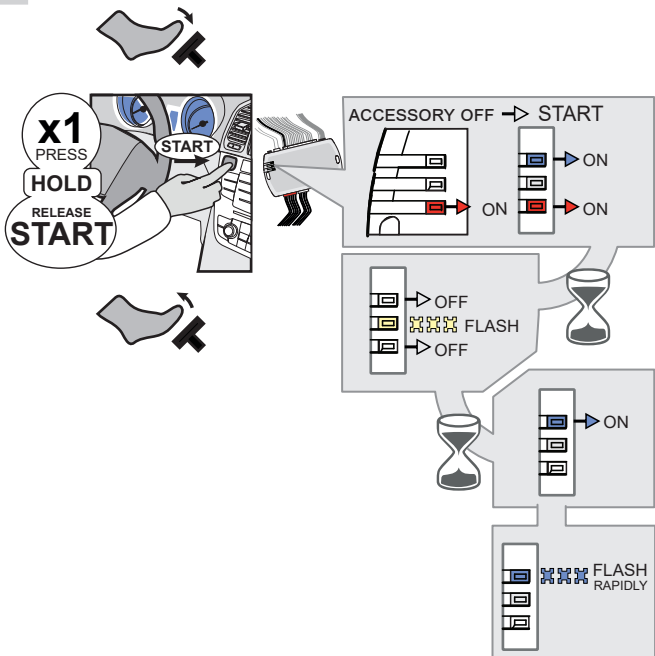
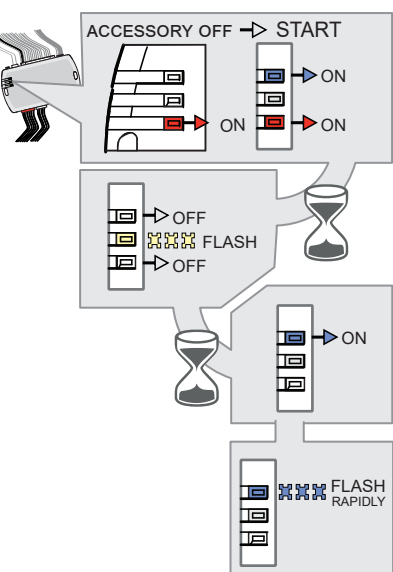
Press the foot-brake pedal.

Press the Push-to-Start button until the engine start.

Release the foot-brake pedal.

- ↳ The BLUE LED will turn ON.
- ↳ The BLUE LED will turn OFF. The RED LED will turn OFF.
- ↳ The YELLOW LED will flash rapidly
- ↳ The BLUE LED will turn ON.
- ↳ The BLUE LED will flash rapidly

10

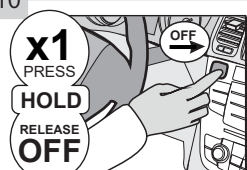
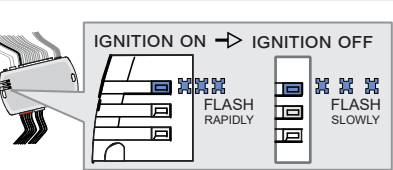
Press the Push-to-Start button until the engine turn OFF.

- ↳ The BLUE LED will flash slowly

11

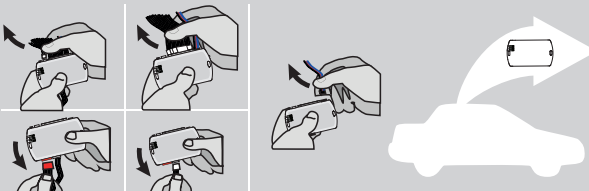

Disconnect all the connectors and after the Data-Link (4-pins) connector.

12

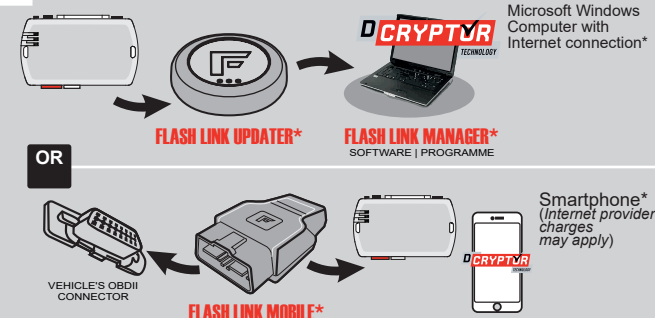

Use the tool: FLASH LINK UPDATER or FLASH LINK MOBILE to visit the DCRYPTOR menu.

***Parts required (not included)**

13

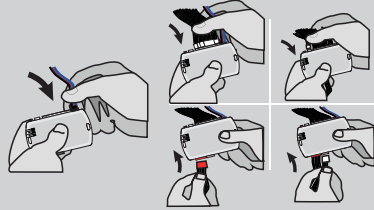
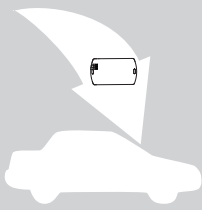

AFTER DCRYPTOR PROGRAMMING COMPLETED
Go back to the vehicle and **reconnect** the 4-Pin (Data-Link) connector and after, all the remaining connector.



The module is now programmed.



REMOTE STARTER / ALARM VERIFICATION

Test the remote starter. Remote start the vehicle.

REMOTE STARTER FUNCTIONALITY |



All doors must be closed.

Remote start the vehicle.



Press the Unlock button of the remote car starter.



Enter the vehicle with the Intelligent Access Key.

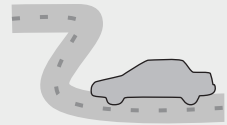

The vehicle can now be put in to gear and driven.



If the vehicle is not unlocked the module will shut down the remote-starter and the vehicle as soon as any door is opened.

THARNESS STAND ALONE INSTALLATION
THAR-GM6

ADDENDUM - SUGGESTED WIRING CONFIGURATION

ONLY COMPATIBLE WITH AUTOMATIC TRANSMISSION VEHICLES.

Vehicle functions supported in this diagram (functional if equipped)

VEHICLE	YEARS	Immobilizer bypass	Lock	Unlock	Arm	Disarm	Trunk (open)	Parking Light	RAP Disable	Tachometer	Heated Seats	Door Status	Trunk Status	Hand-Brake Status	Foot-Brake Status	OEM Remote Monitoring
BUICK																
Verano	Push-To-Start	2012-2017	•	•	•	•	•	•	•	•	•	•	•	•	•	•
CHEVROLET																
Blazer	Push-To-Start	2019-2020	•	•	•	•	•	•	•	•	•	•	•	•	•	•
Malibu	Push-To-Start	2016-2020	•	•	•	•	•	•	•	•	•	•	•	•	•	•
Traverse	Push-To-Start	2018-2020	•	•	•	•	•	•	•	•	•	•	•	•	•	•
GMC																
Terrain	Push-To-Start	2018-2020	•	•	•	•	•	•	•	•	•	•	•	•	•	•



FIRMWARE VERSION

70.[41]

GM MINIMUM

 To add the firmware version and the options, use the **FLASH LINK UPDATER** or **FLASH LINK MOBILE** tool, sold separately.

IF THE VEHICLE IS NOT EQUIPPED WITH FUNCTIONAL HOOD PIN:
A11
OFF

Hood trigger (Output Status).



Program bypass option:

UNIT OPTION

DESCRIPTION

C1

OEM Remote status (Lock/Unlock) monitoring

D6

Push-to-Start

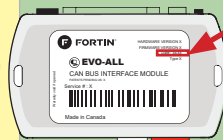
ATTENTION!

DATE: XX-XX

E5
OFF
SPECIAL FUNCTIONS: BY DEFAULT DEACTIVATED
ON
MANUFACTURED MODULES BETWEEN: 04/2018 TO 04/2019

Parts required (Not included)

1X THAR-GM6

MANDATORY INSTALL
***HOOD PIN**

HOOD STATUS: THE HOOD PIN SWITCH MUST BE INSTALLED IF THE VEHICLE CAN BE REMOTE STARTED WITH THE HOOD OPEN, SET FUNCTION A11 TO OFF.

A11
OFF
Notice: the installation of safety elements are mandatory. The hood pin is an essential security element and must be installed.

THIS MODULE MUST BE INSTALLED BY A QUALIFIED TECHNICIAN. A WRONG CONNECTION CAN CAUSE PERMANENT DAMAGE TO THE VEHICLE.

PARTS REQUIRED (NOT INCLUDED)

1x **FLASH LINK UPDATER**
 1x **FLASH LINK MANAGER**
 SOFTWARE
 1x Microsoft Windows Computer with Internet connection

OR

1x **FLASH LINK MOBILE**
 1x **FLASH LINK MOBILE APP**
 Smartphone *Android* or *iOS* with Internet connection (*provider charges may apply*).
 1x

MANDATORY

HOOD PIN



REMOTE START SAFETY OVERRIDE SWITCH

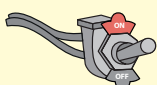





VALET SWITCH

Part #: RSPB available, Sold separately.

Notice: the installation of safety elements are mandatory. The hood pin and the valet switch are essential security elements and must be installed.

STAND ALONE CONFIGURATION

	Program bypass option	UNIT OPTION	DESCRIPTION
	OEM Remote Stand Alone Remote Starter:	D1.10 	By default, LOCK, LOCK, LOCK Par défaut, VERROUILLE,VERROUILLE,VERROUILLE
		D1.1 	
	Program bypass option with oem remote:	C1	OEM Remote Monitoring
	Program bypass option with RF KIT antenna:	H1 to H6	Supported RF Kits and select RF Kit

REMOTE STARTER FUNCTIONALITY



All doors must be closed.

3X 

Press the OEM remote's Lock button 3x to remote-start (or remote-stop) the vehicle.



START 

The vehicle will START.

REMOTE STARTER DIAGNOSTICS
MODULE RED LED

x2 flash :	Brake ON
x3 flash :	No tach
x4 flash :	Ignition before start
x5 flash :	Hood Open

REMOTE STARTER WARNING CARD



CUT THIS WARNING CARD AND STICK IT ON A VISIBLE PLACE:
 or use the package **RSPB**, Sold separately.

WARNING



REMOTE STARTER

THE VEHICLE CAN BE STARTED BY EITHER: PRESSING THE LOCK BUTTON ON THE OEM REMOTE 3 TIMES CONSECUTIVELY OR BY A SMARTPHONE. **TURN ON** THE SAFETY SWITCH LOCATED UNDER THE DASHBOARD BEFORE WORKING ON THE VEHICLE.

DESCRIPTION

BCM



Centrale console

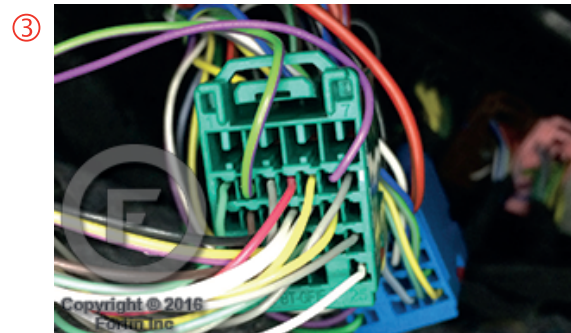
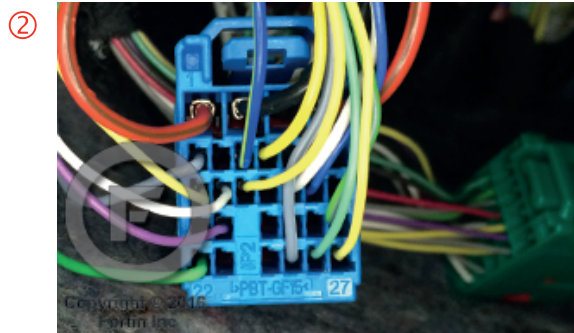
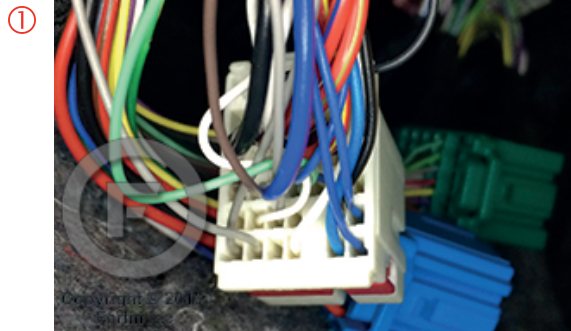
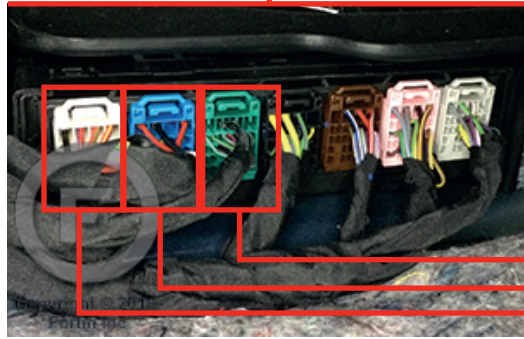

WIRING CONNECTION

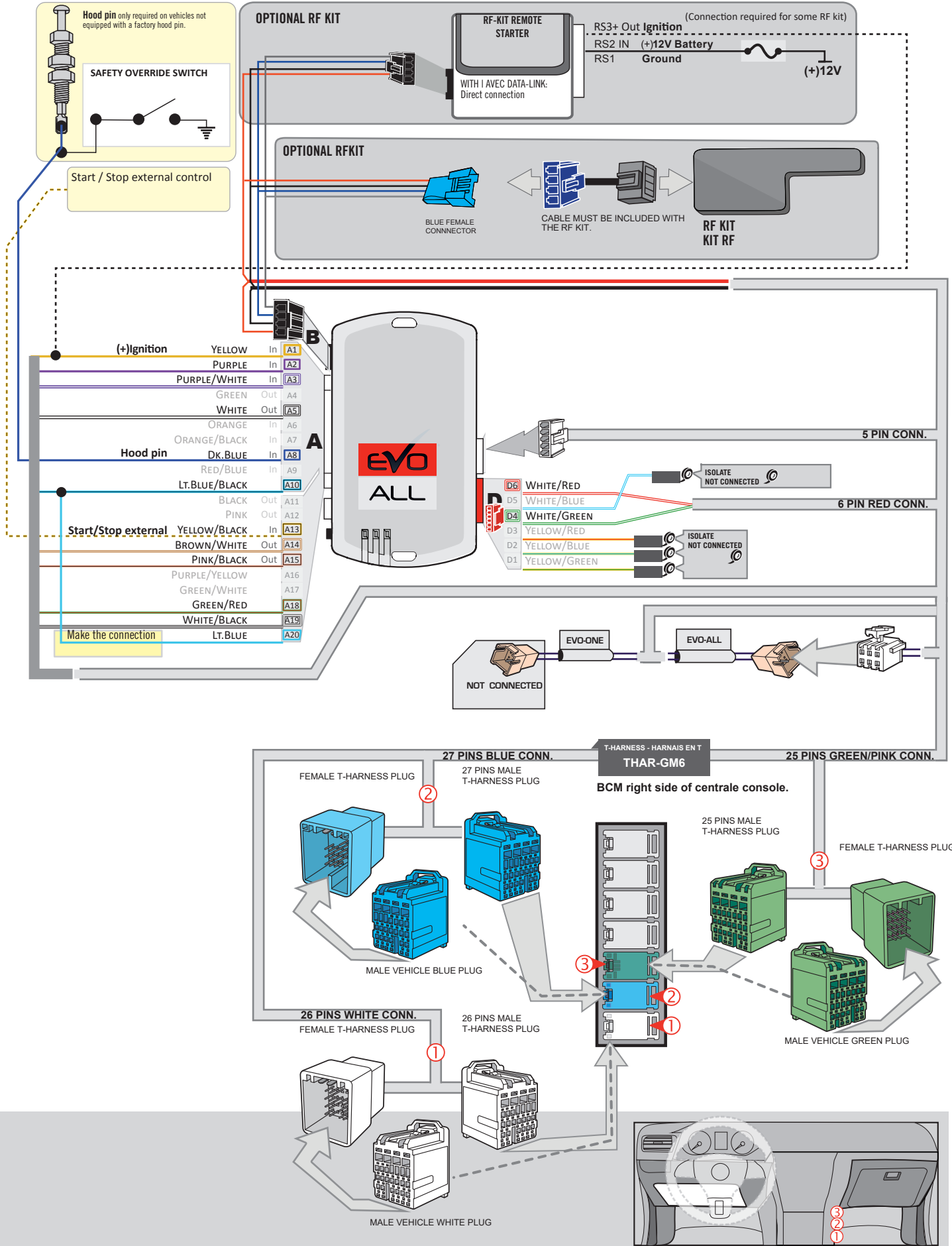

KEY BYPASS PROGRAMMING PROCEDURE 1/3

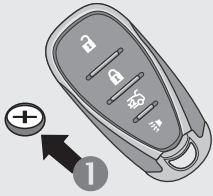

1 Remove the battery from the OEM remote.

2 Place the OEM remotes in to the center console.

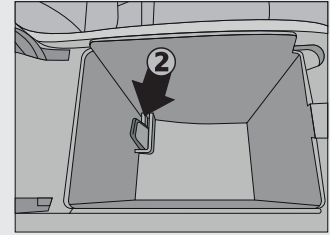

1

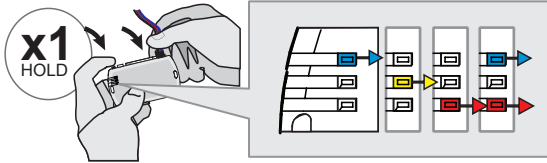

Press and hold the programming button:
Connect the 4-PIN Data-link harness (Black connector).

↳The Blue, Red, Yellow and Blue & Red LEDs will alternatively illuminate.

2

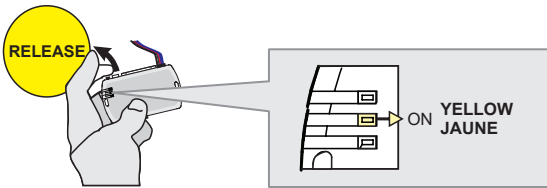

Release the programming button when the LED is YELLOW.

If the LED is not solid YELLOW disconnect the 4-Pin connector (Data-Link) and go back to step 1.

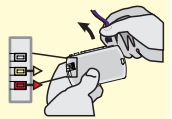

3

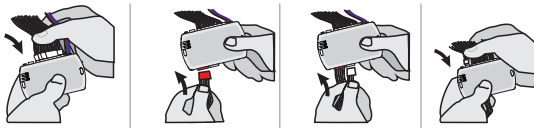

Insert the required remaining connectors.

4

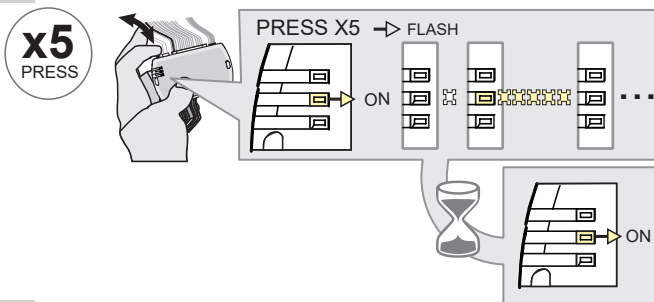

Press and release the programming button five (5x) times.

↳The YELLOW LED will flash 5 times each second.

↳**WAIT** for the YELLOW LED to turn ON solide.

5

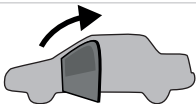

Open the driver door.

6

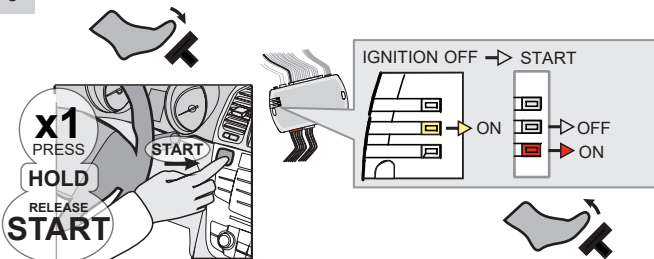

Press the foot-brake pedal.

Press the Push-to-Start button until the engine start.

Release the foot-brake pedal.

↳The RED LED will turn ON.
↳The YELLOW LED will turn OFF.

KEY BYPASS PROGRAMMING PROCEDURE 2/3

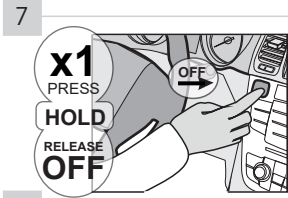

Press the Push-to-Start button until the engine turn OFF.

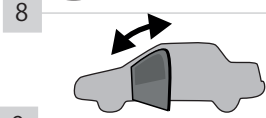

Close and open the driver door.

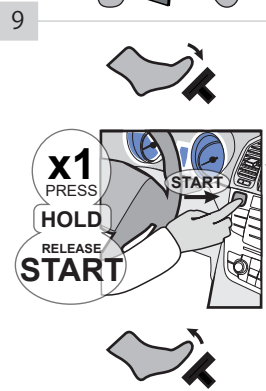

Press the foot-brake pedal.

Press the Push-to-Start button until the engine start.

Release the foot-brake pedal.

↳ The BLUE LED will turn ON.

↳ The BLUE LED will turn OFF.
The RED LED will turn OFF.

↳ The YELLOW LED will flash rapidly

↳ The BLUE LED will turn ON.

↳ The BLUE LED will flash rapidly

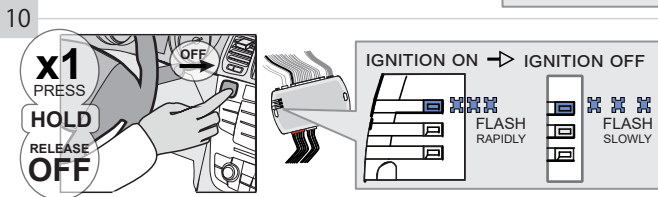

Press the Push-to-Start button until the engine turn OFF.

↳ The BLUE LED will flash slowly

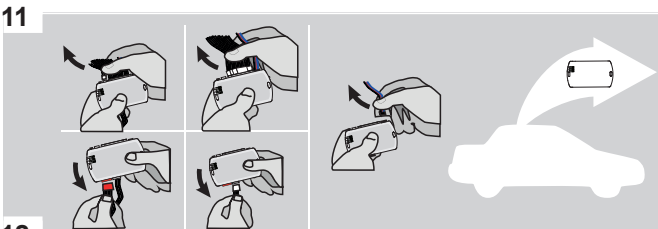

Disconnect all the connectors and after the Data-Link (4-pins) connector.

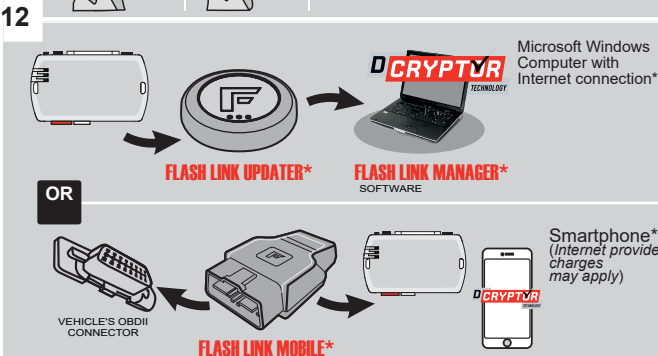

Use the tool: **FLASH LINK UPDATER** or **FLASH LINK MOBILE** to visit the DCRYPTOR menu.

*Parts required (not included)

KEY BYPASS PROGRAMMING PROCEDURE 3/3

13

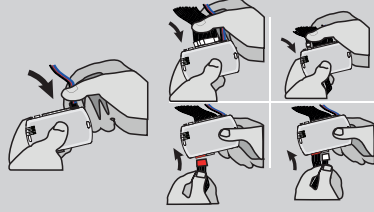
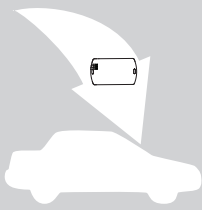

AFTER DCRYPTOR PROGRAMMING COMPLETED
Go back to the vehicle and **reconnect** the 4-Pin (Data-Link) connector and after, all the remaining connector.



The module is now programmed.



REMOTE STARTER / ALARM VERIFICATION PROCEDURE

Test the remote starter. Remote start the vehicle.

REMOTE STARTER FUNCTIONALITY



All doors must be closed.



Remote start the vehicle.



Unlock the doors with either:

- The OEM remote
- The remote-starter remote
- Or the proximity remote

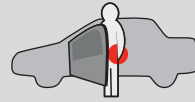

Enter the vehicle with the Intelligent Key.



The vehicle can now be put in to gear and driven.

If the vehicle is not unlocked with one of these conditions the remote-starter will shut down as soon as any door is opened.



THAR-GM6

THARNNESS STAND ALONE INSTALLATION

ADDENDUM - SUGGESTED WIRING CONFIGURATION



ONLY COMPATIBLE WITH AUTOMATIC TRANSMISSION VEHICLES.

VEHICLE	YEARS	Vehicle functions supported in this diagram (functional if equipped)												
		Immobilizer bypass	Lock	Unlock	Arm	Disarm	RAP Disable	Tachometer	Heated Seats	Door Status	Hand-Brake Status	Foot-Brake Status	OEM Remote Monitoring	
														
GMC														
Sierra 1500	Push-To-Start	2019-2020	•	•	•	•	•	•	•	•	•	•	•	•
Sierra 2500	Push-To-Start	2020	•	•	•	•	•	•	•	•	•	•	•	•
Sierra 3500	Push-To-Start	2020	•	•	•	•	•	•	•	•	•	•	•	•



FIRMWARE VERSION

70.[41]

GM MINIMUM

To add the firmware version and the options, use the **FLASH LINK UPDATER** or **FLASH LINK MOBILE** tool, sold separately.

IF THE VEHICLE IS NOT EQUIPPED WITH FUNCTIONAL HOOD PIN:

A11

OFF

Hood trigger (Output Status).

	Program bypass option:	UNIT OPTION	DESCRIPTION
		C1	OEM Remote status (Lock/Unlock) monitoring
		D6	Push-to-Start



ATTENTION!

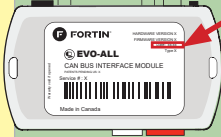

DATE: XX-XX

E5

OFF

ON

SPECIAL FUNCTIONS: BY DEFAULT DEACTIVATED

MANUFACTURED MODULES BETWEEN: 04/2018 TO 04/2019



Parts required (Not included)

1X THAR-GM6

MANDATORY INSTALL

*HOOD PIN



HOOD STATUS: THE HOOD PIN SWITCH MUST BE INSTALLED IF THE VEHICLE CAN BE REMOTE STARTED WITH THE HOOD OPEN, SET FUNCTION A11 TO OFF.

A11

OFF

Notice: the installation of safety elements are mandatory. The hood pin is an essential security element and must be installed.

THIS MODULE MUST BE INSTALLED BY A QUALIFIED TECHNICIAN. A WRONG CONNECTION CAN CAUSE PERMANENT DAMAGE TO THE VEHICLE.

PARTS REQUIRED (NOT INCLUDED)

1x **FLASH LINK UPDATER,**
 1x **FLASH LINK MANAGER**
 SOFTWARE | PROGRAMME
 1x Microsoft Windows Computer with Internet connection

OR

1x **FLASH LINK MOBILE**
 1x **FLASH LINK MOBILE APP**
 Smartphone *Android* or *iOS* with Internet connection (*provider charges may apply*).

MANDATORY

HOOD PIN



REMOTE START SAFETY OVERRIDE SWITCH

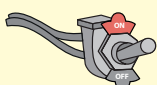





VALET SWITCH

Part #: RSPB available, Sold separately.

Notice: the installation of safety elements are mandatory. The hood pin and the valet switch are essential security elements and must be installed.

STAND ALONE CONFIGURATION

	Program bypass option	UNIT OPTION	DESCRIPTION
	OEM Remote Stand Alone Remote Starter:	D1.10 	By default, LOCK, LOCK, LOCK
		D1.1 	Par défaut, VERROUILLE,VERROUILLE,VERROUILLE
	Program bypass option with oem remote:	C1	OEM Remote Monitoring
	Program bypass option with RF KIT antenna:	H1 to H6	Supported RF Kits and select RF Kit

REMOTE STARTER FUNCTIONALITY



All doors must be closed.

3X 

Press the OEM remote's Lock button 3x to remote-start (or remote-stop) the vehicle.



START

The vehicle will START.

REMOTE STARTER DIAGNOSTICS
MODULE RED LED

x2 flash :	Brake ON
x3 flash :	No tach
x4 flash :	Ignition before start
x5 flash :	Hood Open

REMOTE STARTER WARNING CARD



CUT THIS WARNING CARD AND STICK IT ON A VISIBLE PLACE:
 or use the package **RSPB**, Sold separately.

WARNING | ATTENTION



REMOTE STARTER

THE VEHICLE CAN BE STARTED BY EITHER: PRESSING THE LOCK BUTTON ON THE OEM REMOTE 3 TIMES CONSECUTIVELY OR BY A SMARTPHONE. **TURN ON** THE SAFETY SWITCH LOCATED UNDER THE DASHBOARD BEFORE WORKING ON THE VEHICLE.

DESCRIPTION

BCM, Above Driver kick panel

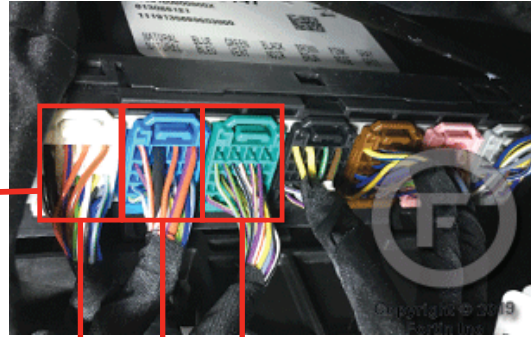

①



②

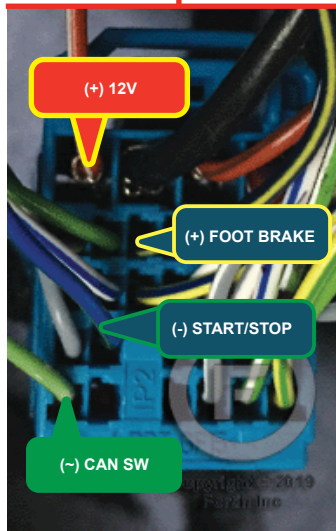

③

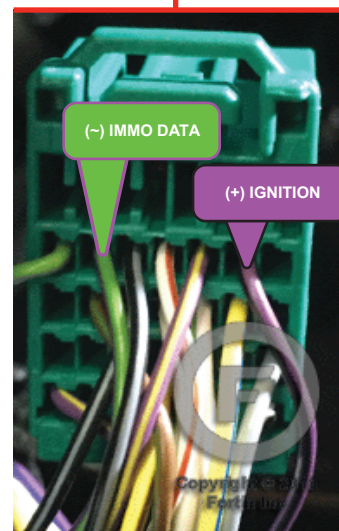

AUTOMATIC TRANSMISSION WIRING CONNECTION

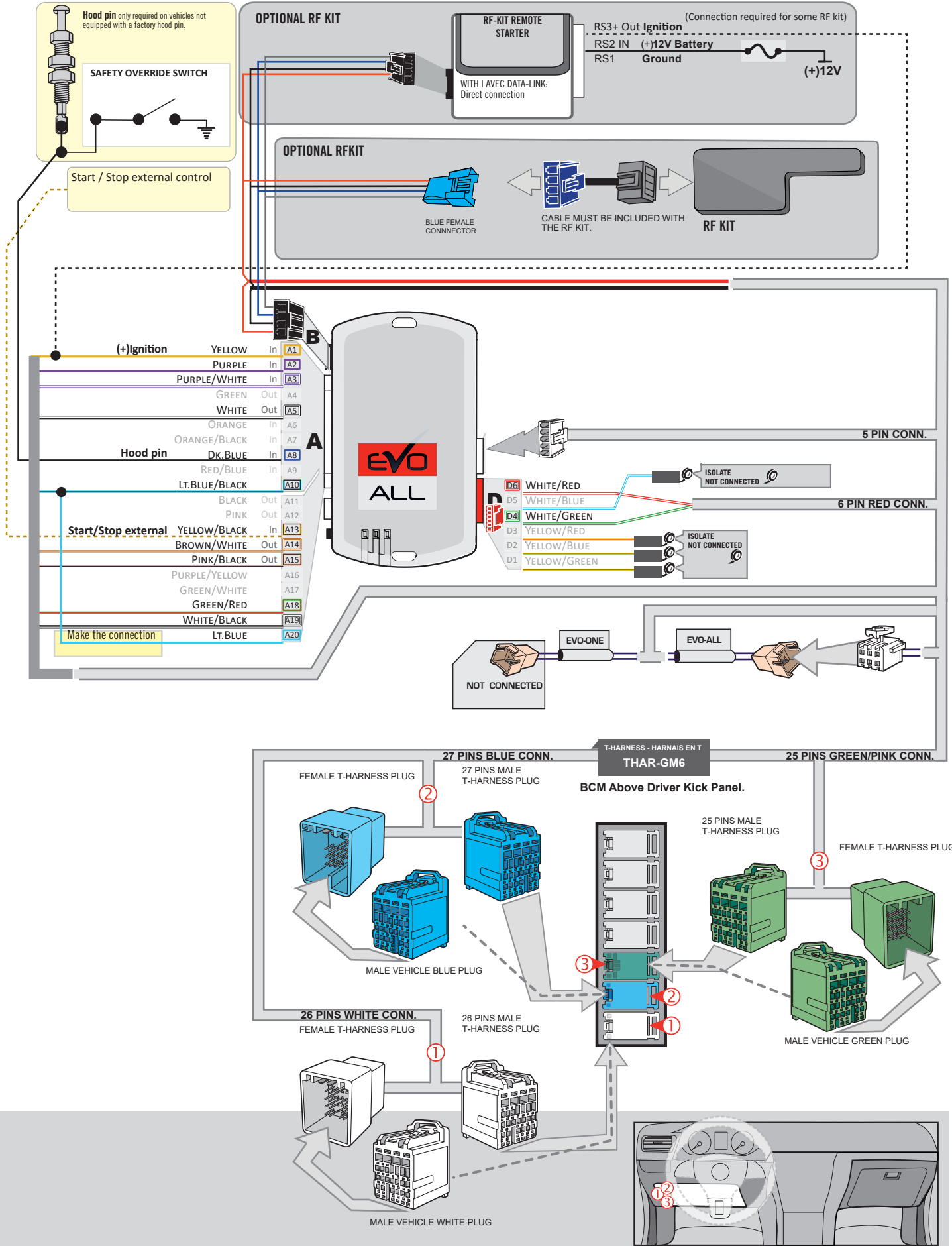

KEY BYPASS PROGRAMMING PROCEDURE 1/3

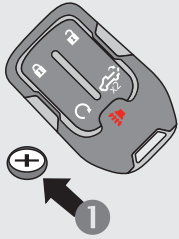

- 1 Remove the battery from the OEM remote.
- 2 Place the OEM remotes in to the center console.

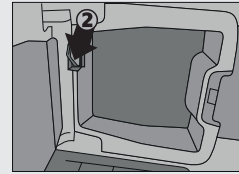

- 1 Remove the battery from the OEM remote.
 - 2 Place the transmitter in the cupholder
- Refer to vehicle user guide for keyport location.

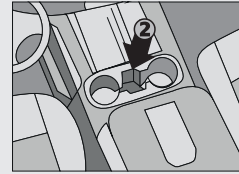

1

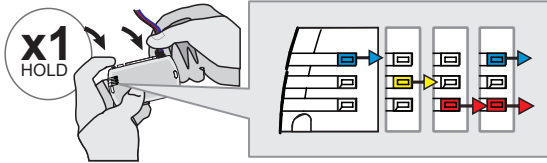

Press and hold the programming button:
Connect the 4-PIN Data-link harness (Black connector).

↳The Blue, Red, Yellow and Blue & Red LEDs will alternatively illuminate.

2

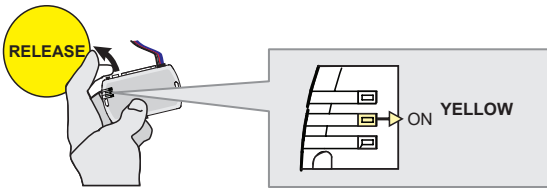

Release the programming button when the LED is YELLOW.

If the LED is not solid YELLOW disconnect the 4-Pin connector (Data-Link) and go back to step 1.

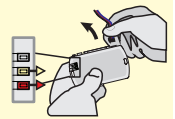

3

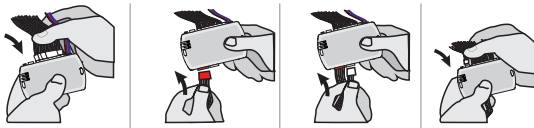

Insert the required remaining connectors.

4

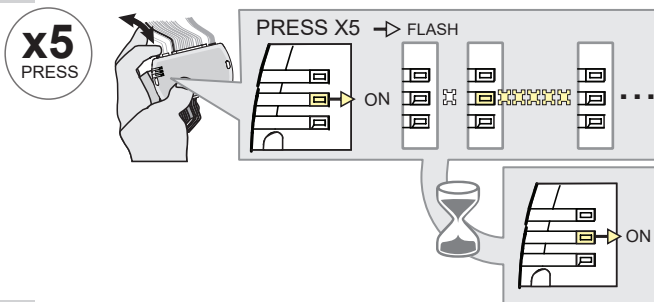

Press and release the programming button five (5x) times.

↳The YELLOW LED will flash 5 times each second.

↳WAIT for the YELLOW LED to turn ON solide.

5

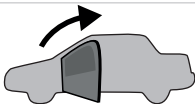

Open the driver door.

6

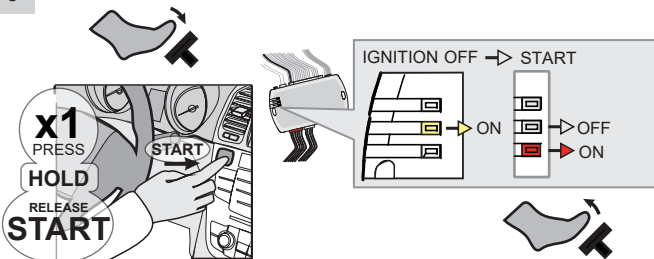

Press the foot-brake pedal.

Press the Push-to-Start button until the engine start.

Release the foot-brake pedal.

↳The RED LED will turn ON.
↳The YELLOW LED will turn OFF.

KEY BYPASS PROGRAMMING PROCEDURE 2/3

7



Press the Push-to-Start button until the engine turn OFF.

8

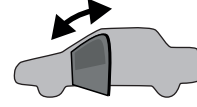

Close and open the driver door.

9

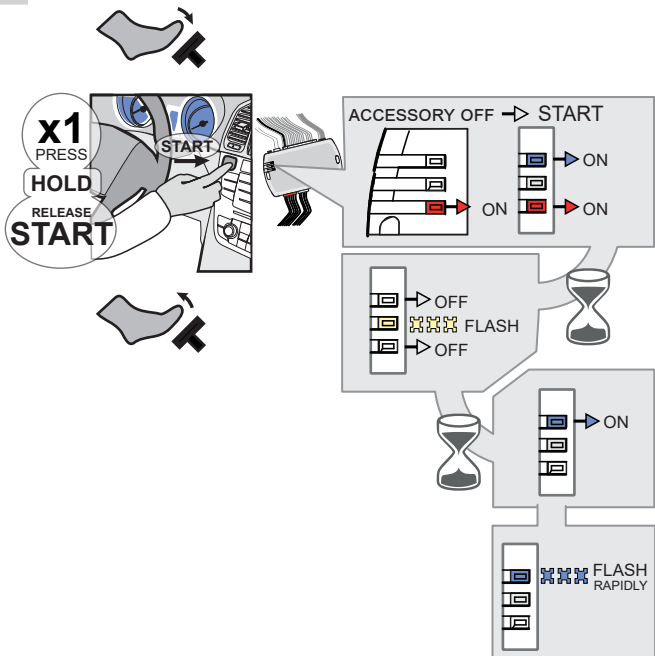

Press the foot-brake pedal.

Press the Push-to-Start button until the engine start.

Release the foot-brake pedal.

- ↳ The BLUE LED will turn ON.
- ↳ The BLUE LED will turn OFF. The RED LED will turn OFF.
- ↳ The YELLOW LED will flash rapidly
- ↳ The BLUE LED will turn ON.
- ↳ The BLUE LED will flash rapidly

10

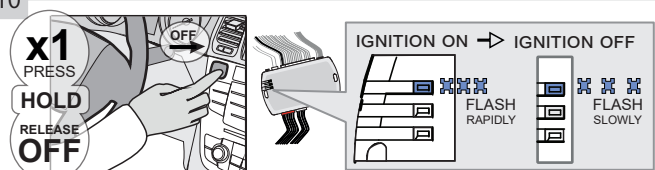

Press the Push-to-Start button until the engine turn OFF.

- ↳ The BLUE LED will flash slowly

11

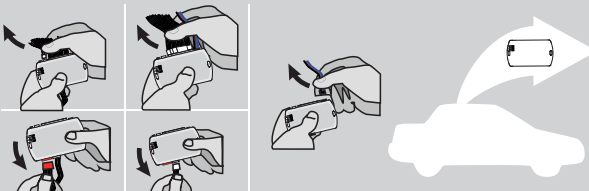

Disconnect all the connectors and after the Data-Link (4-pins) connector.

12

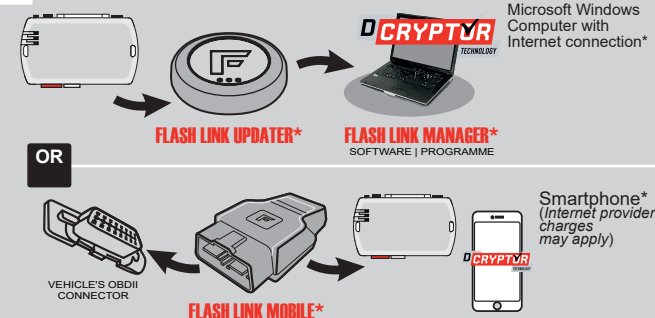

Microsoft Windows Computer with Internet connection*

FLASH LINK UPDATER* FLASH LINK MANAGER*
SOFTWARE | PROGRAMME

OR

Smartphone* (Internet provider charges may apply)

VEHICLE'S OBDII CONNECTOR FLASH LINK MOBILE*

Use the tool: FLASH LINK UPDATER or FLASH LINK MOBILE to visit the DCryptor menu.

*Parts required (not included)

KEY BYPASS PROGRAMMING PROCEDURE 3/3

13

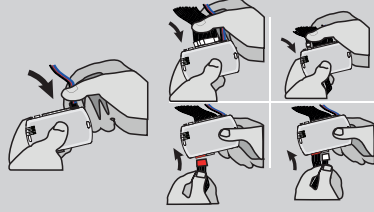
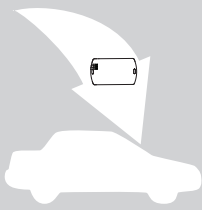

AFTER DCRYPTOR PROGRAMMING COMPLETED
Go back to the vehicle and **reconnect** the 4-Pin (Data-Link) connector and after, all the remaining connector.



The module is now programmed.



REMOTE STARTER / ALARM VERIFICATION PROCEDURE

Test the remote starter. Remote start the vehicle.

OPTIONAL RF-KIT PROGRAMMING



PROGRAM BYPASS OPTION

	<p>Program bypass option:</p>	<p>H2</p>	<p><input checked="" type="checkbox"/> Supported RF-KITS enable <input checked="" type="checkbox"/> H2 Fortin 2</p>
---	-------------------------------	------------------	---













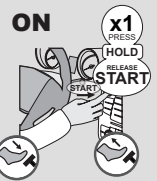



OPTIONAL FORTIN RF KIT SERIES 4 OR SERIES 9 PROGRAMMING

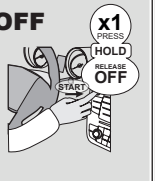
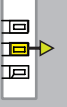

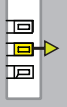
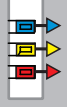
The module must be programmed on the vehicle.

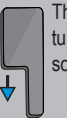
MAKE SURE THE IGNITION KEY HAS BEEN IN THE OFF POSITION FOR AT LEAST 5 SECONDS.

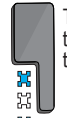
1	2	3	4	5	6
<p>ON x1 PRESS (HOLD) START</p>  <p>Press the foot-brake pedal. Press the Push-to-Start button until the engine start. Release the foot-brake pedal.</p>	<p>OFF x1 PRESS (HOLD) START OFF</p>  <p>Press the Push-to-Start button until the engine turn OFF.</p>	<p>ON x1 PRESS (HOLD) START</p>  <p>Press the foot-brake pedal. Press the Push-to-Start button until the engine start. Release the foot-brake pedal.</p>	<p>4X BRAKES x4 PRESS</p>  <p>Press and release the brake pedal four times.</p>	<p>ON EACH TRANSMITTER</p> <p>4 BUTTONS</p> <p> PRESS AND RELEASE</p> <p> PRESS AND RELEASE</p> <p></p> <p>1 BUTTON</p> <p> PRESS APPROX. 12 SEC. AND WAIT FOR THE BLUE LED TO TURN OFF THEN BACK ON SOLID THEN RELEASE.</p>	<p>OFF x1 PRESS (HOLD) START OFF</p>  <p>Press the Push-to-Start button until the engine turn OFF.</p>
 <p>The YELLOW LED will turn ON solid.</p>	 <p>The YELLOW LED will turn Off.</p>	 <p>The YELLOW LED will turn ON solid.</p>	 <p>The 3 LED will turn ON solid.</p>	 <p>The LED will flash rapidly.</p>	 <p>The 3 LED will turn off.</p>
		 <p>The LED will turn ON solide.</p>	 <p>The LED will flash rapidly.</p>	 <p>The LED will turn off each time.</p>	 <p>The LED will turn Off.</p>
			 <p>The 3 LED will turn off each time.</p>		

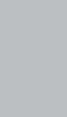

REMOTE STARTER FUNCTIONALITY



All doors must be closed.

Remote start the vehicle.



Press the Unlock button of the remote car starter.



Enter the vehicle with the Intelligent Access Key.



The vehicle can now be put in to gear and driven.



If the vehicle is not unlocked the module will shut down the remote-starter and the vehicle as soon as any door is opened.

THARNESS STAND ALONE INSTALLATION

ADDENDUM - SUGGESTED WIRING CONFIGURATION



ONLY COMPATIBLE WITH AUTOMATIC TRANSMISSION VEHICLES.



VEHICLE	YEARS	Vehicle functions supported in this diagram (functional if eq)												
		Immobilizer bypass	Lock	Unlock	Arm	Disarm	RAP Disable	Tachometer	Heated Seats	Door Status	Hand-Brake Status	Foot-Brake Status	OEM Remote Monitoring	
CHEVROLET														
Silverado 2500	Push-To-Start	2020-2021	•	•	•	•	•	•	•	•	•	•	•	•
GMC														
Sierra 2500	Push-To-Start	2020-2021	•	•	•	•	•	•	•	•	•	•	•	•

FIRMWARE VERSION

70.[45]

GM MINIMUM

To add the firmware version and the options, use the **FLASH LINK UPDATER** or **FLASH LINK MOBILE** tool, sold separately.

	UNIT OPTION	DESCRIPTION
<p>Program bypass option:</p>	C1	OEM Remote status (Lock/Unlock) monitoring
IF THE VEHICLE IS NOT EQUIPPED WITH FUNCTIONAL HOOD PIN:	A11	<div style="background-color: red; color: white; padding: 5px; display: inline-block;">OFF</div> Hood trigger (Output Status).
	D6	Push-to-Start

ATTENTION!

DATE: XX-XX

E5

OFF

ON

SPECIAL FUNCTIONS:
BY DEFAULT DEACTIVATED

MANUFACTURED MODULES BETWEEN: 04/2018 TO 04/2019

Parts required (Not included)
1X THAR-GM6

MANDATORY INSTALL

*HOOD PIN



HOOD STATUS: THE HOOD PIN SWITCH MUST BE INSTALLED IF THE VEHICLE CAN BE REMOTE STARTED WITH THE HOOD OPEN, SET FUNCTION A11 TO OFF.

A11

OFF

Notice: the installation of safety elements are mandatory. The hood pin is an essential security element and must be installed.

THIS MODULE MUST BE INSTALLED BY A QUALIFIED TECHNICIAN. A WRONG CONNECTION CAN CAUSE PERMANENT DAMAGE TO THE VEHICLE.

PARTS REQUIRED (NOT INCLUDED)

1x **FLASH LINK UPDATER**
 1x **FLASH LINK MANAGER**
 SOFTWARE | PROGRAMME
 1x Microsoft Windows Computer with Internet connection

OR

1x **FLASH LINK MOBILE**
 1x **FLASH LINK MOBILE APP**
 Smartphone *Android* or *iOS* with Internet connection (*provider charges may apply*).
 1x

MANDATORY

HOOD PIN



REMOTE START SAFETY OVERRIDE SWITCH

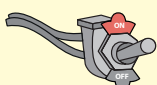





VALET SWITCH

Part #: RSPB available, Sold separately.

Notice: the installation of safety elements are mandatory. The hood pin and the valet switch are essential security elements and must be installed.

STAND ALONE CONFIGURATION

	Program bypass option	UNIT OPTION	DESCRIPTION
	OEM Remote Stand Alone Remote Starter:	D1.10 	By default, LOCK, LOCK, LOCK Par défaut, VERROUILLE,VERROUILLE,VERROUILLE
		D1.1 	
	Program bypass option with oem remote:	C1	OEM Remote Monitoring
	Program bypass option with RF KIT antenna:	H1 to H6	Supported RF Kits and select RF Kit

REMOTE STARTER FUNCTIONALITY



All doors must be closed.

3X 

Press the OEM remote's Lock button 3x to remote-start (or remote-stop) the vehicle.



START 

The vehicle will START.

REMOTE STARTER DIAGNOSTICS
MODULE RED LED

x2 flash :	Brake ON
x3 flash :	No tach
x4 flash :	Ignition before start
x5 flash :	Hood Open

REMOTE STARTER WARNING CARD



CUT THIS WARNING CARD AND STICK IT ON A VISIBLE PLACE:
 or use the package **RSPB**, Sold separately.

WARNING



REMOTE STARTER

THE VEHICLE CAN BE STARTED BY EITHER: PRESSING THE LOCK BUTTON ON THE OEM REMOTE 3 TIMES CONSECUTIVELY OR BY A SMARTPHONE. **TURN ON** THE SAFETY SWITCH LOCATED UNDER THE DASHBOARD BEFORE WORKING ON THE VEHICLE.

DESCRIPTION

BCM

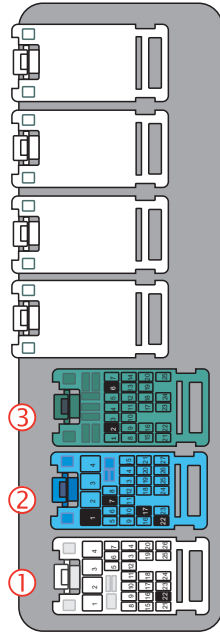
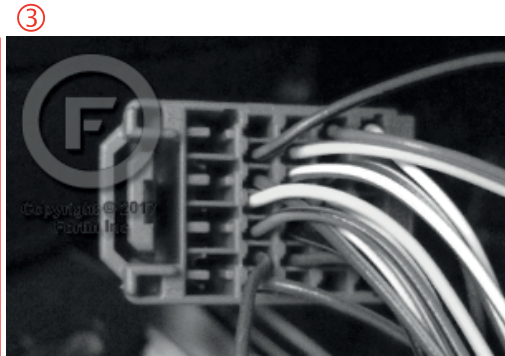

AUTOMATIC TRANSMISSION WIRING CONNECTION

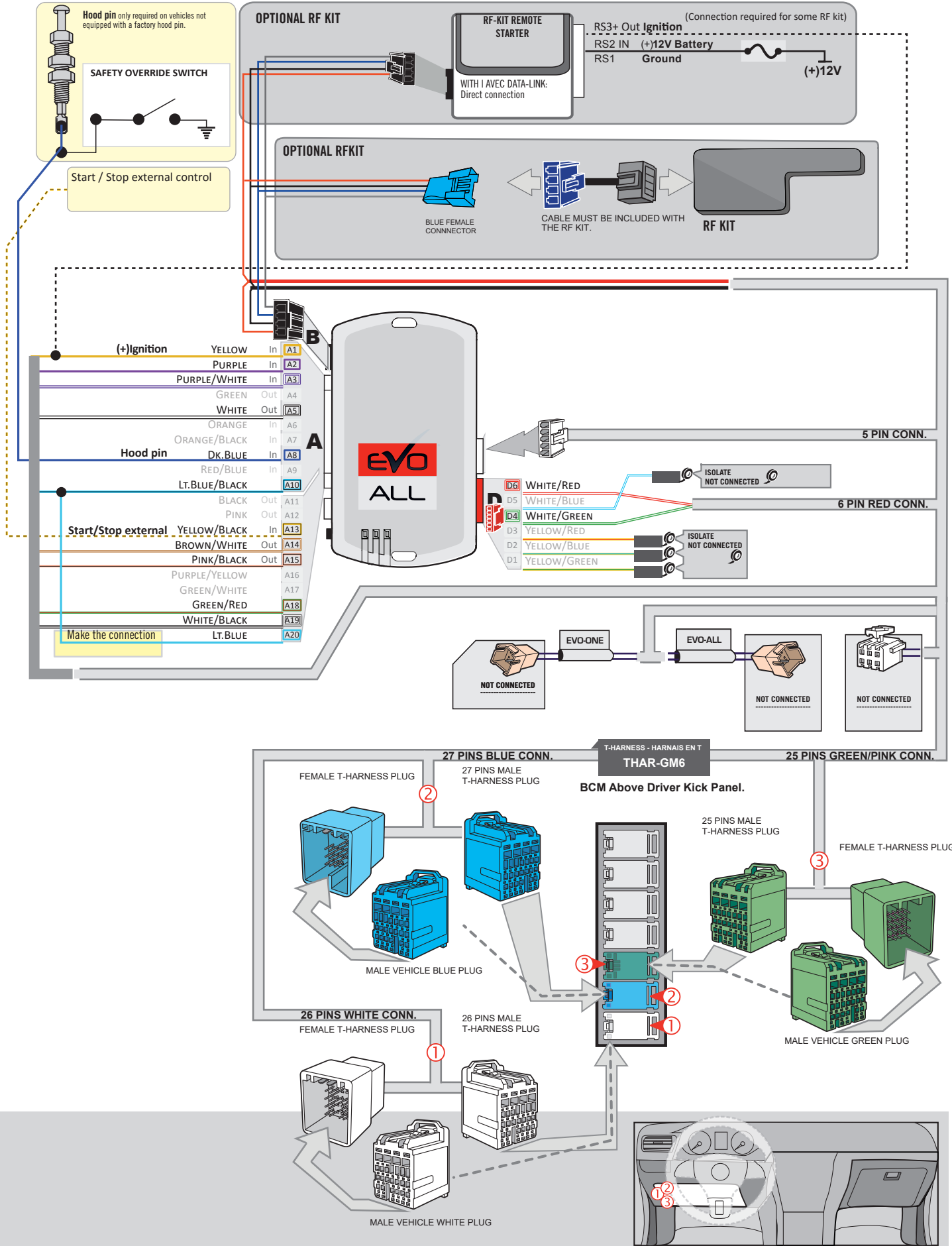

KEY BYPASS PROGRAMMING PROCEDURE 1/3

**SIERRA
SILVERADO**

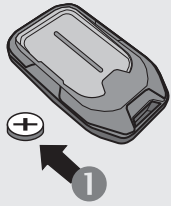

- 1 Remove the battery from the OEM remote.
- 2 Place the OEM remote in the middle part of the cup holder in the center console.

Refer to vehicle user guide for keyport location.

- 1 Remove the battery from the OEM remote.
- 2 Place the transmitter in the transmitter pocket, which is inside the centre console storage area.

Refer to vehicle user guide for keyport location.

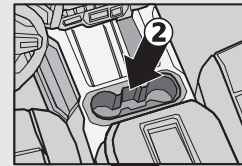

OR
OU

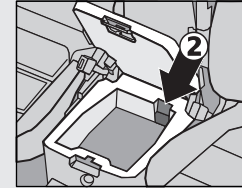

1

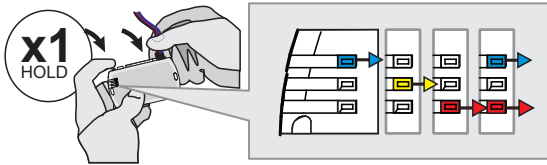

Press and hold the programming button:
Connect the 4-PIN Data-link harness (Black connector).

↳The Blue, Red, Yellow and Blue & Red LEDs will alternatively illuminate.

2

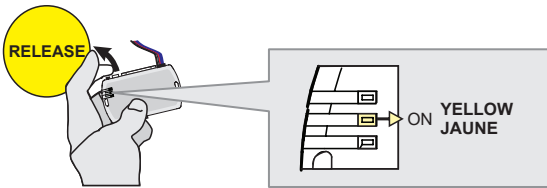

Release the programming button when the LED is **YELLOW**.

If the LED is not solid YELLOW disconnect the 4-Pin connector (Data-Link) and go back to step 1.

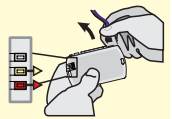

3

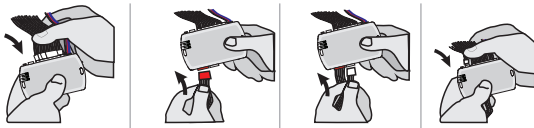

Insert the required remaining connectors.

4

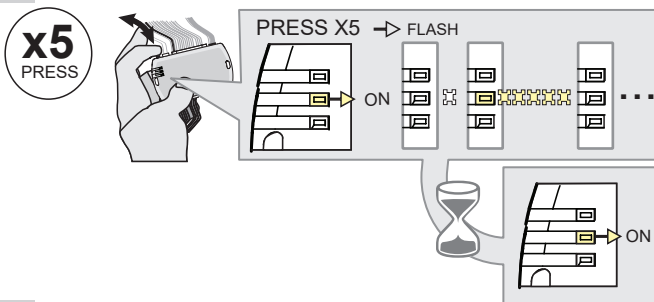

Press and release the programming button five (5x) times.

↳The YELLOW LED will flash 5 times each second.

↳**WAIT** for the YELLOW LED to turn ON solide.

5

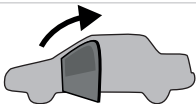

Open the driver door.

6

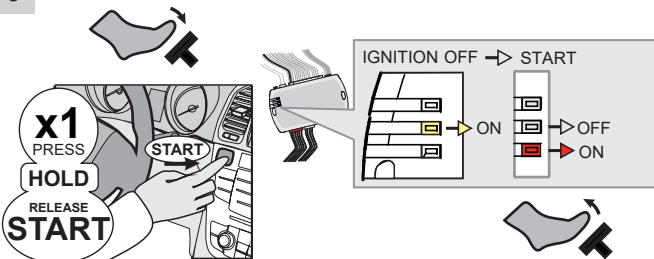

Press the foot-brake pedal.

Press the Push-to-Start button until the engine start.

Release the foot-brake pedal.

↳The RED LED will turn ON.
↳The YELLOW LED will turn OFF.

KEY BYPASS PROGRAMMING PROCEDURE 2/3 |

7



Press the Push-to-Start button until the engine turn OFF.

8

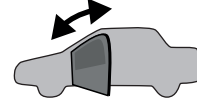

Close and open the driver door.

9

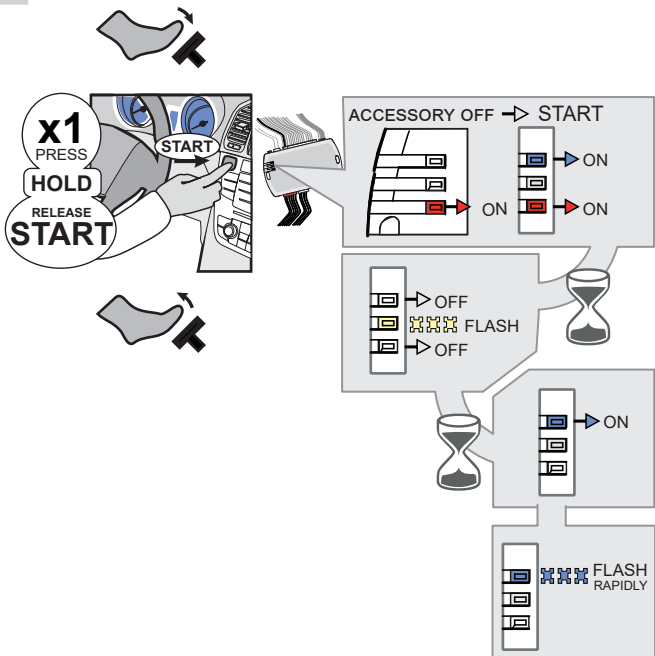

Press the foot-brake pedal.

Press the Push-to-Start button until the engine start.

Release the foot-brake pedal.

- ↳ The BLUE LED will turn ON.
- ↳ The BLUE LED will turn OFF. The RED LED will turn OFF.
- ↳ The YELLOW LED will flash rapidly
- ↳ The BLUE LED will turn ON.
- ↳ The BLUE LED will flash rapidly

10

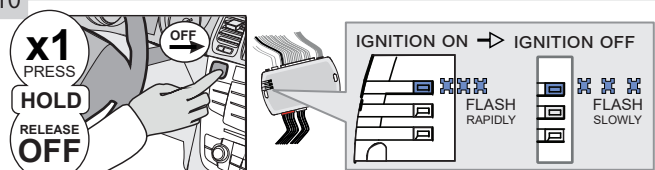

Press the Push-to-Start button until the engine turn OFF.

- ↳ The BLUE LED will flash slowly

11

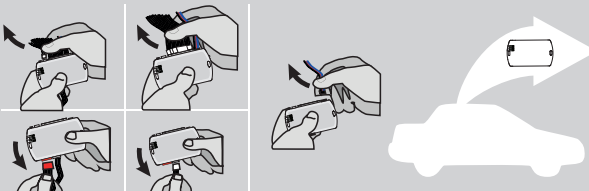

Disconnect all the connectors and after the Data-Link (4-pins) connector.

12

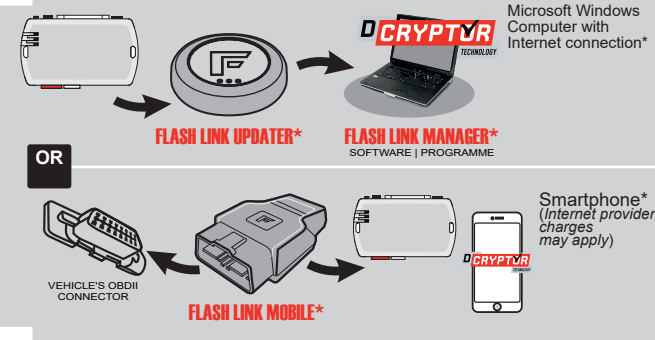

Use the tool: FLASH LINK UPDATER or FLASH LINK MOBILE to visit the DCRYPTOR menu.

*Parts required (not included)

13

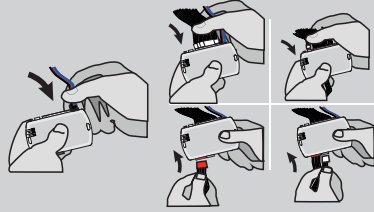
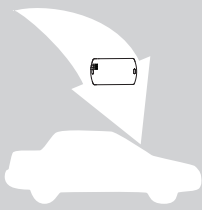

AFTER DCRYPTOR PROGRAMMING COMPLETED
Go back to the vehicle and **reconnect** the 4-Pin (Data-Link) connector and after, all the remaining connector.



The module is now programmed.



REMOTE STARTER / ALARM VERIFICATION PROCEDURE

Test the remote starter. Remote start the vehicle.

REMOTE STARTER FUNCTIONALITY |



All doors must be closed.

Remote start the vehicle.



Press the Unlock button of the remote car starter or the OEM remote.

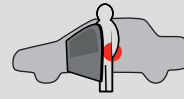

Enter the vehicle with the Intelligent Access Key.

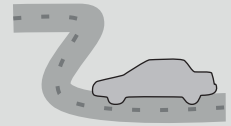

The vehicle can now be put in to gear and driven.



If the vehicle is not unlocked the module will shut down the remote-starter and the vehicle as soon as any door is opened.

THARNESS STAND ALONE INSTALLATION

THAR-GM6

ADDENDUM - SUGGESTED WIRING CONFIGURATION



ONLY COMPATIBLE WITH AUTOMATIC TRANSMISSION VEHICLES.

VEHICLE	YEARS	Vehicle functions supported in this diagram (functional if equipped)													
		Immobilizer bypass	Lock	Unlock	Arm	Disarm	RAP Disable	Tachometer	Heated Seats	Door Status	Hand-Brake Status	Foot-Brake Status	OEM Remote Monitoring		
															
CHEVROLET															
Silverado 1500	Push-To-Start	2019	•	•	•	•	•	•	•	•	•	•	•	•	•



FIRMWARE VERSION

70.[41]

GM MINIMUM

To add the firmware version and the options, use the **FLASH LINK UPDATER** or **FLASH LINK MOBILE** tool, sold separately.

<p>IF THE VEHICLE IS NOT EQUIPPED WITH FUNCTIONAL HOOD PIN:</p>	A11	OFF	Hood trigger (Output Status).
--	------------	------------	-------------------------------

	Program bypass option:	UNIT OPTION	DESCRIPTION
		C1	OEM Remote status (Lock/Unlock) monitoring
		D6	Push-to-Start

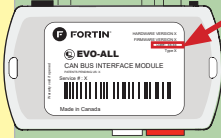
	ATTENTION!	 <p>DATE: XX-XX</p>	E5	OFF	<p>SPECIAL FUNCTIONS: BY DEFAULT DEACTIVATED</p>
				ON	<p>MANUFACTURED MODULES BETWEEN: 04/2018 TO 04/2019</p>



Parts required (Not included)

1X THAR-GM6

MANDATORY INSTALL		A11	OFF	
<p>*HOOD PIN</p> 	<p>HOOD STATUS: THE HOOD PIN SWITCH MUST BE INSTALLED IF THE VEHICLE CAN BE REMOTE STARTED WITH THE HOOD OPEN, SET FUNCTION A11 TO OFF.</p>			<p>Notice: the installation of safety elements are mandatory. The hood pin is an essential security element and must be installed.</p>
				<p>THIS MODULE MUST BE INSTALLED BY A QUALIFIED TECHNICIAN. A WRONG CONNECTION CAN CAUSE PERMANENT DAMAGE TO THE VEHICLE.</p>

PARTS REQUIRED (NOT INCLUDED)

1x **FLASH LINK UPDATER,**
 1x **FLASH LINK MANAGER**
 SOFTWARE | PROGRAMME
 1x Microsoft Windows Computer with Internet connection

OR

1x **FLASH LINK MOBILE**
 1x **FLASH LINK MOBILE APP**
 Smartphone *Android* or *iOS* with Internet connection (*provider charges may apply*).

MANDATORY

HOOD PIN



REMOTE START SAFETY OVERRIDE SWITCH

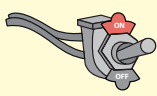





VALET SWITCH

Part #: RSPB available, Sold separately.

Notice: the installation of safety elements are mandatory. The hood pin and the valet switch are essential security elements and must be installed.

STAND ALONE CONFIGURATION

	Program bypass option	UNIT OPTION	DESCRIPTION
	OEM Remote Stand Alone Remote Starter:	D1.10 	By default, LOCK, LOCK, LOCK Par défaut, VERROUILLE,VERROUILLE,VERROUILLE
		D1.1 	
	Program bypass option with oem remote:	C1	OEM Remote Monitoring
	Program bypass option with RF KIT antenna:	H1 to H6	Supported RF Kits and select RF Kit

REMOTE STARTER FUNCTIONALITY



All doors must be closed.

3X 

Press the OEM remote's Lock button 3x to remote-start (or remote-stop) the vehicle.



The vehicle will START.

REMOTE STARTER DIAGNOSTICS
MODULE RED LED

x2 flash :	Brake ON
x3 flash :	No tach
x4 flash :	Ignition before start
x5 flash :	Hood Open

REMOTE STARTER WARNING CARD



CUT THIS WARNING CARD AND STICK IT ON A VISIBLE PLACE:
 or use the package **RSPB**, Sold separately.

WARNING

REMOTE STARTER

THE VEHICLE CAN BE STARTED BY EITHER: PRESSING THE LOCK BUTTON ON THE OEM REMOTE 3 TIMES CONSECUTIVELY OR BY A SMARTPHONE. **TURN ON** THE SAFETY SWITCH LOCATED UNDER THE DASHBOARD BEFORE WORKING ON THE VEHICLE.

DESCRIPTION

BCM, Above Driver kick panel

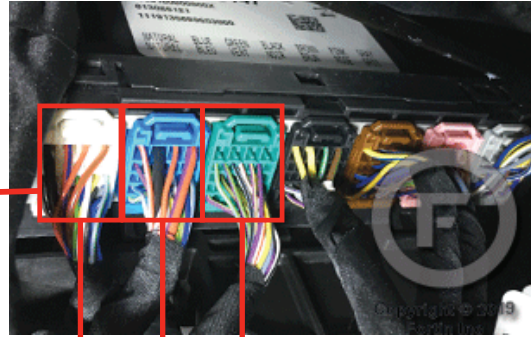

①



②

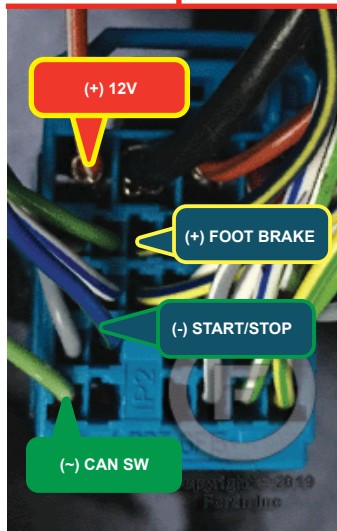

③

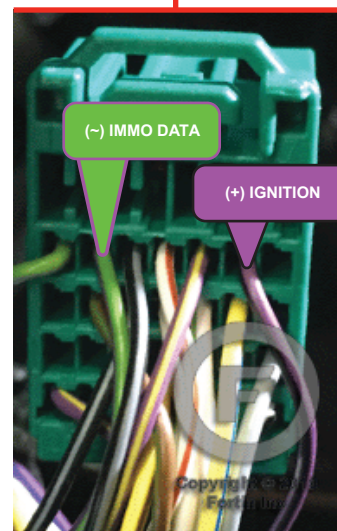

AUTOMATIC TRANSMISSION WIRING CONNECTION

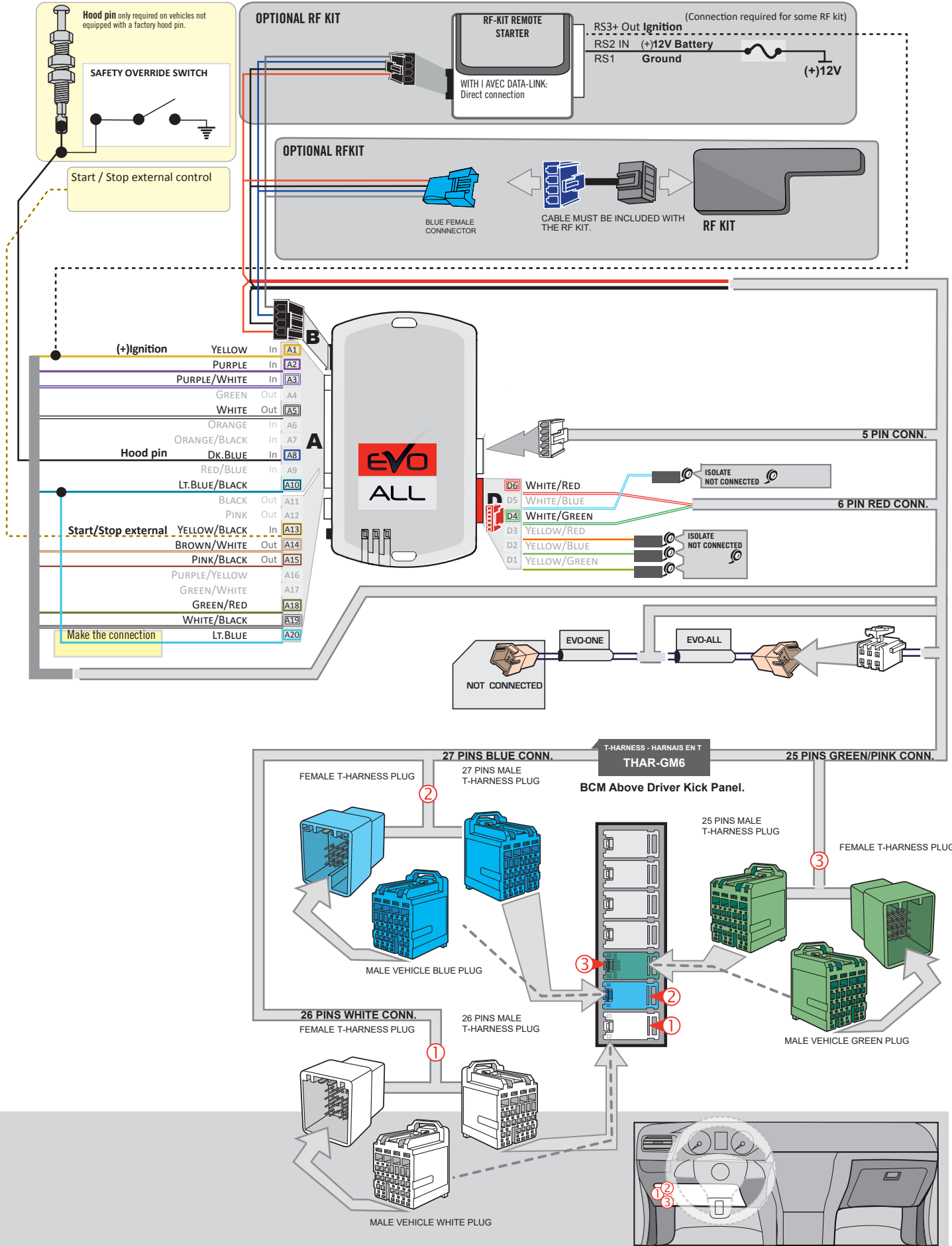

KEY BYPASS PROGRAMMING PROCEDURE 1/3

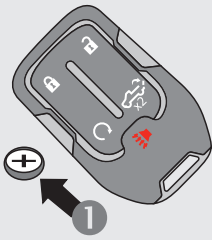

1 Remove the battery from the OEM remote.

2 Place the OEM remotes in to the center console.

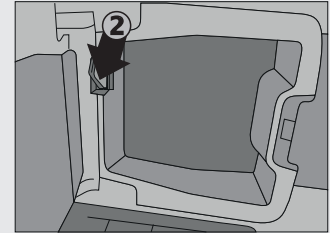

1

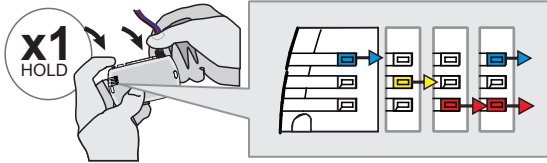

Press and hold the programming button:
Connect the 4-PIN Data-link harness (Black connector).

↳The Blue, Red, Yellow and Blue & Red LEDs will alternatively illuminate.

2

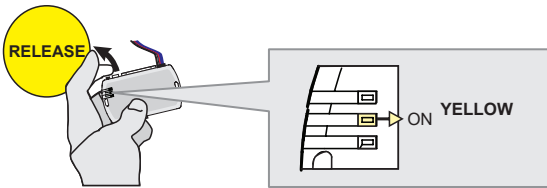

Release the programming button when the LED is YELLOW.

If the LED is not solid YELLOW disconnect the 4-Pin connector (Data-Link) and go back to step 1.

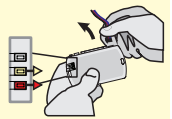

3

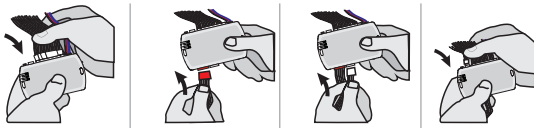

Insert the required remaining connectors.

4

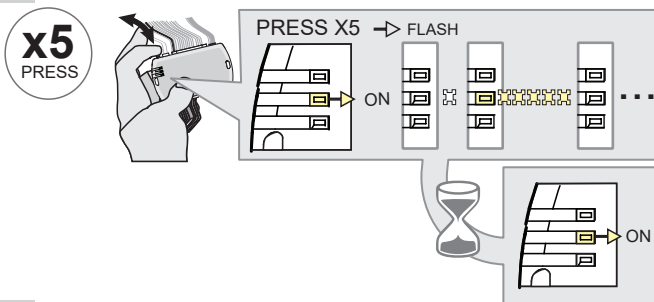

Press and release the programming button five (5x) times.

↳The YELLOW LED will flash 5 times each second.

↳WAIT for the YELLOW LED to turn ON solide.

5

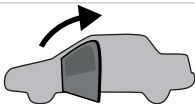

Open the driver door.

6

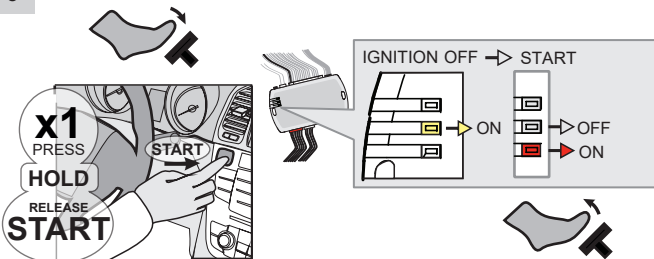

Press the foot-brake pedal.

Press the Push-to-Start button until the engine start.

Release the foot-brake pedal.

↳The RED LED will turn ON.
↳The YELLOW LED will turn OFF.

KEY BYPASS PROGRAMMING PROCEDURE 2/3

7

Press the Push-to-Start button until the engine turn OFF.

8

Close and open the driver door.

9

Press the foot-brake pedal.

Press the Push-to-Start button until the engine start.

Release the foot-brake pedal.

- ↳ The BLUE LED will turn ON.
- ↳ The BLUE LED will turn OFF. The RED LED will turn OFF.
- ↳ The YELLOW LED will flash rapidly
- ↳ The BLUE LED will turn ON.
- ↳ The BLUE LED will flash rapidly

10

Press the Push-to-Start button until the engine turn OFF.

- ↳ The BLUE LED will flash slowly

11

Disconnect all the connectors and after the Data-Link (4-pins) connector.

12

Use the tool: FLASH LINK UPDATER or FLASH LINK MOBILE to visit the DCRYPTOR menu.

***Parts required (not included)**

KEY BYPASS PROGRAMMING PROCEDURE 3/3

13

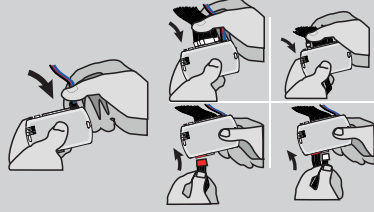
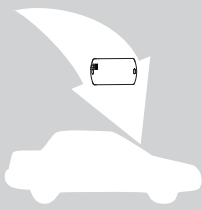

AFTER DCRYPTOR PROGRAMMING COMPLETED
Go back to the vehicle and **reconnect** the 4-Pin (Data-Link) connector and after, all the remaining connector.



The module is now programmed.



REMOTE STARTER / ALARM VERIFICATION PROCEDURE













Test the remote starter. Remote start the vehicle.

OPTIONAL RF-KIT PROGRAMMING

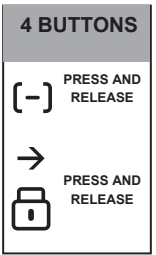
PROGRAM BYPASS OPTION

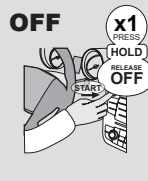
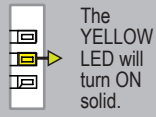
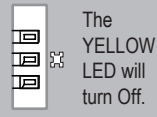
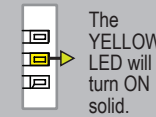
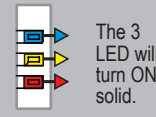
	<p>Program bypass option:</p>	<p>H2</p>	<p><input checked="" type="checkbox"/> Supported RF-KITS enable <input checked="" type="checkbox"/> H2 Fortin 2</p>
---	-------------------------------	------------------	---

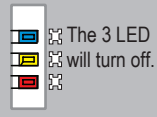
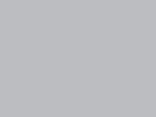
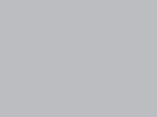
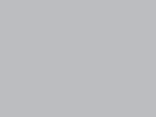
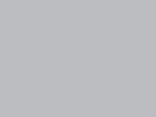
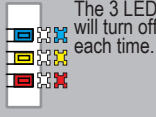
OPTIONAL FORTIN RF KIT SERIES 4 OR SERIES 9 PROGRAMMING

<p>The module must be programmed on the vehicle.</p>   <p>MAKE SURE THE IGNITION KEY HAS BEEN IN THE OFF POSITION FOR AT LEAST 5 SECONDS.</p>	<p>1</p> <p>ON</p>  <p>ON Press the foot-brake pedal. Press the Push-to-Start button until the engine start. Release the foot-brake pedal.</p>	<p>2</p> <p>OFF</p>  <p>OFF Press the Push-to-Start button until the engine turn OFF.</p>	<p>3</p> <p>ON</p>  <p>ON Press the foot-brake pedal. Press the Push-to-Start button until the engine start. Release the foot-brake pedal.</p>	<p>4</p> <p>4X BRAKES</p>  <p>4X PRESS</p> <p>Press and release the brake pedal four times.</p>  <p>The LED will turn off each time.</p>	<p>5</p> <p>ON EACH TRANSMITTER</p> <p>4 BUTTONS</p>  <p>1 BUTTON</p>  <p>PRESS APPROX. 12 SEC. AND WAIT FOR THE BLUE LED TO TURN OFF THEN BACK ON SOLID THEN RELEASE.</p>	<p>6</p> <p>OFF</p>  <p>OFF Press the Push-to-Start button until the engine turn OFF.</p>
	 <p>The YELLOW LED will turn ON solid.</p>	 <p>The YELLOW LED will turn Off.</p>	 <p>The YELLOW LED will turn ON solid.</p>	 <p>The 3 LED will turn ON solid.</p>	 <p>The LED will flash rapidly.</p>	 <p>The LED will turn Off.</p>
	 <p>The 3 LED will turn off.</p>	 <p>The 3 LED will turn off.</p>	 <p>The 3 LED will turn off each time.</p>	 <p>The 3 LED will turn off each time.</p>	 <p>The 3 LED will turn off each time.</p>	 <p>The 3 LED will turn off.</p>



REMOTE STARTER FUNCTIONALITY



All doors must be closed.

Remote start the vehicle.



Press the Unlock button of the remote car starter.



Enter the vehicle with the Intelligent Access Key.



The vehicle can now be put in to gear and driven.



If the vehicle is not unlocked the module will shut down the remote-starter and the vehicle as soon as any door is opened.

THARNESS STAND ALONE INSTALLATION

ADDENDUM - SUGGESTED WIRING CONFIGURATION

THAR-GM6



ONLY COMPATIBLE WITH AUTOMATIC TRANSMISSION VEHICLES.



VEHICLE

YEARS

Vehicle functions supported in this diagram (functional if equipped)

CHEVROLET

Volt	Push-To-Start	2016-2019	•	•	•	•	•	•	•	•	•	•	•	•	•	•	•	•	•
------	---------------	-----------	---	---	---	---	---	---	---	---	---	---	---	---	---	---	---	---	---



FIRMWARE VERSION

70.[41]

GM MINIMUM

To add the firmware version and the options, use the **FLASH LINK UPDATER** or **FLASH LINK MOBILE** tool, sold separately.

IF THE VEHICLE IS NOT EQUIPPED WITH FUNCTIONAL HOOD PIN:

A11

OFF

Hood trigger (Output Status).



Program bypass option:

UNIT OPTION

DESCRIPTION

C1

OEM Remote status (Lock/Unlock) monitoring

D6

Push-to-Start



Program bypass option (Vehicle hybrid only):

UNIT OPTION

DESCRIPTION

D4

Hybrid mode (Vehicle hybrid only)



ATTENTION!

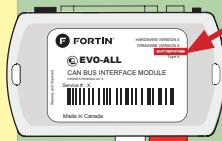

DATE: XX-XX

E5

OFF

SPECIAL FUNCTIONS: BY DEFAULT DEACTIVATED

ON

MANUFACTURED MODULES BETWEEN: 04/2018 TO 04/2019



Parts required (Not included)

- 1X 5 Amp Fuse
- 1X 1k Ohm Resistor

MANDATORY INSTALL

*HOOD PIN



HOOD STATUS: THE HOOD PIN SWITCH MUST BE INSTALLED IF THE VEHICLE CAN BE REMOTE STARTED WITH THE HOOD OPEN, SET FUNCTION A11 TO OFF.

A11

OFF

Notice: the installation of safety elements are mandatory. The hood pin is an essential security element and must be installed.

THIS MODULE MUST BE INSTALLED BY A QUALIFIED TECHNICIAN. A WRONG CONNECTION CAN CAUSE PERMANENT DAMAGE TO THE VEHICLE.

PARTS REQUIRED (NOT INCLUDED)

1x **FLASH LINK UPDATER,**
 1x **FLASH LINK MANAGER**
 SOFTWARE | PROGRAMME
 1x Microsoft Windows Computer with Internet connection

OR

1x **FLASH LINK MOBILE**
 1x **FLASH LINK MOBILE APP**
 Smartphone *Android* or *iOS* with Internet connection (*provider charges may apply*).

MANDATORY

HOOD PIN



REMOTE START SAFETY OVERRIDE SWITCH

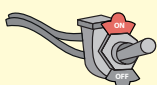





VALET SWITCH

Part #: RSPB available, Sold separately.

Notice: the installation of safety elements are mandatory. The hood pin and the valet switch are essential security elements and must be installed.



STAND ALONE CONFIGURATION

	Program bypass option	UNIT OPTION	DESCRIPTION
	OEM Remote Stand Alone Remote Starter:	D1.10 	By default, LOCK, LOCK, LOCK Par défaut, VERROUILLE, VERROUILLE, VERROUILLE
		D1.1 	
	Program bypass option with oem remote:	C1	OEM Remote Monitoring
	Program bypass option with RF KIT antenna:	H1 to H6	Supported RF Kits and select RF Kit

REMOTE STARTER FUNCTIONALITY



All doors must be closed.

3X  

Press the OEM remote's Lock button 3x to remote-start (or remote-stop) the vehicle.



The vehicle will START.

REMOTE STARTER DIAGNOSTICS
MODULE RED LED

x2 flash :	Brake ON
x3 flash :	No tach
x4 flash :	Ignition before start
x5 flash :	Hood Open

REMOTE STARTER WARNING CARD



CUT THIS WARNING CARD AND STICK IT ON A VISIBLE PLACE:
 or use the package RSPB, Sold separately.

WARNING | ATTENTION

REMOTE STARTER

THE VEHICLE CAN BE STARTED BY EITHER: PRESSING THE LOCK BUTTON ON THE OEM REMOTE 3 TIMES CONSECUTIVELY OR BY A SMARTPHONE. **TURN ON** THE SAFETY SWITCH LOCATED UNDER THE DASHBOARD BEFORE WORKING ON THE VEHICLE.

DESCRIPTION

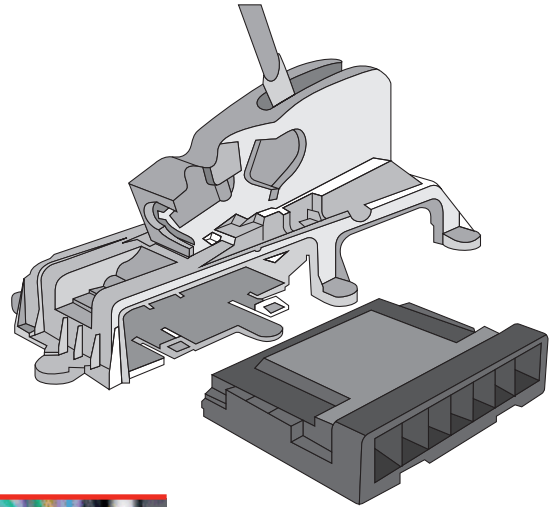

BCM

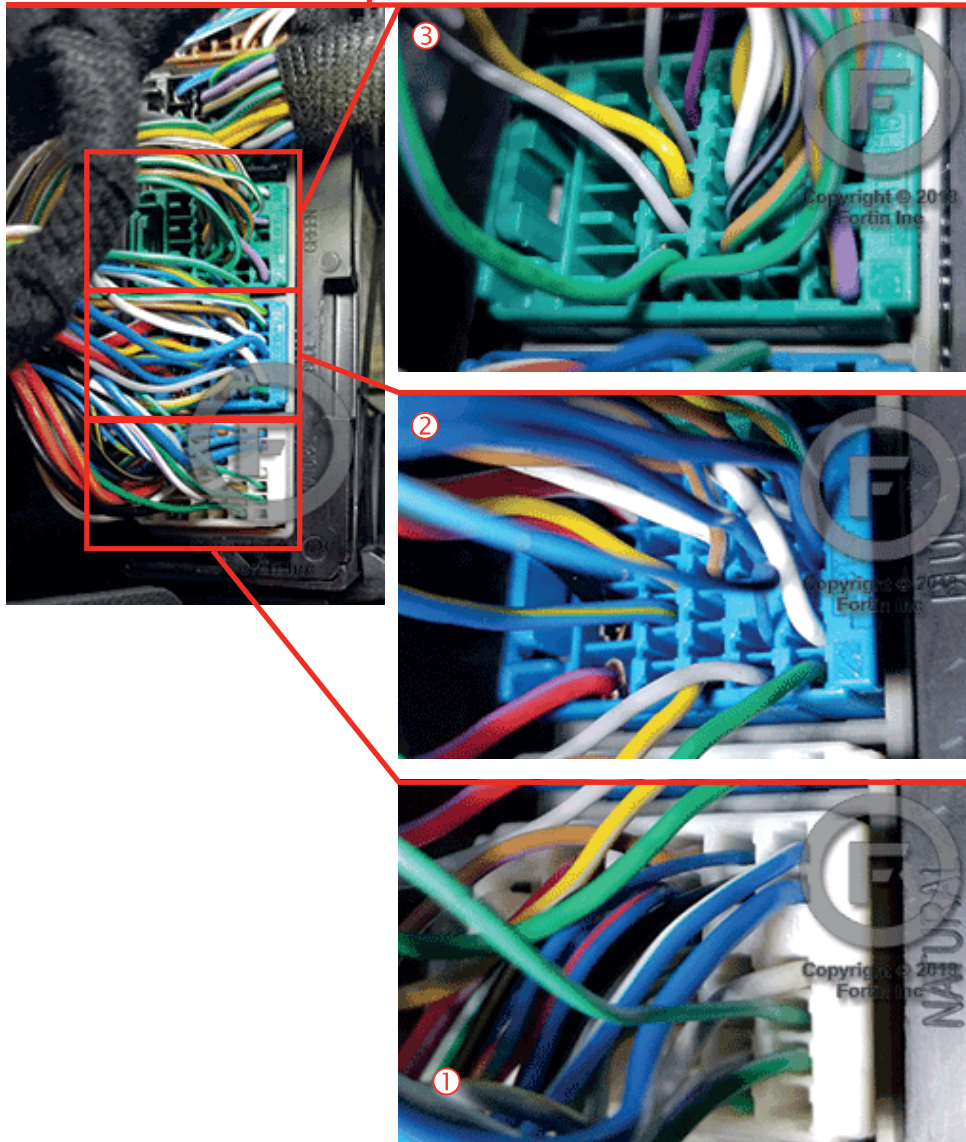

AUTOMATIC TRANSMISSION WIRING CONNECTION

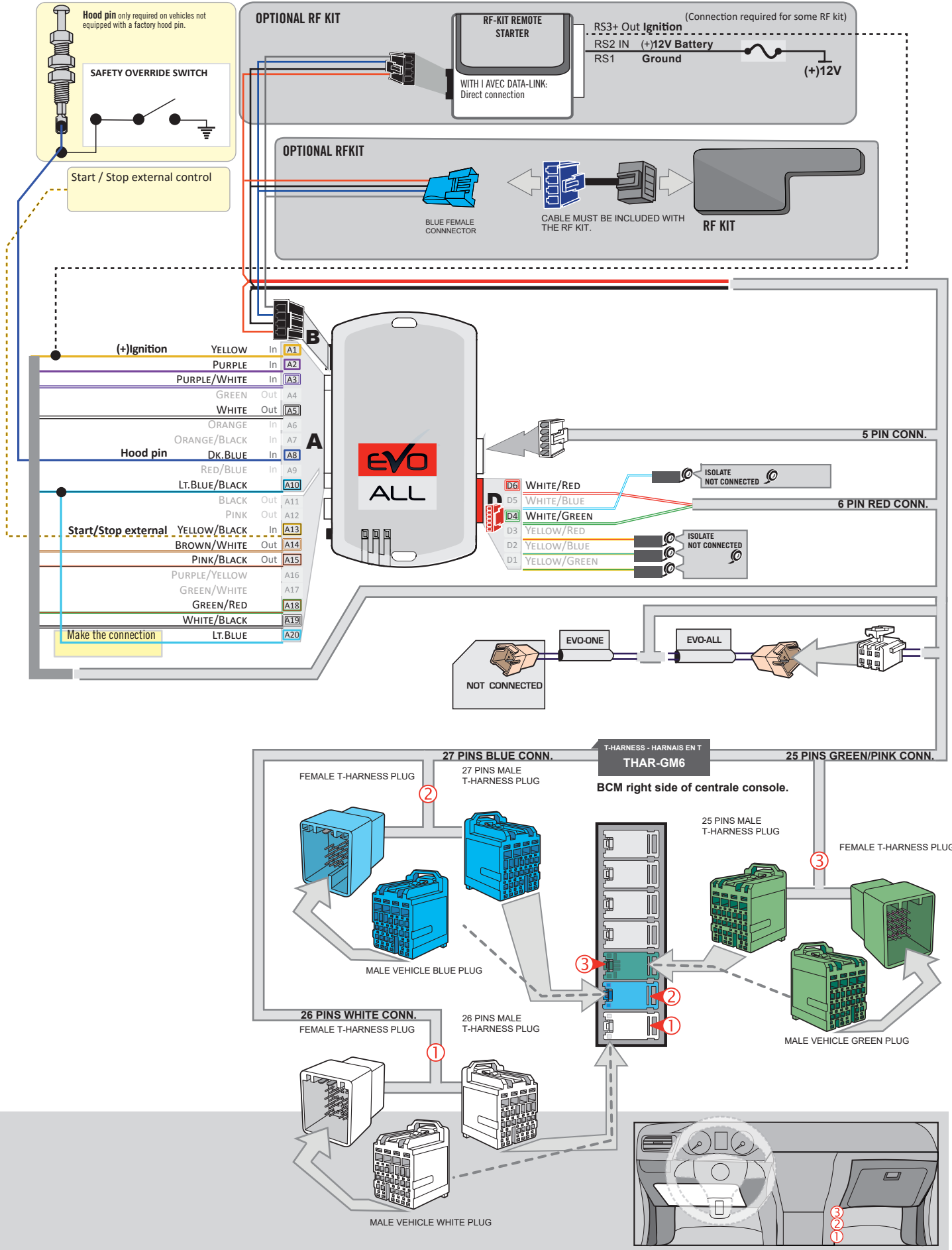

KEY BYPASS PROGRAMMING PROCEDURE 1/3



- 1** Remove the battery from the OEM remote.
- 2** Place the OEM remote into the center console.
Refer to vehicle user guide for keyport location.

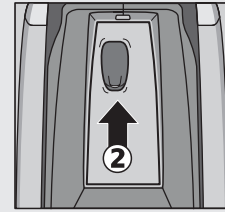

1

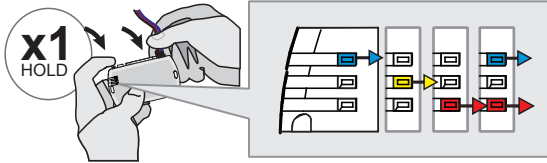

Press and hold the programming button:
Connect the 4-PIN Data-link harness (Black connector).

↳The Blue, Red, Yellow and Blue & Red LEDs will alternatively illuminate.

2

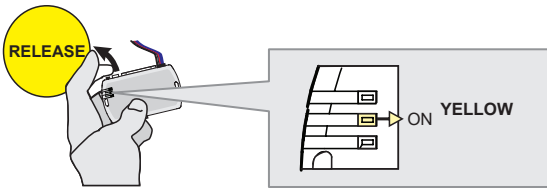

Release the programming button when the LED is YELLOW.

If the LED is not solid YELLOW disconnect the 4-Pin connector (Data-Link) and go back to step 1.

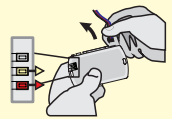

3

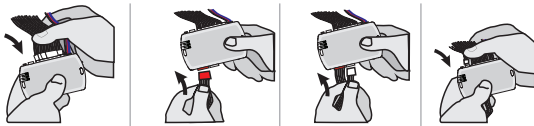

Insert the required remaining connectors.

4

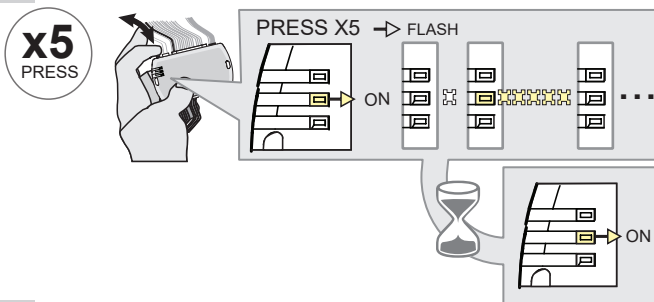

Press and release the programming button five (5x) times.

↳The YELLOW LED will flash 5 times each second.

↳**WAIT** for the YELLOW LED to turn ON solide.

5

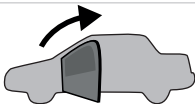

Open the driver door.

6

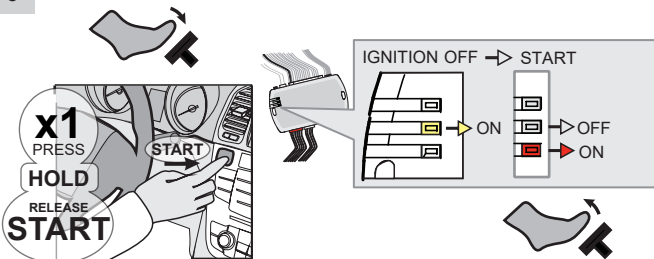

Press the foot-brake pedal.

Press the Push-to-Start button until the engine start.

Release the foot-brake pedal.

↳The RED LED will turn ON.
↳The YELLOW LED will turn OFF.

KEY BYPASS PROGRAMMING PROCEDURE 2/3

7



Press the Push-to-Start button until the engine turn OFF.

8

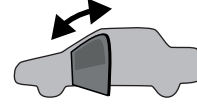

Close and open the driver door.

9

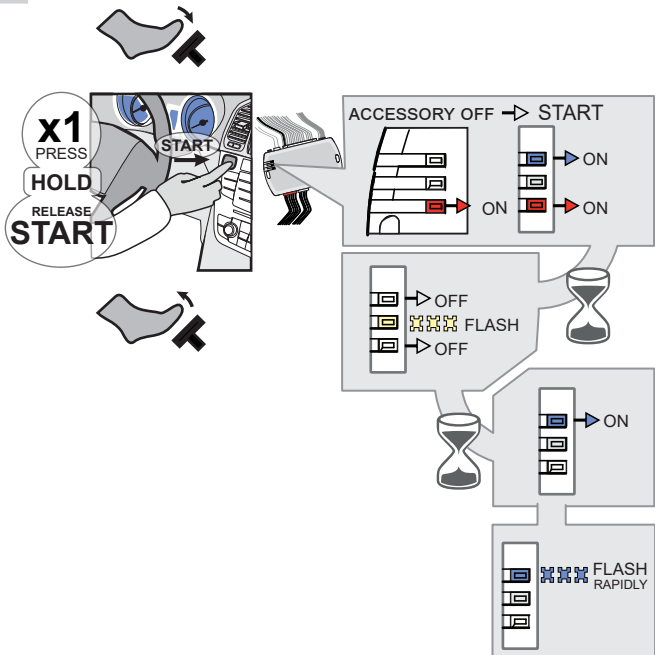

Press the foot-brake pedal.

Press the Push-to-Start button until the engine start.

Release the foot-brake pedal.

- ↳ The BLUE LED will turn ON.
- ↳ The BLUE LED will turn OFF. The RED LED will turn OFF.
- ↳ The YELLOW LED will flash rapidly
- ↳ The BLUE LED will turn ON.
- ↳ The BLUE LED will flash rapidly

10

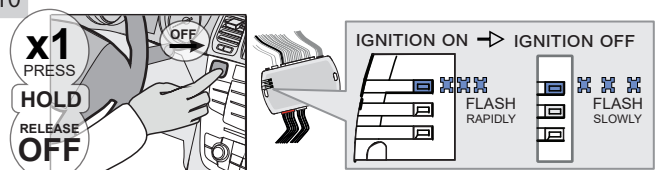

Press the Push-to-Start button until the engine turn OFF.

- ↳ The BLUE LED will flash slowly

11

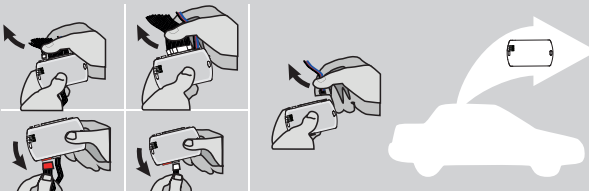

Disconnect all the connectors and after the Data-Link (4-pins) connector.

12

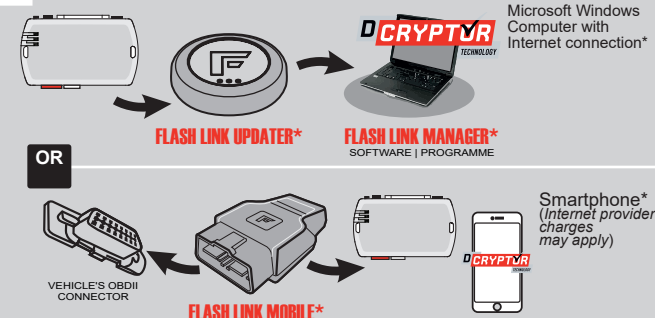

Use the tool: FLASH LINK UPDATER or FLASH LINK MOBILE to visit the DCryptor menu.

***Parts required (not included)**

KEY BYPASS PROGRAMMING PROCEDURE 3/3

13

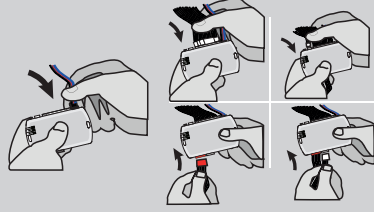
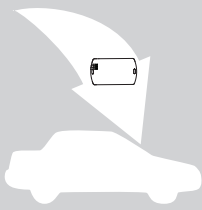

AFTER DCRYPTOR PROGRAMMING COMPLETED
Go back to the vehicle and **reconnect** the 4-Pin (Data-Link) connector and after, all the remaining connector.



The module is now programmed.



REMOTE STARTER / ALARM VERIFICATION PROCEDURE

Test the remote starter. Remote start the vehicle.

REMOTE STARTER FUNCTIONALITY



All doors must be closed.

Remote start the vehicle.



Press the Unlock button of the remote car starter or the OEM remote.

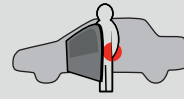

Enter the vehicle with the Intelligent Access Key.

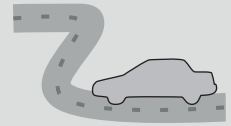

The vehicle can now be put in to gear and driven.



If the vehicle is not unlocked the module will shut down the remote-starter and the vehicle as soon as any door is opened.

THAR-GM6

THARNESSTAND ALONE INSTALLATION

ADDENDUM - SUGGESTED WIRING CONFIGURATION



ONLY COMPATIBLE WITH AUTOMATIC TRANSMISSION VEHICLES.



Vehicle functions supported in this diagram (functional if equipped)

VEHICLE	YEARS	Immobilizer bypass	Lock	Unlock	Arm	Disarm	Trunk (open)	RAP Disable	Tachometer	Heated Seats	Door Status	Trunk Status	Hand-Brake Status	Foot-Brake Status	OEM Remote Monitoring
CADILLAC															
Escalade	Push-To-Start	2020-2021	•	•	•	•	•	•	•	•	•	•	•	•	•
XT4	Push-To-Start	2019-2021	•	•	•	•	•	•	•	•	•	•	•	•	•
XT5	Push-To-Start	2017-2021	•	•	•	•	•	•	•	•	•	•	•	•	•
XT6	Push-To-Start	2020-2021	•	•	•	•	•	•	•	•	•	•	•	•	•



FIRMWARE VERSION

70.[45]

GM MINIMUM

To add the firmware version and the options, use the **FLASH LINK UPDATER** or **FLASH LINK MOBILE** tool, sold separately.



Program bypass option:

UNIT OPTION

DESCRIPTION

C1

OEM Remote status (Lock/Unlock) monitoring

IF THE VEHICLE IS NOT EQUIPPED WITH FUNCTIONAL HOOD PIN:

A11

OFF

Hood trigger (Output Status).

D6

Push-to-Start



ATTENTION!

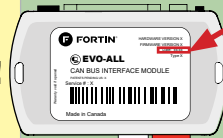

DATE: XX-XX

E5

OFF

SPECIAL FUNCTIONS: BY DEFAULT DEACTIVATED

ON

MANUFACTURED MODULES BETWEEN: 04/2018 TO 04/2019



Parts required (Not included)

1X THAR-GM6

MANDATORY INSTALL

*HOOD PIN



HOOD STATUS: THE HOOD PIN SWITCH MUST BE INSTALLED IF THE VEHICLE CAN BE REMOTE STARTED WITH THE HOOD OPEN, SET FUNCTION **A11** TO OFF.

A11

OFF

Notice: the installation of safety elements are mandatory. The hood pin is an essential security element and must be installed.

THIS MODULE MUST BE INSTALLED BY A QUALIFIED TECHNICIAN. A WRONG CONNECTION CAN CAUSE PERMANENT DAMAGE TO THE VEHICLE.

PARTS REQUIRED (NOT INCLUDED)

1x **FLASH LINK UPDATER,**
 1x **FLASH LINK MANAGER**
SOFTWARE | PROGRAMME
 1x Microsoft Windows Computer with Internet connection

OR

1x **FLASH LINK MOBILE**
 1x **FLASH LINK MOBILE APP**
Smartphone *Android* or *iOS* with Internet connection (*provider charges may apply*).

MANDATORY

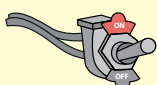



HOOD PIN  REMOTE START SAFETY OVERRIDE SWITCH 

VALET SWITCH

Part #: RSPB available, Sold separately.

Notice: the installation of safety elements are mandatory. The hood pin and the valet switch are essential security elements and must be installed.

STAND ALONE CONFIGURATION

	Program bypass option	UNIT OPTION	DESCRIPTION
	OEM Remote Stand Alone Remote Starter:	D1.10 	By default, LOCK, LOCK, LOCK
		D1.1 	Par défaut, VERROUILLE,VERROUILLE,VERROUILLE
	Program bypass option with oem remote:	C1	OEM Remote Monitoring
	Program bypass option with RF KIT antenna:	H1 to H6	Supported RF Kits and select RF Kit

REMOTE STARTER FUNCTIONALITY



All doors must be closed.

3X 

Press the OEM remote's Lock button 3x to remote-start (or remote-stop) the vehicle.



The vehicle will START.

REMOTE STARTER DIAGNOSTICS
MODULE RED LED

x2 flash :	Brake ON
x3 flash :	No tach
x4 flash :	Ignition before start
x5 flash :	Hood Open

REMOTE STARTER WARNING CARD



CUT THIS WARNING CARD AND STICK IT ON A VISIBLE PLACE:
 or use the package **RSPB**, Sold separately.

WARNING | ATTENTION

REMOTE STARTER

THE VEHICLE CAN BE STARTED BY EITHER: PRESSING THE LOCK BUTTON ON THE OEM REMOTE 3 TIMES CONSECUTIVELY OR BY A SMARTPHONE. **TURN ON** THE SAFETY SWITCH LOCATED UNDER THE DASHBOARD BEFORE WORKING ON THE VEHICLE.

DESCRIPTION

BCM located on passenger side center console



③



②

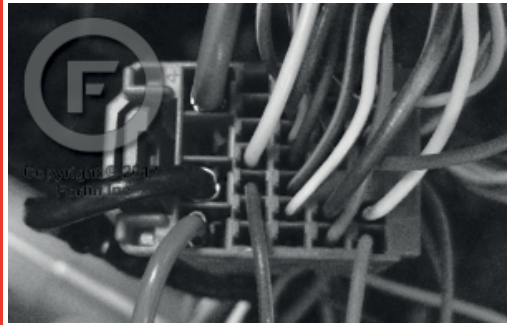

①

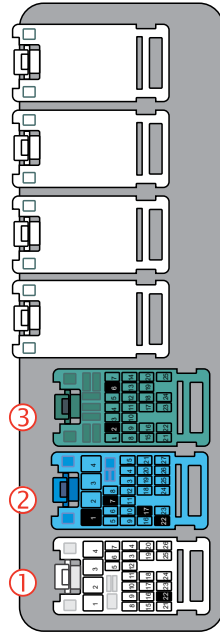

AUTOMATIC TRANSMISSION WIRING CONNECTION

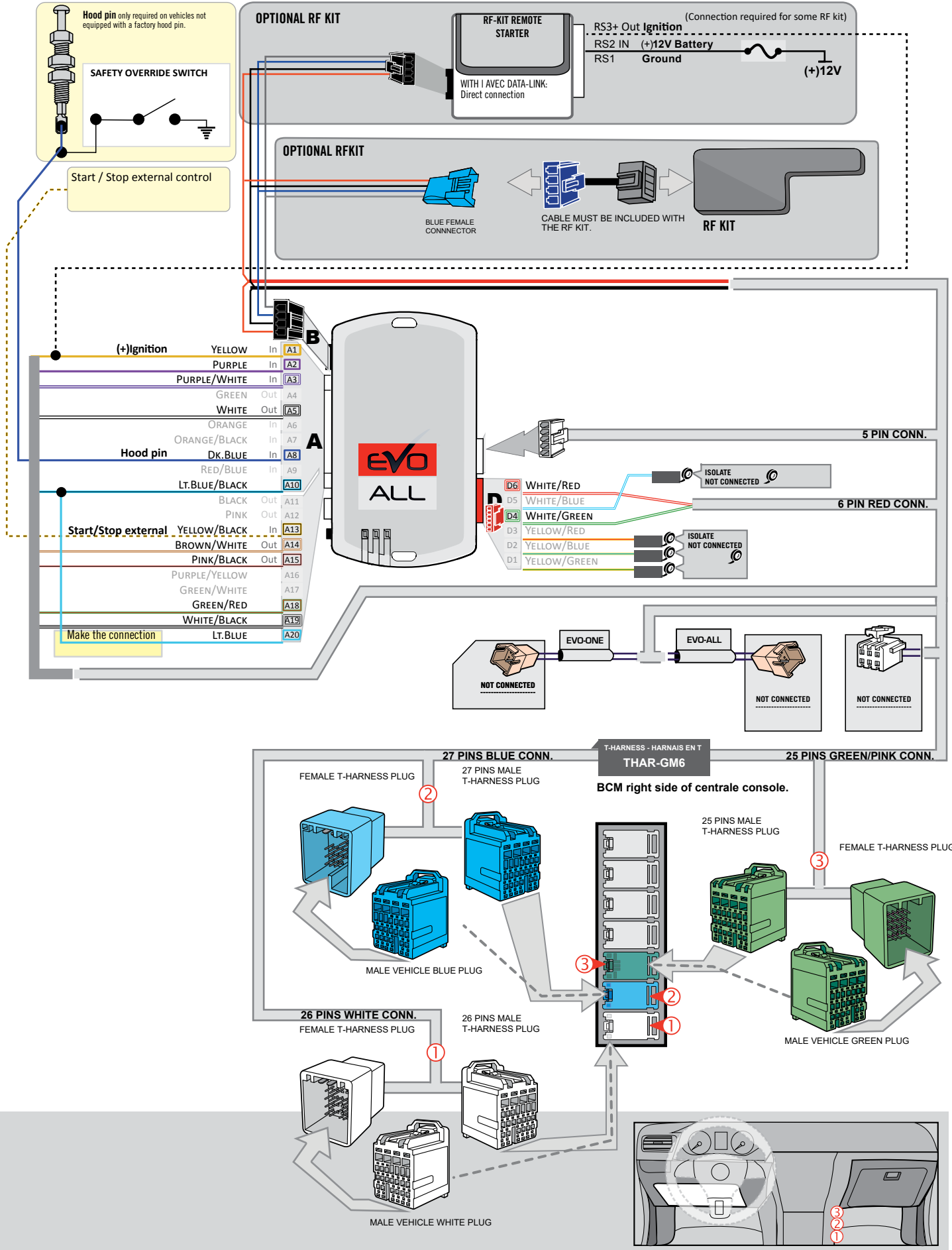

KEY BYPASS PROGRAMMING PROCEDURE 1/3

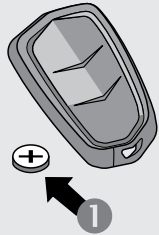

- 1** Remove the battery from the OEM remote.
- 2** Place the OEM remote into the transmitter pocket of the center console.
Refer to vehicle user guide for keyport location.

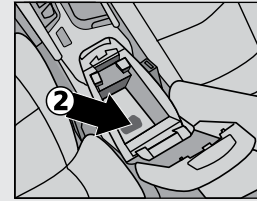

1

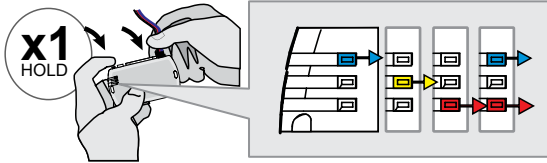

Press and hold the programming button:
Connect the 4-PIN Data-link harness (Black connector).

↳The Blue, Red, Yellow and Blue & Red LEDs will alternatively illuminate.

2

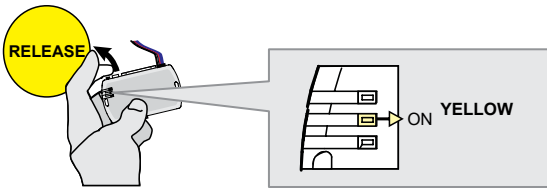

Release the programming button when the LED is YELLOW.

If the LED is not solid YELLOW disconnect the 4-Pin connector (Data-Link) and go back to step 1.

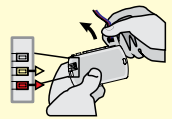

3

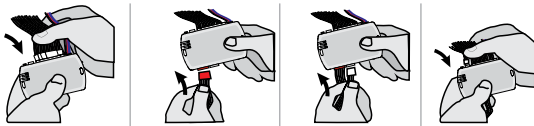

Insert the required remaining connectors.

4

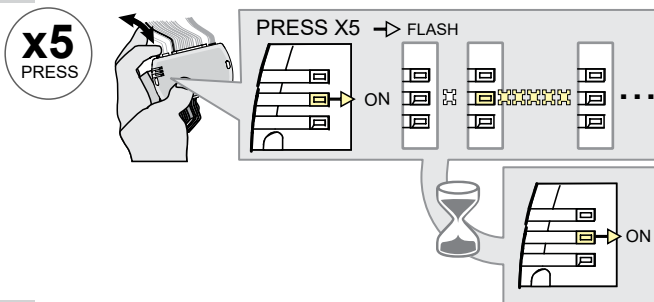

Press and release the programming button five (5x) times.

↳The YELLOW LED will flash 5 times each second.

↳**WAIT** for the YELLOW LED to turn ON solide.

5

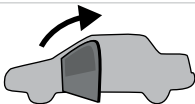

Open the driver door.

6

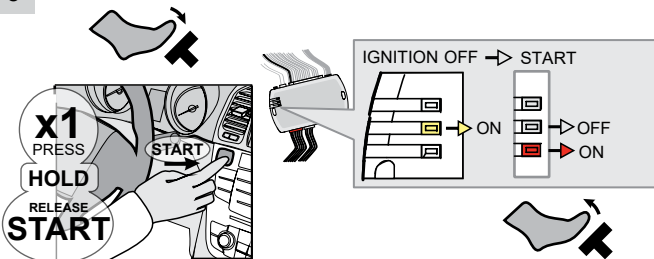

Press the foot-brake pedal.

Press the Push-to-Start button until the engine start.

Release the foot-brake pedal.

↳The RED LED will turn ON.
↳The YELLOW LED will turn OFF.

KEY BYPASS PROGRAMMING PROCEDURE 2/3

7



Press the Push-to-Start button until the engine turn OFF.

8

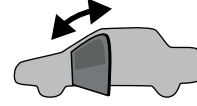

Close and open the driver door.

9

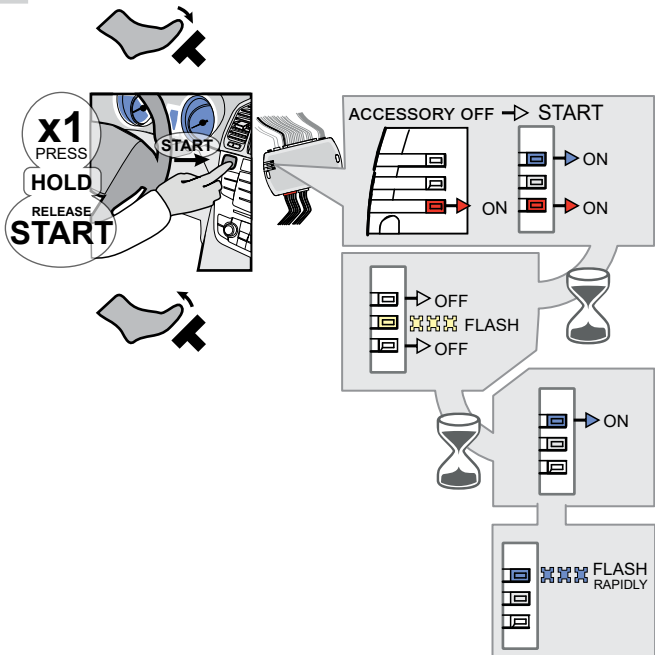

Press the foot-brake pedal.

Press the Push-to-Start button until the engine start.

Release the foot-brake pedal.

- ↳ The BLUE LED will turn ON.
- ↳ The BLUE LED will turn OFF. The RED LED will turn OFF.
- ↳ The YELLOW LED will flash rapidly
- ↳ The BLUE LED will turn ON.
- ↳ The BLUE LED will flash rapidly

10

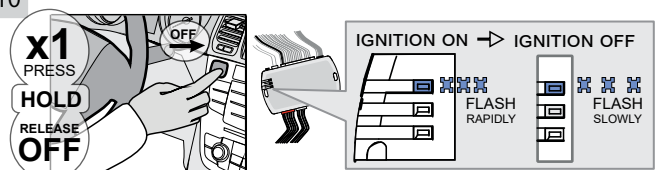

Press the Push-to-Start button until the engine turn OFF.

- ↳ The BLUE LED will flash slowly

11

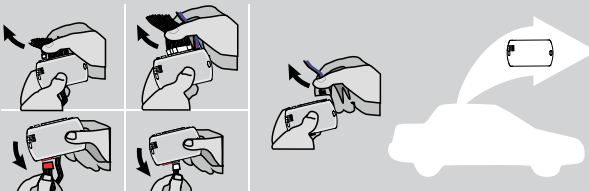

Disconnect all the connectors and after the Data-Link (4-pins) connector.

12

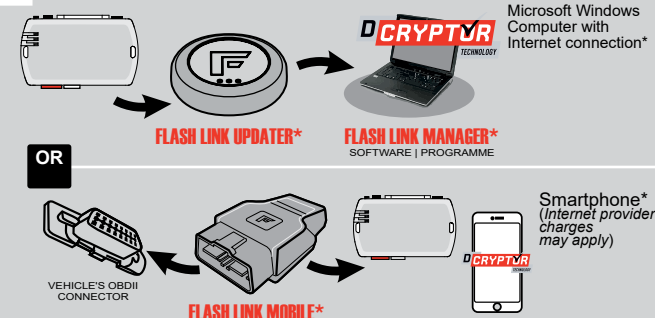

Microsoft Windows Computer with Internet connection*

FLASH LINK UPDATER* **FLASH LINK MANAGER***
SOFTWARE | PROGRAMME

OR

Smartphone* (Internet provider charges may apply)

FLASH LINK MOBILE*

Use the tool: FLASH LINK UPDATER or FLASH LINK MOBILE to visit the DCryptor menu.

*Parts required (not included)

KEY BYPASS PROGRAMMING PROCEDURE 3/3

13

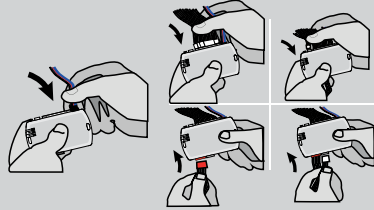
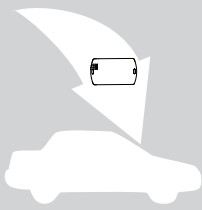

AFTER DCRYPTOR PROGRAMMING COMPLETED
Go back to the vehicle and **reconnect** the 4-Pin (Data-Link) connector and after, all the remaining connector.



The module is now programmed.



REMOTE STARTER / ALARM VERIFICATION PROCEDURE

Test the remote starter. Remote start the vehicle.

REMOTE STARTER FUNCTIONALITY



All doors must be closed.

Remote start the vehicle.

Toutes les



Press the Unlock button of the remote car starter.

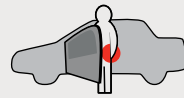

Enter the vehicle with the Intelligent Access Key.

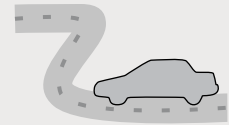

The vehicle can now be put in to gear and driven.



If the vehicle is not unlocked the module will shut down the remote-starter and the vehicle as soon as any door is opened.

THAR-GM6 THARNNESS INSTALLATION

ADDENDUM - SUGGESTED WIRING CONFIGURATION



Vehicle functions supported in this diagram (functional if equipped)

VEHICLE	YEARS	Immobilizer bypass	Lock	Unlock	Arm	Disarm	Trunk (open)	RAP Disable	Tachometer	Heated Seats	Door Status	Trunk Status	Hand-Brake Status	Foot-Brake Status	OEM Remote Monitoring
OPEL															
Astra K	Push-To-Start	2015-2018	•	•	•	•	•	•	•	•	•	•	•	•	•
Zafira C	Push-To-Start	2011-2018	•	•	•	•	•	•	•	•	•	•	•	•	•



BYPASS FIRMWARE VERSION

70.[38]

GM MINIMUM

To add the firmware version and the options, use the **FLASH LINK UPDATER** or **FLASH LINK MOBILE** tool, sold separately.

	Program bypass option:	UNIT OPTION	DESCRIPTION
		C1	OEM Remote status (Lock/Unlock) monitoring
		D6	Push-to-Start



ATTENTION!



DATE: XX-XX

E5

OFF

By default DEACTIVATED

ON

MANUFACTURED MODULES BETWEEN: 04/2018 TO 04/2019

	Program remote starter option for R.S. OEM REMOTE STAND ALONE:	FUNCTION	MODE	DESCRIPTION
		38	2	Enable Press 3x Lock to remote start with the OEM remote.



Parts required (Not included): 1X THAR-GM6

MANDATORY INSTALL

* HOOD PIN



HOOD STATUS: THE HOOD PIN SWITCH (INCLUDED) MUST BE INSTALLED IF THE VEHICLE CAN BE REMOTE STARTED WITH THE HOOD OPEN.

SECURITY STICKER



Included

Notice: the installation of safety elements are mandatory. The hood pin and the sticker are essential security elements and must be installed.

THIS MODULE MUST BE INSTALLED BY A QUALIFIED TECHNICIAN. A WRONG CONNECTION CAN CAUSE PERMANENT DAMAGE TO THE VEHICLE.

DESCRIPTION

BCM above driver kick panel.

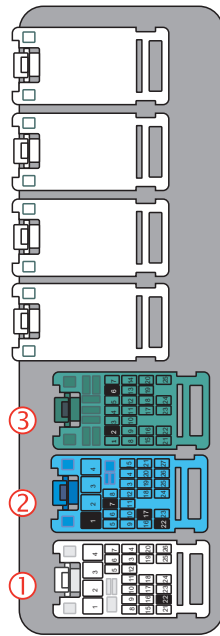
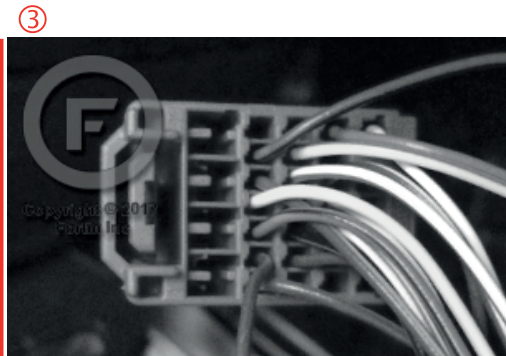

AUTOMATIC TRANSMISSION WIRING CONNECTION

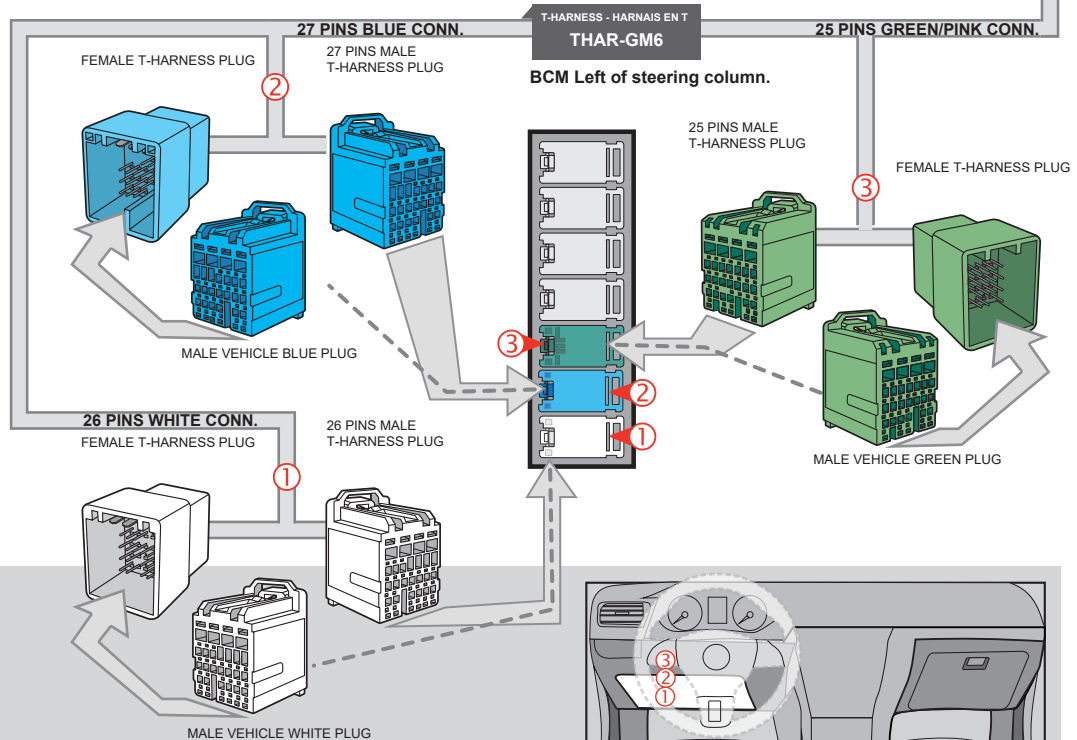
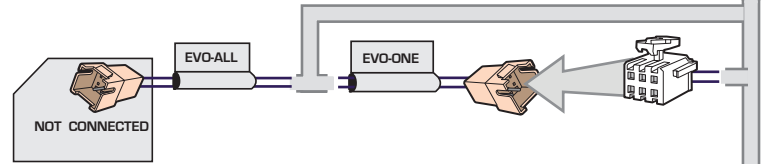
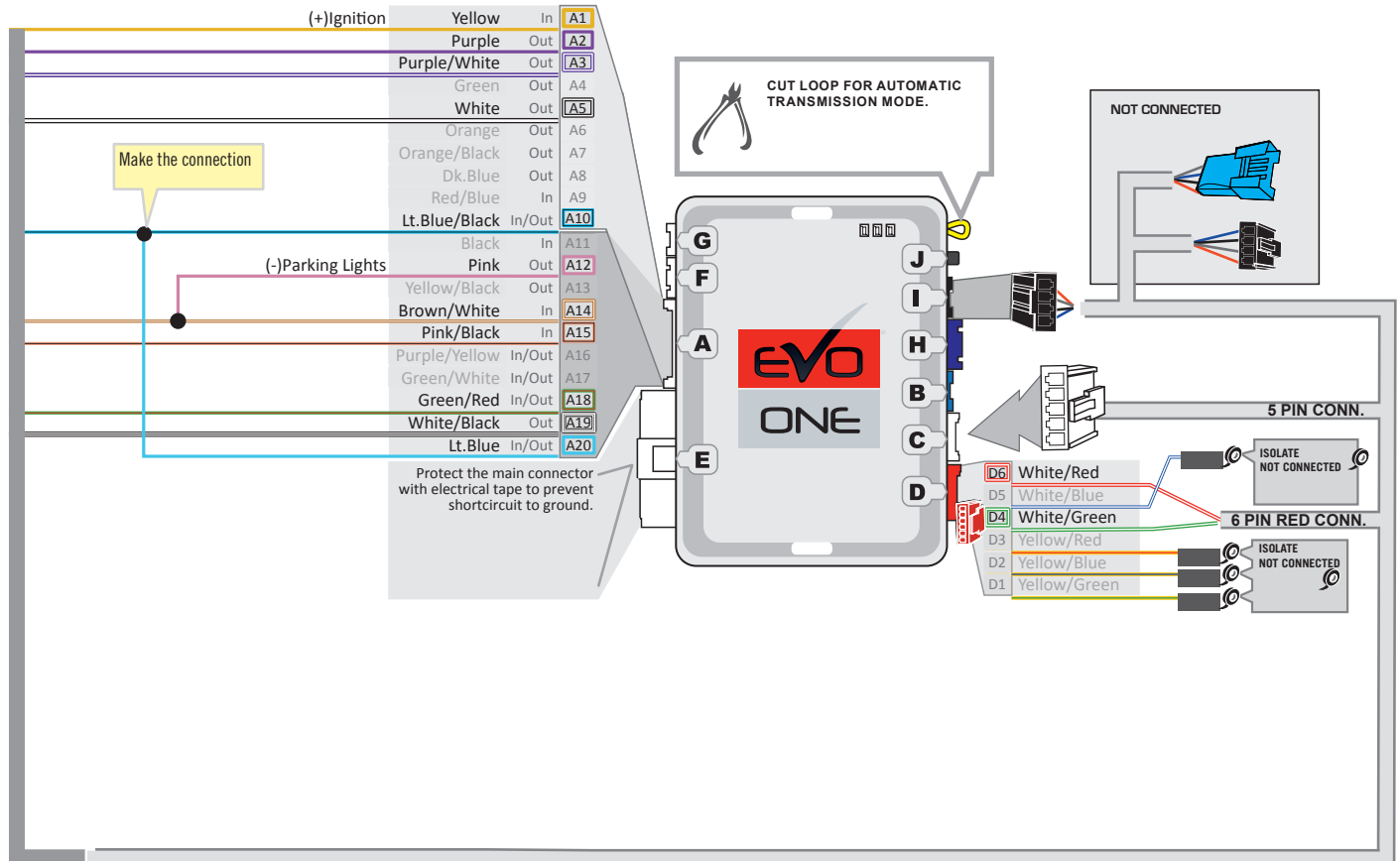

MANUAL TRANSMISSION WIRING CONNECTION

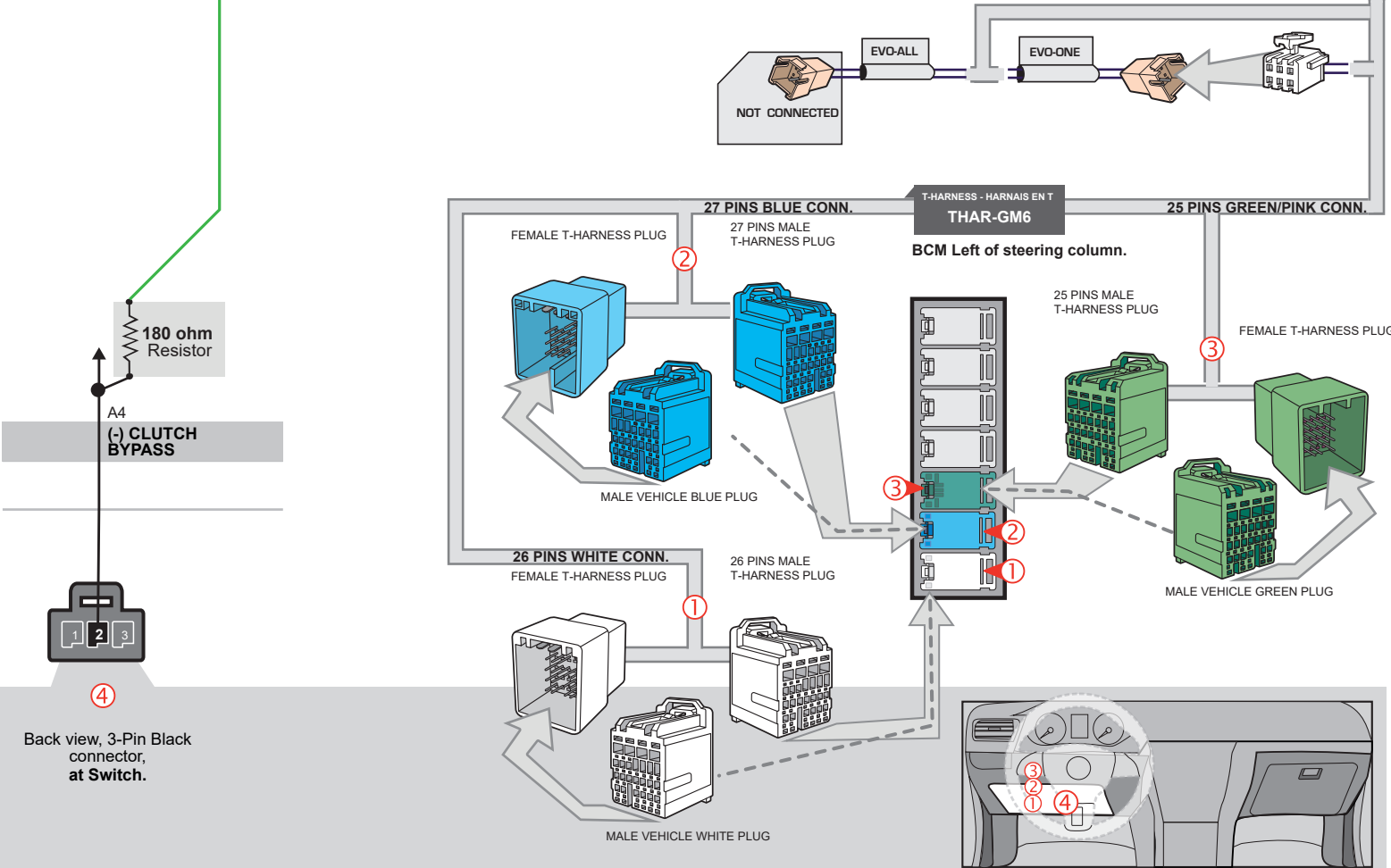
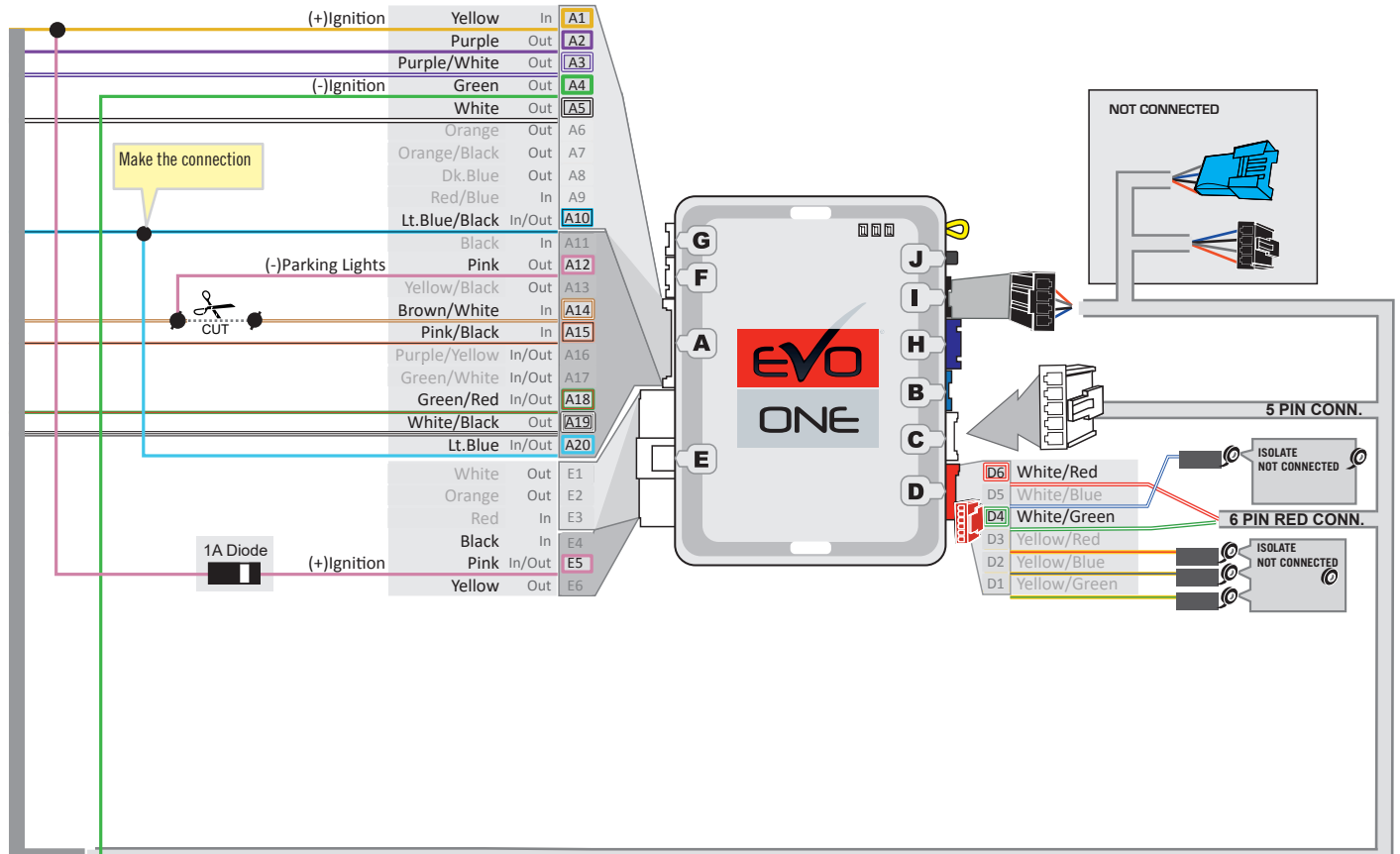

KEY BYPASS PROGRAMMING PROCEDURE 1/2

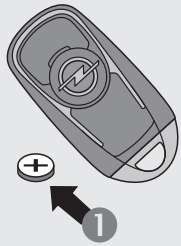

- 1** Remove the battery from the OEM remote.
- 2** Place the OEM remote in the front cup holder in the center console.
Refer to vehicle user guide for keyport location.

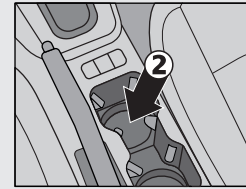

1

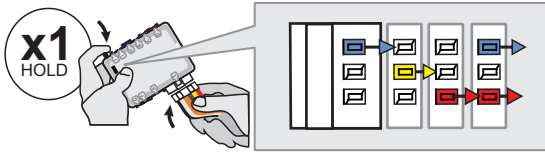

Press and hold the programming button:
Insert the 6-Pin Main connector.

↳The LEDs will alternate between BLUE, RED, YELLOW & BLUE/RED flashes.

2

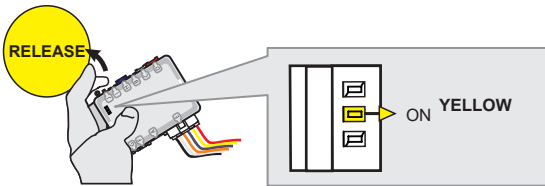

Release the programming button when the LED is YELLOW.

If the LED is not solid YELLOW **disconnect** the 6-Pin connector (Main-Harness) and go back to step 1.

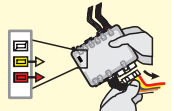

3

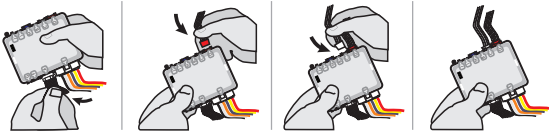

Insert the required remaining connectors.

4

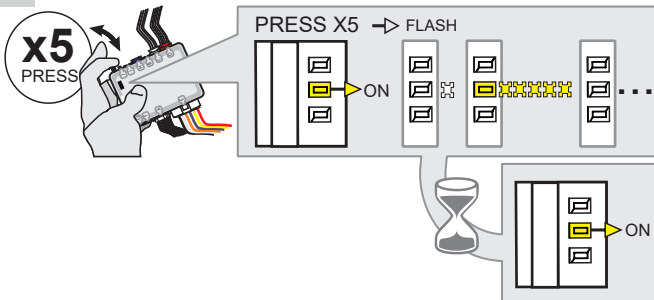

Press and release the programming button five (5x) times.

↳The YELLOW LED will flash 5 times each second.

↳**WAIT** for the YELLOW LED to turn ON solide.

5

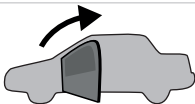

Open the driver door.

6

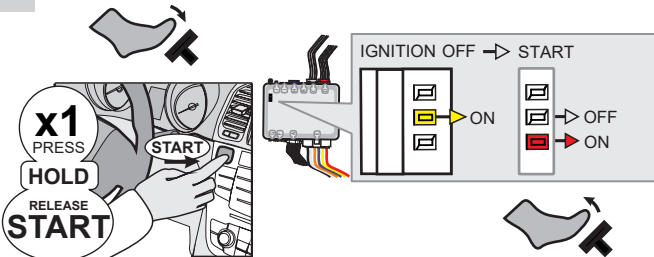

Press the foot-brake pedal.

Press the Push-to-Start button until the engine start.

Release the foot-brake pedal.

↳The RED LED will turn ON.
↳The YELLOW LED will turn OFF.

KEY BYPASS PROGRAMMING PROCEDURE 2/2 |

7



Press the Push-to-Start button until the engine turn OFF.

8

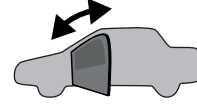

Close and open the driver door.

9

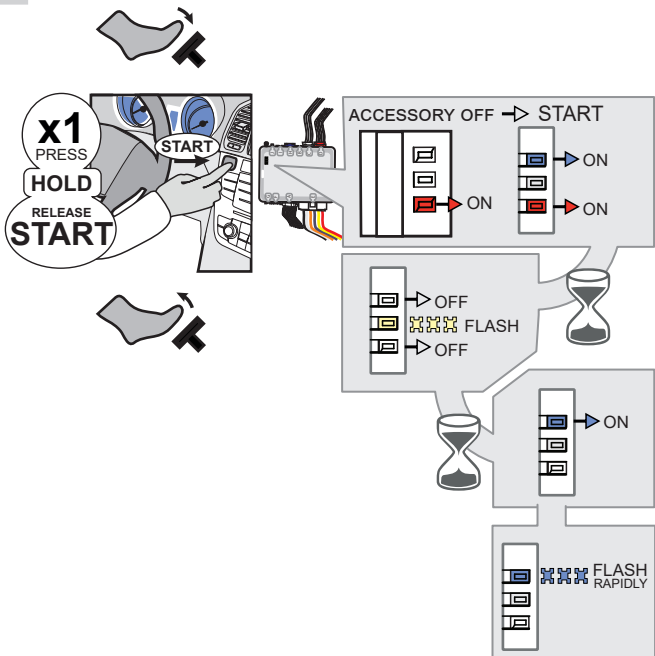

Press the foot-brake pedal.

Press the Push-to-Start button until the engine start.

Release the foot-brake pedal.

- ↳ The BLUE LED will turn ON.
- ↳ The BLUE LED will turn OFF. The RED LED will turn OFF.
- ↳ The YELLOW LED will flash rapidly
- ↳ The BLUE LED will turn ON.
- ↳ The BLUE LED will flash rapidly

10

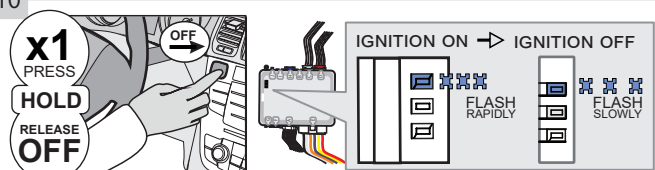

Press the Push-to-Start button until the engine turn OFF.

- ↳ The BLUE LED will flash slowly

11



Disconnect all connectors and after the 6-Pin (Main-Harness) or the 4-Pin Data-link connector.

12

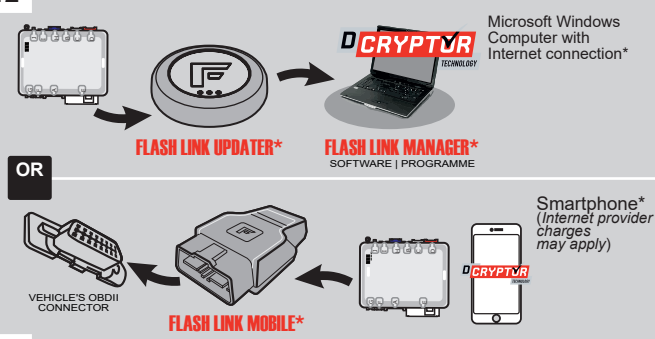

Microsoft Windows Computer with Internet connection*

OR

Smartphone* (Internet provider charges may apply)

Use the tool: **FLASH LINK UPDATER** or **FLASH LINK MOBILE** to visit the DCryptor menu.

*Parts required (not included)

KEY BYPASS PROGRAMMING PROCEDURE 3/3 |

13

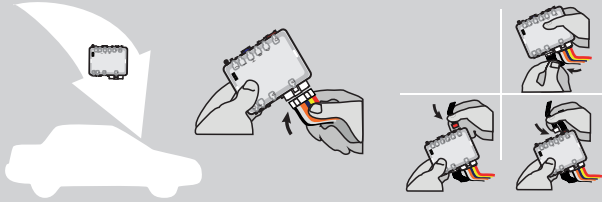

AFTER DCRYPTOR PROGRAMMING COMPLETED
Go back to the vehicle and **reconnect** the 6-Pin (Main-Harness) or the 4-pins (Data-Link) connector and after all the remaining connector.



The module is now programmed.



REMOTE STARTER / ALARM VERIFICATION PROCEDURE

Test the remote starter. Remote start the vehicle.

REMOTE STARTER PROGRAMMING PROCEDURE |



REFER TO THE **QUICK INSTALL GUIDE** INCLUDED WITH THE MODULE FOR THE REMOTE STARTER PROGRAMMING.

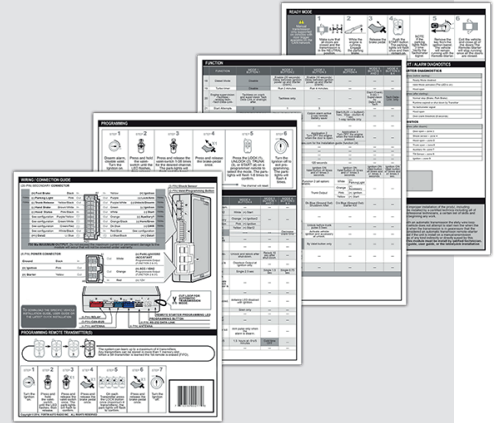

REMOTE STARTER FUNCTIONALITY |



All doors must be closed.

Toutes les

Remote start the vehicle.



Press the Unlock button of the remote car starter.



Enter the vehicle with the Intelligent Access Key.



The vehicle can now be put in to gear and driven.



If the vehicle is not unlocked the module will shut down the remote-starter and the vehicle as soon as any door is opened.