

**GMC Sierra/Chev Silverado 1500 2014-18 Crew Cab**  
**GMC Sierra/Chev Silverado HD(2500-3500) 2015-up Crew Cab**

**TV 5D14CC**

**INSTALLATION ASSISTANCE**

If any installation hardware is missing or lost, or you have any problems or questions during the installation of your new product, please contact the manufacturer for assistance. Do not contact your retailer.

**WARRANTY REGISTRATION**

After completing the installation of your new product, please contact the manufacturer to register your warranty. This validates your warranty in the event you have any future concerns with your product.

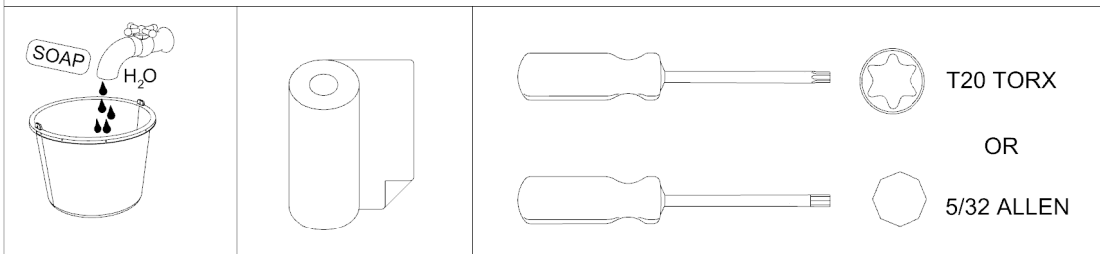
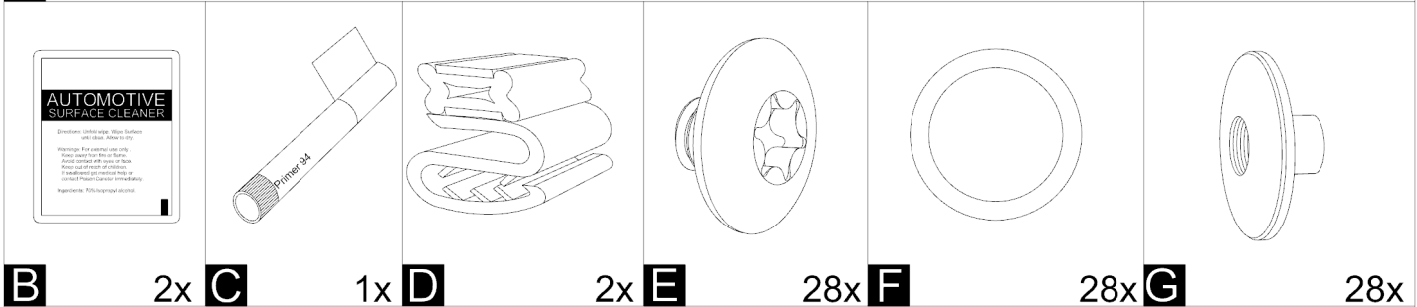
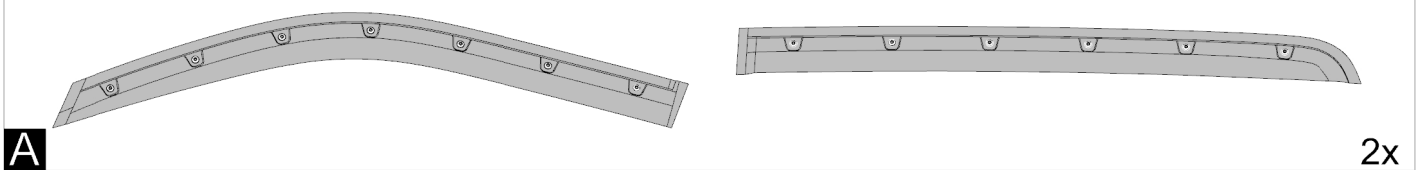

1 X 28

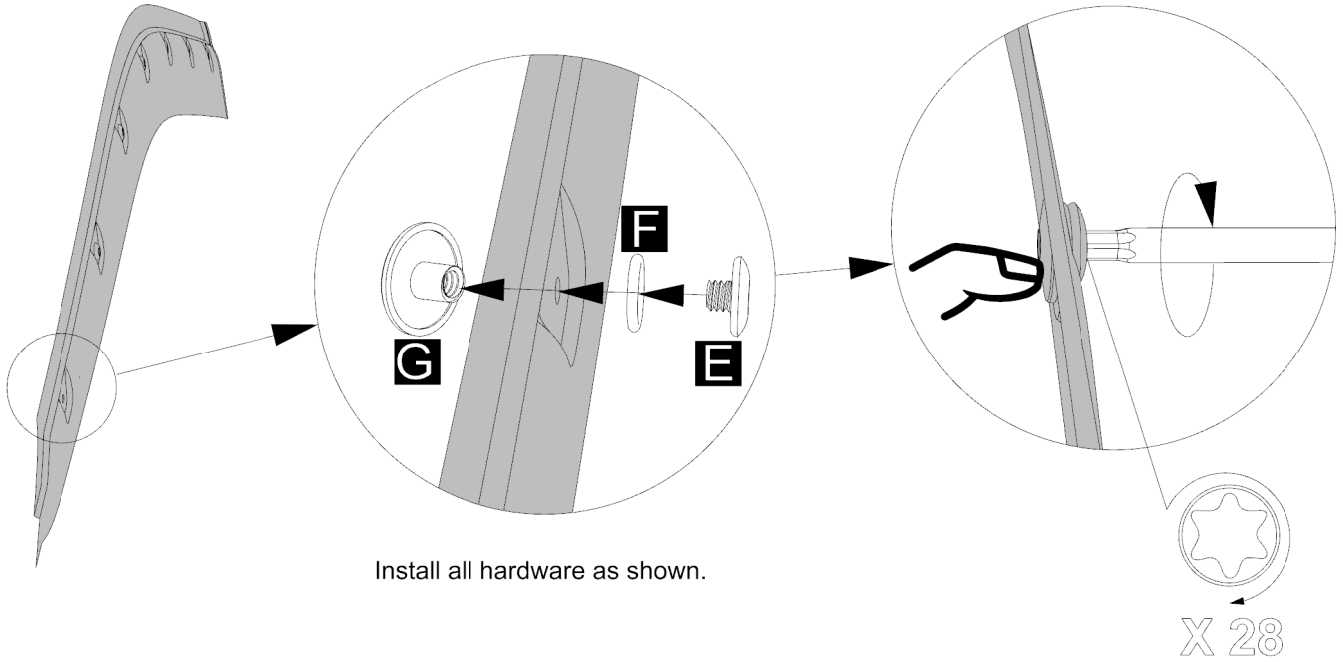

110 °F 40 °C  
70 °F 21 °C

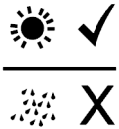

2

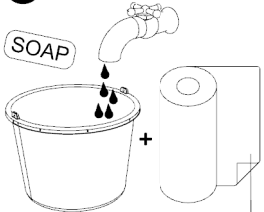

3

B



4

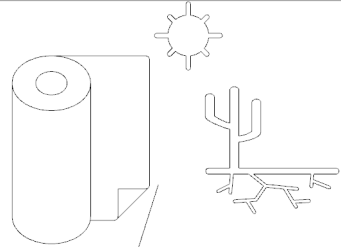

Top of the door frame

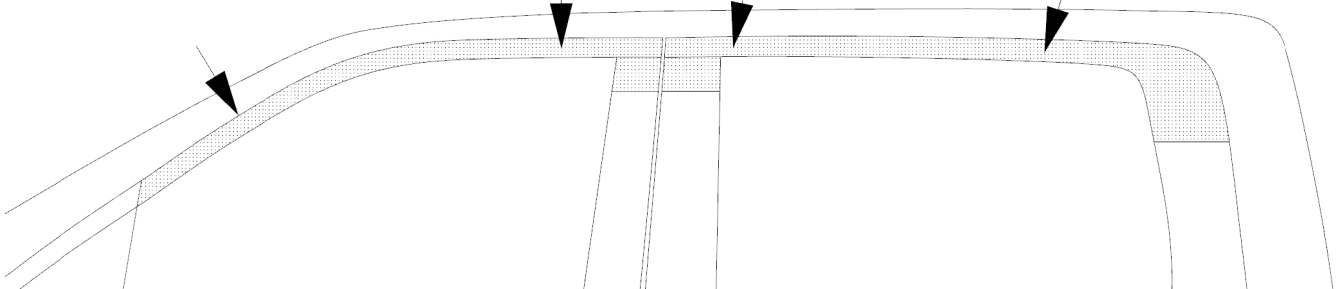

Clean and dry mounting areas- both sides of the truck

- 5** Prime edge of mirror base and black vinyl door trim only!  
Prime both sides of the truck!

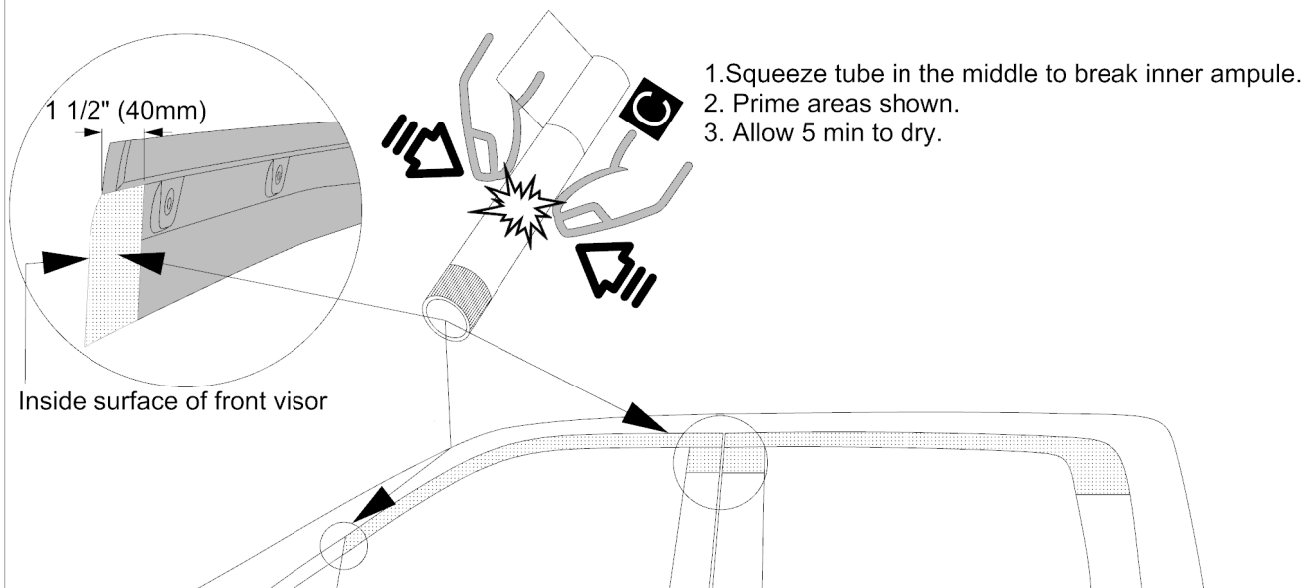

- 6** Install the rear visor, start at the front of the door as shown. Working from the front of the visor remove the red backing while pressing the visor in place in alignment with the top of the door frame.

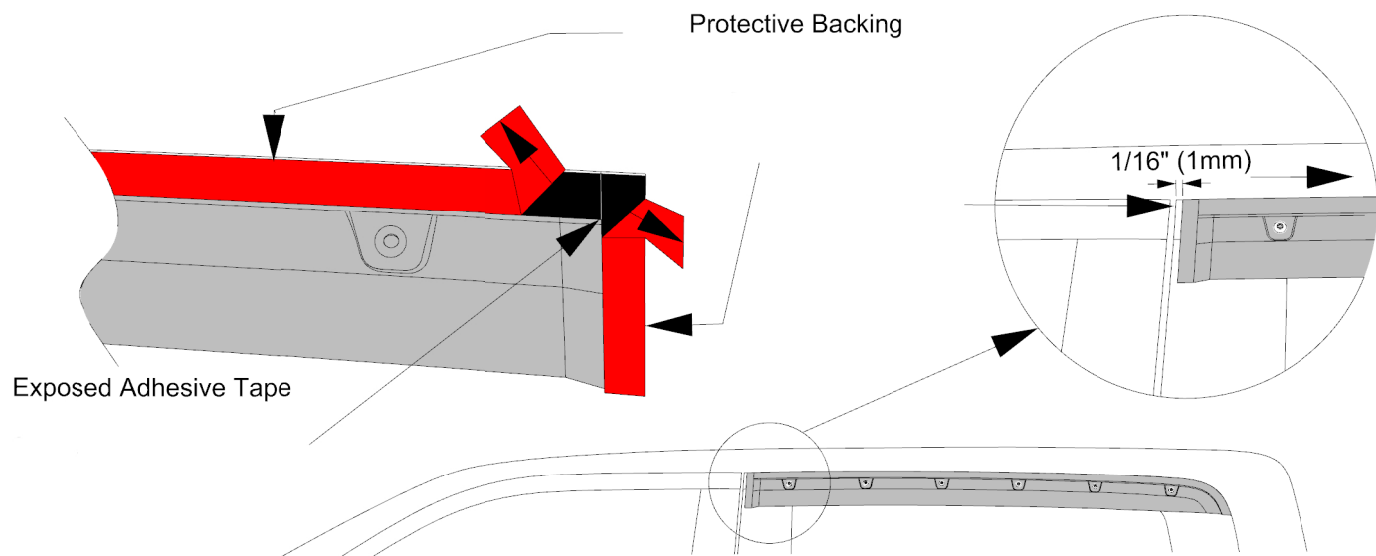

**7** Install the front visor, start at the front of the door as shown. Working from the front of the visor remove the red backing while pressing the visor in place in alignment with the top of the door frame.

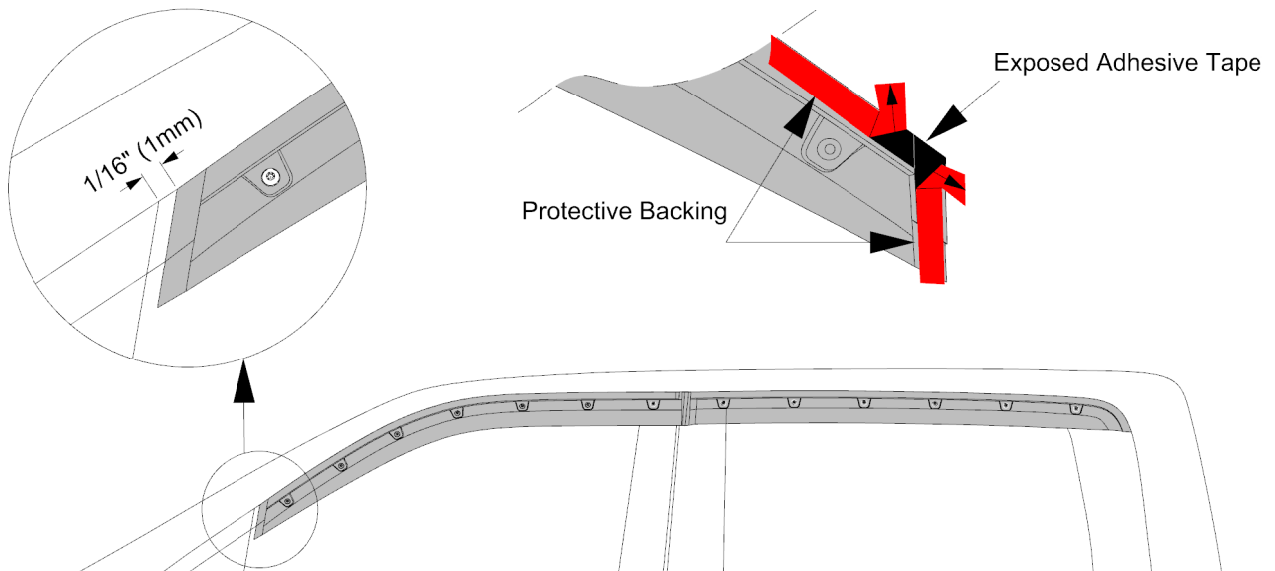

**8**  
Attach clip to the vertical portion of the front door at the "B" pillar location.

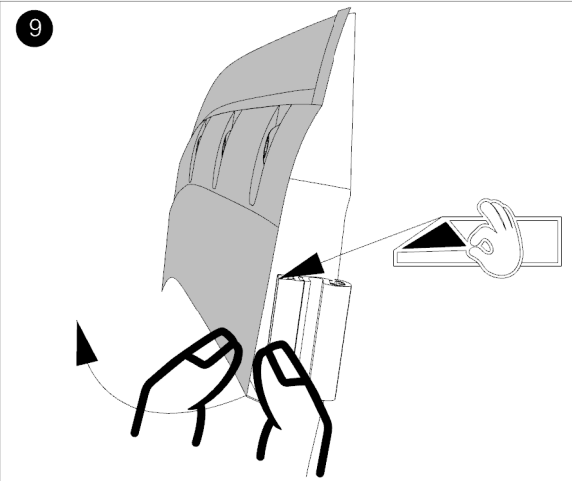
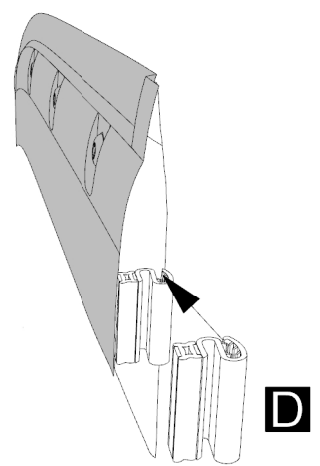

**10**  
Press firmly along the entire flange and where the clip contacts the front visor.

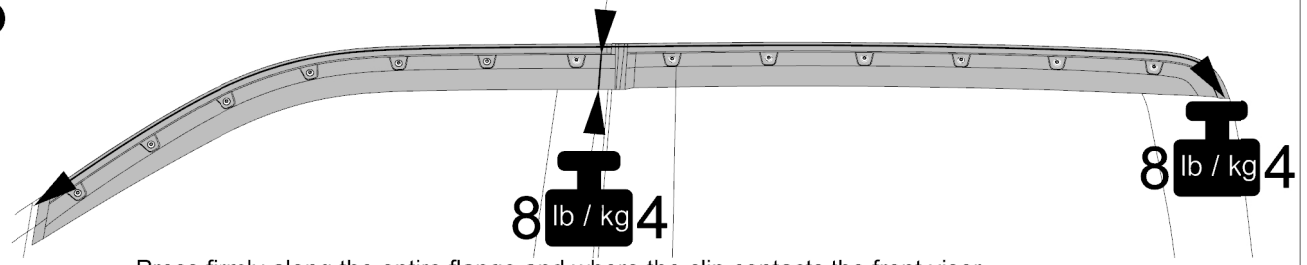

**11** Repeat steps 6-10 for the passenger side.