



Hood Protector

Installation Instructions

TG 8A09

Ford F150 2019- 14

PARTS LIST

Hood protector



Adhesive pedestals (7)



Torx head screws (7)



Nylon shoulder washers (7)



Metal mounting brackets (2)



Abrasion pads (large) (2)

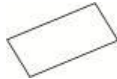

Bumpons (5)



3M Adhesive Promoter (1)

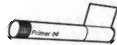

Surface cleaner (2)



Re-usable tape strips (1)

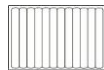

Pedestal locating template (1)



TOOLS AND SUPPLIES REQUIRED

- T45 Torx bit or 7/32" Allen key
- #2 Phillips head screwdriver
- Measuring tape
- Masking Tape
- Clean cloth or soft paper towel
- Felt pen or grease pencil
- Hair dryer or heat gun

INSTALLATION

Ensure the vehicle is clean and completely dry before installation.

This product uses a 3M adhesive that requires installation and curing temperatures of 15° to 43°C (60° to 110°F) for 1 hr to develop maximum adhesion to the hood surface. Failure to install this product at the proper temperature or allow adequate curing time before use is not covered under warranty.



CARE

Hand clean the protector using a mild soap and water solution or plastic cleaner only.

Avoid automatic car-wash equipment where a brush and/or soft cloth may come in contact with the hood protector. Touch-less style automatic car-wash equipment is less likely to harm the hood protector.

SERVICE

Periodically check to confirm the protector is securely attached to the hood.

WARNINGS

Do not pull/push on the protector when opening/ closing the hood.

NOTE

On some vehicles it may be necessary to adjust the hood bumpers and/or latch for proper clearance.

NOTES

- In place of the T45 Torx bit, a 7/32" size Allen key will work.
- Do not use a power drill to turn in either the Torx head screws or the Phillips head screws.
- Use caution to not over-torque any of the screws.

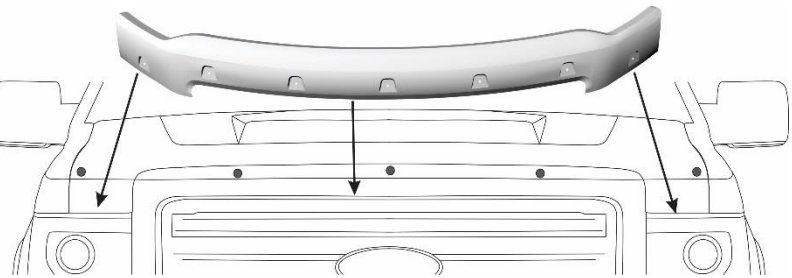
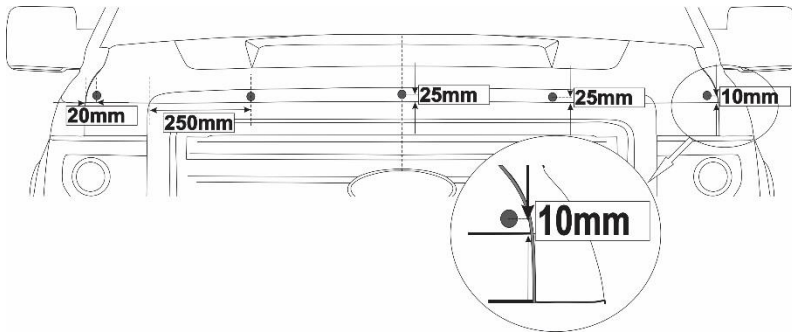
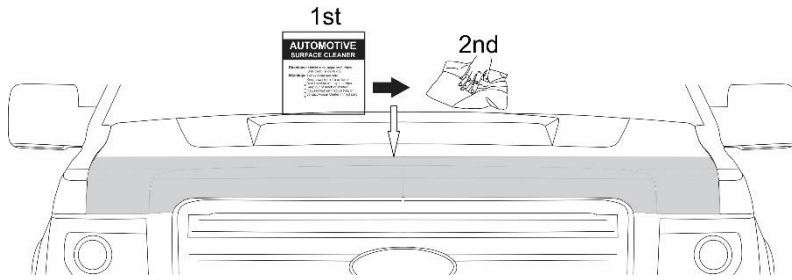

1. Use one of the surface wipes provided and wipe down the area (approximately 15cm (6 in.) from the hood edge) where the hood protector will be installed. Wipe dry with a soft cloth or paper towel. This will remove any wax or grease and will ensure a cleaner surface for the adhesive to bond to.

2. Place bumpons in locations shown in the illustrations. Note that bumpons must be placed on the hood, not the hood protector. If they are placed on the hood protector, they will wear through the paint on your hood!

Metric conversion:	
10mm = 3/8"	250mm = 9 3/4"
20mm = 3/4"	
25mm = 1"	

3. Place the hood protector on the bumpons and center the protector on the hood.

4. Keeping hood protector in position, locate the two pockets as illustrated. Directly in front of these, at the hood edge, place a small abrasion pad on the underside of the hood. The abrasion pad is oriented with the long edge aligned with the edge of the hood and centered in front of the pocket.

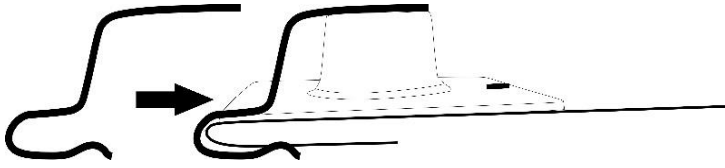

5. Remove the hood protector.

6. Temporarily place a mounting pedestal at the edge of the hood where the abrasion pad was placed in step 4 and slide a bracket over each, as illustrated.

7. Assemble a Torx head screw and shoulder washer as illustrated and thread a screw through the hood protector and into both of the mounting pedestals which were temporarily attached in step 8. Note the pedestals are not permanently fastened so the screw will only turn in part way.

8. Center the hood protector on the hood by sliding the mounting pedestals/brackets left or right as required. Take care to ensure the brackets and mounting pedestals stay square to the hood edge.

9. Once hood protector is centered, take a felt marker (a fine point Sharpie works best) and insert it into the hole in each of the remaining "pockets" of the hood protector. Keeping the marker perpendicular to the hood surface, mark the hood surface with a dot. *****NOTE- IF YOUR HOOD HAS PAINT PROTECTION FILM, A PERMANENT MARKER MAY STAIN THE FILM. USE A DRY-ERASE MARKER OR A GREASE PENCIL.*****

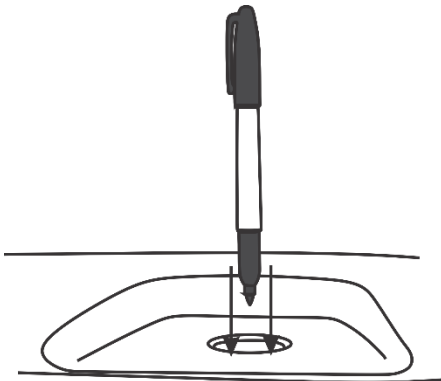
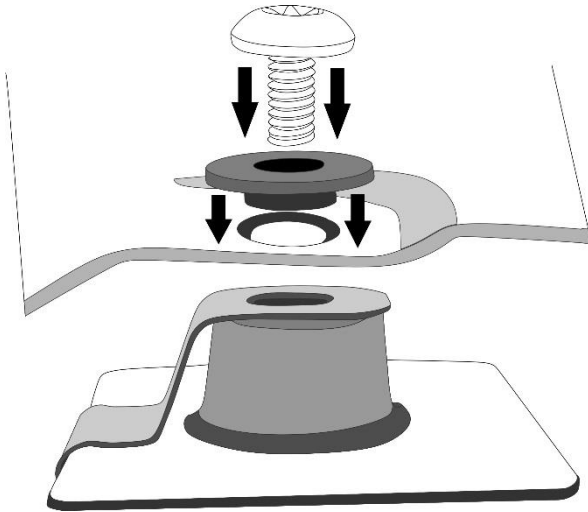

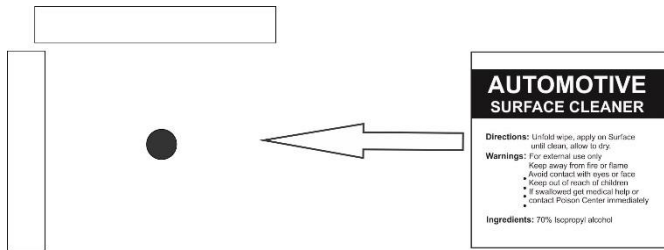
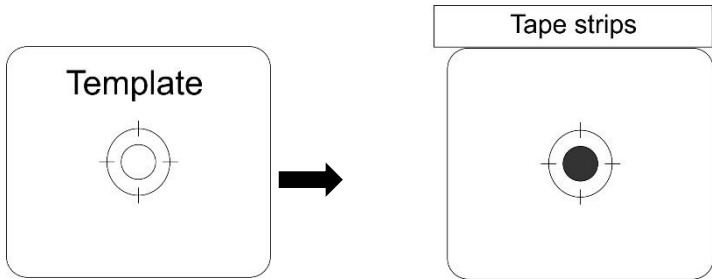

3M Primer 94 Instructions
 -Squeeze tube in middle to break inner ampule
 -Apply to clean, dry surface
 -Allow at least 5 minutes to dry before taping

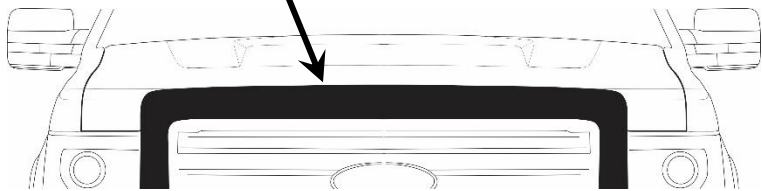
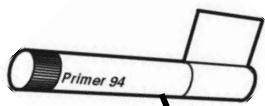

10. Remove the Torx head screws from the mounting pedestals. Remove the hood protector. *****Do not remove the temporarily installed pedestals.**



11. Locate the pedestal positioning template and place the template over a dot on the hood. Ensure the template is square to the hood edge. Using two of the repositionable tape strips, outline the template on two adjacent sides. Repeat for all dots. Depending on the application, it may be necessary to cut the tape strips in half to ensure there are enough to outline all locations. *****Outline the temporarily installed pedestals as well, then remove them.**

12. Using the automotive surface cleaner provided, clean an area approximately the size of the mounting pedestal at each location. Wipe dry with a clean cloth or paper towel. Take care to not contaminate the hood surface after it has been cleaned. Any surface contaminants will reduce the effectiveness of the adhesive.



NOTE: If your vehicle is equipped with a black unpainted grill, the use of Primer 94 at each pedestal location is REQUIRED in order for the adhesive to bond to the plastic. Skip this step if grill is chrome or painted.

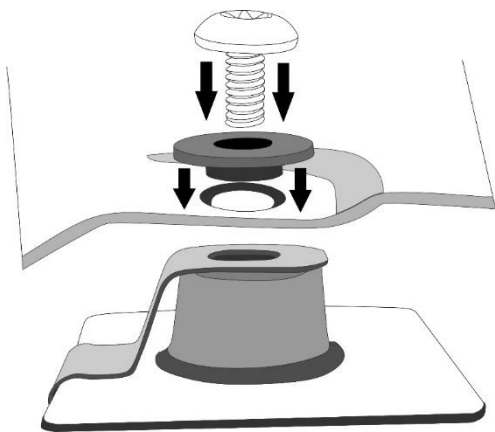
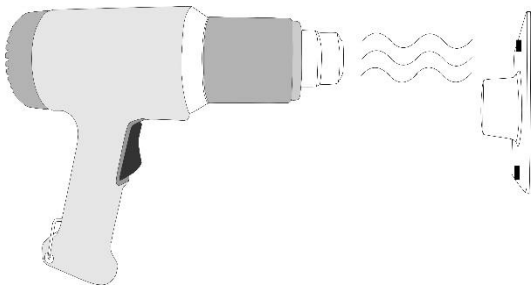
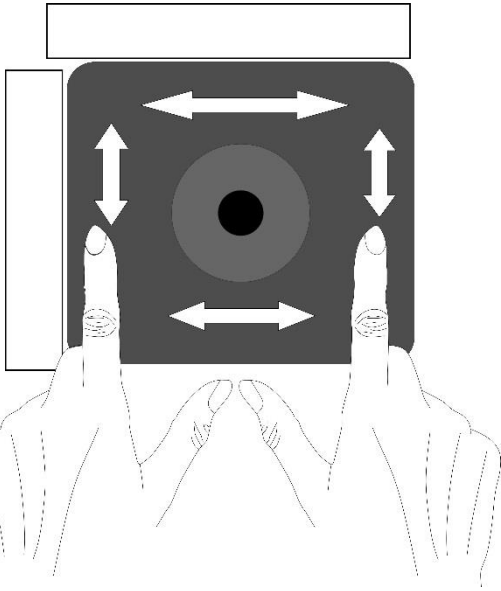
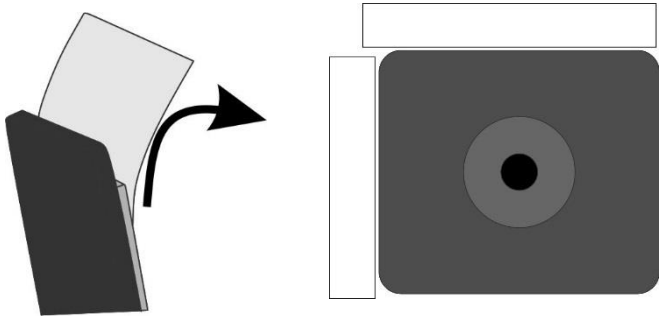

13. Peel the red protective backing off one of the adhesive pedestals. Carefully place it on the hood surface exactly where the tape outline is. **Use care with this step as once the pedestal has been placed on the hood, it will be very difficult to remove.** Repeat for all locations.

14. "Wet out" pedestal bases to ensure the adhesive is thoroughly bonded to the hood.

****NOTE** While the bond between pedestal and hood is very good, using a heat gun to warm the pedestal bases to 40°C (105°F) and wetting them out a second time will ensure the best bond possible.**



Use caution not to overheat the pedestal or damage the paint!!

15. Replace the metal brackets on the two outer pedestal positions and place the hood protector on the bumpers and pedestals.

16. Place a Torx head screw through a shoulder washer and into a hole in hood protector. Ensure the shoulder portion of the washer slides into the hole in the hood protector. Loosely thread the screw into the mounting pedestal. See illustration for orientation of the shoulder washer. Repeat for all locations.

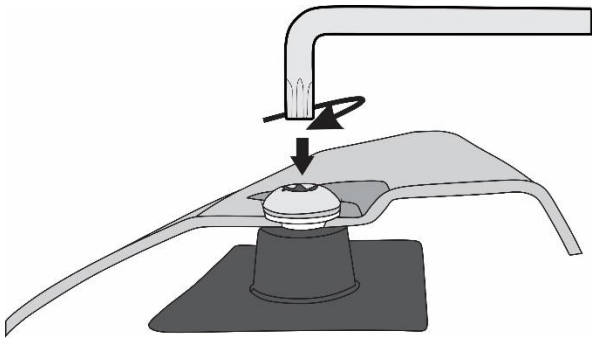

17. Ensure the hood protector is centered on the hood and using a T45 Torx key, tighten the screws into the pedestals. Start in the center position and work outwards. Ensure the shoulder washers are seated properly. Do not overtighten.