



# Hood Protector

# Installation Instructions

# TG 7W07 Jeep Wrangler 2007 -

### PARTS LIST

- Hood protector
- Adhesive pedestals (7)
- Torx head screws (7)
- Nylon shoulder washers (7)
- Pins (3)
- Screws (3)
- Clip bodies (3)
- "L" brackets (3)
- Abrasion pads (3)
- Bumpers (4)
- Surface cleaner (2)
- Re-usable tape strips (1)
- 2.5mm ABS flat washer (2)
- Pedestal locating template

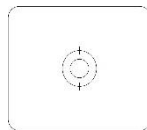
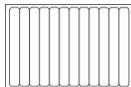
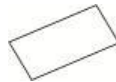

### INSTALLATION

Ensure the vehicle is clean and completely dry before installation. This product uses a 3M adhesive that requires installation and curing temperatures of 15° to 43°C (60° to 110°F) for 1 hr to develop maximum adhesion to the hood surface. Failure to install this product at the proper temperature or allow adequate curing time before use is not covered under warranty.

### CARE

Hand clean the protector using a mild soap and water solution or plastic cleaner only. Avoid automatic car-wash equipment where a brush and/or soft cloth may come in contact with the hood protector. Touch-less style automatic car-wash equipment is less likely to harm the hood protector.

### SERVICE

Periodically check to confirm the protector is securely attached to the hood.

### WARNINGS

Do not pull/push on the protector when opening/ closing the hood.

### NOTE

On some vehicles it may be necessary to adjust the hood bumpers and/or latch for proper clearance.

### NOTES

- In place of the T45 Torx bit, a 7/32" size Allen key will work.
- Do not use a power drill to turn in either the Torx head screws or the Phillips head screws.
- Use caution to not over-torque any of the screws.

### TOOLS AND SUPPLIES REQUIRED

- T45 Torx bit or 7/32" Allen key
- #2 Phillips head screwdriver
- Measuring tape
- Masking Tape
- Clean cloth or soft paper towel
- Felt pen or grease pencil
- Hair dryer or heat gun

**AUTOMOTIVE  
SURFACE CLEANER**

**Directions:** In full view, apply on Surface  
and clean, allow to dry.

**Warnings:** For external use only.  
Keep away from eyes or face.  
Avoid contact with eyes or face.  
Keep out of reach of children.  
If swallowed get medical help or  
contact Poison Center immediately.

**Ingredients:** 70% Isopropyl alcohol

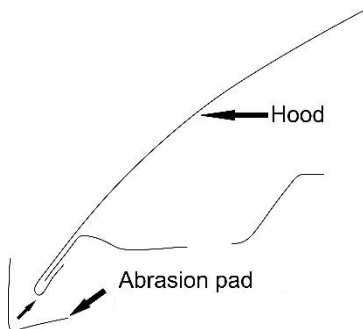
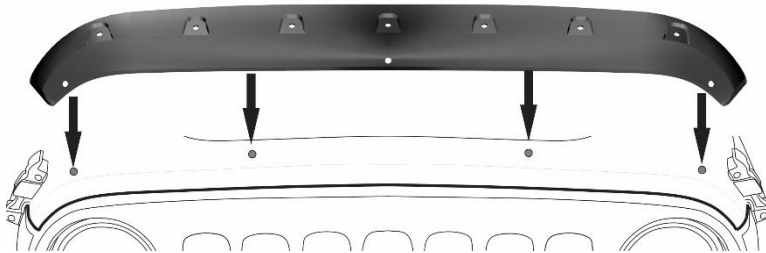
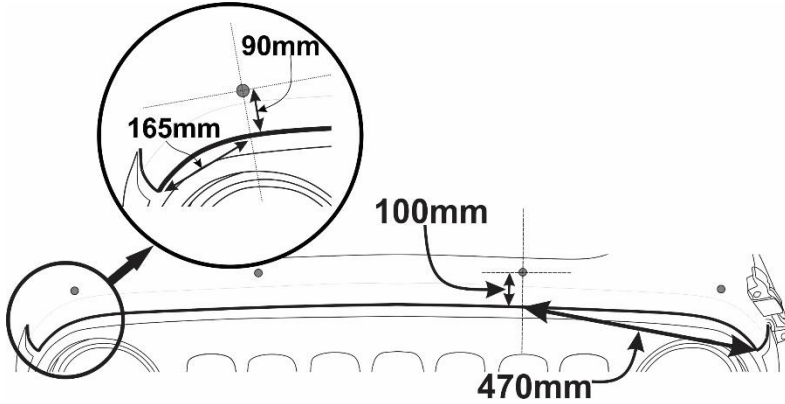
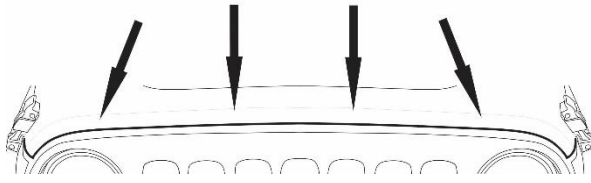
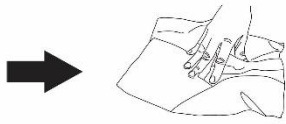

1. Use one of the surface wipes provided and wipe down the area (approximately 15cm from the hood edge) where the hood protector will be installed. Wipe dry with a soft cloth or paper towel. This will remove any wax or grease and will ensure a cleaner surface for the adhesive to bond to.
2. Place bump-ons in locations shown in the illustration. Note that bump-ons must be placed on the hood, not the hood protector. If they are placed on the hood protector, they will wear through the paint on your hood!

Metric conversion:

165mm = 6 1/2"

100mm = 4"

90mm = 3 1/2"

470mm = 18 1/2"

3. Place the hood protector on the bump-ons and center the protector on the hood.
4. Locate the small holes on the front edge of the protector and wrap an abrasion pad around the hood edge at these locations. On some applications it may be easier to stick the abrasion pad to the underside of the hood at the appropriate locations and then pick up the hood protector to wrap the abrasion pad around to the top surface of the hood.

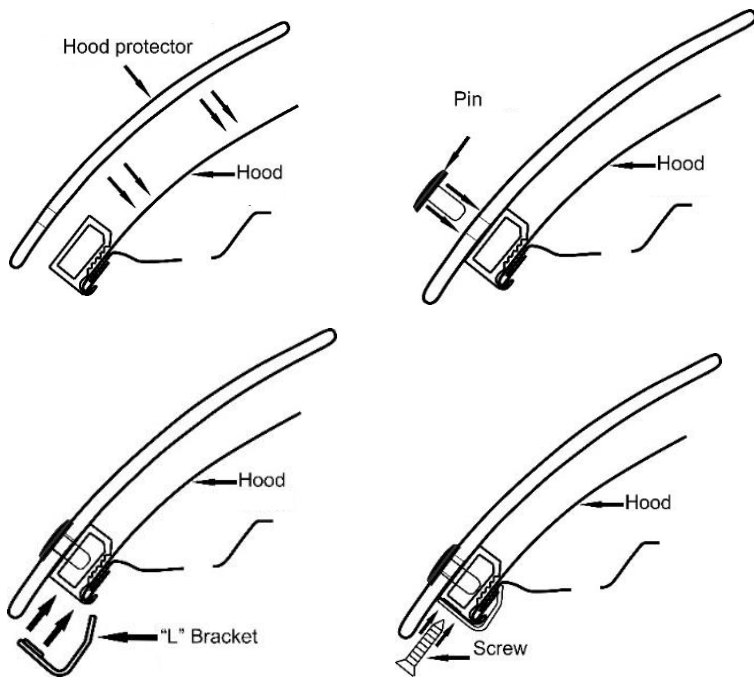

5. With the hood protector in place, assemble the four pieces of the hood edge clip (see illustrations) and loosely attach it to the edge of the hood. Ensure the hood protector is centered and tighten the screws into the clips.

6. Take a felt marker (a fine point Sharpie works best) and insert it into the hole in each of the "pockets" of the hood protector. Keeping the marker perpendicular to the hood surface, mark the hood surface with a dot. **\*\*\*NOTE- IF YOUR HOOD HAS PAINT PROTECTION FILM, A PERMANENT MARKER MAY STAIN THE FILM. USE A DRY-ERASE MARKER OR A GREASE PENCIL.\*\*\***



7. Loosen the screws holding the hood edge clips and remove the hood protector. Do not remove the hood edge clips from the hood protector.

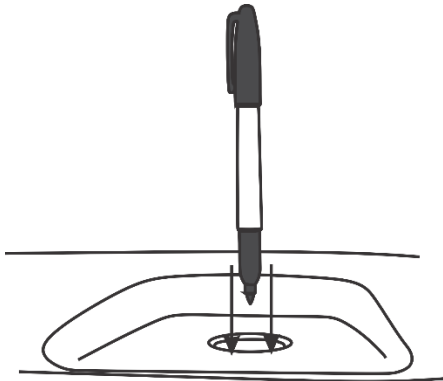

8. Locate the pedestal positioning template and place the template over a dot on the hood. Ensure the template is square to the hood edge. Using two of the repositionable tape strips, outline the template on two adjacent sides. Repeat for all dots. Depending on the application, it may be necessary to cut the tape strips in half to ensure there are enough to outline all locations.

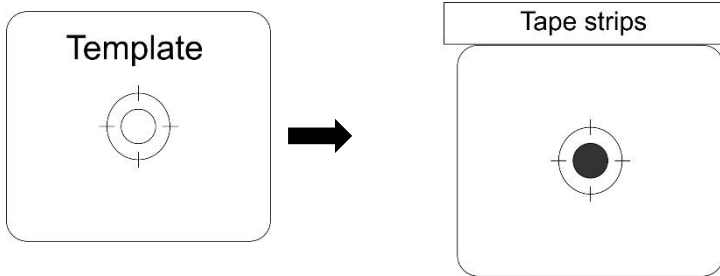

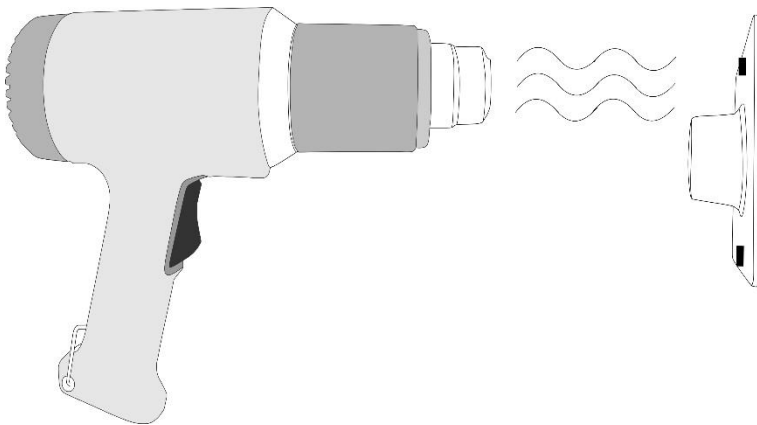
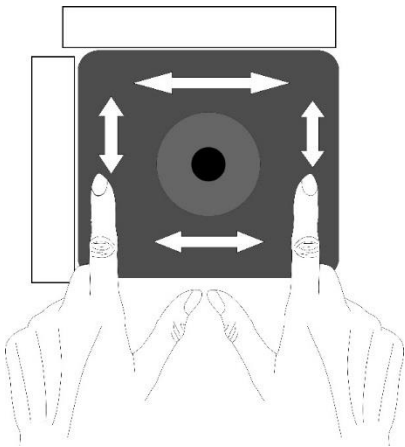
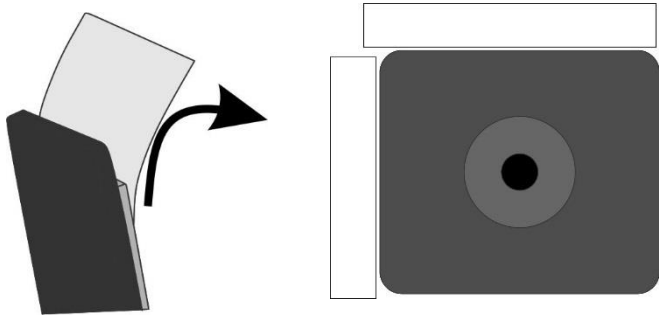
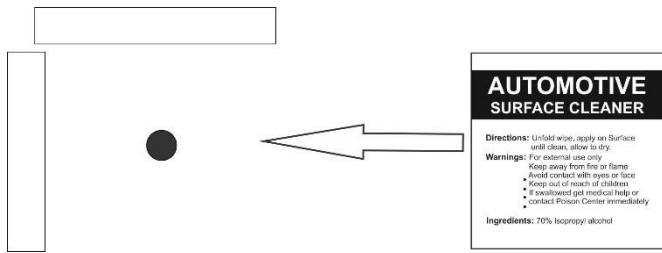

9. Using the automotive surface cleaner provided, clean an area approximately the size of the mounting pedestal at each location. Wipe dry with a clean cloth or paper towel. Take care to not contaminate the hood surface after it has been cleaned. Any surface contaminants will reduce the effectiveness of the adhesive.

10. Peel the red protective backing off one of the adhesive pedestals. Carefully place it on the hood surface exactly where the tape outline is. **Use care with this step as once the pedestal has been placed on the hood, it will be very difficult to remove.** Repeat for all locations.

11. "Wet out" pedestal bases to ensure the adhesive is thoroughly bonded to the hood.

**\*\*NOTE\*\* While the bond between pedestal and hood is very good, using a heat gun to warm the pedestal bases to 40° (105°) and wetting them out a second time will ensure the best bond possible.**

 Use caution not to overheat the pedestal or damage the paint!!

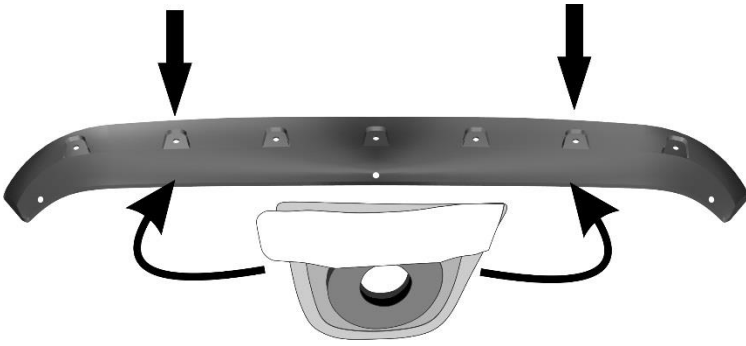

12. **\*\*\*For vehicles equipped with the “power dome” hood only\*\*\*** Use a repositionable tape strip to secure a flat ABS washer to the underside of the hood protector at the two locations indicated in the illustration. This will hold the washer in place while completing steps 13-15.

13. Place the hood protector on the bumpons and pedestals.

14. Re-hook the mounting clips on the front edge of the hood. Ensure the hood protector is centered on the hood and turn each screw until the “L” bracket is in place but not tight.

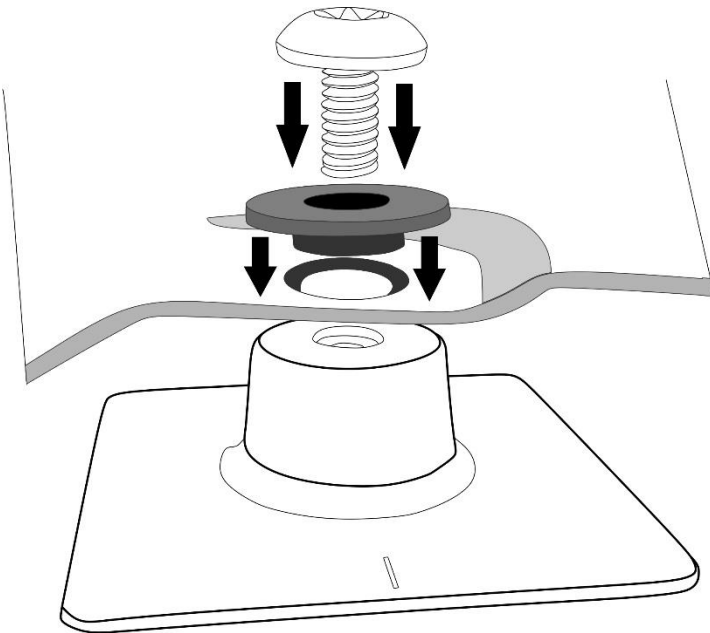

15. Place a Torx head screw through a shoulder washer and into a hole in hood protector. Ensure the shoulder portion of the washer slides into the hole in the hood protector. Loosely thread the screw into the mounting pedestal. See illustration for orientation of the shoulder washer. Repeat for all locations.

16. Ensure the hood protector is centered on the hood and using a T45 Torx key, tighten the screws into the pedestals. Start in the center position and work outwards. Ensure the shoulder washers are seated properly. Do not overtighten.

17. Tighten the screws into the mounting clips on the hood edge. Use caution- do not overtighten.

**Thank you for purchasing a Tough FormFit Guard hood protector!**