

RAPIDEFIT

RF F014
Ford Escape 2013-up

HOOD PROTECTOR/ Protège-Capot

HARDWARE KIT

Metal bracket assemblies (already attached to the protector)
Automotive surface cleaners
Abrasion pads
3M Adhesive tape (already attached to the protector)

TOOLS REQUIRED

1 . Clean cloth or paper towel
1 . Grease pencil
1 . Tape Measure



****Note- illustrations are generic and may not match actual application****

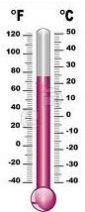

18°C
65°F



WARNING: To ensure complete adhesion of the 3M tape, protector must be installed at or above the minimum temperature shown. Vehicle must remain at this temperature for a minimum of 20 minutes after installation. Use of a heat gun or hair dryer may be required to achieve this.

****Failure to properly prepare the hood surface may void warranty. ****

1. Ensure that the hood is clean and dry inside and out (Steps 1 & 2).

2. Using the surface cleaners supplied, clean the shaded area of hood shown in the illustration below. Dry afterwards with a clean cloth or paper towel. (Steps 3 & 4) ****Failure to properly prepare the hood surface may void warranty. ****

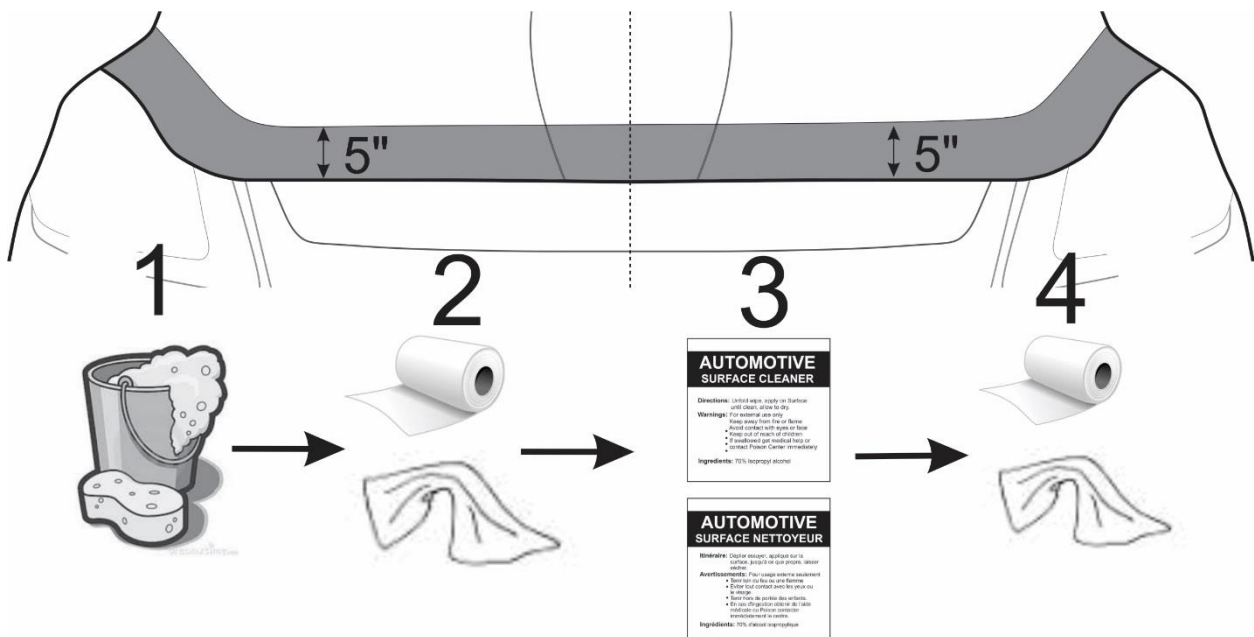

3. Open the hood. Position the hood protector on the hood at the edge. Taking care not to scratch the hood, center the hood protector on the hood. Using a grease pencil or erasable marker, mark the center of each metal bracket on the edge of the hood. Peel and fold an abrasion pad in half over the edge of the hood at each marked location.

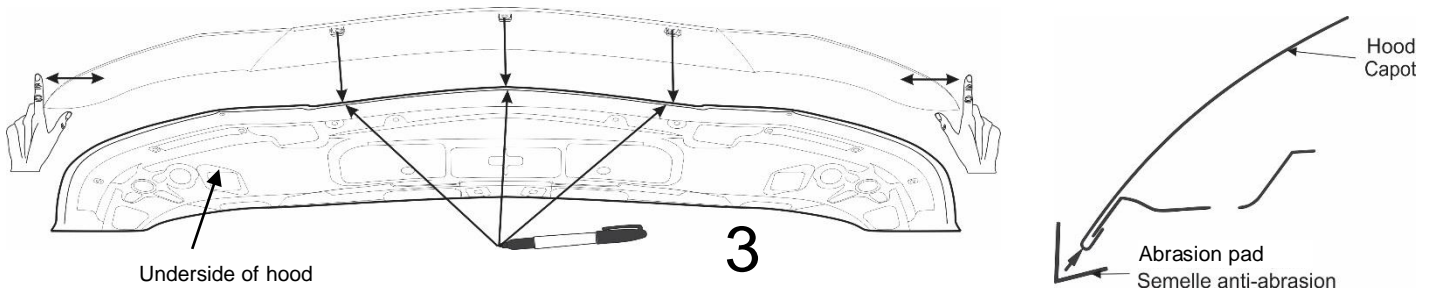

4. Fold tabs on the adhesive tape sections, located on the backside of the protector, so they are accessible after the protector is installed over the edge of the hood. *See illustration*

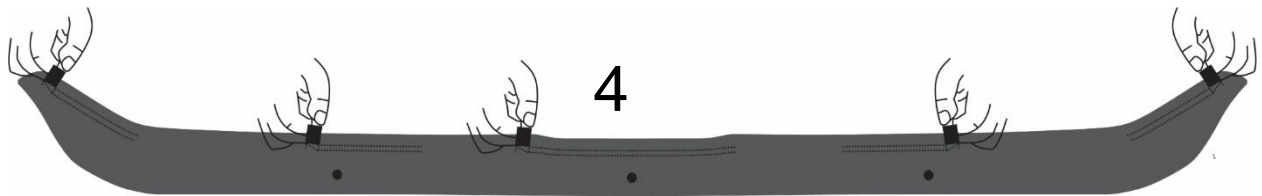

5. Install the protector by aligning the metal brackets with the abrasion pads and pushing the brackets over the hood edge until they are fully seated. Make sure tape liner tabs are accessible. ****Push on metal brackets, not hood protector****

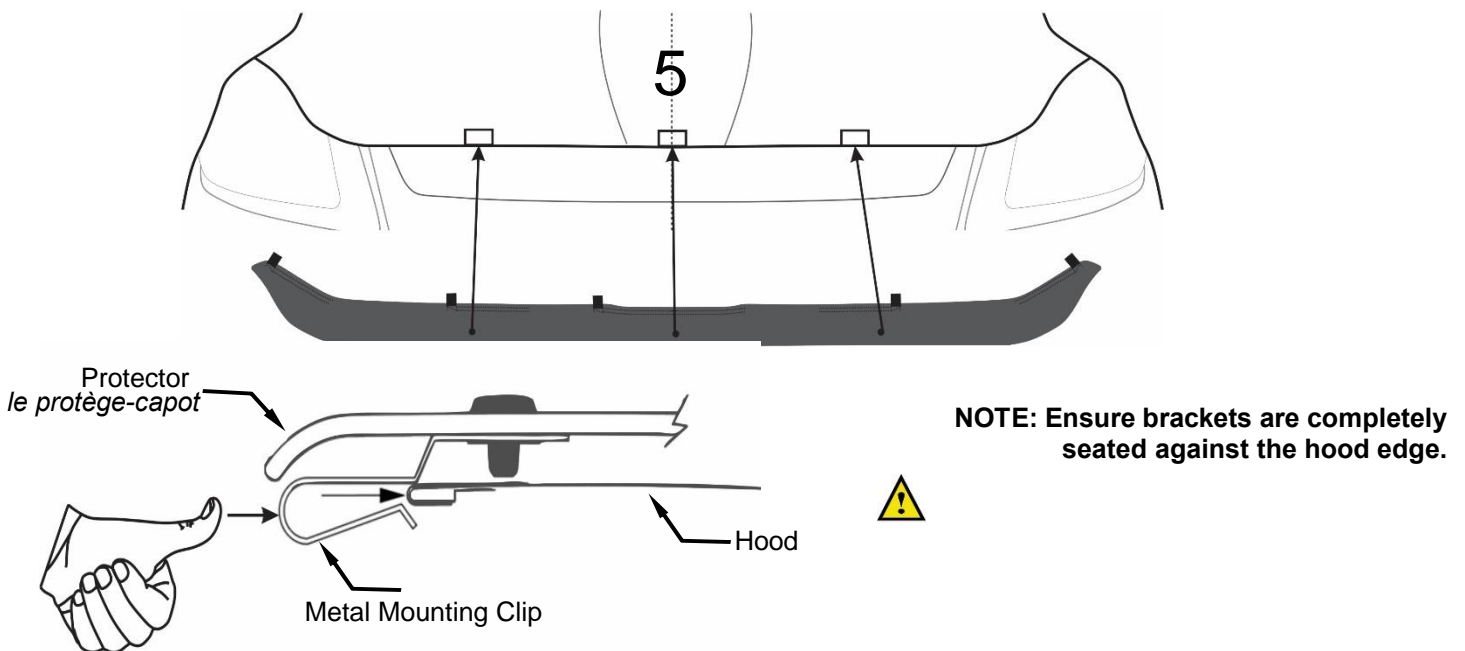

6. Confirm protector is centered on hood visually and by feeling overhang is the same on both ends. Shift protector left or right as required. **Ensure metal brackets remain fully seated.**

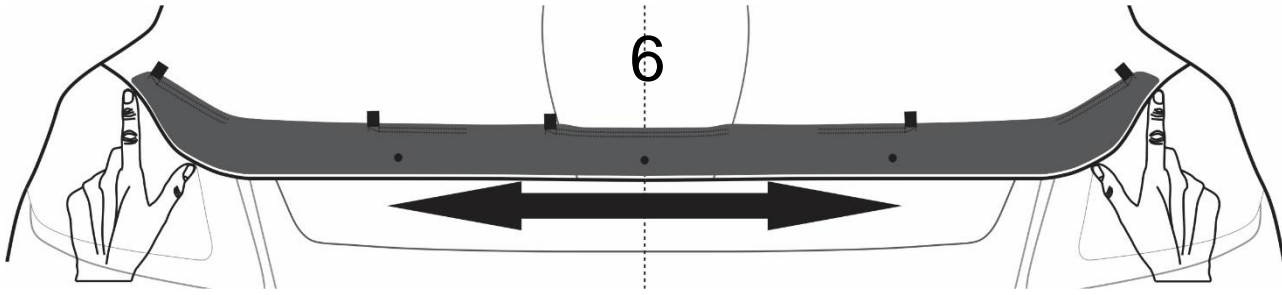

7. If there are tape segments at the front *and* rear of the protector, begin with the rear or trailing edge and centermost tape segment. Hold the tab of the adhesive tape liner and begin removing the liner while applying pressure on the surface of the protector with other hand. *See illustration.* Ensure the tape is well attached by applying firm pressure with your hands on the surface of the protector. Repeat for all tape segments, working away from the center. **Repeat this step after 20 min.**

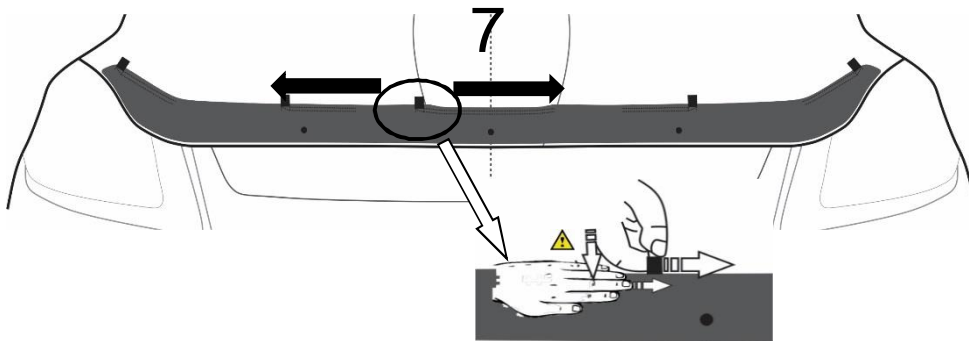

8. On some vehicles it may be necessary to adjust the hood bumpers and/or latch for proper clearance.



24 hrs

Do not use carwash for 24 hours after installation.

CARE INSTRUCTIONS

Clean the protector with a mild soap and water solution or plastic cleaner only. Do not use chemicals or solvents. Periodically check to make sure the protector is secure. Avoid using automatic car washes. Do not pull on protector when opening or closing the hood.

Thank you for purchasing a **Rapide Fit** hood protector. Retain this sheet for care instructions and kit information.