

FORM FIT Hood Protector HD 13S14



Installation Instructions

Nissan Rogue 2014 - up

PARTS LIST

Hood protector installation tape measure



Hood protector



Large pedestals (5)



Small pedestals (2)



Pins (7)



Screws (7)



Anti-abrasion pads (7)



Small metal mounting bracket (2)

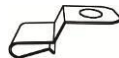

Large metal mounting brackets (5)

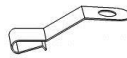

Surface cleaner (1)



Re-usable tape strips (1)

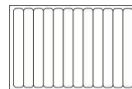

Pedestal centering template

TOOLS AND SUPPLIES REQUIRED

Long Shank Phillips Screwdriver #2

Masking Tape

Clean cloth or paper towel

INSTALLATION

- Make sure the vehicle is clean and completely dry before installation.
- This product uses a 3M adhesive that requires installation and curing temperatures of 15° to 43°C (60° to 110°F) for 1 hr to develop maximum adhesion to the hood surface.



Failure to install this product at the proper temperature or allow adequate curing time before use is not covered under warranty.

- Proper installation of the adhesive pedestal system requires the use of a #2 Phillips screwdriver, preferably with a long shaft. The shaft of the screwdriver needs to fit through the hole in the pedestal. Use of the correct screw driver will facilitate a trouble free installation. Do not attempt to use #1 or smaller Phillips screwdriver or any type of electric screwdriver.



1. Insert a pin through the hole in the hood protector installation tape measure supplied and into one of the large adhesive pedestals.

2. Install one of the screws into the pedestal.

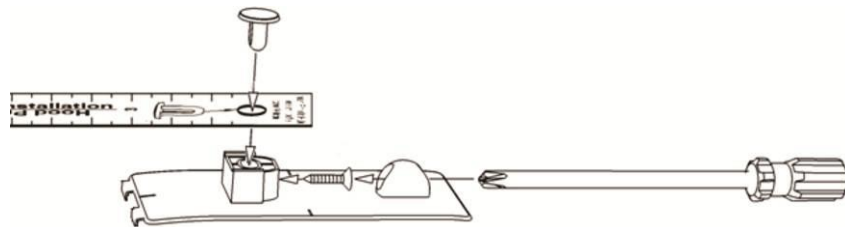

Locate center pedestal using installation tape measure and/or the supplied centering template.

3. Using masking tape or repositionable tape strips supplied, dry fit the large adhesive pedestal at the centre of the hood.

NOTE: The fingers incorporated on the leading edge of the pedestal ensure the correct position relative to the hood edge. When correctly positioned the fingers should contact the leading edge of hood.

- Use the installation tape measure to confirm center by measuring to opposite corners of the hood and adjust pedestal until both measurements are identical.

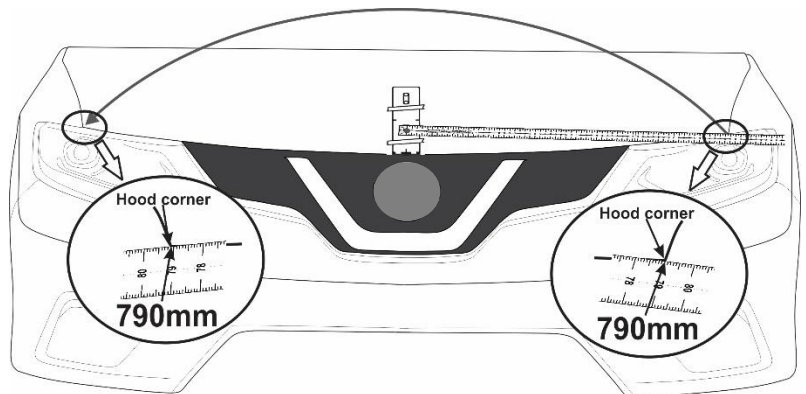

* Tape measure is always located below the measuring point*

1st

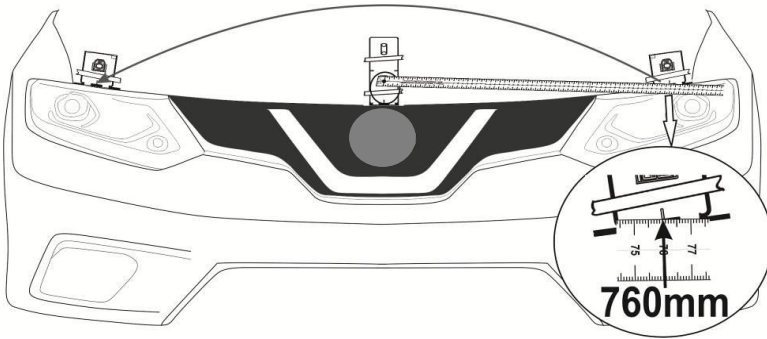

* Tape measure is always located below the measuring point*

2nd

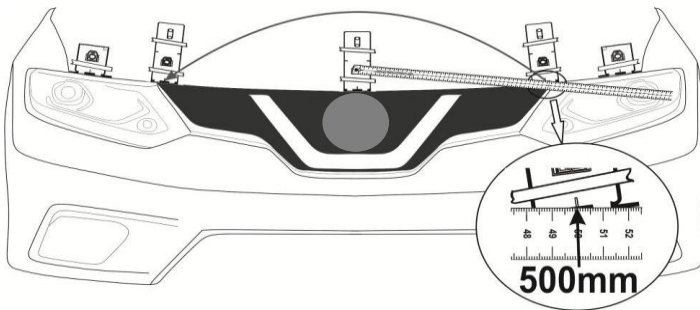

3rd

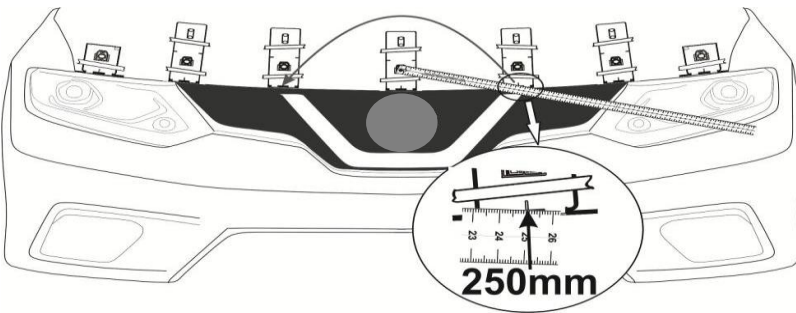

4. Starting at the outer most locations dry fit the remaining pedestals using masking tape or re-usable tape strips supplied to temporarily hold them in position.

The positions of the pedestals are shown in the **illustrations**. Use the center mark on the leading edge of the pedestals for accurate measuring. The fingers incorporated on the leading edge of the pedestal will help ensure the correct position relative to the hood edge. When correctly positioned the fingers should contact the leading edge of the hood.

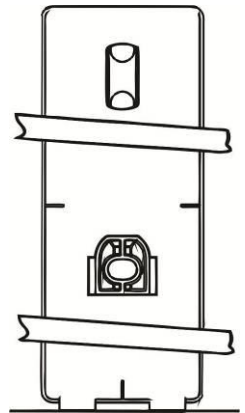
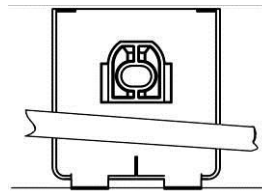

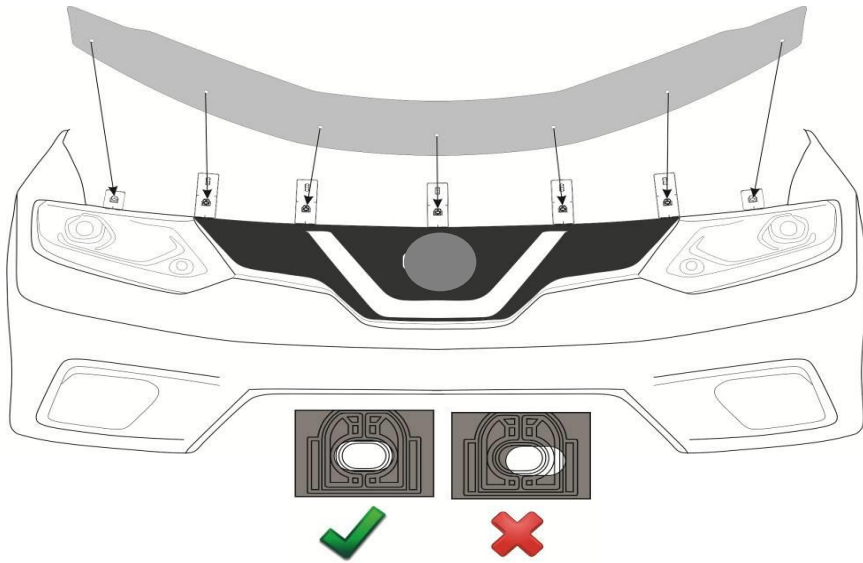

- Remove the hood protector installation tape measure by loosening the screw and removing the pin. Place the hood protector on the pedestals to confirm proper positioning. Ensure the holes in the protector align with those in the pedestals. If necessary, reposition the pedestals so all attachment positions are correct and the protector is well centered.

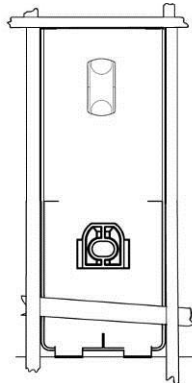

- Remove the hood protector, and outline the perimeter of the pedestals with masking tape or the re-usable tape strips supplied to help final installation.

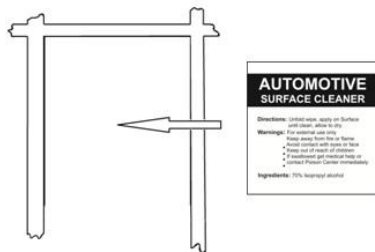

- Remove the pedestals and thoroughly clean the outlined area with the alcohol wiping pad. Wipe dry with a clean cloth or paper towel. This will insure all wax, finger prints and oils are removed from the hood surface in the bonding area.

⚠ Important! Proper preparation of the hood surface will ensure maximum adhesive bond.

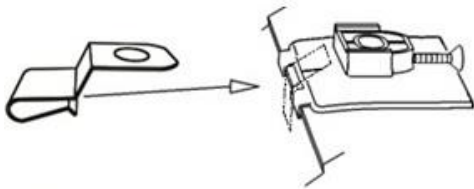
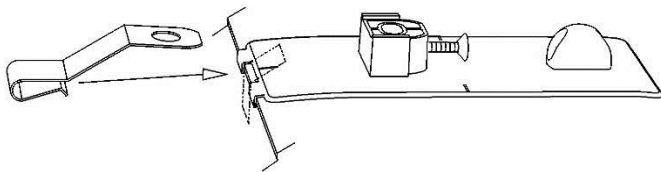
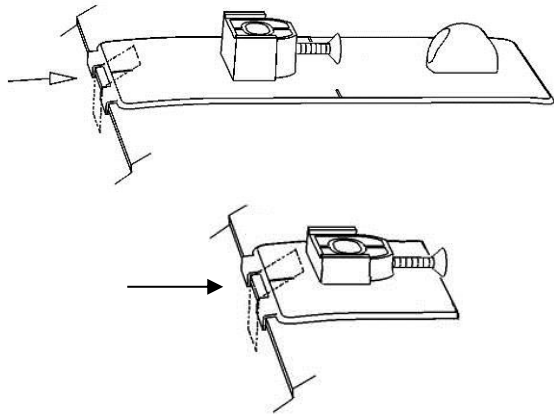
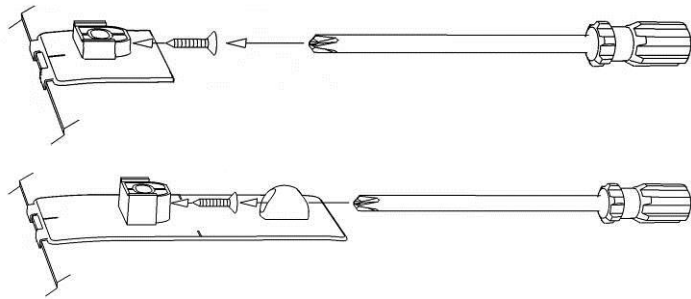
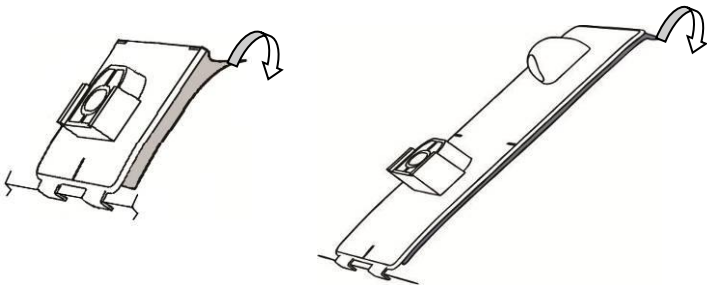

8. One pedestal at a time, remove the protective backing from the adhesive and install on the hood surface.

Use caution to not contaminate the adhesive surface

Tip: Hook the fingers on the pedestal over the hood edge and rotate the unit into position. After installation, remove the masking tape and “wet out” the adhesive to the hood surface by applying pressure with your thumb around the complete surface of the pedestals.

⚠ Important: “wetting out” of the pedestals will ensure maximum adhesive bond.

9. Start a screw into each pedestal a few turns. The tip of the screw must not protrude into the hole where the attachment pin will later install.

10. Peel and fold the anti-abrasion pads in half over the hood edge between the fingers on the pedestals.

11. Push metal mounting brackets over the hood edge aligned with the anti-abrasion pads installed previously. Ensure each bracket is fully engaged over the hood edge and the hole in the bracket is aligned with the hole in the pedestal.

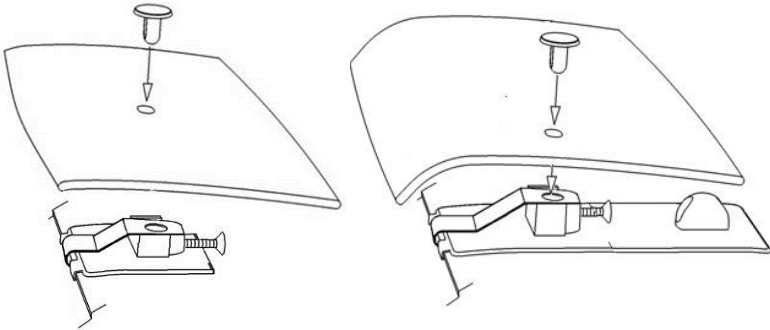

- Place the protector on the pedestals and, starting at the center location, install a pin through the protector and into the pedestal. Maintain slight pressure on the pin to ensure proper seating of the components, while simultaneously tightening the screw a few turns. Repeat for remaining pedestal locations.



NOTE: Only tighten screws a few turns so the pins are held in place but there is still some movement of the protector as this assists in final alignment of all attachment positions.

- Starting at the center location tighten all the screws that were loosely installed in step 12.

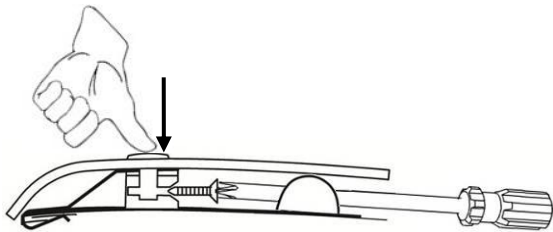

NOTE: To allow the adhesive to cure do not wash the vehicle for 24 hrs. Please inform the customer of this.

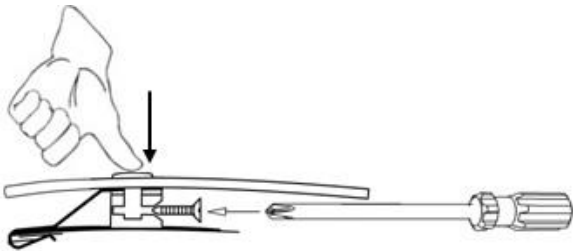

CARE

Hand clean the protector using a mild soap and water solution or plastic cleaner only. Avoid automatic car-wash equipment where a brush and/or soft cloth come in contact with the hood protector. Touch-less style automatic car-wash equipment is less likely to harm the hood protector.

SERVICE

Periodically check to confirm the protector is securely attached to the hood.

WARNINGS

- Do not pull/push on the protector when opening/ closing the hood.

NOTE

On some vehicles it may be necessary to adjust the hood bumpers and/or latch for proper clearance.

Nissan Rogue 14 - up

Center Pedestal Placement Template

Template Instructions

1. Cut along dashed line
2. Carefully fold template at fold lines and place along hood edge
3. Align half-circle in template with center rivet located under the hood
4. Use tape strips to hold template
5. Place pedestal using center line

