

FLUKE®

DS701, DS703 FC

Diagnostic Videoscopes

Users Manual

Table of Contents

Title	Page
Introduction	1
How to Contact Fluke.....	1
Safety Information.....	1
Product Familiarization	4
Features.....	4
Standard Accessories.....	5
Display	8
Control Panel.....	9
Basic Operation	9
Capture an Image.....	9
Record a Video	10
Menus	10
Primary Menu	10
Image Menu.....	11
Setup Menu	11
Date.....	12
Time.....	12
Fluke Connect	13
Memory Menu.....	13
Review Image or Video	13
Delete Image	14
View Images or Videos	14
View on a PC.....	14
View on an HDMI Device.....	15
View with Fluke Connect	15
Update Firmware	15
Fluke Connect Desktop Software	15
Accessories.....	16
Neck Strap	17
Maintenance	17
Clean the Product.....	18
Charge the Battery.....	18
Radio Frequency Data	19
Specifications.....	19

⚠⚠ Warning

To prevent possible electrical shock, fire, or personal injury and for safe operation of the Product:

- Read all safety information before you use the Product.
- Carefully read all instructions.
- Do not alter the Product and use only as specified, or the protection supplied by the Product can be compromised.
- Do not use the Product if it operates incorrectly.
- Do not use the Product if it is altered or damaged.
- Disable the Product if it is damaged.
- Do not put metal objects into connectors.
- Use only specified replacement parts.
- Have an approved technician repair the Product.
- Use only the external mains power supply included with the Product.
- Batteries contain hazardous chemicals that can cause burns or explode. If exposure to chemicals occurs, clean with water and get medical aid.
- Charge the batteries when the low battery indicator shows to prevent incorrect measurements.
- Disconnect the battery charger and move the Product or battery to a cool, non-flammable location if the rechargeable battery becomes hot (>50 °C) during the charge period.
- De-energize the circuit or wear personal protective equipment in compliance with local requirements before you use the probe in a wall.
- Do not use the probe in a wall with metal pipes until a qualified electrician verifies the metal pipes do not contain a charge. Ground circuits can cause metal pipes to carry a charge.
- Do not use the probe in moving parts.
- Do not use the Product for medical reasons. The Product is intended for equipment evaluation only and should never be used in diagnostics, treatment, or any other capacity where the Product would come in contact with a patient.

⚠ Caution













To prevent damage to the Product, do not expose the probe to petroleum-based products.

Note

Electrostatic discharge may cause the Product to turn off.

Table 1 is a list of symbols that can be used on the Product or in this manual.

Table 1. Symbols

Symbol	Description
	Consult user documentation.
	WARNING. RISK OF DANGER.
	WARNING. HAZARDOUS VOLTAGE. Risk of electric shock.
	Battery status.
	Battery charger input.
	On/Off
	Conforms to European Union directives.
	Certified by CSA Group to North American safety standards.
	Conforms to relevant Australian Safety and EMC standards.
	Conforms to relevant South Korean EMC standards.
	Conforms to the Appliance Efficiency Regulation (California Code of Regulations, Title 20, Sections 1601 through 1608), for small battery charging systems.
	This Product contains a lithium-ion battery. Do not mix with the solid waste stream. Spent batteries should be disposed of by a qualified recycler or hazardous materials handler per local regulations. Contact your authorized Fluke Service Center for recycling information.
	This product complies with the WEEE Directive marking requirements. The affixed label indicates that you must not discard this electrical/electronic product in domestic household waste. Product Category: With reference to the equipment types in the WEEE Directive Annex I, this product is classed as category 9 "Monitoring and Control Instrumentation" product. Do not dispose of this product as unsorted municipal waste.

Product Familiarization

The manual explains features for multiple models. Because models have different features, not all of the information in the manual may apply to your Product. The figures show the DS703 FC. Use Table 2 to identify the features of your Product.

Features

Table 2 lists the features of the Product.

Table 2. Features

Feature	DS701	DS703 FC
Cameras		
Forward	●	●
Side	●	●
Up is Up™ Technology	●	●
Digital Zoom	●	●
Straps		
Hand	●	●
Neck		●
Touch Screen		●
Connectivity		
USB	●	●
HDMI®		●
WiFi™		●
Fluke Connect® Desktop software		●
Fluke Connect® App		●

Standard Accessories

Table 3 shows the Product and the standard accessories.

Table 3. Standard Accessories



The diagram illustrates the diagnostic videoscope and its standard accessories. The main unit is a yellow handheld device with a central LCD screen (3) displaying a close-up of a mechanical part. A hand strap (2) is attached to the side, and a control panel (1) is located at the bottom. A probe (4) is connected to the top. A USB charger (5) is shown separately. A neck strap (6) is also included. Two cables are provided: a USB cable (7) and an HDMI cable (8). A T-Pak magnetic hanger (9) is shown at the bottom left.

Item	Description	Item	Description
1	Control panel	6	Neck strap
2	Hand strap	7	USB cable
3	LCD screen (display)	8	HDMI cable
4	Probe	9	T-Pak magnetic hanger
5	USB charger		

Table 4 shows the connections of the Product.

Table 4. Connections

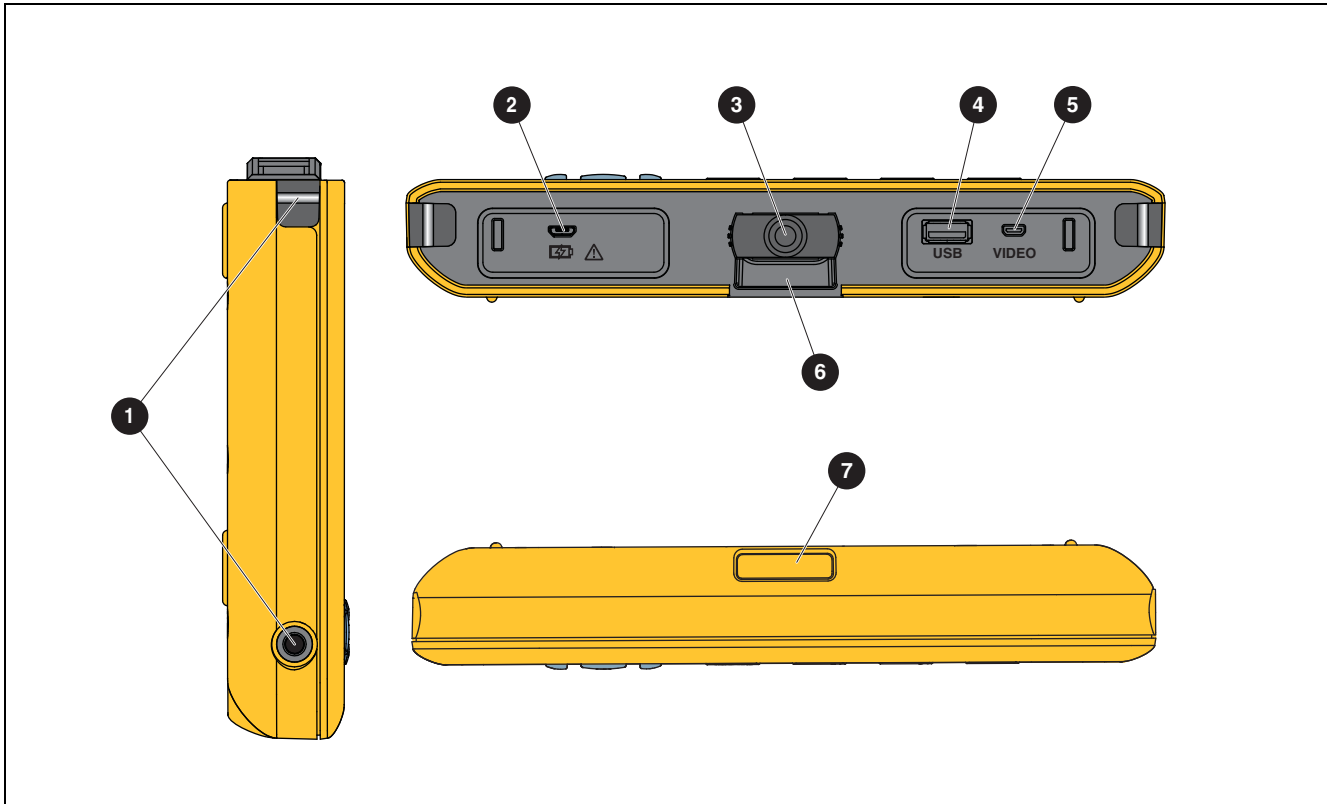

Item	Description	Item	Description
1	Anchors for hand strap	5	HDMI input
2	Micro B USB input	6	Anchor for T-Pak magnetic hanger
3	Probe input	7	Anchor for neck strap
4	USB A input		

Table 5 shows the parts of the probe.

Table 5. Probe

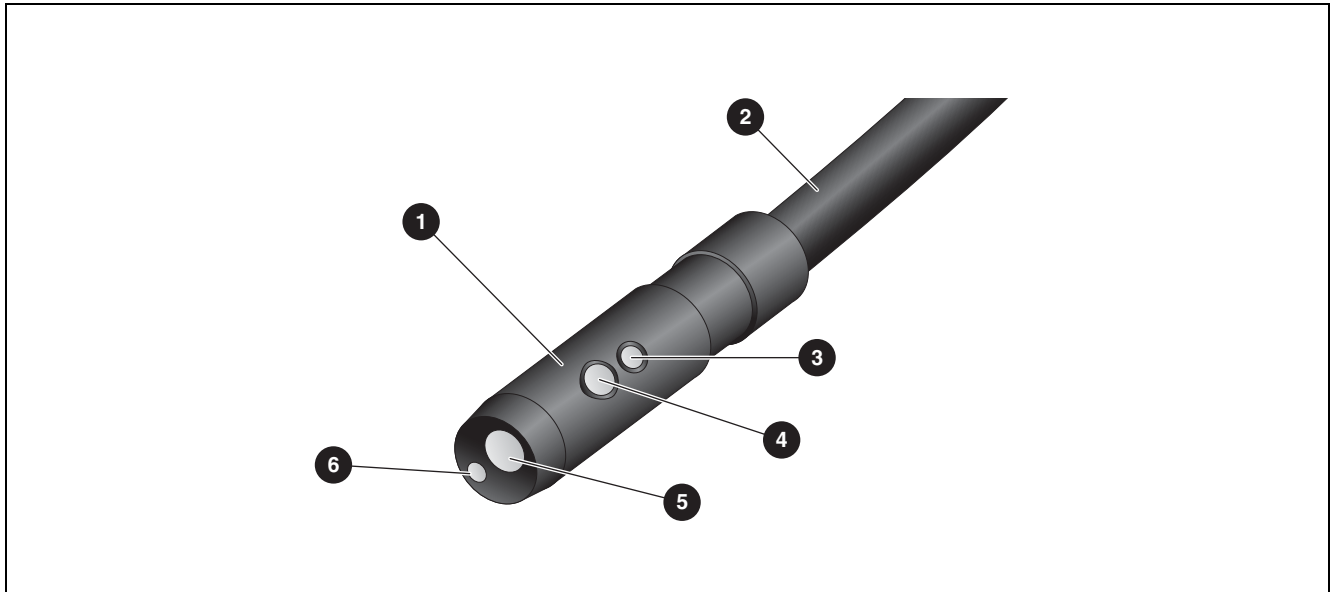









Item	Description	Item	Description
1	Probe head	4	Side LED
2	Probe cable	5	Forward camera
3	Side camera	6	Forward LED

Display

Use the control panel (see [Control Panel](#)) to select an icon to change parameters or select functions and options. Use the touch screen as a shortcut to common settings. The display has a backlight for work in dimly-lit spaces. Table 6 lists the functions of the icons on the display.





















Table 6. Display

Icon	Description	Touch Screen Function
	Primary menu	Tap to open the Primary menu.
	Memory menu	Tap to review or delete captured images and videos.
	Image mode	Tap to capture an image. See Capture an Image .
	Video mode	Tap to start recording a video. Tap again to stop recording a video. See Record a Video .
	Forward/side camera control	Tap to toggle between the front and side camera.
	Battery status	Shows the battery level.
	Zoom control	Touch, hold, and move to the left or right to zoom in or out. To open this feature, see Control Panel .
	Flashlight brightness control	Touch, hold, and move to the left or right to increase or decrease the brightness of the flashlight. To open this feature, see Control Panel .
	Back arrow	In the primary menu, tap to go back to live view. In a submenu, tap to go back to the previous menu.

Control Panel

Use the control panel to change parameters or select functions and options. Table 7 lists the functions of the buttons on the Control Panel.

Table 7. Control Panel

Button	Home Screen Function
	Push to turn on or off the Product.
F1	NA
F2	Push to open the Primary menu ().
F3	Push to turn on or off the zoom control (). Use  /  to zoom in or out.
F4	Push to turn on or off the flashlight brightness control (). Use  /  to increase or decrease brightness.
	With the zoom and flashlight brightness controls off, push to highlight  ,  ,  /  , or  /  .
SELECT	<p>With the Primary menu () or the Memory menu () highlighted, push to open the selected menu.</p> <p>With  highlighted, push to capture an image. See Capture an Image.</p> <p>With  highlighted, push to record a video. See Record a Video.</p> <p>With / highlighted, push to toggle between the front and side cameras.</p>

Basic Operation

Before you use the Product for the first time, see [Charge the Battery](#).

To use the Product, attach the probe to the probe input. See Table 3.

Capture an Image

To capture an image:

1. Use the arrow keys to highlight .
2. Push **SELECT** to capture an image.

The display flashes briefly, and the image saves to memory.

Record a Video

To record a video:

1. Select **Menu > Image > Video > Done > Cancel** to select video mode and return to the home screen.
2. Push **SELECT** to start recording a video.
3. Push **SELECT** again to stop recording a video.

The video saves to memory.

Menus

Use the menus to change and view settings.

To change settings:

1. Push **F2** to open the Primary menu
2. Push **F1** to open the Image menu, or push **F2** to open the Setup menu.
3. Push **▼** / **▲** to select an option.
4. If needed, push **▶** to open a submenu.
5. Push **F1**, **F2**, or **F3** to select an option.
6. Push **F4** to set the option and return to the previous screen.

Primary Menu

Table 8 lists the secondary menus available in the Primary Menu.

Table 8. Primary Menu

Secondary Menu	Description
Image	Set features used to show images on the display and in some saved image and video files.
Setup	Set user preferences.
Cancel	Select to return to live view. Does not cancel changes.

Image Menu

Table 9 lists the options in the Image menu.

Table 9. Image Menu

Option Menu	Option	Description
Image Mode	Image	Select to set up the Product to capture an image.
	Video	Select to set up the Product to record a video.
View Mode	True Color	Select to set the view mode.
	Texture	Use True Color to differentiate similar colors from each other. Use Texture to emphasize the texture of the target.
	UV	Use UV to identify leak detection with UV dye. Images are clearer when used with the UV accessory.
	Inspection	Use Inspection to Identify cracks, wear points, and fine print.
Color	Standard	Select to set the color palette.
	Grayscale	
	Inverted	
Rotate	180	Select to rotate the image 180 °.
	None	Select to view the image with no rotation.
Up is Up	On	Select to rotate the image automatically so the orientation of the image on the display is upright regardless of the position of the probe. With On activated, use the Product to: <ul style="list-style-type: none"> • View text such as serial numbers. • Identify the location of items in relation to each other. For example, if switch A is located to the right of switch B, switch A shows on the display to the right of switch B.
	Off	Select to view the image with no orientation correction.

Setup Menu

Table 10 lists the options in the Setup menu.

Table 10. Setup Menu

Option Menu	Option	Description
Auto Off	<options>	Sets the time before the Product automatically turns off.
Time Stamp	ON	Turns on/off the time stamp on image and video files.
	OFF	
Backlight	<options>	Sets the brightness level of the display.
Date/Time	<options>	Sets the date format and the date. See Date . Sets the time format and the time. See Time .

Table 10. Setup Menu (cont.)

Option Menu	Option	Description
Fluke Connect	Wifi (ON)	Turns on or off WiFi. Select WiFi ON to pair the Imager to the Fluke Connect app on a mobile device or to other Fluke Connect tools. See Fluke Connect .
	Wifi (OFF)	<i>Note</i> The Fluke Connect system is not available in all countries.
Data storage	Internal	Saves files to the internal memory.
	USB	Saves files to a USB storage device.
	Eject USB	With USB enabled, use to safely remove a USB device.
Language	<options>	Sets the language to use on the display.

Date

The date shows as: **MM/DD/YY**, **DD/MM/YY** or **YYYY/MM/DD**.

To set the date:

1. Select **Menu > Setup > Date/Time**.
2. Push **F2** to open the Date Format menu.
3. Select **MM/DD/YY**, **DD/MM/YY** or **YYYY/MM/DD**.
4. Push **▶** to open the set date option menu.
5. Push **◀ / ▶** to select the day, month, or year.
6. Push **▼ / ▲** to change the day, month, or year.
7. Push **F4** to set the date and return to the previous menu.

Time

Time shows as: **12 hour** or **24 hour**.

To set the time format:

1. Select **Menu > Setup > Date/Time**.
2. Push **F3** to open the Time Format menu.
3. Select **12 hour** or **24 hour**.
4. Push **▶** to open the set time option menu.
5. Push **◀ / ▶** to select the minutes or hours.
6. Push **▼ / ▲** to change the minutes or hours.
7. If you selected the 12 hour format, select **AM** or **PM**.
8. Push **F4** to set the time and return to the previous menu.

Fluke Connect

The Product supports the Fluke Connect Wireless system. The Fluke Connect system wirelessly connects your Fluke test tools with an app on a mobile device. Use the app to view images saved on the Product or on your mobile device.

Note

The Fluke Connect system is not available in all countries.

The Fluke Connect app works with Apple and Android products. The app is available for download from the Apple App Store and Google Play.

To use the Fluke Connect app with the Product:

1. On the Product:
 - a. Capture an image.
 - b. Select **Menu > Setup > Fluke Connect > Wifi (ON)**.
2. On the mobile device:
 - a. Download the Fluke Connect app.
 - b. Go to **Settings > Wi-Fi**.
 - c. Select the Wi-Fi network that begins with **FLUKE...**
 - d. In the password field, enter **fluketools**.
3. On the Fluke Connect app:
 - a. Select **DS703 FC <Serial Number>** from the list. The serial number is located on the back of the Product.
 - b. Follow the directions in the app.

Note

Videos cannot be viewed on the app.

Memory Menu



Use the Memory menu to review or delete captured image and video files.

Review Image or Video

To review an image:

1. Use the arrow keys to highlight the Memory menu ().
2. Push **SELECT** to open the Memory menu.
3. Use the arrow keys to select the preview image of the file for review.
4. Push **F1** to review the file.
5. If needed, push **F2** to zoom in or push **F3** to zoom out.

To review a video:

1. Use the arrow keys to highlight the Memory menu ().
2. Push **SELECT** to open the Memory menu.
3. Use the arrow keys to select the preview image of the file for review. All video files show  on the thumbnail.
4. Push **F1** to review the file.
5. Push **F1** to play the video.

Delete Image

To delete images, see Table 11.

Table 11. Delete Images

Action	Procedure
Delete one file	<ol style="list-style-type: none">1. Open the Memory menu.2. Select a preview image.3. Push F2 to open the Delete menu. The Product prompts you to delete or cancel.4. Push F2 again to delete the file.
Delete all files	<ol style="list-style-type: none">1. Open the Memory menu.2. Push F3 to select Delete All. The Product prompts you to delete or cancel.3. Push F2 to delete all the files from the memory.

View Images or Videos

Once files save on the Product, you can view the files on a PC, on an HDMI compatible device, or in the Fluke Connect app (where available).

View on a PC

To view saved files on a PC through a USB connection:

1. Connect the USB A connector end of the USB cable into your PC and the Micro B USB connector end of the USB cable into the Product.
The PC will register the Product as a USB device.
2. On the PC, select the file to review.

View on an HDMI Device

HDMI (High-Definition Multimedia Interface) is a compact audio/video interface that transfers uncompressed data and compressed/uncompressed digital audio data from the Product to a compatible HDMI device.

To view saved files on an HDMI device:

1. Attach the included HDMI cable to the HDMI input on the Product.
2. Connect the other end to an HDMI video device.
3. On the video device, select the HDMI port number that the HDMI cable is attached to.
4. On the Product, select the file to view.

View with Fluke Connect

To view saved files in the Fluke Connect app, see [Fluke Connect](#).

Update Firmware

1. Connect the USB A connector end of the USB cable into your PC and the Micro B USB connector end of the USB cable into the Product.
The PC will register the Product as a USB device.
2. On the PC,
 - a. Go to website.
 - b. Search for the model of your product.
 - c. Click on the link to open the download page for the Product.
 - d. Click on the link to download the firmware update.
 - e. Select **Yes** if prompted to download a firmware update file.
 - f. Select the USB drive the Product is connected to as the location to store the update file.
3. To use the new firmware, turn off the Product and then turn on the Product again.

Accessories

Table 12 is a list of the accessories available for the Product.

Table 12. Accessories

Model	Description	PN
FLK-3.8MM PROBE, 1M, FORWARD VIEW	3.8 mm wide, 1 m long high definition imaging probe with a forward view lens.	4962690
FLK-5.5MM PROBE, 1M, DUAL VIEW	5.5 mm wide, 1 m long high definition imaging probe with forward and side view camera lenses.	4962713
FLK-8.5MM PROBE, 1.2M, DUAL VIEW ^[1]	8.5 mm wide, 1.2 m long high definition imaging probe with forward and side view camera lenses.	4962749
FLK-8.5MM PROBE, 3M, DUAL VIEW ^[1]	8.5 mm wide, 3 m long high definition imaging probe with forward and side view lenses.	4962708
FLK-8.5MM UV PROBE, 1M, DUAL VIEW	8.5 mm wide, 1 m long high definition UV imaging probe with forward and side view camera lenses for use with UV dyes to identify leak detection.	4962751
FLK-9MM PROBE, FORWARD VIEW 20M, REEL	20 m reel for probe storage.	4962760
FLK-DS NECK STRAP, DS7XX NECKSTRAP	Padded neck strap.	4962772
[1] Compatible with Up is Up technology.		

Neck Strap

Use the neck strap to carry the Product for an extended period of time. See Figure 1.



Figure 1. Adjustable Neck Strap

Maintenance

To maintain the Product, clean the case and lenses and charge the batteries.

⚠ Caution

To prevent damage to the Product, do not drop the Product. Treat the Product as a calibrated instrument.

Clean the Product

Caution

To prevent damage to the Product, do not use abrasives, isopropyl alcohol, or solvents to clean the case or lenses.

Clean the case with a damp cloth and a weak soap solution. To clean the lenses, use a pressurized can of air or a dry nitrogen-ion gun, if available, to blow off the particulates from the lenses.

Charge the Battery

Before you use the Product for the first time, charge the battery for ≥ 2.5 hours. See Figure 2.

Note

New batteries are not fully charged. Make sure that the Product is near room temperature before you connect the Product to the charger. See the charging temperature specification. Do not charge in hot or cold areas. When you charge in extreme temperatures, battery capacity may decrease.

Note

The battery does not charge while the Product is on even if  shows as the battery status.

To charge the battery:

1. Turn off the Product.
2. Connect the USB A connector end of the USB cable into the USB charger.
3. Connect the USB charger into an ac wall outlet and connect the Micro B USB connector end into the Micro B USB input on the Product.
4. Wait ≥ 2.5 hours for the Product to charge.
5. Disconnect the USB cable from the Product.
6. Turn on the Product.

 shows on the display when the battery is fully charged.

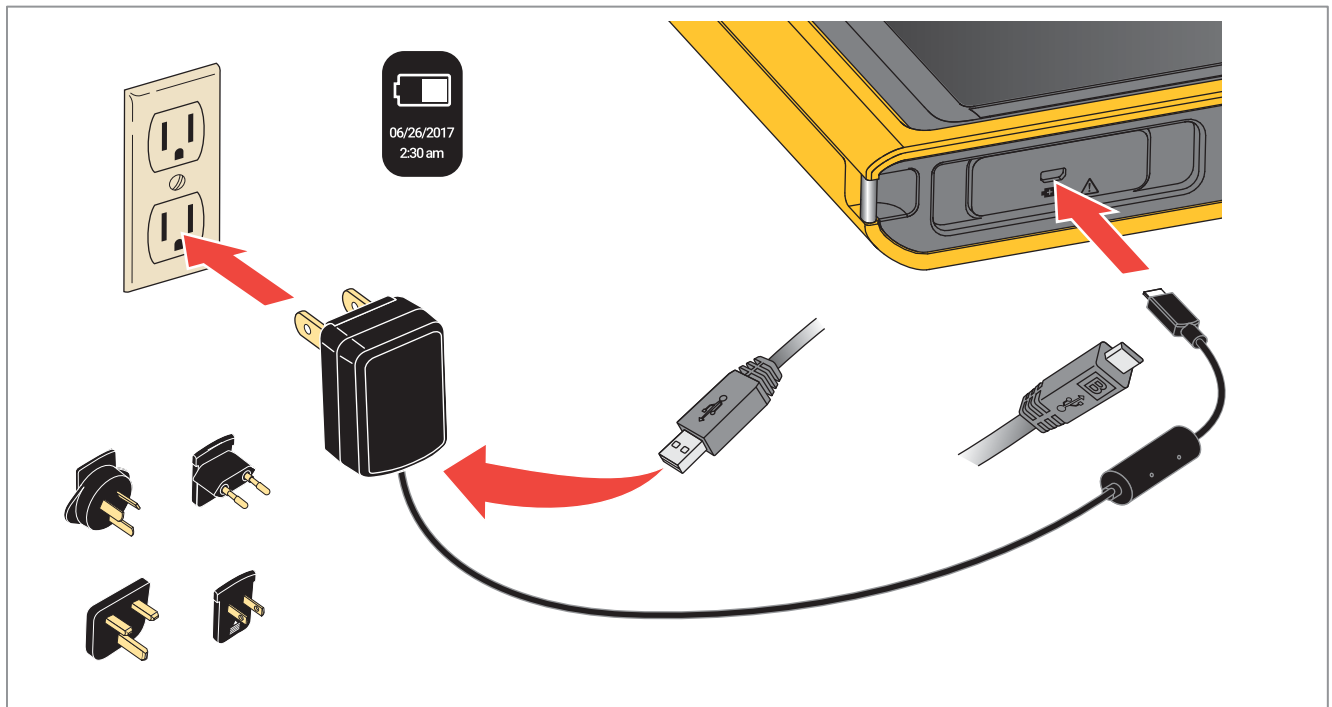

Figure 2. Charge the Battery

Specifications

Temperature

Operating	0 °C to 50 °C (32 °F to 122 °F)
Storage	-10 °C to +60 °C (-14 °F to +140 °F)
Battery Charging	0 °C to 45 °C (32 °F to 113 °F)

Relative Humidity 10 % to 95 % non-condensing

Altitude

Operating	2000 m
Storage	12 000 m

Power Internal lithium-ion battery, 3.7 V, 6400 mAh

Size (H x W x L) 178 mm x 225 mm x 37 mm
(7.0 in x 8.8 in x 1.5 in)

Weight 0.92 kg (2.0 lbs)

Safety IEC 61010-1: Pollution Degree 2

Wireless Radio (DS703 FC)

Frequency 2412 MHz to 2462 MHz
Output Power <100 mW

Electromagnetic Compatibility (EMC)

International IEC 61326-1: Portable Electromagnetic Environment; IEC 61326-2-2
CISPR 11: Group 1, Class A

Group 1: Equipment has intentionally generated and/or uses conductively-coupled radio frequency energy that is necessary for the internal function of the equipment itself.

Class A: Equipment is suitable for use in all establishments other than domestic and those directly connected to a low-voltage power supply network that supplies buildings used for domestic purposes. There may be potential difficulties in ensuring electromagnetic compatibility in other environments due to conducted and radiated disturbances.

Caution: This equipment is not intended for use in residential environments and may not provide adequate protection to radio reception in such environments.

Korea (KCC) Class A Equipment (Industrial Broadcasting & Communication Equipment)

Class A: Equipment meets requirements for industrial electromagnetic wave equipment and the seller or user should take notice of it. This equipment is intended for use in business environments and not to be used in homes.

USA (FCC) 47 CFR 15 subpart B. This product is considered an exempt device per clause 15.103.

Manual Supplement

Manual Title: DS701, DS703 FC Users Supplement Issue: 3

This supplement contains information necessary to ensure the accuracy of the above manual.

DS701, DS703 FC Users

Manual Supplement

Change #1, 575

For the DS703 FC only:

Fluke Connect functionality is coming soon. Go to website and register your product to receive notification when Fluke Connect is available in your region.

Change #2, 632, 635

On page 19, under **Specifications**, replace **Temperature** section with:

Operating 0 °C to +45 °C
(+32 °F to +113 °F)
Storage -10 °C to +60 °C
(-14 °F to +140 °F)
Battery Charging 0 °C to 35 °C
(+32 °F to +95 °F)
Rating 5 V DC, 1.3 A