



Installation Instructions
817913
2020 JEEP GLADIATOR TRUCK
3.6L ENGINE

OVERVIEW:

1. Take a moment to read and understand these instructions before installing your Flowmaster performance system.

NOTE: Please inventory all parts now before continuing and if necessary, report any missing items to our tech line. This will avoid potentially stranding your vehicle until any missing replacement parts arrive.

| ITEM NO. | PART NO. | DESCRIPTION | QTY. |
|----------|----------|----------------------------|------|
| 1 | 26791S | Inlet Pipe | 1 |
| 2 | 843047-Z | Muffler | 1 |
| 3 | 26792S | Y-Pipe | 1 |
| 4 | 86627S | Right Exit Pipe | 1 |
| 5 | 86628S | Left Exit Pipe | 1 |
| 6 | ST461 | Tips | 2 |
| N/A | PK1022 | Hardware Package includes: | 1 |
| 7 | 517HA | Rear Frame Hanger | 1 |
| 8 | MC250BS | 2½" Stainless Band Clamp | 2 |
| 9 | MC300BS | 3" Stainless Band Clamp | 2 |

PREPARE VEHICLE FOR KIT INSTALLATION:

2. Raise vehicle up on a hoist or rack to working height. If you don't have access to a hoist or rack, support vehicle with jack stands.

WARNING:

Avoid serious burns! Allow your vehicle time to cool completely before touching any factory engine components.

To ease preparation and installation of your new kit:

- Apply penetrating lubricant to mounts, bolts and clamps before you remove them.
- Use stands as necessary to support parts as you detach them from your vehicle and again as you install new parts.

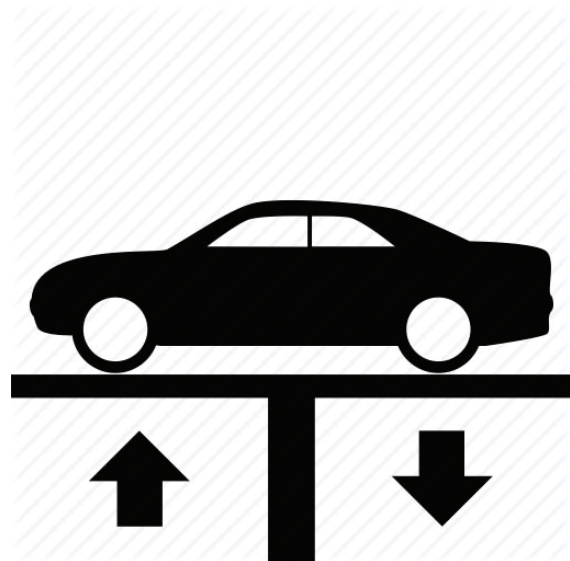

- Support then cut tailpipe at muffler exit. Unbolt rear hanger mount from frame then slide tailpipe section out and down from vehicle. Leave hanger mount on system.

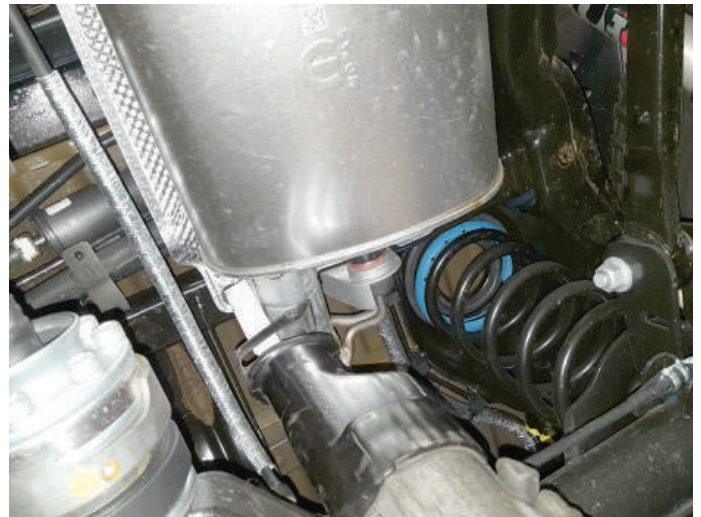
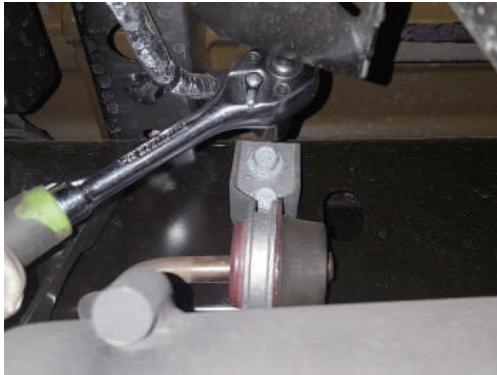

- Loosen ball clamp, disconnect inlet pipe at catalytic converter and slide exhaust system out and down from vehicle.



INSTALL FLOWMASTER EXHAUST SYSTEM

- Release tab to remove ball clamp from inlet pipe and retain it for later use. Remove nuts from stock and Flowmaster clamps, apply anti-seize compound to bolts and re-install nuts.

NOTE: The image in this step is intended for illustrative purposes only and may or may not accurately reflect components included in your kit.

- Every slip fit connection in this kit must seat 3" deep except for muffler connections which must seat 2" deep. Find all slip fit components in your kit and mark them accordingly so your Flowmaster exhaust system fits properly onto your vehicle.



7. Place factory ball clamp (removed step 5) onto **inlet pipe (1)** then connect it to catalytic converter. Insert wire hanger in isolator and tighten clamp enough to allow for adjustment.

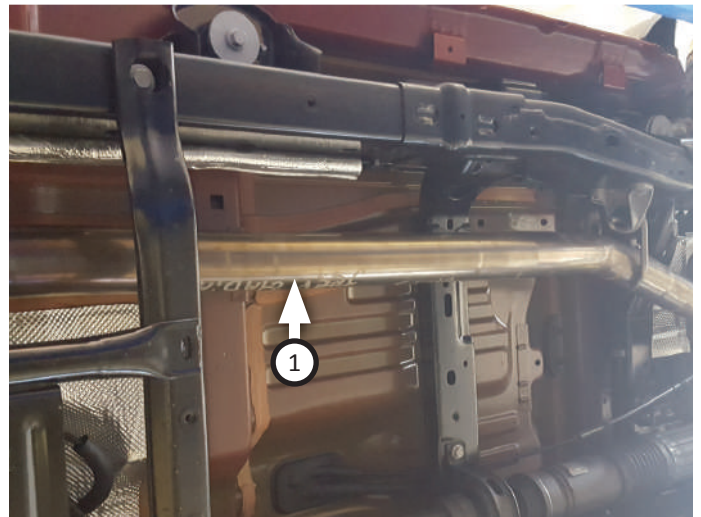
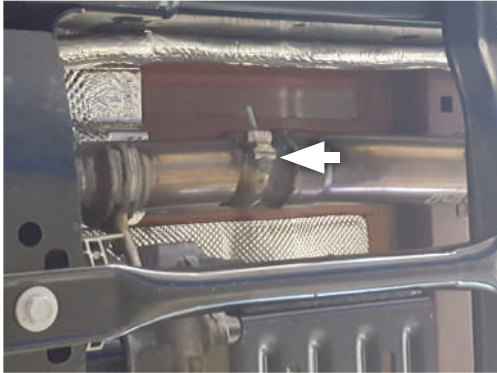

8. Place **clamp (9)** onto **muffler (2)** then connect it to inlet pipe. Tighten clamp just enough to allow for adjustment then place **clamp (9)** onto muffler outlet.

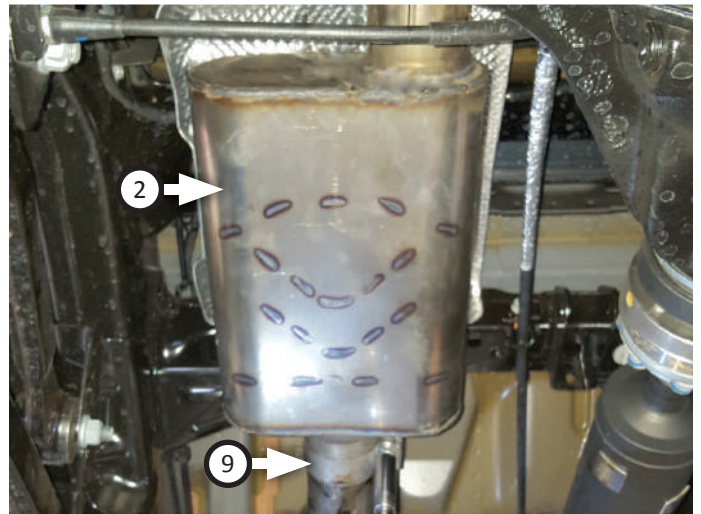

9. Route **y-pipe (3)** over rear axle and connect it to muffler, simultaneously inserting wire hanger into isolator. Tighten clamp just enough to allow for later adjustment.



10. Just behind passenger rear tire, unbolt wiring harness bracket. Retain bolts (x2) for later use. Place **clamp (8)** onto **right exit pipe (4)** and connect it to y-pipe right outlet but do not tighten clamp.

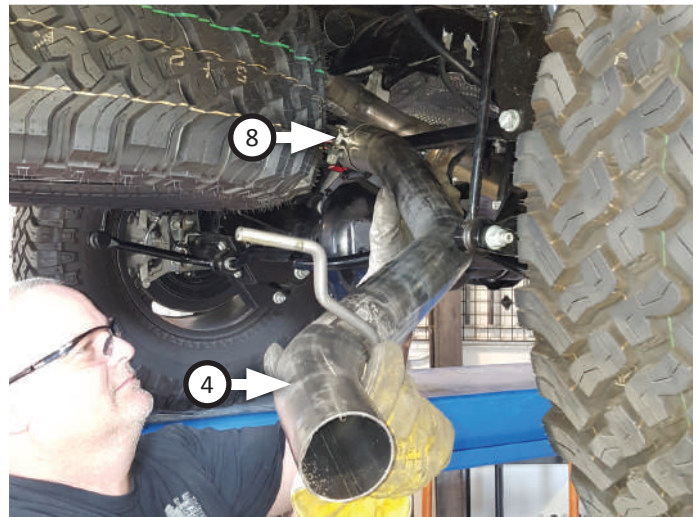

11. Insert **rear frame hanger (7)** onto right exit pipe then place it on passenger frame rail, aligned to holes. Install wiring harness bracket and bolts (x2) (from step 10) and tighten exit pipe clamp to allow for later adjustment.

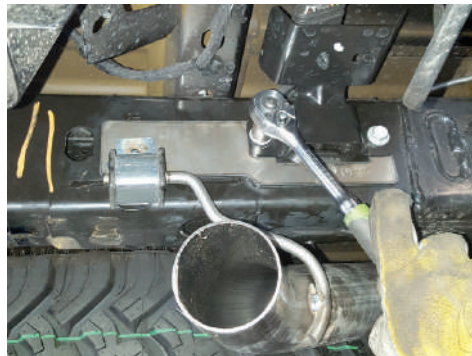
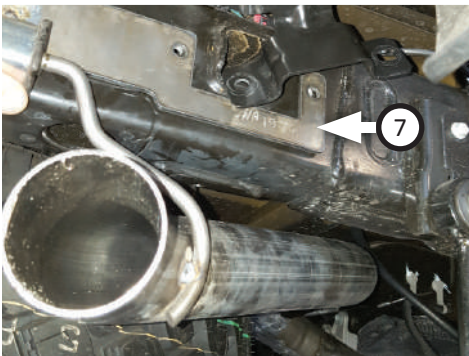

12. Place **clamp (8)** and rear hanger mount (removed step 3) onto **left exit pipe (5)** then connect it to y-pipe left outlet. Re-install rear hanger mount then tighten clamp just enough to allow for later adjustment.

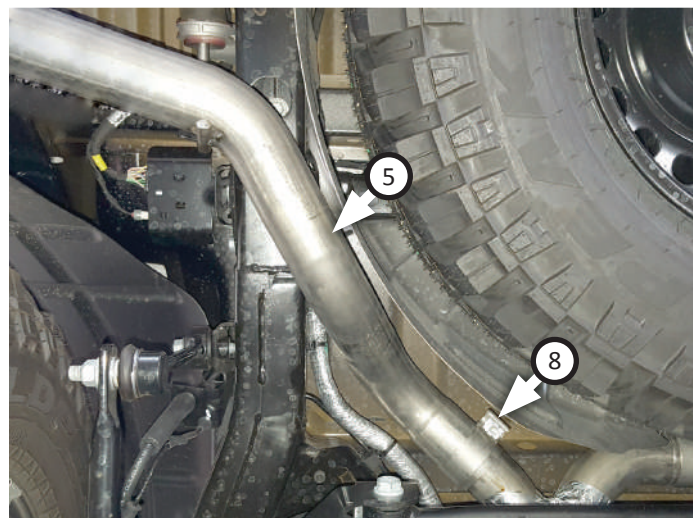

13. Place **tips (x2) (6)** onto side exit pipes and tighten inlets. Rotate exit pipes and tips to desired distance from body or bumper, so angle cut on tips are properly positioned.

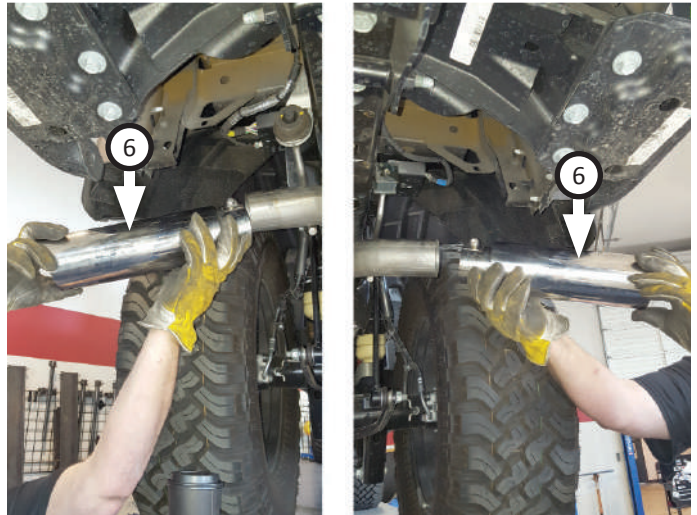

14. Adjust exhaust components for fit; maintaining ½" clearance and compensating for suspension, travel and vibration. Finally, tighten all clamps.
15. Recommended: Secure slip-fit connections with a 1-inch tack weld then spray high-temp paint over each weld to prevent rust and premature corrosion.



Congratulations, the installation of your FLOWMASTER performance exhaust system is now complete!





Installation Diagram
817913
2020 JEEP GLADIATOR TRUCK
3.6L ENGINE

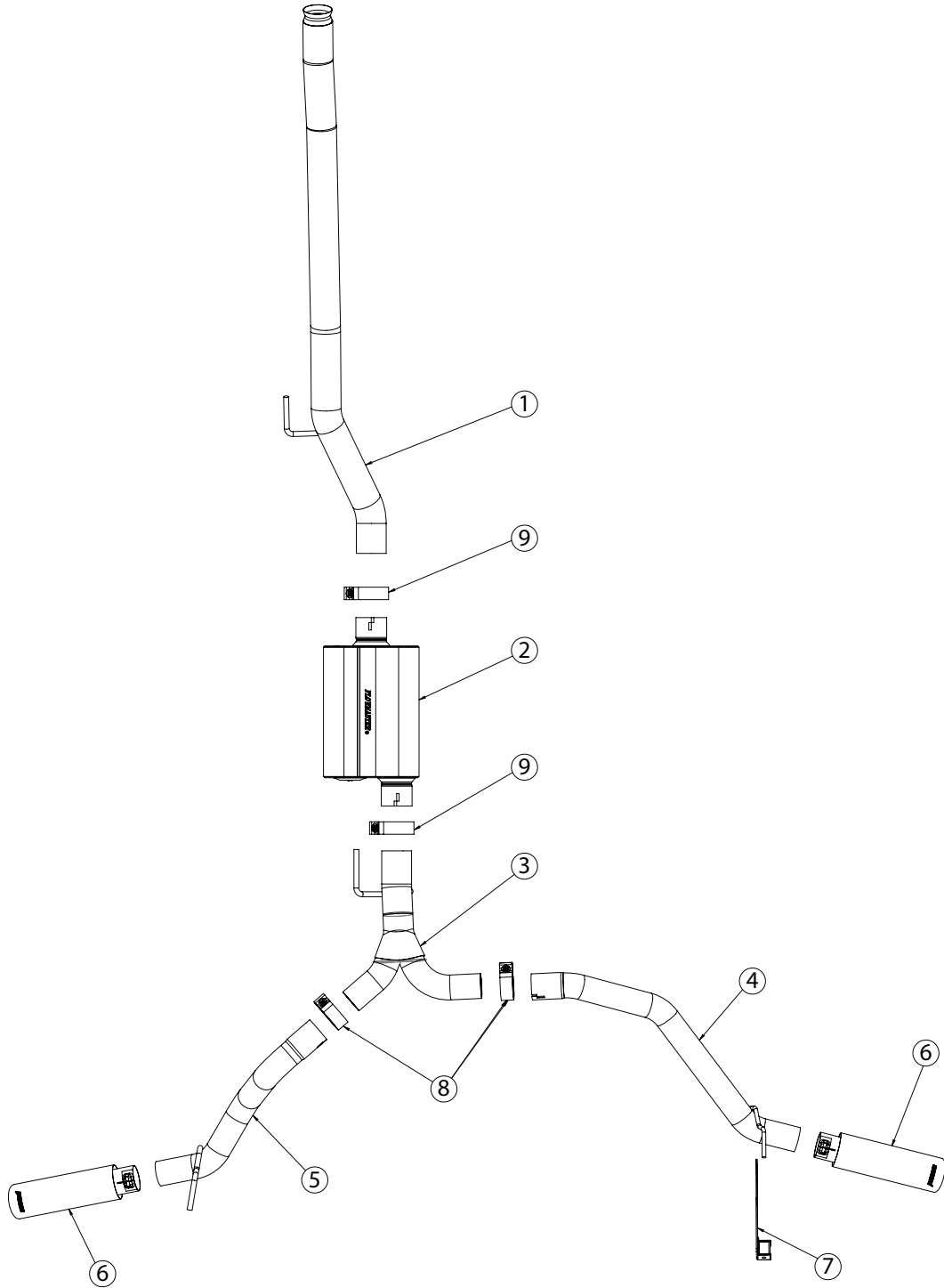

Learn more about performance exhaust systems we have.