

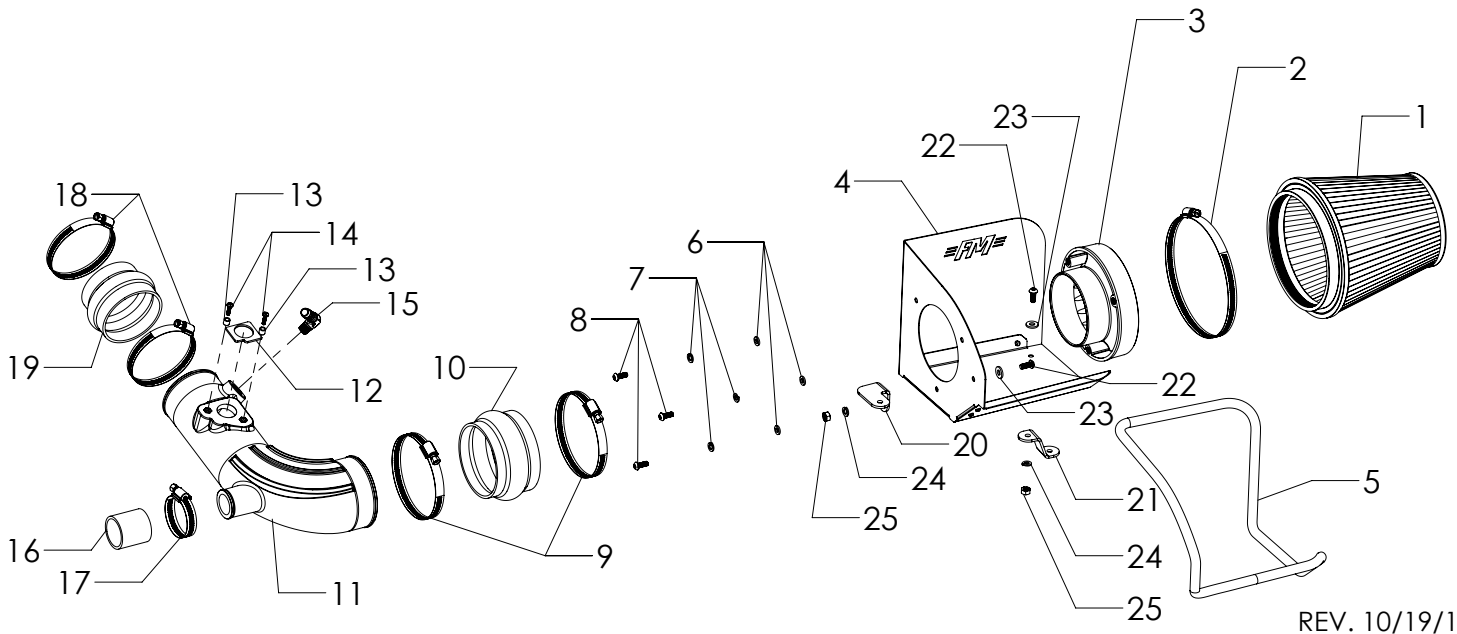

# Installation Instructions for: SYSTEM # 615163 2013-2017 Subaru BRZ & Scion FR-S, and Toyota 86, with 2.0L Engine

NOT LEGAL FOR SALE OR USE ON ANY POLLUTION-CONTROLLED MOTOR VEHICLE IN CALIFORNIA OR IN STATES THAT HAVE ADOPTED CALIFORNIA EMISSION PROCEDURES.



REV. 10/19/17

ITEM NO.	PART NUMBER	DESCRIPTION	QTY.
1	AF1002	AIR FILTER, 7-1/2" x 6" DIA	1
2		SCREW CLAMP, #104 (4-1/8" - 7")	1
3	AF6002	ADAPTER, AIR FILTER 4" x 6"	1
4	AF3043	HEAT SHIELD, 13-17 SUBARU BRZ, SCION FR-S, TOYOTA 86, 2.0L	1
5	49000061	GASKET, HEAT SHIELD	48"
6	HW319	FLAT WASHER, M6	3
7	HW318	LOCK WASHER, M6	3
8	HW244	SCREW, M6 x 1.0 x 16MM	3
9	MC400H	SCREW CLAMP, #64 (3-9/16" - 4-1/2")	2
10	AF4009	COUPLER, FLEX 4" - 3-1/2" I.D. x 2-1/2" L	1
11	AF2043	INTAKE TUBE, 13-17 SUBARU BRZ, SCION FR-S, TOYOTA 86, 2.0L	1
12	GA145	GASKET, MAF SENSOR, 13-17 SUBARU BRZ, SCION FR-S, TOYOTA 86, 2.0L	1
13	HW522	SPACER, SS, 5/16" O.D. x 3/16" I.D. x 9/32" L	2

ITEM NO.	PART NUMBER	DESCRIPTION	QTY.
14	HW259	SCREW, M4 x 0.7 x 16MM	2
15	AF4012	ELBOW, 90°, 3/4" BARB TO 1/4" NPT MALE	1
16	AF4058	COUPLER, STRAIGHT 1-1/2" I.D. x 1-3/4" L	1
17	MC150H	SCREW CLAMP, #28 (1-1/4" - 2-1/4")	1
18	MC314H	SCREW CLAMP, #52 (2-13/16" - 3-3/4")	2
19	AF4056	COUPLER, FLEX 3" I.D. - 3-1/4" I.D. x 2-1/2" L	1
20	AF5044	BRACKET 1, 13-17 SUBARU BRZ, SCION FR-S, TOYOTA 86, 2.0L	1
21	AF5045	BRACKET 2, 13-17 SUBARU BRZ, SCION FR-S, TOYOTA 86, 2.0L	1
22	HW245	SCREW, 1/4"-20 x 5/8"	2
23	HW320	FLAT WASHER, 1/4"	2
24	HW322	LOCK WASHER, 1/4"	2
25	HW115	NUT, 1/4"-20	2

## REVIEW THE INSTRUCTIONS AND VERIFY THE KIT CONTENTS:

1. Please take a moment to read and understand these instructions before installing your Flowmaster cold air intake kit.



2. Use the parts drawing and list (front page) to verify your kit's contents.

In the unlikely event that any parts are missing, please contact Flowmaster Technical Support for replacements.

To simplify assembly and avoid cross-threading fasteners, identify and separate the ¼-20 screws, (item 22) (used with nuts (25)), and the M6 screws (8) (used with filter adapter (3)).

## REMOVE THE FACTORY AIR INTAKE SYSTEM:

### NOTES

- We highly recommend that you retain all factory air intake system parts.
- Please refer to vehicle manufacturer's recommendations regarding removal of factory components.
- Disconnecting the negative battery cable erases pre-programmed electronic memories. Write down all memory settings before disconnecting the negative battery cable. Some radios will require an anti-theft code to be entered after the battery is reconnected. The anti-theft code is typically supplied with your owner's manual. In the event your vehicle's anti-theft code cannot be recovered, contact an authorized dealership to obtain your vehicle's anti-theft code.

3. Turn off the vehicle's ignition and disconnect the negative battery cable.

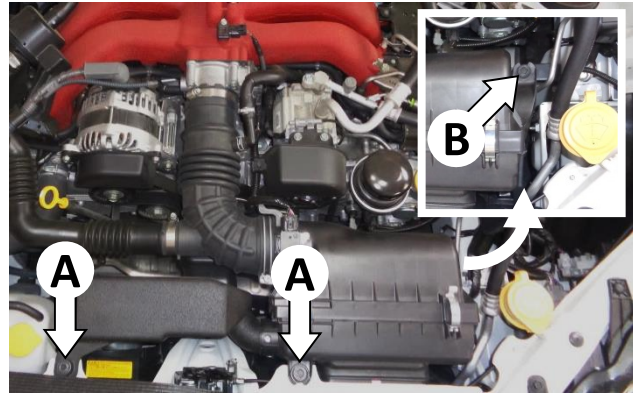

4. Remove the three intake system mount bolts – two upper bolts (A) and one lower bolt (B) – and retain for later use.

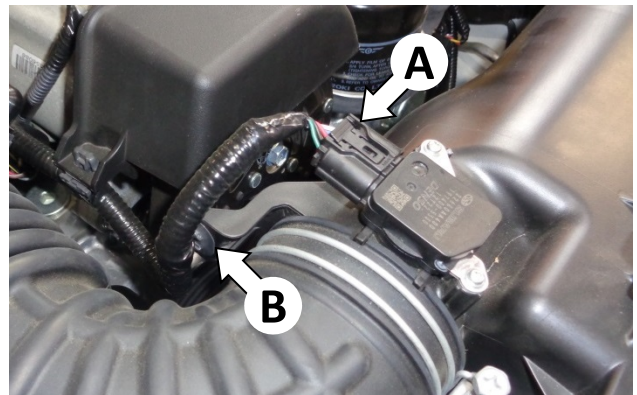

5. Disconnect the electrical plug (A) from the Mass Airflow (MAF) sensor by depressing the locking tab and pulling the plug straight off. Then disconnect the wire loom clip from the bracket (B).

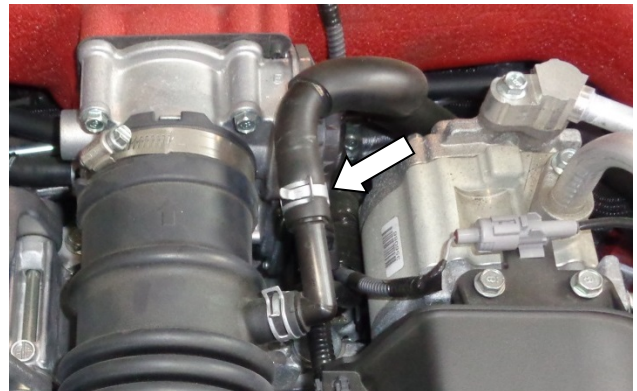

6. Move the pinch clamp on the breather tube back, then pull the tube straight back off the elbow.

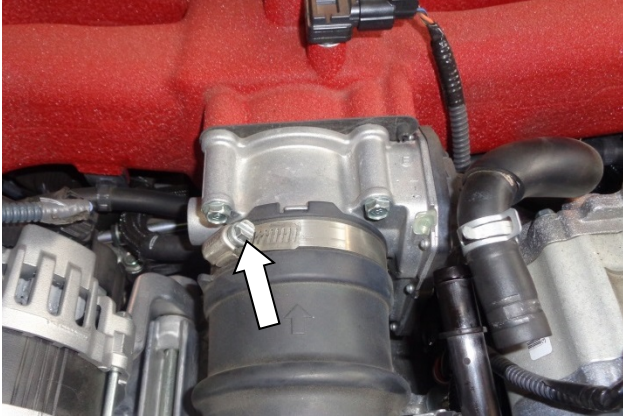

7. Loosen the screw clamp securing the intake duct to the throttle body.



8. Loosen the screw clamp securing the intake duct to the resonator tube, then pull the tube out of the duct.



9. Separate the intake duct from the throttle body, then remove the assembled duct and airbox from the vehicle.

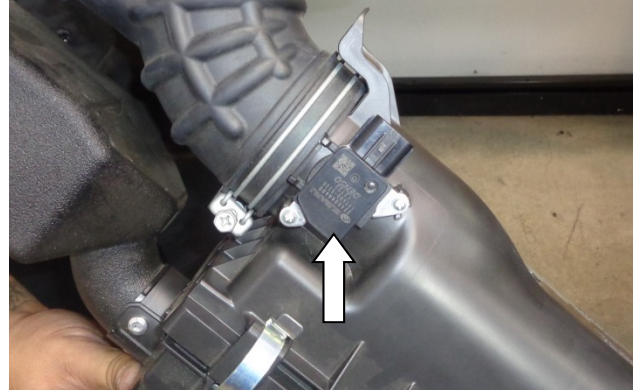

10. Remove the MAF sensor from the airbox, then remove the o-ring from the sensor. **CAUTION: The sensor is delicate!** Handle it with care, and keep it in a safe location until reinstallation.

### ASSEMBLE AND INSTALL YOUR FLOWMASTER COLD AIR INTAKE SYSTEM:

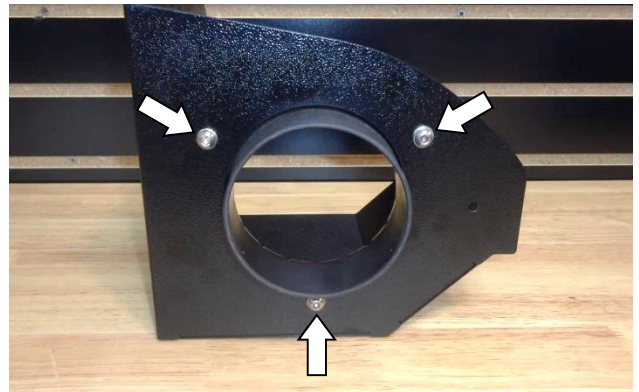

11. Assemble the air filter adapter (3) to the heat shield (4) using the M6 screws (8), lock washers (7) and flat washers (6).

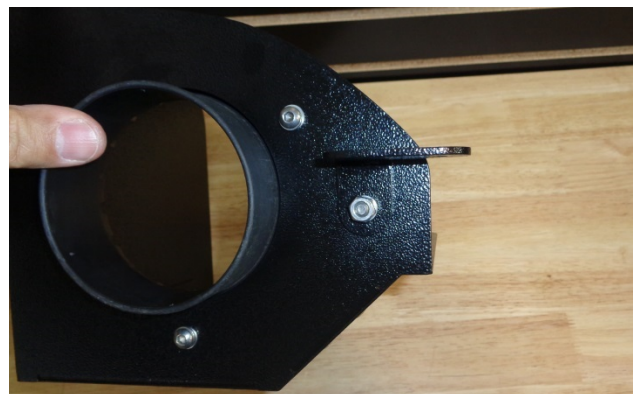

12. Attach bracket (20) to the heat shield using a ¼-20 screw (22) and flat washer (23) (against the heat shield), and lock washer (24) and nut (25) (against the bracket). **Do not tighten the bracket fasteners at this time.**



13. Attach bracket (21) to the heat shield using a ¼-20 screw (22) and flat washer (23) (against the bracket), and lock washer (24) and nut (25) (against the heat shield). **Do not tighten the bracket fasteners at this time.**



14. Starting at the corner shown, firmly press the gasket (5) onto the edge of the heat shield, gradually working your way around. When you return to the starting point, use metal-cutting shears to trim the gasket to length.



15. Place the MAF sensor gasket (12) on the intake tube (11), aligning the notches to ensure correct orientation. Then assemble the sensor to the tube using the M4 screws (14) and spacers (13).



16. Apply 2 wraps of nylon thread tape to the threads of the 1/2" barbed elbow (15), and install it in the intake tube. **Do not overtighten; final alignment will be performed at Step 27.**



17. Install the two large screw clamps (9) on the large coupler (10), and install the small end of the coupler on the filter end of the intake tube. Snug (but do not yet tighten) just the clamp on the tube; leave the other clamp loose.



18. Install the two medium screw clamps (18) on the medium coupler (19), and install the large end of the coupler on the other end of the tube. Snug (but do not yet tighten) just the clamp on the tube; leave the other clamp loose.



19. Push the small coupler (16) all the way onto the intake tube resonator port.

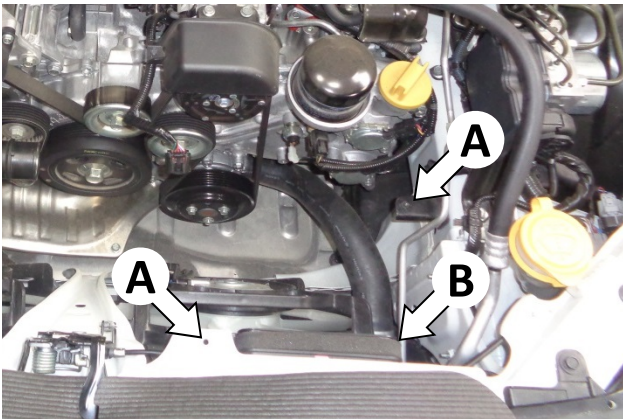

20. Before installing the heat shield in the vehicle, identify the two heat shield mount points (A), and note the stock air intake port (B).

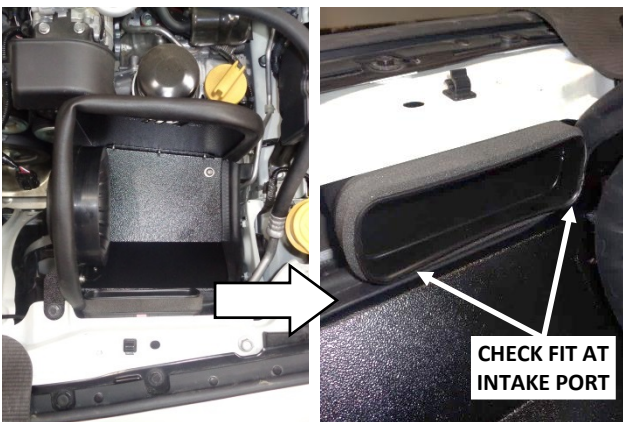

21. Carefully place the assembled heat shield in the vehicle. Ensure that the gasket fits along the bottom and the side of the vehicle's air intake port.

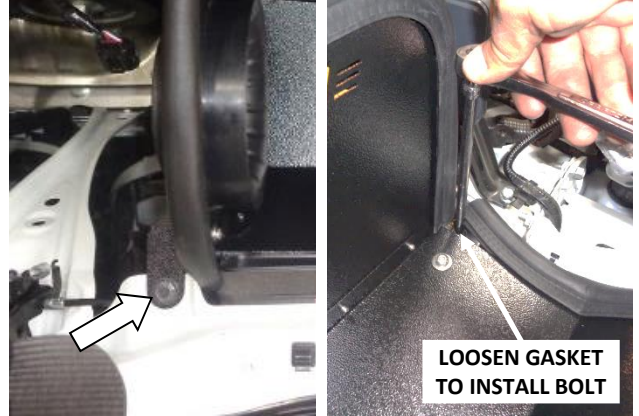

22. Fasten the heat shield to the vehicle using two of the stock mount bolts removed at Step 4. **NOTE: Temporarily loosen a short length of gasket to install the lower bolt.** After tightening the mount bolts, tighten the brackets to the heat shield.



23. Install the assembled intake tube in the vehicle.

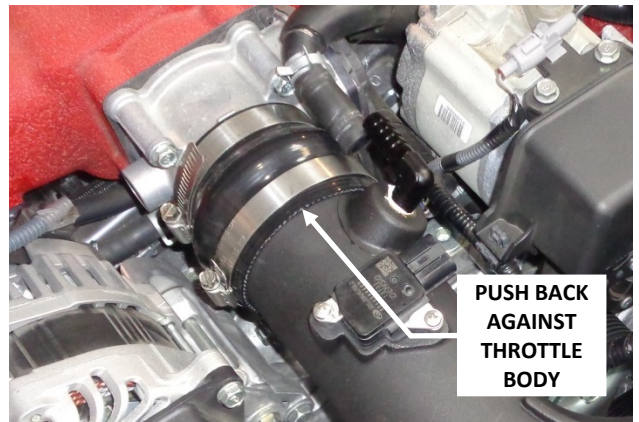

24. Push the rear coupler back against the stops on the throttle body, and tighten only the throttle body clamp.

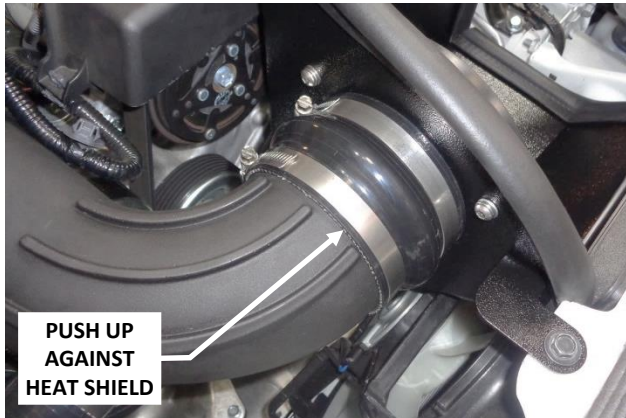

25. Push the front coupler flush against the heat shield, and tighten only the filter adapter clamp.



26. Center the intake tube between the couplers (so that there is roughly an equal length of tube inside each coupler), and tighten the two intake tube clamps.



27. Align the barbed elbow with the breather tube, push the tube onto the elbow, and secure the tube with the pinch clamp.

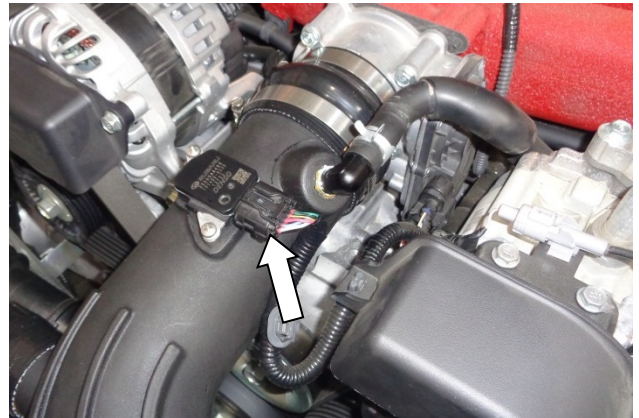

28. Push the MAF sensor plug onto the sensor until it clicks, then verify the connection is secure.

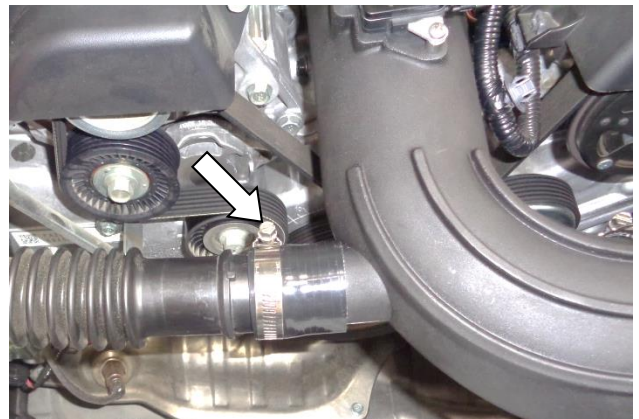

29. Install the small screw clamp (17) on the small coupler, push the resonator hose into the coupler, and tighten the clamp.



30. Slip screw clamp (2) onto air filter (1), install the filter on the filter adapter, and tighten the clamp.

**Congratulations, the installation of your FLOWMASTER cold air intake kit is now complete!**