

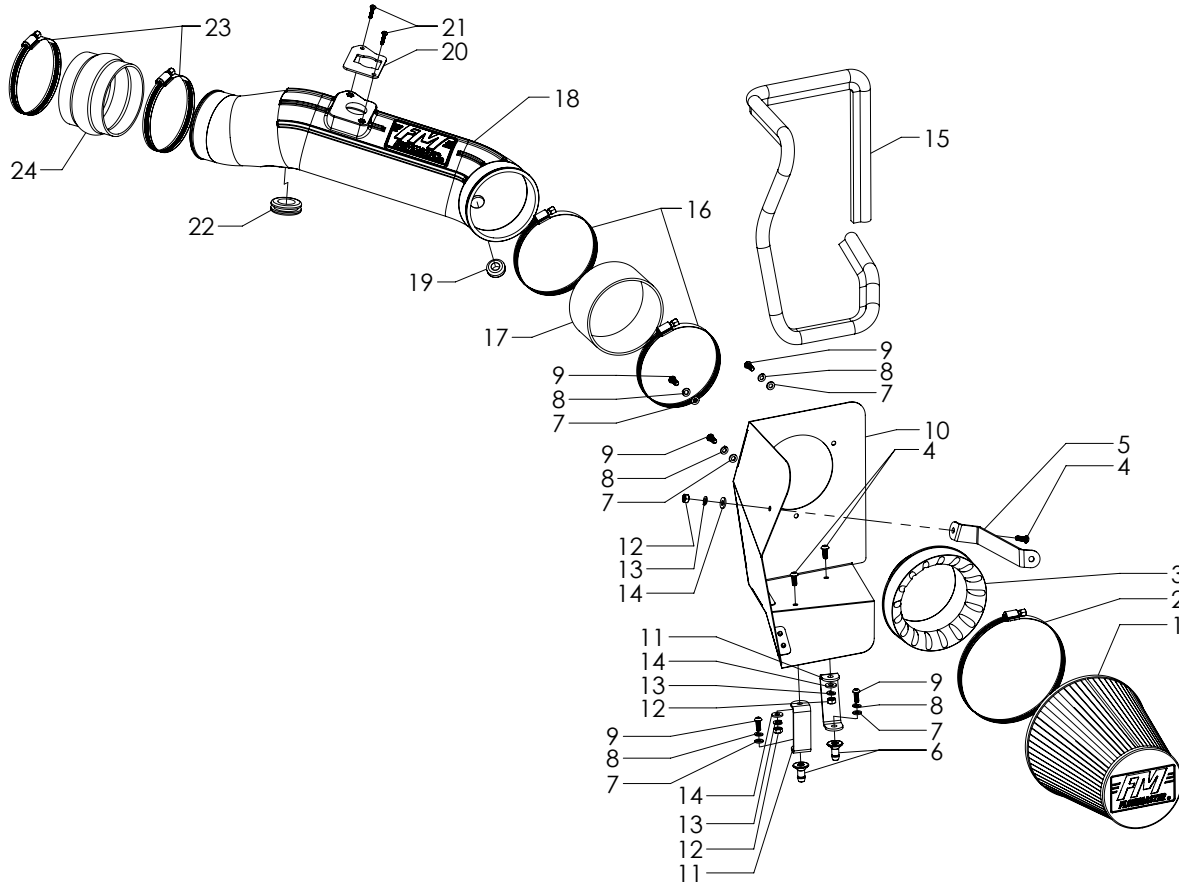

Installation Instructions for: SYSTEM # 615123

2003-2007 FORD F-250, F-350,
F-450, F-550 and EXCURSION
with 6.0L Diesel Engine

NOT LEGAL FOR SALE OR USE ON ANY POLLUTION-CONTROLLED
MOTOR VEHICLE IN CALIFORNIA OR IN STATES THAT HAVE
ADOPTED CALIFORNIA EMISSION PROCEDURES.



ITEM NO.	PART NUMBER	DESCRIPTION	QTY.
1	AF1001	AIR FILTER, 8-5/8" x 6" DIA	1
2		SCREW CLAMP, #104 (4-1/8" - 7")	1
3	AF6003	ADAPTER, AIR FILTER 4-1/2" x 6"	1
4	HW245	SCREW, 1/4"-20 x 5/8"	3
5	AF5055	BRACKET 1, 03-07, FORD TRUCKS, 6.0L DSL	1
6	AF7001	BARBED PIN, M6 x 1.0	2
7	HW319	FLAT WASHER, M6	5
8	HW318	LOCK WASHER, M6	5
9	HW244	SCREW, M6 x 1.0 x 16MM	5
10	AF3048	HEAT SHIELD, 03-07, FORD TRUCKS, 6.0L DSL	1
11	AF5070	BRACKET 2, 03-07, FORD TRUCKS, 6.0L DSL	2
12	HW115	NUT, 1/4"-20	3

ITEM NO.	PART NUMBER	DESCRIPTION	QTY.
13	HW322	LOCK WASHER, 1/4"	3
14	HW320	FLAT WASHER, 1/4"	3
15	49000061	GASKET, HEAT SHIELD	48"
16	MC450H	SCREW CLAMP, #72 (3" - 5")	2
17	AF4047	COUPLER, STRAIGHT 4-1/2" I.D. x 2" L	1
18	AF2048	INTAKE TUBE, 03-07, FORD TRUCKS, 6.0L DSL	1
19	AF4008	GROMMET, 1-1/16" OD x 1/2" ID x 3/16" THK	1
20	GA143	GASKET, MAF SENSOR, 03-07, FORD TRUCKS, 6.0L DSL	1
21	HW260	SCREW, M4 x 0.7 x 18MM	2
22	AF4064	GROMMET, 1-3/4" OD x 1" ID x 3/16" THK	1
23	MC400H	SCREW CLAMP, #64 (3-9/16" - 4-1/2")	2
24	AF4005	COUPLER, FLEX 4" I.D. x 3" L	1

REVIEW THE INSTRUCTIONS AND VERIFY THE KIT CONTENTS:

1. Please take a moment to read and understand these instructions before installing your Flowmaster performance air intake kit.



2. Use the parts drawing and list (front page) to verify your kit's contents.

In the unlikely event that any parts are missing, please contact Flowmaster Technical Support for replacements.

To simplify assembly and avoid cross-threading fasteners, identify and separate the ¼-20 screws (item 4) (used with nuts (12)), and the M6 screws (9) (used with filter adapter (3) and barbed pins (6)).

REMOVE THE FACTORY AIR INTAKE SYSTEM:

NOTES

- We highly recommend that you retain all factory air intake system parts.
- Please refer to vehicle manufacturer's recommendations regarding removal of factory components.
- Disconnecting the negative battery cable erases pre-programmed electronic memories. Write down all memory settings before disconnecting the negative battery cable. Some radios will require an anti-theft code to be entered after the battery is reconnected. The anti-theft code is typically supplied with your owner's manual. In the event your vehicle's anti-theft code cannot be recovered, contact an authorized dealership to obtain your vehicle's anti-theft code.

3. Turn off the vehicle's ignition and disconnect the negative battery cable. **Failure to disconnect the battery may cause the CHECK ENGINE light to illuminate after the air intake kit is installed.**

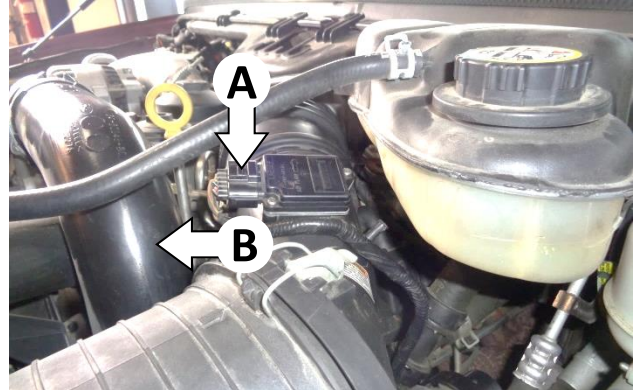

4. Disconnect the mass airflow (MAF) sensor plug by depressing the latch (A) and pulling the plug straight off the sensor (B).



5. Remove the MAF sensor plug from the duct. Then disconnect the hose at the coolant reservoir.



6. Loosen the screw clamp adjacent to the MAF sensor pad.

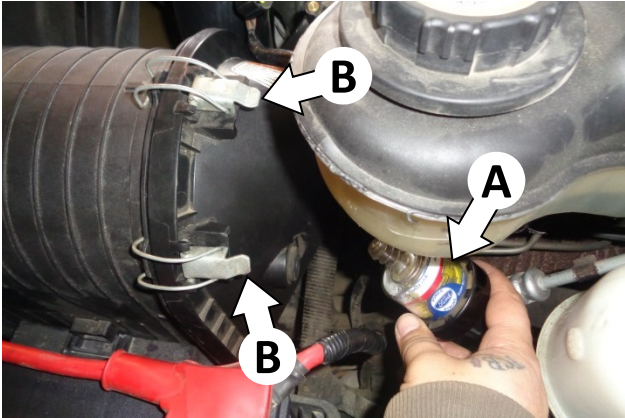

7. Carefully pull the flow gage (A) out of the air cleaner discharge duct and set it aside. Then release the 2 latches (B) at the back of the air cleaner.



8. Remove the air cleaner discharge duct from the vehicle.

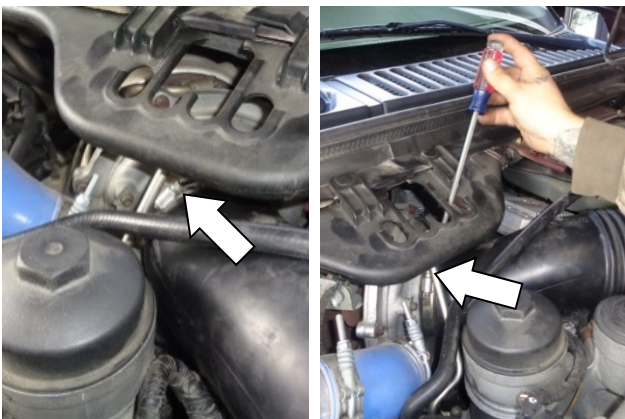

9. Loosen the screw clamp that secures the duct to the turbocharger inlet.

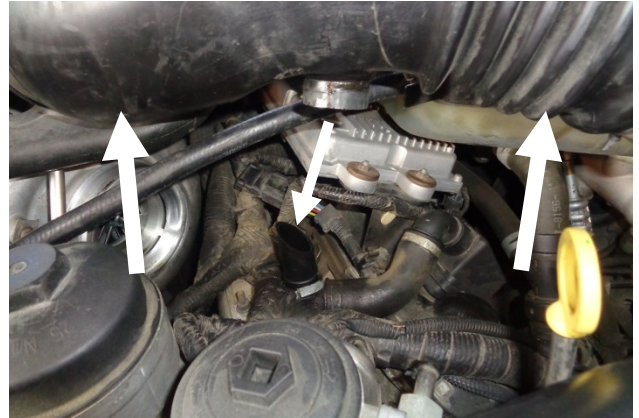

10. Separate the duct from the turbo inlet, then carefully lift the duct out of the vehicle while removing the PCV tube from the bottom of the duct.



11. Remove the air cleaner and inlet duct from the vehicle by firmly pulling straight up on the air cleaner.



12. Remove the bolt from the radiator core support and retain for use at Step 25.

ASSEMBLE AND INSTALL YOUR FLOWMASTER PERFORMANCE AIR INTAKE SYSTEM:

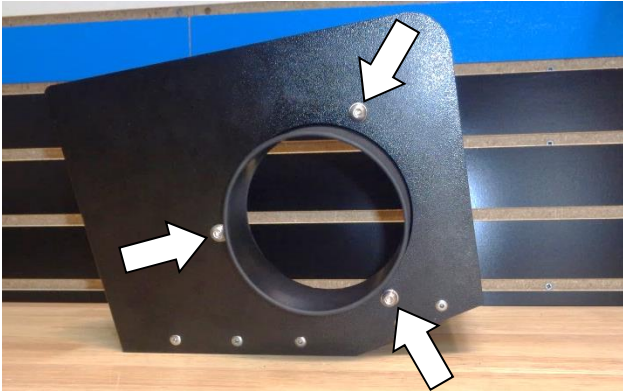

13. Assemble the air filter adapter (3) to the heat shield (10) using M6 screws (9), lock washers (8) and flat washers (7).

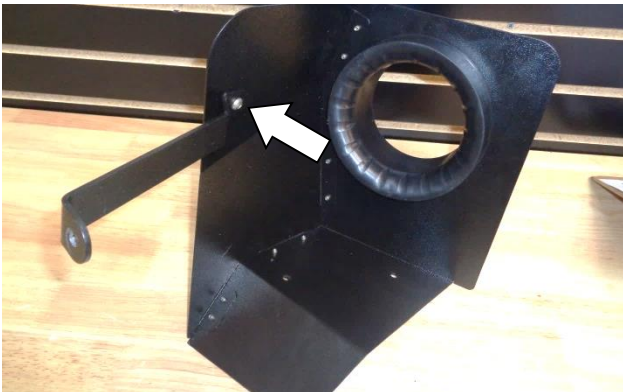

14. Attach bracket (5) to the heat shield using a ¼-20 screw (4) (on the bracket side), and a flat washer (14), lock washer (13) and nut (12) (on the heat shield side).

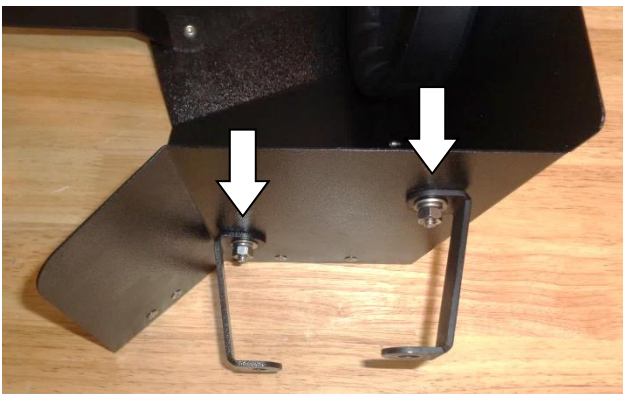

15. Attach brackets (11) to the heat shield using ¼-20 screws (4) (on the heat shield side), and flat washers (14), lock washers (13) and nuts (12) (on the bracket side).

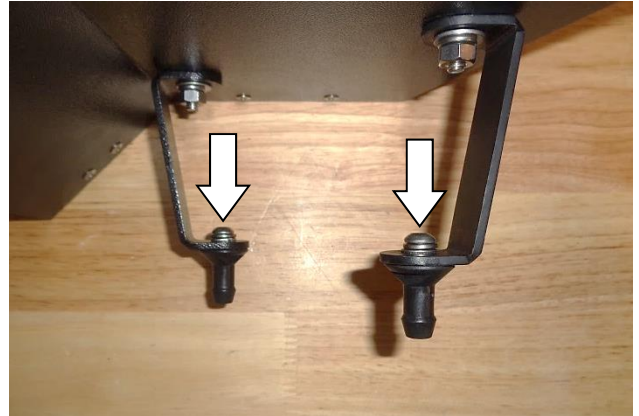

16. Attach barbed pins (6) to the brackets using M6 screws (9), lock washers (8) and flat washers (7).

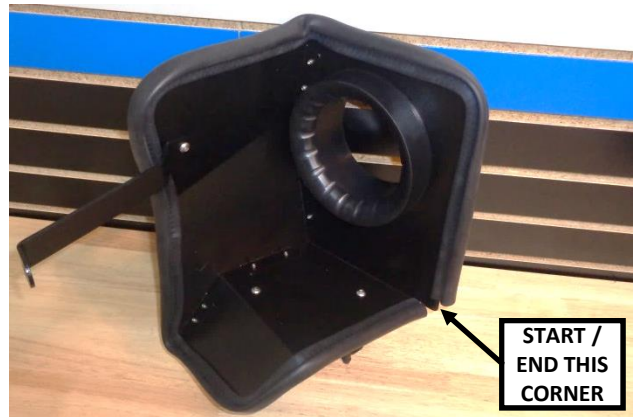

17. Attach the gasket (15) to the heat shield. Starting at the corner shown, firmly press the gasket onto the edge, gradually working around the heat shield. When you return to the starting corner, trim the gasket to fit using metal-cutting shears.



18. Insert the rubber grommets (22) and (19) in their holes in the intake tube (18). **Moistening the grommets with soapy water will ease insertion.**



19. Remove the o-ring from the MAF sensor, then install the sensor and gasket (20) on the intake tube using the M4 screws (21).



20. Install the two large screw clamps (16) on the straight coupler (17), and install the coupler on the large end of the intake tube. **Do not tighten the clamps at this time.**



21. Install the two small screw clamps (23) on the flex coupler (24) **with their screws oriented as shown**, and install the coupler on the small end of the intake tube. **Do not tighten the clamps at this time.**

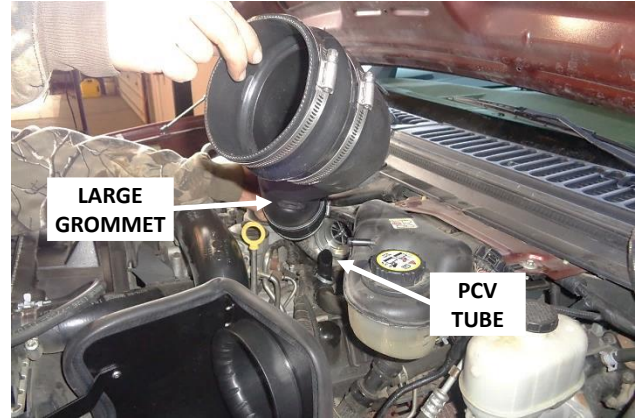

22. **Moistening the PCV tube with soapy water will ease its insertion in the next step.** Move the intake tube into position for installation, noting the locations of the large grommet and PCV tube.



23. Lower the intake tube into alignment with the turbo inlet and carefully work the PCV tube into the grommet.



24. Push the coupler onto the turbo inlet.

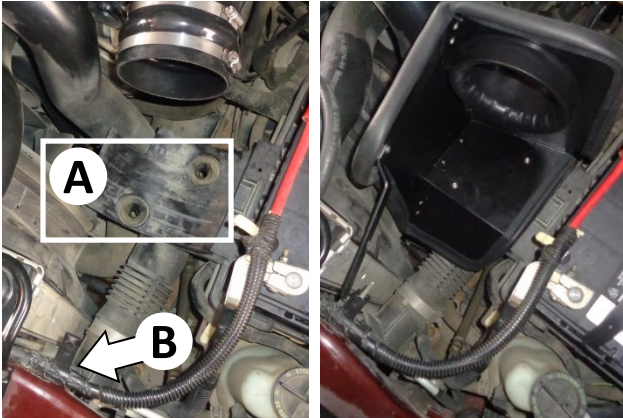

25. Note the locations of the two rubber mount grommets (A), and the bolt hole in the core support (B). Install the heat shield by pushing the two barbed pins into their grommets. Then install the bolt removed at **Step 12** through the bracket.

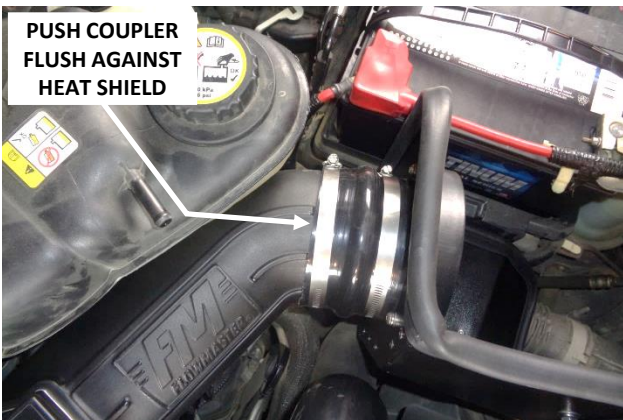

26. Push the front coupler up against the heat shield and tighten only the filter adapter clamp.



27. Push the rear coupler up against the turbo inlet and tighten only the turbo inlet clamp.



28. Center the intake tube between the couplers (so that roughly an equal amount of the tube is inside each coupler), and tighten the two remaining screw clamps.



29. Push the MAF sensor plug onto the sensor until the locking tab clicks, then check the plug for security.



30. **Moistening the tip of the flow gage with soapy water will ease its insertion.** Carefully push the flow gage into its grommet in the intake tube.

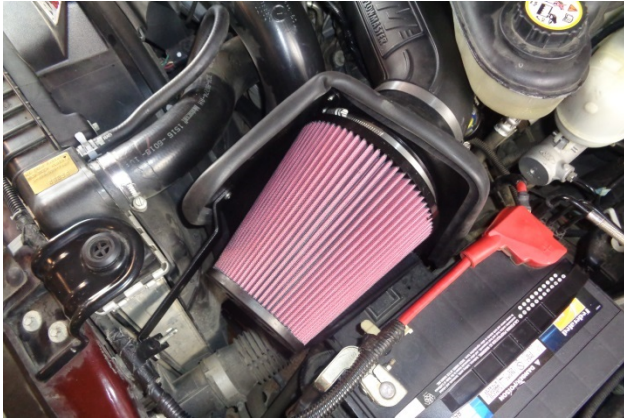

31. Place clamp (2) on air filter (1), install the filter on the filter adapter, and tighten the clamp.



32. Reinstall the coolant overflow hose on the coolant reservoir.



Congratulations, the installation of your FLOWMASTER performance air intake kit is now complete!

