

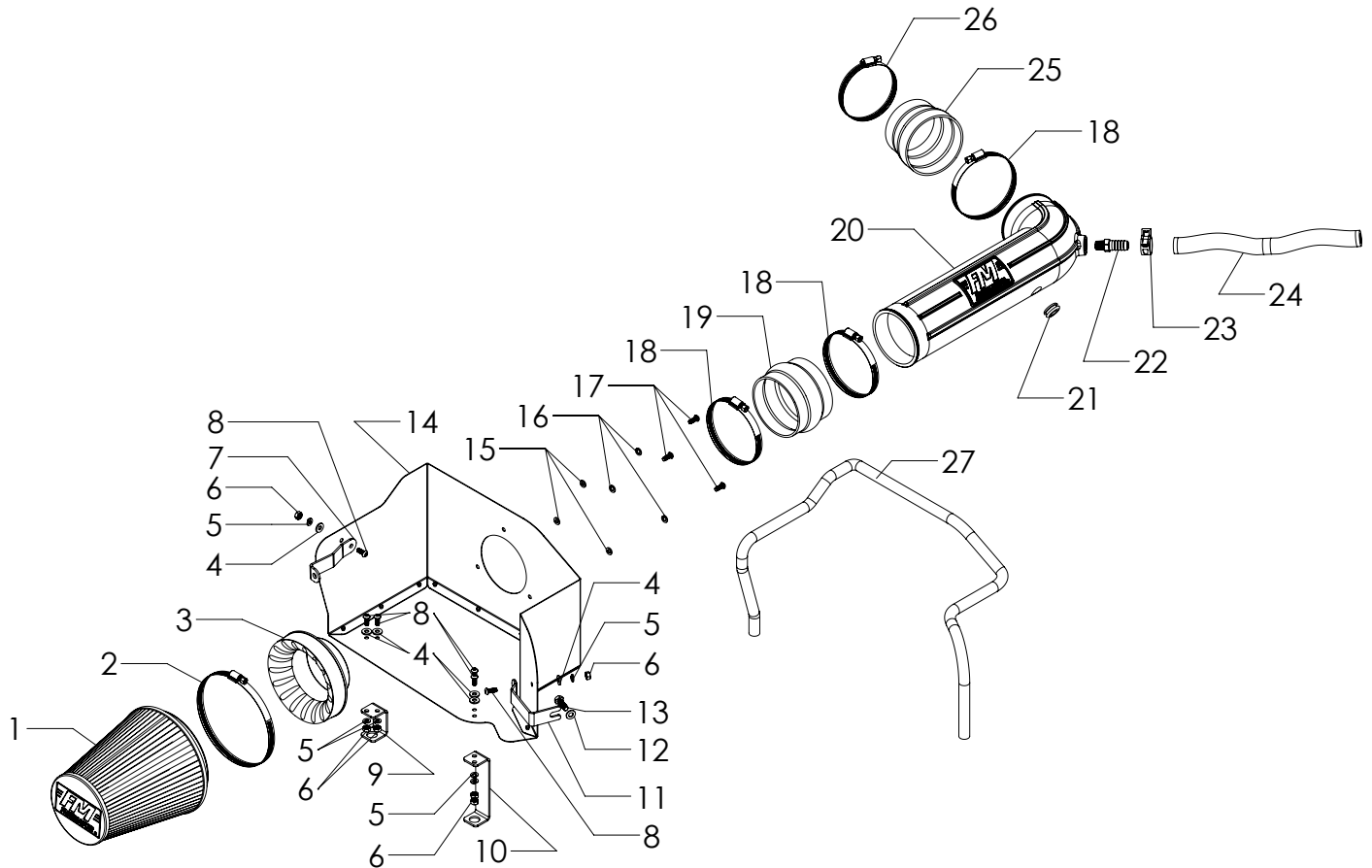

Installation Instructions for: SYSTEM # 615110

2003-2008 Dodge Ram 1500, 2500
and 3500 w/5.7L Engine

NOT LEGAL FOR SALE OR USE ON ANY POLLUTION-CONTROLLED
MOTOR VEHICLE IN CALIFORNIA OR IN STATES THAT HAVE ADOPTED
CALIFORNIA EMISSION PROCEDURES.



ITEM NO.	PART NUMBER	DESCRIPTION	QTY.
1	AF1001	AIR FILTER, 8-5/8" x 6" DIA	1
2		SCREW CLAMP, #104 (4-1/8" - 7")	1
3	AF6002	ADAPTER, AIR FILTER 4" x 6"	1
4	HW320	FLAT WASHER, 1/4"	6
5	HW322	LOCK WASHER, 1/4"	6
6	HW115	NUT, 1/4"-20	6
7	AF5074	BRACKET 3, 03-08, DODGE TRUCKS, 5.7L	1
8	HW245	SCREW, 1/4"-20 x 5/8"	6
9	AF5072	BRACKET 1, 03-08, DODGE TRUCKS, 5.7L	1
10	AF5073	BRACKET 2, 03-08, DODGE TRUCKS, 5.7L	1
11	AF5075	BRACKET 4, 03-08, DODGE TRUCKS, 5.7L	1
12	HW324	FLAT WASHER, M8	1
13	HW264	SCREW, M8 x 1.25 x 25MM	1
14	AF3057	HEAT SHIELD, 03-08, DODGE RAM 1500, 2500 & 3500, 5.7L	1

ITEM NO.	PART NUMBER	DESCRIPTION	QTY.
15	HW319	FLAT WASHER, M6	3
16	HW318	LOCK WASHER, M6	3
17	HW244	SCREW, M6 x 1.0 x 16MM	3
18	MC400H	SCREW CLAMP, #64 (3-9/16" - 4-1/2")	3
19	AF4005	COUPLER, FLEX 4" I.D. x 3" L	1
20	AF2057	INTAKE TUBE, 03-08, DODGE RAM 1500, 2500 & 3500, 5.7L	1
21	AF4008	GROMMET, 1-1/16" OD x 1/2" ID x 3/16" THK	1
22	AF4032	FITTING, STRAIGHT 5/8" BARB TO 1/4" NPT MALE	1
23	MC005P	PINCH CLAMP, 3/4" HOSE	1
24	49000068	HOSE, 5/8" I.D.	18"
25	AF4062	COUPLER, REDUCING 4" - 3-1/2" I.D. x 3" L	1
26	MC350H	SCREW CLAMP, #56 (3-1/16" - 4")	1
27	49000061	GASKET, HEAT SHIELD	54"



7. Loosen the two resonator bolts. (Bolts are captured / not removable.)



8. Remove the resonator from the vehicle.



9. Remove the rubber gasket from the throttle body.



10. Disconnect the PCV hose from the base of the oil filler neck and remove the tube from the vehicle.

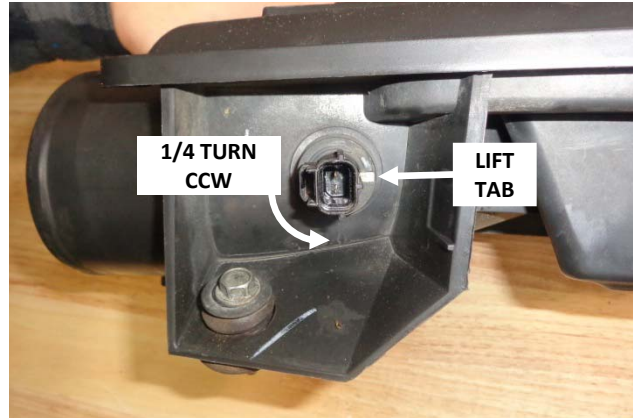

11. Remove the air temp sensor by lifting the locking tab and turning the sensor a quarter-turn counter-clockwise while pulling straight out. Then remove the o-ring from the sensor. **CAUTION: The sensor is delicate!** Handle it with care, and store it in a safe location until reinstallation.



12. Remove any two of the four rubber grommets from the bottom of the airbox, for use at **Step 18**.

ASSEMBLE AND INSTALL YOUR FLOWMASTER PERFORMANCE AIR INTAKE SYSTEM:

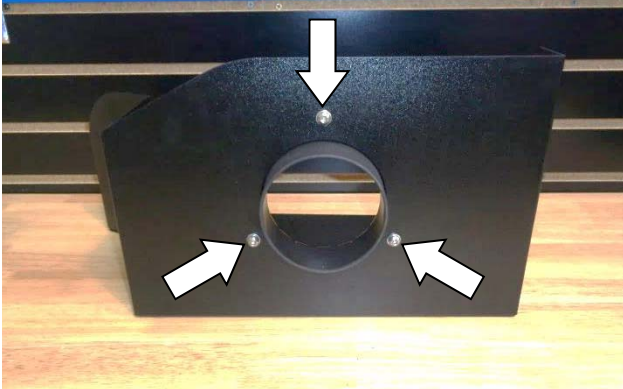

13. Assemble air filter adapter (3) to heat shield (14) using M6 screws (17), lock washers (16) and flat washers (15).

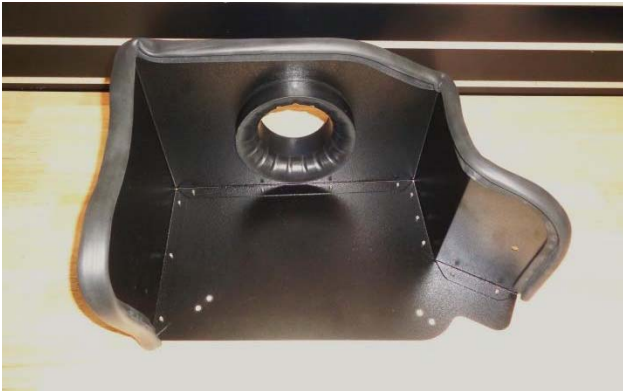

14. Attach the gasket (27) to the heat shield. Starting at one end, firmly press the gasket onto the edge, gradually working around the heat shield. When you reach the other end, trim the gasket to fit using metal-cutting shears.



15. Attach bracket (11) to the heat shield using a ¼-20 screw (8) (on the bracket side), and flat washer (4), lock washer (5) and nut (6) (on the heat shield side). **Do not fully tighten the fasteners at this time.**

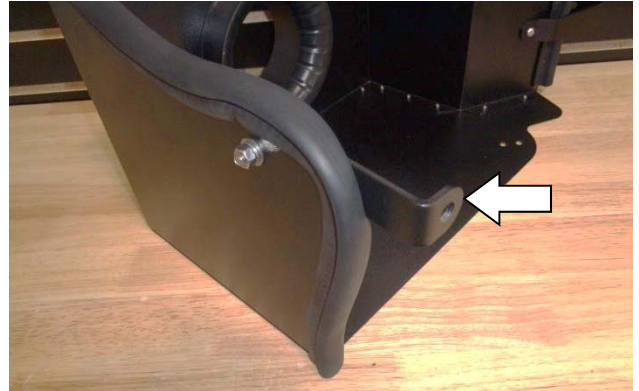

16. Attach bracket (7) to the heat shield using a ¼-20 screw (8) (on the bracket side), and flat washer (4), lock washer (5) and nut (6) (on the heat shield side). **Do not fully tighten the fasteners at this time.**

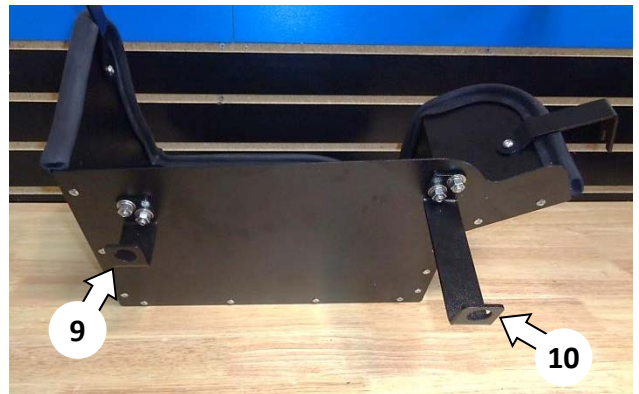

17. Attach brackets (9) and (10) to the heat shield as shown, using ¼-20 screws (8) and flat washers (4) (on the heat shield side), and lock washers (5) and nuts (6) (on the bracket side).

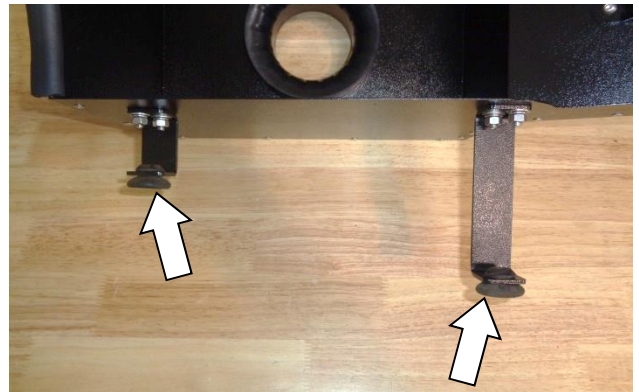

18. Push the two rubber grommets removed from the airbox at **Step 12** into the brackets as shown.



19. Apply 2 wraps of nylon thread tape to the 5/8" barbed fitting (22) and install it in the intake tube (20). Then insert the rubber grommet (21) into the tube. Moistening the grommet with soapy water will ease insertion.

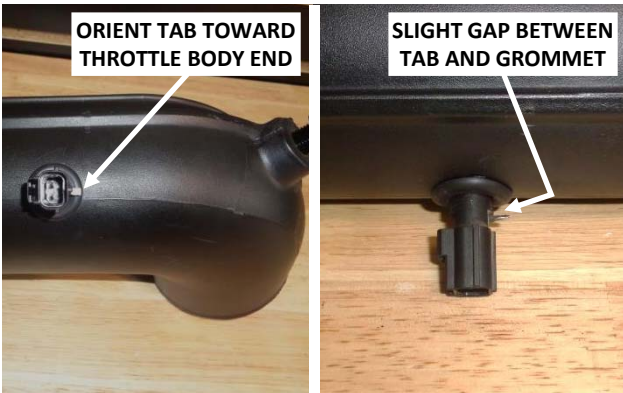

20. Carefully push the air temp sensor into the grommet, orienting the tab toward the throttle body end of the tube. Moistening the grommet I.D. with soapy water will ease insertion. **Note that the tab does not sit flush against the grommet (there will be a slight gap).**



21. Install two large screw clamps (18) on the 4" coupler (19), and install the coupler on the heat shield end of the intake tube. **Do not tighten clamps at this time.**



22. Install the other large screw clamp (18) and the small screw clamp (26) on the 4"-to-3" coupler (25). Then install the coupler on the throttle body end of the intake tube. **Do not tighten clamps at this time.**

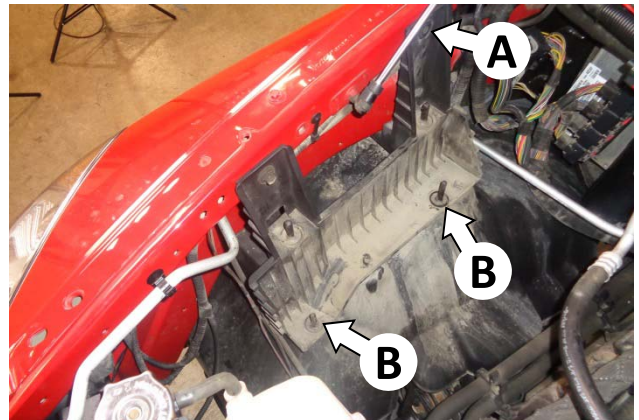

23. Remove the stock screw (A) at the rear of the airbox mount. Also note the location of the two lower airbox mount pins (B) for Step 25.



24. Remove the stock screw just below the radiator cap. Then install the M8 screw (13) with washer (12) only partially (approx. 2-3 turns) at this time.

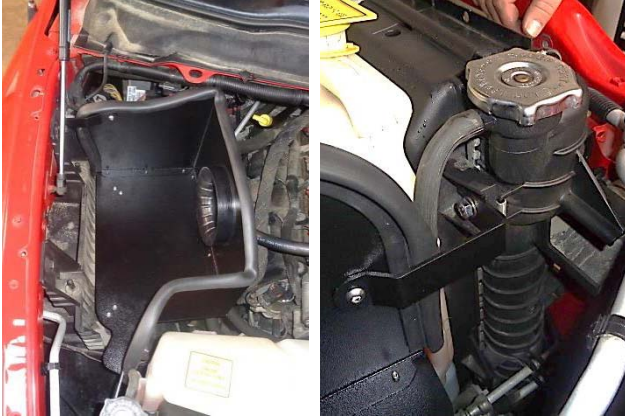

25. Install the heat shield in the vehicle by pressing the rubber grommets onto the two lower mount pins as identified at **Step 23**, while slipping the front bracket behind the screw and washer installed at **Step 24**. Then tighten the front bracket screw.



26. Fasten the rear bracket to the vehicle with the screw removed at **Step 23**. Then tighten the screws and nuts attaching the front and rear brackets to the heat shield.



27. Install the intake tube in the vehicle, but do not tighten any screw clamps yet.



28. Push the left coupler up against the heat shield and tighten only the filter adapter clamp.



29. Push the right coupler up against the throttle body and tighten only the throttle body clamp.



30. Center the intake tube between the couplers (so that there is roughly an equal amount of the tube inside each coupler), and tighten the two intake tube clamps.



31. Connect the air temp sensor plug to the sensor and check the plug for security.

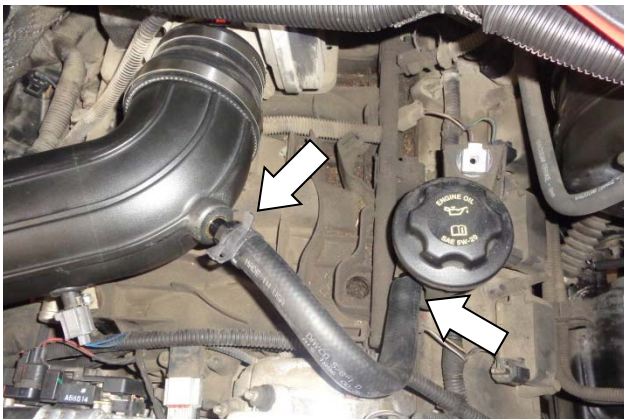

31. Push one end of the 5/8" I.D. hose (24) onto the PCV port at the base of the oil filler neck. Cut the hose to fit the barbed fitting in the intake tube, and secure it to the fitting using the pinch clamp (23).



28. Place clamp (2) on air filter (1), install the filter on the filter adapter, and tighten the clamp.



Congratulations, the installation of your FLOWMASTER performance air intake kit is now complete!

