

**⚠ WARNING** This Quick Reference Guide is not substitute for reading the operator's manual. **To reduce the risk of injury or death, user must read and understand the operator's manual before using this product.** All pages references to the operator's manual.

**1 Unpack Generator:** Remove generator, accessories, inserts and literature from carton.

**2 Removal of shipping support.**

Before you can run your new generator, follow these simple instructions:

**The following items must be removed before running your new generator.** In order to protect your generator these items have been added to ensure safe delivery of your new generator.

**⚠ CAUTION**

**Failure to remove these items can result in damage to your generator, possible Personal injury and void your warranty.**

Refer to the following instructions and pictures to remove the attached engine support brackets (red) under the engine.

1. Before filling the engine oil, tip the generator back onto its recoil frame end as indicated in this picture. Place the generator on the flattened cardboard box or other protective surface.

2. Remove the indicated bolts and nuts from the red engine support brackets. You may use the appropriate wrenches provided.

3. You may discard this brackets, as it is no longer required for normal operation of your generator.

Your generator is now ready for use. Refer to your owner's manual for proper oil fill and startup instructions.

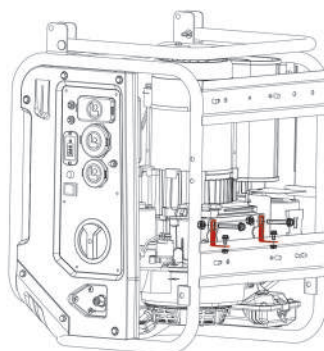

SUPPLIED WRENCHES

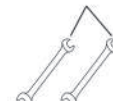

RED ENGINE SUPPORT BRACKET

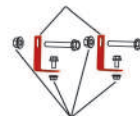

REMOVE THESE NUTS & BOLTS AS INDICATED.

**3 Install the wheel kit**

Slide the axle pin(A) through the wheel(B) and mount point on the frame and flat washer(D). Secure them with cotter pin(C).

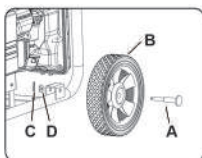

Attach the support leg (G) to the generator frame with flange bolt (E) (M8X16) and flange lock nut(F) (M8).

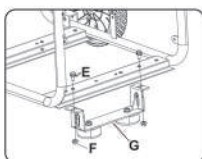

**Included Items**

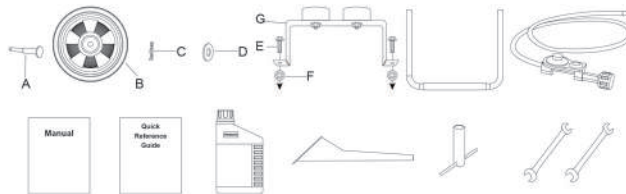

**4 Add Lubricant**

Use a funnel to pour provided engine oil into engine. Fill to the upper mark of the oil dipstick H.

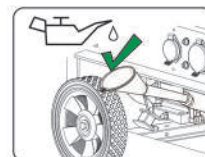

## 5 Battery Cable Connection

You will need to use 8mm box wrenches to connect the battery cables to battery.

NOTE: The generator comes equipped with the positive red cable (red boot) already attached.

1. Verify the positive (+) battery cable (red boot) is securely tightened to the positive (+) battery post. Make sure boot is over battery post
2. Remove bolt M5X10 and M5 nut from black cable ring
3. Remove vinyl cap from the negative(-) battery post. Locate negative (-) black cable and route to the negative(-) battery post. Tight the cable with bolt M5X10 and M5 nut. Cover the post with black boot

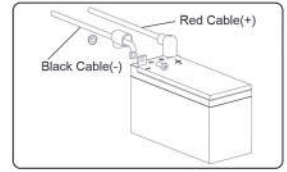
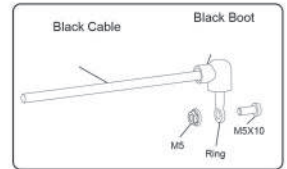

## 6 Add Fuel and Start Generator

Move generator outside to a flat, level surface, away from doors, windows and vents.

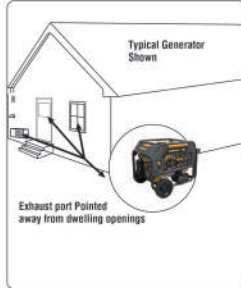

**WARNING** Do not overload generator or electrical cords. Consult operation manual.

### GAS



1. Use clean/fresh regular UNLEADED gasoline with a minimum 87 octane



2. Make sure the LPG cylinder knob is fully closed



3. Turn the fuel selector switch to GAS position

### LPG

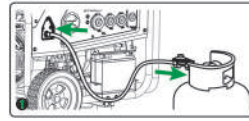

1. Connect the regulator to both LPG cylinder and generator.



2. Fully open the LPG cylinder knob



3. Turn the fuel selector switch to LPG position



4. Move choke lever located on engine to START position
5. Flip the engine switch to the START ( II ) position
6. Move choke lever to RUN position
7. Plug in items to be powered, using only grounded extension cords

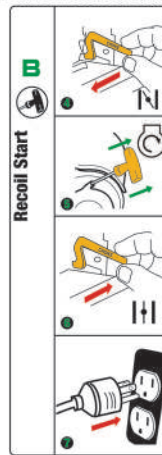

4. Move choke lever located on engine to START position
5. Pull cord starter to start engine
6. Move choke lever to RUN Position
7. Plug in items to be powered, using only grounded extension cords

## 7 Shutdown and Storage

### GAS



Remove any load from the generator



Turn the fuel selector switch to OFF (O) position

### LPG



Remove any load from the generator



Turn the fuel selector switch to OFF (O) position



Fully close the LPG cylinder knob

If generator is to be stored for longer than 30 days, refer to The operator's manual for further instruction.