



Installation Instructions



6" Performance Suspension System

2003-2008 Hummer H2 SUV & SUT

(with Rear Coil Spring Suspension)

2003-2005 Hummer H2 SUV

(with Rear Air Bag Suspension)



2003-2008 Hummer H2 SUV & SUT
 (with Rear Coil Spring Suspension)

2003-2005 Hummer H2 SUV
 (with Rear Air Bag Suspension)
 FTS27003BK / FTS27004BK

PARTS LIST

FTS27003		6" Kit Box 1
Qty	Part #	Description
1	FT20246D	Spindle -Driver
1	FT20246P	Spindle - Pass
2	FT20247	C.V. Spacer
1	FT20187BK	Skid Plate BK Only
1	FT20202BK	Tranny Guard Brk & T Skid
1	FT20164	Diff Bracket Pass.
1	FT20062	Diff Bracket Drv.
1	FT20196	Frnt.Sway Bar End Link Kit
1	FT20075	Weld In Plate
1	FT20386	Hdwr Sub-Assembly Kit
1	FT20190	Bushing Kit
1	FT20189	Hardware Kit
1	FT20192	Hardware Kit (rear)
1	FT20384BK	Track Bar Bracket
1	56123251081	9/16"-12 x 3-1/4 Hex bolt
4	56000005081	9/16" SAE Washer
2	56120004182	9/16"-12 C-lock Nut
1	56121251081	9/16"-12 x 1-1/4 Hex bolt
1	50131251081	1/2"-13 x 1-1/4 Hex bolt
2	50000005081	1/2" SAE Washer
1	50130004152	1/2"-13 C-lock Nut
2	FT1599-2-4	RR Sway Bar End Link
1	FT20197BK	Drv. Bump Stop
1	FT20198BK	Pass Bump Stop

FTS27004		6" Kit Box 2
Qty	Part #	Description
1	FT20156BK	Rear Crossmember
1	FT20157BK	Front Crossmember
1	FT20162BK	Torsion Bar Bracket drv
1	FT20191	Hardware Kit
1	FT20195BK	Torsion Bar Bracket pass
1	FT20203	Front C.V. Drive Shaft
1	FT20419	Hdwr Sub-Assembly Kit

FT20419		Hdwr Sub-Assembly Kit
Qty	Part #	Description
1	FT20200	Nut Tab Drv. Torsion Brk
1	FT20201	Nut Tab Pass. Torsion Brk

FT20386		Hdwr Sub-Assembly Kit
Qty	Part #	Description
2	FT20199	Nut Tab Rear Bump Stop
1	FT20098	Brake Line Tab
4	FT404739	12mm Sleeve
8	FT1004	Sway Bar Bushing
1	FT27003i	Instruction Sheet
2	FT55-1	Large Washer
1	FTAS12	Sticker
1	FTAS16	Driver Warning Decal

TOOL LIST: (NOT INCLUDED)

- FLOOR JACK & JACK STANDS
- ASSORTED METRIC AND S.A.E SOCKETS, & WRENCHES
- LARGE C CLAMP OR C CLAMP VISE GRIPS
- DIE GRINDER WITH CUTOFF WHEEL OR SAWZALL
- TORSION BAR REMOVAL TOOL
- TORQUE WRENCH
- MIG WELDER
- DRILL WITH A 5/16" BIT
- COIL SPRING COMPRESSOR (used on coil spring rear models only)



2003-2008 Hummer H2 SUV & SUT
 (with Rear Coil Spring Suspension)

2003-2005 Hummer H2 SUV
 (with Rear Air Bag Suspension
 FTS27003BK / FTS27004BK

HARDWARE LIST:

FT20703 Hardware Kit	
Qty	Description
2	5/8"-11 x 5 1/2" Bolt
2	5/8"-11 x4 1/2" Bolt
4	5/8"-11 Steel Lock Nut
8	5/8" SAE Flat Washer
2	3/8"-16 Nylok Nut
2	3/8" SAE Flat Washer
1	9/16-12 x 5" Bolt
2	9/16" SAE Flat Washer
1	9/16"-12 Steel Lock Nut
1	1/2"-13 x 3 1/2" Bolt
2	1/2" SAE Flat Washer
1	1/2"-13 Steel Lock Nut
1	1/2"-13 x 4 1/4" Bolt
5	10mm-1.5 x 60mm
5	10mm Flat Washer
1	Thread Locking Compound

FT20191 Hardware Kit	
Qty.	Description
12	10mm-1.5 x 40mm Bolt
12	10mm Flat Washer
2	3/8"-16 x 1" Bolt
4	3/8" SAE Flat Washer
2	3/8"-16 Nylok Nut
2	1/4"-20 x 3/4" Bolt
2	1/4" SAE Flat Washer
2	1/4" Split Washer
6	7/16"-14 x 1 1/4" Bolt
6	7/16-14 Nut
12	7/16" SAE Flat Washer
10	1/2"-13 x 1 1/2" Bolt
8	1/2"-13 Crown Lock
18	1/2" SAE Flat Washer
2	5/16"-18 x 3/4" Thread Forming Bolt

FT20703 cont. Hardware Kit	
Qty.	Description
2	12mm x 1.75 x 70mm
4	12mm Flat Washers
2	12mm x 1.75 Crown Lock
10	7/16"-14 x 1 1/4" Bolt
12	7/16" SAE Flat Washer
2	7/16"-14 Nylok Nut
2	5/16"-18 x 1" Bolt
1	9/16"-12 x 3 1/2" Bolt
2	9/16" SAE Flat Washer
1	9/16"-12 Steel Lock Nut
1	5/16"-18 x 1" Bolt
2	5/16" Split Washer
4	5/16" SAE Flat Washer
1	5/16"-18 Nylok Nut

BEFORE YOU BEGIN INSTALLATION PLEASE READ THE FOLLOWING:

READ ALL INSTRUCTIONS THOROUGHLY FROM START TO FINISH BEFORE BEGINNING INSTALLATION! IF THESE INSTRUCTIONS ARE NOT PROPERLY FOLLOWED, SEVERE FRAME, DRIVELINE AND / OR SUSPENSION DAMAGE MAY RESULT.

NOTE- THIS SUSPENSION SYSTEM REQUIRES WELDING FOR INSTALLATION. ALL WELDING MUST BE PERFORMED BY A CERTIFIED WELDER. ONLY WELD THE SINGLE COMPONENT CALLED OUT IN THESE INSTRUCTIONS. DO NOT WELD ANY OTHER COMPONENTS IN THIS SYSTEM.

NOTE- PRIOR TO THE INSTALLATION OF THIS SUSPENSION SYSTEM A FRONT END ALIGNMENT MUST BE PERFORMED AND RECORDED. DO NOT INSTALL THIS SYSTEM IF THE VEHICLE ALIGNMENT IS NOT WITHIN FACTORY SPECIFICATIONS. CHECK FOR FRAME AND SUSPENSION DAMAGE PRIOR TO INSTALLTION.

DO NOT ALTER THE FINISH OF THESE COMPONENTS, EXAMPLE- CHROMING, ZINC PLATING OR PAINTING. CHANGING THE FINISH CAN CAUSE STRUCTURAL FATIGUE OF COMPONENTS.

SUSPENSION SYSTEM MUST BE INSTALLED WITH FABTECH SHOCK ASBORBERS



2003-2008 Hummer H2 SUV & SUT
(with Rear Coil Spring Suspension)

2003-2005 Hummer H2 SUV
(with Rear Air Bag Suspension
FTS27003BK / FTS27004BK)

VEHICLES THAT WILL RECEIVE OVERSIZED TIRES SHOULD CHECK BALL JOINTS, TIE RODS ENDS AND IDLER ARM EVERY 2500-5000 MILES FOR WEAR AND REPLACE AS NEEDED

THE INSTALLATION OF THIS SUSPENSION SYSTEM SHOULD BE PERFORMED BY TWO PROFESSIONAL MECHANICS.

WITH THE INSTALLATION OF THIS KIT YOU MUST RUN A WHEEL WITH A 4 5/8" BACK SPACING.

FRONT SUSPENSION INSTRUCTIONS:

1. Disconnect the negative terminal on the battery. With the vehicle on level ground set the emergency brake and block the rear tires. Jack up the front end of the truck and support the frame rails with jack stands. **NEVER WORK UNDER AN UNSUPPORTED VEHICLE!** Remove the front tires.
2. Locate the torsion bar adjusting cams and threaded bolts. Measure exposed threads of torsion bar adjusting bolts and record for reinstallation. Mark torsion bars indicating driver and passenger. Using a torsion bar removal tool unload the torsion bars and remove the torsion bar adjusters. Retain the hardware for reinstallation. NOTE- Do not attempt to unload or remove torsion bars without the proper torsion bar tool. **Torsion Bars are under extreme spring load.**
3. Remove the sway bar link ends from the sway bar and lower control arm. Discard links and bushings.
4. Remove the stock shocks and discard.
5. Remove the stock lower rubber bump stops from the frame and discard.
6. Remove the front factory differential skid plate and splash shield and discard. Remove the factory transmission guard and save. Retain the hardware for the transmission guard.
7. Disconnect the tie rod ends from the steering knuckle by loosening the nut and striking the knuckle to dislodge the

tie rod end. Use care not to damage the tie rod end when removing. SEE PHOTO NEXT COLUMN.



8. Remove the brake hose bracket from the top of the steering knuckle. Unplug the ABS wire connection from the frame and control arm. Remove the caliper from the rotor and place above the upper control arm during this portion of the installation.
9. Remove the brake rotor from the steering knuckle. Remove the axle nut, washer, and the 4 hub bolts on the backside of knuckle. Remove the bearing hub assembly including O

ring from knuckle. Retain the parts and hardware for reinstallation.

10. Remove the upper and lower ball joint nuts. Disconnect the upper and lower ball joints from the steering knuckle by striking the knuckle with a large hammer next to each ball joint on the knuckle to dislodge the ball joints. Use care not to hit the ball joints when removing. Retain the nuts and discard knuckle. SEE PHOTO BELOW.



11. Disconnect the CV half shafts from differential housing and remove the axle assembly.
12. Remove the lower control arms from the frame along with the torsion bar and retain the arms, torsion bar, and hardware for reinstallation. SEE PHOTO BELOW.



13. Disconnect the front drive shaft from differential housing and transfer case, and retain the bolts and u joint clamps for reinstallation, discard drive shaft. **NOTE: A new C.V. drive shaft will be install later (included in this kit).**
14. Disconnect the differential housing electrical connection and vacuum line from the differential housing.
15. Remove the stock differential rear crossmember and discard. Remove the differential housing assembly from

vehicle. To ease removal, turn the steering wheel to the left for better centerlink clearance.

16. With the differential housing out of the truck locate the mounting bushing eye on the upper front side of the differential housing and mark the housing with a cut line smooth to the housing. Using a sawzall, cut the entire ear off the housing. Take care not to cut into the flat portion of the housing. SEE PHOTOS BELOW.



Before Cut



After Cut & Sanding Surface Smooth

17. Locate the C shaped Fabtech differential bracket FT20062 and install bushings and sleeve in bracket from Bushing Kit.
18. Place differential bracket to the differential housing and remove the appropriate 5 housing bolts. The bracket should be positioned with the bushing eye to the top side of the housing. Using the provided the 10mm x 1.5 x 60mm bolts and washers in the hardware kit attach the differential bracket to housing using thread lock compound and torque to 30 ft lbs. Note- Some leakage of the differential oil is normal during this process. Recheck and fill diff housing with oil once the differential is mounted in vehicle. SEE PHOTO NEXT PAGE.



Diff Housing Bracket

19. Locate the rear driver side lower control arm pocket, measure 1-3/4" from the backside of the pocket and mark a vertical cut line around entire pocket. Using a Sawzall or die grinder cut the backside of the pocket. SEE PHOTO BELOW.



View from the front of the truck looking back

20. With the back of the pocket now removed place the FT20075 plate against the frame and weld in place. Let the plate cool and paint with a corrosive resistant paint or undercoating. SEE PHOTO IN NEXT COLUMN.



21. Locate and install the Fabtech rear crossmember into the factory lower control arm pockets using the stock hardware with the nuts towards the rear of the truck. Leave loose
22. Locate the supplied large bushing halves and long sleeve from the bushing kit. Install into the differential mount on the rear crossmember.
23. Locate and install the Fabtech Passenger side Diff bracket FT20164 to the bottom of the factory frame mount. Attach using the supplied 1/2" x 3 1/2" bolt, nut, and washer. Torque to 70 ft lbs. SEE PHOTO BELOW.



24. Place the differential housing into the Fabtech rear crossmember using the supplied 1/2" x 4 1/2" bolt, nut, and washers along with the supplied large FT55-1 washers attach the differential. SEE PHOTO ON NEXT PAGE.



25. Attach the Fabtech front crossmember into the lower control arm pockets using the stock hardware.
26. Position the front differential urethane bushing mount into the front crossmember tabs. Locate and install the differential skid plate around the differential housing bushing using the supplied 9/16" x 5" bolt, nut, and washers. Using the supplied 3/8" x 1" bolt and washer attach the rear of the skid plate to the rear crossmember. Leave loose. **If installing the optional Fabtech Full Differential Skid Plate FTS9700BK do so at this time, and discard the supplied FT20187 skid plate.**
27. Reconnect the electrical connection and the vacuum line to the differential housing.
28. Install the lower control arms into the new crossmembers. Use the 5/8" x 4 1/2" (front crossmember) and 5/8" x 5 1/2" (rear crossmember) bolts, nuts, and washers from hardware kit. Leave loose.
29. Torque the following bolts - Driver side front and rear diff bushing bolts to 70 ft lbs, Passenger side diff bushing bolts to 70 lbs, Crossmember frame pocket bolts to 105 ft lbs, Control arm bolts to 105 lbs, Crossmember tab bolts to 25 ft lbs. Recheck all bolts on the front end for proper torque before proceeding to next step.
30. Locate the two bump stop mounts on the Fabtech rear crossmember and install one of the supplied low profile bump stops to each side of the crossmember. SEE PHOTO BELOW.

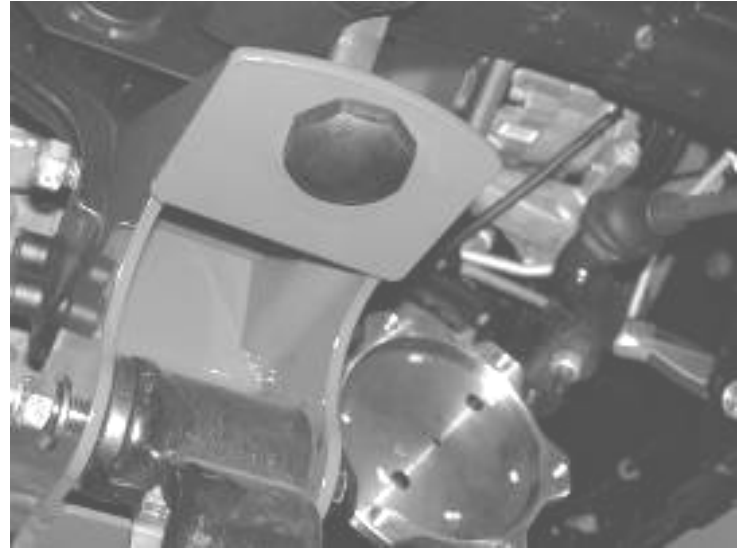

31. Locate the factory brake line mount on top of the upper control arm. Remove the brake line mount, and route the line with bracket to the bottom side of the control arm. Drill a guide hole directly below the original hole on the upper control arm. Mount the factory bracket to the bottom side of the control arm using the supplied 5/16 thread forming bolt. SEE PHOTO BELOW.



32. Locate the FTS20246D & P steering knuckle and install the stock hub bearing assembly taking care to place O ring in the proper position. Apply thread lock compound to the stock hardware torque the flange bolts to 130 lbs. SEE PHOTO ON NEXT PAGE.

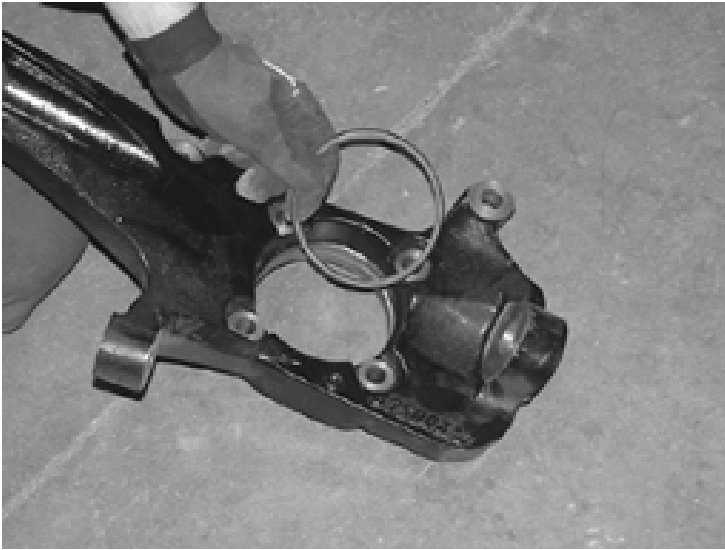

33. Working from the driver side of the truck, attach the steering knuckle FT20246D for the driver side to the upper control arm and to the lower control arm using the stock hardware. Torque the upper ball joint to 35 ft lbs and lower to 70 ft lbs.
34. Reinstall the C.V. half shaft through new knuckle and attach nut and washer. Locate and install the Fabtech CV spacers between the CV axle and the differential housing using 10mm x 40mm bolts and washers from Hardware kit with the provided thread lock compound and torque to 55 lbs. in a cross pattern. Torque axle nut to 150 lbs SEE PHOTO BELOW.



35. Install Fabtech shock part number FTS7191 (not included) using factory hardware. Torque the upper stem bushing to 15 ft lbs and the lower bolt to 35 ft lbs.
36. Reattach the tie rod end to the steering knuckle and torque to 65 ft lbs.
37. Reinstall the brake rotor and caliper. **Note: If your brake caliper cage has the boss shown below, it must be ground / sanded flush with the cage before mounting the calipers. SEE PHOTOS** Torque the caliper bolts to 70 ft lbs. Route the brake hose and ABS line to the steering

knuckle using the factory steel guide clamp to the rear side of the steering knuckle and attach with the 1/4" x 3/4" bolt and washer from Hardware kit. Torque to 5 ft lbs. Check to make sure that the brake hose and ABS line is routed as to allow full turning radius to the steering without the tire or suspension component contact at anytime. Use provided plastic tyraps to secure the line and hose to the upper control arm and knuckle away from the tire and wheel. SEE PHOTOS BELOW AND ON NEXT PAGE.

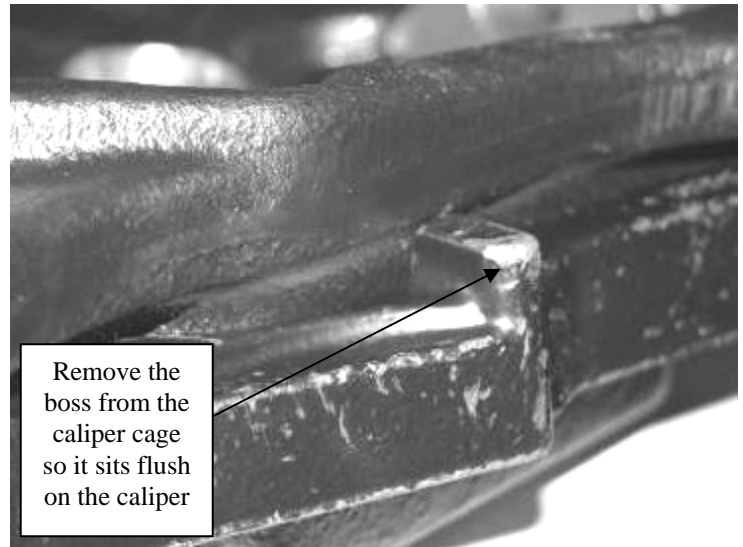

Remove the boss from the caliper cage so it sits flush on the caliper

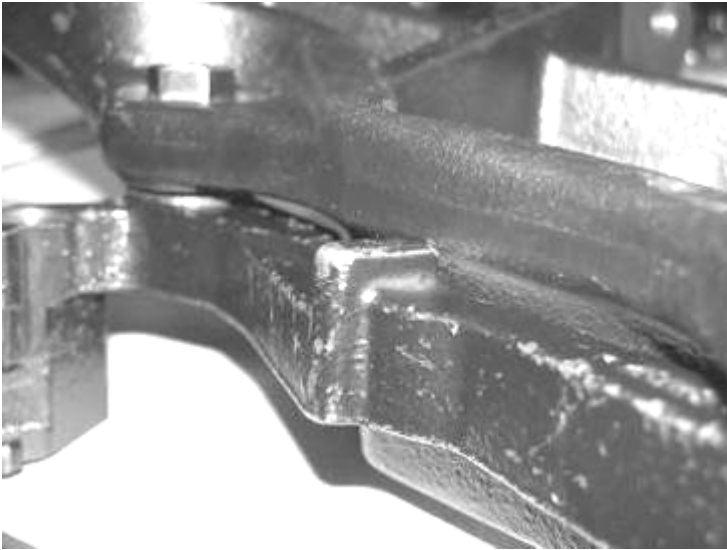

Photos show caliper cage and knuckle off of truck for photo only

38. Install the new C.V. drive shaft FT20203 to the differential yoke using the stock hardware and torque u joint straps to 19 ft lbs.
39. Repeat steps thirty three to thirty eight on the passenger side of the truck.
40. Remove the sway bar and flip it upside down and remount. Locate and install the Fabtech sway bar link ends and bushings Torque to 10 ft lbs. SEE PHOTO BELOW.

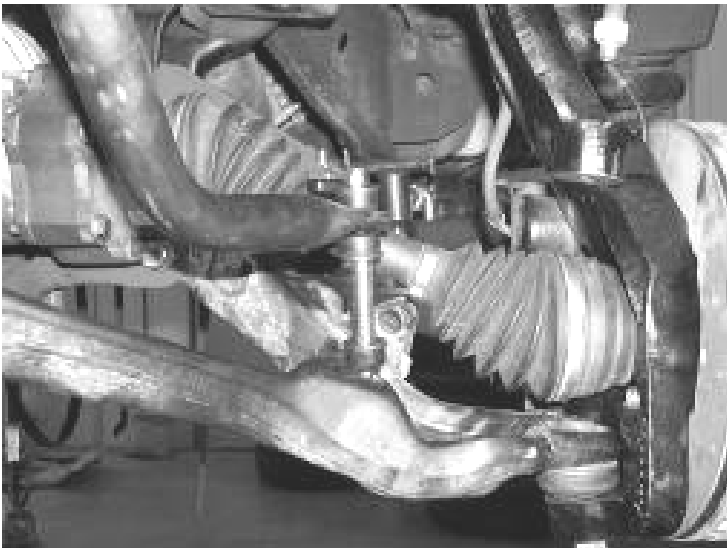

41. Locate the factory transfer case skid plate, remove and discard.
42. Locate the previously removed factory transmission guard, attach it to the three tabs on the rear Fabtech the crossmember using the supplied 7/16" bolts, nuts, and washers. Locate the supplied FT20202 transmission guard bracket and transfer case skid, attach to the two inner factory transmission crossmember bolts. Attach the rear section of the factory transmission guard to the FT20202 bracket using the supplied 7/16" bolts, nuts, and washers. SEE PHOTO IN NEXT COLUMN.

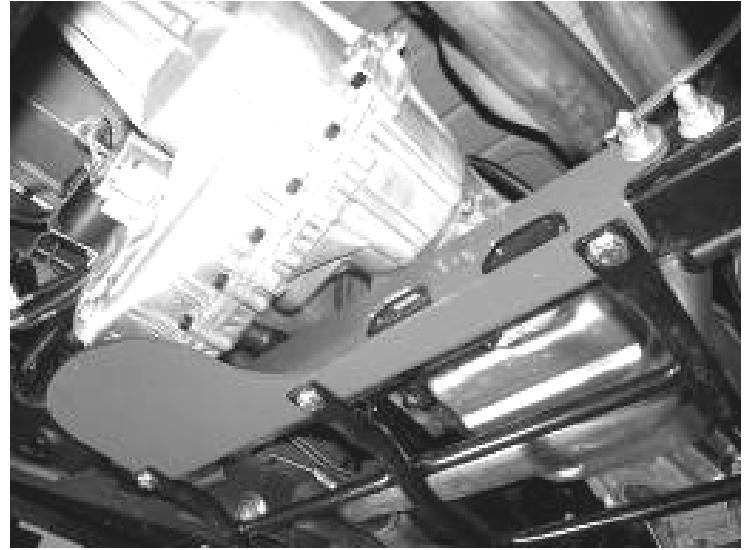

43. Recheck all bolts on the front end for proper torque before proceeding to next step.
44. Locate the torsion bar drop down mounts and install the bushings and sleeves. Placing the Fabtech mount with the bushing eye below the factory torsion bar bushing eye. You will use two existing holes on the bottom side of the frame and have to drill two additional holes. Using the supplied 1/2" x 1 1/4" bolts, nuts, and washers attach to the frame. Locate the single hole on the inner side on the Fabtech bracket. You will need to drill a 1/2" hole in the frame. Using the supplied FT20200 (driver side nut tab) and FT20201 (passenger side nut tab) nut tab and a 1/2" x 1 1/4" bolt and washer attach the bracket to the frame. The nut tab on the driver side will be placed in the frame from the hole located towards the front of the new bracket on the outside of the frame. The nut tab on the passenger side will be placed in the frame from the hole located towards the front of the truck on the inside of the frame. Torque to 65 lbs. Repeat same procedure for the opposite side. SEE PHOTOS BELOW AND ON NEXT PAGE.



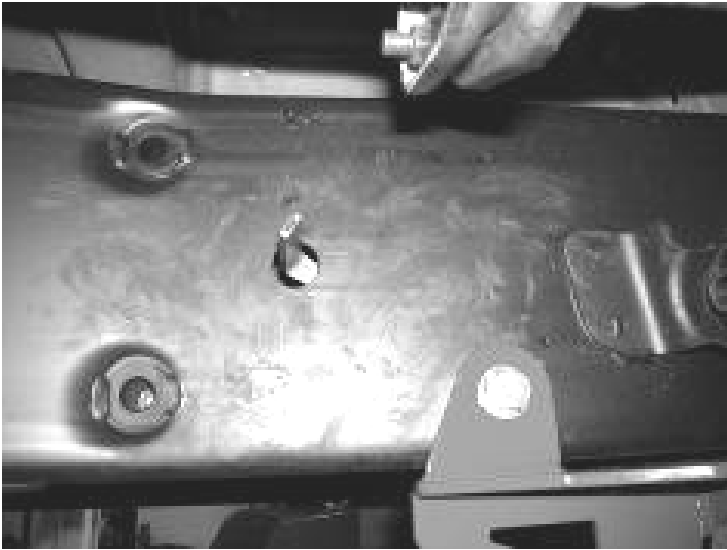

Passenger side Nut Tab



Driver Side Nut Tab

45. Locate the factory torsion bar crossmember. Using a die grinder you will need to notch the ends of the crossmember 1" in on both ends. SEE PHOTO BELOW.



46. Install the factory torsion bar crossmember onto the Fabtech brackets. Note: on some trucks you will need to install the Fabtech torsion bar brackets and factory crossmember as one unit. This will require you to remove the Fabtech bracket after all the holes have been drilled than reinstall as one complete unit.
47. Reinstall the driver and passenger side torsion bars with the factory torsion bar adjuster using the factory hardware and set adjuster nut to original recorded setting.
48. Recheck all bolts for proper torque. Recheck brake hoses and lines for proper clearances.
49. Check the fluid in the front differential and fill if need with factory specification differential oil.
50. Install tires and wheels and torque lug nuts to wheel manufacturers specifications. Turn front tires left to right and check for appropriate tire clearance. Note- Some oversized tires may require trimming of the front bumper & valance.
51. Remove the front end of the truck from the jack stands.

REAR SUSPENSION

52. **Disconnect the negative terminal of the battery.** Jack up the rear of the truck and support the frame rails with jack stands. **NEVER WORK UNDER AN UNSUPPORTED VEHICLE!** Remove the rear tires.
53. Starting on the driver side of the truck, remove the bolt securing the brake line support tab to the center of the differential housing.
54. Disconnect the sway bar end links from the frame and sway bar. Discard sway bar end links.
55. Using a floor jack, raise the differential just enough to slightly compress the rear shocks. Remove the shocks and discard.
56. Remove the lower pivot bolt that attaches the track bar to the bracket on the rear axle. Pull trac bar free from mount and save the hardware.

Step 57 For Coil Spring Models Only

57. Lower the floor jack to release the coil springs. Remove the coil springs from the vehicle and save the rubber upper coil insulator.

Step 58 For Air Bag Models Only

58. Locate the airline going into the top of the air bags. Push the air line into the bag causing the fitting on the bag to push in also, hold the fitting in and pull out on the airline, witch will release the air line. **NOTE: A large amount of air will blow out of the bag at first.** Remove the air bag from the truck by twisting the bag in the upper mount counter clockwise. Repeat step on the opposite side.
59. Working from the driver side of the truck remove the e-brake cable from the factory bump stop mount. Place the bump stop extension mounts FT20197 onto the existing pads on the top of the differential. Using the supplied 7/16" bolts, washers and nut tab, secure the upper mount to the differential. There should be a flat washer on the topside of the bolt only. Do not fully tighten. Make sure the side tab is flat against the pad on the differential. Drill the 7/16" hole and use the remaining 7/16" hardware attach the previously removed e-brake bracket to the bump stop and axle on this new hole. Fully tighten all the 7/16" fasteners to 30 ft lbs. SEE PHOTOS BELOW AND NEXT COLUMN.

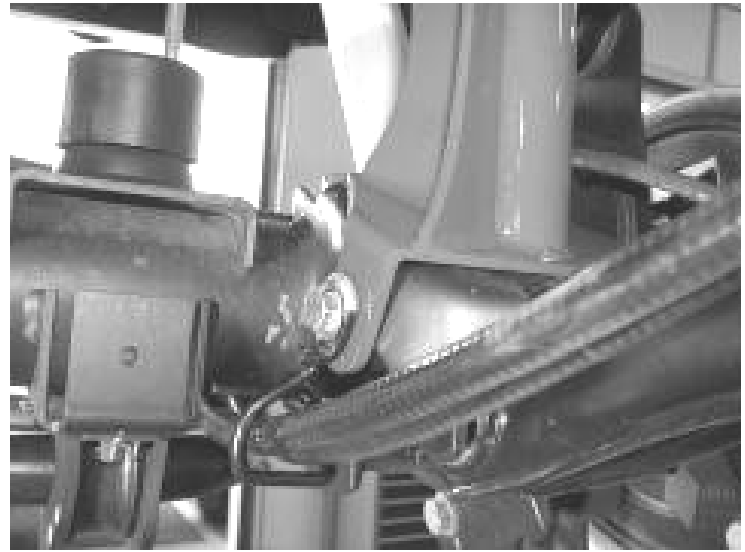
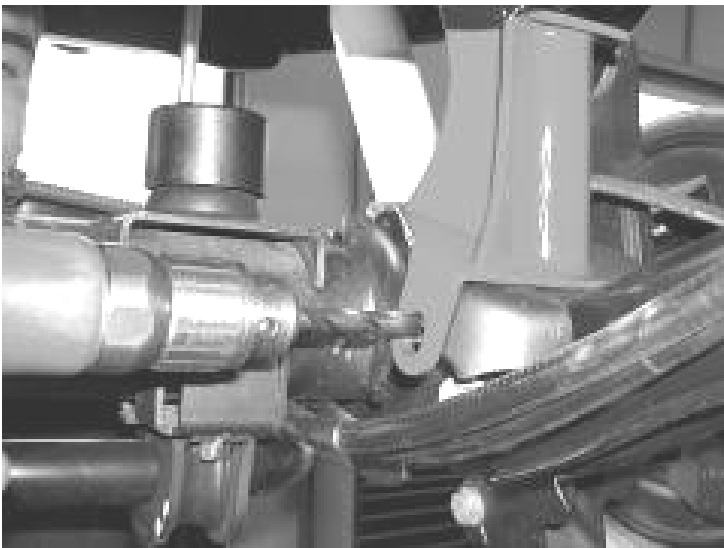

60. Repeat step 58 on the passenger side of the truck. Without relocating the e-brake cable bracket.
61. Slide the Trac Bar Bracket FT20384 into the original axle trac bar mount. Place the supplied 9/16" x 3 1/4" bolt, with a flat washer, through the original hole, followed by another flat washer and a c-lock nut. Make sure that the bracket is flat against the factory mount and tighten the 9/16" bolt. Next, mark the 1/2" hole that is in the center of the bracket to the mount. Using a drill with a 1/2" bit, make a new mounting hole in the mount. Use the supplied 1/2 x 1 1/4" bolt and hardware to attach the new bracket to the mount. Next, mark the 9/16" hole that is in the face of the bracket to the mount. Using a drill with a 9/16" bit, make a new mounting hole in the mount. Use the supplied 9/16" x 1 1/4" bolt and hardware to attach the new bracket to the mount. Torque the 1/2" hardware to 75 ft. lbs & the 9/16" hardware to 95 ft. lbs. SEE DIAGRAMS BELOW & ON LAST PAGES OF THE INSTRUCTIONS.

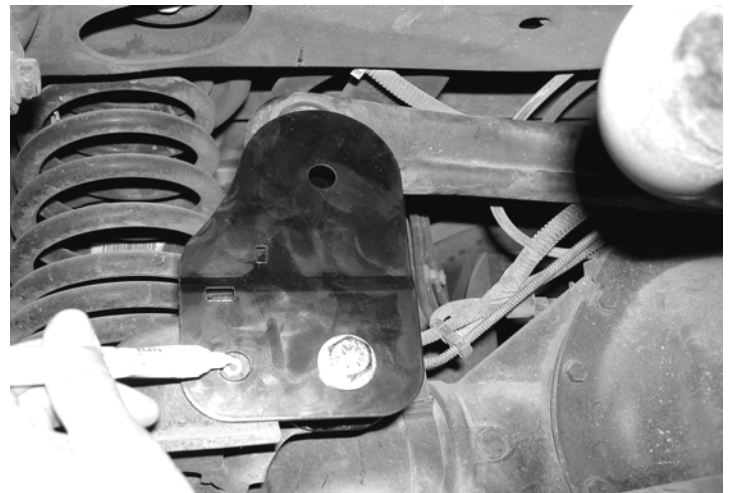



Step 62 For Coil Rear Models Only

62. Locate the coils from Kit FTS27005. Place a floor jack under the rear axle. Attach your coil spring compressor onto the new rear coil spring and compress the coil 1"-2". Set the upper coil insulator on top of the coil spring and position the top of the coil into the frame pocket. Push the bottom of the coil spring onto the axle pad and raise the floor jack under the axle to hold the coil spring in position. Remove the coil spring compressors. Repeat this with the opposite coil spring. **USE CAUTION WHEN WORKING WITH COIL SPRING COMPRESSORS, THEY CAN BE UNDER EXTREME LOAD.**

All Rear Suspension Cont.



63. Locate the supplied FT1599-2-4 sway bar end links. Install two bushings and one sleeve into each end. Connect the bottom of the sway bar end link onto the sway bar using the supplied 12mm-1.75 x 70 bolts, flat washers and c-lock nuts and connect the top of the sway bar end link to frame with the factory bolt. SEE PHOTO BELOW.

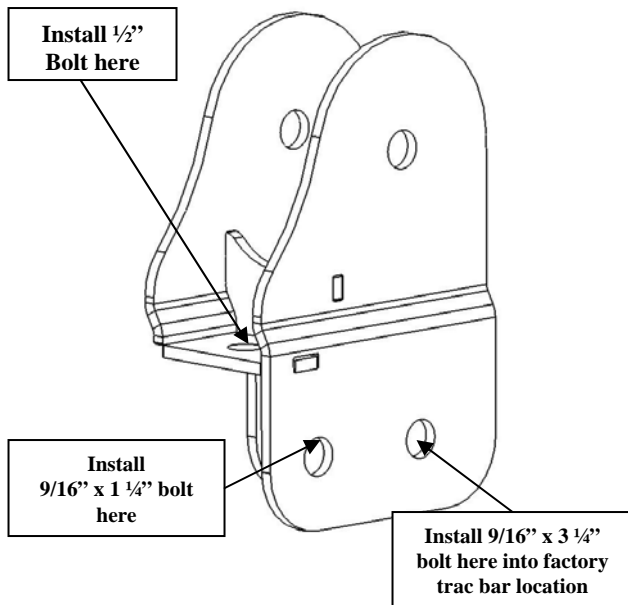

Step 64-66 For Air Bag Rear Models Only

64. Locate the Air Bag Spacer From Kit FTS27006. Place the spacer in the stock upper air bag frame pocket. Using the supplied 7/16" bolts, and washers, attach the spacer to the frame in the existing holes using a small amount of the supplied thread locking compound on each bolt. You will now need to pull the airline through the center of the air bag spacer. **Note: You will need to carefully pull the airline to gain some slack.** SEE PHOTO NEXT PAGE.



65. Reinstall the factory air bag onto the new spacer previously installed. The air bag will need to be locked into the spacer by engaging the tabs from the air bag to the spacer and twisting the air bag clockwise. Set the lower mount of the air bag onto the axle.

66. Locate the ride height sensor above the upper link arm. Remove the factory mounting bracket from the sensor and the frame and discard, save the hardware. Locate the new sensor bracket FT20204 (Driver Side) and attach it to the frame in the original location using factory hardware. Attach the sensor to bracket using factory hardware and positioning it in the center of the adjustment as shown below. Repeat this step on the passenger side of the truck using FT20205. SEE PHOTO BELOW.

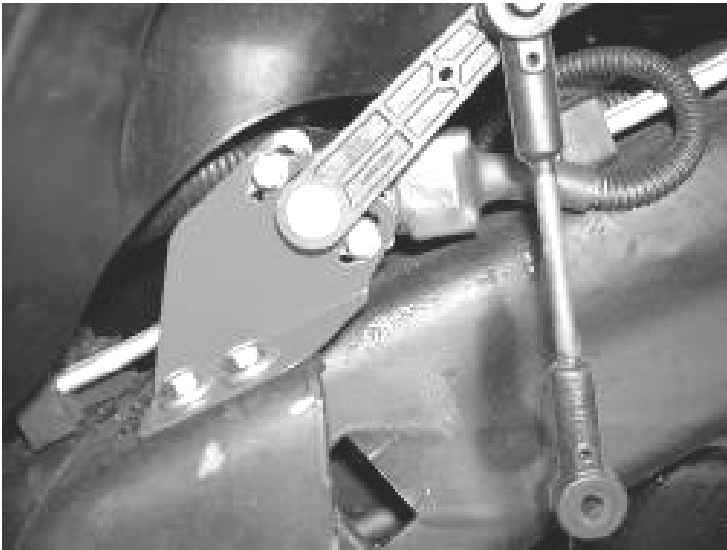

67. Install the FT20098 brake line extension tab using the original bolt and the supplied 5/16" hardware. SEE PHOTO IN NEXT COLUMN.



68. Raise the floor jack supporting the rear axle and slide the lower mount of the track bar into the new bracket on the axle. Torque to 105ft. lbs. SEE DIAGRAM BELOW.

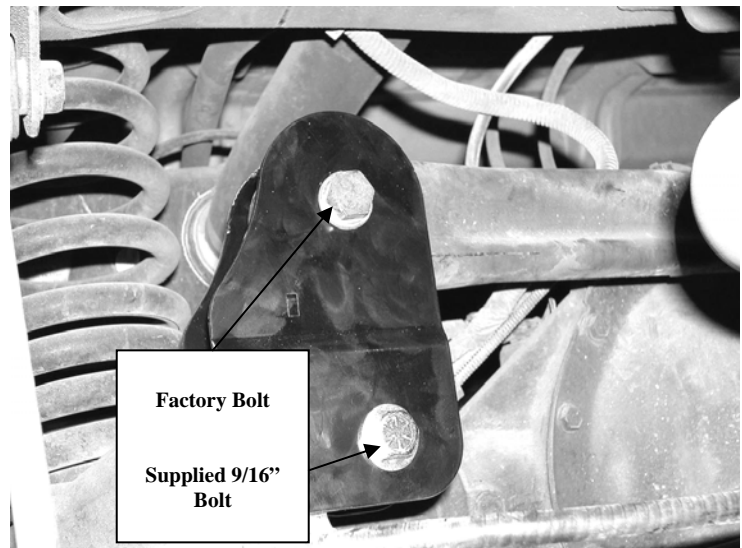
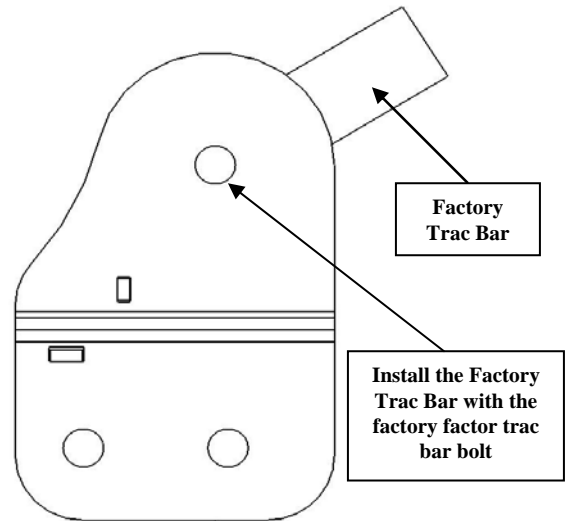

69. Install the new Fabtech shocks FTS7266 (not included in kit).
70. Reinstall the rear tires and torque the lug nuts to the wheel manufacture specifications.
71. Reconnect the negative terminal of the battery.

Air Bag Models Only

72. With the truck still supported on the frame with jack stands, use a floor jack to raise the rear axle approximately 2-3" start the truck and close the door (**use care not to lock the keys in the truck**). Allow the air bags to refill. This will take a few minutes. **CAUTION WHEN REFILLING**

THE AIR BAGS, USE CARE TO MAKE SURE THEY DO NOT FOLD OVER OR TWIST, THIS CAN CAUSE DAMAGE TO THE AIR BAG. IF THE BAG FOLDS OVER OR TWISTS TURN THE TRUCK OFF AND DEFLATE BAG AND START OVER.

73. Remove the jack stands and set the truck back onto the ground. Check the torque on all fasteners.
74. Check the front-end alignment and set to the factory specifications. Re-adjust headlights.