



INSTALLATION INSTRUCTIONS

FTS835237D FCS1425D		FORD SUPERDUTY 4.0 COILOVER
1	FT30717	LOWER COILOVER MOUNT (DRIVER)
1	FT30726	UPPER COILOVER MOUNT (DRIVER)
1	FT30728	DRILL GUIDE
1	FT835232i	INSTRUCTIONS
1	FT86077	HARDWARE KIT 77
1	FT86078	HARDWARE KIT
1	FT86094	HARDWARE KIT 94

FTS835237P FCS1425P		FORD SUPERDUTY 4.0 COILOVER
1	FT30718	LOWER COILOVER MOUNT (PASSENGER)
1	FT30727	UPPER COILOVER MOUNT (PASSENGER)
1	FT30728	DRILL GUIDE
1	FT835232i	INSTRUCTIONS
1	FT86077	HARDWARE KIT 77
1	FT86078	HARDWARE KIT

FTS835232D		FORD SUPERDUTY 4.0 COILOVER 6" KIT
1	FT30717	LOWER COILOVER MOUNT (DRIVER)
1	FT30726	UPPER COILOVER MOUNT (DRIVER)
1	FT86094	HARDWARE KIT 94
1	FT835232i	INSTRUCTIONS
1	FT86116	HARDWARE KIT 116
1	FT86078	HARDWARE KIT
1	FT30456	SWAY BAR RELOCATOR (AXLE)
1	FT3400-112D	SWAY BAR DROP (DRIVER)

FTS835232P		FORD SUPERDUTY 4.0 COILOVER 6" KIT
1	FT30718	LOWER COILOVER MOUNT (PASSENGER)
1	FT30727	UPPER COILOVER MOUNT (PASSENGER)
1	FT30728	DRILL GUIDE
1	FT835232i	INSTRUCTIONS
1	FT86116	HARDWARE KIT 116
1	FT86078	HARDWARE KIT
1	FT30456	SWAY BAR RELOCATOR (AXLE)
1	FT3400-112P	SWAY BAR DROP (PASS)

2017-2020 FORD F-250/F-350 SUPERDUTY

4.0 COILOVER CONVERSION KIT

FT835232i

FT86077		HARDWARE KIT 77
1	FT83245	UPPER MOUNT BUSHING (LARGE)
1	FT83246	UPPER SHOCK BUSHING (SMALL)
2	FT83474	SPACER (UPPER)
2	FT83475	5/8" SPACER (LOWER)
2	FT89016	HOSE CLAMP

FT86116		HARDWARE KIT 116
2	50000005081	1/2" SAE WASHER
1	50130004152	1/2-13 C-LOCK NUT
1	50131251081	1/2-13 X 1-1/4" HEX BOLT
1	FT83245	UPPER MOUNT BUSHING (LARGE)
1	FT83246	UPPER SHOCK BUSHING (SMALL)
2	FT83474	SPACER (UPPER)
2	FT83475	5/8" SPACER (LOWER)
2	FT89016	HOSE CLAMP

FT86094		HARDWARE KIT 94
1	FT30664	BRAKE LINE BRACKET
1	FT30688	ABS TAB
1	FT30728	DRILL GUIDE
2	FT30929	ABS SPACER
2	31181501081	5/16-18 X 1-1/2 HEX BOLT
4	31000005052	5/16" SAE WASHER
2	31180004152	5/16-18 C-LOCK NUT

FT86078 - HARDWARE KIT		LOCATION
2	M14-2.0 X 30MM HEX BOLT	LOWER MOUNT
2	M14 FLAT WASHER	
3	7/16" USS FLAT WASHER	UPPER MOUNT
3	7/16-14 C-LOCK NUT	
2	1/2" SAE WASHER	
1	1/2-13 C-LOCK NUT	
1	1/2-13 X 2-1/2" HEX BOLT	
2	5/8" SAE WASHER	
1	5/8-11 C-LOCK NUT	
1	5/8-11 X 3-1/2" HEX BOLT	
2	1/4-20 X 1" HEX BOLT	BRAKE LINE
4	1/4" SAE WASHER	
2	1/4-20 NYLOCK NUT	
2	3/8-16 X 1-1/4" HEX BOLT	ABS BRACKET
4	3/8" WASHER	
2	3/8-16 NYLOCK NUT	
1	5/16-18 X 1" HEX BOLT	ABS TAB
2	5/16" WASHER	
1	5/16-18 NYLOCK NUT	

- TOOL LIST -

Required Tools (Not Included)

- Basic Hand Tools
- Floor Jack
- Jack Stands
- Torque Wrench
- Die Grinder w/ Cutoff Wheel or Sawzall
- Assorted Metric and S.A.E sockets, and Allen wrenches

- PRE-INSTALLATION NOTES -

For technical assistance call: **909-597-7800** or e-mail: **info@fabtechmotorsports.com**

READ THIS BEFORE YOU BEGIN INSTALLATION -

Check all parts to the parts list above before beginning installation. If any parts are missing contact Fabtech at 909-597-7800 and a replacement part will be sent to you immediately.

Read all instructions thoroughly from start to finish before beginning the installation. If these instructions are not properly followed severe frame, driveline and / or suspension damage may occur.

Check your local city and state laws prior to the installation of this system for legality. Do not install if not legal in your area.

Prior to the installation of this suspension system perform a front end alignment and record. Do not install this system if the vehicle alignment is not within factory specifications. Check for frame and suspension damage prior to installation.

The installation of this suspension system should be performed by two professional mechanics.

This suspension must be installed with Fabtech shock absorbers.

Use the provided thread locking compound on all hardware.

WARNING- Installation of this system will alter the center of gravity of the vehicle and may increase roll over as compared to stock.

Vehicles that receive oversized tires should check ball joints, uniballs, tie rods ends, pitman arm and idler arm every 2500-5000 miles for wear and replace as needed.

Verify differential fluid is at manufactures recommended level prior to kit installation. Installation of the kit will reposition the differential and the fill plug hole may be in a different position. (For example, if the manufacture recommends 3 quarts of fluid, make sure the diff has 3 quarts of fluid). Check your specific manual for correct amount of fluid.

FOOTNOTES -

- WILL NOT WORK WITH LEVELING OR BASIC SYSTEM

NOTE: TO ORDER WEARABLE REPLACEMENT COMPONENTS DO NOT USE PART NUMBERS SHOWN ON THIS INSTRUCTION SHEET. GO TO FABTECH WEBSITE AND LOOK UP WEARABLE REPLACEMENT PARTS TO FIND THE PROPER PART NUMBER TO ORDER.

- INSTRUCTIONS -

1. Disconnect the negative terminal on the battery. Jack up the front end of the truck and support the frame rails with jack stands. **NEVER WORK UNDER AN UNSUPPORTED VEHICLE!** Remove the front tires.
2. Disconnect the sway bar from the end links and the factory brake line bracket from the lower coil spring perch. **SEE FIGURE 1.** Repeat on Passenger side.

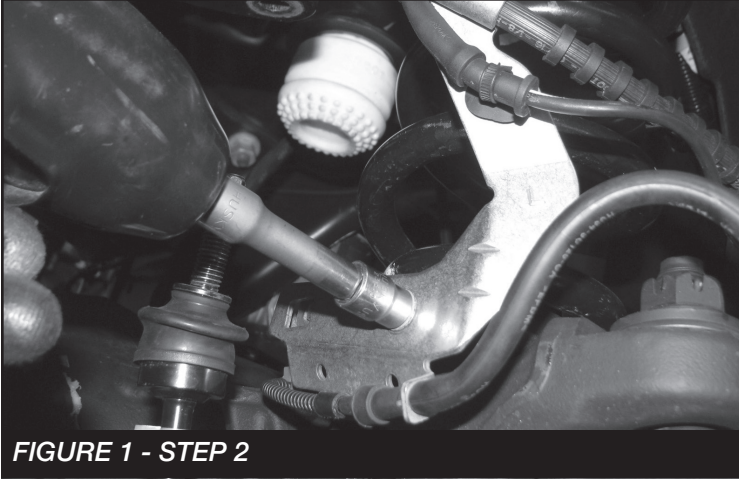

FIGURE 1 - STEP 2

3. Disconnect the track bar from the track bar bracket. Save hardware.
4. Remove and discard the front shocks, coil springs and upper rubber isolators from both sides. Save lower shock hardware.
5. Remove the lower coil spring perch from the axle and discard. Repeat on passenger side.
6. **(DRIVER SIDE ONLY)** Remove the driver side inner fender liner. Locate the ABS module mounted to the factory spring perch. Remove and save the bolt attaching the bracket to the front of the spring perch. Using a 13mm wrench remove the (2) nuts that attach the L bracket together. Then using the same 13mm wrench remove the nuts attaching the same bracket to the back side of the factory spring perch. Discard the factory bracket and save the hardware. **2020 Models** - Remove the factory bolt assembly attaching the ABS module to the coil bucket. **SEE FIGURE 2**

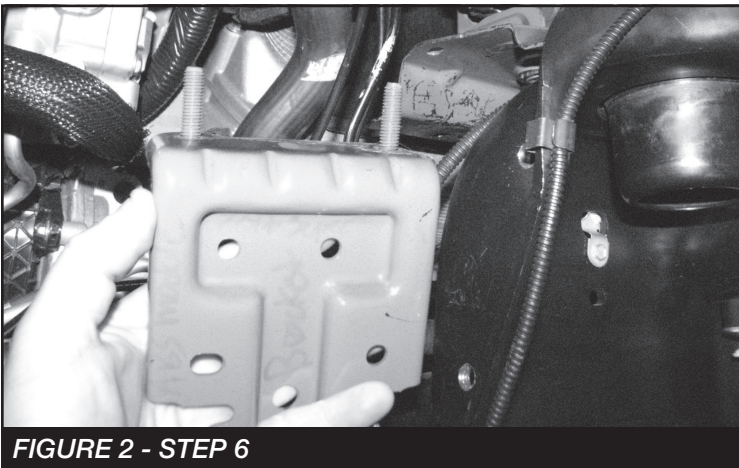

FIGURE 2 - STEP 6

7. **2017-2019 Models** - Locate and install FT30664 (ABS Bracket) in the same location as the factory bracket previously removed using the factory nuts on the spring perch and the supplied 3/8" X 1-1/4" hardware. Torque to 52 ft-lbs. **SEE FIGURE 3**



FIGURE 3 - STEP 7

8. **2020 Models** - Install two FT30929 (ABS Module spacer) between the ABS bracket and the upper shock mount bracket using the supplied 5/16" x 1-1/2" bolts, washers and nuts. **SEE FIGURE 4**

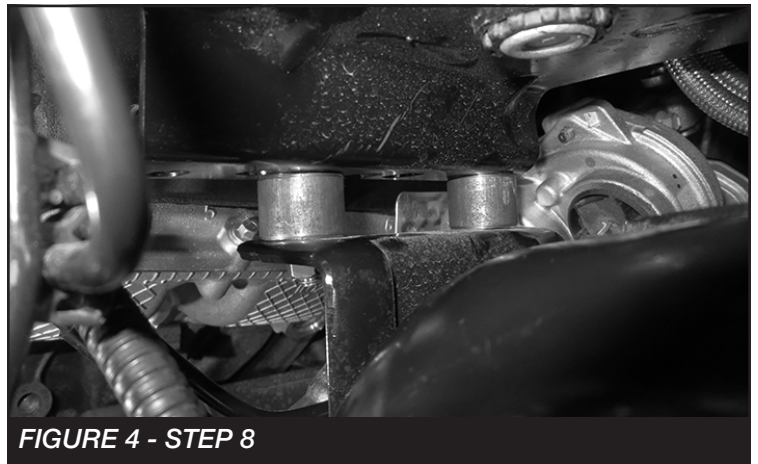

FIGURE 4 - STEP 8

9. Install FT30688 (ABS Tab) using the factory and 5/16" hardware. Torque to 29 ft-lbs. **SEE FIGURE 5**



FIGURE 5 - STEP 9

- Reinstall the fender liner -

10. Locate FT30728 (Drill guide). Place the guide up in the upper coil spring mount with the notch facing towards you. Measure 4-3/4" from the edge of the mount. Place the notch at the 4-3/4" mark. Next, mark the 3 holes and remove the guide. **SEE FIGURES 6**

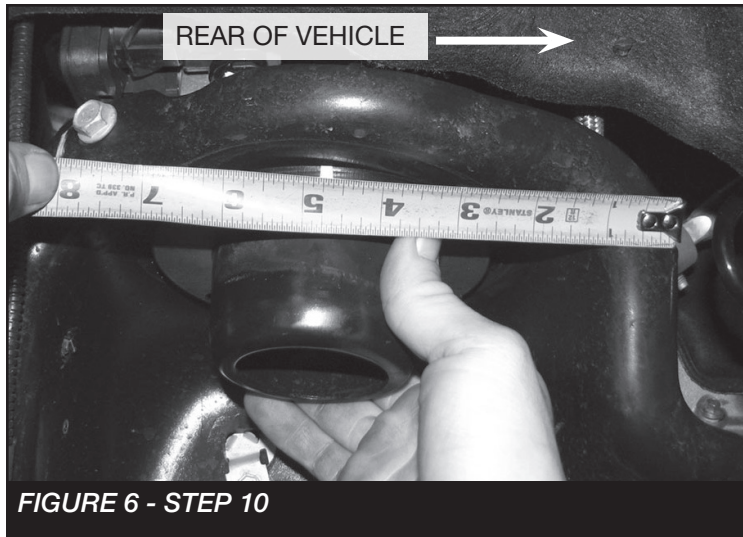

11. Locate the upper coil spring perch. The locator tube will need to be cut off using a reciprocating saw or cut off wheel. Sand to a smooth finish. **SEE FIGURES 7-8**

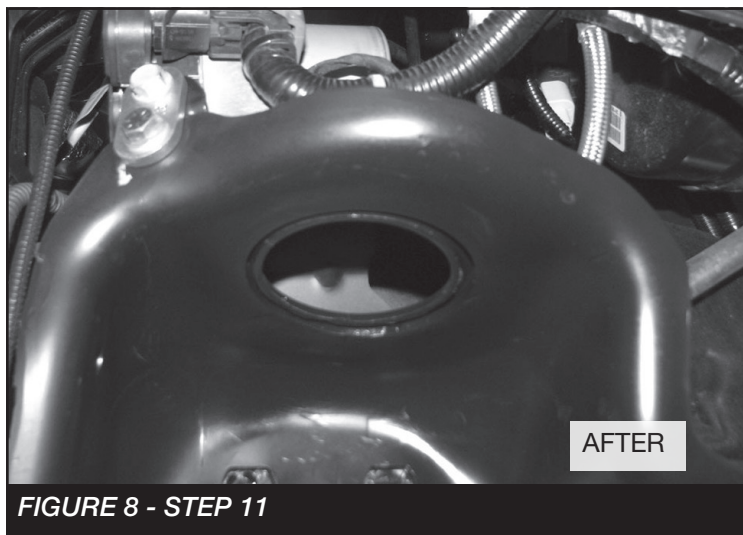
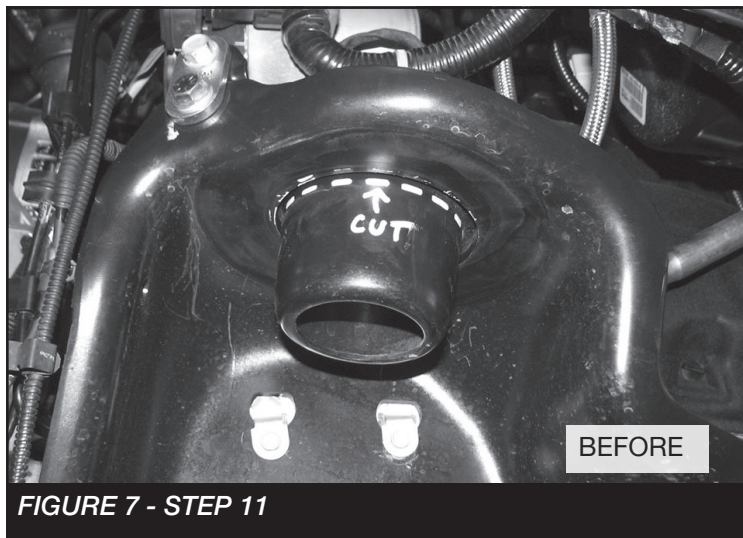

12. Using a drill and a 1/2" drill bit. Drill the 3 holes that were previously marked in step 9. Paint all bare areas. **SEE FIGURE 9**

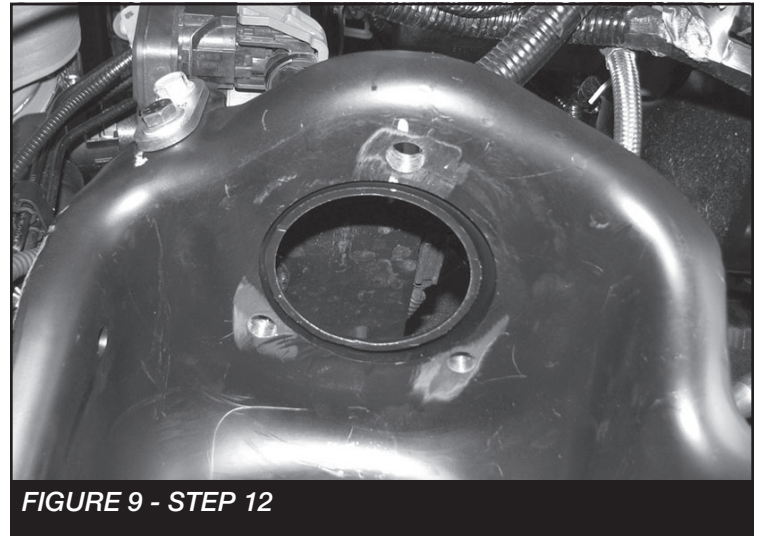

13. REPEAT STEPS 10-12 ON PASSENGER SIDE

14. Locate the Driver side Coilover, FT30726 (Driver upper coilover mount), FT83245 (large bushing, FT83246 (small bushing), two of the FT83474 (1/2" ID misalignment) 1/2" X 2-1/2" bolt and hardware. Using **FIGURE 10** install the upper mount on the coilover with the misalignments and bushings. **NOTE: The resi hose will orientate towards the rear of the vehicle and the 1/2" bolt will needs to be installed from the back side.** Torque to 127 ft-lbs. Once complete set aside.

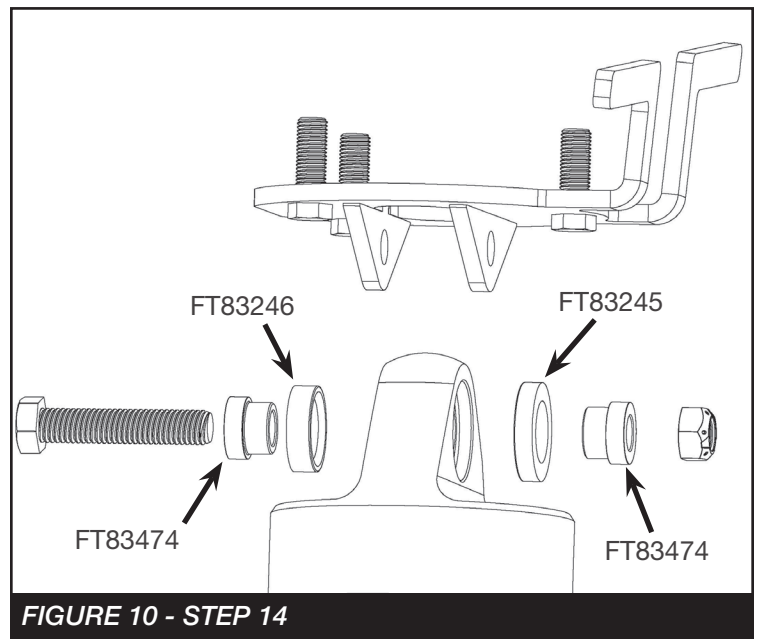

15. REPEAT STEP 14 FOR THE PASSENGER SIDE. Use the Passenger side Coilover, FT30727 (pass upper mount) bushings, misalignments and 1/2" hardware. SEE FIGURE 11 FOR COMPLETED ASSEMBLY.



FIGURE 11 - STEP 15

16. Install FT30717 (Driver lower coilover mount) onto the driver side of the axle using the factory shock hardware at the factory shock location and M14 X 30mm bolt and washer at the lower spring perch location. Torque factory hardware to 100 ft-lbs and M14 to 160 ft-lbs. SEE FIGURE 12.

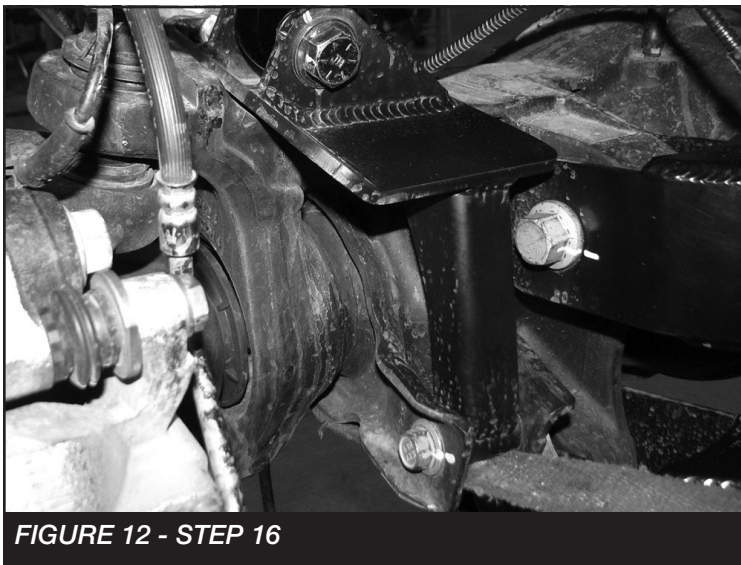

FIGURE 12 - STEP 16

17. REPEAT STEP 16 ON THE PASSENGER SIDE USING FT30718 (PASSENGER LOWER COILOVER MOUNT).

18. Install the driver side coilover using the supplied 7/16" nuts and washers for the upper mount and the 5/8" hardware with two FT83475 (Misalignments) at the lower mount. Torque 7/16" to 83 ft-lbs and 5/8" 254 ft-lbs. SEE FIGURE 13

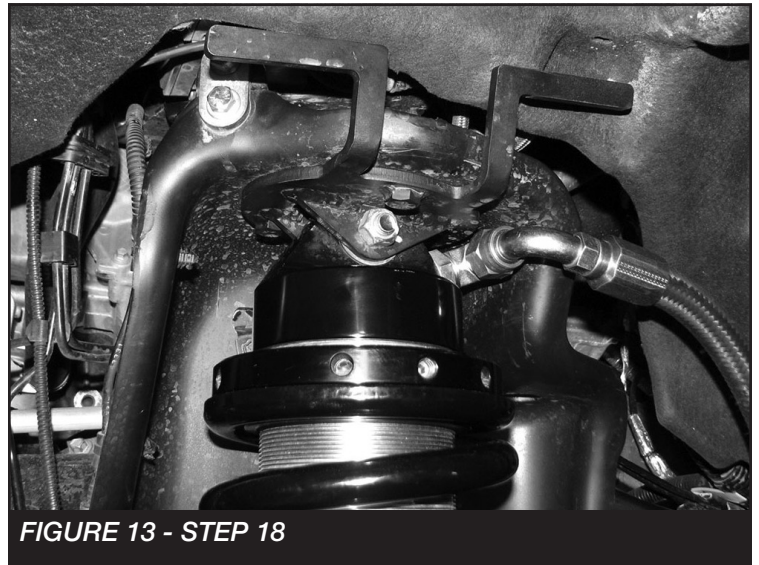

FIGURE 13 - STEP 18

19. Install the resi can to the resi mount using the supplied clamps. SEE FIGURE 14

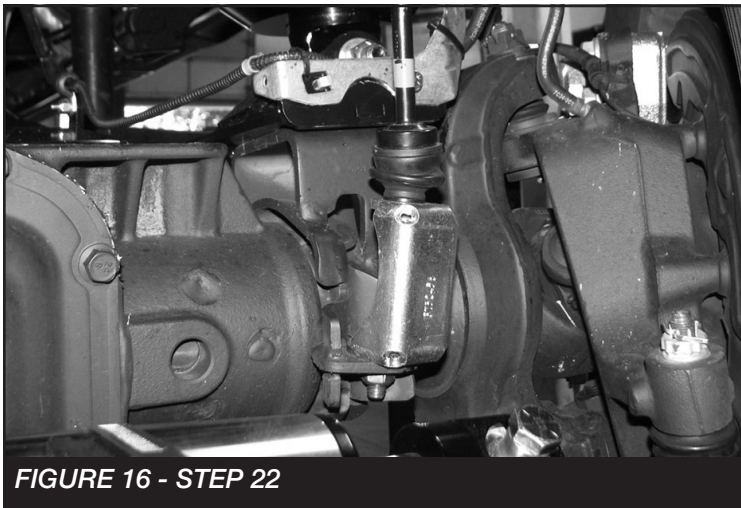

FIGURE 14 - STEP 19

20. REPEAT STEPS 18 & 19 ON THE PASSENGER SIDE

21. **NOTE: If installing FTS835232D&P (6" Coilovers) refer to the next step for the installation of the sway bar relocation brackets.**

22. Install FT3400-112P (Driver) & FT3400-112D (Passenger) Sway bar drop brackets using the factory hardware. Reinstall the front sway bar to the new brackets using the supplied 7/16" hardware torque all hardware to 83 ft-lbs. Remove the factory end links and install FT30456 to the axle using the supplied 1/2-13 X 1-1/2" hardware then reinstall the endlink to the new bracket and sway bar. Torque to 52 ft-lbs. **NOTE:** The smaller flange end of the bracket will be installed to the axle. **SEE FIGURES 15-16**



23. Reconnect the track bar. Torque the track bar bracket bolt to 160 ft-lbs.

24. Install the factory brake line bracket to the new lower coilover mount using the supplied 1/4" hardware. Torque to 14 ft-lbs.

25. Install tires and wheels and torque lug nuts to wheel manufacturer's specifications. Turn front tires left to right and check for appropriate tire clearance. **Note - Some oversized tires may require trimming of the front bumper & valance.**

26. Check front end alignment and set to factory specifications. Readjust headlights.

27. Recheck all bolts for proper torque.

28. Recheck brake hoses, ABS wires and suspension parts for proper tire clearance while turning tires fully left to right.

29. Check the fluid in the front and rear differential and fill if needed with factory specification differential oil. **Note - some differentials may expel fluid after filling and driving. This can be normal in resetting the fluid level with the new position of the differential/s.**

30. Install Driver Warning Decal. Complete product registration card and mail to Fabtech in order to receive future safety and technical bulletins on this suspension.

Vehicles that will receive oversized tires should check ball joints, uniballs and all steering components every 2500-5000 miles for wear and replace as required.

RE-TORQUE ALL NUTS, BOLTS AND LUGS AFTER 50 MILES AND PERIODICALLY THEREAFTER.