



2008-16 FORD F-250/350 SUPER DUTY 4WD



**FTS22100BK
10" RADIUS ARM BOX KIT**



**2008-10 FORD F-250/350 SUPER DUTY
4WD FT22100i
10" RADIUS ARM KIT**

FTS22100BK			10" Radius Arm Box Kit Box 1			FT30287			Hardware Kit -		
Qty	Part #	Description	Qty	Description	Qty	Description	Qty	Description	Qty	Description	Location
1	FT30125BK	Custom Radius Arm Dr.	2	5/16"-18 x 1 1/4" Bolt							Brake Line Bracket
1	FT30126BK	Custom Radius Arm Pass.	2	5/16"-18 Nyloc Nut							
2	FT30467BK	Radius Arm Drop Drv & Pass	4	5/16" SAE Flat Washer							
1	FT30122	Pitman Arm	2	5/16"-18 x 1" Thrd Frmg Bolt							
1	FT30185BK	Frnt. Bumpstop Drop Driver	2	5/16"-18 x 1 1/4" Bolt							Bump Stop Center
1	FT30186BK	Frnt. Bumpstop Drop Passenger	2	5/16" SAE Flat Washer							
1	FT30402	Steering Stabilizer Drop 08-10	2	5/16" Split Washer							
1	FT30629	Sway Bar Drop Drv. 15-UP	7	8" Zip Ties							4wd & ABS Lines
1	FT30630	Sway Bar Drop Pass. 15-UP	4	7/16"-14 x 1 1/2" Bolt							Bump Stop
1	FT30304BK	Trac Bar Drop Bracket 10"	4	7/16"-14 Nyloc Nut							
1	FT30305BK	Trac Bar Support Tube 10"	8	7/16" SAE Flat Washer							
1	FT30287	Hardware Kit (radius arm)	4	7/16"-14 x 1 1/4" bolt							Sway Bar Drop Brkt
1	FT30271	Hardware Kit (10 inch)	4	7/16"-14 C-Lock Nut							
1	FT3400-112D	Sway Bar Drop Driver 08-14	8	7/16" SAE Flat Washer							
1	FT3400-112P	Sway Bar Drop Pass 08-14	6	1/4"-20 x 1" Bolt							ABS Line & Brkt
			6	1/4"-20 C-Lock Nut							@ Radius Arm
			12	1/4" SAE Flat Washer							
			2	Adel Clamp							ABS Line & Brkt
	FT30521	Hardware Subassembly	2	Zerk Fitting							Radius Arm End
Qty	Part #	Description			1	1/8" x 2" Cotter Pin					Drag Link
4	FT1006	Bushing	1	Lock Tight							
2	FT102	Sleeve	1	M12-1.75 X 70MM Bolt							Steering Stabilizer
2	FT22100i	Instruction Sheet	2	M12 SAE Flat Washer							
1	FT292	Cam Bolt Kit	1	M12-1.75 C-Lock Nut							
1	FT30258	Sector Shaft Nut									
2	FT30409	8" Brake Line									
2	FT30410	Brake Line Union									
2	FT30276	Frnt. Brake line Bracket	Qty	Description	8	3/4" -10 x 1 1/2" Bolt					Frame Bracket
2	FT30277	ABS Line Bracket @ Radius Arm	8	3/4"-10 C-Lock Nut							
1	FTAS12	Fabtech Sticker	16	3/4" SAE Flat Washer							
1	FTLUBE	Lube	2	14mm-2.0 x 100MM							Lower Coil Perch
1	FTREGCARD	Reg. Card	2	14mm Flat Washer							



**2011-16 FORD F-250/350 SUPER DUTY
4WD FT22100i
10" RADIUS ARM KIT**

FTS22144			10" Radius Arm Box Kit Box 1			FT30287			Hardware Kit -		
Qty	Part #	Description	Qty	Description	Location	Qty	Description	Location	Qty	Description	Location
1	FT30125BK	Custom Radius Arm Dr.	2	5/16"-18 x 1 1/4" Bolt	Brake Line Bracket						
1	FT30126BK	Custom Radius Arm Pass.	2	5/16"-18 Nyloc Nut							
2	FT30467BK	Radius Arm Drop Drv & Pass	4	5/16" SAE Flat Washer							
1	FT30122	Pitman Arm	2	5/16"-18 x 1" Thrd Frmg Bolt							
1	FT30185BK	Frnt. Bumpstop Drop Driver	2	5/16"-18 x 1 1/4" Bolt	Bump Stop Center						
1	FT30186BK	Frnt. Bumpstop Drop Passenger	2	5/16" SAE Flat Washer							
1	FT30583	Steering Stabilizer Drop 11-UP	2	5/16" Split Washer							
1	FT30629	Sway Bar Drop Drv. 15-UP	7	8" Zip Ties	4wd & ABS Lines						
1	FT30630	Sway Bar Drop Pass. 15-UP	4	7/16"-14 x 1 1/2" Bolt	Bump Stop						
1	FT30304BK	Trac Bar Drop Bracket 10"	4	7/16"-14 Nyloc Nut							
1	FT30305BK	Trac Bar Support Tube 10"	8	7/16" SAE Flat Washer							
1	FT30287	Hardware Kit (radius arm)	4	7/16"-14 x 1 1/4" bolt	Sway Bar Drop Brkt						
1	FT30271	Hardware Kit (10 inch)	4	7/16"-14 C-Lock Nut							
1	FT3400-112D	Sway Bar Drop Driver 08-14	8	7/16" SAE Flat Washer							
1	FT3400-112P	Sway Bar Drop Pass 08-14	6	1/4"-20 x 1" Bolt	ABS Line & Brkt						
			6	1/4"-20 C-Lock Nut	@ Radius Arm						
			12	1/4" SAE Flat Washer							
			2	Adel Clamp	ABS Line & Brkt						
	FT30459	Hardware Subassembly	2	Zerk Fitting	Radius Arm End						
Qty	Part #	Description	1	1/8" x 2" Cotter Pin	Drag Link						
4	FT1006	Bushing	1	Lock Tight							
2	FT102	Sleeve	1	M12-1.75 X 70MM Bolt	Steering Stabilizer						
2	FT22100i	Instruction Sheet	2	M12 SAE Flat Washer							
1	FT292	Cam Bolt Kit	1	M12-1.75 C-Lock Nut							
1	FT30258	Sector Shaft Nut									
2	FT30409	8" Brake Line									
2	FT30410	Brake Line Union	Qty	Description	Hardware Kit -						
2	FT30276	Frnt. Brake line Bracket	8	3/4" -10 x 1 1/2" Bolt	Frame Bracket						
2	FT30277	ABS Line Bracket @ Radius Arm	8	3/4"-10 C-Lock Nut							
1	FT30059	Rear Brake Line	16	3/4" SAE Flat Washer							
1	FT30432	Front Brake line	2	14mm-2.0 x 100MM	Lower Coil Perch						
1	FTREGCARD	Reg. Card	2	14mm Flat Washer							

TOOL LIST:

- FLOOR JACK
- JACK STANDS
- ASSORTED METRIC AND S. A. E. WRENCHES AND SOCKETS
- WHITE LITHIUM GREASE
- TORQUE WRENCH

READ ALL INSTRUCTIONS THOROUGHLY FROM START TO FINISH BEFORE BEGINNING INSTALLATION.

CHECK PARTS & HARDWARE AGAINST THE PARTS LIST BEFORE BEGINNING THE INSTALLATION TO ASSURE THE KIT IS COMPLETE, CONTACT FABTECH IF KIT IS INCOMPLETE.

FABTECH RECOMMENDS YOU DO A PRE- INSPECTION OF THE TRUCKS FRAME FOR ANY DAMAGE BEFORE BEGINNING THE INSTALLATION OF THIS KIT. FABTECH ALSO RECOMMEND YOU PREFORM AN ALIGNMENT ON THE TRUCK BEFORE BEGINNING THE INSTALLATION. IF THE TRUCK HAS ANY FRAME DAMAGE OR WILL NOT ALIGN TO FACTORY SEPECS. DO NOT INSTALL THIS KIT UNTIL THE DAMAGE IS CORRECTED. CALL FABTECH FOR FURTHER INFORMANTION.

FABTECH RECOMMENDS THE FOLLOWING TIRE SIZES FOR USE WITH THIS KIT:

10" LIFT- 40/12.50r17 TIRES W/ 17x9 WHEELS W/ 4 5/8" BACK SPACING w/ minor trimming

10" LIFT- 40/13.50r20 TIRES W// 20x10 WHEELS W/ 4 1/2" BACK SPACING w/ minor trimming

Fabtech suspension systems FTS22092BK & FTS22100BK when used on "Gas engine" trucks will require that the front drive shaft be modified. This is done to give adequate clearance between the driveshaft and the factory exhaust. Fabtech does not recommend modifying the exhaust and / or the catalytic converters.

****NOTE - DO NOT PROCEED WITH INSTALLATION OF SUSPENSION KIT UNTIL VERIFYING THE PROPER FACTORY PITMAN ARM LENGTH.**

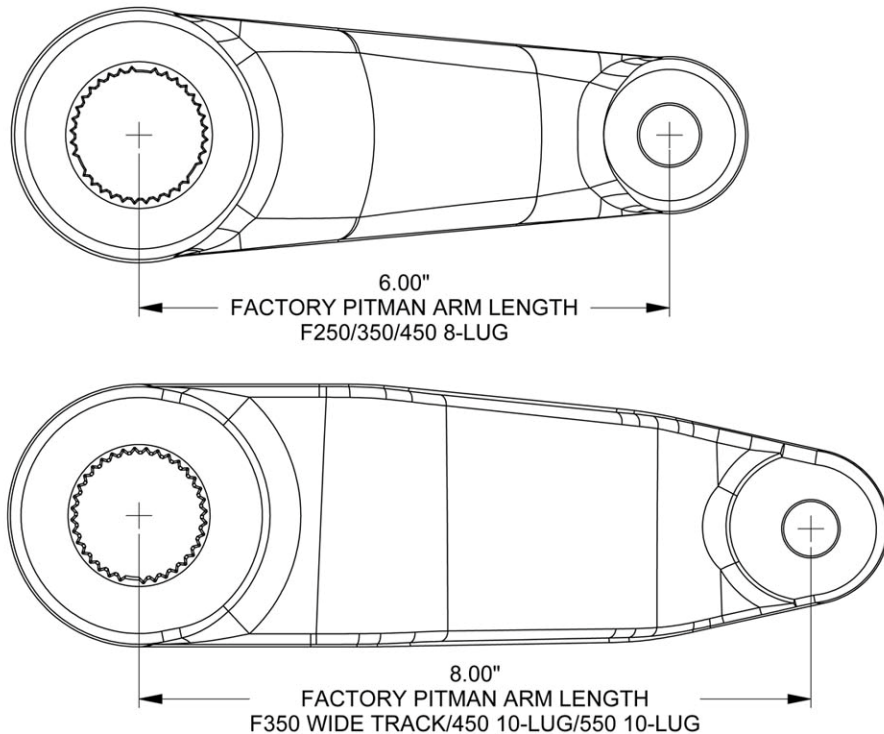

CALL FABTECH FOR ADDITIONAL INFORMATION.

LIFT INSTRUCTIONS:

1. Disconnect the negative terminal on the battery. Jack up the front end of the truck and support the frame, at the front frame rails, with jack stands. **NEVER WORK UNDER AN UNSUPPORTED VEHICLE.** Remove the front tires.
2. Working from both sides of the truck, remove the brake calipers (**remove the caliper cage from the knuckle, do not remove the caliper from the caliper cage**) and tie them up out of the way. **DO NOT ALLOW THE CALIPERS TO HANG FROM THE BRAKE LINES!** Remove the brake line and ABS line tabs from the front side and the rear side of the coil spring mount on the axle and save the hardware.
3. Supporting the front axle with two floor jacks, remove the front shocks and discard. Remove the sway bar end links from the axle mount and save with the hardware.
4. Lower the front axle allowing the coil springs to come free of tension. **EXERCISE EXTREME CAUTION WHEN WORKING WITH COIL SPRINGS UNDER LOAD!** Remove the coil springs from the truck and discard, save the factory upper coil isolator.
5. Remove the factory steering stabilizer from the frame mount and save the hardware. Remove the steering stabilizer frame bracket and save the hardware. Discard the frame bracket. Leave the steering stabilizer connected to the drag link. SEE PHOTO BELOW.



6. Remove the drag link from the pitman arm and save factory hardware. You will need to strike the pitman arm with a large hammer to dislodge the drag link from the pitman arm. **USE CARE NOT TO HIT THE THREADS ON THE DRAG LINK!**

7. Remove the trac bar from the frame bracket and save the original hardware. Remove the trac bar bracket from the frame and save the original hardware and discard the factory trac bar bracket. SEE PHOTO BELOW.



8. Remove the factory pitman arm from the steering box using a large pitman arm puller or large two-jaw puller. Save the hardware and discard the pitman arm. SEE PHOTO BELOW.



9. Locate FTS30122 new drop pitman arm. Attach to the steering box in the same indexed position as the factory pitman arm was when removed. **Install the provided FT30258 Sector Shaft Nut and torque to 350 ft. lbs. (Note: this is a one-time only use nut, once it is tightened on the sector shaft and removed, it must be discarded)**
10. Locate FT30272 Trac Bar Frame Bracket. Attach to the frame using the original hardware in the same position. Torque bolts to 110 ft. lbs. **DO NOT ATTACH THE TRAC BAR TO THE FRAME BRACKET AT THIS TIME.**

11. Locate the ABS lines on the radius arms and disconnect it at its two mounting points. Use care not to damage the plastic clips on the ABS line as they will be reused, discard the bolt from the bracket.
12. With the front axle still supported by the floor jacks remove both front factory radius arms from axle and factory frame mounts. Save the factory frame pivot bolts and the factory front upper pivot bolt from the axle mounts, discard the front lower axle pivot bolt.
13. Working from the driver side of the truck, locate FT30467 radius arm drop bracket. Place the bracket into the factory radius arm bracket on the frame. Attach the bracket to the factory bracket using the supplied $\frac{3}{4}$ " x $1\frac{1}{2}$ " bolts, nuts, and washers through the original holes in the frame. Torque bolts to 100 ft. lbs

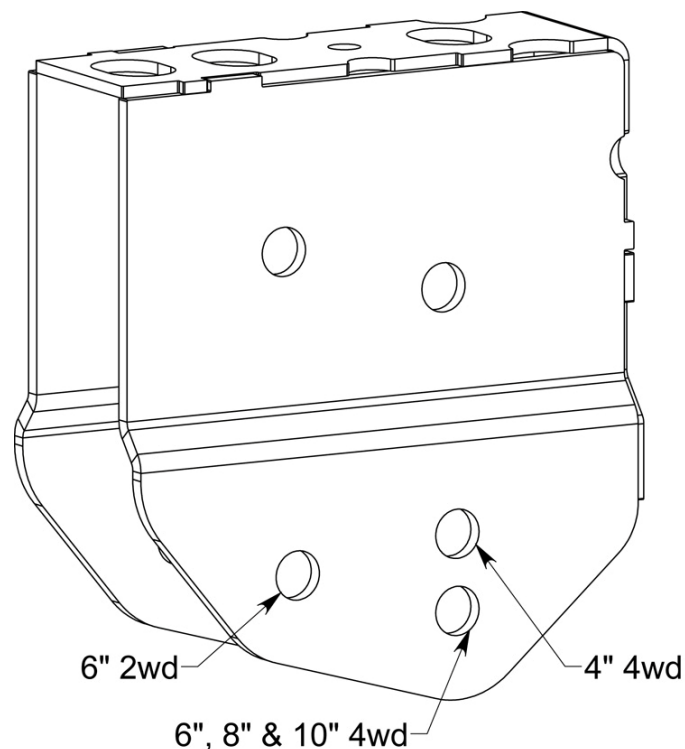
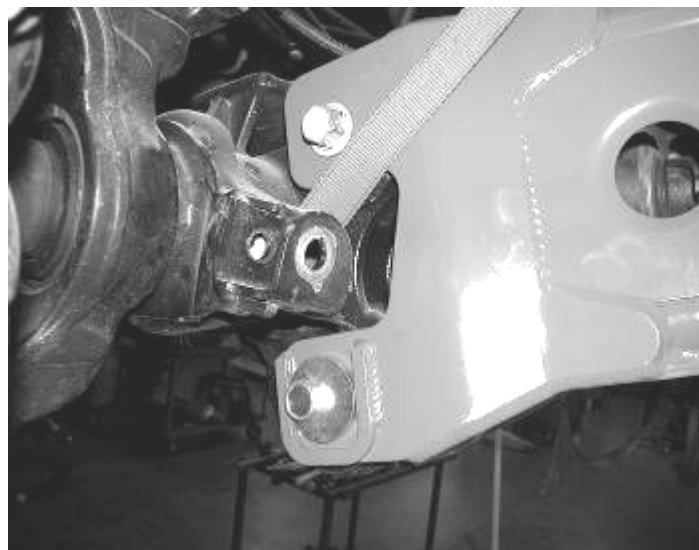

14. Locate both FT30125 and FT30126 radius arms and install two of the supplied bushings and one of the supplied sleeves into each radius arm end. Use the supplied FTLUBE on all the bushing surfaces before installing them into the radius arms. Install one grease fitting into each end of the radius arms with the bushings.
15. Working from the driver side of the truck, Install FT30125, driver side radius arm onto the truck. First attach the radius arm to the axle mounts using the factory upper pivot bolt and the supplied alignment cam on the lower pivot. Then attach the rear pivot to the new Fabtech drop mount in the rearmost hole and use the factory bolt. Leave loose at this time. SEE PHOTO BELOW.

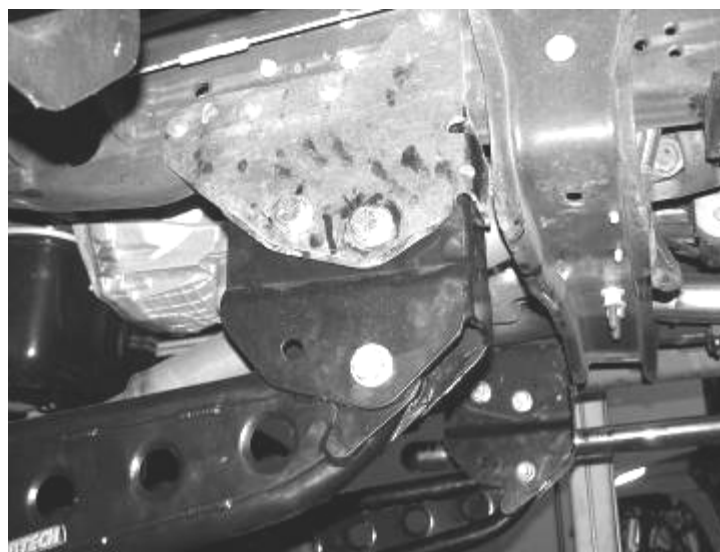

16. Repeat step fifteen on the passenger side of the truck.
17. Working from both sides of the truck, locate and remove the factory front bump stops and save. These can be removed by pulling on the bump stop itself free from the cup. Remove the factory mounting cup from the frame and discard the hardware. Locate FT30143 and FT30144 front bump stop drop brackets. Using a drill with a 7/16" drill bit, drill out the factory locator pin hole in the frame. Now attach the bump stop to the hole in the frame using the supplied 7/16" x 1 1/2" bolt, nut, and washer. Once attached and aligned with the frame drill the second hole with the 7/16" drill bit. Attach the last hole with the supplied 7/16" x 1 1/2" hardware.
18. Locate the factory bumpstop cup and use a die grinder with a cut-off wheel to cut off the locating tab from the bottom. Attach the last hole with the supplied 7/16" x 1 1/2" hardware. Attach the factory bump stop cup to the new bracket using the supplied 5/16" x 1 1/4" bolt, flat washer, and split washer. Before tightening the bolt, align the flat part of the bumpstop cup to the flat side of the drop bracket. Press the factory bump stop back into the cup. SEE PHOTOS BELOW.

IF INSTALLING A FABTECH DUAL SHOCK KIT SEE THE INSTRUCTIONS ENCLOSED WITH THE DUAL SHOCK KIT AT THIS TIME

19. Locate FT30162 coil spacer (**SUPPLIED IN THE COIL SPRING BOX**) and place on top of the axle where the factory spring perch was mounted, place the factory spring perch on top of the new spacer. Attach the factory perch and new spacer to the axle using the supplied 14mm bolt and washer. Use a small amount of the supplied thread locking compound on the bolt. Torque to 80 ft. lbs
20. Using the coil springs from the 10" lift coil spring kit install the coil spring into the truck in the factory location using the original factory upper coil isolator. Make sure that the coil spring is seated correctly in the upper and lower mounts.
21. Using a floor jack raise the front axle enough to compress the front coils approx. 1". Locate the correct Dirt Logic 2.25 Front Shocks FTS81064 and install onto the truck. **Note: Some shock mounts will require cutting a 1/4" from the top of the factory shock tab. If required, use a die grinder with a cut-off wheel and remove the top 1/4" of the tab. Sand and paint bare/ exposed metal. SEE PHOTOS BELOW AND IN NEXT COLUMN**
22. Using a floor jack raise the front axle enough to compress the front coils approx. 1". Locate the correct Dirt Logic 2.25 Front Shocks FTS81064 and install onto the truck. **Note: Some shock mounts will require cutting a 1/4" from the top of the factory shock tab. If required, use a die grinder with a cut-off wheel and remove the top 1/4" of the tab. Sand and paint bare/ exposed metal. SEE PHOTOS BELOW**

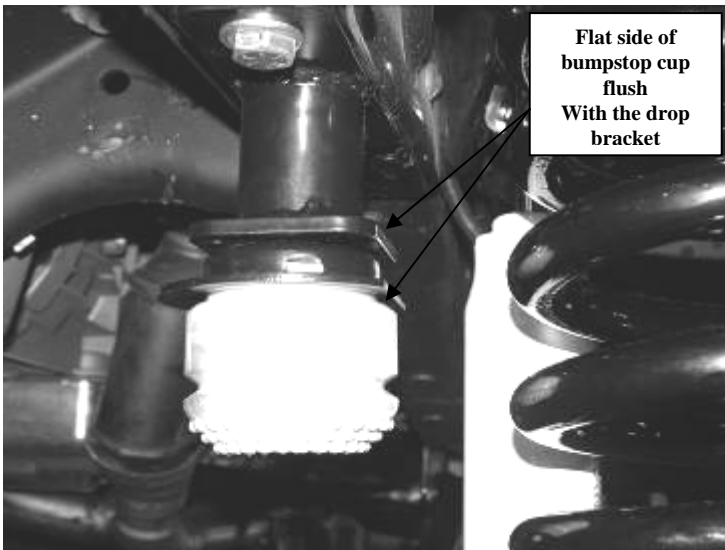
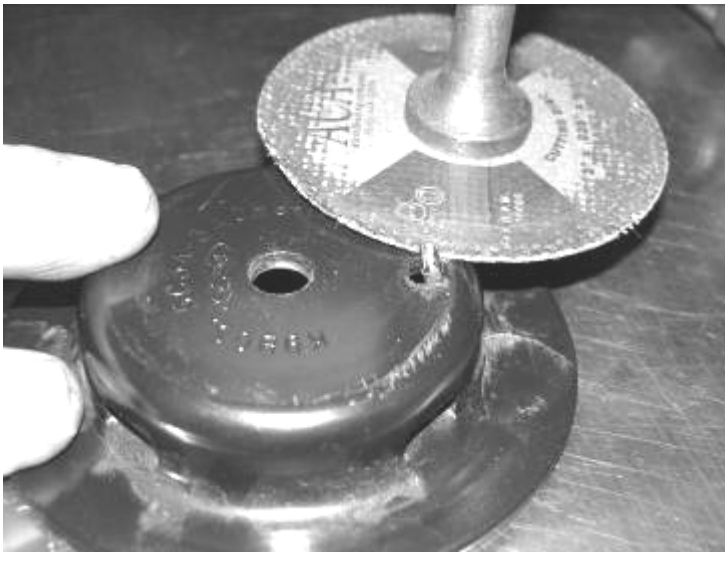



23. Torque the front and rear radius arm pivot bolts to 200 ft. lbs. **NOTE: SET THE ALIGNMENT CAMS IN THE LOWER FRONT RADIUS ARM IN THE MIDDLE OF ADJUSTMENT BEFORE TORQUING. MAKE SURE THE CAM IS SEATED INSIDE THE ALIGNMENT CAM GUIDES.**

24. Locate the factory brake line mount on the front side of the frame. Remove the bracket from the frame and save the hardware. Locate FT30276 Front Brake Line Drop Bracket and attach to the coil bucket using the original hardware in the factory brake line hole. Locate the supplied 5/16" thread forming bolt. Use a drill with a 17/64th drill bit and drill the new hole from the drop bracket into the frame. Install the 5/16" bolt into the new hole. Locate FT30409 Hard Brake Line Extension and separate the factory hose from the hard line. Install the supplied FT30410 union and hard line to the factory hard line. Connect the factory hose to the new hard line. Using the supplied 1/4" x 1 1/4" hardware, attach the factory brake line to the new drop bracket. You will need to carefully bend the hard line down to meet the new brake line bracket. **USE CARE NOT TO DAMAGE THE HARD LINE.** SEE PHOTOS BELOW

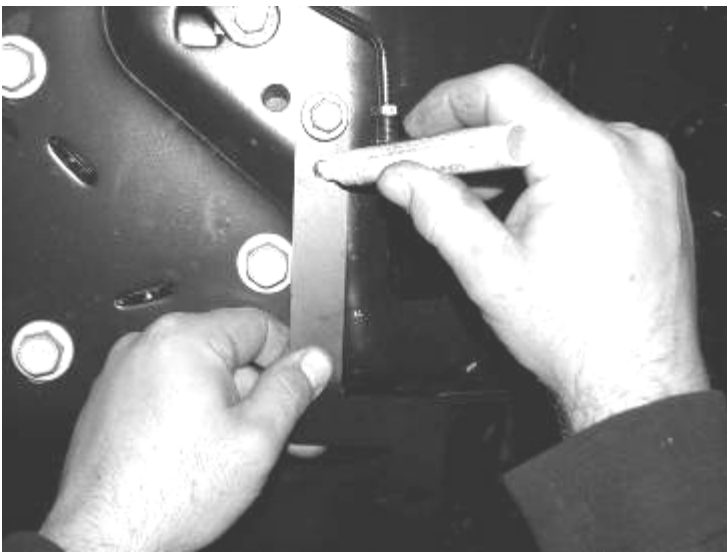
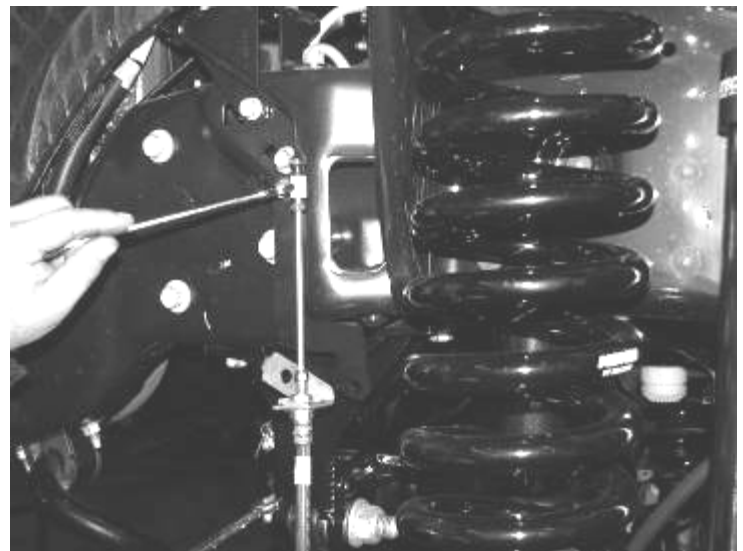

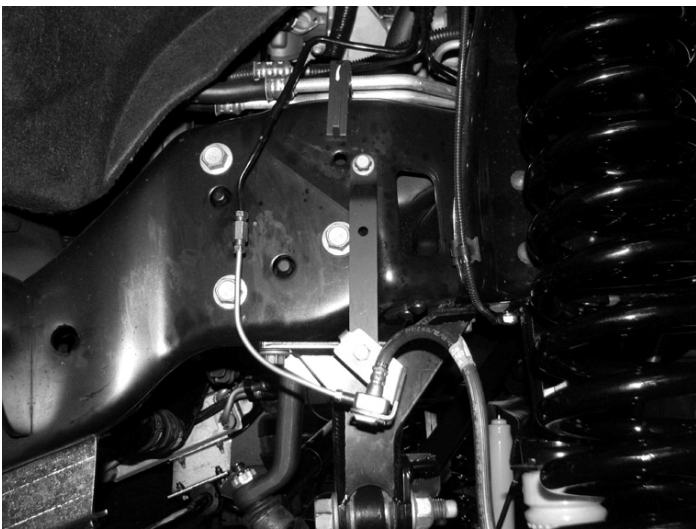
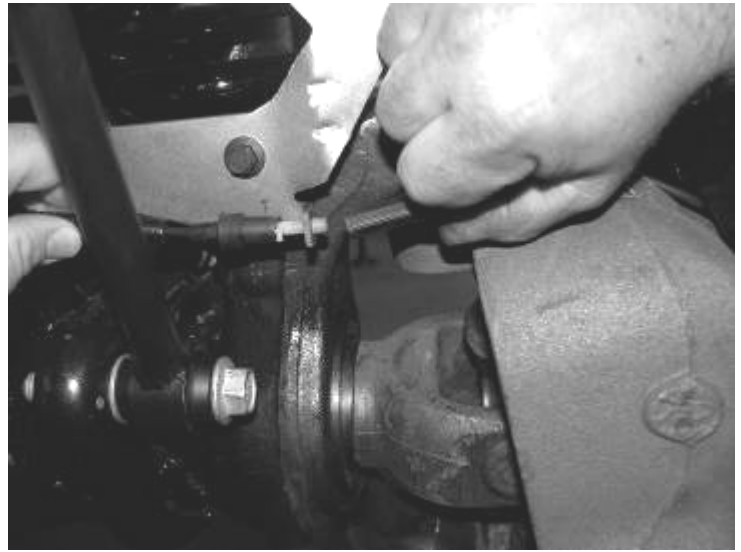
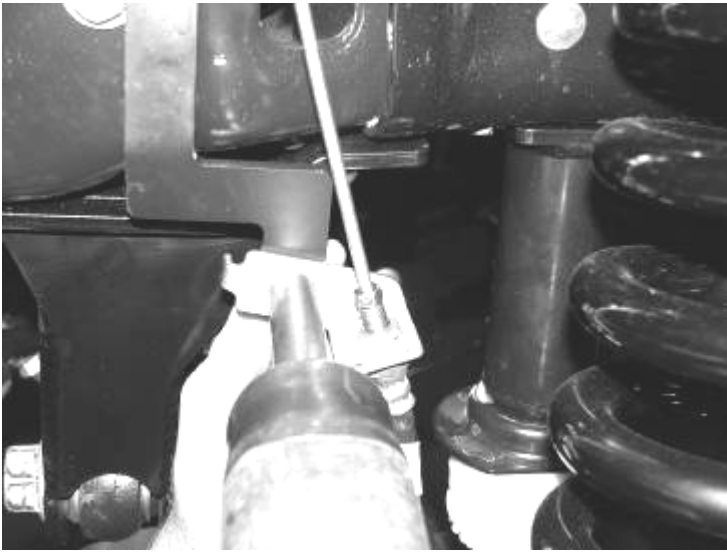

2011 Brake line bracket (FT30432) shown above

25. Working on the driver side, disconnect the four wheel drive vacuum line from the front brake line bracket and reposition and reconnect behind the coil spring mount. Follow the 4wd vacuum line up to the 120 degree connector and remove it from the line and re-connect the lines with the existing line splint. Attach the vacuum line to the ABS line at the coil mount with 2 of the supplied zip ties and attach the vacuum line to the front differential vent hose with 2 more zip ties. **(this keeps all the lines in place during suspension travel, failure to follow this step could cause ABS or 4wd failure).** SEE PHOTOS BELOW



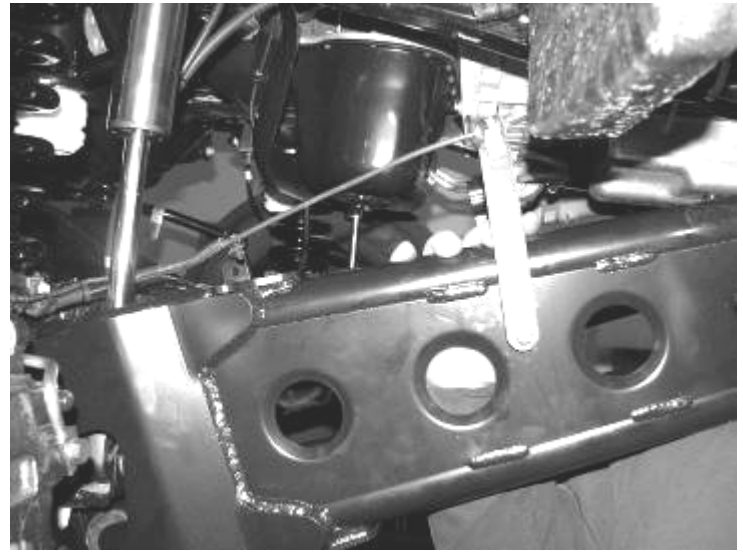
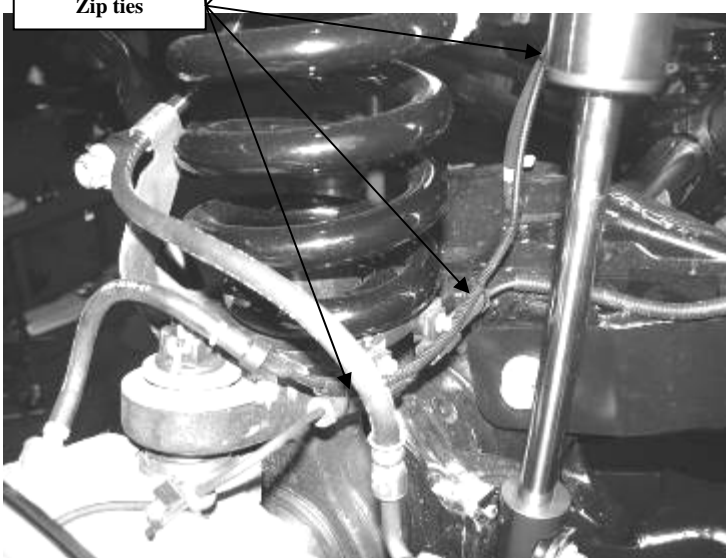
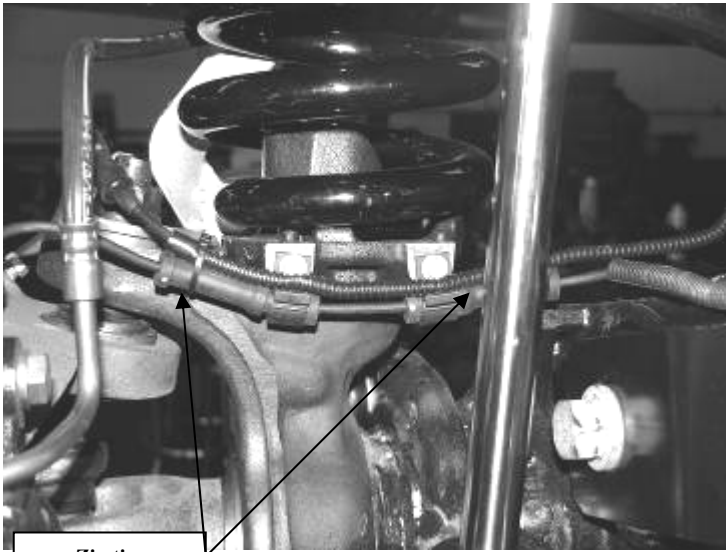

26. Locate FT30277 ABS Line Bracket, the supplied ¼” hardware, and adel clamp. Locate the hole on the radius arm and attach the line bracket to the radius arm in the middle hole. Now mark and drill the bottom hole in the line bracket to the radius arm. Install the ¼” hardware into the bottom hole. Remove the ABS socket connector from the frame and re-connect the ABS line. Install the factory front ABS mount onto the front of the radius arm. Place the provided adel clamp onto the ABS line mount (this may need to be moved) and attach to the new bracket with the supplied ¼” hardware SEE PHOTO BELOW

27. Locate FT30402 (08-10) or FT30583 (11-UP) steering stabilizer drop bracket and install in the factory location using the original hardware. Torque to 50 ft. lbs. Reattach the factory stabilizer to the frame bracket using the original hardware unless installing on 11-UP use supplied M12 Hardware. If installing a Fabtech stabilizer do so at this time. SEE PHOTOS BELOW



Picture Shown with Stabilizer being installed



28. Remove the front sway bar from the frame mounts and save the hardware. Locate the appropriate sway bar frame drop brackets and attach to the frame (AS SHOWN IN PHOTOS) where the sway bar was originally attached using the factory hardware. **(MOUNT THE DRIVER SIDE BRACKET ON THE PASSENGER SIDE, AND THE PASSENGER SIDE ON THE DRIVER SIDE)**

Using the supplied 7/16" X 1 1/4" hardware, attach the sway bar to the new drop brackets and torque to 35 ft. lbs. SEE PHOTOS BELOW



View of outer driver side frame rail



View of inner passenger side frame rail

29. Reattach the factory sway bar end links to the axle mounts using the original hardware. Torque to 40 ft. lbs.
30. Position the factory trac bar into the new trac bar bracket. Note: You may need to raise the axle up or down to align the hole. Using the original bolt insert it from the front side of the bracket towards the back. Do not push the bolt fully through at this time.
31. Locate FT30273 trac bar support bracket. First attach it to the forward motor mount bolt on the driver side of the truck, then line the other end up the trac bar bolt. Torque the factory motor mount bolt to 55 ft. lbs and the trac bar bolt to 400 ft. lbs. SEE PHOTO BELOW.



32. Refer to owner's manual for proper brake bleeding procedure.
33. Install front tires and wheels. Torque lug nuts to wheel manufacturer's specifications.

34. Re-check all front hardware at this time for correct torque tightness.
35. Check the front brake lines and ABS line at this time for proper clearance from all moving parts. You will want to steer the wheels from left to right to make sure the lines clear the wheels. Check fender to tire clearance, trim as needed. Adjust the front headlights.
36. Complete a full alignment on the truck.
37. **RETORQUE ALL NUTS, BOLTS AND LUGS AFTER 500 MILES.** Re-adjust headlights.

REAR LIFT

SEE THE INSTRUCTIONS ENCLOSED IN THE REAR LIFT BOX KIT.

RETORQUE ALL NUTS, BOLTS AND LUGS AFTER 50 MILES AND PERIODICALLY THEREAFTER.