



FTS22140
6" & 8" 4 LINK BOX KITS

2008-2015 FORD F-250/350 SUPER DUTY 4WD



**2008-2015 FORD F-250/350 SUPER DUTY 4WD
 FTS22140
 6" & 8" 4 LINK KIT**

FTS22140BK		
Qty	Part #	4 Link Kit 8" Box 1 Description
1	FT30128BK	Upper Link Driver
1	FT30137BK	Upper Link Passenger
2	FT30129BK	Lower Link D/P
1	FT30143BK	Frnt. Bumpstop Drop Driver
1	FT30144BK	Frnt. Bumpstop Drop Pass
1	FT30435	Hdwr Sub-Asseby Kit
1	FT30402	Steering Stabilizer Drop 08-10
		Steering Stabilizer Drop 11-UP
1	FT30583BK	
1	FT3400-112P	Sway Bar Drop Bracket Drv.
1	FT3400-112D	Sway Bar Drop Bracket Pass.

FTS22080BK		
Qty	Part #	4 Link Kit 8" Box 2 Description
1	FT30138BK	Pass. 4 Link Frame Bracket
1	FT30139BK	Driver 4 Link Frame Bracket
1	FT30373BK	Trac Bar Drop Brkt 6" & 8"
1	FT30273BK	Trac Bar Spprt Tube 6" & 8"
1	FT30286	Hardware Kit (4 link)
1	FT30122	Pitman Arm
1	FT30258	Sector Shaft Nut

FT30435		
Qty	Part #	Hdwr Sub-Assembly Kit Description
8	FT103	Mis-Alignments for Links
1	FT292	Cam Bolt Kit
2	FT30409	8" Brake Line
2	FT30410	Brake Line Union
2	FT30276	Frnt. Brake line Bracket
2	FT22140I	Instruction Sheet
1	FTAS12	Decal
1	FTREGCARD	Registration Card
1	FTAS16	Driver Warning
2	FT30432	Brake Line Bracket
1	FT30059	Brake Line Bracket

FT30286		
Qty	Description	Hardware Kit - Location
4	3/4"-10 x 1 1/2" Hex Bolt	Link Frame Brkt
4	3/4"-10 x 4 1/2" Hex Bolt	Links to Bracket
8	3/4"-10 C-Lock Nut	
16	3/4" Flat Washer	
4	7/16"-14 x 1 1/4" Hex bolt	Sway Bar Drop Brkt
4	7/16"-14 C-Lock Nut	
8	7/16" SAE Flat Washer	
1	1/8" x 2" Cotter Pin	Drag Link
2	5/16"-18 x 1 1/4" Bolt	Brake Line Bracket
2	5/16"-18 Nylock Nut	
4	5/16" SAE Flat Washer	
2	5/16"-18x1" Thrd Frmg Blt	
2	5/16"-18 x 1 1/4" Bolt	Bump Stop Center
2	5/16" SAE Flat Washer	
2	5/16" Split Washer	
4	7/16"-14x1 1/2" Bolt	Bump Stp Drop Brkt
4	7/16"-14 Nylock Nut	
8	7/16" SAE Flat Washer	
2	5/16"-18 x 1" Hex Cap Bolt	ABS @ Link Arm
2	5/16"-18 C-Lock Nut	
4	5/16" SAE Flat Washer	
1	M12-1.75 X 70 Bolt	Steering Stabilizer
2	M12 SAE Flat Washer	
1	M12-1.75 C-Lock Nut	
2	Lock Tight	
7	8" Zip Ties	4wd & ABS Lines

READ BEFORE BEGINNING INSTALLATION

READ ALL INSTRUCTIONS THOROUGHLY FROM START TO FINISH BEFORE BEGINNING INSTALLATION.

FABTECH RECOMMENDS YOU DO A PRE- INSPECTION OF THE TRUCKS FRAME FOR ANY DAMAGE BEFORE BEGINNING THE INSTALLATION OF THIS KIT. FABTECH ALSO RECOMMEND YOU PREFORM AN ALIGNMENT ON THE TRUCK BEFORE BEGINNING THE INSTALLATION. IF THE TRUCK HAS ANY FRAME DAMAGE OR WILL NOT ALIGN TO FACTORY SEPECS. DO NOT INSTALL THIS KIT UNTIL THE DAMAGE IS CORRECTED. CALL FABTECH FOR FURTHER INFORMANTION.

VEHICLES THAT WILL RECEIVE OVERSIZED TIRES SHOULD CHECK BALL JOINTS, TIE RODS ENDS AND IDLER ARM EVERY 2500-5000 MILES FOR WEAR AND REPLACE AS NEEDED

DO NOT ALTER THE FINISH OF THESE COMPONENTS, EXAMPLE- CHROMING, ZINC PLATING OR PAINTING. CHANGING THE FINISH CAN CAUSE STRUCTURAL FATIGUE OF COMPONENTS

CHECK THE FACTORY PITMAN ARM SPLINE ORIENTATION WITH THE SUPPLIED PITMAN ARM BEFORE BEGINING INSTALLATION. SEE STEP NINE FOR MORE INFORMATION

FABTECH RECOMMENDS THE FOLLOWING TIRE SIZES FOR USE WITH THIS KIT:

6" LIFT- 325/65R18 (35x12.50/18) TIRES W/ 18X9.5 WHEELS W/ 4 3/4" BACK SPACING

8" LIFT- 355/65R18 (37x13.50/18) TIRES W/ 18X9.5 WHEELS W/ 4 3/4" BACK SPACING

SEE FABTECH'S CATALOG FTC2007 FOR OPTIONAL WHEEL & TIRE SIZES

Fabtech suspension systems when used on "Gas engine" trucks may require that the front drive shaft be modified. This is done to give adequate clearance between the driveshaft and the factory exhaust. Fabtech does not recommend modifying the exhaust and / or the catalytic converters. Contact Fabtech for additional information.

****NOTE - DO NOT PROCEED WITH INSTALLATION OF SUSPENSION KIT UNTIL VERIFYING THE PROPER FACTORY PITMAN ARM LENGTH.**

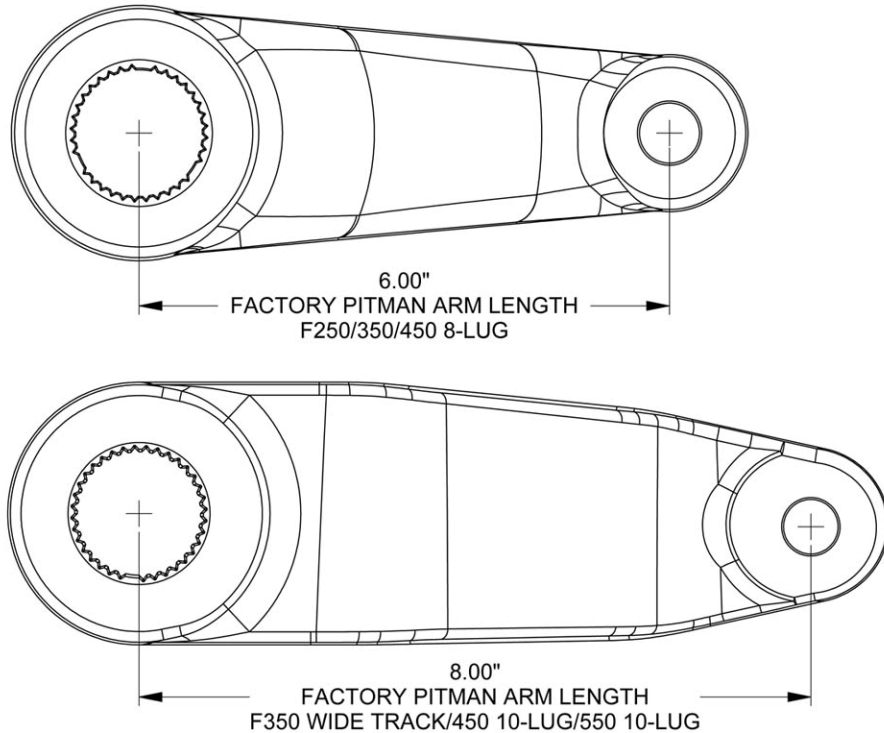

CALL FABTECH FOR ADDITIONAL INFORMATION.

TOOL LIST:

- **FLOOR JACK**
- **JACK STANDS**
- **ASSORTED METRIC & S.A.E. WRENCHES & SOCKETS**
- **WHITE LITHIUM GREASE**
- **TORQUE WRENCH**
- **DRILL W/ ASSORTED BITS**
- **PITMAN ARM PULLER or 2 JAW PULLER**
- **DIE GRINDER w/ CUT-OFF WHEEL & SANDING DISCS**

LIFT INSTRUCTIONS:

1. Disconnect the negative terminal on the battery. Jack up the front end of the truck and support the frame, at the front frame rails, with jack stands. **NEVER WORK UNDER AN UNSUPPORTED VEHICLE.** Remove the front tires.
2. Working from both sides of the truck, remove the brake calipers (**remove the caliper cage from the knuckle, do not remove the caliper from the caliper cage**) and tie them up out of the way. **DO NOT ALLOW THE CALIPERS TO HANG FROM THE BRAKE LINES!** Remove the brake line and ABS line tabs from the front side and the rear side of the coil spring mount on the axle and save the hardware.
3. Locate the ABS lines on the radius arms and disconnect it at its two mounting points. Use care not to damage the plastic clips on the ABS line as they will be reused, discard the bolt from the bracket
4. Supporting the front axle with two floor jacks, remove the front shocks and discard. Remove the sway bar end links from the axle mount and save with the hardware.
5. Lower the front axle allowing the coil springs to come free of tension. **EXERCISE EXTREME CAUTION WHEN WORKING WITH COIL SPRINGS UNDER LOAD!** Remove the coil springs from the truck and discard, save the factory upper coil isolator.
6. Remove the factory steering stabilizer from the frame mount and save the hardware. Remove the steering stabilizer frame bracket and save the hardware. Discard the frame bracket.

Leave the steering stabilizer connected to the drag link.
SEE PHOTO BELOW.



7. Remove the drag link from the pitman arm and save factory hardware. You will need to strike the pitman arm with a large hammer to dislodge the drag link from the pitman arm. **USE CARE NOT TO HIT THE THREADS ON THE DRAG LINK!**
8. Remove the trac bar from the frame bracket and save the original hardware. Remove the trac bar bracket from the frame and save the original hardware and discard the factory trac bar bracket. SEE PHOTO BELOW.



9. Remove the factory pitman arm from the steering box using a large pitman arm puller or large two-jaw puller. Discard the hardware and the pitman arm (**do not re-use the factory sector shaft nut**). SEE PHOTO BELOW.



10. Locate FT30122 new drop pitman arm. Attach to the steering box in the same indexed position as the factory pitman arm was when removed. **Install the provided FT30258 Sector Shaft Nut and torque to 350 ft. lbs. (Note: this is a one-time only use nut, once it is tightened on the sector shaft and removed, it must be discarded)**
11. Locate FT30373BK Trac Bar Frame Bracket. Attach to the frame using the original hardware in the same position. Torque bolts to 110 ft. lbs. **DO NOT ATTACH THE TRAC BAR TO THE FRAME BRACKET AT THIS TIME.**
12. With the front axle still supported by the floor jacks remove both front factory radius arms from axle and factory frame mounts. Save the factory frame pivot bolts and the factory front pivot bolts and nut from the axle mounts.
13. Locate FT30139 Driver side frame bracket. Place the bracket into the stock radius arm frame pocket. Using the supplied $\frac{3}{4}$ " x $1\frac{1}{2}$ " bolts, nuts, and washer attach the bracket to the frame through the rearward two holes. Torque to 110 ft. lbs. SEE PHOTO BELOW

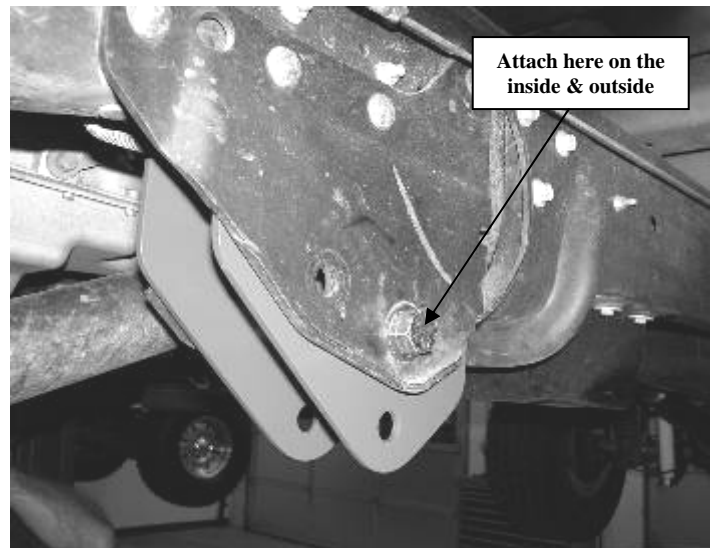

14. Repeat step thirteen on the passenger side of the truck.

15. Locate FT30128 upper driver side link arm. Using the original bolt attach it to the upper mount on the axle. Leave loose at this time. Locate two FT103 Mis-Alignments and insert one into each side of the bearing at the other end of the link arm. Using the supplied $\frac{3}{4}$ " x $4\frac{1}{2}$ " bolt, nuts, and washers attach the bearing end of the link arm to the upper hole in the new frame bracket. Leave loose at this time.

Repeat on the passenger side at this time using FT30137 passenger upper link.

16. Locate FT30129 Lower link arm and attach it to the factory lower axle mount on the driver side using the supplied FT292 alignment cam hardware and leave it loose at this time. When setting the cam up in the lower link arm put the lobe of the cam forward on the 8" kit and up on a 6" kit. Locate two FT103 Mis-Alignments and insert one into each side of the bearing at the other end of the link arm. Using the supplied $\frac{3}{4}$ " x $4\frac{1}{2}$ " bolt, nut, and washers attach the bearing end of the link arm with the mis-alignments to the lower hole in the new frame bracket.

Repeat on the passenger side at this time. NOTE: Some axle housings may have to be sanded for proper clearance of the lower link arms. Use a grinder and remove ONLY the material needed for proper fitment of the lower link arms. SEE DIAGRAM & PHOTOS BELOW.

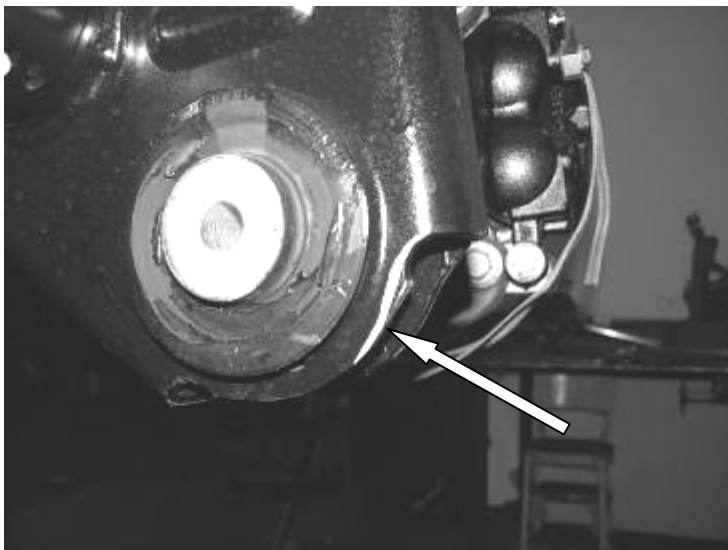

Passenger side before grinding

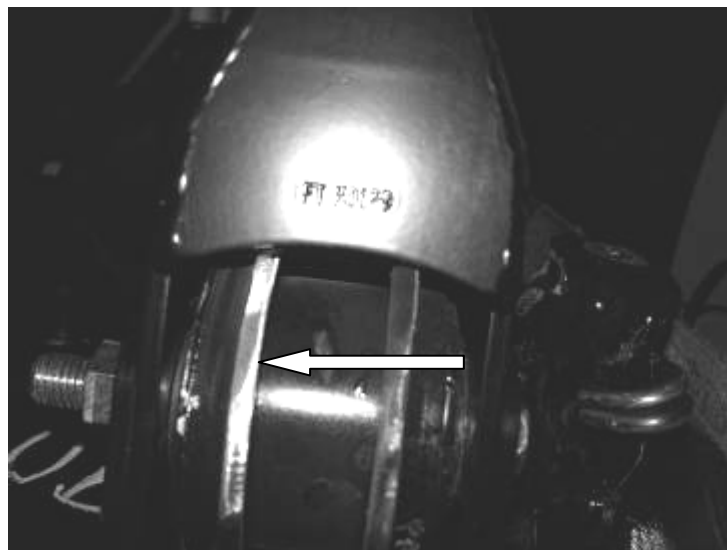

Passenger side after grinding

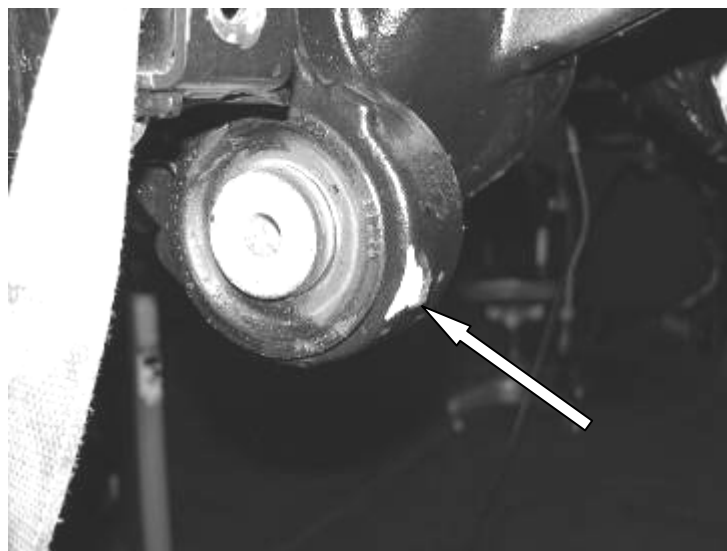

Driver side before grinding

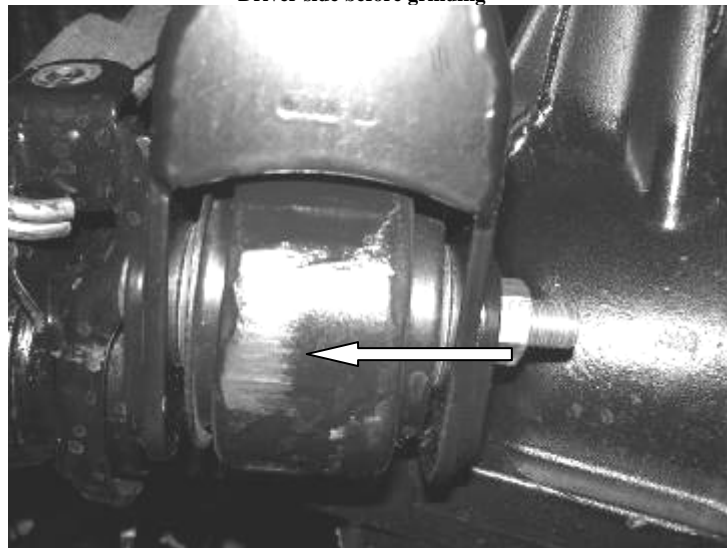

Driver side after grinding

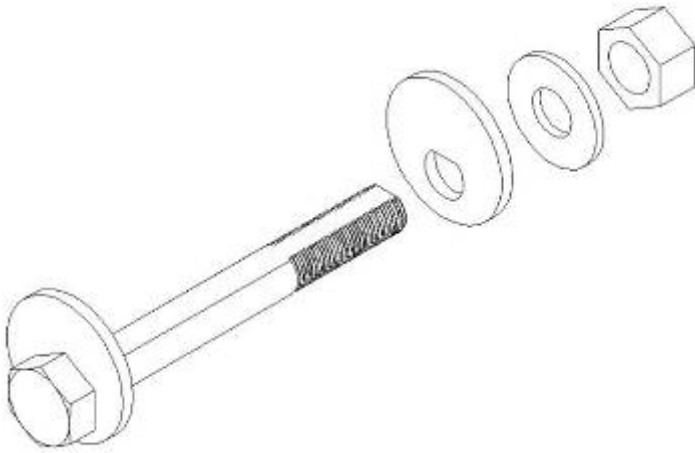

Assembly of the FT292 Alignment Cam



IF INSTALLING A FABTECH COILOVER CONVERSION KIT SEE THE INSTRUCTIONS ENCLOSED WITH THE HOOP KIT AT THIS TIME

IF INSTALLING A FABTECH DUAL SHOCK KIT SEE THE INSTRUCTIONS ENCLOSED WITH THE DUAL SHOCK KIT AT THIS TIME

- Working from both sides of the truck, locate and remove the factory front bump stops and save. These can be removed by pulling on the bump stop itself free from the cup. Remove the factory mounting cup from the frame and discard the hardware. Locate FT30143 Drv. Side front bump stop drop brackets. Using a drill with a 7/16" drill bit, drill out the factory locator pin hole in the frame. Now attach the bump stop to the hole in the frame using the supplied 7/16" x 1 1/2" bolt, nut, and washer. Once attached and aligned with the frame drill the second hole with the 7/16" drill bit. Locate FT30144 Pass. side and center on

the bottom of the frame between the factory rivets. (Pass. side does not have a locating hole). Mark the two holes from the new bracket to the frame and drill the two holes. Attach the bracket to the frame with the supplied 7/16" hardware.

- Locate the factory bumpstop cup and use a die grinder with a cut-off wheel to cut off the locating tab from the bottom. Attach the last hole with the supplied 7/16" x 1 1/2" hardware. Attach the factory bump stop cup to the new bracket using the supplied 5/16" x 1 1/4" bolt, flat washer, and split washer. Before tightening the bolt, align the flat part of the bumpstop cup so it faces outward toward the coil spring. Press the factory bump stop back into the cup. SEE PHOTOS BELOW.

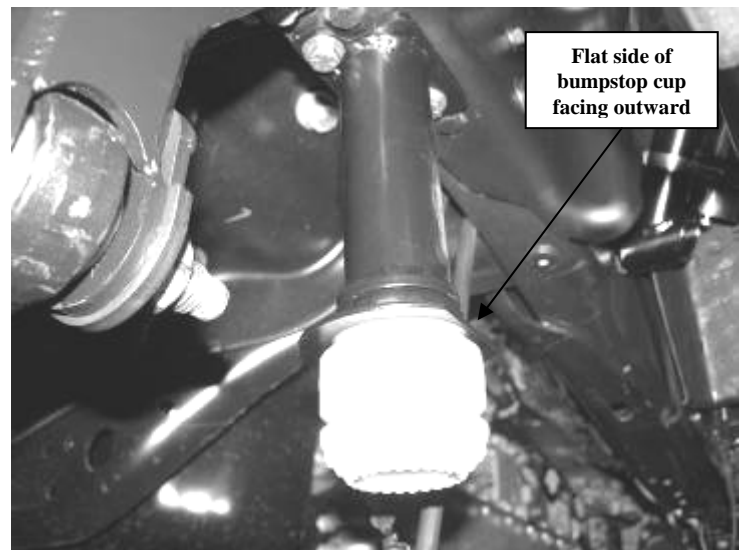

- Using the coil springs from the 6" lift or 8" lift coil spring kit install the coil spring into the truck in the factory location using the original factory upper coil isolator. Make sure that the coil spring is seated correctly in the upper and lower mounts.
- Torque the front and rear radius arm pivot bolts to 200 ft. lbs. **NOTE: SET THE ALIGNMENT CAMS IN THE LOWER FRONT RADIUS ARM IN THE MIDDLE OF ADJUSTMENT BEFORE TORQUING. MAKE SURE**

THE CAM IS SEATED INSIDE THE ALIGNMENT CAM GUIDES.

21. Using a floor jack raise the front axle enough to compress the front coils approx. 1". Locate the correct front shocks FTS7188 for the 6" kit and FTS7189 for the 8" kit and install onto the truck. **Note: Some shock mounts will require cutting a 1/4" from the top of the factory shock tab. If required, use a die grinder with a cut-off wheel and remove the top 1/4" of the tab. Sand and paint bare/exposed metal. SEE PHOTOS BELOW.**



22. Locate the factory brake line mount on the front side of the frame. Remove the bracket from the frame and save the hardware. Locate (FT30276 Front Brake Line Drop Bracket 2008-2010) or the (FT30432 Front Brake Line Drop Bracket 2011-13) and attach to the frame using the original hardware in the factory brake line hole (with the offset of the bracket to the rear of the truck on 2008-2010).

Complete step 23 on 2008-13 models only.

23. Locate FT30409 Hard Brake Line Extension and separate the factory hose from the hard line. Install the supplied

FT30410 union and hard line to the factory hard line. Move to step 27.

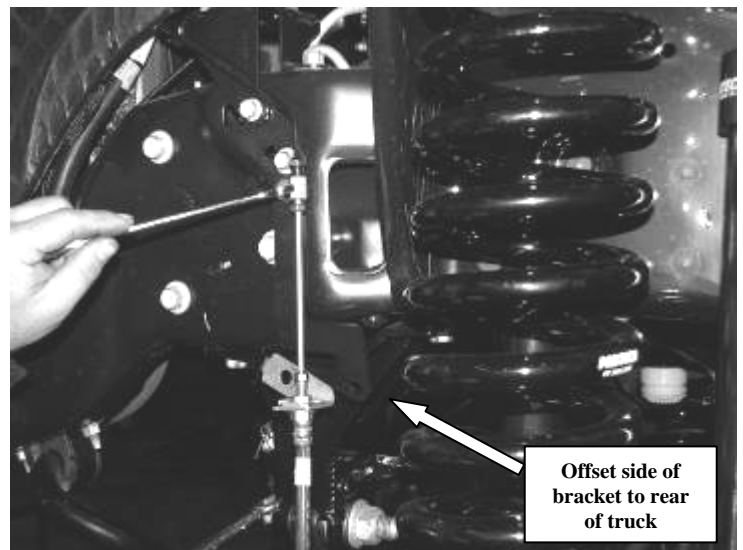
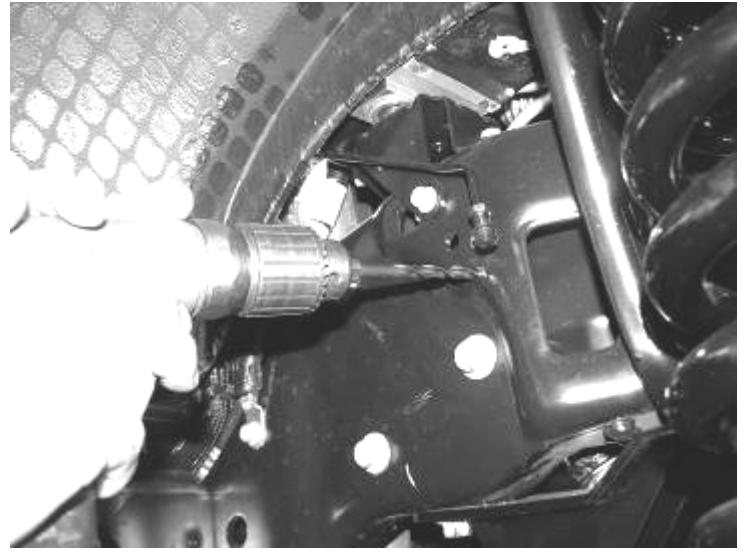

Offset side of
bracket to rear
of truck

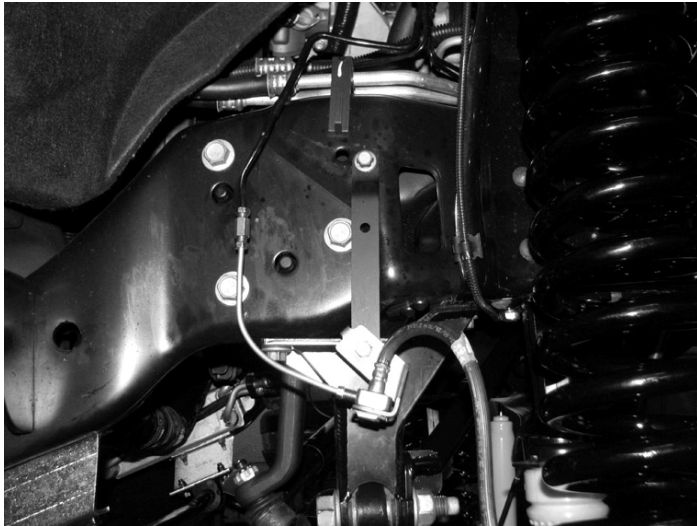
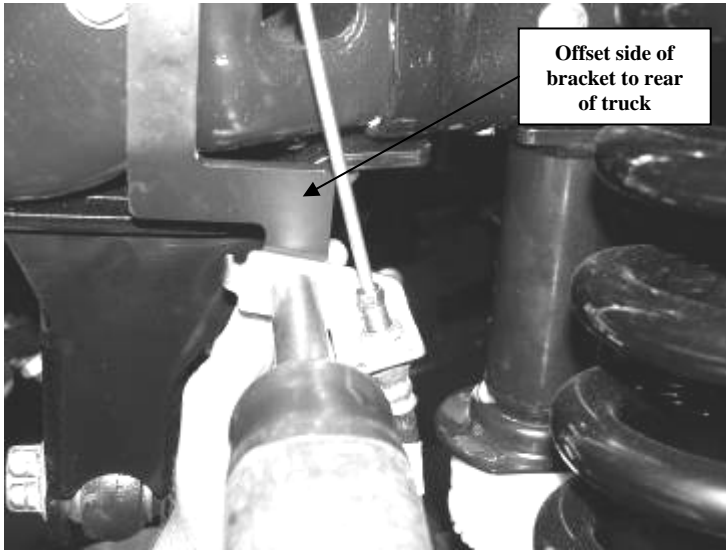

2011 Brake line bracket (FT30432) shown above

Complete step 24-26 on 2014 models only.

24. Remove the bolt holding the brake line to the frame and straighten out the factory hard line.



25. Using a die grinder remove the tang from the factory brake line bracket.

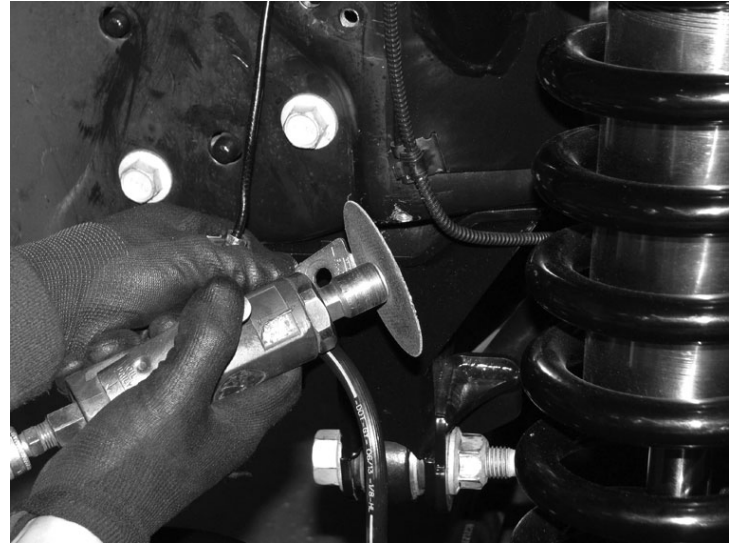

26. Move the bracket down 4" from the factory mounting hole. Using a 1/4" drill bit drill a new hole and remount the factory bracket using the supplied 5/16" self tapping screw. Torque to 14 ft-lbs. Move to step 27.

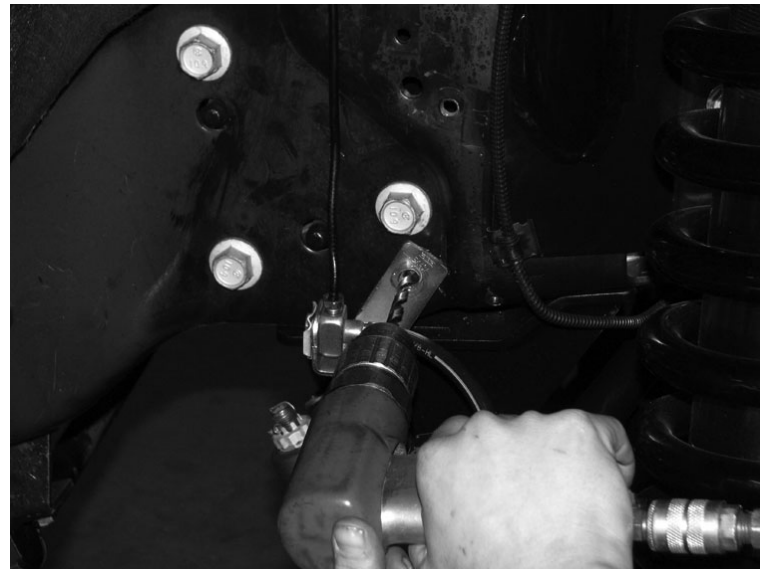

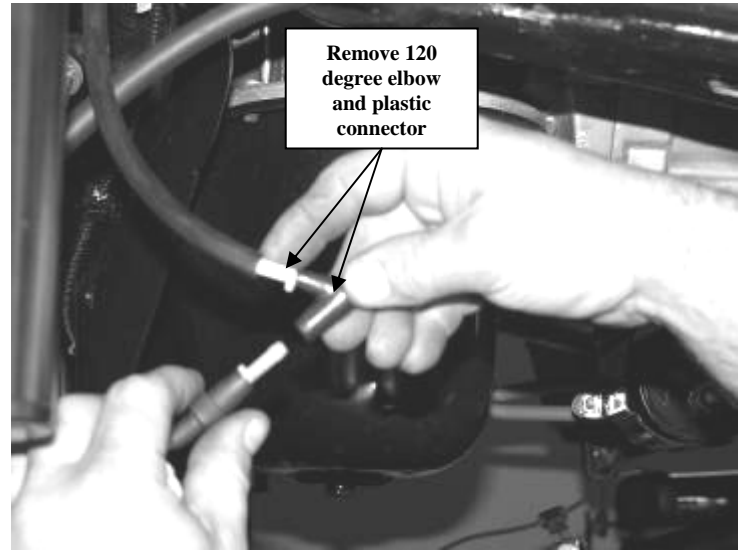
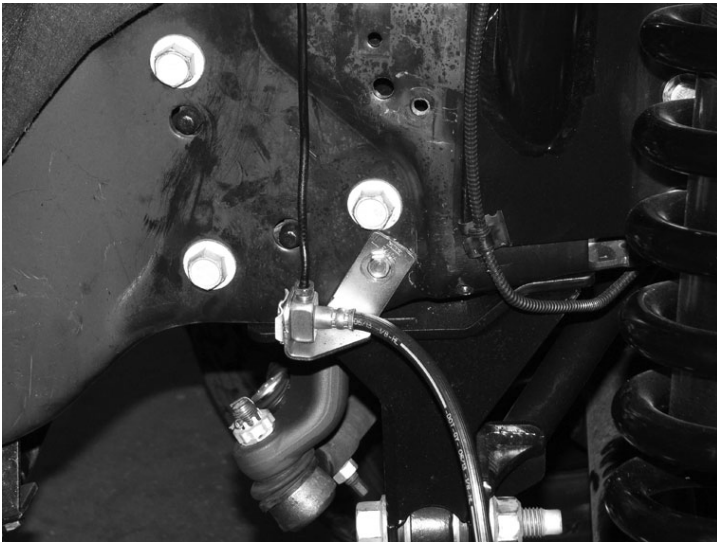

Continue with Step 27 for all models.

27. Working on the driver side, disconnect the four wheel drive vacuum line from the front brake line bracket and reposition and reconnect behind the coil spring mount. Follow the 4wd vacuum line up to the 120 degree connector and remove it from the line and re-connect the lines with the existing line splint. Attach the vacuum line to the ABS line at the coil mount with 2 of the supplied zip ties and attach the vacuum line to the front differential vent hose with 2 more zip ties. **(this keeps all the lines in place during suspension travel, failure to follow this step could cause ABS and / or 4wd failure).** SEE PHOTOS BELOW.

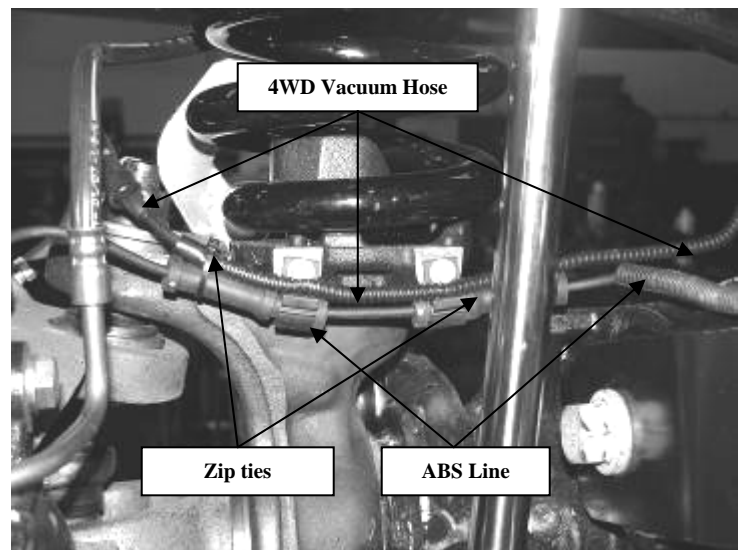
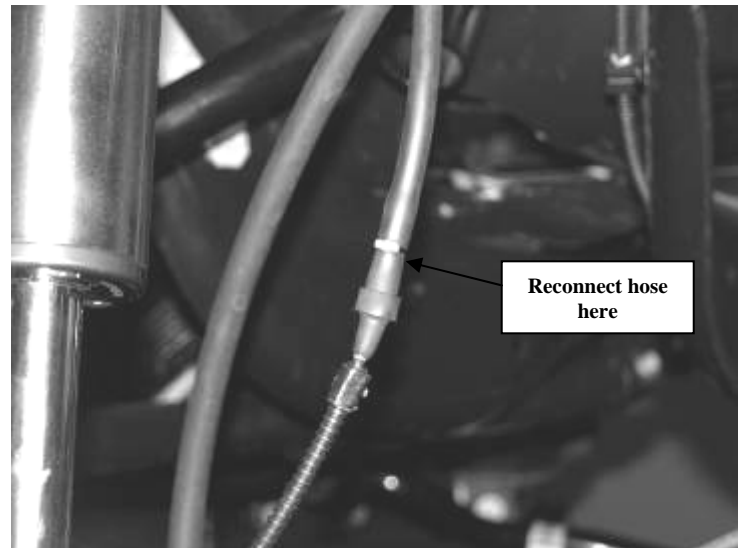

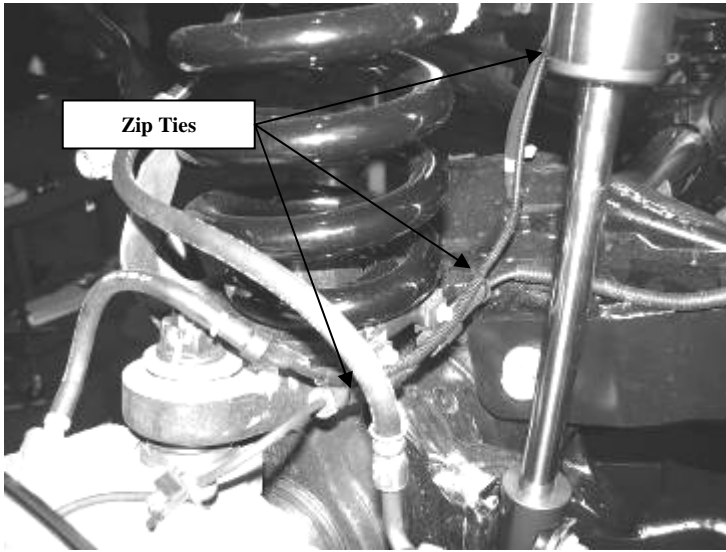

28. Locate stock plastic ABS Line Bracket and the supplied 5/16" hardware. Remove the ABS line from the plastic bracket and use a die grinder with a sanding disc and sand the face of the bracket so that it is flat. Position the bracket on the upper link arm tab and mark the bracket at the hole in the tab. Use a drill with a 5/16" drill bit and drill a hole into the plastic bracket. Use the supplied 5/16" hardware and attach the plastic bracket to the link arm. Remove the ABS socket connector from the frame and re-connect the ABS line. Install the factory front ABS mount onto the front of the link arm and the ABS line mount back into the plastic bracket (this may need to be moved). SEE PHOTO BELOW.



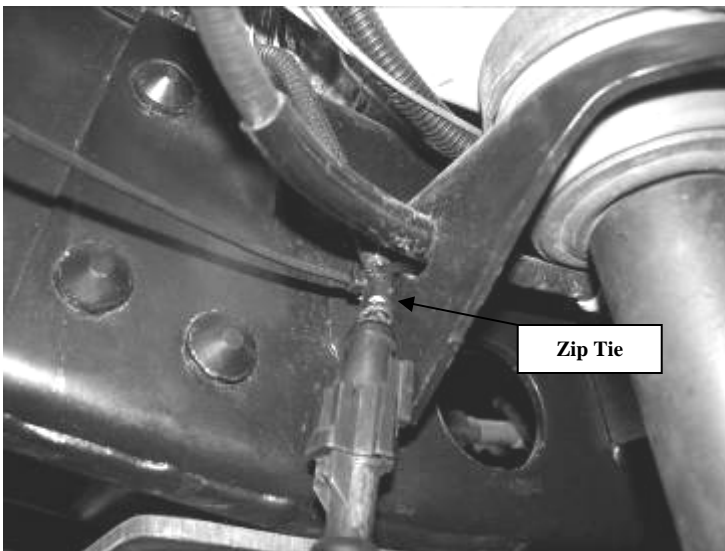
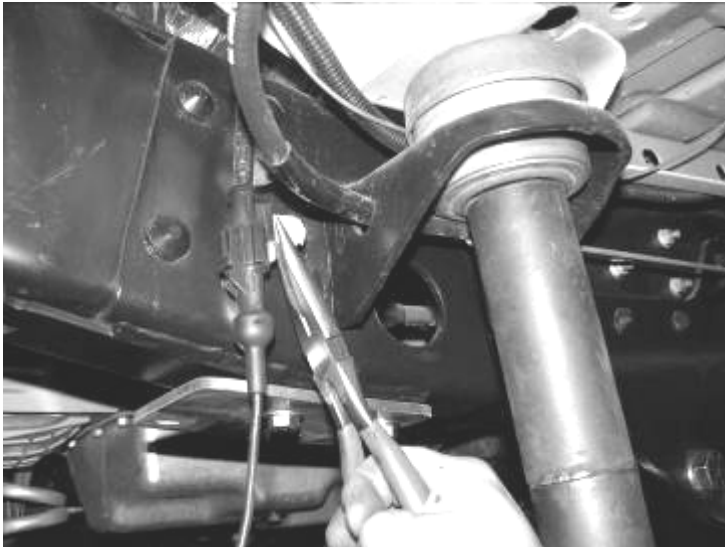
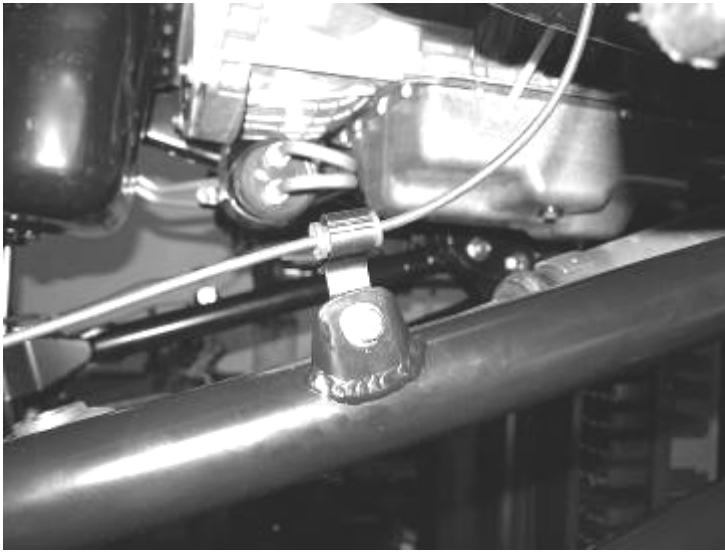

29. Locate FT30402 (08-10) or FT30583BK (11-UP) steering stabilizer drop bracket and install in the factory location using the original hardware. Torque to 50 ft. lbs. Reattach the factory stabilizer to the frame bracket using the original hardware unless installing on 11-UP vehicle use supplied M12 hardware. If installing a Fabtech stabilizer do so at this time. SEE PHOTOS BELOW.



Picture Shown with Factory Stabilizer re-installed



28. Remove the front sway bar from the frame mounts and save the hardware. Locate FT3400-110D & P sway bar frame drop brackets and attach to the frame (AS SHOWN IN PHOTOS) where the sway bar was originally attached using the factory hardware. **MOUNT THE DRIVER SIDE BRACKET (FT3400-110d) ON THE PASSENGER SIDE, AND THE PASSENGER SIDE (FT3400-110p) ON THE DRIVER SIDE.** Using the supplied 7/16" X 1 1/4"

hardware, attach the sway bar to the new drop brackets. Reattach the factory sway bar end links to the axle mounts using the original hardware (**Torque to 40 ft. lbs. once the truck is on the ground; do not tighten while the suspension is in the air**). The new drop brackets are slotted at both mounting points. For the 6" lift, position the frame mount and sway bar all the way forward toward the front of the truck and torque to 35 ft. lbs. For the 8" lift, position the frame mount and sway bar all the way rearward toward the back of the truck and torque to 35 ft. lbs. SEE PHOTO BELOW.



View of outer driver side frame rail



View of inner passenger side frame rail

29. Position the factory trac bar into the new trac bar bracket. Note: You may need to raise the axle up or down to align the hole. Using the original bolt insert it from the front side

of the bracket towards the back. Do not push the bolt fully through at this time.

30. Locate FT30273 trac bar support bracket. First attach it to the forward motor mount bolt on the driver side of the truck, and then line the other end up the trac bar bolt. Torque the factory motor mount bolt to 55 ft. lbs and the trac bar bolt to 400 ft. lbs. SEE PHOTO BELOW.



31. Refer to owner's manual for proper brake bleeding procedure
32. Install front tires and wheels. Torque lug nuts to wheel manufacturer's specifications.
33. Re-check all front hardware at this time for correct torque tightness. Torque the sway bar hardware and endlinks at this time
34. Check the front brake lines and ABS line at this time for proper clearance from all moving parts. You will want to steer the wheels from left to right to make sure the lines clear the wheels. Check fender to tire clearance, trim as needed. Adjust the front headlights.
35. Complete a full alignment on the truck.
36. RETORQUE ALL NUTS, BOLTS AND LUGS AFTER 500 MILES. Re-adjust headlights.

REAR LIFT

SEE THE INSTRUCTIONS ENCLOSED IN THE REAR LIFT BOX KIT.