



**2008 – 2010 FORD F-250/350 4wd
FTS22094BK - 10" COILOVER HOOP CONVERSION**

**2011-15 FORD F-250/350 4wd
FTS22146 - 10" COILOVER HOOP CONVERSION**

	FTS22094BK	Coil Over Conv. Kit (08-10)
Qua	Part #	Description
1	FT30513BK	4.0 Coil Over Hoop Drv.
1	FT30280BK	4.0 Coil Over Hoop Pass.
1	FT30266BK	Driver Lower Mount
1	FT30267BK	Passenger Lower Mount
1	FT30191	Hardware Kit
1	FT20408	Hdwr Sub-Assembly

	FT20408	Hdwr Sub-Assembly Kit (08-10)
Qua	Part #	Description
2	50131501081	1/2"-13 x 1 1/2" Bolt
6	50000005252	1/2" Split Washer
2	31181001152	5/16"-18 x 1" Self Tap Bolt
1	31182001081	Screw 5/16-18 X 2 bolt
1	31180003352	Nut 5/16-18 Stover G5 Z1
1	31000005052	Washer 5/16 SAE G5 Z1
2	12001407100	14" Zip Tie
1	FT161	Sleeve
1	FT30299	Nut Tab Drv
1	FT30300	Nut Tab Pass
1	FT30301	Dual Nut Tab Drv
1	FT30302	Dual Nut Tab Pass
2	FT30197	Upper Limit Strap Bracket
2	FT30270	Lower Limit Strap Bracket
2	FT30192BK	Limited Straps w/ Logo
2	FT22094i	Instruction Sheet
1	FTAS12	Fabtech Sticker
1	FTAS16	Driver Warning
1	FTREGCARD	Reg. Card

	FT30191	Hardware Kit (08-10)
Qua	Description	Location
16	1/2"-13 x 1 1/2" Hex Bolt	Hoop To Frame
6	1/2"-13 x 1 3/4" Hex Bolt	Hoop To Frm To Limit Strap
26	1/2"-13 C-Lock Nut	Bracket & Limit Straps
52	1/2"SAE Flat Washer	
4	7/16"-14 x 1 3/4" Bolt	Hoop To Frame (top)
4	7/16"-14 C-Lock Nut	
8	7/16 SAE Flat Washer	
8	1/4"-20 X 1" Hex Bolt	All Brake Line to Hoop
8	1/4"-20 Nyloc Nut	
16	1/4" SAE Flat Washer	
2	14mm-2.0 x 30mm Bolt	Lower Mount to Axle
2	14mm Flat Washer	
2	18mm-2.5 x 130mm Bolt	Upper Axle Pivot Bolt
2	18mm-2.5 C-Lock Nut	
4	18mm Flat Washer	
1	Lock Tight	

FTS22146		
Coil Over Conv. Kit (2011-2015)		
Qua	Part #	Description
1	FT30513BK	4.0 Coil Over Hoop Drv.
1	FT30280BK	4.0 Coil Over Hoop Pass.
1	FT30266BK	Driver Lower Mount
1	FT30267BK	Passenger Lower Mount
1	FT30191	Hardware Kit
2	FT30456	Axle Swaybar Relocator
1	FT30458	Hdwr Sub-Assembly

FT30451 (2011-2015)		
Qua	Description	
2	14" Black Zip Tie	
4	5/16" SAE Flat Washer	
2	5/16"-18 Lock Nut	
2	5/16"-18 x 1" Self Tap	
2	5/16"-18 x 2" Hex Bolt	
4	1/2" SAE Flat Washer	
6	1/2" Split Lock Washer	
2	1/2"-13 Lock Nut	
2	1/2"-13 x 1-1/4" Bolt	
2	1/2"-13 x 1-1/2" Bolt	

FT30458		
Hdwr Sub-Assembly Kit		
Qua	Part #	Description (2011-2015)
1	FT161	Sleeve
1	FT30299	Nut Tab Drv
1	FT30300	Nut Tab Pass
1	FT30301	Dual Nut Tab Drv
1	FT30302	Dual Nut Tab Pass
2	FT30197	Upper Limit Strap Bracket
2	FT30270	Lower Limit Strap Bracket
2	FT30192BK	Limited Straps w/ Logo
1	FT30451	Hardware Kit
2	FT22094i	Instruction Sheet
1	FTAS12	Fabtech Sticker
1	FTAS16	Driver Warning
1	FTREGCARD	Reg. Card
1	FT30514	ABS BRACKET

CHECK ALL PARTS INCLUDED IN THIS KIT TO THE PARTS LIST ABOVE BEFORE BEGINNING INSTALLATION OF THE KIT. IF ANY PIECES ARE MISSING, CONTACT FABTECH.

FABTECH RECOMMENDS FTS92001 HYDRAULIC BUMP STOP KIT USE ON TRUCKS THAT WILL HAVE HEAVY OFF ROAD USE.

THIS KIT MUST BE INSTALLED WITH FABTECH DIRT LOGIC COILOVER SHOCKS NOT INCLUDED IN THIS BOX KIT.

THIS KIT MUST BE USED WITH FABTECH'S 10" RADIUS ARM SYSTEM OR 10" 4 LINK SYSTEM ONLY.

NOTE: IF YOU HAVE THE FABTECH DUAL SHOCK KIT FTS52002 ON THE VEHICLE, YOU WILL NEED SEVERAL OF THE PARTS THAT WERE DISCARDED DURING THE INSTALL OF THE DUAL SHOCK KIT. THE FORD PARTS REQUIRED ARE THE FACTORY BRAKE LINE BRACKETS AND THE FABTECH PARTS REQUIRED ARE THE SWAY BAR DROP BRACKETS WITH HARDWARE AND SWAY BAR END LINKS WITH THE BUSHINGS AND HARDWARE. CONTACT FABTECH FOR PART NUMBERS IF NESSESARY.

SPANNER WRENCH IS NOT INCLUDED IN THIS KIT,IF NEEDED ORDER FTS89905.

Fabtech suspension systems FTS22092BK & FTS22100BK when used on "Gas engine" trucks will require that the front drive shaft be modified. This is done to give adequate clearance between the driveshaft and the factory exhaust. Fabtech does not recommend modifying the exhaust and / or the catalytic converters.

TOOL LIST:

- Floor jack
- Jack stands
- Assorted metric & S.A.E. wrenches & sockets
- Air Hammer
- Die Grinder with cutoff wheel
- Drill with 7/16" & 1/2" bit

INSTRUCTIONS:

1. Disconnect the negative terminal on the battery. Jack up the front end of the truck and support the front axle with jack stands. **NEVER WORK UNDER AN UNSUPPORTED VEHICLE.** Remove the front tires.
2. Support the front axle with a floor jack. Raise the floor jack approx. 1". Working on both side of the truck, remove the front shocks and discard. Save the factory lower shock bolt and nut tab. Disconnect the front sway bar end links from the axle mount and save the hardware.
3. Remove the brake line bracket from the frame rail and discard hardware. If a Fabtech kit has already been installed remove the brake line drop bracket supplied with that kit, remove it from the frame and save with hardware. Remove the brake line and ABS line mounts from the lower coil perch and discard the hardware.
4. Remove the trac bar bracket from the driver side of the frame and save the hardware.
5. Lower the floor jack supporting the axle down until the coil springs are free of tension. Remove the coil springs and discard.
6. Locate bump stop on the bottom of the frame below the coil bucket and remove. If you have a Fabtech kit that has already been installed on the truck, remove the bump stop along with the drop bracket and discard. The installation of the coil over kit does not require the installation of a bump stop.
7. Working from the driver's of the truck, using a die grinder with a cut off wheel cut all the heads of the rivet in a cross pattern that attach the factory coil bucket to the frame. Using an air chisel, remove the heads of the rivets and pry the coil bucket free from the frame. With the bucket removed from the frame use a hammer and center punch and knock the rest of the rivets out of the holes in the frame. SEE PHOTOS BELOW.

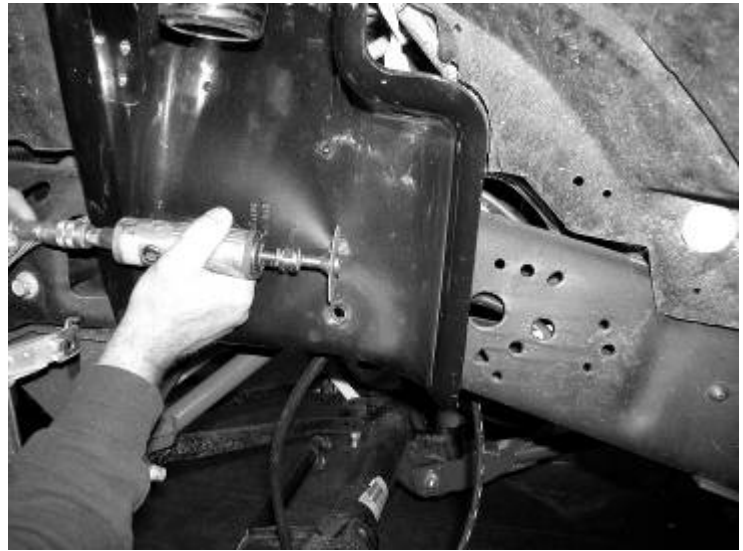

8. Using a drill with a 1/2" bit, drill all the holes on the outside, and bottom of the frame that the hoop will be mounting to. (due to variances from truck to truck, you might have to use the coil buckets as a template to drill each hole) SEE PHOTO BELOW.



9. Locate the factory lower coil perch on the axle and remove. Discard the perch and hardware.
10. Using a sharp razor blade cut a 6" x 4" rectangle in the plastic inner fender well as shown below. When cutting the inner fender well do not cut the heat shield felt on the backside of the inner fender well. (each truck will vary, trim fender well as necessary) SEE PHOTOS BELOW.



Passenger Side Cut

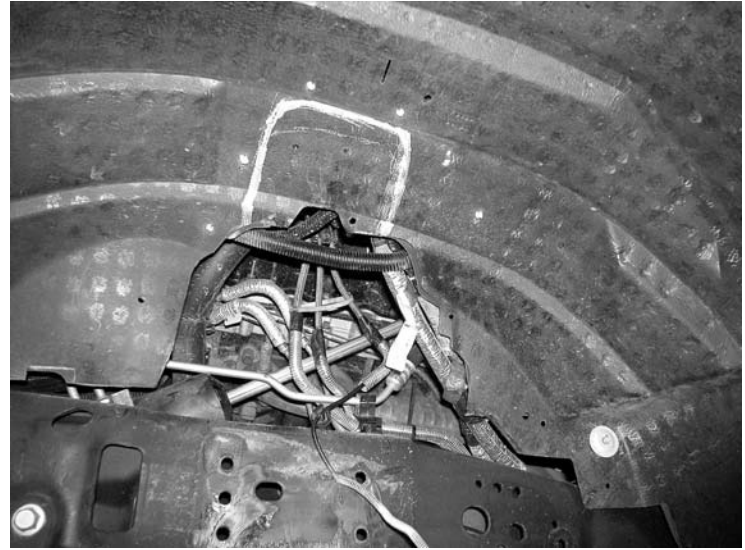

Driver Side Uncut But Marked

11. Repeat steps eight through eleven on the passenger side of the truck. Remove the wiring harness from the face of the frame and save the hardware. Carefully bend the A/C lines to make room for the coilover bucket. SEE PHOTO BELOW.



Photo shows bent A/C line

12. Locate the upper axle pivot on the front axle. Remove the bolt and discard. Locate FT30270 lower limit strap bracket and attach to the inside of the upper pivot using the supplied 18mm x 130mm bolt, nut, and washer. If installing this kit on an 8" kit the long end of the bracket will be facing upward and on a 6" kit the short end will be facing up. SEE PHOTO BELOW.

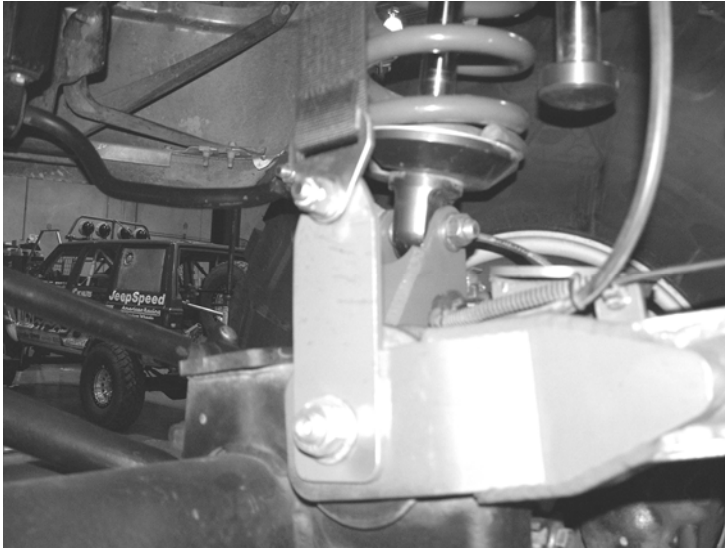

Picture Shown With Tab Set Up For 10" Kit

13. Working from the driver side of the truck, locate FT30266 lower coil over axle mount. Place the mount on the axle where the factory coil perch was located, aligning the arm of the new perch into the factory lower shock mount on the axle. Using the supplied 14mm bolt and washer and small amount of the supplied thread locking compound attach it to the axle. Using the original lower shock bolt and nut tab attach the support arm of the mount to the factory shock mount on the axle. Torque the 14mm bolt to 100 ft. lbs. and the support arm bolt to 80 ft. lbs. SEE PHOTO BELOW.

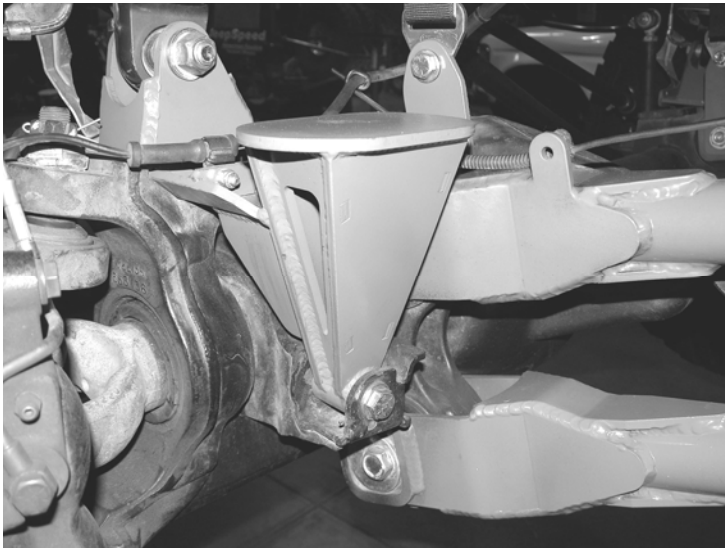

Driver side shown

14. Locate FT30513BK (driver side) Coil Over Hoop and align onto the frame where the factory bucket was mounted. Align the holes in the hoop to the holes in the frame. Using the supplied 1/2" x 1 1/2" hardware on the holes on the outside of the frame attach the hoop to the frame, leave loose at this time.
15. Drill the three rear holes to 1/2" through the frame. Locate FT30299 & FT30301 nut tabs and use the supplied 1/2" x 1 1/2" hardware attach to the frame. Locate FT161 Sleeve and the supplied 5/16"x2" hardware. Attach the power steering line bracket to the back of the bucket and torque to 15lbs. **NOTE: on 11-up vehicles install FT30514 (ABS Bracket) on the backside of the hoop.** Once tightened, make sure that the lines are NOT making contact with the hoop. Carefully

bend them for additional clearance if needed. Repeat steps 14 & 15 on the passenger side of the truck.

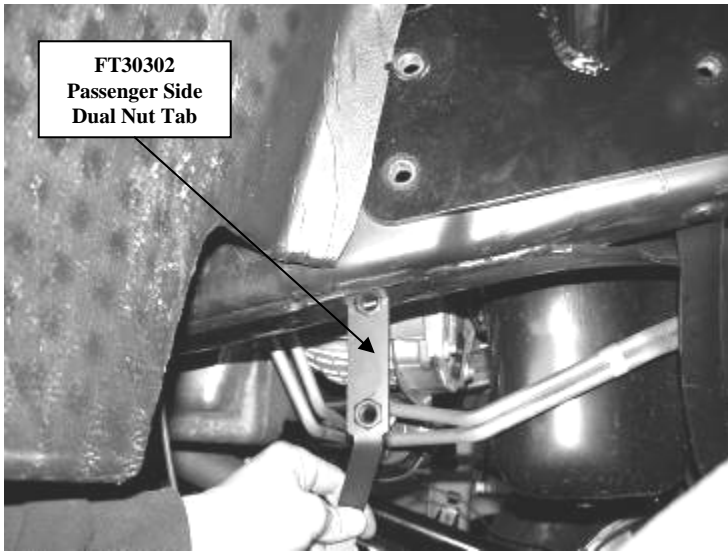

**FT30302
Passenger Side
Dual Nut Tab**

Passenger side Shown

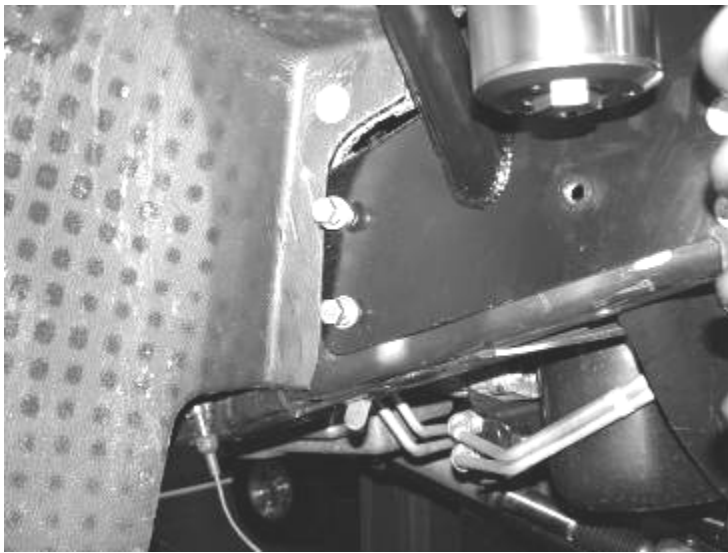

Passenger side Shown

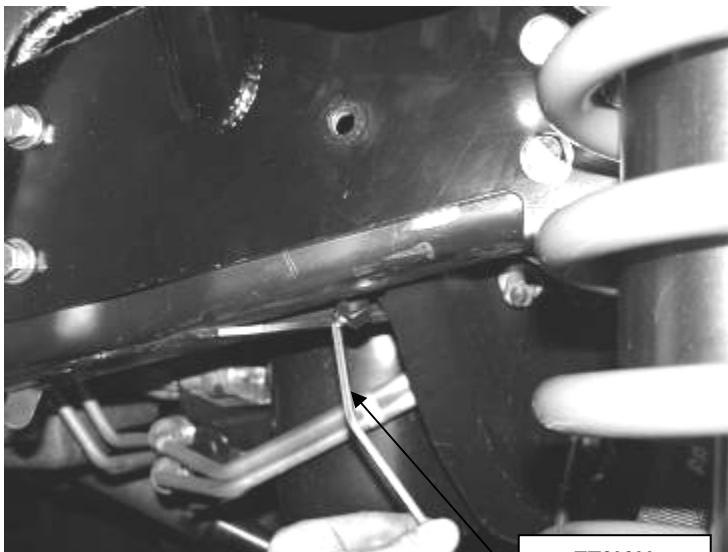

Passenger side Shown

**FT30300
Passenger
Single Nut Tab**

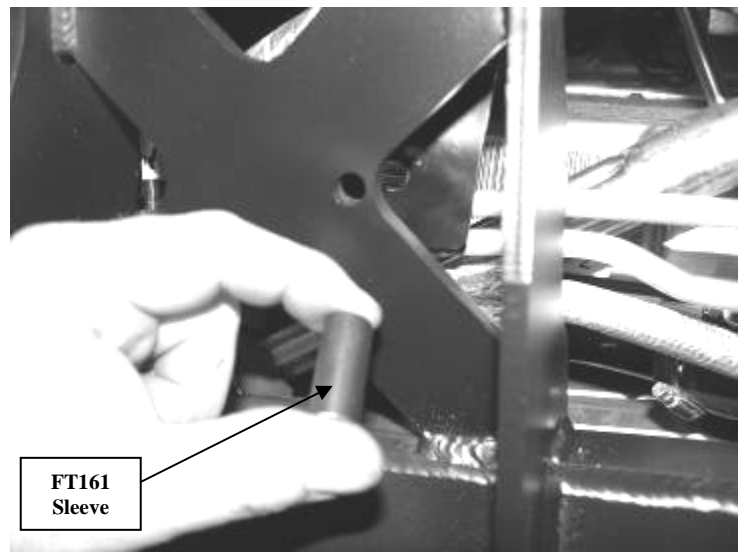
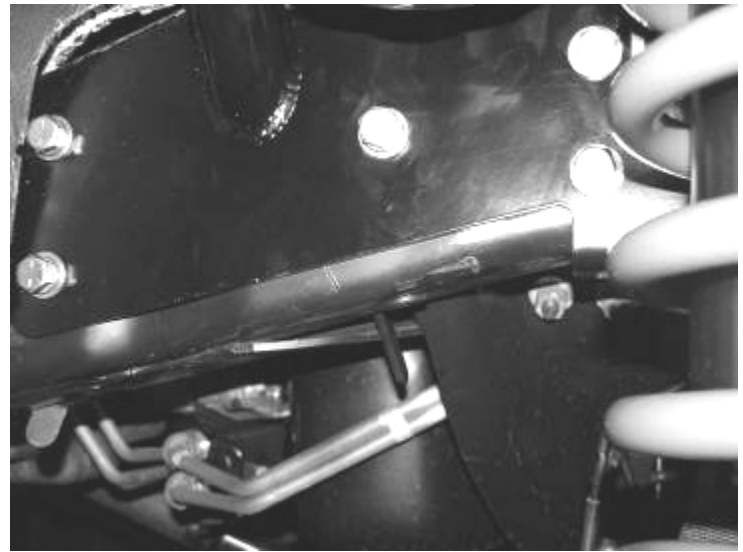

**FT161
Sleeve**

Driver side shown

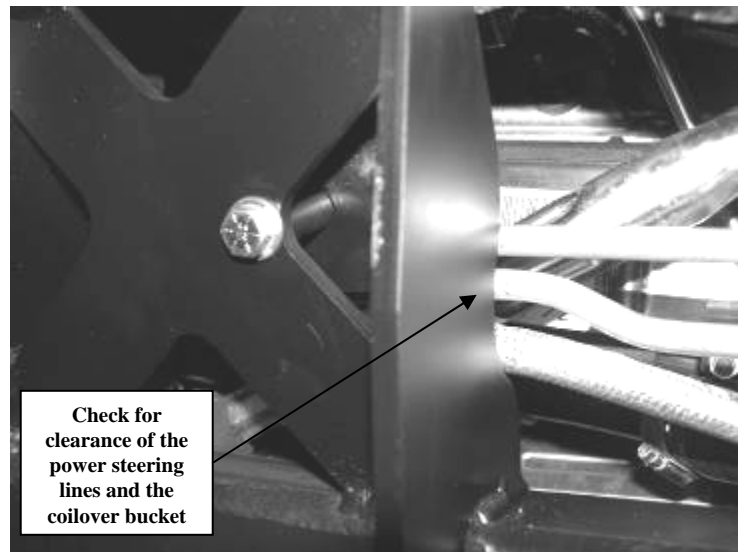

**Check for
clearance of the
power steering
lines and the
coilover bucket**

Driver side shown

16. Reinstall the trac bar bracket to the frame and torque the frame mount bolts to 80 ft. lbs & motor mount bolt to 55 ft. lbs & trac bar bolt to 400 ft. lbs.

17. Locate FT30197 upper limit strap bracket. Place the bracket on the inside of the frame to the rear hole on the bottom of the frame (the long side of the bracket mounts to the frame with the short side attaching to the strap). Using the supplied 1/2" x 1 3/4" hardware, attach it to the frame. Attach the forward hole of the hoop to the frame with the supplied 1/2" x 1 1/2" hardware at this time also. Torque to 50 ft. lbs. SEE PHOTO BELOW

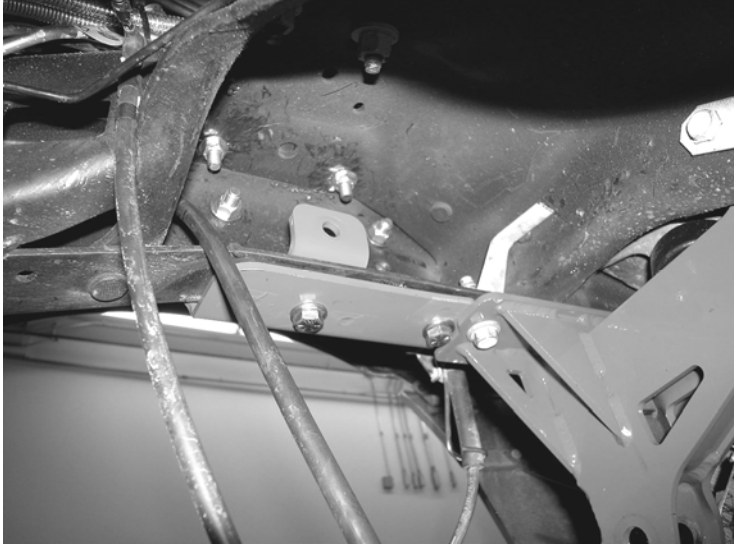

18. If installing Fabtech's optional Hydraulic front bump stop kit do so at this time.
19. Locate the supplied two large zip ties. Use the zip ties and attach the wiring harness to the power steering lines inside the driver's side wheel well. SEE PHOTO BELOW.



20. Locate the two holes on the passenger side coilover hoop. The top hole will need to be drilled out to 17/64". Locate the electrical wiring harness on the passenger side which was removed earlier during install and attach to the coil bucket with the factory hardware. SEE PHOTO BELOW



22. Insert one of the supplied FT83034 mis-alignment spacers to each side of the top bearing in the shock. Next locate the supplied FT1040 and FT1041 Delron bushings and place the one with the larger inner ring on the side of the bearing without the snap ring and the one with the smaller inner ring on the side with the snap ring. Insert the top of the coil over into the coil over hoop. Using the supplied 5/8" x 3.5" bolt and washers and FT30183 nut tab connect the coil over to the hoop. SEE DIAGRAM ON LAST PAGE.
23. Locate the last two FT83034 mis-alignment spacers and insert them into the bearing on the bottom of the shock. Using the supplied 5/8" x 3.5" bolt, nut, and washer attach it to the lower mount on the axle.

24. Install the supplied limit straps to the upper and lower mounts using the supplied $\frac{1}{2}$ " x $1\frac{3}{4}$ " bolt, nuts, and washers. You will use a $\frac{1}{2}$ " washer between the limit strap and mounting brackets on both upper and lower mounts. SEE DIAGRAM BELOW.

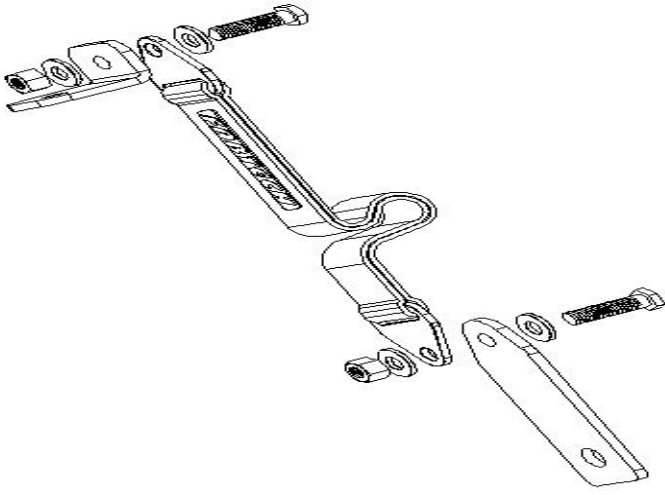

25. Using the Supplied $\frac{1}{4}$ " x 1" bolt, nut, and washer attach the ABS line to the new lower coil perch as shown below. The original line clamps will be reused. SEE PHOTO BELOW.

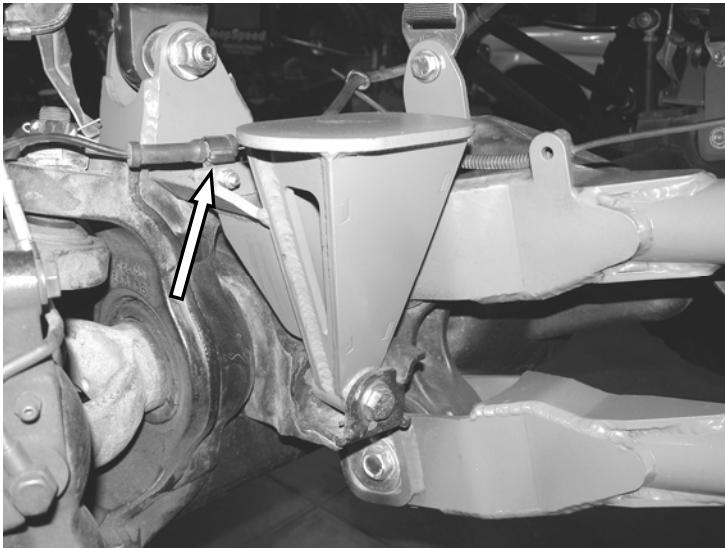

26. Re-attach the brake line bracket using the original hardware to the frame. You will need to carefully pull the hard line free from the frame. Re-install the brake calipers and torque caliper bolts to 130lbs.
27. Attach the lower brake line bracket to the new lower coil over mount using the supplied $\frac{1}{4}$ " x 1" bolt, nut, and washer.
28. Make sure the vacuum line from the hub assembly is still routed in the stock position. If the line is tight carefully pull some slack free from the frame mounts. SEE PHOTO BELOW.

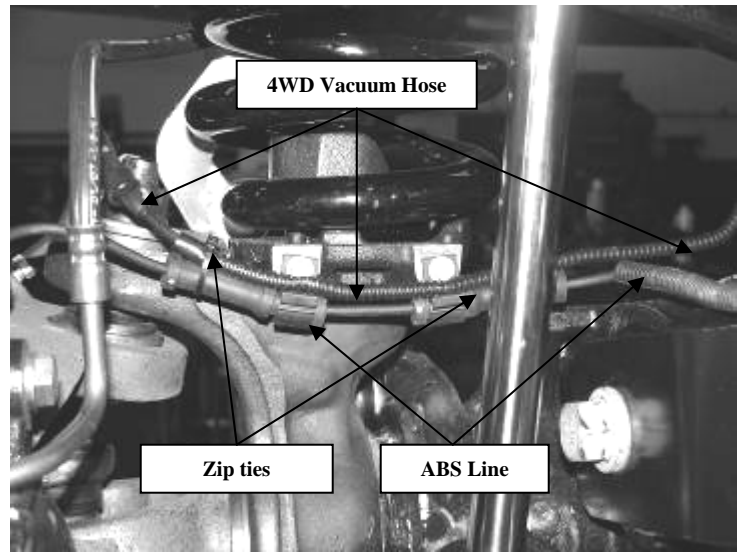

29. Reconnect the front sway bar back to the axle mount using the original hardware. On 2011 models use the FT30456 sway bar relocation bracket. Mount the bracket using a $\frac{1}{2}$ - 13 x $1\frac{1}{2}$ bolt, c lock nut and washers. Torque to 90 ft-lbs. SEE PHOTO BELOW.



30. Reinstall the front tires and set the truck back on the ground. Turning the steering wheel fully in each direction, check for contact between the tires and any newly installed components. Drive the truck fifty miles and complete a full front end alignment. Re-adjust headlights.

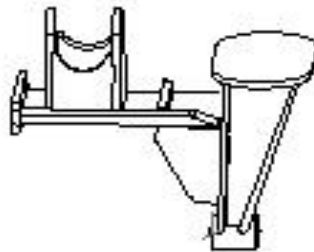
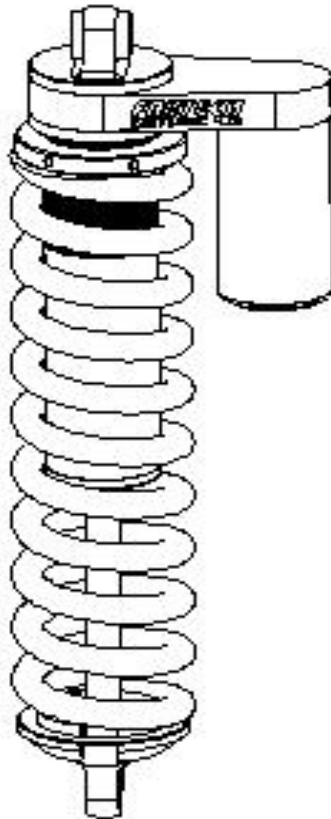
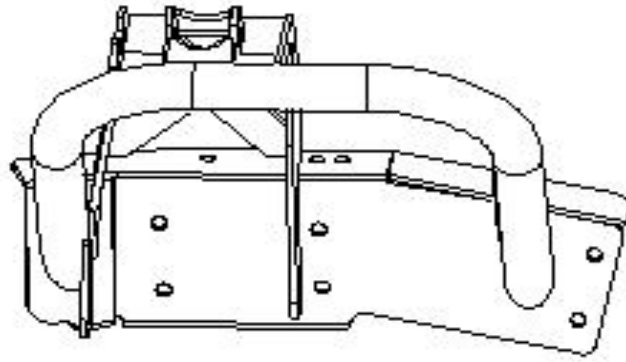

Driver Side Shown

RETORQUE ALL NUTS, BOLTS AND LUGS AFTER 50 MILES AND PERIODICALLY THEREAFTER.