



**2005 - 2007 FORD F250 / F350 2WD**

**6" BASIC KIT**

**FTS22056BK**





**2005 - 2006 FORD F250 / F350  
6" BASIC KIT**

**PARTS LIST**

<b>FTS22056BK</b>		<b>6" Basic Kit</b>
<b>Qty</b>	<b>Part #</b>	<b>Description</b>
1	FT30467BK	Radius Arm Drop Drv & Pass
1	FT410-104BK	Driver I-Beam Bracket
1	FT410-103BK	Pass. I-Beam Bracket
1	FT30217	Hardware Kit
2	FT22056i	Instruction Sheet

<b>FTS22058BK</b>		<b>S.D. 2WD 6" Coil V10&amp;Diesel</b>
<b>Qty</b>	<b>Part #</b>	<b>Description</b>
2	FT137BK	Coil 6" Diesel or Gas
1	FT30338	Hdwr Sub-Assembly
2	FT30169BK	Sway Bar Drop
2	FT410-107BK	Bump Stop Drop
1	FT30205	Steering Stabilizer Drop
1	FT30122	Pitman Arm

<b>FT30338</b>		<b>Hdwr Sub-Assembly Kit</b>
<b>Qty</b>	<b>Part #</b>	<b>Description</b>
2	FT30208	Brake Line Drop Bracket
1	FT30206	Pitman Arm Spacer
1	FT30258	Sector Shaft Arm Nut
2	FT410-108	Coil Spacer
2	FT594	Alignment Cam
2	FTT79	Brake Line Clip
1	FTAS12	Fabtech Sticker
1	FTAS16	Driver Warning
1	FTREGCARD	Reg. Card

<b>FT30217 Hardware Kit</b>	
<b>Qty</b>	<b>Description</b>
2	1/4"-20 x 1" hex head bolt
2	1/4"-20 nylock nut
4	1/4" SAE flat washer
6	7/16"-14 x 1 1/2" hex head bolt
6	7/16"-14 nylock nut
12	7/16" SAE flat washer
1	1/2"-13 x 1" hex head bolt
7	1/2"-13 x 1 1/4" hex head bolt
4	1/2"-13 x 1 1/2" hex head bolt
3	1/2"-13 x 3 1/2" hex head bolt
2	1/2"-13 x 4" hex head bolt
17	1/2"-13 nylock nut
36	1/2" SAE flat washer
4	1/2" USS flat washer
8	3/4"-10 x 1 1/2" Bolts
8	3/4"-10 C-Lock Nut
16	3/4" Flat Washer
1	1/8" x 2" cotter pin
1	Loc-Tight



**2005 - 2006 FORD F250 / F350  
6" BASIC KIT**

**TOOL LIST:**

- FLOOR JACKS
- JACK STANDS
- DRILL WITH ASSORTED BITS
- ASSORTED METRIC & SAE WRENCHES & SOCKETS
- TORQUE WRENCH
- AIR HAMMER WITH CHISEL & PUNCH BITS
- DIE GRINDER WITH CUT -OFF WHEEL

**READ BELOW BEFORE INSTALLING THIS KIT**

**CHECK ALL PARTS INCLUDED IN THIS KIT TO THE PARTS LIST ABOVE BEFORE BEGINNING INSTALLATION OF THE KIT.**

**THIS SUSPENSION SYSTEM MUST BE INSTALLED WITH FABTECH SHOCK ASBORBERS**

**VEHICLES THAT WILL RECEIVE OVERSIZED TIRES SHOULD CHECK BALL JOINTS, TIE RODS ENDS AND IDLER ARM EVERY 2500-5000 MILES FOR WEAR AND REPLACE AS NEEDED**

**PRIOR TO THE INSTALLATION OF THIS SUSPENSION SYSTEM A FRONT END ALIGNMENT MUST BE PERFORMED AND RECORDED. DO NOT INSTALL THIS SYSTEM IF THE VEHICLE ALIGNMENT IS NOT WITHIN FACTORY SPECIFICATIONS. CHECK FOR FRAME AND SUSPENSION DAMAGE PRIOR TO INSTALLATION.**

**READ ALL INSTRUCTIONS THOROUGHLY FROM START TO FINISH BEFORE BEGINNING INSTALLATION.**

**FABTECH RECOMMENDS THAT YOU EXERCISE EXTREME CAUTION WHEN WORKING WITH COIL SPRINGS TO AVOID ANY POSSIBILITY OF INJURY.**

## INSTRUCTIONS:

1. Disconnect the negative terminal on the battery. Jack up the front end of the truck and support the frame at the front frame rails with jack stands. **NEVER WORK UNDER AN UNSUPPORTED VEHICLE.** Remove the front tires. Disconnect the negative terminal on the battery.
2. Working on both sides of the truck, disconnect the A.B.S. sensor at its connection point at the back of the wheel liner and from the plastic clamps along the brake line (do not remove from the spindle). Next remove the brake caliper and tie it up out of the way and save the hardware. **DO NOT ALLOW THE CALIPERS TO HANG FROM THE BRAKE LINES!** Remove the front shocks and the sway bar with the end links from the truck. Save the shock and the sway bar and hardware. Loosen the I-Beam pivot bolts, **DO NOT REMOVE THE BOLTS FROM THE I-BEAM BRACKET.** SEE PHOTO BELOW

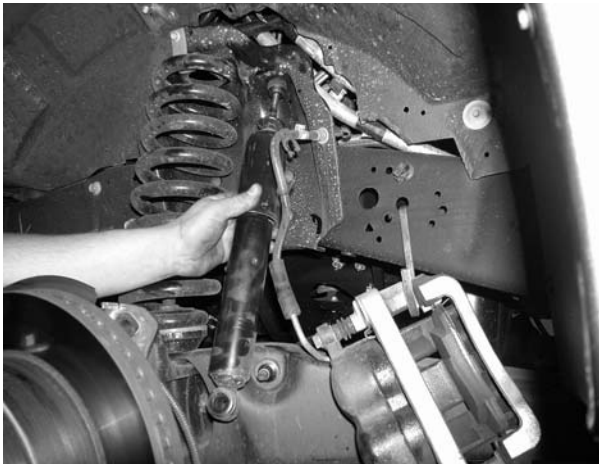

3. Working from the driver side of the truck, support the I-beam with a jack and remove the J clip at the top of the coil spring. **EXERCISE EXTREME CAUTION WHEN WORKING WITH COIL SPRINGS UNDER LOAD!** Lower the floor jack supporting the I-beam and remove the nut at the bottom of the coil spring. Discard the coil spring, and save all hardware.
4. Remove the nut and bolt at the end of the radius arm and the bolt securing the radius arm to the I Beam. Separate the radius arm from the I Beam and save all of the hardware and the radius arm.
5. Supporting the factory I-beam with a floor jack, remove the factory I-beam pivot bolt and save. Lower the floor jack removing the I beam from the truck.
6. Repeat steps three through five on the passenger side of the truck.

7. Working from both sides of the truck, locate and remove the factory front bump stops and save. These can be removed by pulling on the bump stop itself from the cup. Remove the factory mounting cup from the frame and save it and the hardware. SEE PHOTO BELOW



8. Locate the two rivets on the bottom of the coil bucket. Using a die grinder with a cutoff wheel, make an X cut on the face of the rivet. Next, using an air chisel, remove the rivets from the bucket and frame. Using a drill, drill the two holes out to 1/2".
9. Locate FT410-106 and FT410-107 front bump stop drop brackets and 1/2" x 1 1/2" bolt and hardware. Attach the bump stop brackets to the frame to the two holes that you previously removed the rivets from and torque the bolts to 50lbs. Now attach the bump stop cup to the new brackets using the factory hardware. Press the factory bump stop back into the cup. SEE PHOTO BELOW.



10. Separate the drag link from the pitman arm. Remove the factory pitman arm from the steering box using a large pitman arm puller or large two-jaw puller. Save the hardware and discard the pitman arm. SEE PHOTO ON NEXT PAGE.

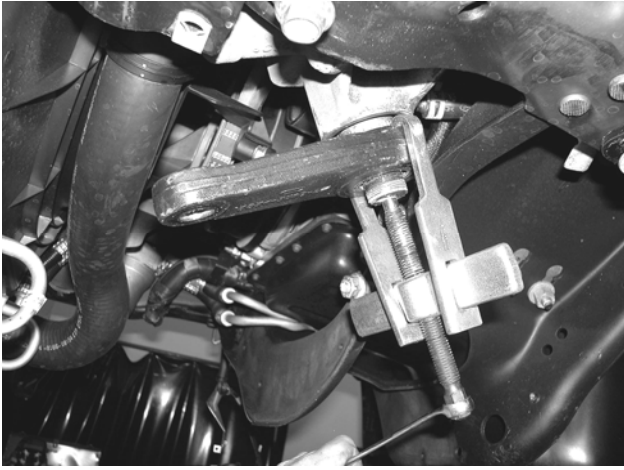

11. Locate FTS30122 new drop pitman arm. Attach to the steering box in the same indexed position as the factory pitman arm was when removed. **Install the provided FT30258 Sector Shaft Nut and torque to 350 ft. lbs. (Note: this is a one-time only use nut, once it is tightened on the sector shaft and removed, it must be discarded. SEE PHOTO BELOW.**



12. Remove the factory steering stabilizer from the frame bracket and save the hardware. Remove the bracket from the frame and discard and save the hardware.
13. Remove the factory I beam brackets from the frame. Discard the brackets and hardware.
14. Locate FT410-104 & FT410-103 I-beam drop brackets and place the brackets against the frame in the factory I-beam pivot location. Attach the new drop brackets to the frame using the included hardware. You will reuse most of the factory holes and have to drill some new ones. Locate the existing holes with the supplied bolts and mark the new holes that must be drilled with a center punch. Drill the holes with a pilot drill (1/8") and follow through with a 1/2" drill. **BE SURE THERE IS NOTHING BEHIND THE FRAME SECTIONS YOU ARE DRILLING THROUGH, PLACE A PIECE OF PLATE STEEL ABOVE THE FRAME BELOW THE OIL PAN TO**

**PREVENT DRILLING INTO THE PAN.**

Tighten all the fasteners securing the brackets to the frame and torque to 75lbs. SEE PHOTOS BELOW.

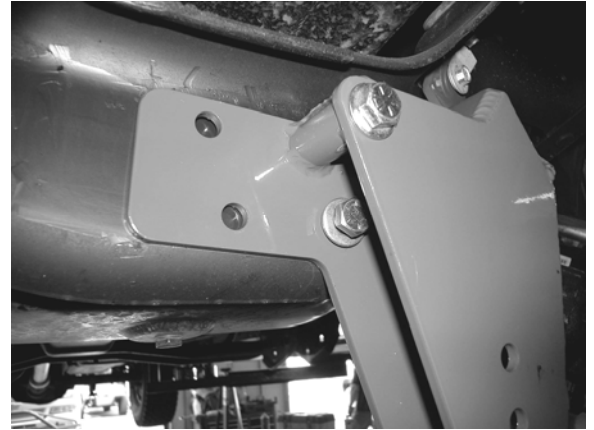

**Driver Side I-beam Bracket**  
*Passenger I-Beam connection point*

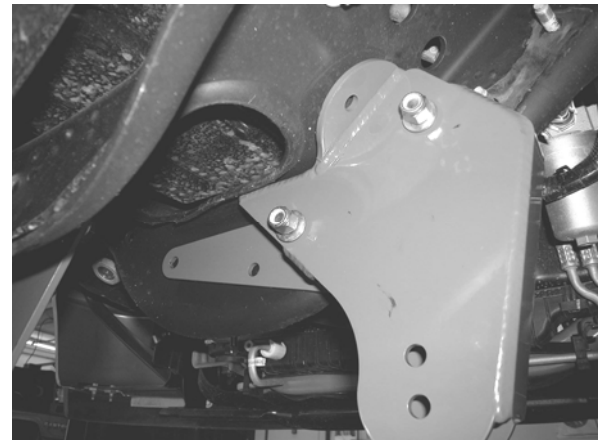

**Passenger Side I-beam Bracket**  
*Driver I-Beam connection point*

15. Attach the factory I-beams to the new drop brackets in the bottom holes re-using the factory bolts, leave loose at this time.
16. Working from the driver side of the truck, locate FT30467 (driver) and (pass) radius arm drop bracket. Place the bracket into the factory radius arm pockets on the frame. Attach the bracket to the factory pocket using the supplied 3/4" x 1 1/2" bolts, nuts, and washers through the original holes in the frame. Torque bolts to 100 ft. lbs.
17. Once the new brackets are bolted in the stock pockets, locate the 7/16" hole in the bottom of the new bracket. Using a drill with a 7/16" drill bit, drill through the bracket into the stock pocket. Attach using the supplied 7/16" x 1 1/2" bolts, nuts, and hardware. SEE PHOTOS ON NEXT PAGE.

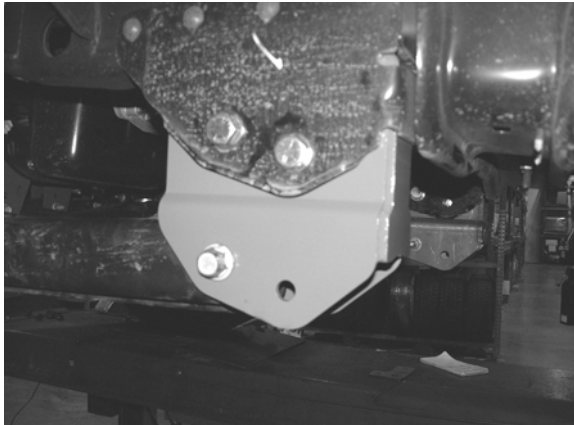
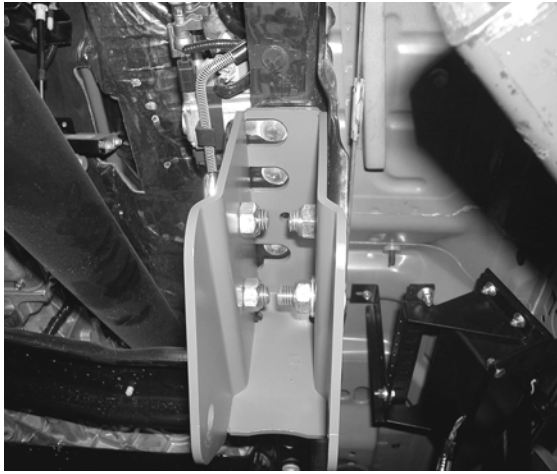
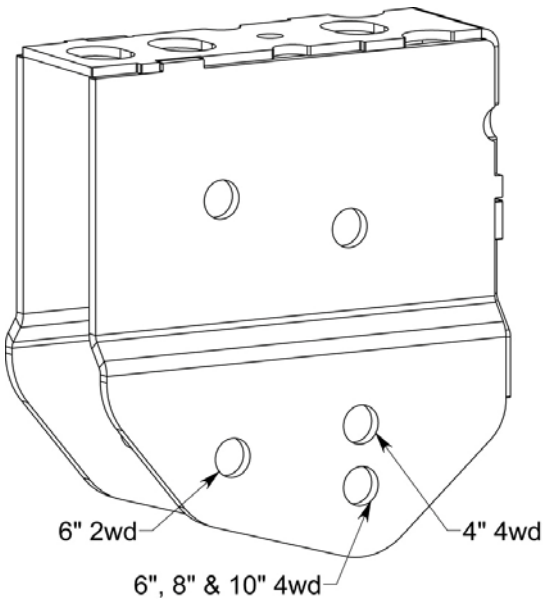
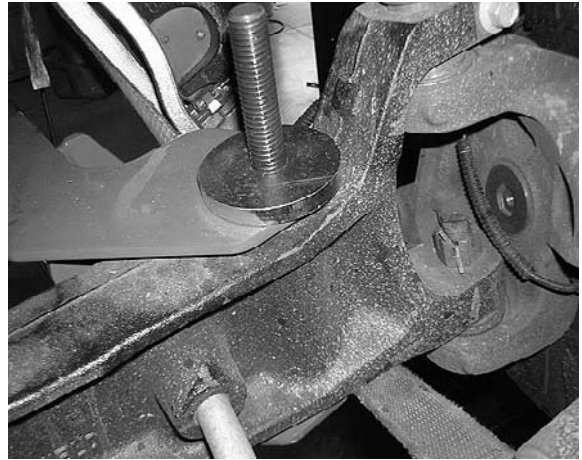

Photo Shown w/Radius Arm Installed

18. Locate both driver and passenger side factory radius arms and radius arm bolts. Attach both the driver and passenger radius arms to the I-Beams using the original hardware, just insert the bolt at this time with no nut. Attach the other end of the radius arms to the frame mounts using the original hardware. When mounting the radius arm to the new drop bracket you will use forward hole. Leave loose at this time. SEE DRAWING BELOW.



19. Locate the FT410-108 Coil Spacers. Place the spacer on the bolt that connects the I-beam and radius arm that was previously installed. Then place the factory nut on the bolt and torque to 150 ft. lbs. SEE PHOTO IN NEXT COLUMN.



Picture Shown w/Optional Radius Arm

20. Locate the lift coil springs and factory lower coil spring perch. Place the perch on top of the coil spacer along with the factory nylon lower coil seat. Seat the coil on the perch first, then into the coil bucket on the frame. Using the original nut and coil retainer attach the coil spring to the I Beam. Using the original "J" clip and original hardware attach the top of coil to the coil bucket. **NOTE-when installing the "J" clip, it will only grab the coil spring and not the bucket like it was factory.** SEE PHOTOS BELOW.



21. Using a floor jack, raise the front I-Beam enough to compress the front coils approx. 1". Locate the FTS7236 front shocks ( not included in kit ). The factory upper shock bushings must be removed from the coil bucket prior to installing the shocks. Install the top of the shocks using the supplied bushings and hardware and attach the lower mount with the original hardware. Tighten the top shock nuts until the bushings start to bulge and torque the lower bolts to 35 ft lbs. Torque the Radius Arm bolts to 200 lbs and the I-Beam pivot bolts to 150 lbs.

22. Locate the factory brake line mount on the rear of the coil bucket. Remove the clip that mounts the line to the bucket. Measure 3" down from the factory hole and drill a 1/4" hole. Locate FT30208 front brake line bracket and attach it to brake line with the supplied FTT79 clip. You will need to carefully bend the hard line down to meet the new brake line bracket location. **USE CARE NOT TO DAMAGE THE HARD LINE.** Using the supplied 1/4"-20 x 1" hardware, attach the brake line bracket to the coil bucket. Re-install the front brake caliper with original hardware and torque to factory spec. SEE PHOTO BELOW.



23. Locate the ABS sensor connection point in the back of the plastic wheel well. The end of the plug is slid into a clip on the liner that is mounted by two push in plastic plugs. Use care in removing the clip and the plastic plugs, they will be re-used. Using a drill with a 1/4" bit, drill the upper hole to 1/4". Re-insert the clip with the socket inverted, that way the end of the plug is now facing upward. Re-connect the sensor and continue to route the ABS line back into the stock mounting locations. Using WD-40, adjust the rubber grommets on the lines so they fit into the clamps on the frame and brake hose properly. SEE PHOTO IN NEXT COLUMN.

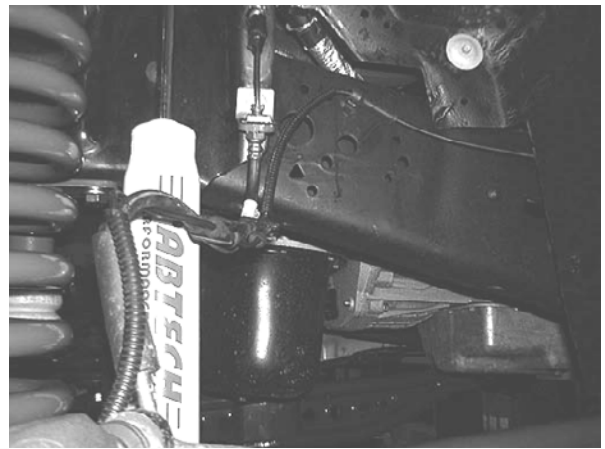

24. Locate FT30169BK sway bar frame drop bracket and attach it to the frame using the original sway bar hardware. Attach the sway bar to the new frame mounts using the supplied 7/16-14 x 1 1/2" bolts, nuts and washers. Attach the end links to the stock spring perch's on the I-Beams using the original hardware. Torque the end link hardware to 55 ft. lbs and the frame mount hardware to 45 ft. lbs. SEE PHOTO BELOW.



25. Locate FT30206 pitman arm spacer. Place the drag link through the bottom of the new pitman arm. Place the spacer on top of the pitman arm, followed by the factory nut. Torque the nut to 90 ft lbs and install the factory nut keeper and the new cotter pin. SEE PHOTO BELOW.



26. Locate the supplied FT30205 stabilizer bracket and install it in the factory location using the original hardware and torque to 65 ft. lbs. Re-connect the stabilizer to the new drop bracket and tighten to 45lbs. SEE PHOTO BELOW.



27. Locate the factory alignment cam. Completely remove the pinch bolt on the I-Beam and remove the factory alignment cam and discard. Locate the supplied FT594 alignment cam and place it into the I-Beam where the stock cam was. Re-install and tighten the pinch bolt. SEE PHOTO BELOW.

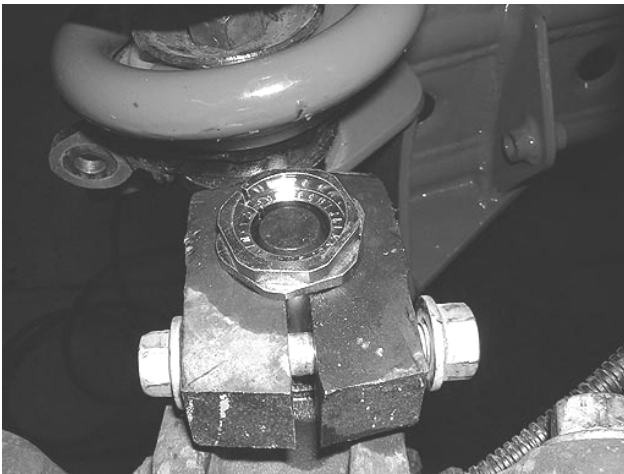

28. Install the front wheels and tires and torque to factory specs. Set the truck back on the ground. Re-torque the all the hardware to recommended specs. Double check the toe-in and reset it to factory specs if necessary.
29. Recheck all bolts for proper torque. Recheck brake hoses and lines for proper clearances.
30. Grease all I-Beam pivot fittings and ball joints.
31. Torque lug nuts to wheel manufacturers specifications. Turn front tires left to right and check for appropriate tire clearance. Note- some oversized tires may require trimming of the front bumper & valance.
32. Check front-end alignment and set to factory specifications. We recommend driving the truck for fifty miles and then have it aligned to factory specs. Readjust headlights.
33. Reconnect the negative terminal of the battery.

## **REAR INSTRUCTIONS**

Follow the instructions included in the rear kit