



Installation Instructions



*2007 - 17 GM Tahoe & Yukon 4WD - 2wd w/Auto
Ride, Basic System*

FTS21040BK / FTS21041BK / FTS21042BK



*2007 - 17 GM Tahoe & Yukon Basic System
FTS21040BK / FTS21041BK / FTS21042BK*

PARTS LIST

FTS21040BK Chevy 2007 Box 1		
Qty	Part #	Description
1	FT20282BK	Frt Crossmember
1	FT20283BK	Rear Crossmember
2	FT20284BK	Crossmember Support Tube
1	FT20347	Driver Diff Bracket
1	FT20348	Pass. Diff Bracket
2	FT20287BK	Impact Tube
2	FT20288BK	Impact Tube Bracket
1	FT20304BK	Diff Skid Plate
1	FT20308	Hardware Kit
1	FT20399	Hdwr Sub-Assembly Kit

FT20399 Hdwr Sub-Assembly Kit		
Qty	Part #	Description
1	FT1044	Bushing Kit
2	FT20277	Drv./Pass Outer Tie Rod End
1	FT20300	1/4" Wheel Spacer
1	FT20313	Drv. Frt. Brake Line Bracket
1	FT20314	Pass. Frt. Brake Line Bracket

FTS21042BK Chevy 2007 Box 3 Coil Spacer		
Qty	Part #	Description
1	FT20295	Hardware Kit
2	FT20323BK	Shock Extension
4	FT20568BK	Shock Brackets
2	FT20339BK	Shock Mount To Arm
1	FT20397	Hdwr Sub-Assembly Kit

FT20397 Hdwr Sub-Assembly Kit		
Qty	Part #	Description
4	FT1036	Bushing Lower Mount
2	FT148	Sleeve
4	FT20342	Alum. Shock Mount Bushing Half "non- auto ride bushing halves"
4	FT20352	Lower Mount Shim (forged steel a-arms only)

FTS21041BK Chevy 2007 Box 2		
Qty	Part #	Description
1	FTS20276D	Drv. Spindle
1	FTS20276P	Pass. Spindle
1	FT20347	Driver Diff Bracket
1	FT20348	Pass. Diff Bracket
2	FT20289	C.V. Spacer
2	FT20602	Sway Bar Link Bracket D/P.
1	FT20312	Sway Bar Frame Bracket Drv.
1	FT20318	Sway Bar Frame Bracket Pass

Note: If your vehicle is equipped with the Auto Ride system, use the FT20351 Aluminum Shock Mount Bushing Halves that are included with the FTS21051BK Rear Coil Spring kit. The FT20342 Aluminum Shock Mount Bushing Halves that are included with this kit will not work with the Auto Ride System and should be discarded.



*2007 - 17 GM Tahoe & Yukon Basic System
FTS21040BK / FTS21041BK / FTS21042BK*

Hardware Kit FT20308					
Qty	Description	Location	Qty	Description	Location
2	5/8"-11 x 5" Hex Cap Bolt	Front Crossmember	2	1/2"-13 x 1 3/4" Hex Cap Bolt	Diff Drop Bracket Dr.
2	5/8"-11 x 5 3/4" Hex Cap Bolt	Rear Crossmember	2	1/2"-13 C-Locks	
8	5/8" SAE Flat Washer		4	1/2" SAE Flat Washer	
4	5/8"-11 C-Locks		2	9/16"-12 x 1 3/4" Hex Cap Bolt	Diff Drop Brkt Pass.
2	18mm- 2.50 x 50mm Bolt	Front Sway bar	2	9/16"-12 C-Lock Nut	
2	18mm- 2.50 C-Locks		4	9/16" SAE Flat Washer	
4	18mm Flat Washer		2	7/16"-14 x 1 1/4" Hex Cap Bolt	Skid Plate
4	7/16"-14 x 3 1/2" Bolt	Impact Struts	1	1/2"-12 x 1 1/4" Hex Cap Bolt	
4	7/16"-14 C-Locks		2	7/16"-14 C-Lock Nut	
8	7/16" SAE Flat Washer		1	1/2"-13 C-Lock Nut	
4	1/4"-20 x 3/4" Hex Cap Bolt	Front Brake Drop Brkt	4	7/16" SAE Flat Washer	
4	1/4"-20 C-Locks		2	1/2" SAE Flat Washer	
8	1/4" SAE Flat Washer		12	10mm 1.50 x 50mm	Axle Bolts
4	7/16"-14 x 2 1/4" Hex Cap Bolt	Sway Bar Drop Bracket	12	10mm Flat Washer	
4	7/16"-14 C-Locks		2	1/4"-20 x 3/4" Hex Cap Bolt	ABS Cable@Spindle
8	7/16" SAE Washer		2	1/4" Split Washer	
4	10mm x 1.5 x 30mm Bolt		2	1/4" SAE Flat Washer	
4	10mm x 1.5 C-Lock Nut		2	1/4" Adel / Line Clamp	
8	10mm Flat Washer		6	6" Cable Ties	
			1	Thread Locking Compound	

Hardware Kit FT20295		
Qty	Description	Location
4	7/16"-14 x 2 1/2" Hex Cap Bolt	Strut Mnt Brkt @ L.C.A.
4	7/16"-14 C-Locks	
8	7/16" SAE Flat Washer	
4	1/2"-13 x 4" Hex Cap Bolt	Mount @ Lwr. Ctrl Arm
2	1/2"-13 x 3 3/4" Hex Cap Bolt	Front Lower Strut
6	1/2"-13 C-Locks	
12	1/2" SAE Flat Washer	
8	5/16"-18 x 1" Hex Cap Bolt	Strut Mount Brackets
8	5/16"-18 C-Locks	
16	5/16" SAE Flat Washer	



*2007 - 17 GM Tahoe & Yukon Basic
System FTS21040BK / FTS21041BK /
FTS21042BK*

FT20300 WHEEL SPACER IS TO BE USED WITH THE SPARE TIRE ONLY. IT IS FOR TEMPORARY USE ONLY. THE WHEEL SPACER IS TO BE GIVEN TO THE END CONSUMER AND PLACE WITH THE FACTORY SPARE WHEEL AND TIRE. WHEEL SPACERS ARE FOR LOW SPEED OPERATION ONLY, 50 MPH AND SLOWER.

DO NOT ALTER THE FINISH OF THESE COMPONENTS, EXAMPLE- CHROMING, ZINC PLATING OR PAINTING. CHANGING THE FINISH CAN CAUSE STRUCTURAL FATIGUE OF COMPONENTS.

SUSPENSION SYSTEM MUST BE INSTALLED WITH FABTECH SHOCK ASBORBERS.

VEHICLES THAT WILL RECEIVE OVERSIZED TIRES SHOULD CHECK BALL JOINTS, TIE RODS ENDS AND IDLER ARM EVERY 2500-5000 MILES FOR WEAR AND REPLACE AS NEEDED.

CHECK ALL PARTS INCLUDED IN THIS KIT TO THE PARTS LIST ABOVE BEFORE BEGINNING INSTALLATION OF THE KIT. IF ANY PIECES ARE MISSING, CONTACT FABTECH.

READ ALL INSTRUCTIONS THOROUGHLY FROM START TO FINISH BEFORE BEGINNING INSTALLATION! IF THESE INSTRUCTIONS ARE NOT PROPERLY FOLLOWED, SEVERE FRAME, DRIVELINE AND / OR SUSPENSION DAMAGE MAY RESULT.

NOTE- PRIOR TO THE INSTALLATION OF THIS SUSPENSION SYSTEM A FRONT END ALIGNMENT MUST BE PERFORMED AND RECORDED. DO NOT INSTALL THIS SYSTEM IF THE VEHICLE ALIGNMENT IS NOT WITHIN FACTORY SPECIFICATIONS. CHECK FOR FRAME AND SUSPENSION DAMAGE PRIOR TO INSTALLATION. THIS SUSPENSION SYSTEM DOES NOT REQUIRE WELDING FOR INSTALLATION. DO NOT WELD ANY OF THESE COMPONENTS.

THE INSTALLATION OF THIS SUSPENSION SYSTEM SHOULD BE PERFORMED BY TWO PROFESSIONAL MECHANICS.

FABTECH RECOMMEND'S A 17X8 WHEEL WITH A 5" BACK SPACING WITH A 315/70R17 TIRE.

THIS KIT NOT RECOMMENDED FOR THE 2WD SUBURBAN.

BE SURE TO USE THREAD LOCKING COMPOUND ON ALL HARDWARE.

TOOL LIST: (NOT INCLUDED)

- **FLOOR JACK & JACK STANDS.**
- **ASSORTED METRIC AND S.A.E SOCKETS, & WRENCHES.**
- **LARGE C CLAMP OR C CLAMP VISE GRIPS.**
- **DIE GRINDER WITH CUTOFF WHEEL OR SAWZALL.**
- **TORQUE WRENCH.**

DRIVELINE VIBRATION MAY OCCUR AND WILL REQUIRE PART #FTS21192 (CV DRIVESHAFT KIT)

FRONT SUSPENSION INSTRUCTIONS:

1. Disconnect the negative terminal on the battery. With the vehicle on level ground and the emergency brake set, block the rear tires. Jack up the front end of the truck and support the frame rails with jack stands. **NEVER WORK UNDER AN UNSUPPORTED VEHICLE!** Remove the front tires.
2. Disconnect the tie rod ends from the steering knuckle by striking the knuckle to dislodge the tie rod end. Use care not to damage the tie rod end when removing. SEE PHOTO BELOW



3. Unplug the ABS brake connection from the frame and control arm. Remove the brake hose bracket from the steering knuckle. Remove the brake hose bracket from the strut bucket and secure the brake caliper to the frame out of the way. **DO NOT ALLOW THE BRAKE CALIPER TO HANG FROM THE BRAKE LINE HOSE.** SEE PHOTO BELOW



4. Remove the wheel stud clips and discard. Remove bearing cover, axle nut, washer, and rotor with hub bearing. (DO NOT REMOVE THE HUB FROM THE ROTOR). Retain parts and hardware for reinstallation. SEE PHOTOS IN NEXT COLUMN.

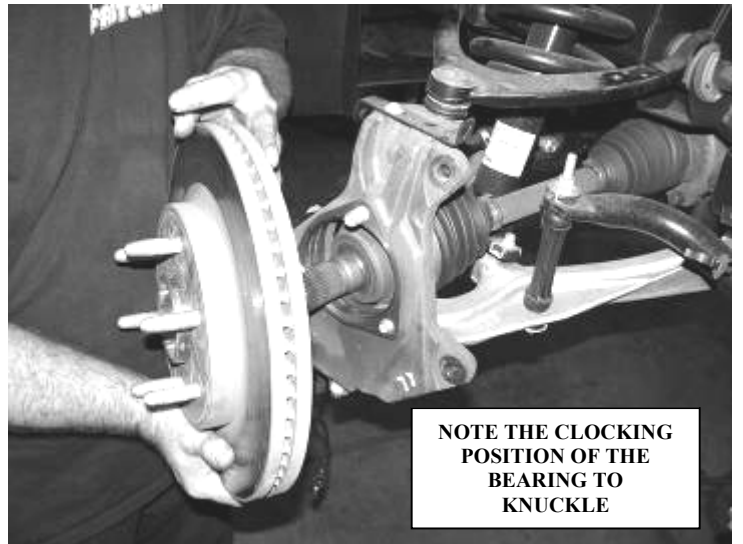

5. Remove the upper and lower ball joint nuts. Disconnect the upper and lower ball joints from the steering knuckle by striking the knuckle with a large hammer next to each ball joint on the knuckle to dislodge the ball joints. Use care not to hit the ball joints when removing. Save nuts and discard knuckle. SEE PHOTO BELOW

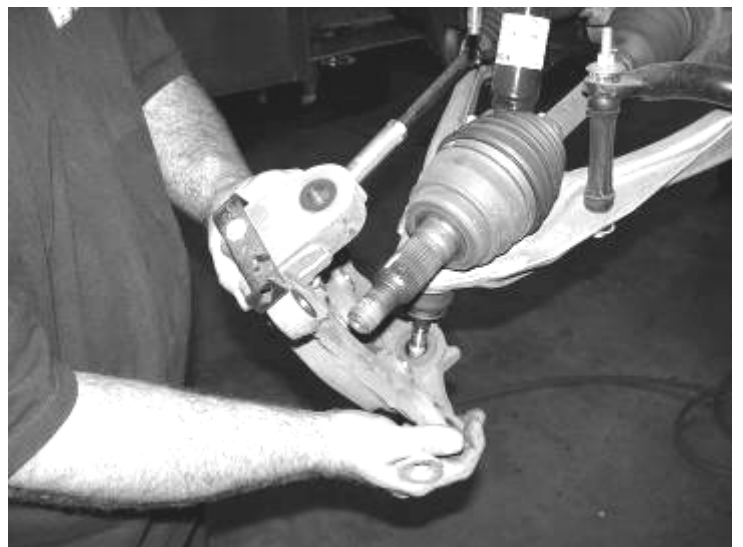

6. Remove the shock assembly and save with the hardware. Remove and discard the factory brake line bracket from the brake hose that attached the hose to the upper control arm. SEE PHOTO BELOW

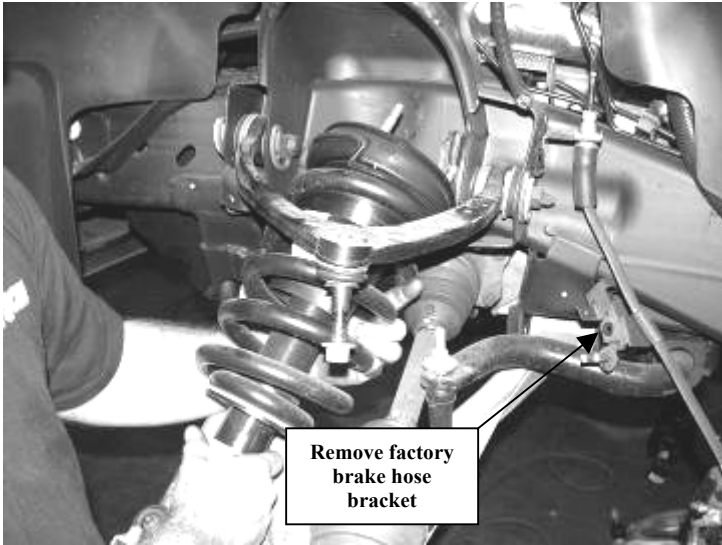

7. Disconnect and remove CV axles from differential housing and the sway bar endlinks and save. Discarding ONLY the CV axle hardware. SEE PHOTO BELOW.

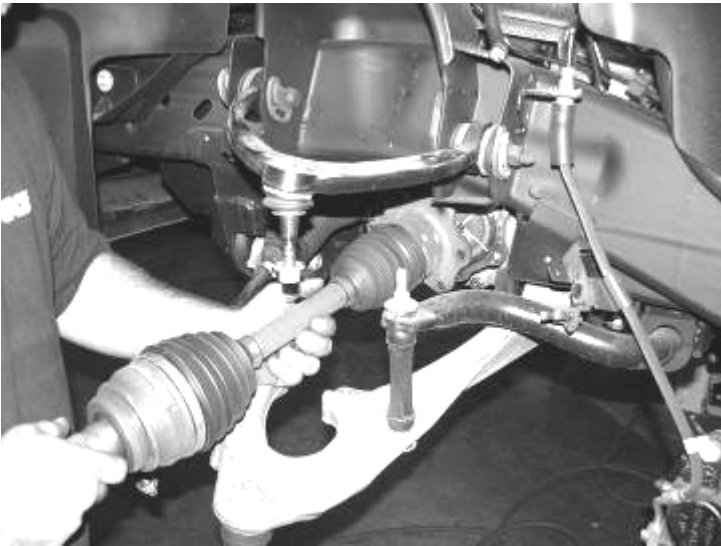

8. Remove the lower control arms from the frame and retain with the hardware for reinstallation. SEE PHOTO IN NEXT COLUMN.



9. Locate, remove, and save the sway bar, discard hardware. SEE PHOTO BELOW

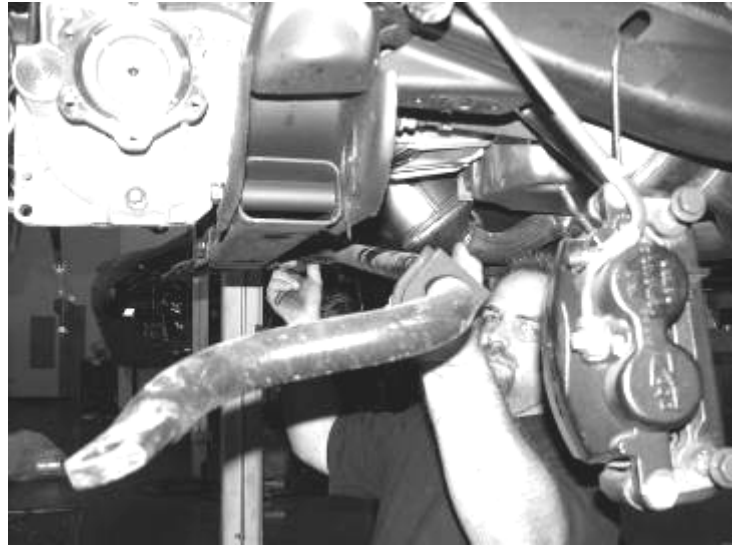

10. Remove front factory differential skid plate and splash shield and discard.
11. Disconnect front driveshaft from differential housing and retain bolts and u joint clamps for reinstallation. Locate, remove, and discard the factory rear crossmember with hardware.
12. Disconnect the electrical connection including the two retaining clamps and the vacuum line from differential housing. Remove differential housing assembly from vehicle. Retain hardware for reinstallation.
13. Locate the rear driver lower control arm mount on the frame. Measure 3" from the inside edge of the mount toward the frame and mark with a paint pen. Use a sawzall and cut the mount from the frame. SEE PHOTO ON NEXT PAGE.

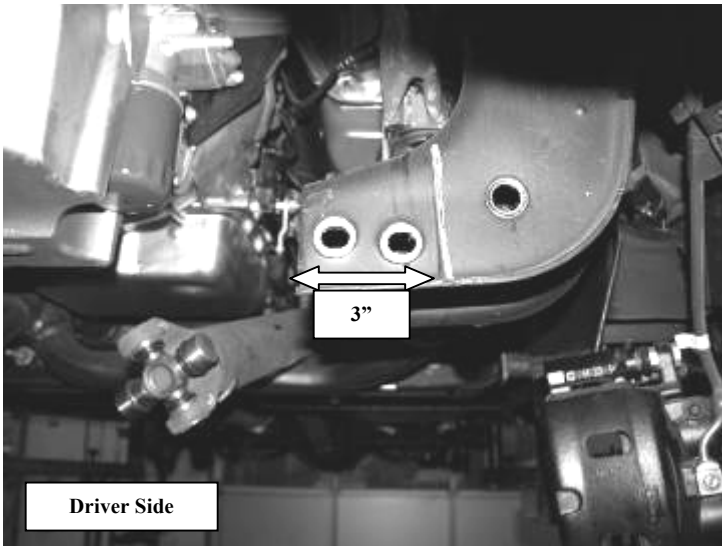

Driver Side

View from front of vehicle

14. Locate the rear passenger lower control arm mount on the frame. Measure 3 1/2" from the inside edge of the mount toward the frame and mark with a paint pen. Use a sawzall and cut the mount from the frame. SEE PHOTO BELOW

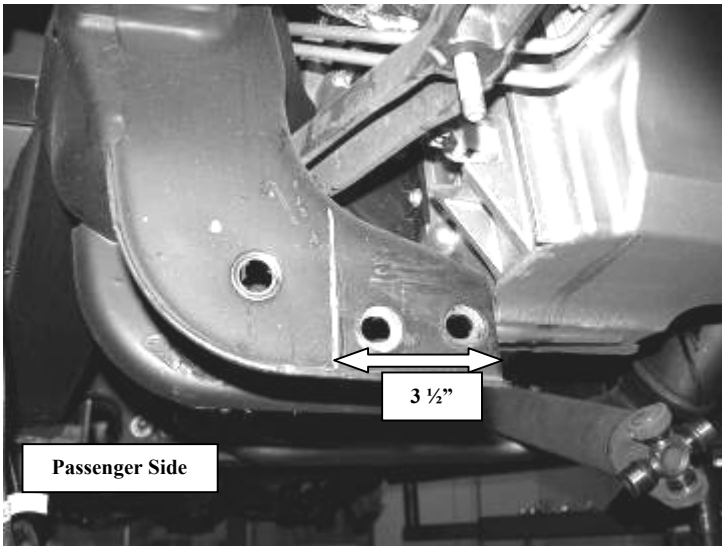

Passenger Side

View from front of vehicle

15. Locate the factory front lower control arm pockets. Grind 1/4" section from both Corners of the pockets as shown in the photo. SEE PHOTOS IN NEXT COLUMN

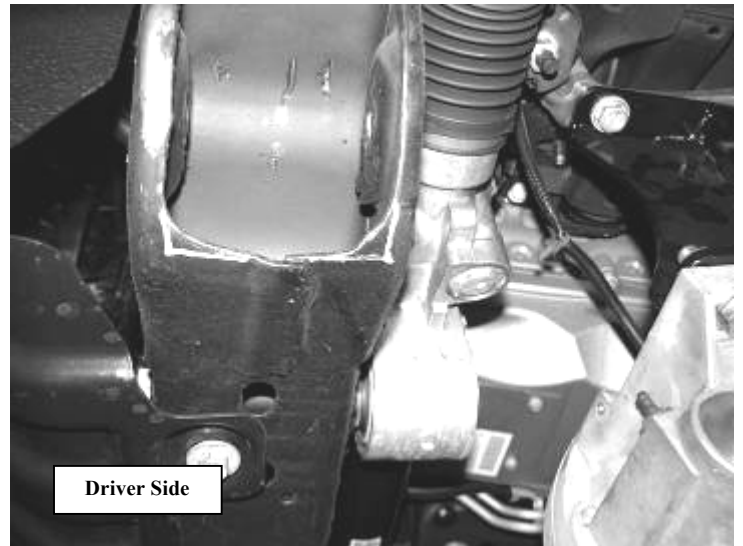

Driver Side

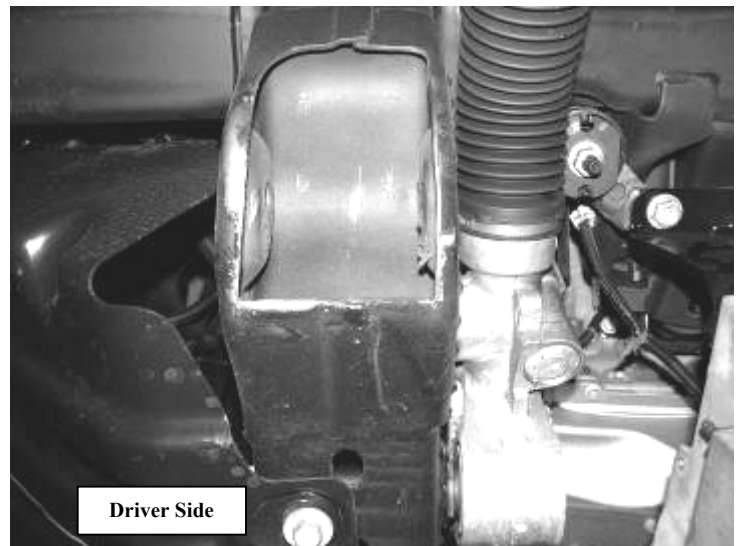

Driver Side

This step must be done on the Driver and Passenger Side

DUE TO VARIANCES IN EACH TRUCK, ADDITIONAL GRINDING MAY BE REQUIRED FOR PROPER FITMENT OF THE CROSSMEMBERS. USE THESE MEASUREMENTS AS A STARTING POINT AND CLEARANCE THE FRAME POCKETS AS NEEDED FOR PROPER FITMENT OF THE CROSSMEMBERS

16. Locate the front differential. The diff will need to be trimmed / cut in three places. The first is the 90 degree tab on the bottom front of the diff. Measure in 1 1/4" from the outer edge and cut with a sawzall as shown in photos. The second cut is the bottom rear gusset on the passenger side of the diff. Measure down 1/4" from the pinion side of the gusset and mark 1 1/2" long and 1/2" deep. Using a barrel sander, sand down the gusset as shown in photos below. The third cut is second gusset from the rear on the driver side of the diff. Mark the gusset 2 1/4" from the top and a 1/4" in. Using a barrel sander, sand down the gusset as shown in photos below. SEE PHOTOS ON NEXT PAGE

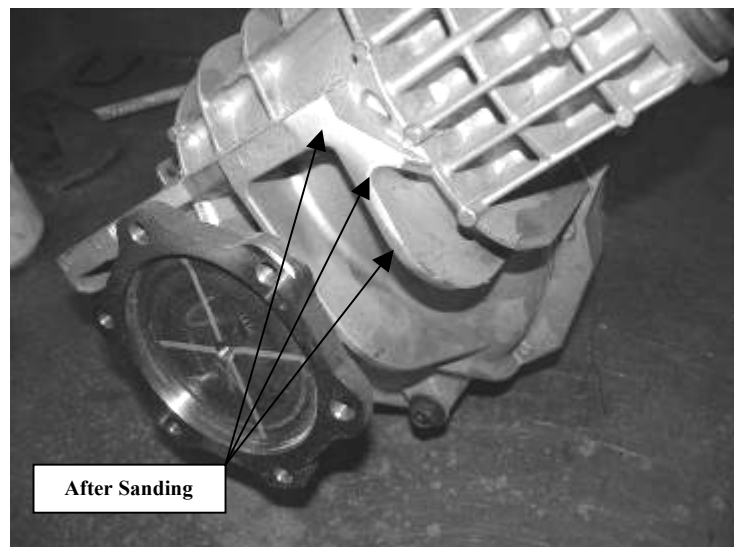
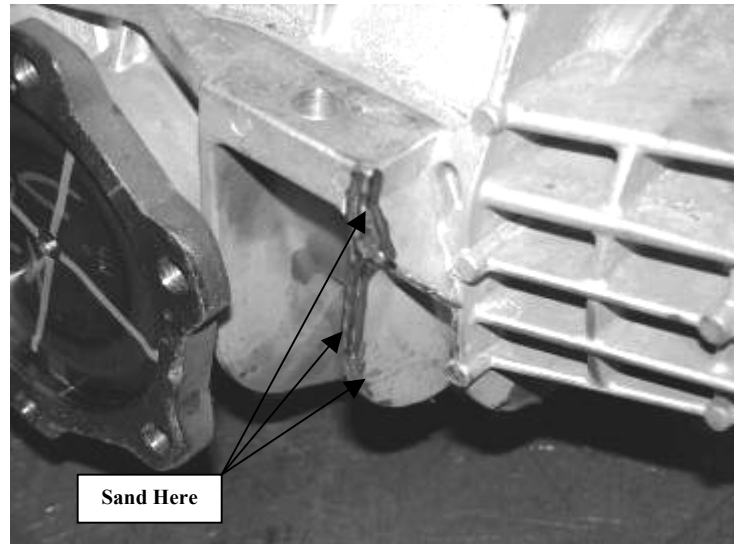
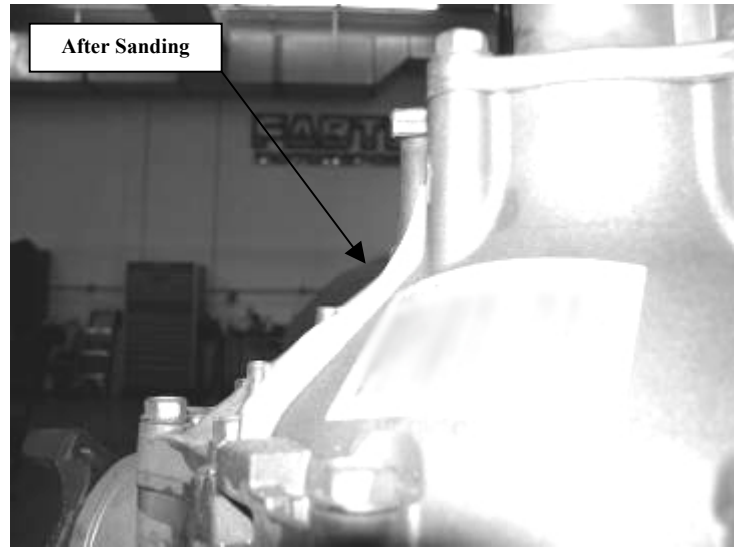
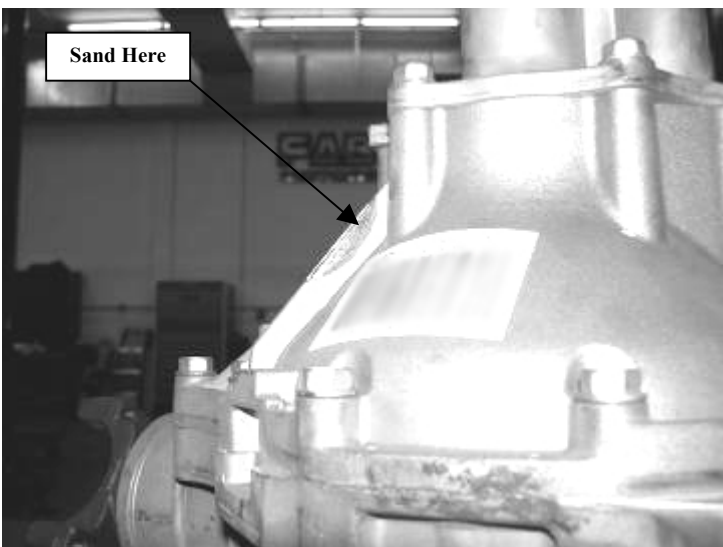
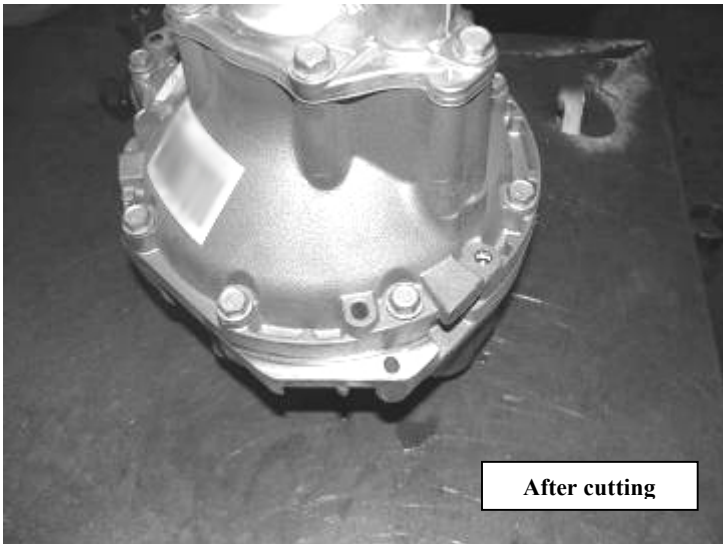
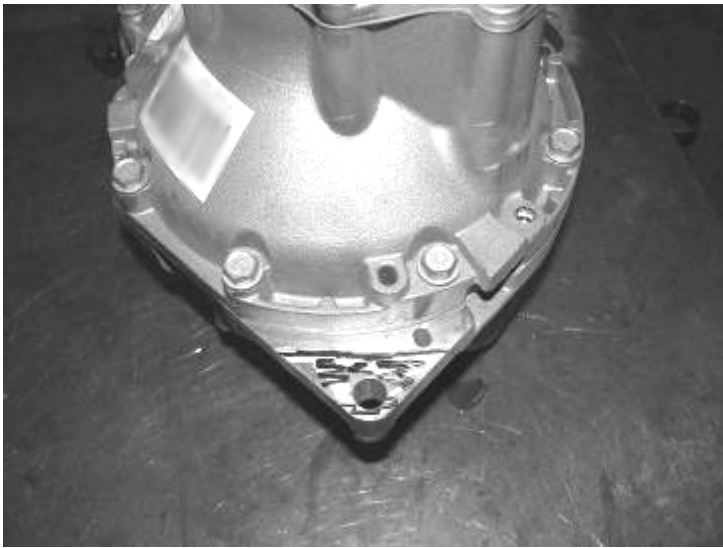

USE THESE MEASUREMENTS AS A STARTING POINT AND CLEARANCE THESE AREAS AS NEEDED FOR PROPER FITMENT OF THE DIFFERENTIAL

17. Locate the driver upper differential mount. The locating pin on this mount needs to be cut off. Using a die grinder with a cutoff wheel, cut the pin flush with the bracket. SEE PHOTOS ON NEXT PAGE

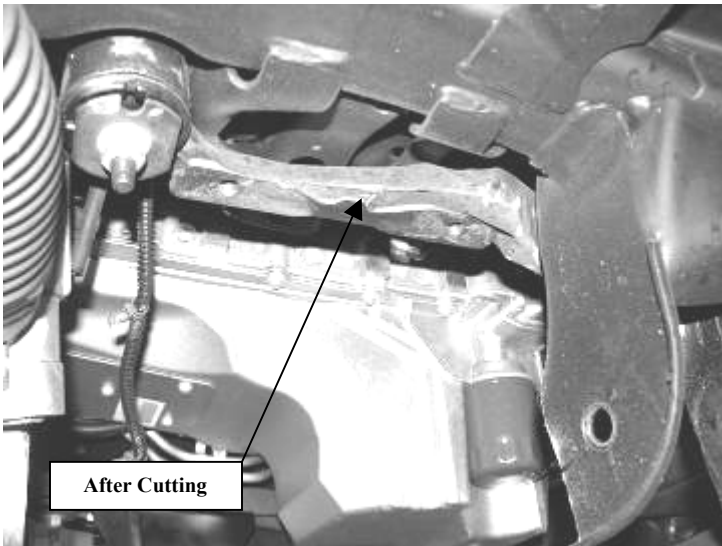
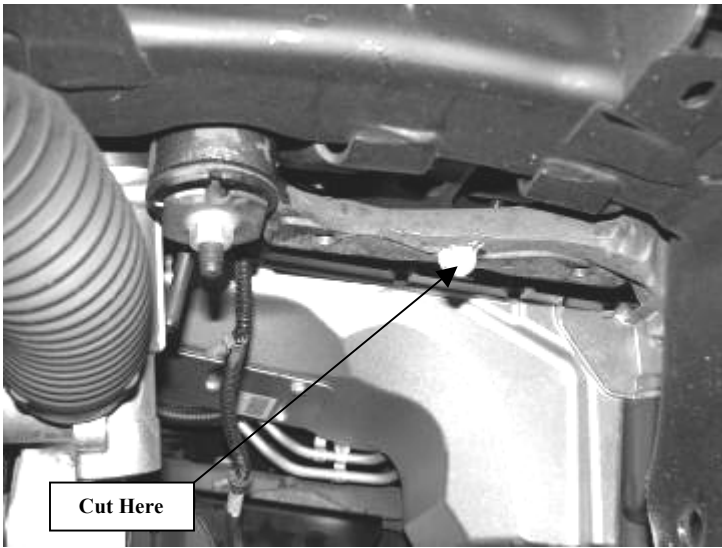

18. Locate FT20347 (driver) & FT20348 (pass) Diff. brackets and the factory diff hardware. Install the brackets to the factory mounts with the taller part of the bracket to the front of the truck with the factory hardware. Torque to 75 ft lbs. SEE PHOTOS BELOW AND IN NEXT COLUMN.

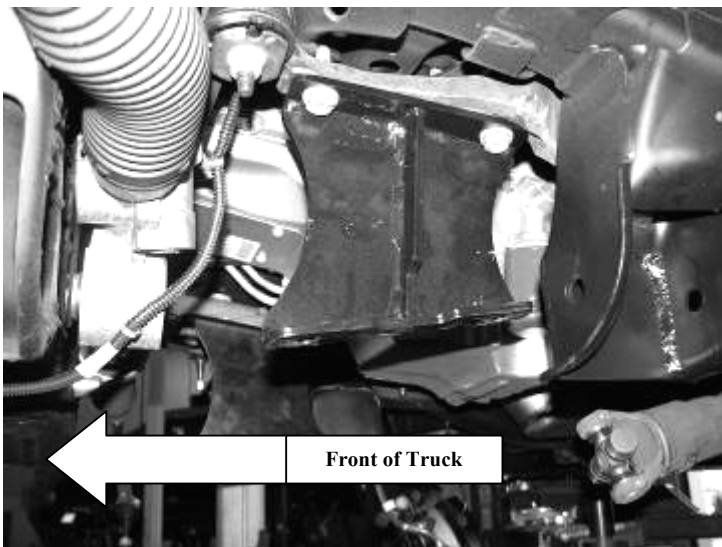

Driver Side

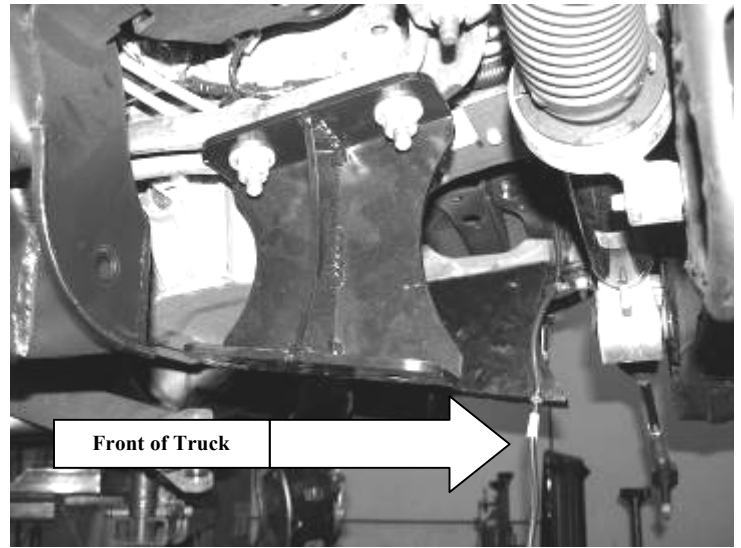

Passenger Side

19. Locate the supplied $\frac{1}{2}$ " x $1\frac{3}{4}$ " and $\frac{9}{16}$ " x $1\frac{3}{4}$ " hardware and the front diff. Install the diff onto the new drop brackets using the $\frac{1}{2}$ " hardware on the driver's side and the $\frac{9}{16}$ " on the passenger side. Torque the $\frac{1}{2}$ " hardware to 75ft lbs and the $\frac{9}{16}$ " to 95 ft lbs. Re-connect the electrical and vacuum connections back onto the diff. **(CHECK THE CLEARANCE OF THE DIFF TO THE FRAME IN SANDED AND CUT SPOTS ON THE DIFF. FOR ADAQUATE CLEARANCE TO THE FRAME AND CROSSMEMBER) .SEE PHOTO BELOW**



20. Locate and install FT20283 rear crossmember into the factory lower control arm pockets using the stock hardware and leave loose at this time. **(CHECK THE CLEARANCE OF THE DIFF TO CROSSMEMBER WHERE IT WAS SANDED DOWN IN STEP #18 FOR ADAQUATE CLEARANCE TO THE FRAME AND CROSSMEMBER) SEE PHOTO ON NEXT PAGE.**

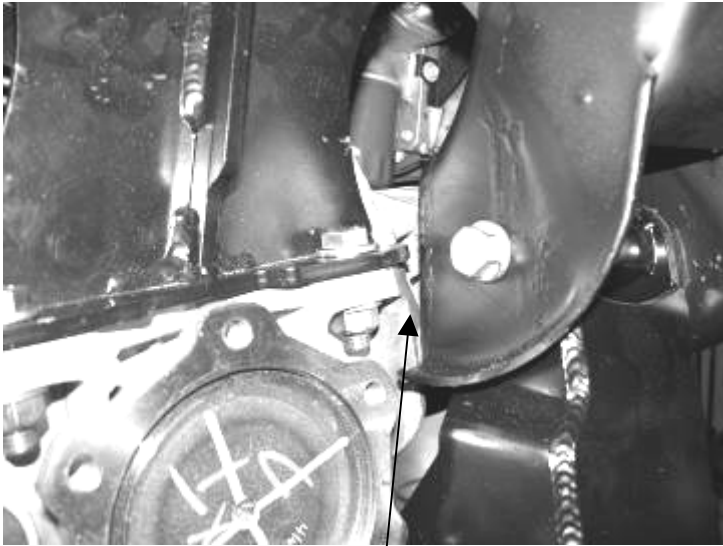

Check for clearance of the diff to the frame and crossmember

21. Locate and install FT20282 front crossmember into the factory lower control arm pockets using the stock hardware. Leave loose. SEE PHOTO BELOW

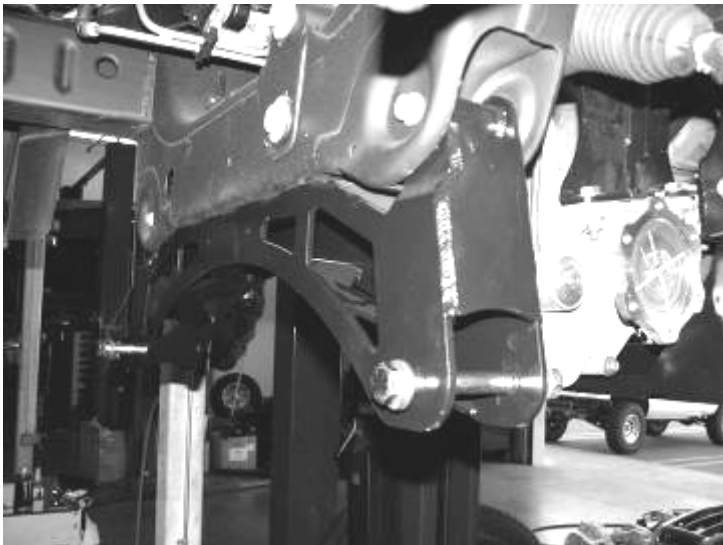

22. Locate FT20284 Crossmember Support Tubes. Install the lower control arms into the new crossmembers using the 5/8" x 5" hardware in the front pocket. Position the control arms into the crossmember and insert only the front 5/8" bolt just so that it is through the arm. Position the Support tube between the crossmembers and rotate them up to the locating tabs on the crossmember. Install 5/8" x 5 3/4" hardware in the rear pocket and the front bolt with hardware. Leave loose. SEE PHOTO IN NEXT COLUMN.

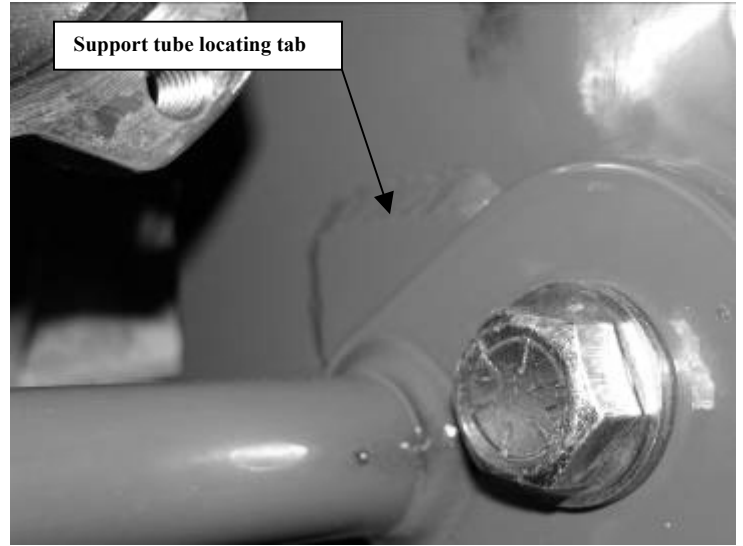

Driver side shown

23. Locate FT20304 Skid Plate and the supplied 1/2" x 1-1/4" hardware and attach the rear of the skid plate to the bottom of the rear crossmember. Use the supplied 7/16" x 1 1/4" hardware and attach the front of the skid plate to the front crossmember (make sure that the diff is clearanced enough to clear the skid plate). SEE PHOTO BELOW.

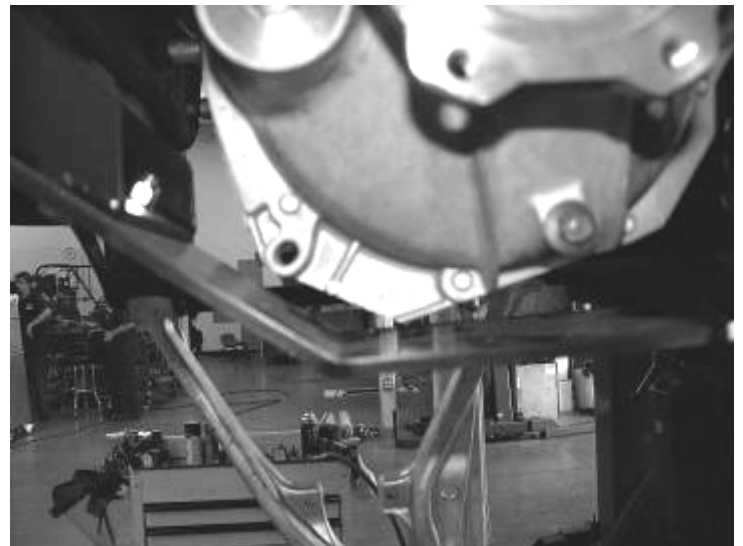

24. Torque the crossmember frame pocket bolts to 125 ft lbs, the lower control arm bolts to 110 ft lbs, the 1/2" skid plate hardware to 75 ft lbs, and the 7/16" to 50 ft lbs.
25. Locate the factory coilovers. Remove the nut clips from the cross-shaft and discard. Using a press, press out the cross-shaft and the bushing from the bottom of the coilover and discard. SEE PHOTOS ON NEXT PAGE.



26. Locate Box 3 FTS21042BK which has FT20339 Shock Mount to Arm, FT20323 Shock Extensions, FT20568 Shock Brackets, FT20342 (**non auto-ride**) or FT20351 (**auto-ride**) Aluminum Bushings , Hardware Kit FT20295, FT1036 Bushings, and FT148 Sleeves. Using a press, press the bushings and sleeves (with the provided lube) into the shock extension. Insert the Aluminum Bushings into the bottom of the factory shock. SEE PHOTOS IN NEXT COLUMN

Photo shows installation of FT20342 non-auto ride aluminum bushings

27. Place the Shock Brackets around the bottom of the shock and align with the aluminum sleeves. Position the shock extension over the brackets and also align with the aluminum sleeves. Locate the supplied $\frac{1}{2}$ " x 4" bolts and hardware and install through the aluminum bushing and the shock mount. Leave loose. Locate the $\frac{5}{16}$ " x 1" bolts and hardware and install into the shock brackets. Tighten the $\frac{5}{16}$ " hardware so the brackets are evenly spaced on the shock. Torque to 20 ft lbs. Torque the $\frac{1}{2}$ " hardware to 75 ft lbs. SEE PHOTOS BELOW AND IN NEXT COLUMN.

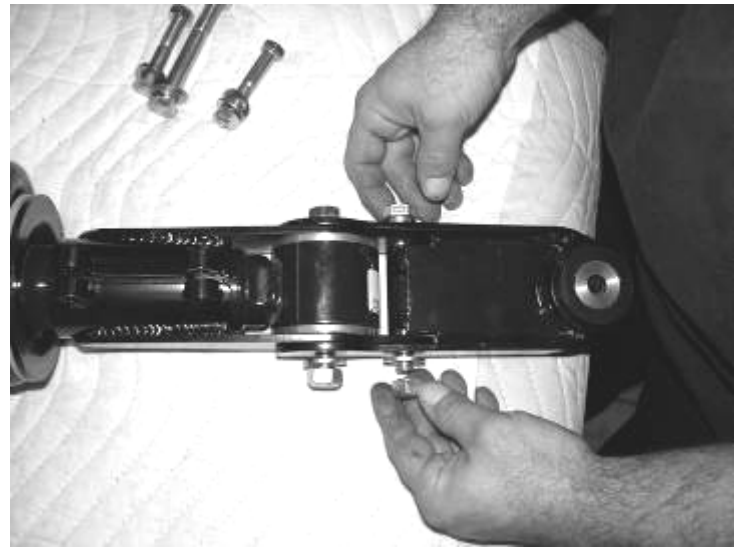
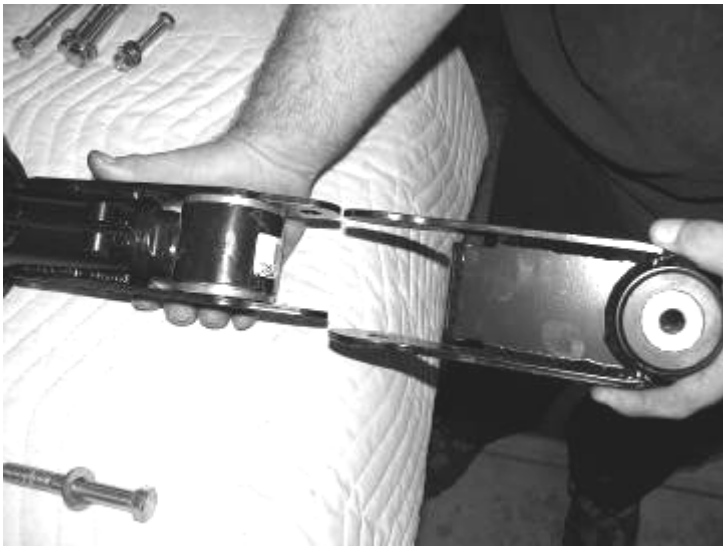

28. Locate the factory upper shock hardware. Install the shock into the factory shock bucket and leave loose. SEE PHOTOS BELOW AND ON NEXT PAGE.



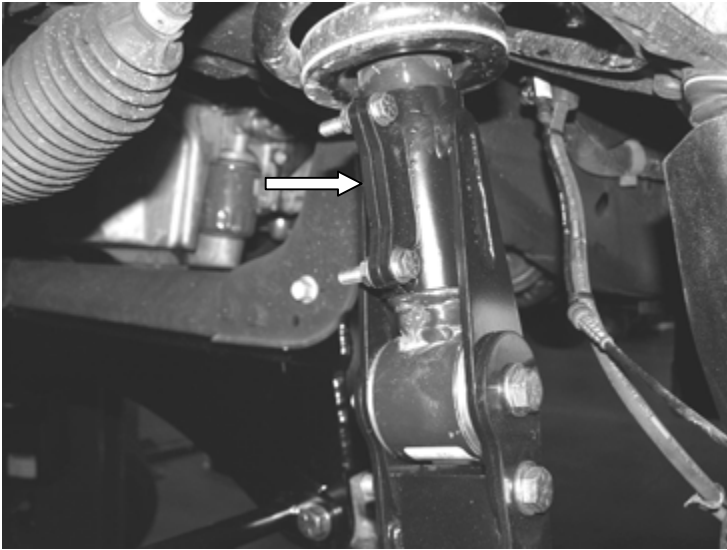
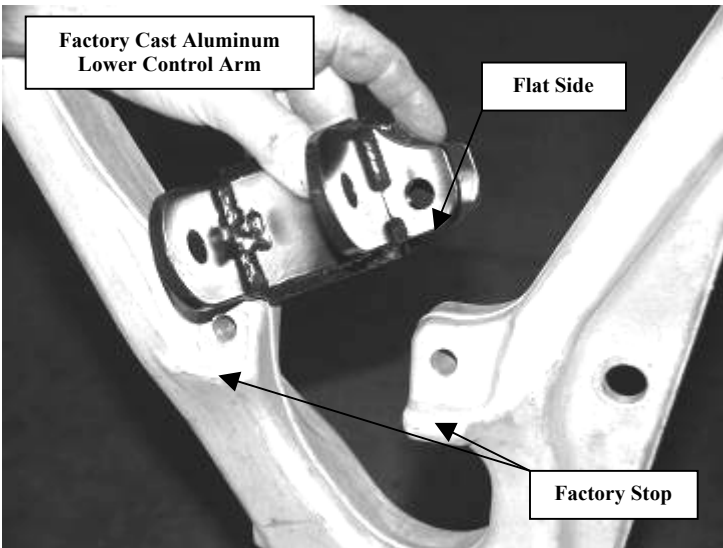
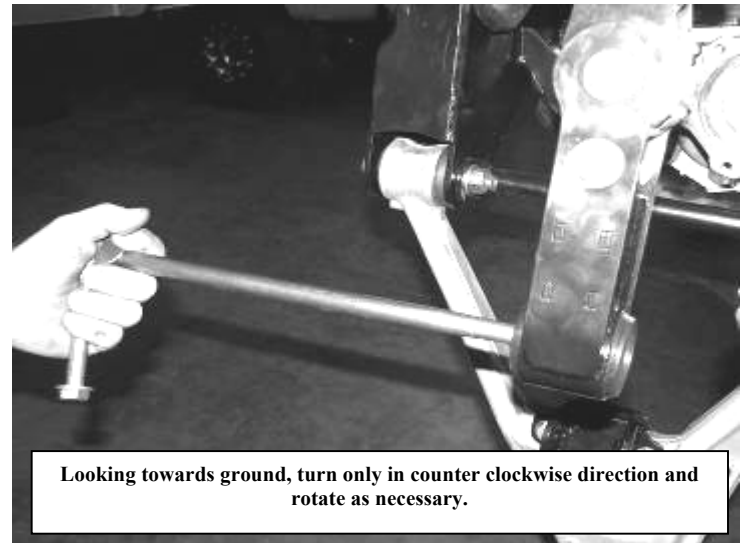
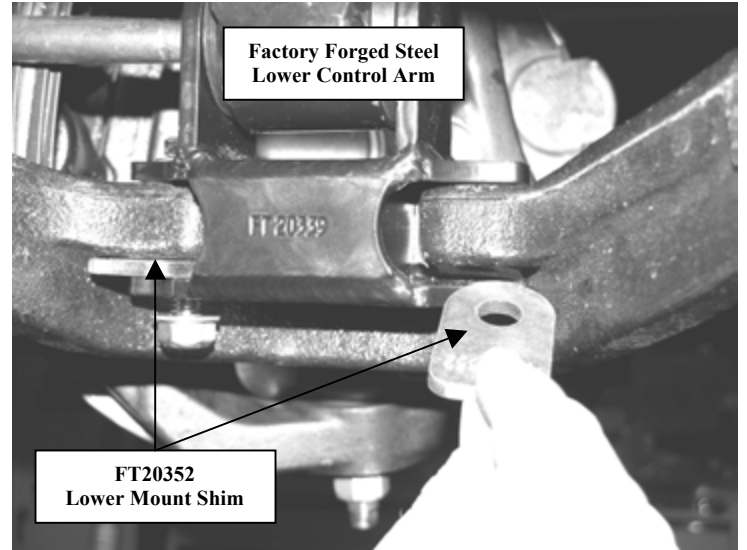

Photo shows new style shock brackets

29. Locate FT20339 Lower Shock Mount and the supplied 7/16" x 2 1/2" hardware. Position the mount onto the lower control arm so the flat side of the bracket will be flush with the stop on the arm. Attach with the 7/16" hardware and torque to 50 ft lbs. Rotate the lower control arm up and attach the strut to the new mount with the provided 1/2" x 3 3/4" hardware and torque to 75 ft lbs. (it may be necessary to rotate the shock and extension to attach). Torque the top shock bolts to 40 ft lbs. SEE PHOTOS BELOW AND IN NEXT COLUMN.



NOTE: If your truck has the Factory Forged Steel Lower Control Arms, you MUST use the FT20352 Lower Mount Shims. The shims will need to be positioned between the new mount and the control arm. SEE PHOTO IN NEXT COLUMN.



Looking towards ground, turn only in counter clockwise direction and rotate as necessary.

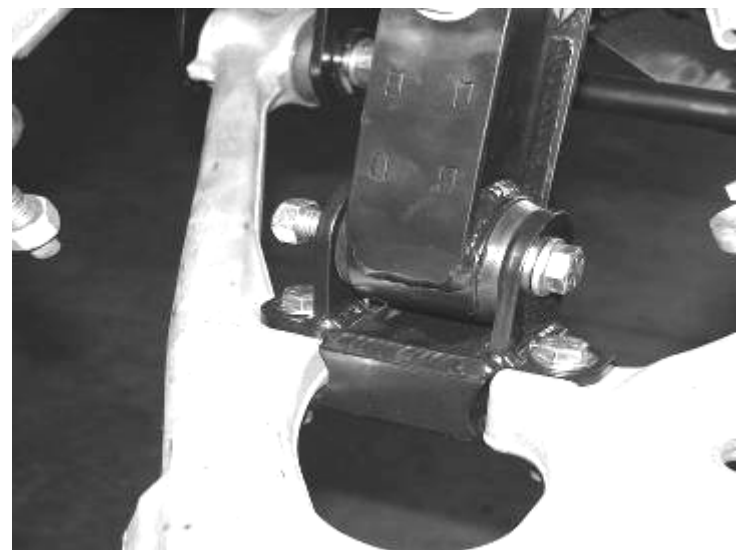

30. Locate the steering knuckle FT20276D and FT20276P. Attach the lower control arm to the knuckle using the stock hardware and torque to 70 ft lbs. Attach the upper control arm to the new knuckle using the factory hardware and torque to 35 ft lbs.

31. Reinstall axle shaft through new knuckle and torque axle nut to 150 ft lbs. and install bearing cover.

32. Locate and install the FT20289 CV spacers between the CV axle and the differential housing using 10mm x 50mm bolt and washer with the provided thread lock compound and torque to 55 ft lbs. in a cross pattern. SEE PHOTOS BELOW.

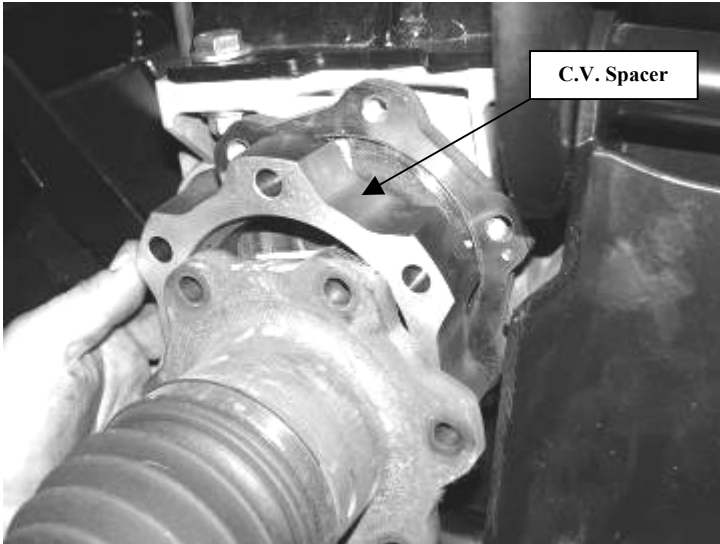

33. Reinstall the rotor and hub bearing assembly using the stock hardware and torque flange bolts to 125 ft lbs. Reinstall brake rotor and caliper. Torque caliper bolts to 30 ft lbs.

34. Locate FT20277 outer tie rods. Loosen the jam nut and remove the factory outer tie rods and discard, leaving the factory jam nut on the inner tie rod. Install the new outer tie rod onto the inner tie rod until it makes contact with the jam nut. Attach new tie rod end to the knuckle with the supplied nut and torque to 60 ft-lbs. **(This is just a starting point; a final alignment must be performed upon completion of suspension system).** SEE PHOTOS IN NEXT COLUMN

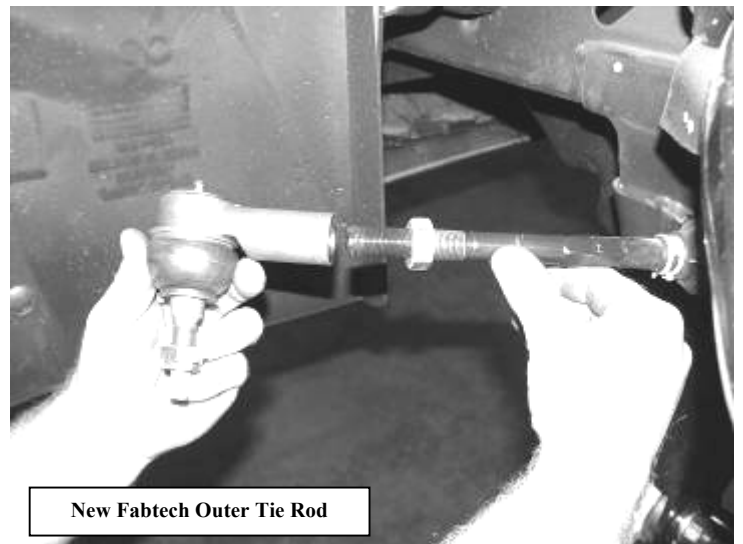
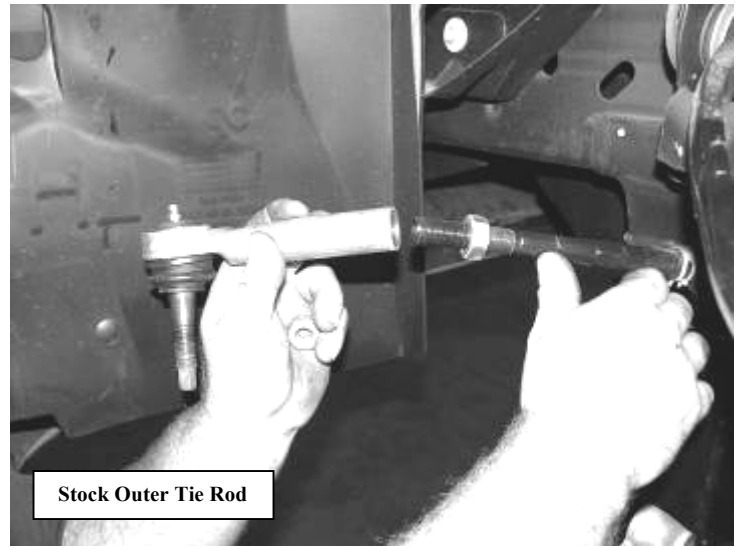

35. Locate FT20312 (Drv), FT20318 (Pass) Sway Bar Frame Bracket, and the supplied 7/16"x2 1/4" and 10mm x 30mm hardware. Position the frame bracket on the frame so that sway bar will be farther back from the suspension and attach with the 10mm hardware. Locate the factory sway bar with the factory mounts and attach to the new brackets with the 7/16" hardware and torque to 50 ft lbs. and the 10mm hardware to 25 ft lbs. SEE PHOTO BELOW

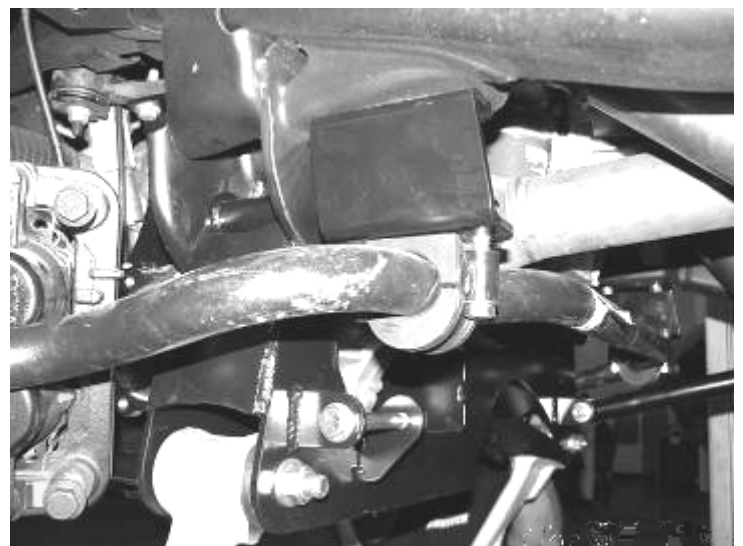

36. Locate FT20602 Sway Bar Mounts and the supplied 18mm x 50mm hardware. Position the Sway Bar Mount so that it is on the bottom of the sway bar with the stop plate on the bottom. Attach with the 18mm hardware and torque to 110 ft lbs. Locate the factory sway bar end links and attach to the new mount and the lower control arm. SEE PHOTOS BELOW.

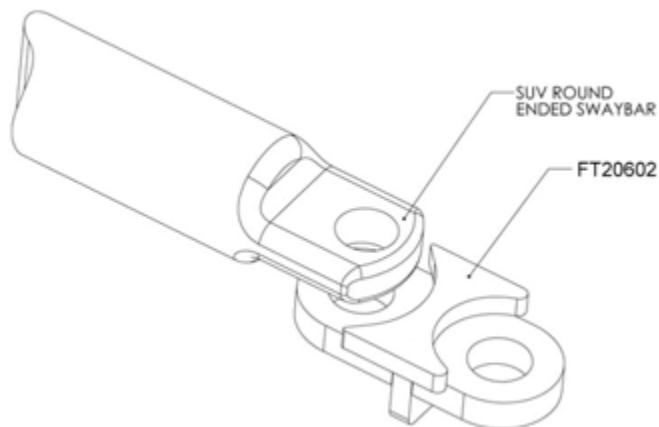

37. Locate FT20313 (drv.) FT20314 (pass) Brake Line Bracket and $\frac{1}{4}$ " x $\frac{3}{4}$ " hardware. Position the new bracket into the factory brake line bracket location and attach with the factory hardware and the $\frac{1}{4}$ " hardware. Attach the factory brake line bracket to the new Fabtech bracket. Carefully bend the hard brake line and attach with the supplied $\frac{1}{4}$ " hardware. Torque to 10 ft LBS. SEE PHOTOS IN NEXT COLUMN.

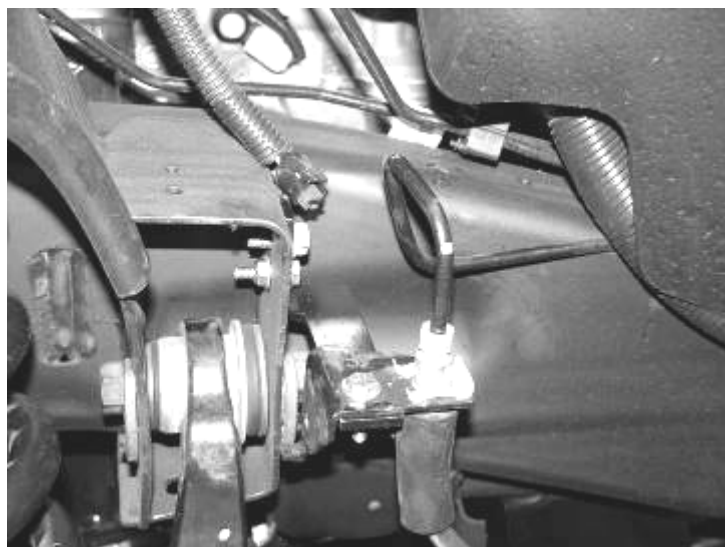
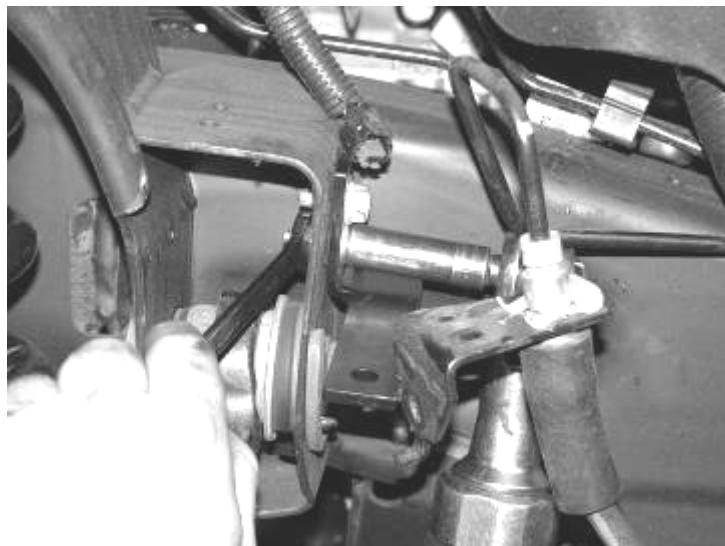
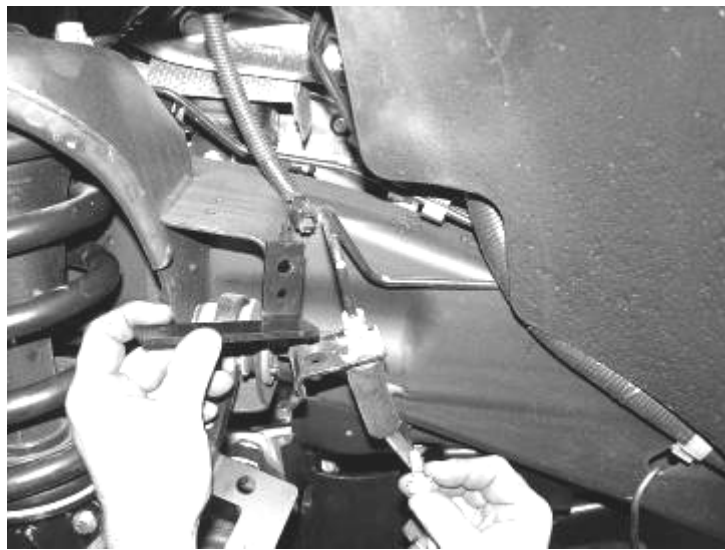

38. Re-route the brake hose and the ABS Line to the steering knuckle using the adel clamp to the back of the steering knuckle and attach with 1/4" x 3/4" bolt and washer. Torque to 10 ft LBS. Route the ABS line next to the brake hose. Re-connect the ABS line to the harness in the wheel well. Using provided plastic tyrap secure line to the hose and away from the tire and wheel. SEE PHOTO BELOW



39. Reattach the driveshaft to the differential yoke using the stock hardware and torque to 19ft lbs.
40. Locate the FT20288 Impact Strut Tube Mounts. Working from the drivers side, support the transmission crossmember and remove the two bolts that secure the crossmember to the frame. Position the new mount onto the front of the crossmember and insert the factory bolts into the new mount and then into the crossmember having the factory nut on the back of the crossmember. Torque to 75 lbs. SEE PHOTO IN NEXT COLUMN.



41. Locate and install the bushings into the Impact Strut bars. Attach the Impact Struts into the tabs on the back side of the lower control arm crossmember and rearward to the Impact Strut mounts using 7/16" x 3-1/2" bolts, nuts and washers from Hardware. ****NOTE** MAY NEED TO MODIFY EXHAUST TUBE ON SOME MODELS. REMOVE OXYGEN SENSOR BEFORE MODIFYING.** Torque to 45 ft lbs. SEE PHOTO BELOW

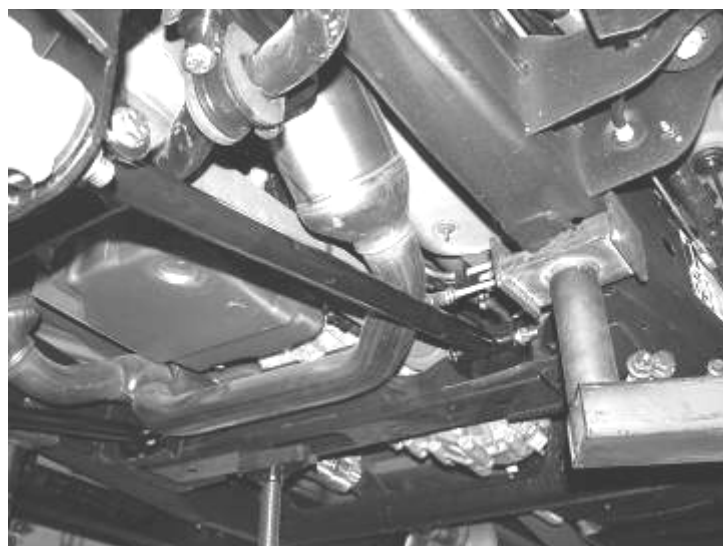

42. Install front tires and wheels. Torque lug nuts to wheel manufacturer's specifications. Check the brake and ABS lines for proper clearance from all moving items.
43. Check front end alignment and set to factory specifications. Adjust the headlights.

IN ORDER TO UTILIZE THE FACTORY WHEELS AFTER INSTALLATION OF THIS SUSPENSION YOU MUST USE PROVIDED FT20300 WHEEL SPACERS. WHEEL SPACERS ARE FOR LOW SPEED OPERATION ONLY, 50 MPH AND SLOWER. WHEEL SPACERS MUST BE GIVEN TO THE END CONSUMER FOR USE WITH FACTORY SPARE TIRE

RETORQUE ALL NUTS, BOLTS AND LUGS AFTER 50 MILES AND PERIODICALLY THEREAFTER.