



INSTALLATION INSTRUCTIONS



2015-17 GM C/K1500 SUV 2WD/4WD
6" BASIC SYSTEM

- PARTS LIST - 6" BASIC SYSTEM

K1078		6" BASIC SYSTEM
1	FTS21137	COMPONENT BOX 1
1	FTS21138	SPACER KIT
1	FTS21159	COMPONENT BOX 2
1	FTS21160	REAR COMPONENT BOX

FTS21137		COMPONENT BOX 1
2	FT20284BK	CROSSMEMBER SUPPORT TUBE
1	FT20304BK	DIFF SKID PLATE
1	FT20312	SWAY BAR FRAME BRACKET (DRIVER)
1	FT20318	SWAY BAR FRAME BRACKET (PASSENGER)
1	FT20347	DIFF BRACKET (DRIVER)
1	FT20365	DIFF SUPPORT BRACKET
1	FT20610BK	FRONT CROSSMEMBER
1	FT20611BK	REAR CROSSMEMBER
1	FT20615	HARDWARE SUBASSEMBLY
1	FT20633	DIFF BRACKET (PASSENGER)
1	FT20634	HARDWARE KIT

FTS21138		SPACER KIT
1	FT20295	HARDWARE KIT
2	FT20323BK	SHOCK EXTENSION
2	FT20339BK	SHOCK MOUNT TO ARM
1	FT20397	HARDWARE SUBASSEMBLY
4	FT20568BK	SHOCK BRACKET

FTS21159		COMPONENT BOX 2
2	FT20613	WASHER UPPER BALL JOINT
2	FT20614	WASHER LOWER BALL JOINT
2	FT20289	CV SPACER
1	FT20669	HARDWARE SUBASSEMBLY
1	FTS20612D	SPINDLE (DRIVER)
1	FTS20612P	SPINDLE (PASSENGER)

FT20397		HARDWARE SUBASSEMBLY
4	FT1036	BUSHING HALF
2	FT148	SLEEVE 1.250 X .530 X 2.400
4	FT20342	ALUMINUM SHOCK MOUNT BUSHING
4	FT20352	LOWER MOUNT SHIM TRUCK

FT20634 - HARDWARE KIT		LOCATION
20	M10 FLAT WASHER ZINC	
4	M10-1.5 GR C (CL 10) CROWNLOCK NUTS	
4	M10-1.5 X 30MM HEX HD	
12	M10-1.5 X 50MM HEX HD	
6	7.5" STANDARD CABLE TIE BLACK	
4	M18 FLAT WASHER	
2	M18-2.5 GRADE C LOCK NUT	
2	M18-2.5 X 50MM HEX HEAD	
10	1/4 SAE WASHER	
2	1/4 LOCK WASHER	
4	1/4-20 GR C CROWNLOCK NUT	
6	1/4-20 X 3/4 HEX BOLT G5 ZINC	
20	7/16 SAE WASHER G8 ZINC	
10	7/16-14 C-LOCK NUT ZINC	
2	7/16-14 X 1 1/4 HEX HD	
4	7/16-14 X 2-1/4 HEX BOLT	
4	7/16-14 X 3 1/2 HEX HD	
1	1/2-13 X 4 1/2 HEX BOLT	
8	1/2 SAE WASHER	
4	1/2-13 C-LOCK NUT	
1	1/2-13 X 1-1/4 HEX BOLT	
2	1/2-13 X 1-3/4 HEX BOLT	
4	9/16 SAE WASHER	
2	C-LOCK NUT 9/16"-12	
2	9/16-12 X 1 3/4 HEX HEAD	
8	5/8 SAE WASHER G8	
4	LOCK NUT STOVER 5/8"-11	
2	5/8-11 X 5" HEX HEAD	
2	5/8-11 X 5-3/4 HEX HEAD	
2	CLAMP 3/8X1/2W .26THK NEOPRENE	
1	THREAD LOCKING COMPOUND 1 MIL	

FT20615		HARDWARE SUBASSEMBLY
2	FT20602	SWAY BAR LINK BRACKET
1	FT20313	FRONT BRAKELINE BRACKET (DRIVER)
1	FT20314	FRONT BRAKELINE BRACKET (PASSENGER)
1	FT90085	BUSHING KIT

FT20669		HARDWARE SUBASSEMBLY
4	12008007100	ZIP TIE 8" BLACK 40 LBS
2	FT20277	OUTER TIE ROD
1	FT20300	6 LUG 1/4" WHEEL SPACER
1	FT20353	HARDWARE KIT
4	FT20351	BUSHING

- TOOL LIST -

Required Tools (Not Included)

Basic Hand Tools
Floor Jack
Jack Stands
Assorted Metric and S.A.E sockets, and Allen wrenches
Torque Wrench
Die Grinder w/ Cutoff Wheel or Sawzall

- PRE-INSTALLATION NOTES -

Read this before you begin installation-

Check all parts to the parts list above before beginning installation.

Read all instructions thoroughly from start to finish before beginning the installation. If these instructions are not properly followed severe frame, driveline and / or suspension damage may occur.

Check your local city and state laws prior to the installation of this system for legality. Do not install if not legal in your area.

Prior to the installation of this suspension system perform a front end alignment and record. Do not install this system if the vehicle alignment is not within factory specifications. Check for frame and suspension damage prior to installation.

The installation of this suspension system should be performed by two professional mechanics.

This suspension must be installed with Fabtech shock absorbers.

Use the provided thread locking compound on all hardware.

WARNING- Installation of this system will alter the center of gravity of the vehicle and may increase roll over as compared to stock.

Vehicles that receive oversized tires should check ball joints, uniballs, tie rods ends, pitman arm and idler arm every 2500-5000 miles for wear and replace as needed.

Verify differential fluid is at manufactures recommended level prior to kit installation. Installation of the kit will reposition the differential and the fill plug hole may be in a different position. (For example, if the manufacture recommends 3 quarts of fluid, make sure the diff has 3 quarts of fluid). Check your specific manual for correct amount of fluid.

FOOTNOTES -

- 8. Will not fit all wheel drive models.
- 14. Cannot use OEM wheel and tire.
- 16. Utilizes stock rear shocks.
- 101. Some models may not sit level after install.
- 132. Will not fit 2WD Suburban models.
- 134. Will not fit 2WD Yukon XL models.

- INSTRUCTIONS -

FRONT SUSPENSION

1. Disconnect the negative terminal on the battery. Jack up the front end of the truck and support the frame rails with jack stands. **NEVER WORK UNDER AN UNSUPPORTED VEHICLE!** Remove the front tires.
2. Working from front of the truck, disconnect the tie rod ends from the steering knuckle by striking the knuckle to dislodge the tie rod end. Use care not to damage the tie rod end when removing. **SEE FIGURE 1**

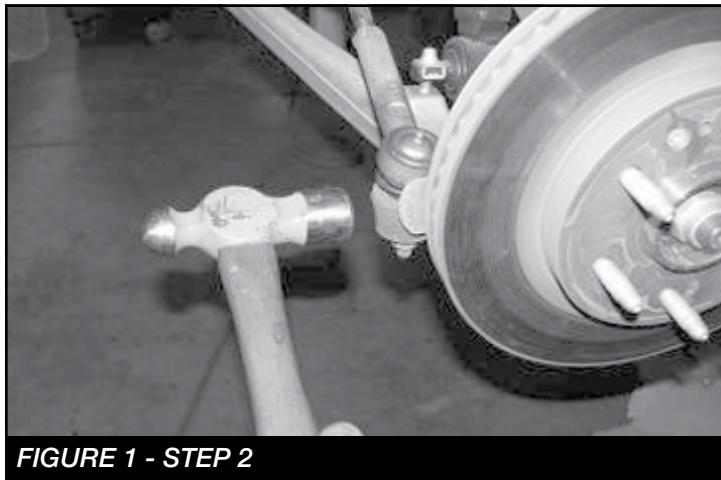

FIGURE 1 - STEP 2

3. Unplug the ABS brake connection from the frame and control arm. Remove the brake hose bracket from the steering knuckle. Remove the brake hose bracket from the coil bucket and save hardware. Remove the caliper from the rotor and secure the brake caliper to the frame out of the way. **DO NOT ALLOW THE BRAKE CALIPER TO HANG FROM THE BRAKE LINE HOSE. SEE FIGURE 2**



FIGURE 2 - STEP 3

4. Remove the wheel stud clips and discard. Remove bearing cover, axle nut, washer, and rotor with hub bearing. **(DO NOT REMOVE THE HUB BEARING FROM THE ROTOR).** Retain parts and hardware for reinstallation. **SEE FIGURES 3-4**



FIGURE 3 - STEP 4

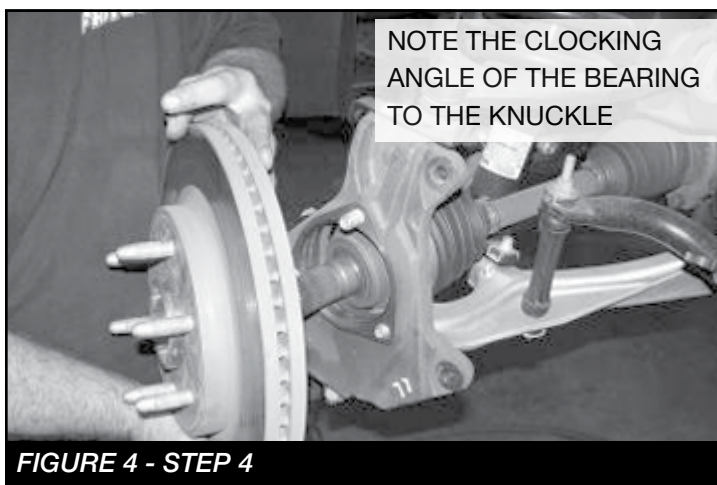

FIGURE 4 - STEP 4

5. Remove the upper and lower ball joint nuts. Disconnect the upper and lower ball joints from the steering knuckle by striking the knuckle with a large hammer next to each ball joint on the knuckle to dislodge the ball joints. Use care not to hit the ball joints when removing. Save nuts and discard knuckle. **SEE FIGURE 5**

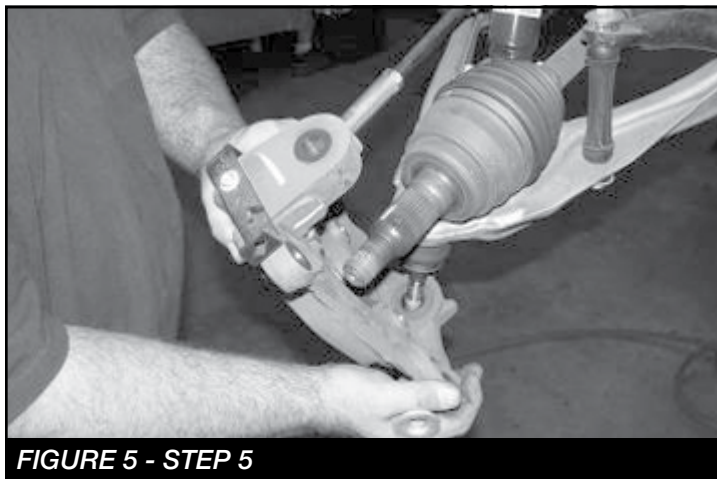
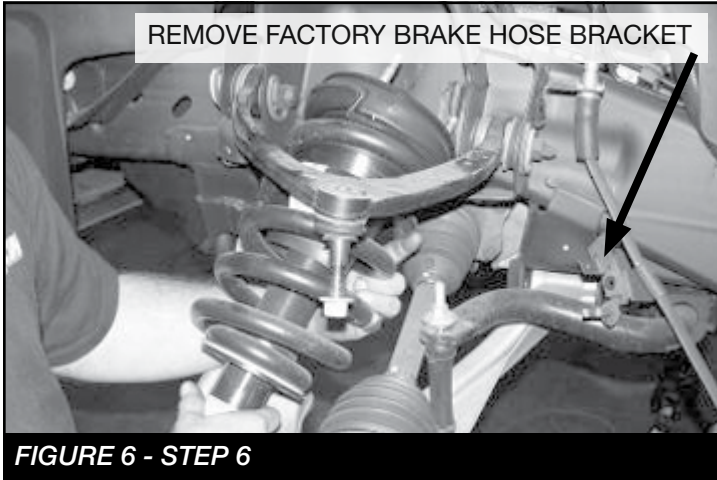
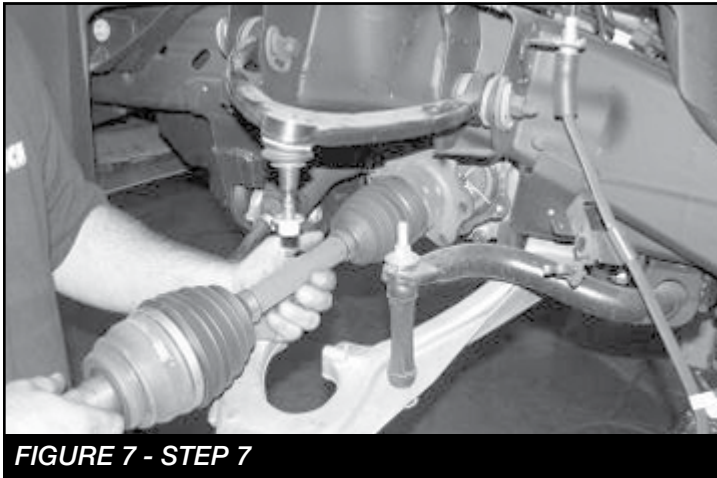

FIGURE 5 - STEP 5

6. Remove the shock assembly and save with the hardware. Remove and discard the factory brake line bracket from the brake hose that attached the hose to the upper control arm. **SEE FIGURE 6**



7. Disconnect and remove CV axles from differential housing and the sway bar endlinks and save. Discarding **ONLY** the CV axle hardware. **SEE FIGURE 7**



8. Remove the lower control arms from the frame and retain with the hardware for reinstallation. **SEE FIGURE 8**

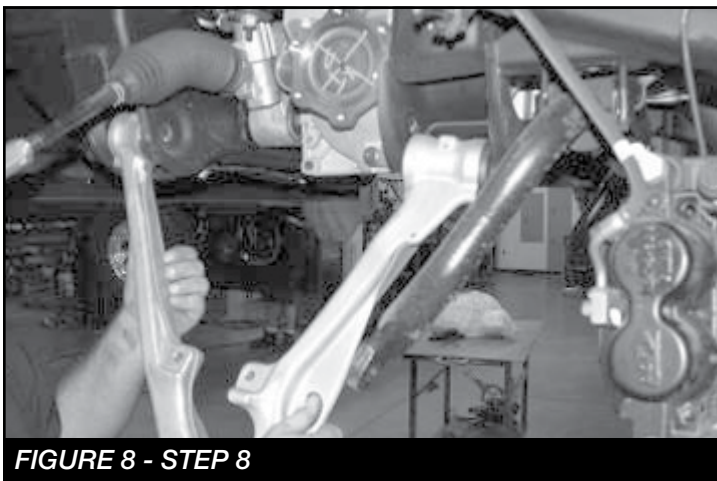

9. Locate, remove, and save the sway bar, discard hardware. **SEE FIGURE 9**

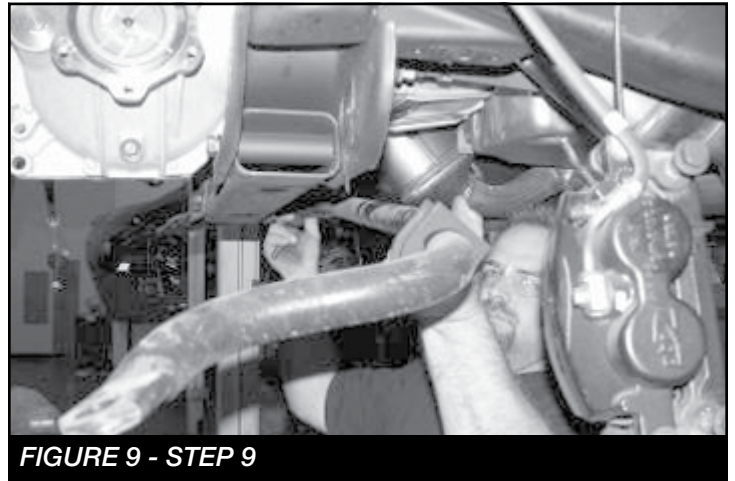

10. Remove front factory differential skid plate and splash shield and discard.
11. Disconnect front driveshaft from differential housing and retain bolts and u joint clamps for reinstallation. Locate, remove, and discard the factory rear crossmember with hardware.
12. Disconnect the electrical connection including the two retaining clamps and the vacuum line from differential housing. Remove differential housing assembly from vehicle. Retain hardware for reinstallation.
13. Locate the rear driver lower control arm mount on the frame. Measure 3" from the inside edge of the mount toward the frame and mark with a paint pen. Use a sawzall and cut the mount from the frame. **SEE FIGURE 10**

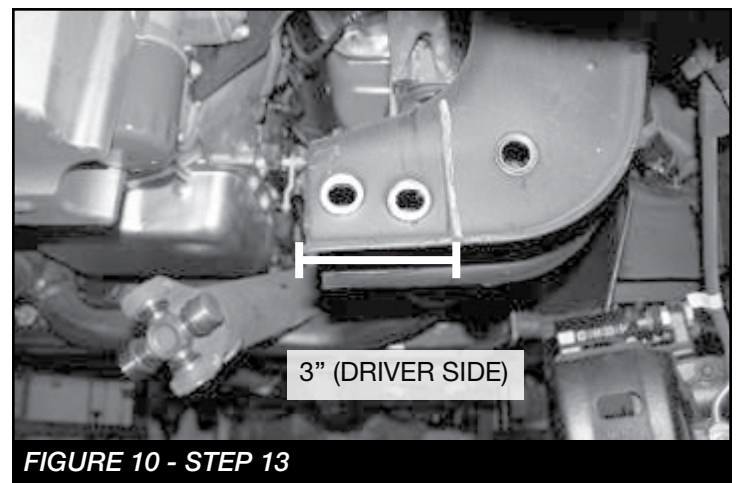

14. Locate the rear passenger lower control arm mount on the frame. Measure 3 1/2" from the inside edge of the mount toward the frame and mark with a paint pen. Use a sawzall and cut the mount from the frame.

SEE FIGURE 11

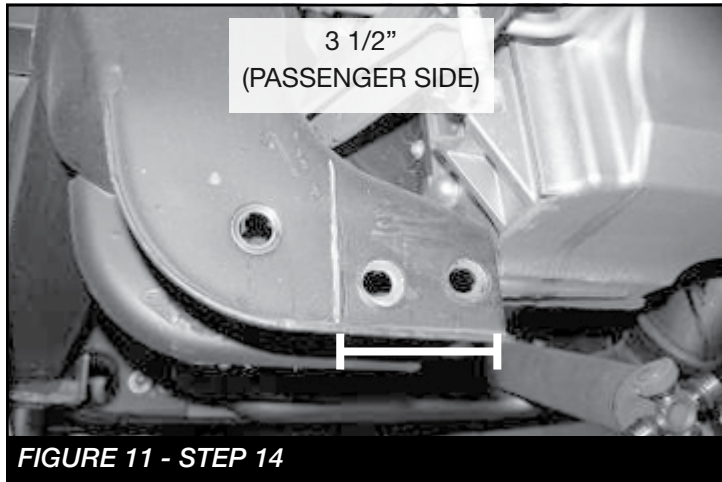

FIGURE 11 - STEP 14

15. Locate the factory front lower control arm pockets. Grind 1/4" section from both Corners of the pockets.

SEE FIGURES 12-13

DUE TO VARIANCES IN EACH TRUCK, ADDITIONAL GRINDING MAY BE REQUIRED FOR PROPER FITMENT OF THE CROSSMEMBERS. USE THESE MEASUREMENTS AS A STARTING POINT AND CLEARANCE THE FRAME POCKETS AS NEEDED FOR PROPER FITMENT OF THE CROSSMEMBERS

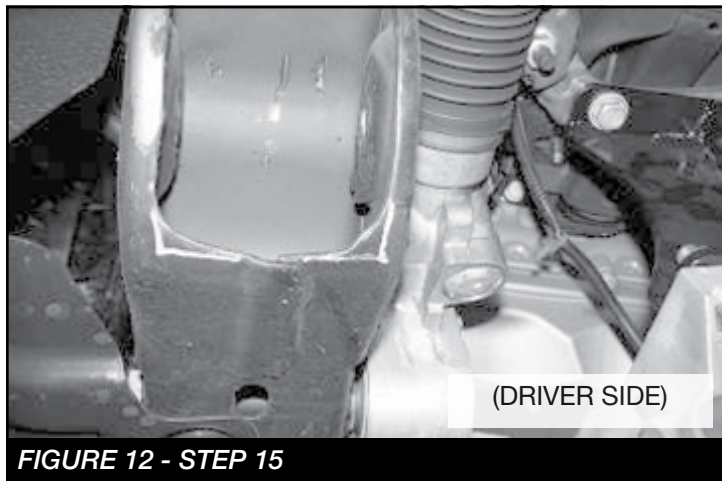

FIGURE 12 - STEP 15

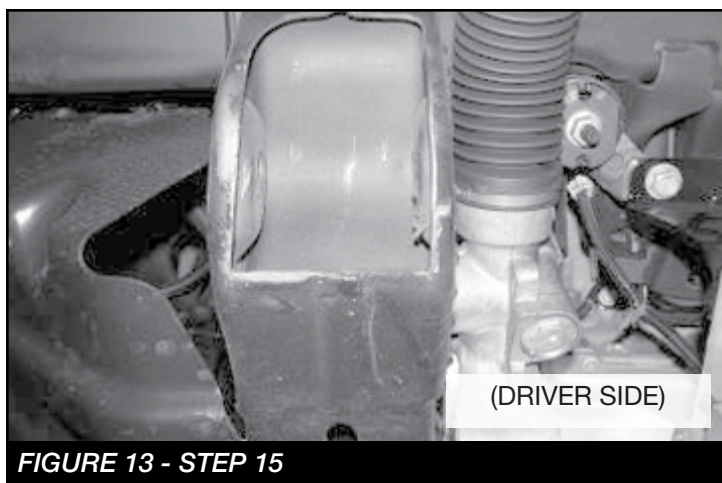

FIGURE 13 - STEP 15

16. Locate the front differential. The diff will need to be trimmed / cut in three places. The first is the 90 degree tab on the bottom front of the diff. Measure in 1 1/4" from the outer edge and cut with a sawzall as shown in photos. The second cut is the bottom rear gusset on the passenger side of the diff. Measure down 1/4" from the pinion side of the gusset and mark 1 1/2" long and 1/2" deep. Using a barrel sander, sand down the gusset as shown in photos below. The third cut is second gusset from the rear on the driver side of the diff. Mark the gusset 2 1/4" from the top and a 1/4" in. Using a barrel sander, sand down the gusset. **SEE FIGURES 14-19**

USE THESE MEASUREMENTS AS A STARTING POINT AND CLEARANCE THESE AREAS AS NEEDED FOR PROPER FITMENT OF THE DIFFERENTIAL

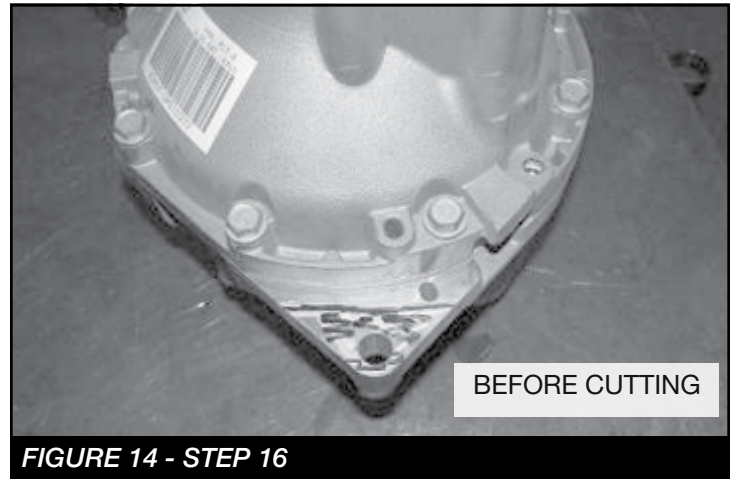

FIGURE 14 - STEP 16

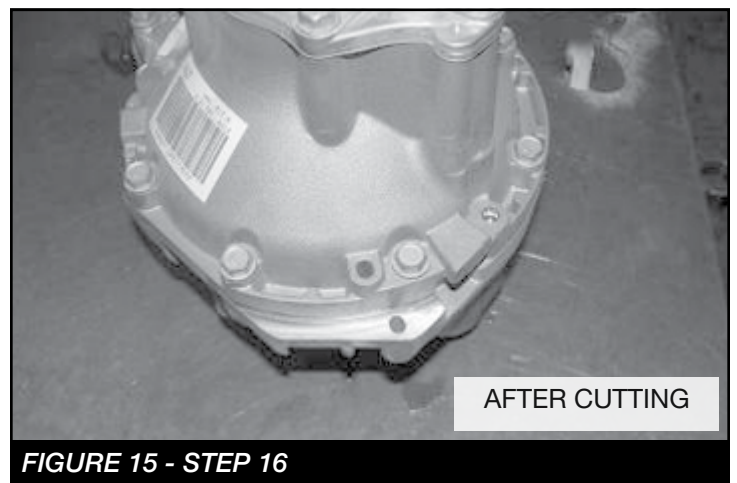

FIGURE 15 - STEP 16

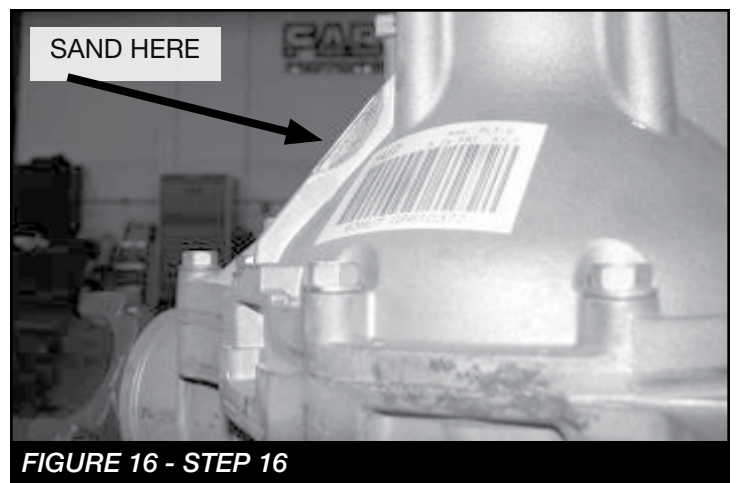

FIGURE 16 - STEP 16

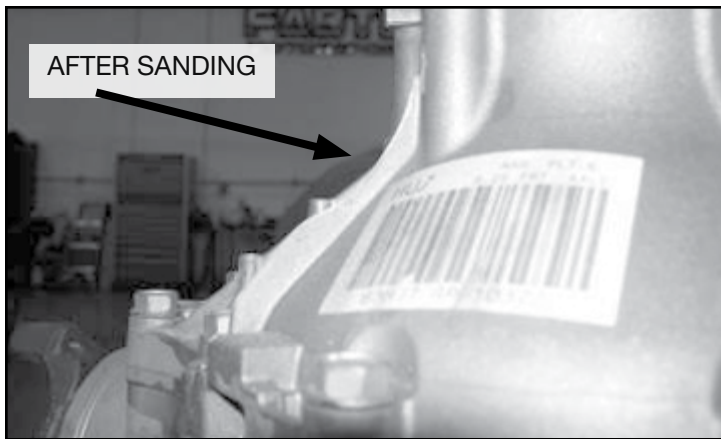

FIGURE 17 - STEP 16

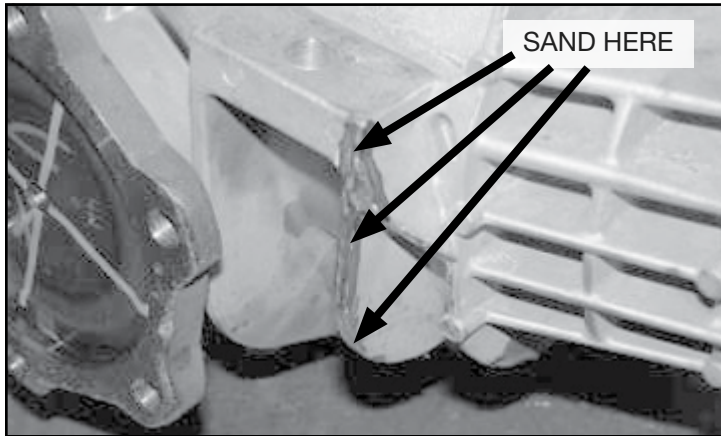

FIGURE 18 - STEP 16

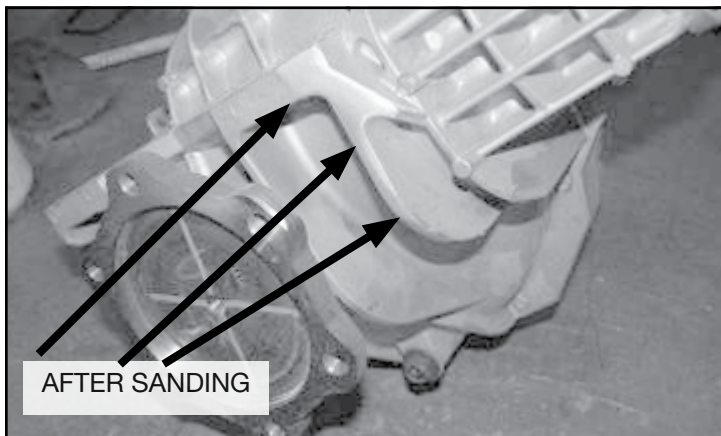

FIGURE 19 - STEP 16

17. Locate the driver upper differential mount. The locating pin on this mount needs to be cut off. Using a die grinder with a cutoff wheel, cut the pin flush with the bracket.
SEE FIGURES 20-21

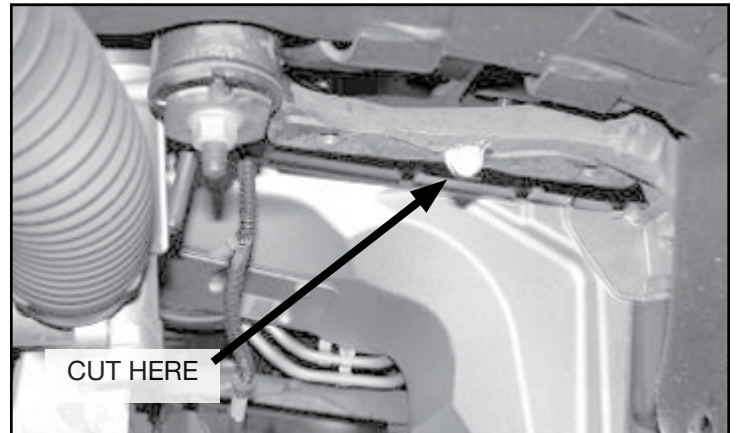

FIGURE 20 - STEP 17

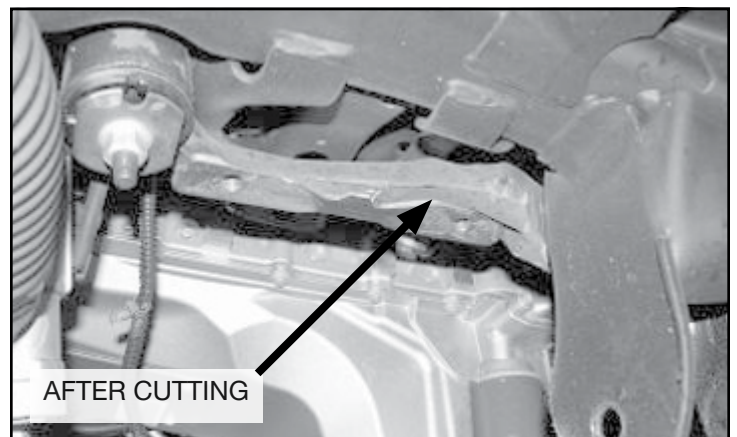

FIGURE 21 - STEP 17

18. Locate FT20347 (driver) & FT20633 (pass) Diff. brackets and the factory diff hardware. Install the brackets to the factory mounts with the taller part of the bracket to the front of the truck with the factory hardware. Torque to 75 ft-lbs. **SEE FIGURES 22-23**

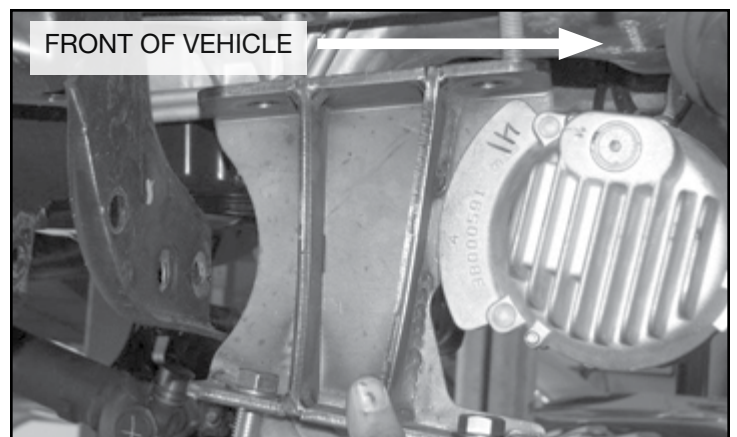

FIGURE 22 - STEP 18

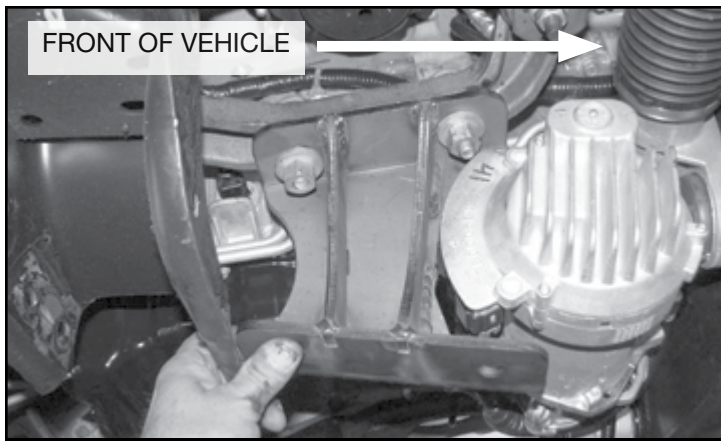

FIGURE 23 - STEP 18

19. Locate the supplied $\frac{1}{2}$ " x $1\frac{3}{4}$ " and $\frac{9}{16}$ " x $1\frac{3}{4}$ " hardware and the front diff. Install the diff onto the new drop brackets using the $\frac{1}{2}$ " hardware on the driver's side and the $\frac{9}{16}$ " on the passenger side. Torque the $\frac{1}{2}$ " hardware to 75 ft-lbs. and the $\frac{9}{16}$ " to 95 ft-lbs. Re-connect the electrical and vacuum connections back onto the diff. **(CHECK THE CLEARANCE OF THE DIFF TO THE FRAME IN SANDED AND CUT SPOTS ON THE DIFF. FOR ADAQUATE CLEARANCE TO THE FRAME AND CROSSMEMBER). SEE FIGURE 24**

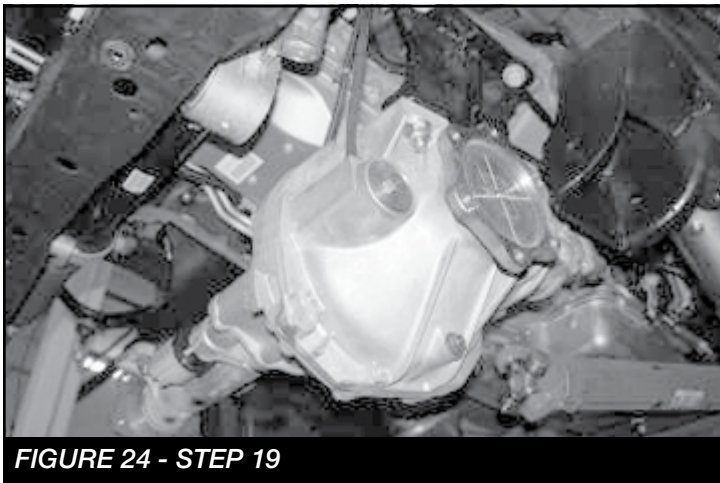

FIGURE 24 - STEP 19

20. Locate and install FT20611BK rear crossmember into the factory lower control arm pockets using the stock hardware and leave loose at this time. **(CHECK THE CLEARANCE OF THE DIFF TO CROSSMEMBER WHERE IT WAS SANDED DOWN IN STEP #17 FOR ADAQUATE CLEARANCE TO THE FRAME AND CROSSMEMBER). SEE FIGURE 25**

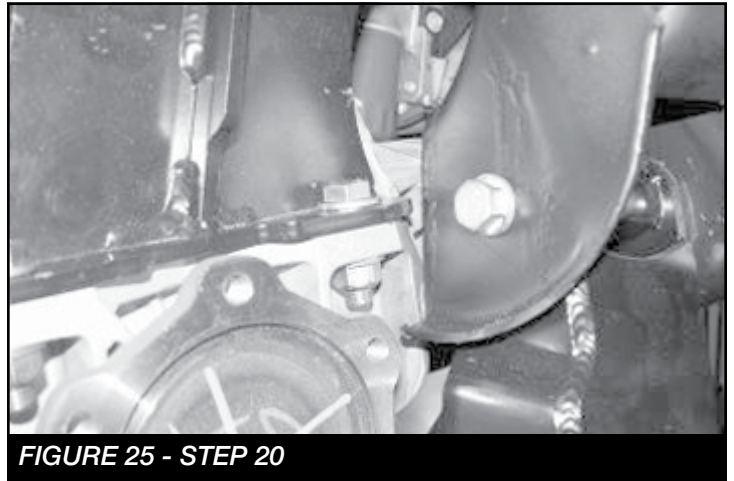

FIGURE 25 - STEP 20

21. Locate and install FT20610BK front crossmember into the factory lower control arm pockets using the stock hardware. Leave loose. **(CHECK THE CLEARANCE OF THE DIFF TO CROSSMEMBER WHERE IT WAS SANDED DOWN IN STEP #18 FOR ADAQUATE CLEARANCE TO THE FRAME AND CROSSMEMBER). SEE FIGURES 26-27**

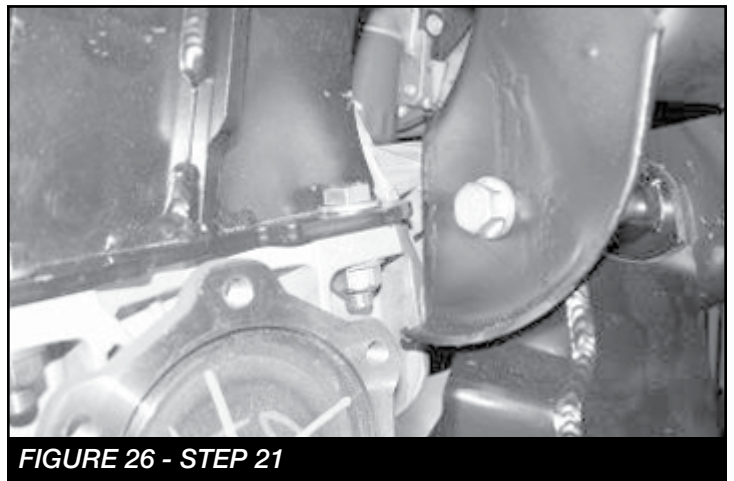

FIGURE 26 - STEP 21

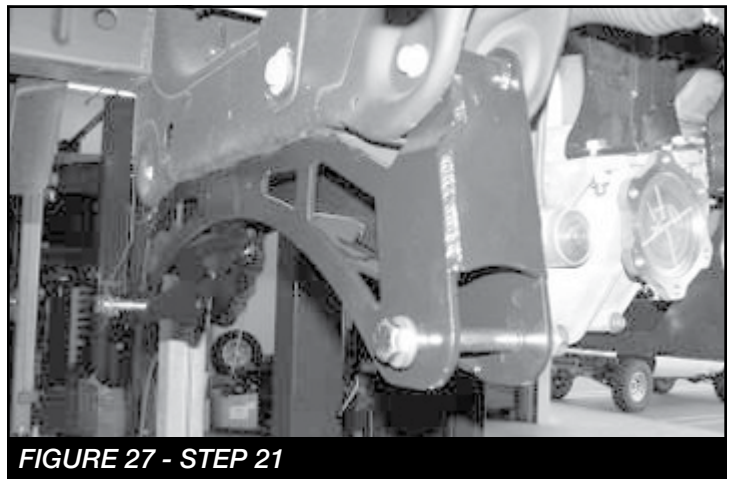

FIGURE 27 - STEP 21

22. Install FT90085 bushing kit into FT20365 diff bracket.
23. Remove the 3 factory diff housing bolts.
24. Install diff bracket using the factory bolts and the 1/2-13x4 1/2" bolt, nut, and washers. **SEE FIGURE 28**

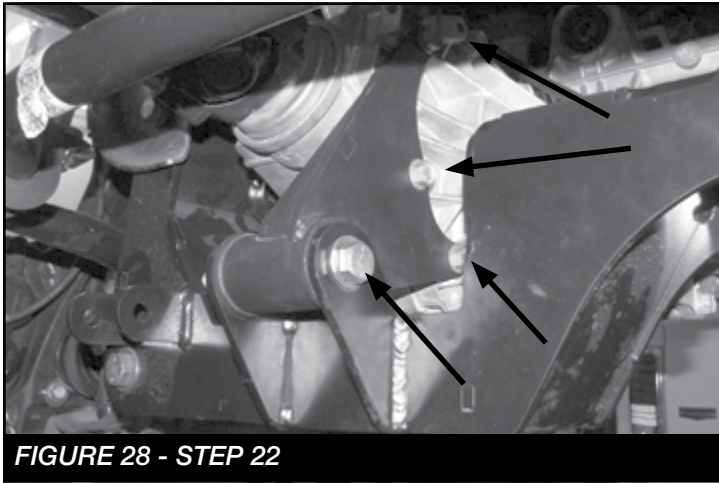

FIGURE 28 - STEP 22

25. Locate FT20284 Crossmember Support Tubes. Install the lower control arms into the new crossmembers using the 5/8" x 5" hardware in the front pocket. Position the control arms into the crossmember and insert only the front 5/8" bolt just so that it is through the arm. Position the Support tube between the crossmembers and rotate them up to the locating tabs on the crossmember. Install 5/8" x 5 3/4" hardware in the rear pocket and the front bolt with hardware. Leave loose. **SEE FIGURE 29**

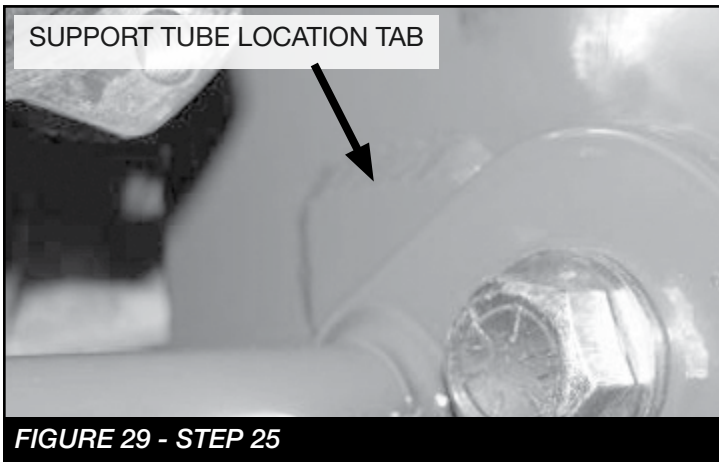

FIGURE 29 - STEP 25

26. Locate FT20304 Skid Plate and the supplied 1/2" x 1-1/4" hardware and attach the rear of the skid plate to the bottom of the rear crossmember. Use the supplied 7/16" x 1 1/4" hardware and attach the front of the skid plate to the front crossmember (**MAKE SURE THAT THE DIFF IS CLEARANCED ENOUGH TO CLEAR THE SKID PLATE**). **SEE FIGURE 30**

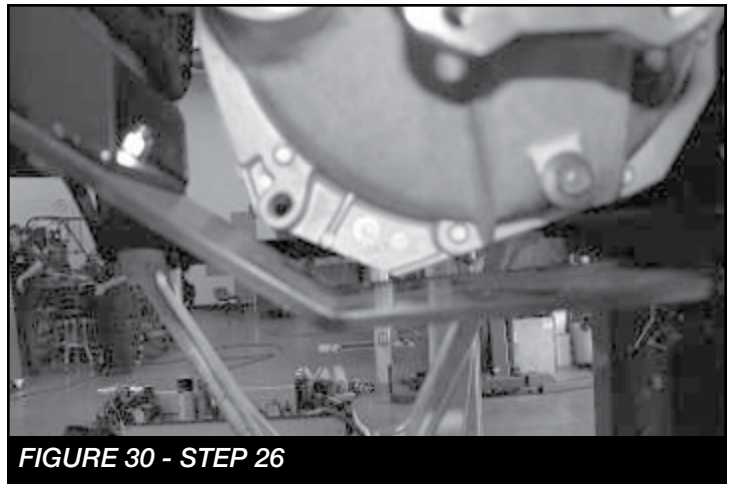

FIGURE 30 - STEP 26

27. Torque the crossmember frame pocket bolts to 125 ft-lbs., the lower control arm bolts to 110 ft-lbs. the 1/2" skid plate hardware to 75 ft-lbs., and the 7/16" to 50 ft-lbs.
28. Locate the factory coilovers. Remove the nut clips from the cross-shaft and discard. Using a press, press out the cross-shaft and the bushing from the bottom of the coilover and discard. **SEE FIGURES 31-33**



FIGURE 31 - STEP 28

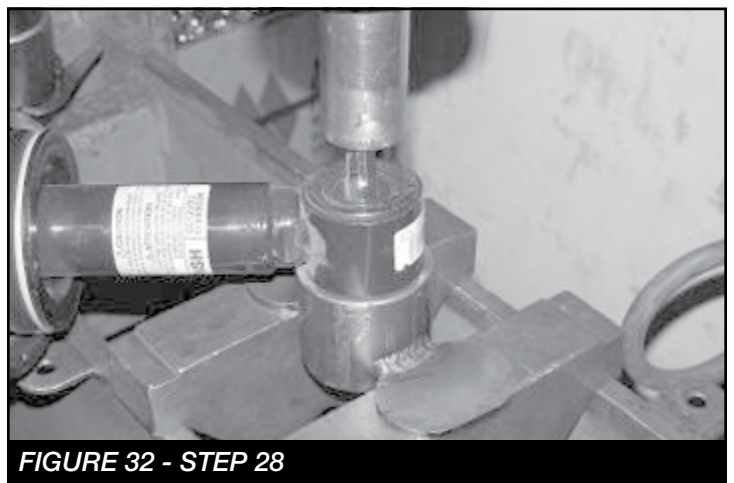

FIGURE 32 - STEP 28



FIGURE 33 - STEP 28

29. Locate Box 3 FTS21042BK which has FT20339 Shock Mount to Arm, FT20323 Shock Extensions, FT20568 Shock Brackets, Hardware Kit FT20295, FT1036 Bushings, and FT148 Sleeves. **NOTE: Due to variances use either FT20351 or FT20342 aluminum bushings.** Using a press, press the bushings and sleeves (with the provided lube) into the shock extension. Insert the Aluminum Bushings into the bottom of the factory shock. **SEE FIGURE 34-36**



FIGURE 34 - STEP 29



FIGURE 35 - STEP 29



FIGURE 36 - STEP 29

30. Place the Shock Brackets around the bottom of the shock and align with the aluminum sleeves. Position the shock extension over the brackets and also align with the aluminum sleeves. Locate the supplied $\frac{1}{2}$ " x 4" bolts and hardware and install through the aluminum bushing and the shock mount. Leave loose. Locate the $\frac{5}{16}$ " x $1\frac{1}{2}$ " bolts and hardware and install into the shock brackets. Tighten the $\frac{5}{16}$ " hardware so the brackets are evenly spaced on the shock. Torque to 20 ft-lbs. Torque the $\frac{1}{2}$ " hardware to 75 ft-lbs. **SEE FIGURE 37-40**



FIGURE 37 - STEP 30

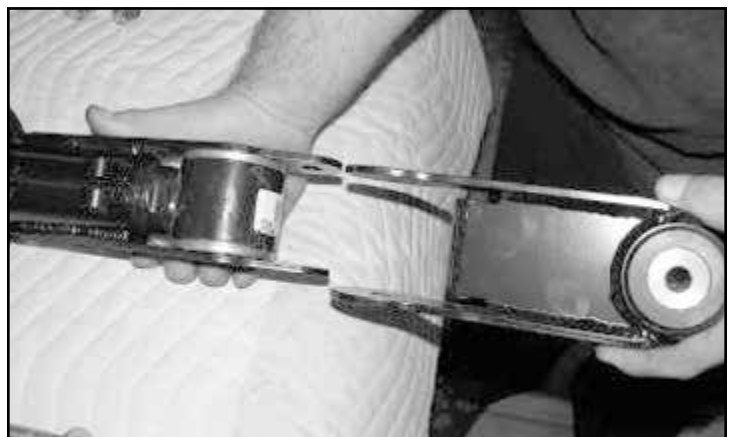

FIGURE 38 - STEP 30

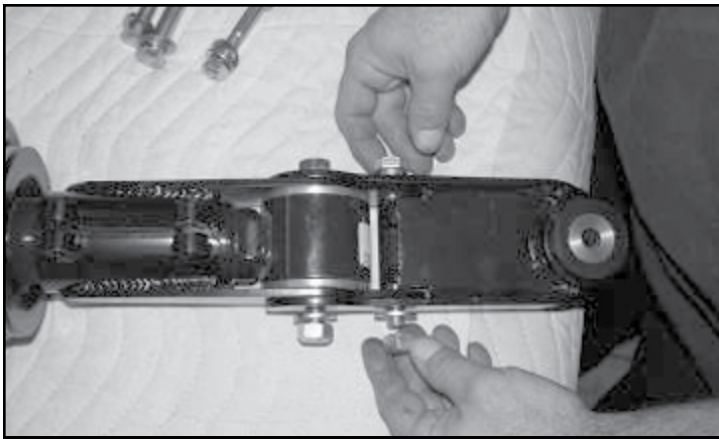

FIGURE 39 - STEP 30



FIGURE 40 - STEP 30

31. Locate the factory upper shock hardware. Install the shock into the factory shock bucket and leave loose. **SEE FIGURES 41-42**

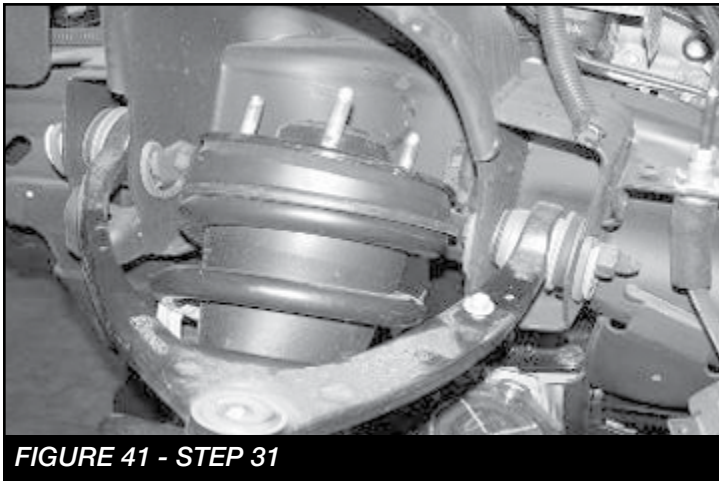

FIGURE 41 - STEP 31

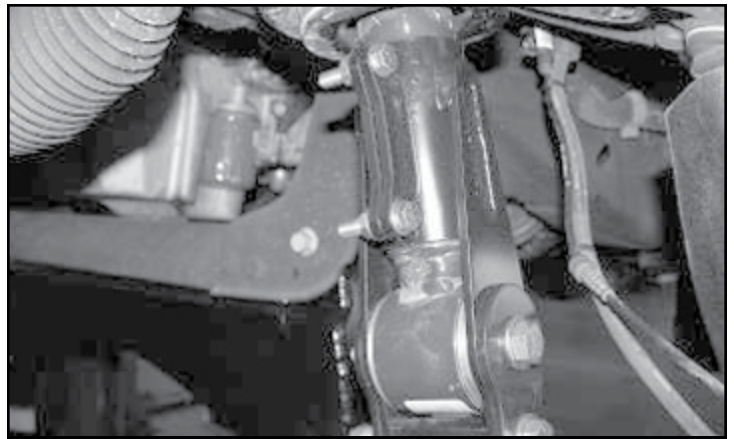

FIGURE 42 - STEP 31

32. Locate FT20339 Lower Shock Mount, FT20352 Lower Mount Shim, and the supplied 7/16" x 2 1/2" hardware. Position the mount onto the lower control arm so the flat side of the bracket will be flush with the stop on the arm. Position the shim (**ONLY USE THE SHIMS ON THE FORGED STEEL CONTROL ARMS**) in between the new mount and the control arm. Attach with the 7/16" hardware and torque to 50 ft-lbs. Rotate the lower control arm up and attach the strut to the new mount with the provided 1/2" x 3 3/4" hardware and torque to 75 ft-lbs. (it may be necessary to rotate the shock and extension to attach). Torque the top shock bolts to 40 ft-lbs. **SEE FIGURES 43-46**

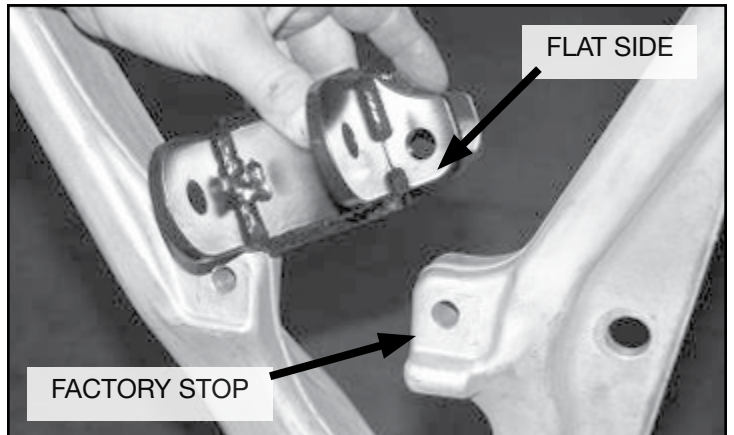

FIGURE 43 - STEP 32

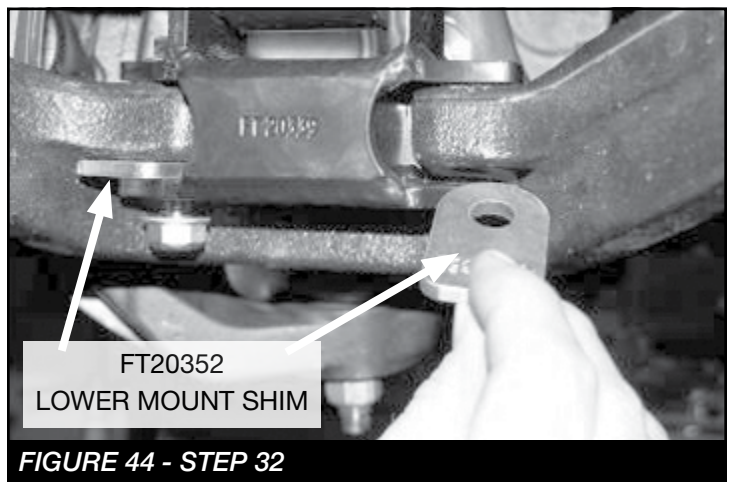

FIGURE 44 - STEP 32

LOOKING TOWARDS GROUND, TURN ONLY IN COUNTER
CLOCKWISE DIRECTION AND ROTATE AS NECESSARY

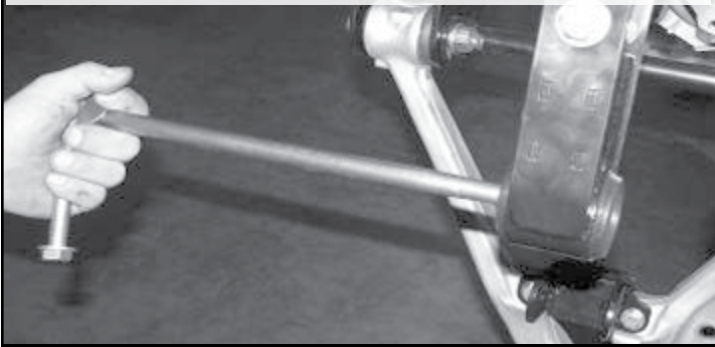

FIGURE 45 - STEP 32

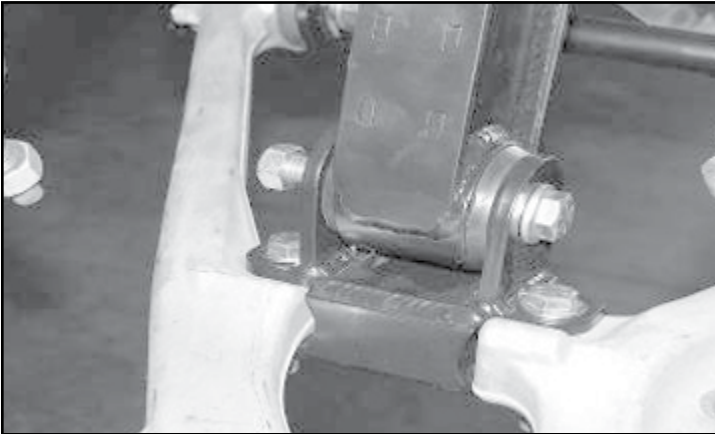

FIGURE 46 - STEP 32

33. Locate the steering knuckle FT20276D and FT20276P if you have the factory steel knuckles. If you have the factory aluminum knuckle locate FTS20612D and FTS20612P you need to install the FT20613 and FT20614 ball joint spacer under the nut when installing the knuckle. Attach the lower control arm to the knuckle using the stock hardware and torque to 70 ft-lbs. Attach the upper control arm to the new knuckle using the factory hardware and torque to 35 ft-lbs. **SEE FIGURE 47**

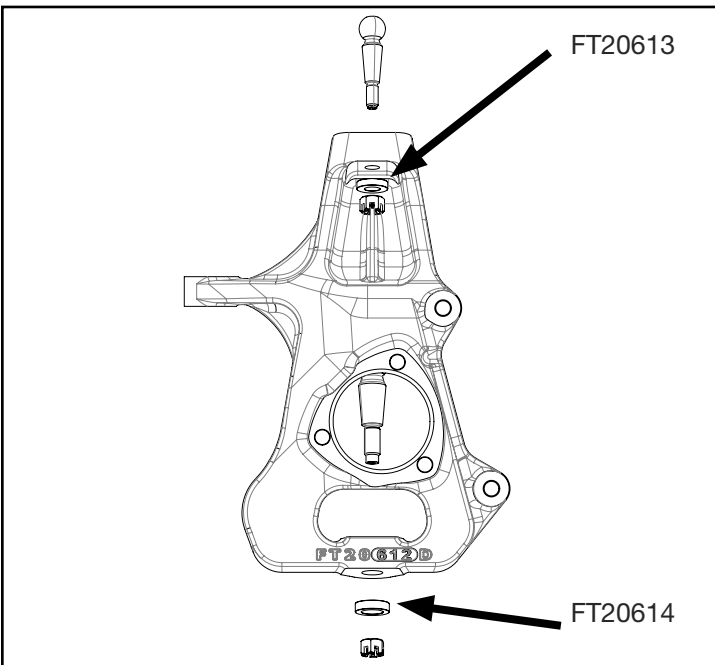

FIGURE 47 - STEP 33

34. Reinstall axle shaft through new knuckle and torque axle nut to 150 ft-lbs. and install bearing cover.
35. Locate and install the FT20289 CV spacers between the CV axle and the differential housing using 10mm x 50mm bolt and washer with the provided thread lock compound and torque to 55 ft-lbs. in a cross pattern.
SEE FIGURES 48-49

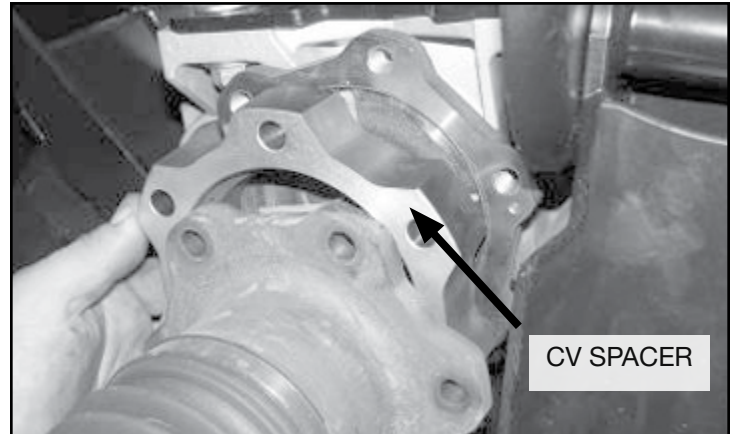

FIGURE 48 - STEP 35



FIGURE 49 - STEP 35

36. Reinstall the dust shield and hub bearing assembly using the stock hardware and torque flange bolts to 125 ft-lbs.
37. Trim the dust shield to clear the caliper.
SEE FIGURES 50-51

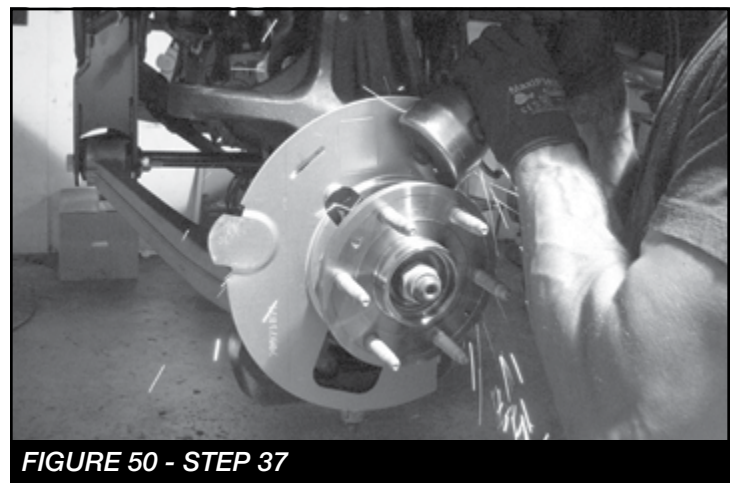

FIGURE 50 - STEP 37

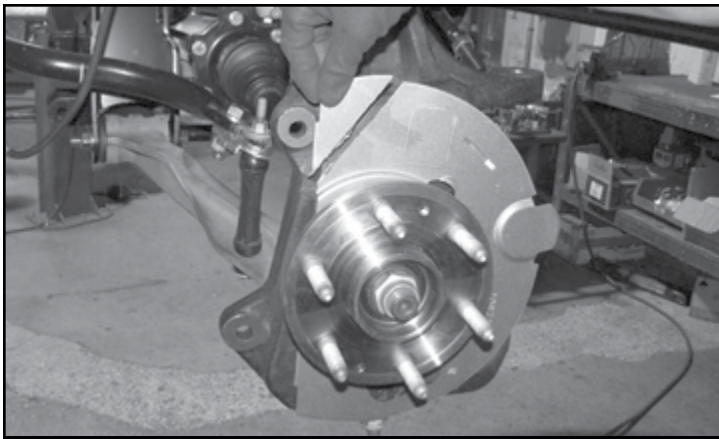

FIGURE 51 - STEP 37

38. Reinstall brake rotor and caliper. Torque caliper bolts to 100 ft-lbs.
39. Locate FT20277 outer tie rods. Loosen the jam nut and remove the factory outer tie rods and discard, leaving the factory jam nut on the inner tie rod. Install the new outer tie rod onto the inner tie rod until it makes contact with the jam nut. Attach new tie rod end to the knuckle with the supplied nut and torque to 40 ft-lbs. **(THIS IS JUST A STARTING POINT; A FINAL ALIGNMENT MUST BE PERFORMED UPON COMPLETION OF SUSPENSION SYSTEM).** SEE FIGURES 52-53

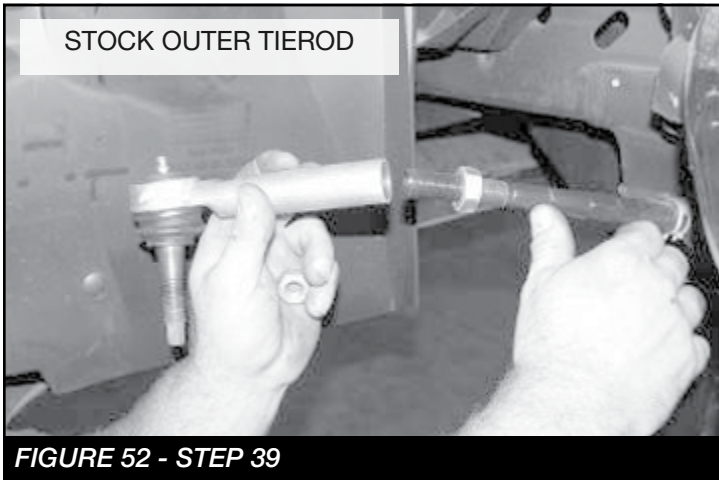

FIGURE 52 - STEP 39

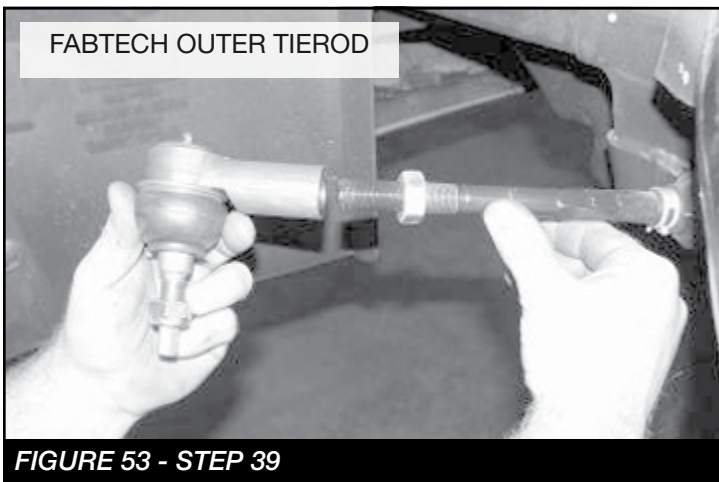

FIGURE 53 - STEP 39

40. Locate FT20312 (Drv), FT20318 (Pass) Sway Bar Frame Bracket, and the supplied 7/16"x2 1/4" and 10mm x 30mm hardware. Position the frame bracket on the frame so that sway bar will be farther back from the suspension and attach with the 10mm hardware. Locate the factory sway bar with the factory mounts and attach to the new brackets with the 7/16" hardware and torque to 50 ft-lbs. and the 10mm hardware to 25 ft-lbs. **SEE FIGURE 54**

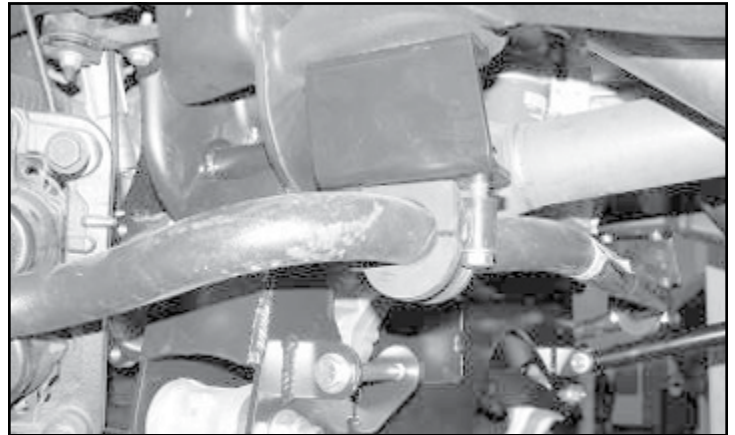

FIGURE 54 - STEP 40

41. Locate FT20602 Sway Bar Mounts and the supplied 18mm x 50mm hardware. Position the Sway Bar Mount so that it is on the bottom of the sway bar with the SHORTER side of the mount against the stop plate end of the mount. Attach with the 18mm hardware and torque to 110 ft-lbs. Locate the factory sway bar end links and attach to the new mount and the lower control arm. **(NOTE - SOME PICK UP TRUCKS MAY BE EQUIPPED WITH SUV STYLE SWAY BAR).** SEE FIGURE 55

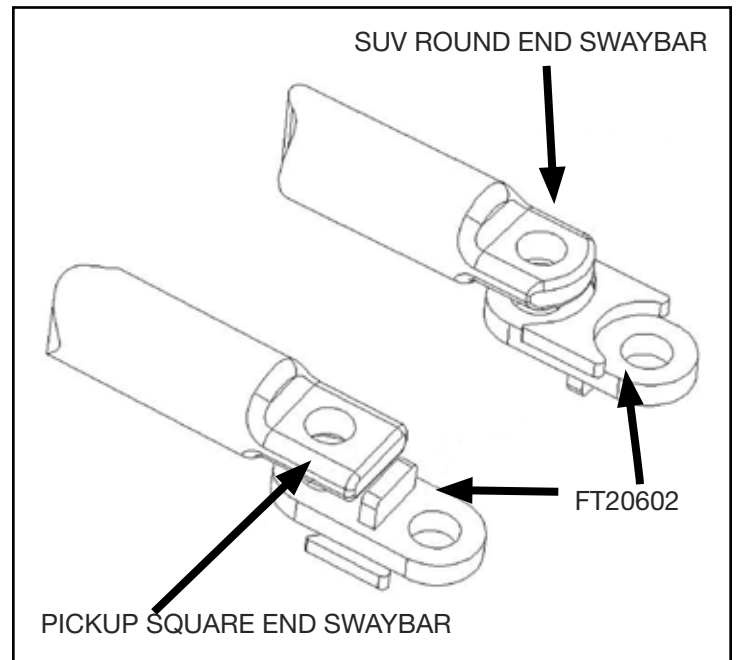
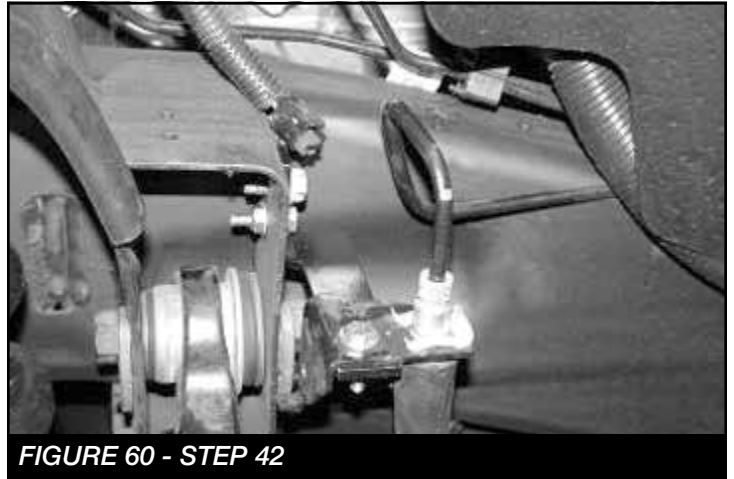
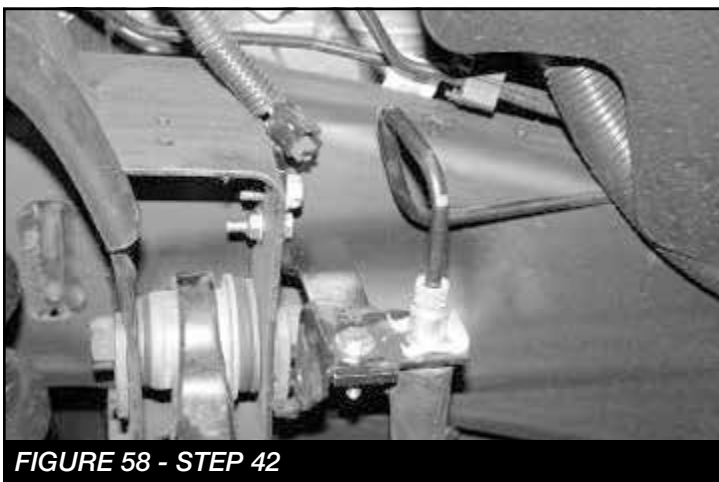
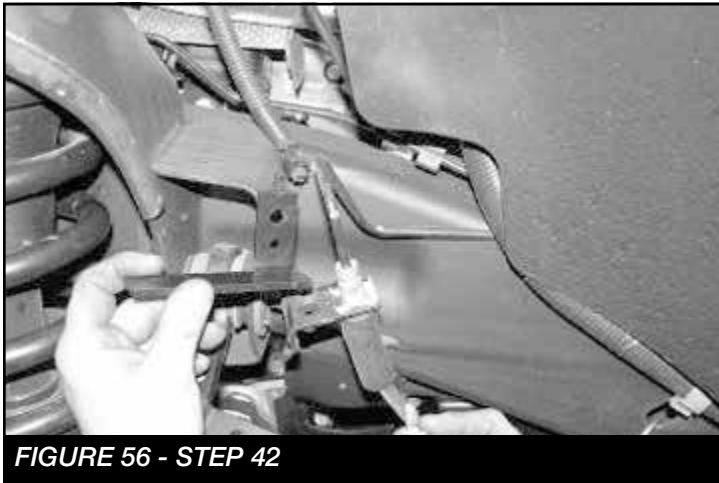

FIGURE 55 - STEP 41

42. Locate FT20313 (drv.) FT20314 (pass) Brake Line Bracket and $\frac{1}{4}$ " x $\frac{3}{4}$ " hardware. Position the new bracket into the factory brake line bracket location and attach with the factory hardware and the $\frac{1}{4}$ " hardware. Attach the factory brake line bracket to the new Fabtech bracket. Carefully bend the hard brake line and attach with the supplied $\frac{1}{4}$ " hardware. Torque to 10 ft-lbs. **SEE FIGURES 56-60**



43. Re-route the brake hose and the ABS Line to the steering knuckle using the adel clamp to the back of the steering knuckle and attach with $\frac{1}{4}$ " x $\frac{3}{4}$ " bolt and washer. Torque to 10 ft-lbs. Route the ABS line next to the brake hose. Re-connect the ABS line to the harness in the wheel well. Using provided plastic tyrap secure line to the hose and away from the tire and wheel. **SEE FIGURE 61**



44. Reattach the driveshaft to the differential yoke using the stock hardware and torque to 19 ft-lbs.

TO COMPLETE INSTALLATION, REFER TO REAR KIT INSTRUCTIONS FT21051I

45. Install tires and wheels and torque lug nuts to wheel manufacturer's specifications. Turn front tires left to right and check for appropriate tire clearance. **Note - Some oversized tires may require trimming of the front bumper & valance.**
46. Check front end alignment and set to factory specifications. Readjust headlights.
47. Recheck all bolts for proper torque.
48. Recheck brake hoses, ABS wires and suspension parts for proper tire clearance while turning tires fully left to right.
49. Check the fluid in the front and rear differential and fill if needed with factory specification differential oil. **Note - some differentials may expel fluid after filling and driving. This can be normal in resetting the fluid level with the new position of the differential/s.**
50. Install Driver Warning Decal. Complete product registration card and mail to Fabtech in order to receive future safety and technical bulletins on this suspension.
51. Have vehicle properly aligned to factory specs.