



**OPEN  
FENDER  
MANUAL**

**2018**

**INSTALLATION INSTRUCTIONS**

**OPEN FENDER SYSTEM**

**PRODUCT NUMBER: TF4100/TF4110**

**APPLICATION: 2017 FORD F250/350**



# SAFETY

Your safety and the safety of others is very important.

In order to help you make informed decisions about safety, we have provided installation instructions and other information.

These instructions alert you to potential hazards that could hurt you or others.

Please do a job safety analysis before each task to identify potential hazards for your situation and remove/protect against them.

Use own good judgment, and take your time.

Read and understand all safety precautions and instructions before installing this product.

**THIS PRODUCT IS FOR OFFROAD USE ONLY. ALL LIABILITY FOR INSTALLATION AND USE RESTS WITH THE OWNER.**

**CARELESS INSTALLATION AND OPERATION CAN RESULT IN SERIOUS INJURY OR EQUIPMENT DAMAGE.**

**FOR PROFESSIONAL INSTALLATION ONLY.**

## DISCLAIMER

Failure to observe these instructions could lead to severe injury or death.

- Always remove jewelry and wear eye protection.
- Always use extreme caution when jacking up a vehicle for work. Set emergency brake and use tire blocks. Locate and use the vehicle manufacturers designated lifting points. Use jack stands.
- Always use appropriate and adequate care in lifting components into place.
- Always insure components will remain secure during installation and operation.
- Always wear safety glasses when installing this kit. A drilling operation will cause flying metal chips. Flying chips can cause serious eye injury.
- Always use extreme caution when drilling a vehicle. Always disconnect power before welding. Thoroughly inspect the area to be drilled (on both sides of material when possible) prior to drilling, and relocate any objects that may be damaged.
- Always use extreme caution when welding a vehicle. Thoroughly inspect the area to be welded (on both sides of material when possible) prior to welding, and relocate any objects that may be a fire hazard. When welding in a cab make sure to interior surfaces are covered (e.g. welding blanket) and a fire extinguisher is at hand.
- Always use extreme caution when cutting and trimming during fitting.
- Always tighten all nuts and bolts securely per installation instructions.
- Always route electrical cables carefully. Avoid moving parts, components that become hot and rough or sharp edges.
- Always insulate and protect all exposed wiring and electrical terminals.
- Perform regular inspections and maintenance on mounts and hardware.
- Tire may rub at max turn or articulation.

# TABLE OF CONTENTS

SAFETY .....	1
DISCLAIMER .....	1
TABLE OF CONTENTS .....	2
A WORD FROM THE OWNER.....	3
HOW TO USE THIS MANUAL .....	4
CHAPTER 1: BEFORE WE START .....	5
<i>Lay out and account for all hardware AND ACCESSORIES....</i>	<i>6</i>
<i>Optional: Inner Fender &amp; Fender Flare .....</i>	<i>7</i>
<i>Fully lay out and account for all FAB FOUR parts .....</i>	<i>7</i>
FAB FOURS PARTS LIST .....	8
TOOLS REQUIRED .....	8
ORGANIZATION .....	8
EASE OF ACCESS .....	8
CHAPTER 2: DISASSEMBLY & PREPARATION .....	9
GRILLE REMOVAL .....	9
BUMPER REMOVAL .....	12
FRONT FENDER TRIM REMOVAL .....	15
HEADLIGHT REMOVAL .....	19
FRONT FENDER REMOVAL .....	22
CHAPTER 3: TEMPLATE MOUNTING (CHEVY 1500) .....	27
CHAPTER 4: CUTTING (CHEVY 1500 FRONT & F250 REAR)....	35
CHAPTER 5: INSTALLATION - CAB & FRAME (FORD F350)....	46
CHAPTER 6: INSTALLATION - FENDER SYSTEM.....	55
CHAPTER 7: MAINTENANCE & CARE.....	59
APPENDIX 1: VIDEO GUIDE.....	61
APPENDIX 2: TROUBLE SHOOTING .....	63





INTRO

# OWNER'S MESSAGE

---



Thank you for purchasing our Fab Fours "Open Fender Kit"... You are not just modifying your vehicle, but participating in evolving the future of all truck and Jeep customization with us! You chose this method of tire fitment for the same reason that I invested so much to create it - we both believe that the ultimate lift truck should have no lift at all! Low slung, wide stance, optimal CG, all come together to make the baddest looking, best riding, biggest tire fitting trucks on the planet! We have gone to great lengths to perfect this system, knowing the risks in cutting a brand new vehicle - please follow the instructions and videos carefully to ensure proper execution and you will be on your way soon with a #40sNolift truck!

Welcome to the family!

*Ereg Higgs*

FOUNDER, FAB FOURS



## HOW TO USE THIS MANUAL



This technical manual is meant to be a comprehensive companion to online video resources. Few manuals offer a similar combination of hands-on information, color images, and video instruction. Our goal is to provide this comprehensive instruction in bite-sized and manageable chunks that an individual will feel comfortable using. **THIS IS NOT A REPLACEMENT FOR THE PROFESSIONAL SKILLS AND EXPERIENCE REQUIRED, BUT A SUPPLEMENTAL REFERENCE.**

The appendixes in the back of the manual provide references to individual videos as well as information for trouble shooting. It is recommended to refer back to it whenever the appropriate icon is shown.



### **VIDEO GUIDED**

Where ever this icon is located there are supplementary videos. These video will be given at the head of every section by an accompanying path name for locating them on the web site.

### **UNIQUE TOOLS & HARDWARE**

Where ever this icon is located there are special tools required for installation.

### **MEASUREMENT**

Where ever this icon is located it indicates a measurement or adjustment that is required at this stage in installation

**Take care when executing the steps. Damage to part or vehicle could make installation more difficult and time consuming.**

# CHAPTER 1

## BEFORE YOU START

# INSTALLATION INSTRUCTIONS

## OPEN FENDER SYSTEM

Product Number: TF41XX  
Application: 2017 FORD F250/350

# TF4100

## [ OPEN FENDER BASE ]

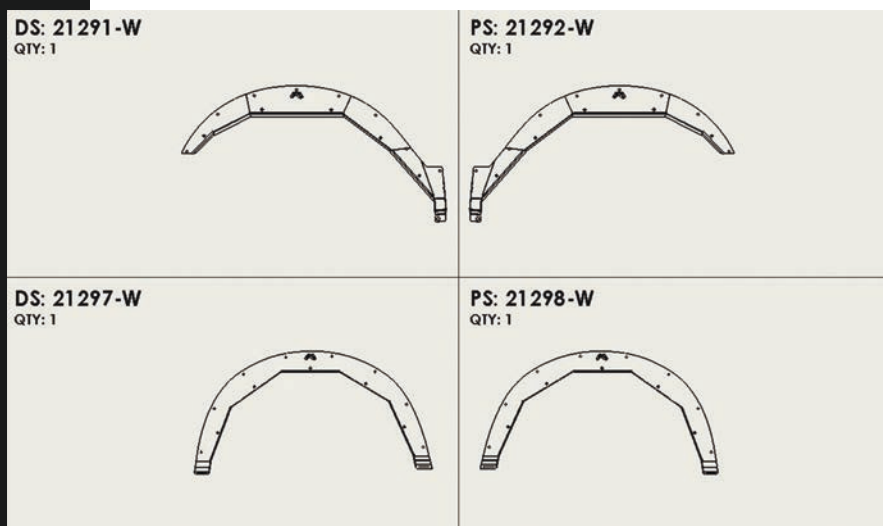
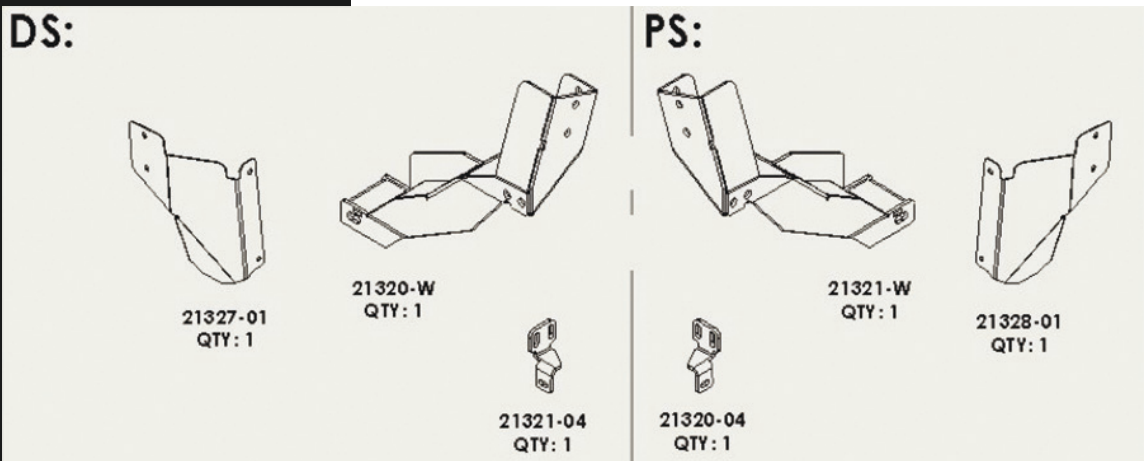
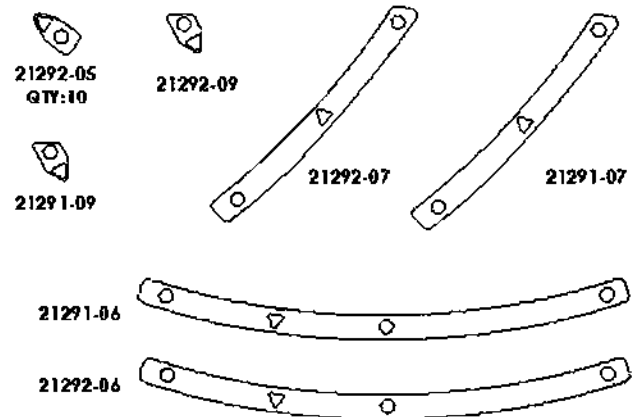



# [ TF4100 HW-KIT ]

Fully layout and account for all hardware and accessories.

52x

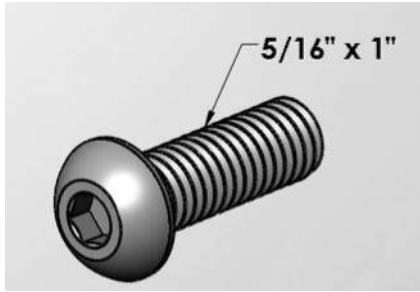

2x

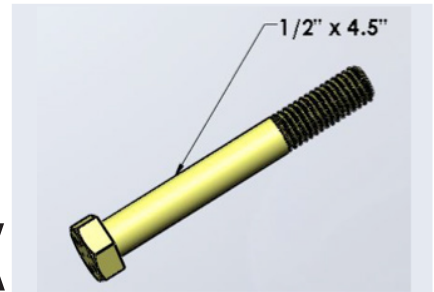

4x

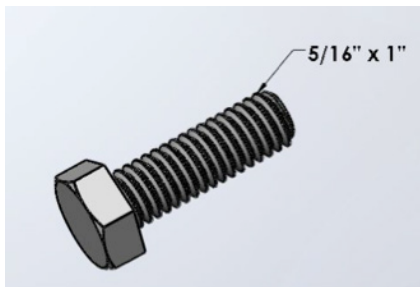

52x

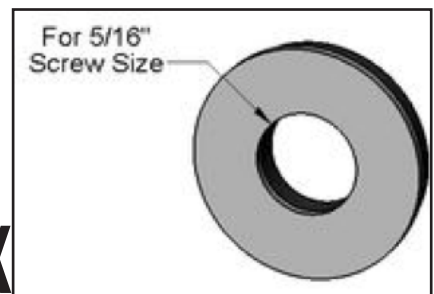

10x

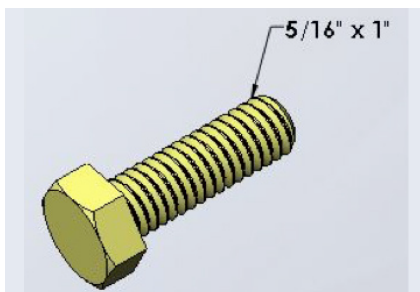

10x



6x

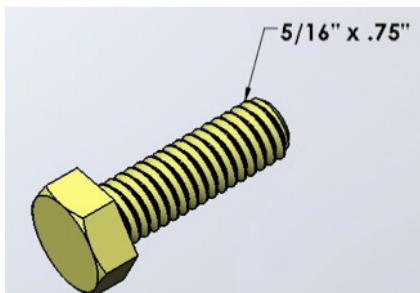

22x

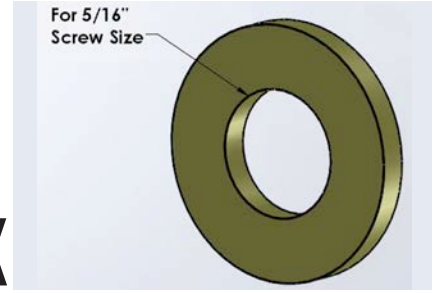

2x

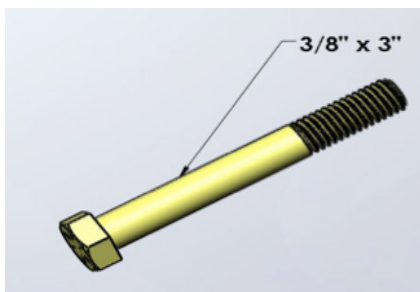

2x

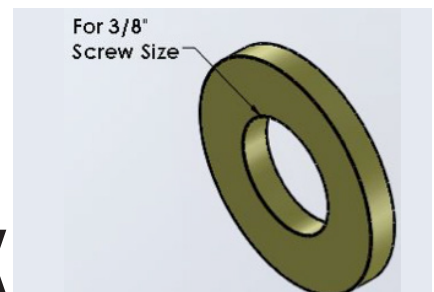

# [ TF4100 HW-KIT ]

Fully layout and account for all hardware and accessories.

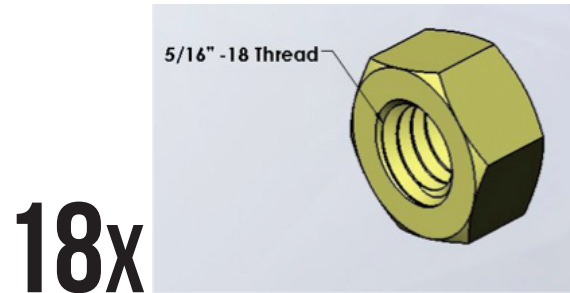
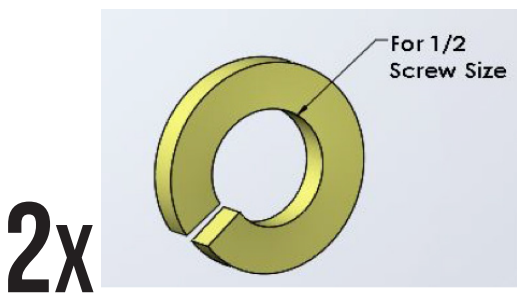
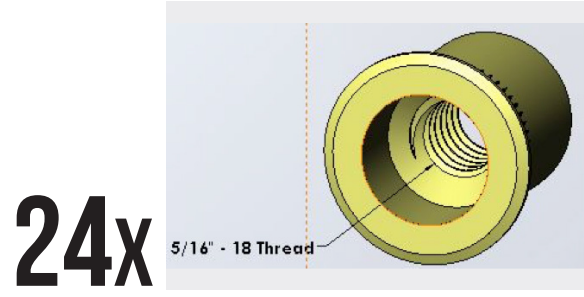
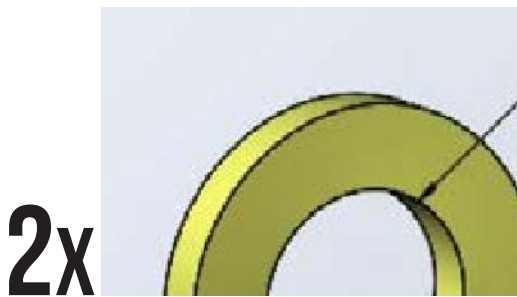
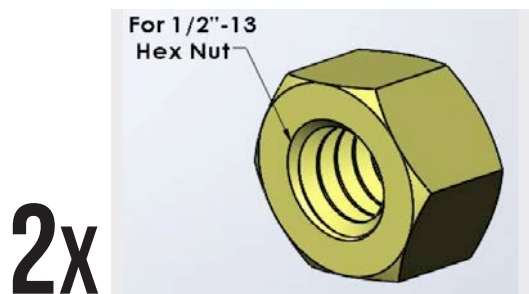
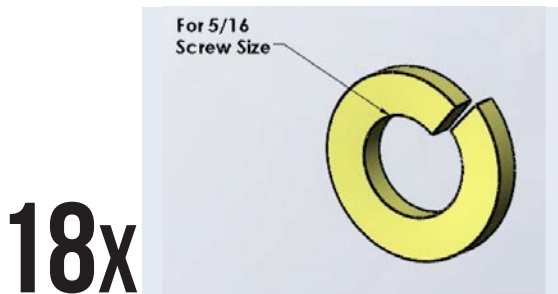
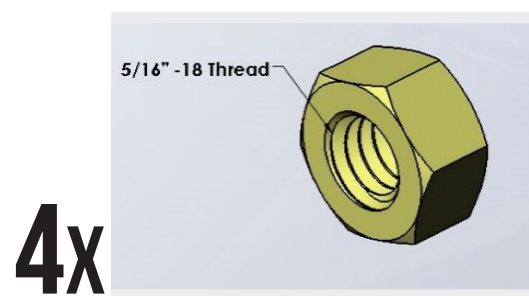
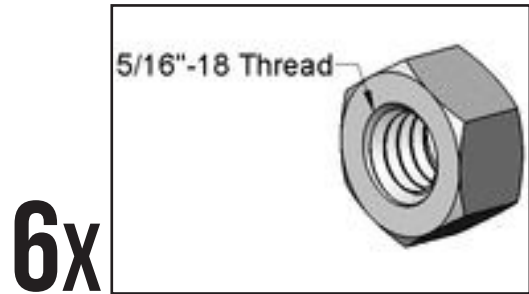



**INSTALLATION INSTRUCTIONS**  
**OPEN FENDER SYSTEM**  
Product Number: TF41XX  
Application: 2017 FORD F250/350

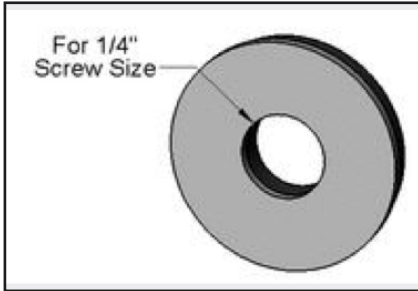

**10x**

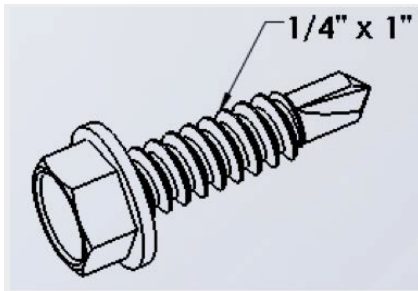

**10x**



**1x**

**[ TF4120 HW-KIT ]**

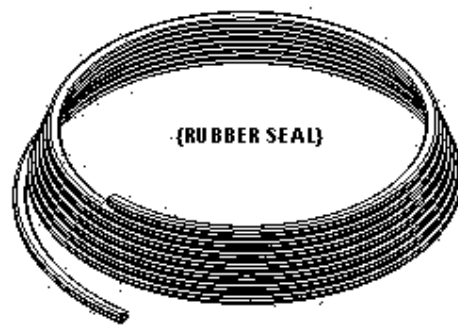

READY-LIFT KIT  
QTY: 1

TEMPLATE TF41XX  
QTY: 1

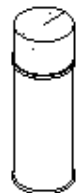

FOAM SEALANT  
QTY: 1

# [ TF4110 OPEN FENDER FLARE ]

DS: 21293-W  
QTY: 1

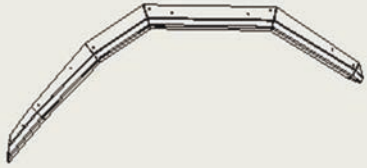

PS: 21294-W  
QTY: 1

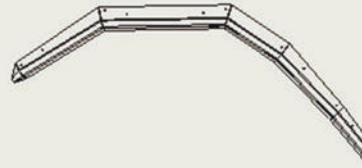

DS: 21299-W  
QTY: 1

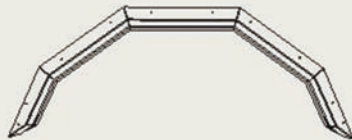

PS: 21300-W  
QTY: 1

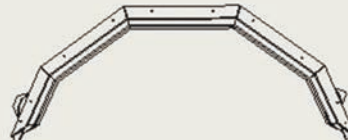

## TF4110 HW-KIT

Fully lay out and account for all hardware and accessories.

20x

For 5/16  
Screw Size

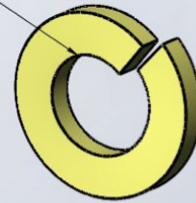

20x

5/16" x 1"

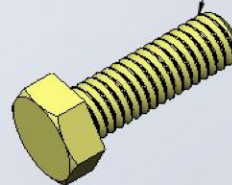

20x

For 5/16"  
Screw Size

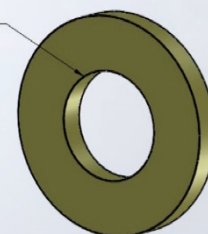



# INSTALLATION INSTRUCTIONS

## OPEN FENDER SYSTEM

Product Number: TF41XX

Application: 2017 FORD

F250/350

# [ TF4120 OPEN FENDER INNER ]

**DS: 21318-W**

QTY: 1

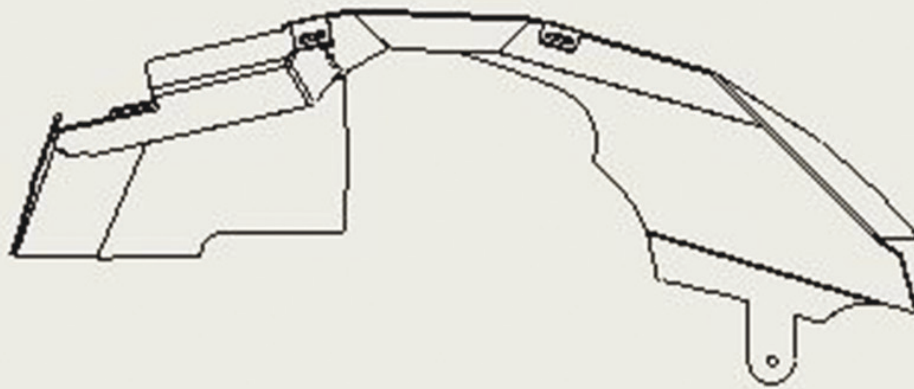

**PS: 21319-01**

QTY: 1



# [ TF4120 OPEN FENDER TEMPLATES ]

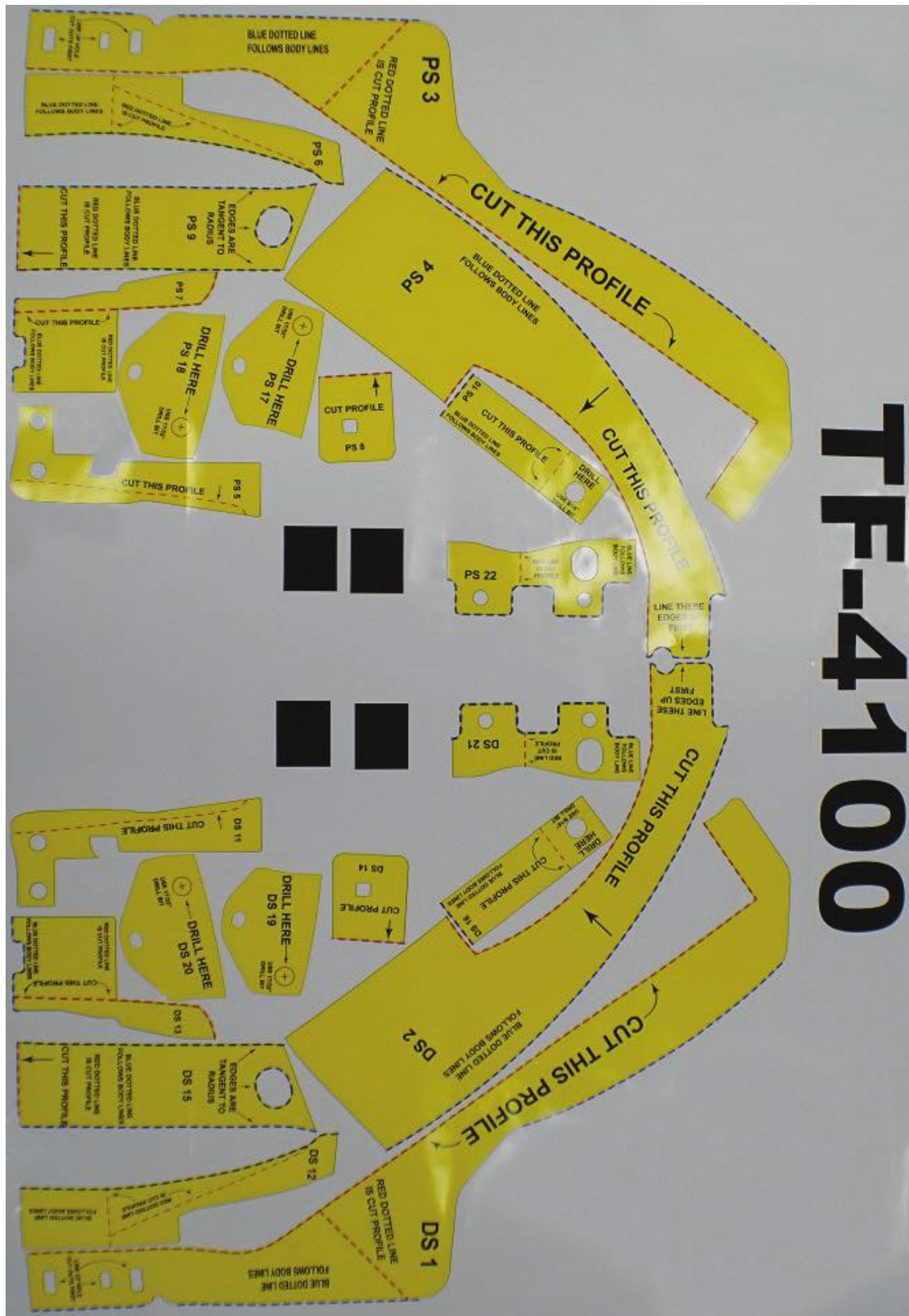



# INSTALLATION INSTRUCTIONS OPEN FENDER SYSTEM

Product Number: TF41XX

Application: 2017 FORD F250/350

Using pads or other protective surface, lay out all the parts provided by Fab Fours. Failure to fully account for all components before beginning installation may leave vehicle immobile until part is acquired. Refer to following list.

## TOOLS REQUIRED:

- Chalk line
- Socket wrench with extension (ratcheting wrenches may also be convenient)
- Full set of sockets metric and standard
- Full set of wrenches and ratchet wrenches
- Flat and Phillips head screw drivers
- Electric Drill with drill bit set up to ½"
- Plastic Fastener Remover
- Reciprocating saw
- Cutting wheel
- Grinding wheel
- Tin snips
- T15 torx
- Hex key sets
- Step bit

## ORGANIZATION:

Keeping your surroundings both clean and organized is paramount. Disassemble the vehicle where you can catalog and store everything. One good example is labeling and bagging all the OEM bolts when removing the front clip of the vehicle. Failure to keep track of parts could lead to an inability to properly reinstall components.

## TEMPLATES:

Blue dotted lines follow body lines of truck. Red dotted lines indicate cut lines. Drawn holes with center mark indicate drill locations. Holes and slots cut in template indicate locating features that must be matched.

## EASE OF ACCESS:

Removing the tires and raising the vehicle is recommended at this time. We recommend the use of an appropriately rated lift when installing.

# CHAPTER 2

## DISASSEMBLY & PREPARATION

1

Grille Removal: Remove radiator cover.

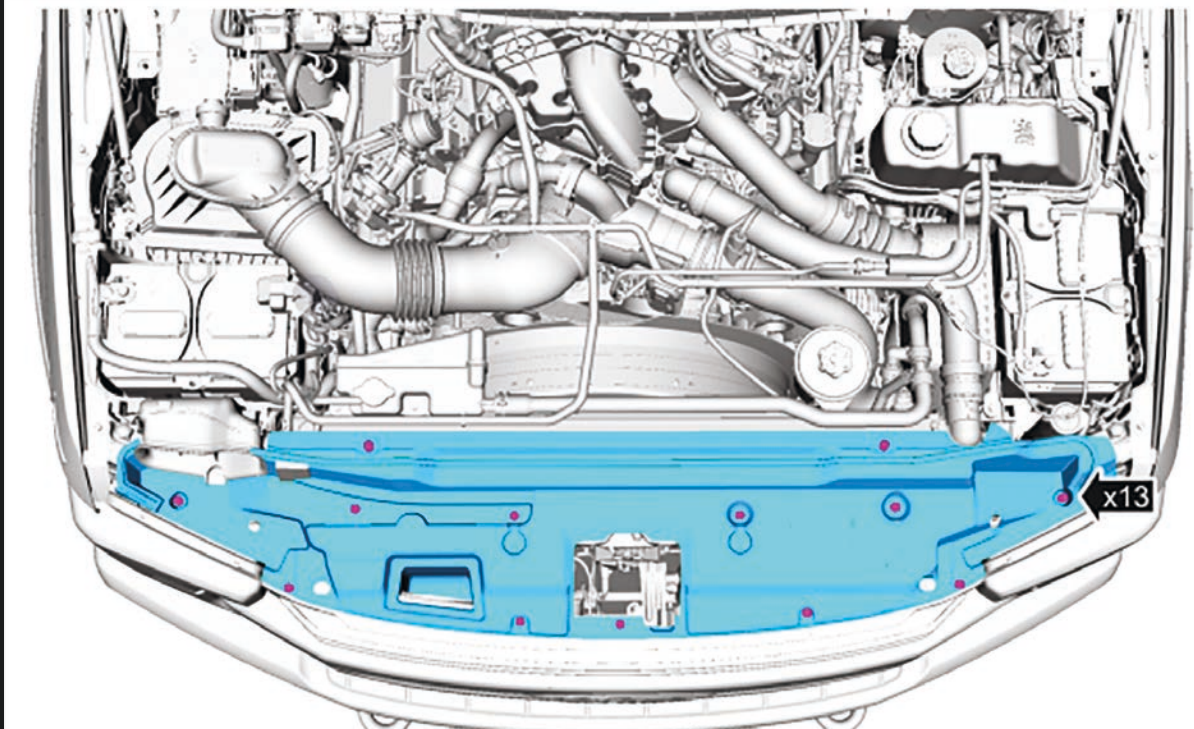

Using a plastic fastener remover, remove the 13 push pins from the radiator cover and 1 pin from the intake, then lift radiator cover from engine compartment.

# INSTALLATION INSTRUCTIONS

## OPEN FENDER SYSTEM

Product Number: TF41XX

Application: 2017 FORD

F250/350

2

Remove grille bolts.

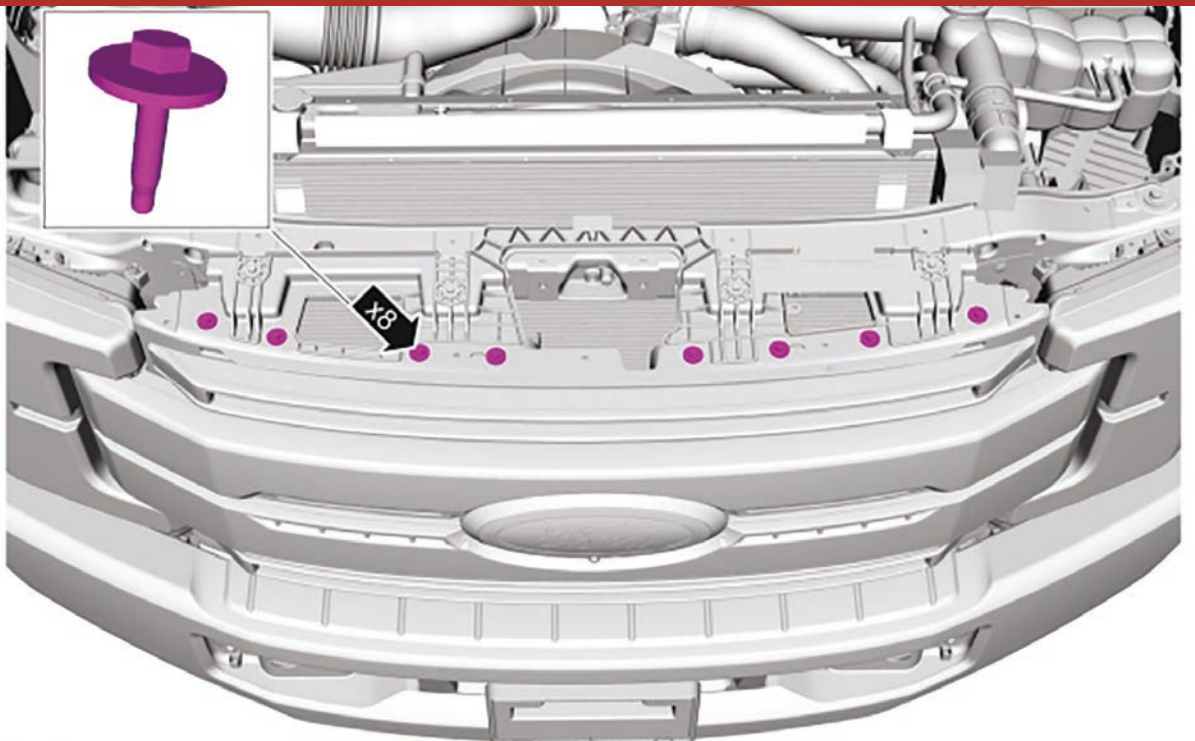

Using a 10mm socket remove the 8 bolts indicated in the image above.



# CHAPTER 2

## DISASSEMBLY & PREPARATION

### 3

### Pulling grille away.

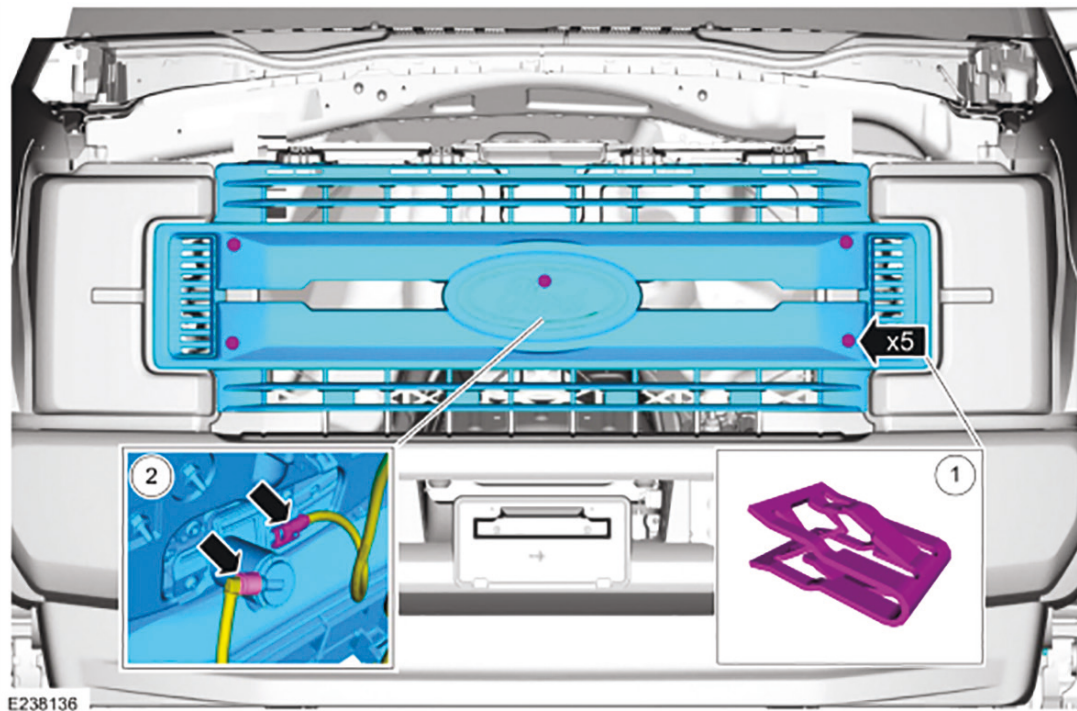
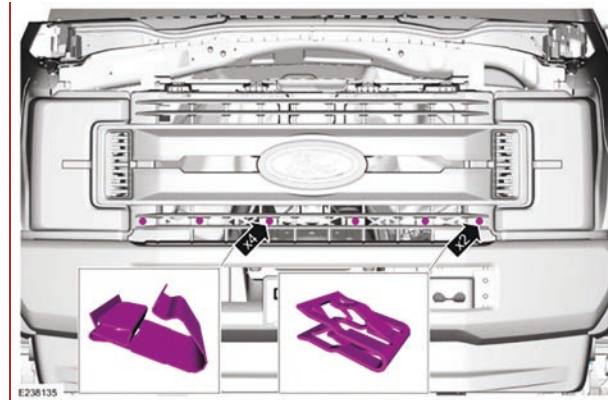
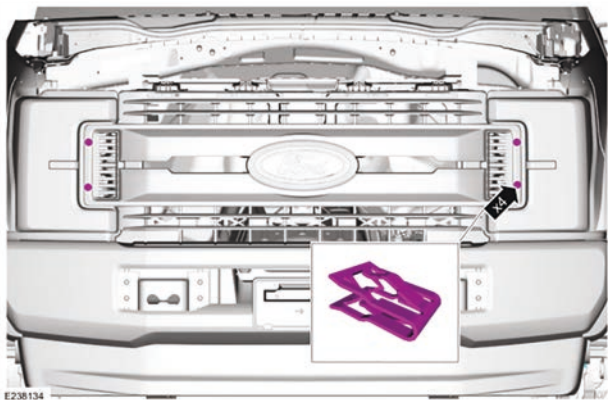

There are numerous locating clips holding the grille to the vehicle. Referring to the images above, slowly and firmly pull away the grille near the pink spotted locations. If you have the option for the 360 camera, disconnect the camera washer hose and the electrical connector (i.e. sub image 2) before pulling grille away from vehicle.

**INSTALLATION INSTRUCTIONS**  
**OPEN FENDER SYSTEM**  
Product Number: TF41XX  
Application: 2017 FORD  
F250/350

**1**

**Removing filler pans and harness.**

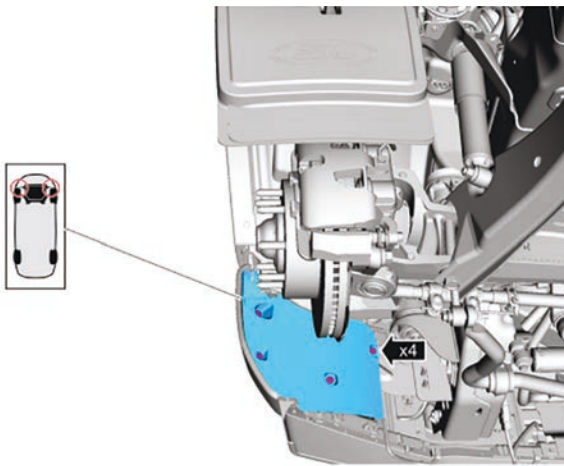

7491

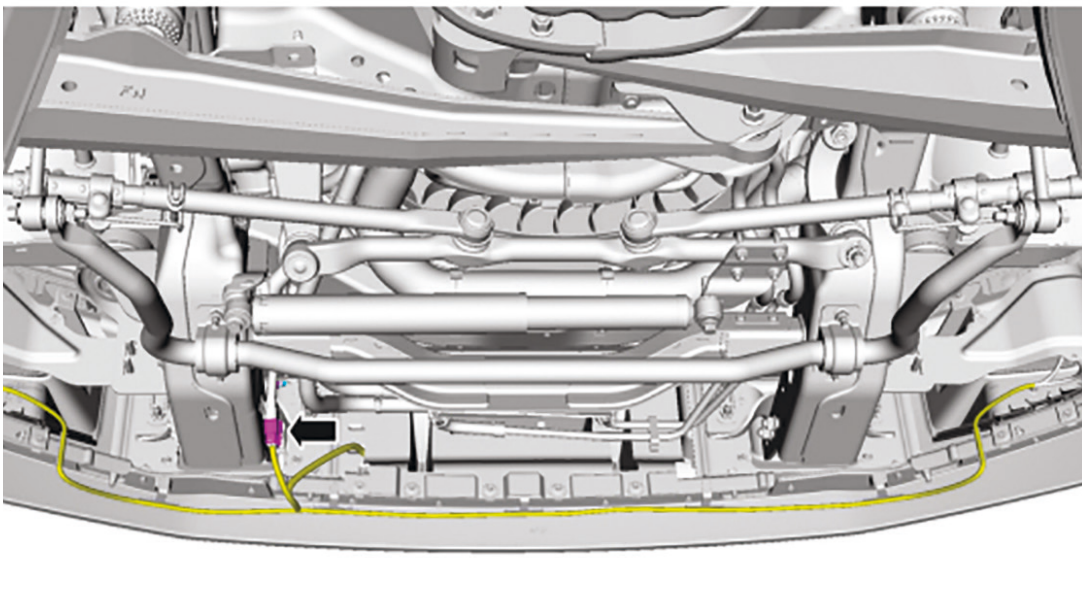
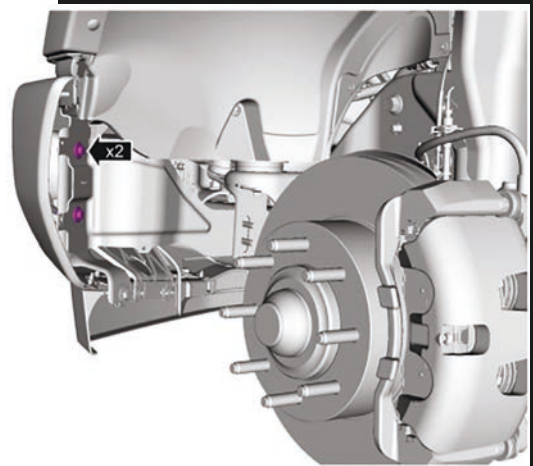

Using a 5.5mm socket remove and the plastic fastener remover, remove the 2 bolts and 2 Christmas tree pins holding the filler plates from both sides of the vehicle. Using a 15mm socket disconnect the 2 extension bolts from both sides of the vehicle. Finally, disconnect the electrical harness at the indicated location above.

# CHAPTER 2

## DISASSEMBLY & PREPARATION

2

### Removing Bumper



With the help of others, and using an 18mm socket, remove the 8 bolts holding the bumper to the vehicle. Pull bumper away from vehicle.



Optional: If block heater is equipped, unplug Block Heater electrical harness as bumper is pulled away.



## INSTALLATION INSTRUCTIONS

### OPEN FENDER SYSTEM

Product Number: TF41XX

Application: 2017 FORD

F250/350

3

## Removing tow hooks.

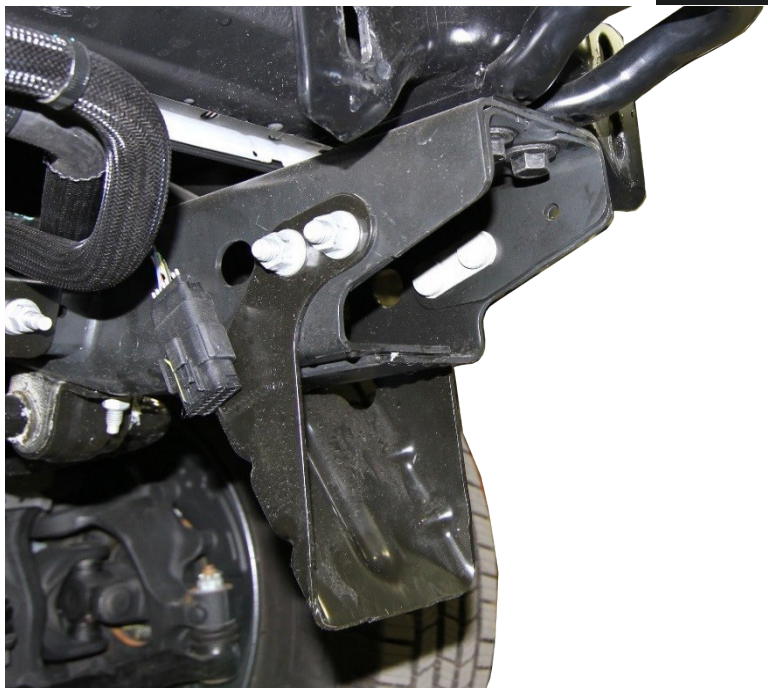
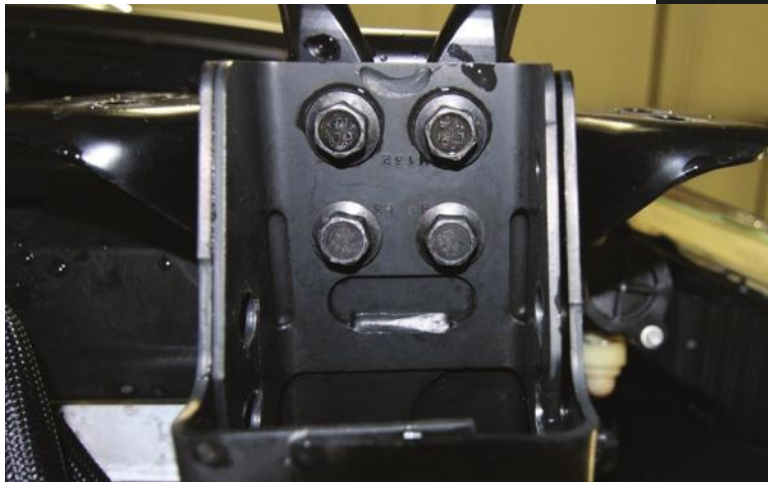

With the bumper off the vehicle, you can now remove the tow hooks by removing the four 18mm bolts located under the top of frame rail. Next, using 18mm socket remove the two nuts on either side of the frame attaching frame horns to frame. Set bolt strips and nuts aside as they will be used in the installation of Fab Fours bumper. Repeat on other side of vehicle.

# CHAPTER 2

## DISASSEMBLY & PREPARATION

1

### Removing corner molding and mud flaps.

NOTE: The following steps are to be executed on both sides of the vehicle.

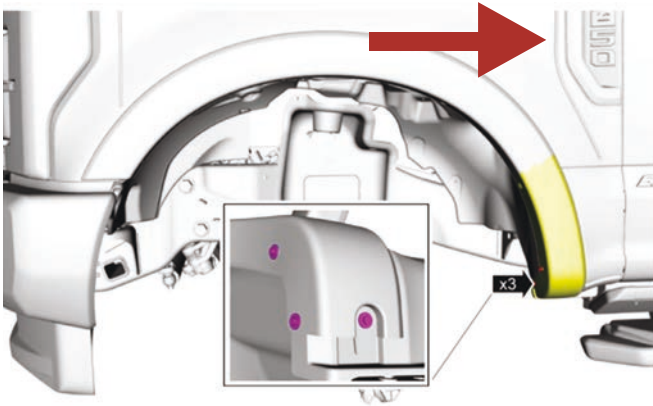

238149

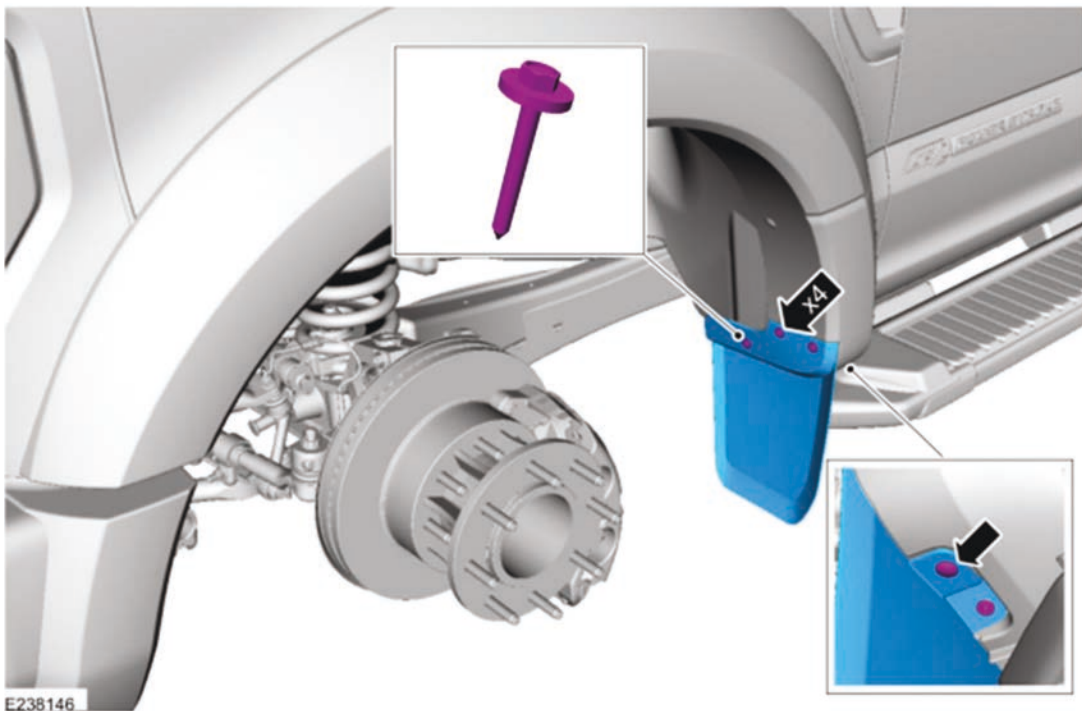
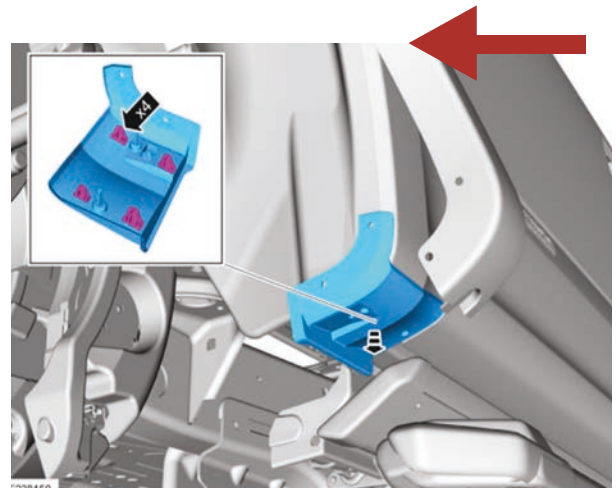

E238146

## INSTALLATION INSTRUCTIONS

### OPEN FENDER SYSTEM

Product Number: TF41XX

Application: 2017 FORD

F250/350

# 2

## Removing trim (optional)

Using a 5.5mm socket remove the 3 retaining screws securing the lower corner of the trim and pry back to give clearance to corner molding. There are 4 clips securing the corner molding, pull firmly to remove. If mud flap equipped, use plastic pin remover to remove the 4 pins and a 5.5mm socket to for the screw.

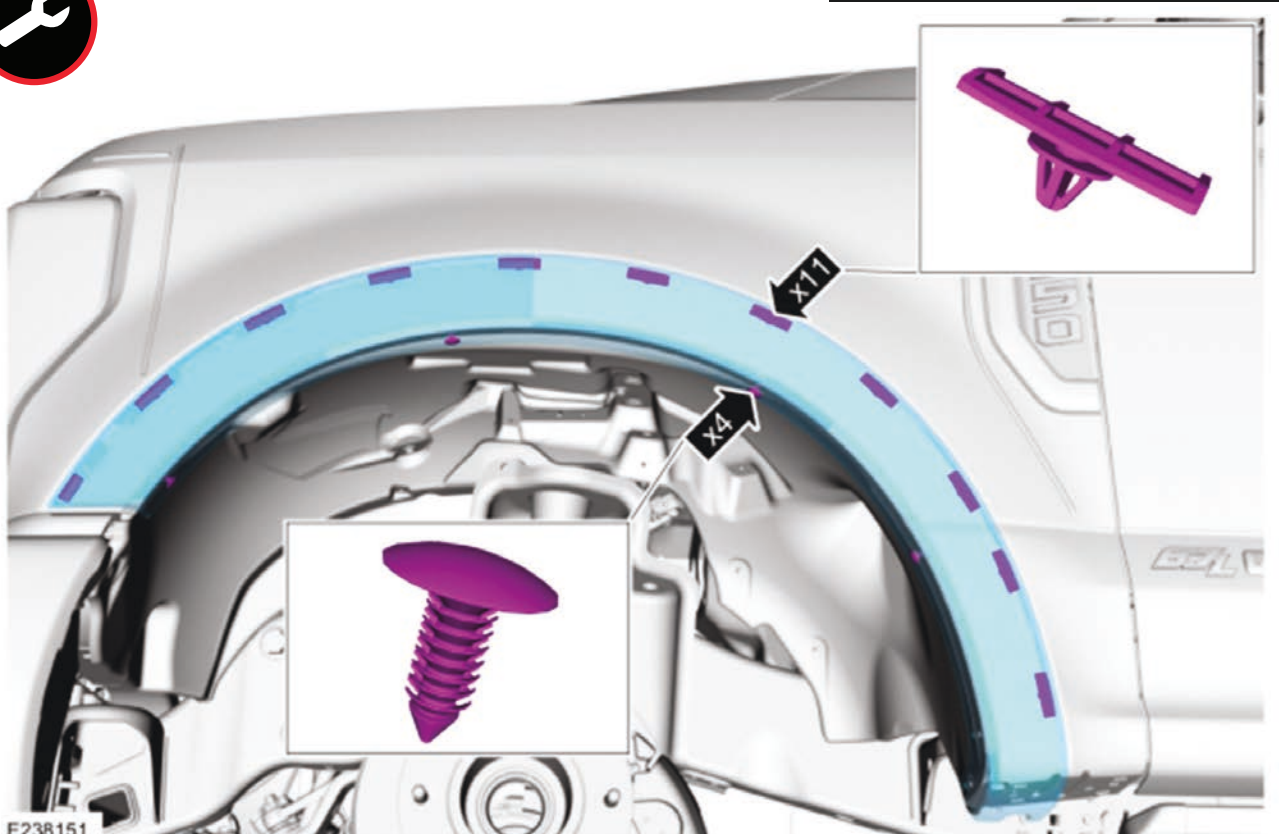

Using a plastic pin remover and a non-marring trim tool, remove the 4 pin and disengage the 11 retainers from fender.



# CHAPTER 2

## DISASSEMBLY & PREPARATION

### 3

### Removing inner fender/liner screws and pins (Part 1)

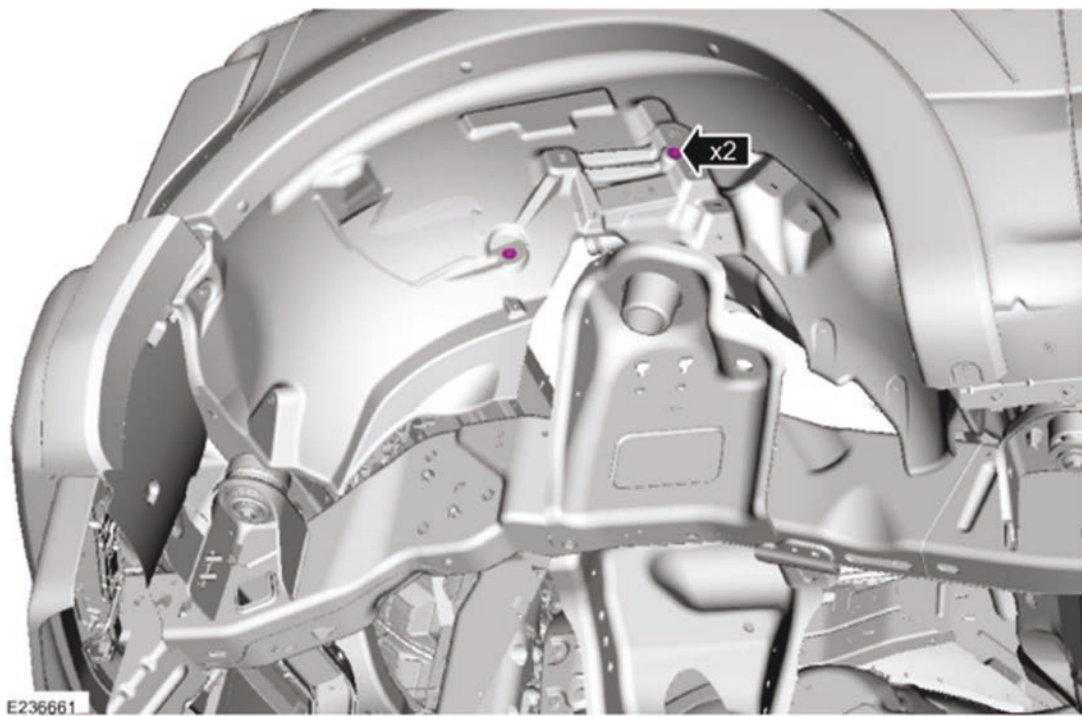
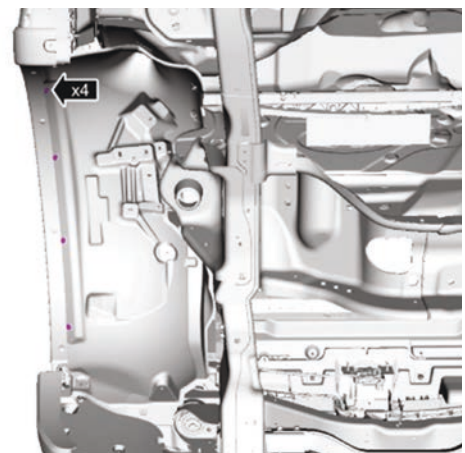
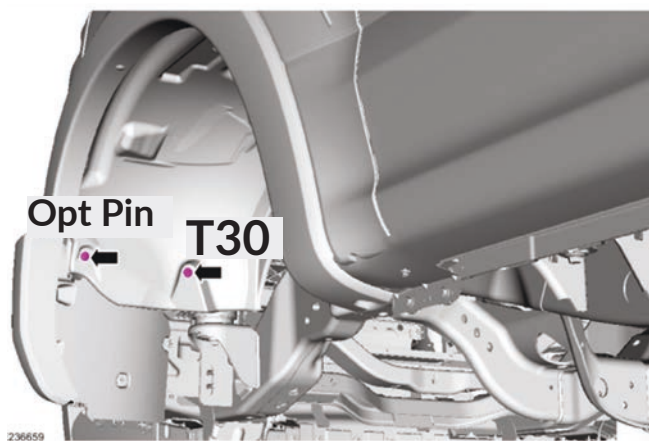

Using a plastic pin remover, T30 torx head and an 8mm socket, remove all the clips and screw indicated in the images above. If you do not see retainers for wiring harness in step 4 pull away liner from vehicle.

## INSTALLATION INSTRUCTIONS

### OPEN FENDER SYSTEM

Product Number: TF41XX

Application: 2017 FORD

F250/350

4

## Removing inner fender retainers (Part 2)

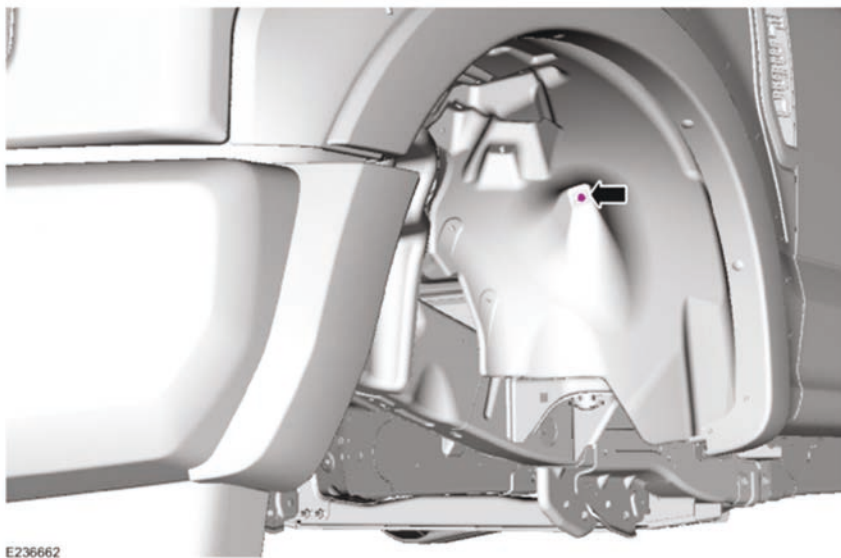

Remove single screw in middle rear of inner fender.

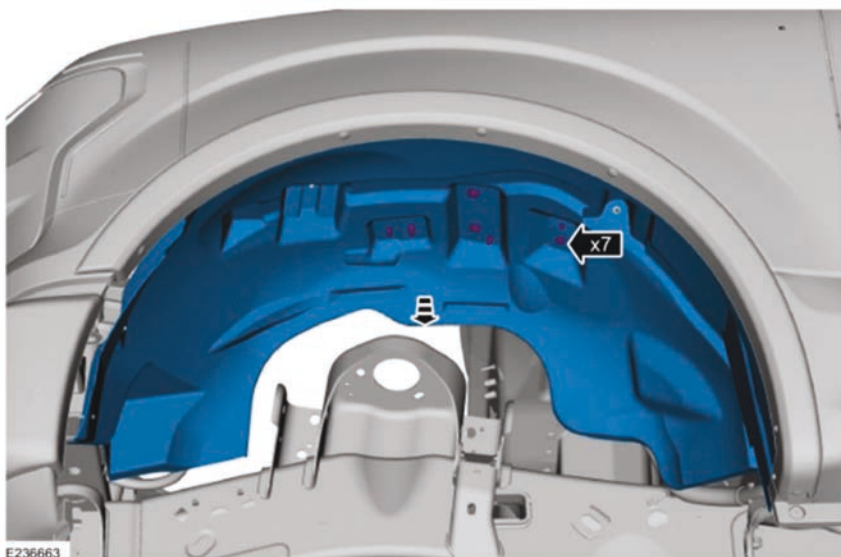

Disengage the 7 retainers for the wiring harness at top of inner fender and pull away from vehicle.

# CHAPTER 2

## DISASSEMBLY & PREPARATION

1

### Headlight Removal: Removing bolts.

NOTE: The following steps are to be executed on both sides of the vehicle.

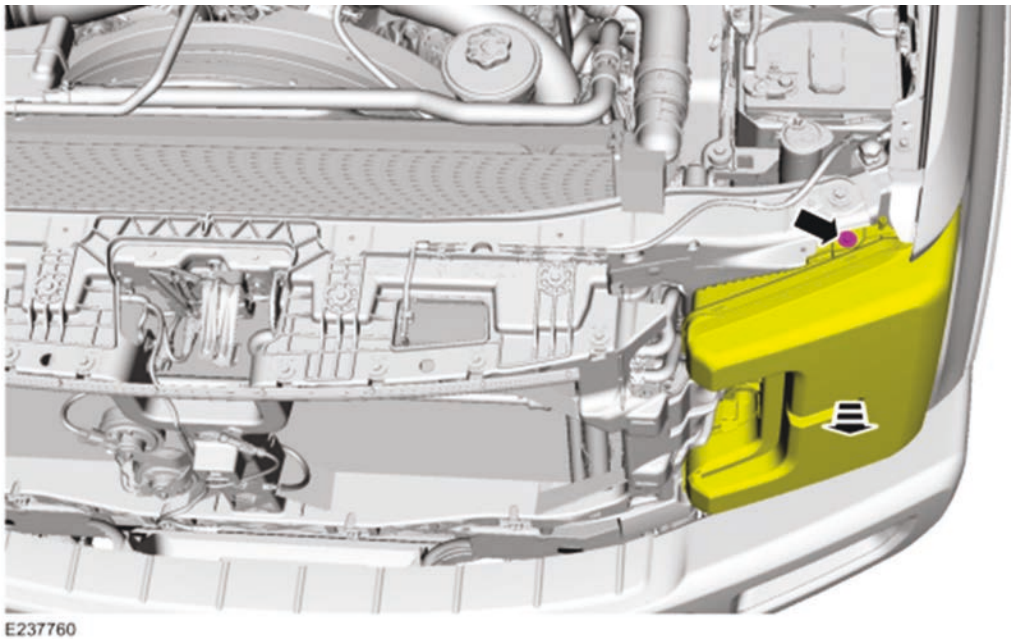
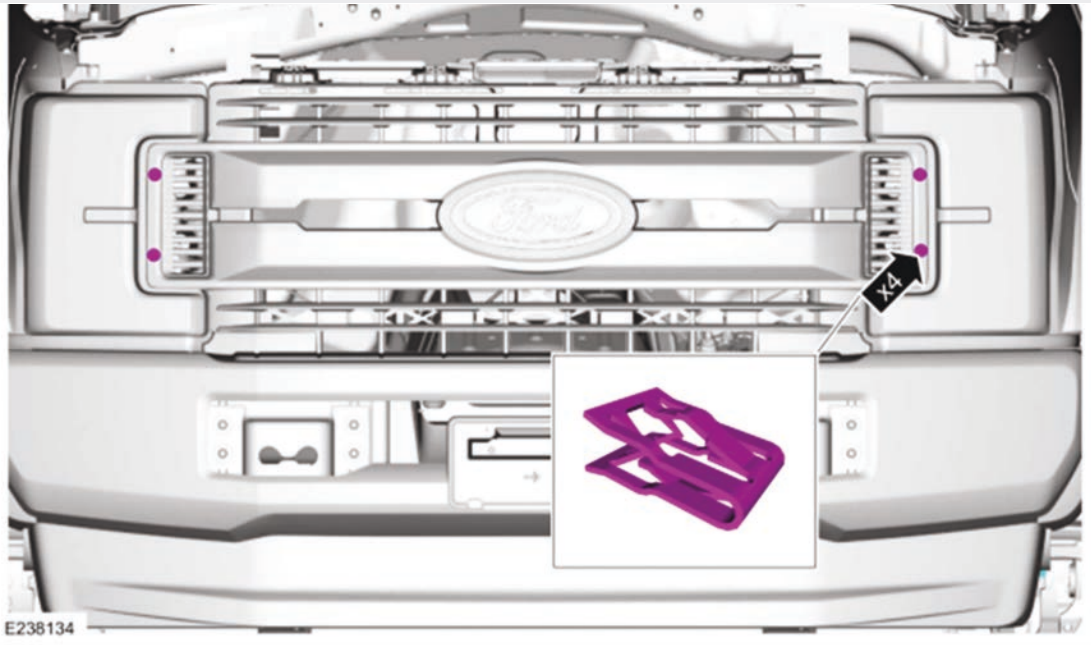

Using a 10mm socket remove the 4 retaining bolts securing the inner corner, bottom outer corner, and top of headlight where indicated in the images above. Slowly pull away headlight from vehicle until electrical connector can be seen.



# INSTALLATION INSTRUCTIONS

## OPEN FENDER SYSTEM

Product Number: TF41XX

Application: 2017 FORD

F250/350

# 2

## Unplugging Headlights (Part 2)



For LED headlight assemblies, disconnect electrical connector as seen in image.

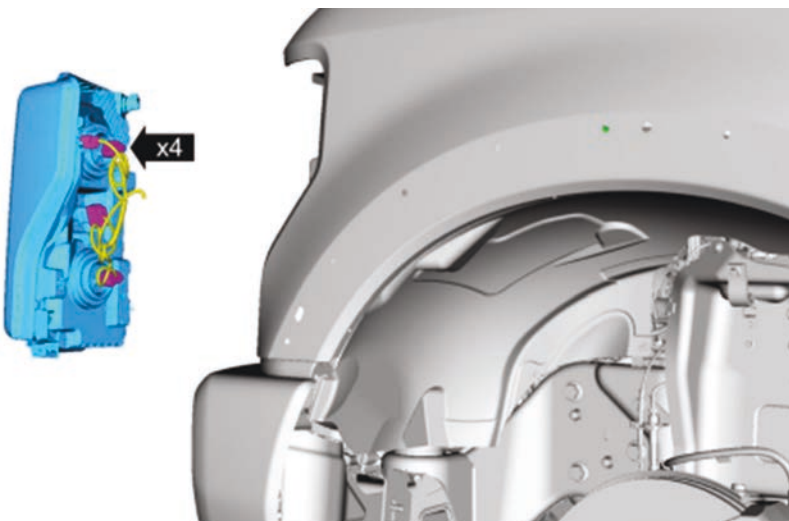

For Halogen headlight assemblies, disconnect electrical connector as seen in image.

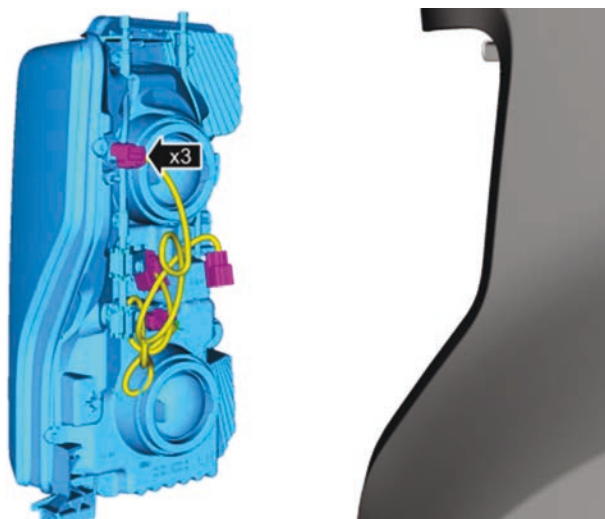

For vehicles with Day-time Running Lights, disconnect electrical connector as seen in image beside

You are now free to pull headlights fully away from vehicles.

# CHAPTER 2

## DISASSEMBLY & PREPARATION

# 1

### Front Fender Removal: Removing insulation and bolts.

NOTE: The following steps are to be executed on both sides of the vehicle.

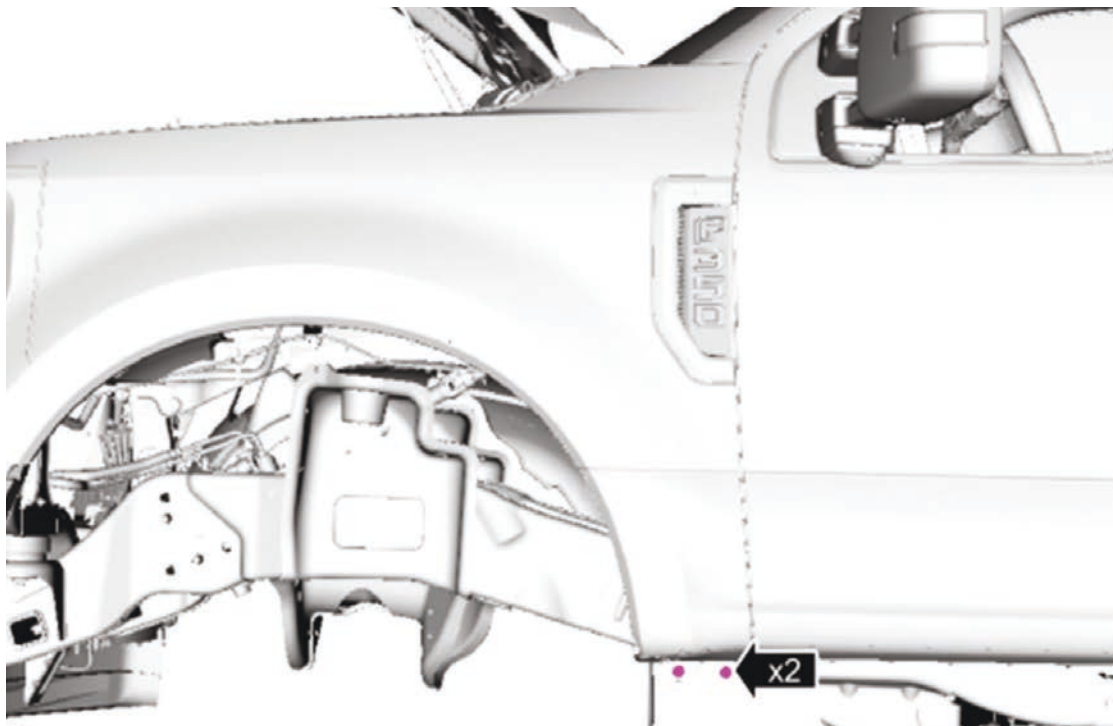
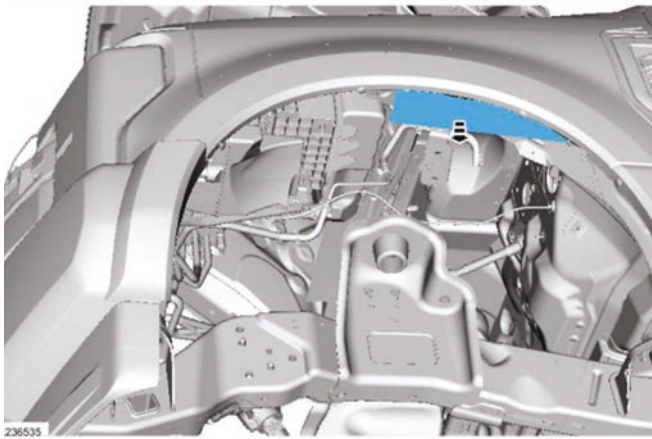

Using a 10mm socket remove the 4 retaining bolts securing the inner corner, First locate the fender insulator on the inside of the wheel well and slowly pull away from vehicle. Using a 10mm socket remove the first 3 bolts securing the fender to the cab.

# INSTALLATION INSTRUCTIONS

## OPEN FENDER SYSTEM

Product Number: TF41XX

Application: 2017 FORD

F250/350

2

### Unbolting (Part 1)

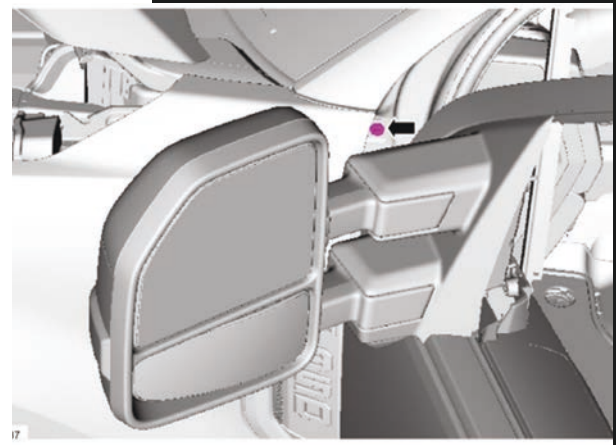
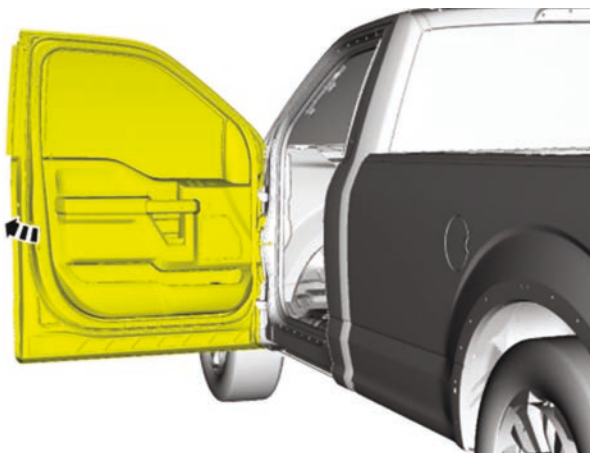

Open the door to gain access to the bolt located in the door jamb toward the top of the fender. Using a 7mm socket remove the bolt. The bolt may have been powdered over making it difficult to grip with the aforementioned socket. Once the bolt is removed close the door.



# CHAPTER 2

## DISASSEMBLY & PREPARATION

3

### Unbolting (Part 2)

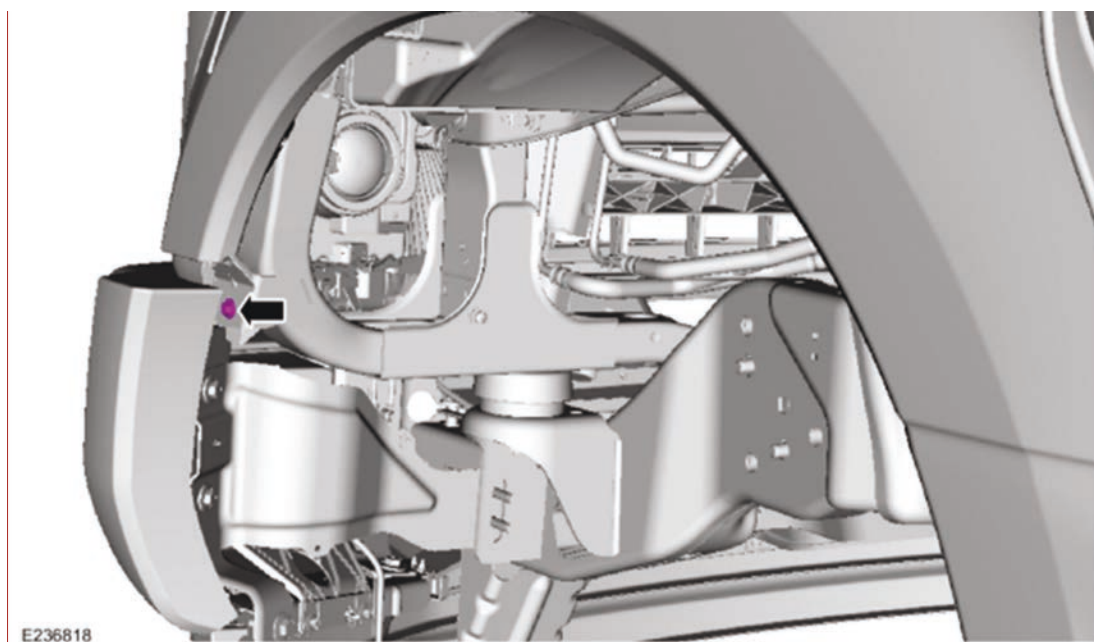
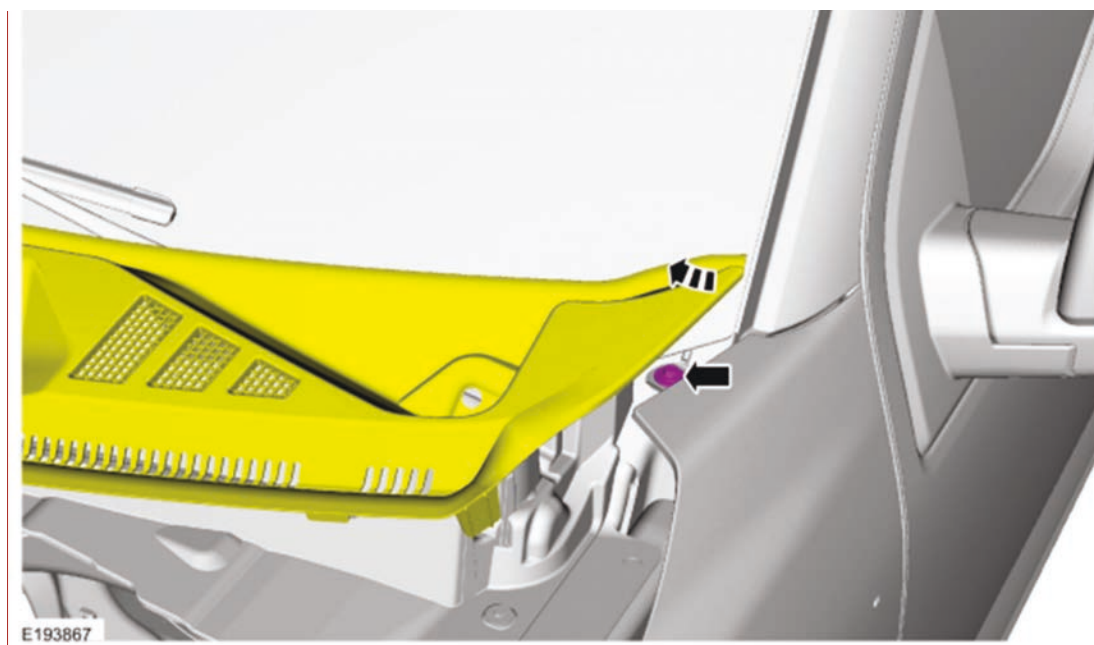

Raise the corner of the cowl to access the bolt underneath, then using a 10mm socket remove bolt. Now, locating the bolt at the front lower mount of the fender use a 10mm socket to remove.



# INSTALLATION INSTRUCTIONS

## OPEN FENDER SYSTEM

Product Number: TF41XX

Application: 2017 FORD

F250/350

4

### Unbolting (Part 3)

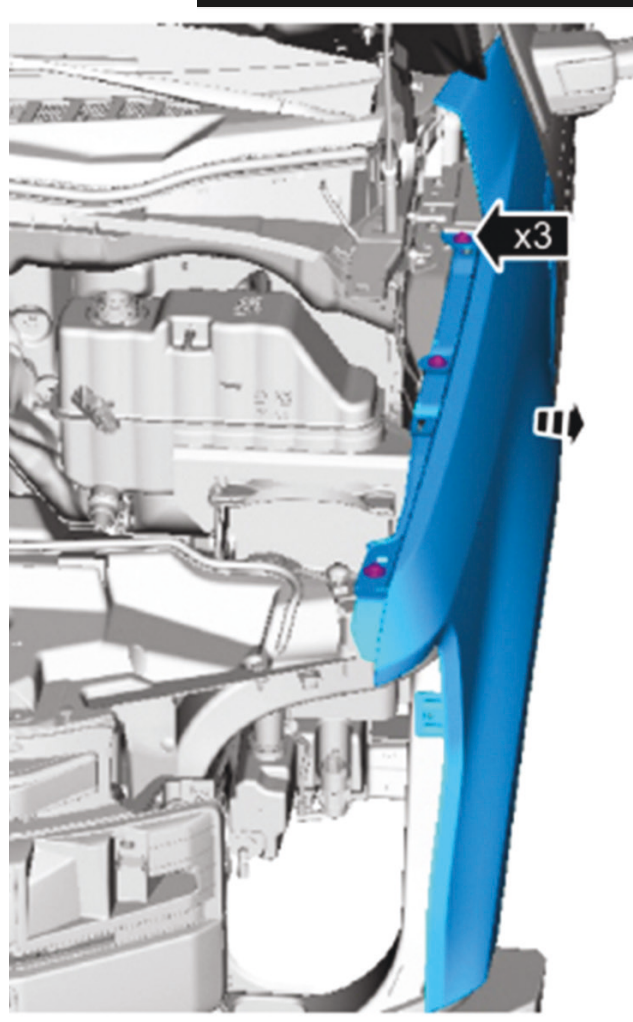
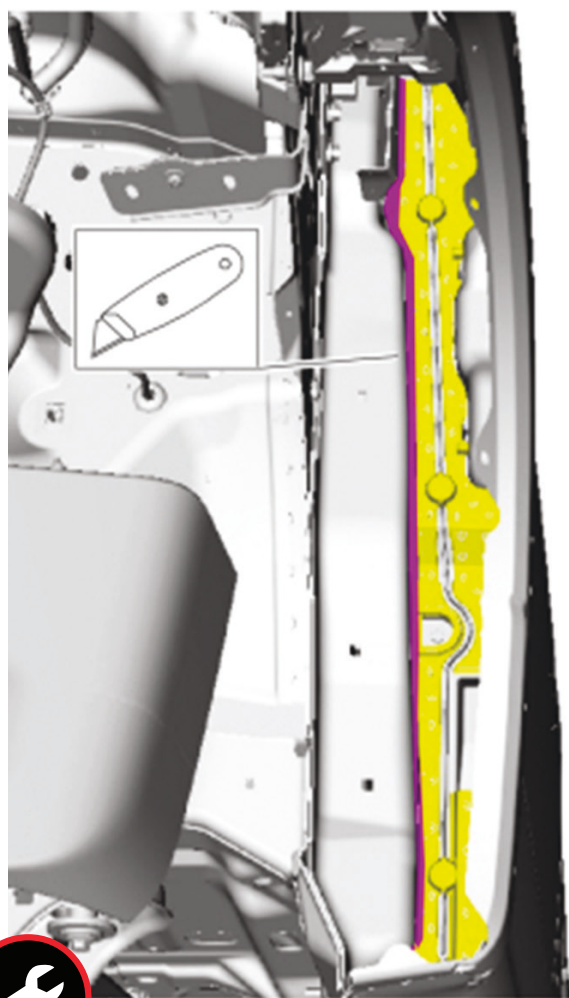

Using a box cutter or its equivalent, cut away the foam baffle along the body. Locate the 3 bolts at the top of the fender toward the engine bay and using a 10mm socket remove them. With the help of another you can now pull the fender away from the vehicle.

# CHAPTER 2

## DISASSEMBLY & PREPARATION

5

Rear quarter panel molding & inner fender liner



Using a plastic pin remover remove the 5 pins holding the molding to the rear quarter panel. Take care not to damage the pins when removing and pull panel away slowly so as not to damage the clips built into the molding.

## INSTALLATION INSTRUCTIONS

### OPEN FENDER SYSTEM

Product Number: TF41XX

Application: 2017 FORD

F250/350



Using a plastic pin remover and a 7mm socket remove the 3 bolts and 3 pins holding the inner and pull the inner lining away. There will be a bolt and pin combination on the front, back, and inner faces of the wheel well liner.



# CHAPTER 3

## TEMPLATE MOUNTING

Note: All surfaces should be cleaned before installing templates.



VIDEO: CH3 SEC-1

1

### Installing fender templates.



Cut template 1 will be aligned with the holes on the bottom of the fender and the outside contour of the fender. These two areas are indicated by the red ovals in the images around the box.

Cut template 1 is the driver side template and a mirror of Cut template 3.





# INSTALLATION INSTRUCTIONS

## OPEN FENDER SYSTEM

Product Number: TF41XX

Application: 2017 FORD  
F250/350



Start by installing cut template 2 on the front bottom edge of the fender of the vehicle. Cut template 2 will be installed by aligning the bottom edge profile with the matching sheet metal of the fender indicated by the red oval. When placing the template, make certain the template is aligned with the contour of the fender, ref purple crescent. Cut template 4 is a mirror of cut template 2



Cut template 20 is mounted by aligning slot and contours at the bottom of the template on the front driver side fender, ref the red rectangle. Cut template 18 is the mirror of above.

# CHAPTER 3

## TEMPLATE MOUNTING

1

### Installing fender templates cont...

Cut template 19 is mounted by aligning slot and contours at the bottom of the template on the front driver side fender, ref the red rectangle. Cut template 17 is the mirror of above

Complete template view of Driver side Template



# INSTALLATION INSTRUCTIONS

## OPEN FENDER SYSTEM

Product Number: TF41XX

Application: 2017 FORD

F250/350



Cut template 4 is the passenger side template and a mirror of the driver side. Repeat steps for Cut template 2



Cut template 3 is the passenger side template and a mirror of the driver side. Repeat steps for Cut template 1.



# CHAPTER 3

## TEMPLATE MOUNTING



Cut template 18 and 17 are the passenger side templates and a mirror of Cut templates 19 & 20.

**2**

**Installing side cab templates**



**VIDEO: CH3 SEC-2**



Cut template 14 will be aligned with the square cut in rocker panel, indicated by the red oval. This is the second square from the bottom of rocker panel and you may need to remove a black plug to see it. The first square maybe covered by tape.

# CHAPTER 3

## TEMPLATE MOUNTING



VIDEO: CH3 SEC-2

2

Installing side cab templates cont...



Bottom of cut template 11 will be aligned with the two bolts in side of rocker panels, under door hinges, refer to red square.



Top of cut template 11 will be aligned with the cut profile of cut 14, refer to purple square.



# INSTALLATION INSTRUCTIONS

## OPEN FENDER SYSTEM

Product Number: TF41XX

Application: 2017 FORD

F250/350

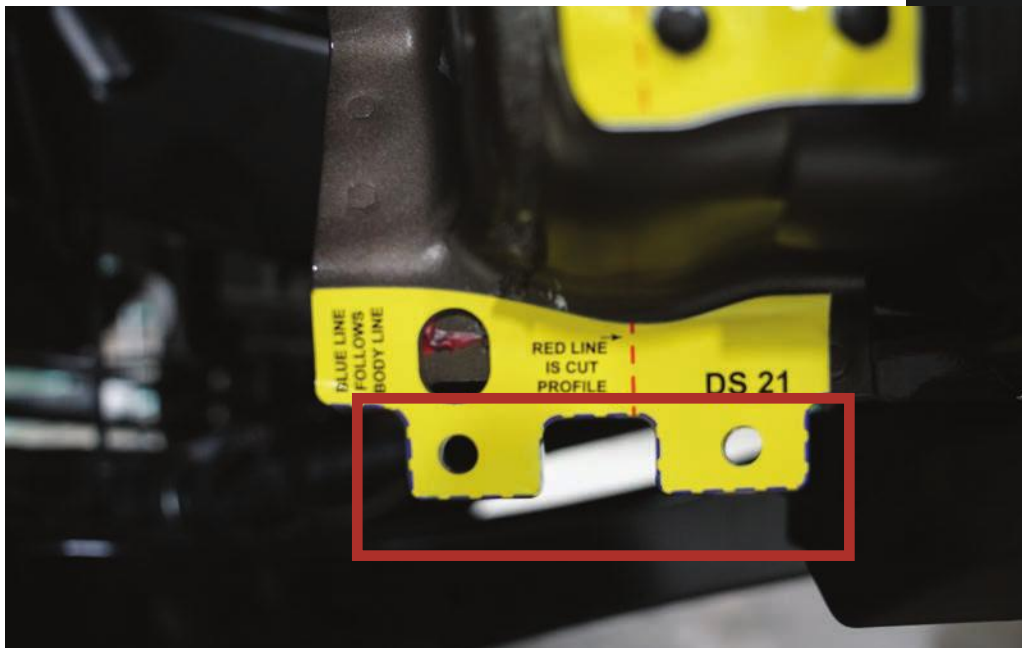

Bottom of cut template 21 on the driver side of the vehicle and the cut template 22 on the passenger side will be aligned with the profile of the bottom of the rocker panel indicated by the red squares.

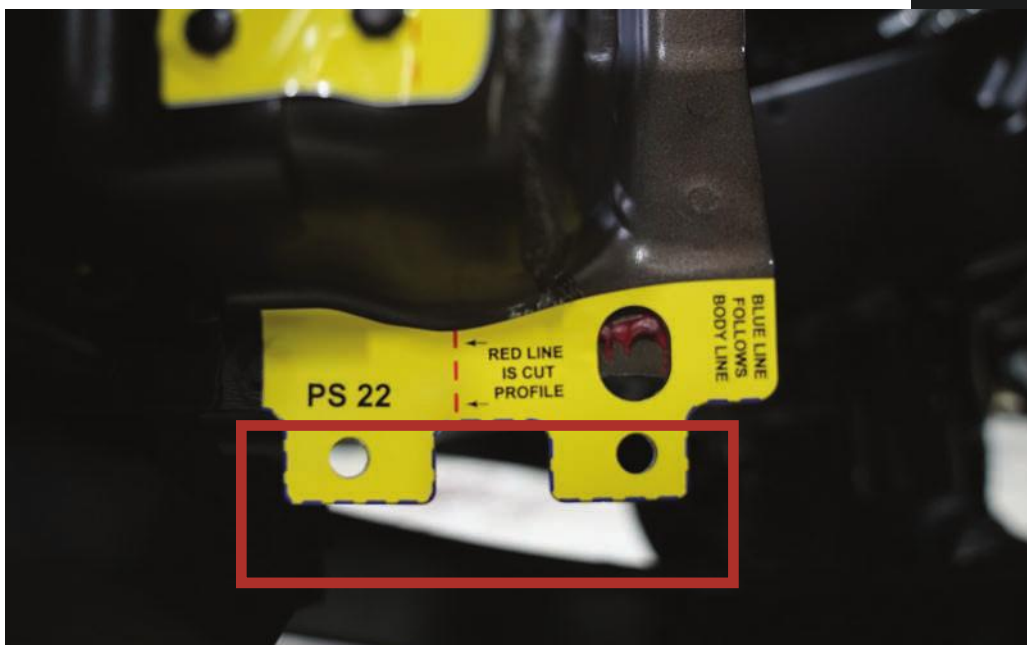

# CHAPTER 3

## TEMPLATE MOUNTING



Bottom of cut template 13 on the driver side of the vehicle and the cut template 7 on the passenger side will be aligned with the inside profile of the bottom of the rocker panel indicated by the red squares.

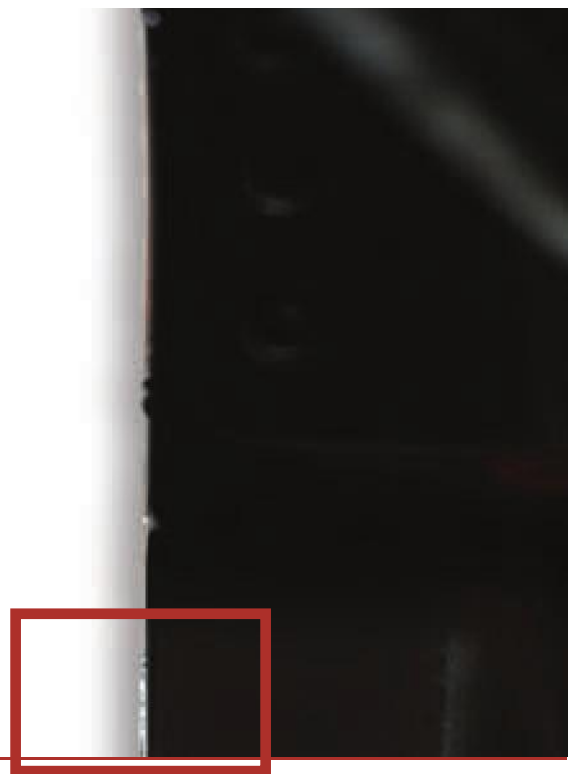

# INSTALLATION INSTRUCTIONS

## OPEN FENDER SYSTEM

Product Number: TF41XX

Application: 2017 FORD

F250/350

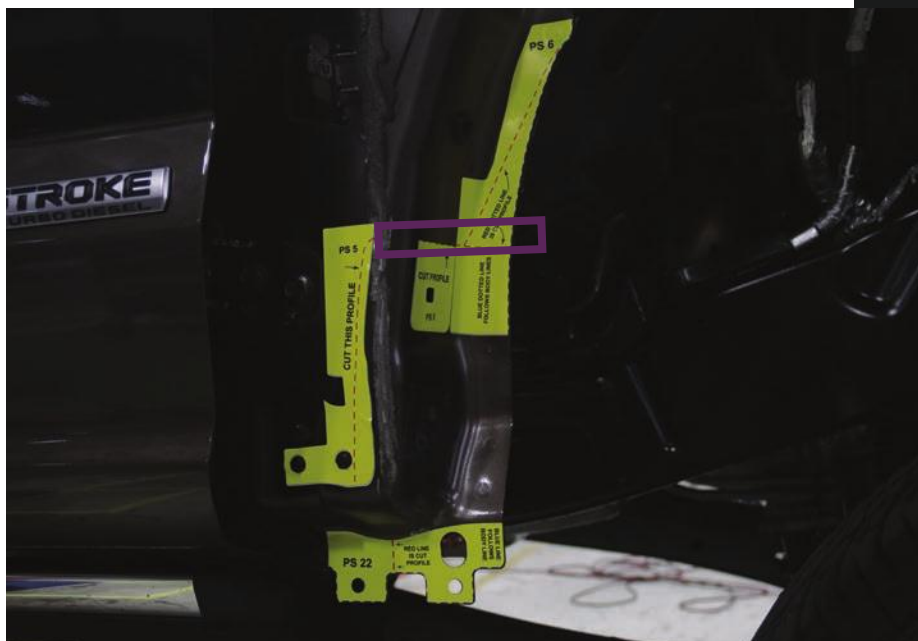

Start at the top of cut template 12 by matching the contour of the template to the vehicle indicated by red triangle. The red dashed lines of the cut profile should align with the cut template 14.

The red dashed lines for cut templates 12, 14, & 11 on the driver side and for Cut templates 6, 5, & 8 should all be in line with each other, this is indicated by the purple box in the surrounding images.

# CHAPTER 3

## TEMPLATE MOUNTING



VIDEO: CH3 SEC-3

3

### Installing reinforcement bar templates



Cut template 15 and 9 are installed by placing all edges on the flat of the tube where the different curves end. This is done by attempting to align the slot and lineup edges of the templates on both sides with the flat part of the tube, right before it starts to curve.





# INSTALLATION INSTRUCTIONS

## OPEN FENDER SYSTEM

Product Number: TF41XX

Application: 2017 FORD

F250/350



Cut template 16 & 10 is installed by lining the edge of the template up with the edge of the reinforcement and running the bottom of the template with the bottom of the reinforcement where the radius ends.

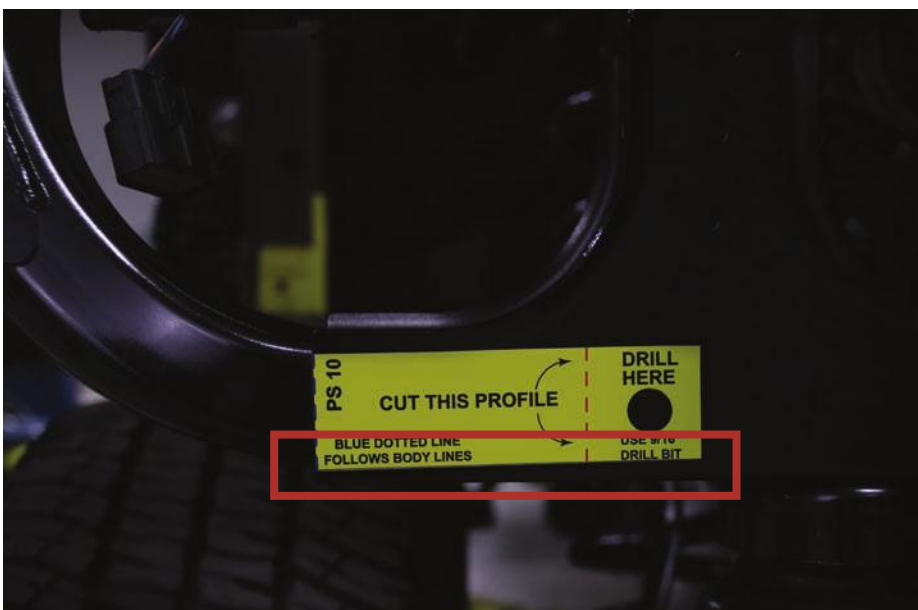

Make sure template is above lower radius.

# CHAPTER 4

## CUTTING

1

### Cutting front fenders



Using a body saw, start cutting the rear portion of fender along the inner most cut profile. Once complete come back and make the 90 degree cuts to meet the initial cut, indicate by the red boxes.



# INSTALLATION INSTRUCTIONS

## OPEN FENDER SYSTEM

Product Number: TF41XX

Application: 2017 FORD

F250/350



Using a body saw, flip the fender over and cut off the plastic mold along initial cut line.

# CHAPTER 4

## CUTTING

### Cutting front fenders cont...

Using a body saw, start cutting the fender at the bottom of the red crescent. Once complete, come back and make the 90 degree cuts to meet the initial cut, indicate by the red boxes and remove lower section of fender as shown beside.

Note: you may find it easier to follow the indicated contour using a cutoff wheel.

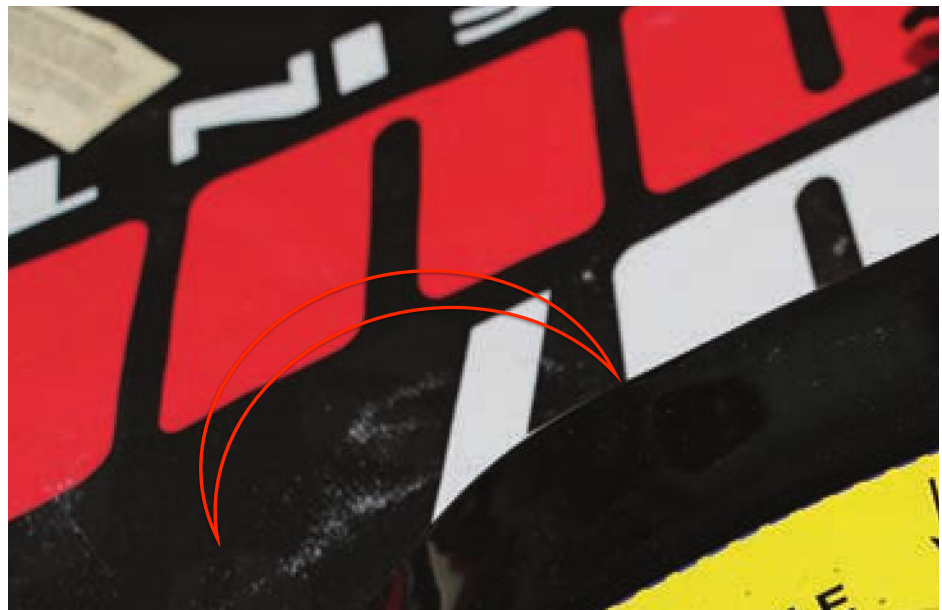



## INSTALLATION INSTRUCTIONS

### OPEN FENDER SYSTEM

Product Number: TF41XX

Application: 2017 FORD

F250/350



With cutting templates installed you can now drill. Using a center punch and 17/32 bit, mark and drill holes at the locations indicated by the templates.

# CHAPTER 4

## CUTTING



The last step in the front fender cut is to return to cut templates 3 & 1 and to cut off the bottom portion indicated by the red squares. This will remove the rear most bottom of the fender.

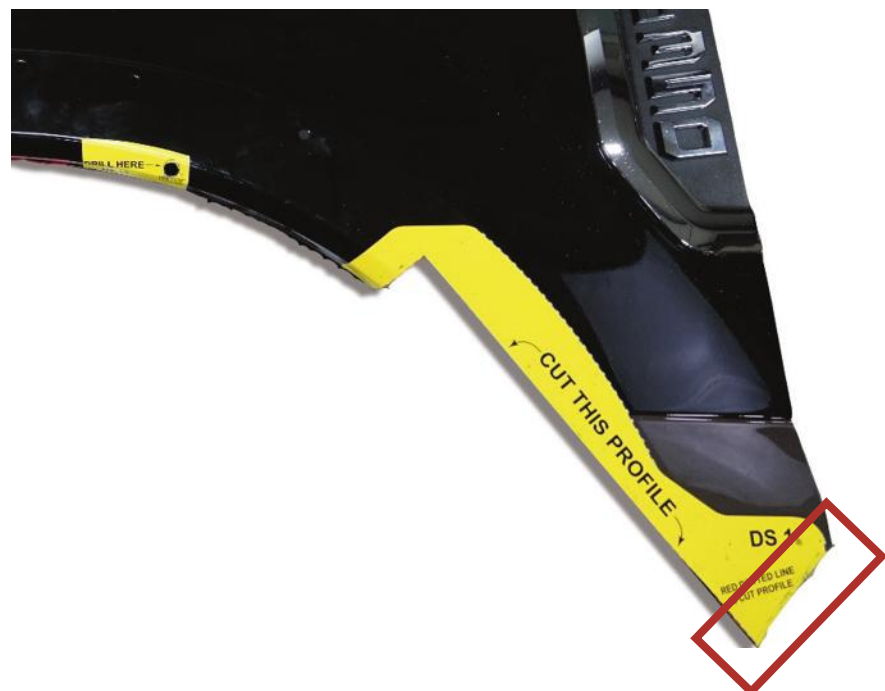

## INSTALLATION INSTRUCTIONS

### OPEN FENDER SYSTEM

Product Number: TF41XX

Application: 2017 FORD

F250/350

2

## Cutting reinforcement bar.



Note: When cutting always error on the side of taking less material away from vehicle.

Material can always be removed later for proper fitment.

Using a sawzall, cut the front of the reinforcement bar indicated in cut template 16. Next, cut through the top of the corner of the reinforcement bar indicated in cut template 15.



# CHAPTER 4

## CUTTING

### Cutting reinforcement bar cont...



Using a sawzall, cut the front of the reinforcement bar indicated in cut template 10. Next, cut through the top of the corner of the reinforcement bar indicated in cut template 9.





# INSTALLATION INSTRUCTIONS

## OPEN FENDER SYSTEM

Product Number: TF41XX

Application: 2017 FORD

F250/350



Driver side cuts are the mirror of cuts in image above.

# CHAPTER 4

## CUTTING

3

### Cutting cab



Using a sawzall cut through the radius of the flange indicated by the red square on above.

Note: when cutting always error on the side of taking less material away from vehicle. Material can always be removed later for proper fitment.

# INSTALLATION INSTRUCTIONS

## OPEN FENDER SYSTEM

Product Number: TF41XX

Application: 2017 FORD

F250/350



Next cut lower rocker channel away, starting from the bottom of the cut template 22 and up through cut template 5. This cut will pass complete through rocker panel not following cut template 7, refer to the image to the left.

Cut straight in, level with the cut indicated by cut template 5.

# CHAPTER 4

## CUTTING

### Cutting cab cont...



Take care when cutting template 6 cut line. Do not over cut and penetrate the firewall.





# INSTALLATION INSTRUCTIONS

## OPEN FENDER SYSTEM

Product Number: TF41XX

Application: 2017 FORD

F250/350

The procedures listed here should be repeated on both sides.



# CHAPTER 4

## CUTTING

4

Cutting driver and passenger side bed.



The rear fenders of the vehicle will be covered with painters tape along the contour shown beside. At this point the contour will be marked to indicate the cutting line.. Using a cutoff wheel, the indicated portion of the fender will be removed.

Note: The line should be drawn along the curve between the 3rd surface (flat) and the second small flange.

# INSTALLATION INSTRUCTIONS

## OPEN FENDER SYSTEM

Product Number: TF41XX

Application: 2017 FORD

F250/350



The procedures listed here should be repeated on both sides.

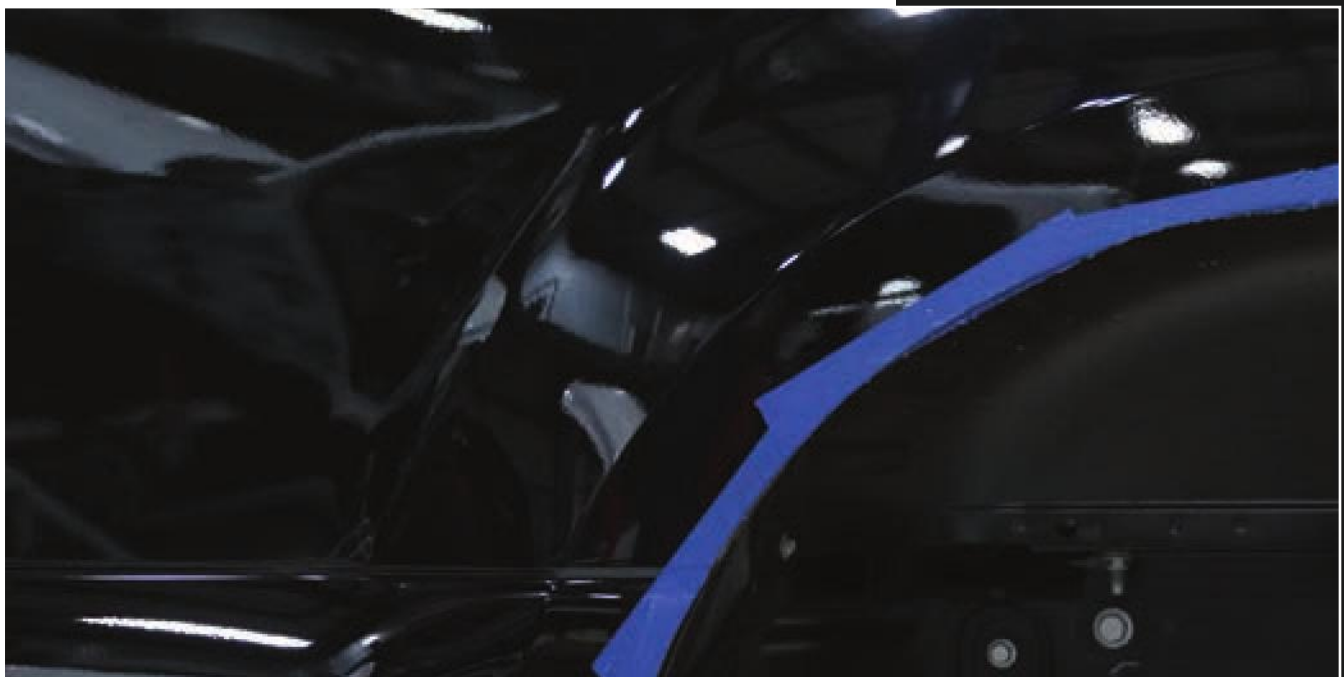

# CHAPTER 4

## CUTTING

### Cutting driver and passenger side bed cont..

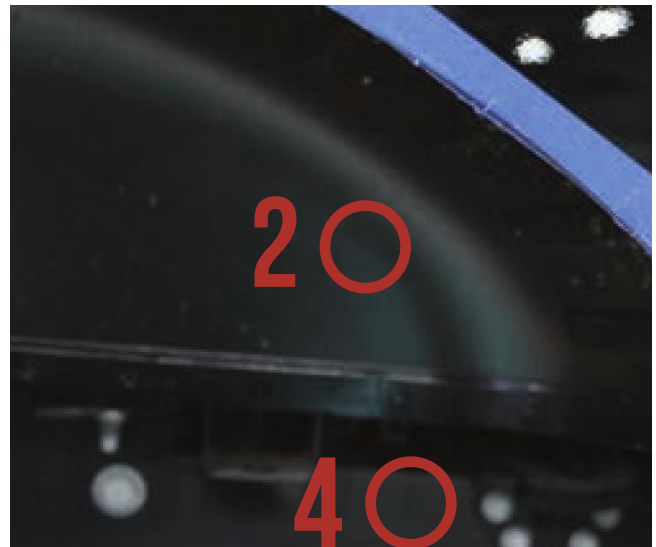

Using a chalk line, mark the cut line from the point where the indent in the rear fenders meet the wheel well cuts (ref 1 & 2) to the bottom of the quarter panels before the wheel well structure meets the bed (ref 3 & 4).





# INSTALLATION INSTRUCTIONS

## OPEN FENDER SYSTEM

Product Number: TF41XX

Application: 2017 FORD

F250/350



Using saw the final cuts should look similar to photos here on both sides of truck.



# CHAPTER 5

## INSTALLATION - CAB & FRAME (MODIFIER)

Note: All parts are mirrors, steps should be repeated on both sides unless stated otherwise.

### Cab Preparation

After cutting the vehicle such that all cuts are in line with the red dashed lines (i.e cut lines) on the templates and rust trap is applied to all cut and/or exposed metal in areas. You will be ready to begin installation. Refer images below for examples and instruction:

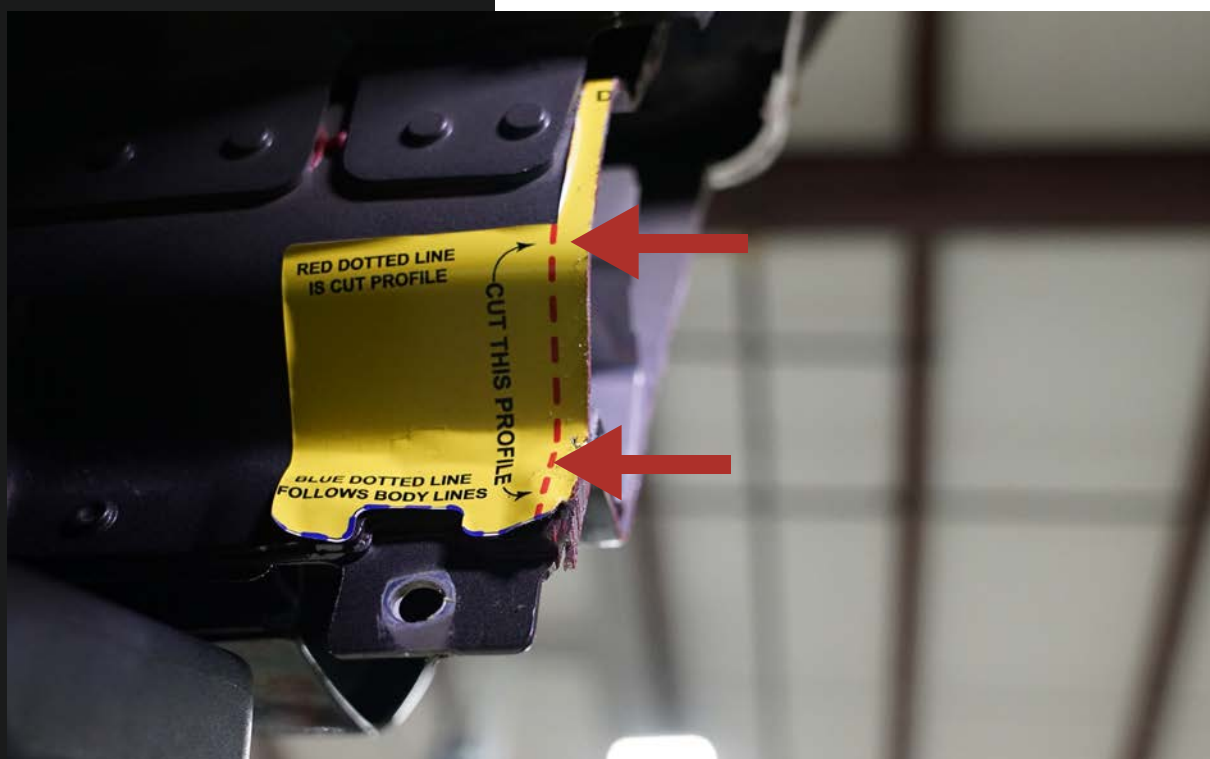

Any cut not in line with red cut line should be ground or cut back to match for proper fitment of accessories. The above cut is a good example of leaving too much material.

**INSTALLATION INSTRUCTIONS**  
**OPEN FENDER SYSTEM**  
Product Number: TF41XX  
Application: 2017 FORD  
F250/350



Description: Front of Brace



Description: Side of Brace

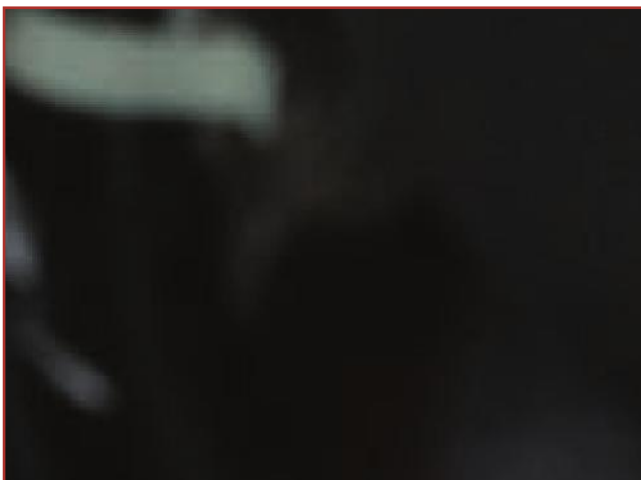

Description: Front Cab



# CHAPTER 5

## INSTALLATION - CAB & FRAME (MODIFIER)



Using an acid brush apply a coat of 'Rust Trap' to ALL cut edges and exposed surfaces to prevent corrosion. Above is an example of application in the cab cut area.



**INSTALLATION INSTRUCTIONS**  
**OPEN FENDER SYSTEM**  
Product Number: TF41XX  
Application: 2017 FORD  
F250/350

**1**

**Installing cap plate for rocker panels cab.**



**VIDEO: CH5 SEC-1**



Cut OEM foam straight across 4" from the bottom point. Insert foam into the rocker channel as seen in image on the right. Use duct tape or its equivalent to close off Channel as seen in image on the left.

Place the rocker plate over cut, as seen in images below,. Using the rocker plate holes as a guide, mark the center of the holes.

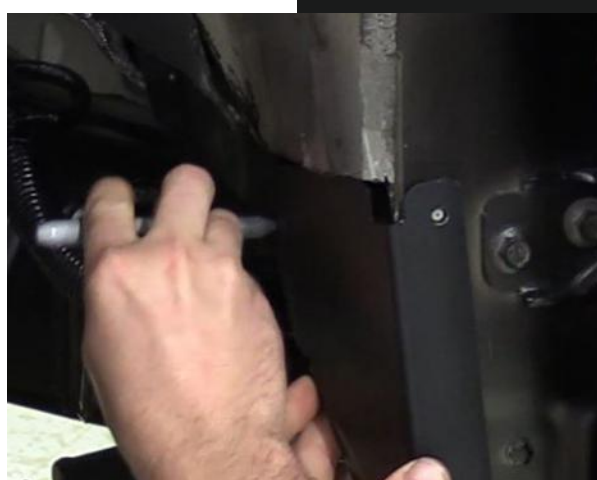

# CHAPTER 5

## INSTALLATION - CAB & FRAME (MODIFIER)

### Installing cap plate for rocker panels cab cont...



Using a 5/32" bit, drill pilot holes. Reinstall plate on vehicle, using a 3/8" socket and provided self-tapping bolts. With plate installed, tape around edges leaving a gap at the top for the provided foam tube to fit

Note: Do not allow the plate to shift while punching holes.

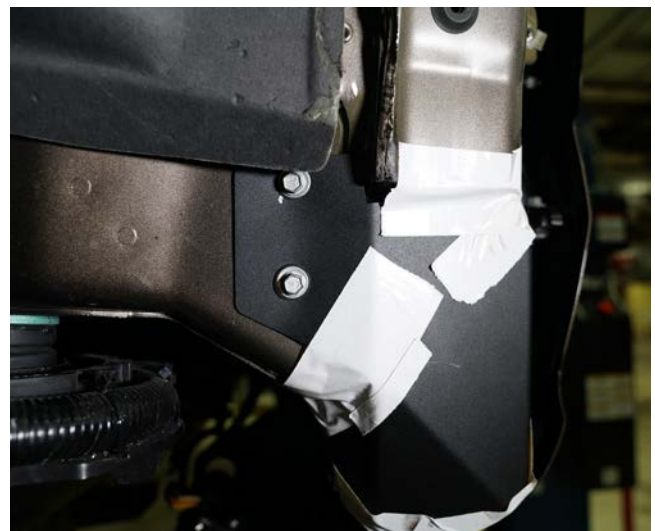

# INSTALLATION INSTRUCTIONS

## OPEN FENDER SYSTEM

Product Number: TF41XX  
Application: 2017 FORD  
F250/350

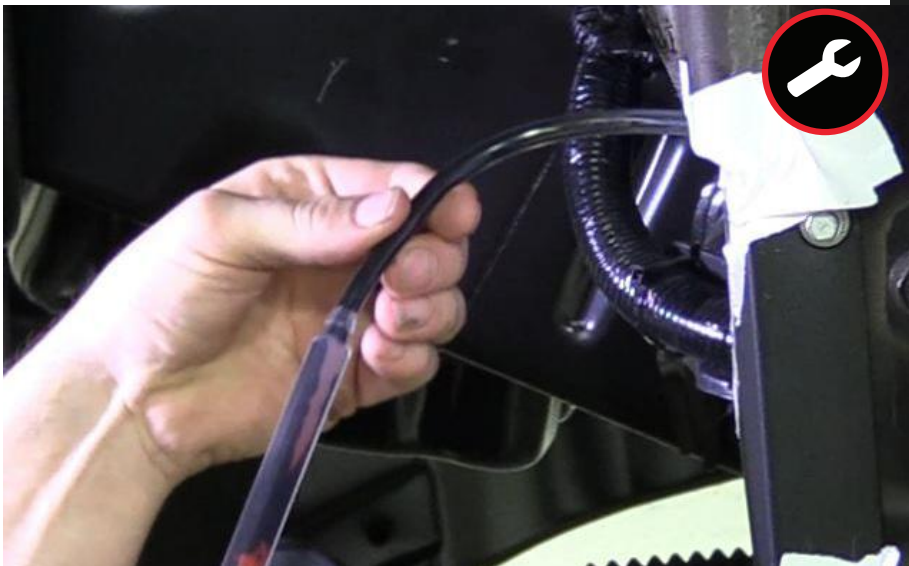

Using foam sealant fill in all gaps, then cover areas of application with duct tape and leave to set. After dry remove duct tape, remove excess. Note: read the directions and warning labels on provided sealing foam for instructions on proper application and use.





# CHAPTER 5

## INSTALLATION - CAB & FRAME (MODIFIER)



VIDEO: CH5 SEC-2

2

### Installing reinforcement bracket for brace.

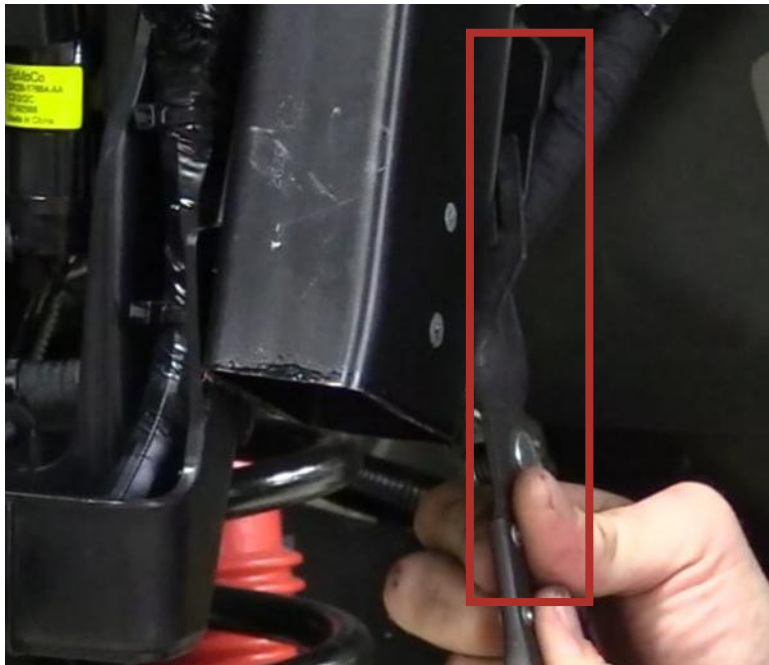

Wiring harness mount will need to be disconnected and floating. To do this remove Christmas trees pin on the inside surface of the reinforcement tube. Plastic housing will need to be floating. To do this remove Christmas trees and using a 10mm socket remove bolt. This will be reattached, using only the 10mm bolt, after.





# INSTALLATION INSTRUCTIONS

## OPEN FENDER SYSTEM

Product Number: TF41XX

Application: 2017 FORD

F250/350

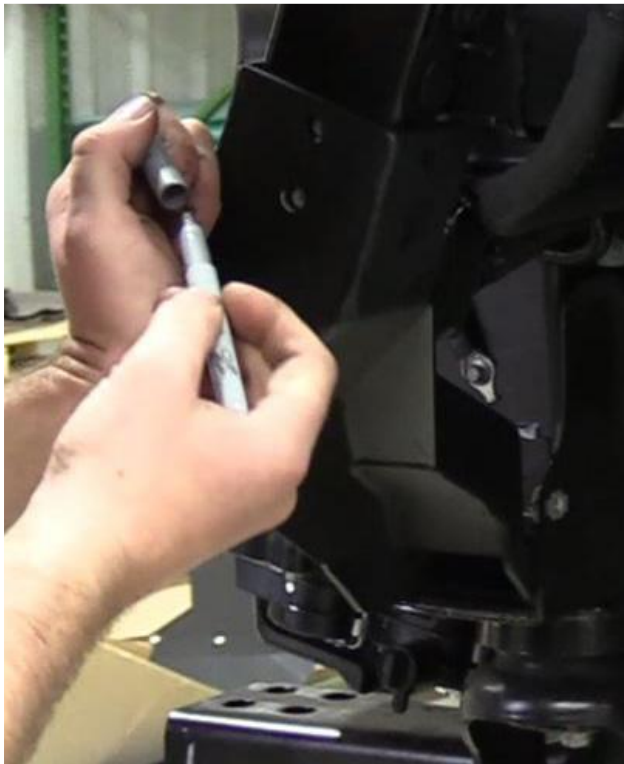

Insert lower portion of reinforcement bracket into cut, making sure the top of the brace is flush with the top mounting surface of the bracket. Hold the bracket to the reinforcement brace as shown besides. Mark the drill locations using a marker, a center punch, and the bracket hole as a guide. Use a 1/4" drill bit for a pilot hole. Do this on both sides of vehicle.

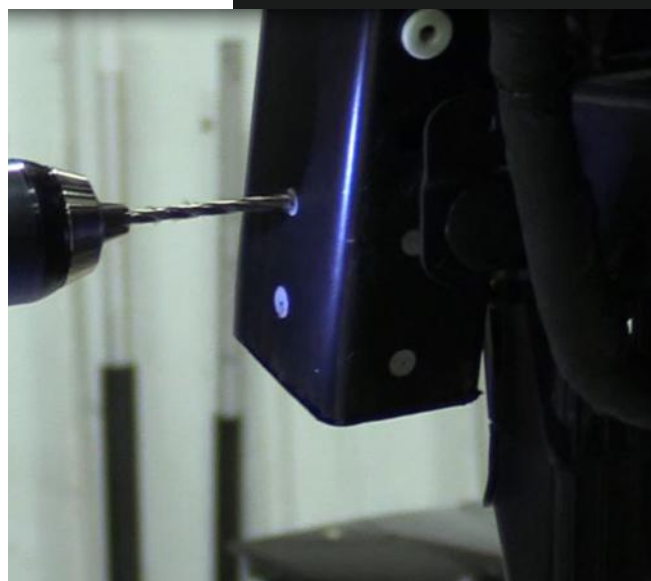
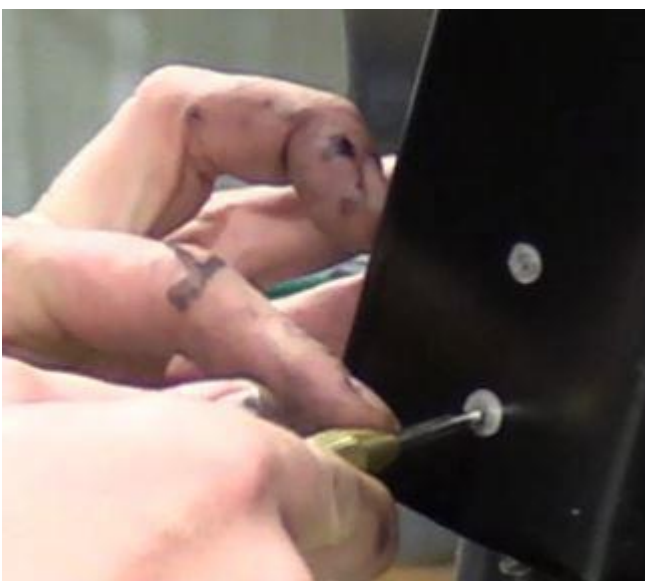

# CHAPTER 5

## INSTALLATION - CAB & FRAME (MODIFIER)

### Installing reinforcement bracket for brace cont.

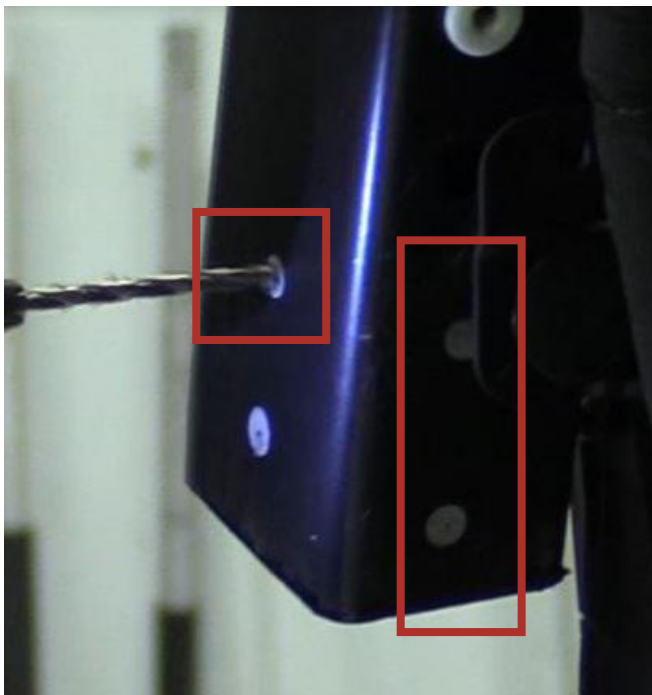

Using the provided drill bit for rivet, drill the top three holes indicated by the red squares in the image to the right and follow the rivet nut instructions<sup>1</sup> to install the three rivet nuts in the reinforcement bar.

Do this on both sides of vehicle.



# INSTALLATION INSTRUCTIONS OPEN FENDER SYSTEM

Product Number: TF41XX

Application: 2017 FORD

F250/350



Using a 3/8 drill bit, drill a through hole at the bottom outside hole location indicated by the purple circle to the right.

Note: WHEN DRILLING THROUGH HOLES IN BAR MAKE SURE TO PLACE PROTECTION BETWEEN ELECTRIC HARNESS AND BAR. REF BLUE LINE IN IMAGE

Do this on both sides of the vehicle.



# CHAPTER 5

## INSTALLATION - CAB & FRAME (MODIFIER)

### Installing reinforcement bracket for brace cont.

Looking at the photo on the right, note the part of the template that says drill. Center punch hole that hole and using a  $\frac{1}{4}$ " bit, drill a pilot hole. Using a  $\frac{5}{8}$ " bit drill hole in front bracket reinforcement.

Note: If front hole is off increase size with step up bit till  $\frac{1}{2}$ " bolt can clear normally.

With top of bracket fully bolted down and using the reinforcement bracket slot as a guide, drill fully through rear reinforcement.

Using the  $\frac{1}{2}$ " bolt stack, bolt down the lower bracket slot.

Do this on both sides of vehicle.

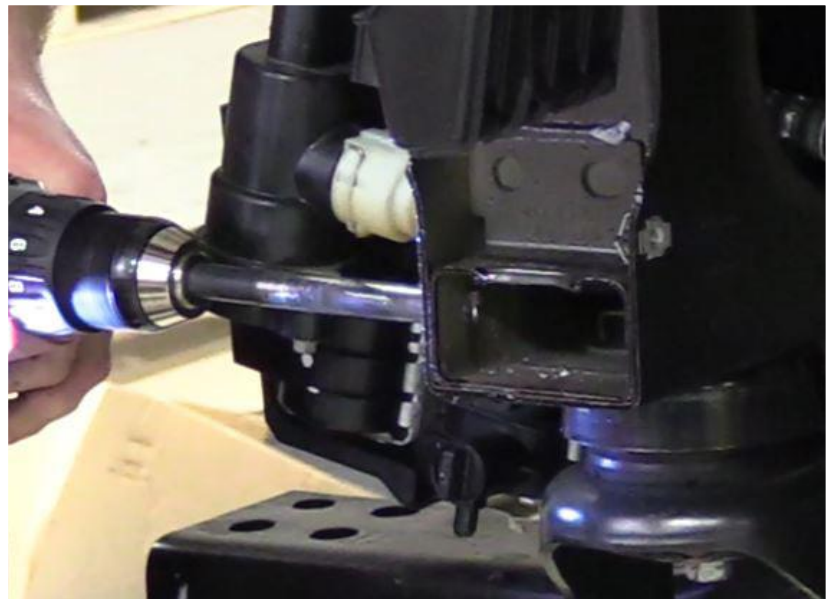



# INSTALLATION INSTRUCTIONS

## OPEN FENDER SYSTEM

Product Number: TF41XX

Application: 2017 FORD

F250/350



# CHAPTER 6

## INSTALLATION - FENDER (INNER)

Note: All cuts are mirror steps and should be repeated on both sides of vehicle unless specified otherwise.

# 1

## Locating rear inner fender hole.



VIDEO: CH6 SEC-1

With the help of one other. Remove inner bracket bolts. Mount inner fender and by hand loosely run bolts back in. Maneuver inner fender until it is above shock tower and bottom mounting hole is flush against frame.

Do this on both sides of vehicle.

With fender held in place, use a marker, center punch, and the mounting hole as a guide to mark the drill location. Remove inner fender and drill pilot hole in frame. Using the 17/32" bit, provided for in the hardware kit, drill the frame.

**NOTE: MAKE SURE INNER FENDER IS NOT TOUCHING SHOCK TOWER.**



# INSTALLATION INSTRUCTIONS

## OPEN FENDER SYSTEM

Product Number: TF41XX

Application: 2017 FORD

F250/350



VIDEO: CH6 SEC-2

2

### Installing inner fender.



Insert the rivet nut into the hole and follow the rivet nut installation instructions<sup>1</sup>.

Do this on both sides of vehicle.

Remount inner fender using the self-tappers and a 5/16" bolt stack for the rear. Leave all bolts loose until complete installation of front fender base. Repeat these steps on both sides of vehicle for full install.





# CHAPTER 7

## INSTALLATION - FENDER (BASE)



VIDEO: CH7 SEC-1

1

### Drilling holes in fender.

Place base on fender keeping it in line with the front edge as well as the rounded contour of the fender. Use a pick and/or marker to mark the clearance hole locations where necessary for weldnuts (ref red circles). remove fenders and using a step-up bit and/or metal shears to create large clearance holes as needed so projection weldnuts on backside of fender base does not touch OEM fender in any location. Use metal shears, step up bit, and/or grinder to remove material from cut area until fenders can fit evenly along contours

Note: if weldnuts are touching it may effect fitment of bases.

Do this on both sides of vehicle.





# INSTALLATION INSTRUCTIONS

## OPEN FENDER SYSTEM

Product Number: TF41XX

Application: 2017 FORD

F250/350



# CHAPTER 7

## INSTALLATION - FENDER (BASE)

### Drilling holes in fender cont...

Replace base on fender such that it is flush with the surface and all contours are aligned. Starting at the rear clamp the fender to the base to hold it in place. Now, using a  $25/64$ " center punch mark the drill locations and remove fender. Remove fender and drill out all center punched holes us a Q sized drill bit.

Do this on both sides of the vehicle.



# INSTALLATION INSTRUCTIONS

## OPEN FENDER SYSTEM

Product Number: TF41XX

Application: 2017 FORD

F250/350

2

## Installing base on fender



Install seal along the edge of part.

Note: do not precut seal apply seal as a whole and only cut remainder after fully installed.

Using the provided mounting plates and the 5/16" stainless steel bolts install base, refer to images in section. All bolts should be hand tight and orientation checked before using a 3/16" Allen wrench to tighten all bolts. At this point remove front bottom mounting flange with body saw as indicated in image below.



Do this on both sides of vehicle.



# CHAPTER 7

## INSTALLATION - FENDER (BASE)

Installing base on fender cont...





# INSTALLATION INSTRUCTIONS

## OPEN FENDER SYSTEM

Product Number: TF41XX

Application: 2017 FORD

F250/350

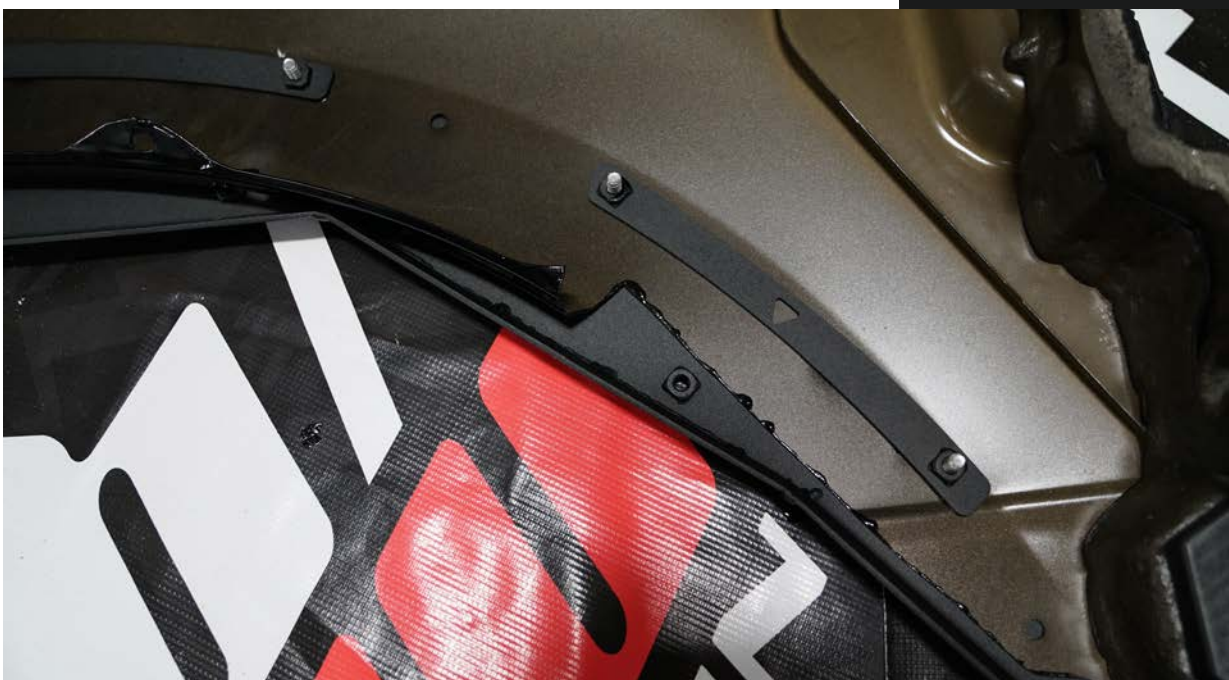

# CHAPTER 7

## INSTALLATION - FENDER (BASE)



VIDEO: CH7 SEC-3

3

### Installing fender on truck



Reinstall the cut OEM foam before reinstalling fender on truck where red square indicates above.

All bolts on the inner fender will be loose as the fender is reinstalled on the vehicle.

To install the top portion of the fender reverse the disassembly instructions found in chapter 1.

For the installation of the lower portion of the fender, start by loosely bolting the inner fender to the fender.

## INSTALLATION INSTRUCTIONS

### OPEN FENDER SYSTEM

Product Number: TF41XX

Application: 2017 FORD

F250/350

## Installing base on fender



Use the bottom OEM hardware removed from the lower flange of the fender to bolt the fender base at the same location.

Loosely mount the Reinforcement bracket using two 5/16" bolts (ref. blue square), the bolt the front of the fender at the indicated location (ref. red circle) with 5/16" bolt stack.

Tighten down all hardware when fender is position properly.

Do this on both sides of vehicle.

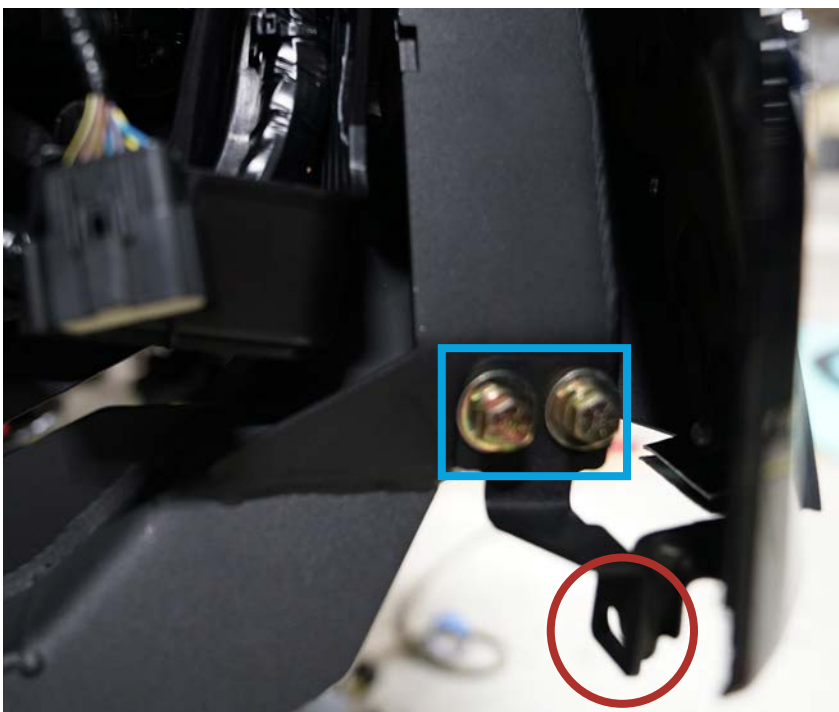



# CHAPTER 7

## INSTALLATION - FENDER (BASE)



VIDEO: CH7 SEC-4

Note: No two fenders fit the same. One should always take care to remove the least amount of material from the area around the cut line as possible for a good fit.

4

### Installing fender on rear truck



With the help of one other hold rear fender base up to vehicle. Base should make contact at bottom edges of fender cuts and follow the contour of the remaining fender.





## INSTALLATION INSTRUCTIONS

### OPEN FENDER SYSTEM

Product Number: TF41XX

Application: 2017 FORD  
F250/350



Once fender fits flush to the vehicle clamp fender in place at top and bottom flanges. Use a  $25/64$ " center punch to punch all holes.

Remove fender and use a  $17/32$  to drill the pilot holes. Using the drill bit provided in the hardware kit, drill out holes.

Follow the rivet nut installation instructions install rivet nuts in the top four holes view image below.



Then replace fender and install  $5/16$ " stainless steel bolts with a  $3/16$ " Allan wrench.

# CHAPTER 7

## INSTALLATION - FENDER (BASE)

### Installing fender on rear truck cont...



Run seal along outer edge of base, cutting the excess off after full installation. With seal installed used the provided stainless steel hardware and nut plates to install fender base.



## INSTALLATION INSTRUCTIONS

### OPEN FENDER SYSTEM

Product Number: TF41XX

Application: 2017 FORD

F250/350



With the stainless steel hardware fully bolted, drill clearance holes for 5/16" zinc bolts at the slots located at the bottom corner on each side.

Using the 5/16" zinc bolts provided, bolt in the front flange.

The rear flange will be bolted in after the plastic kick plate has been installed.

# CHAPTER 7

## INSTALLATION - FENDER (BASE)

### Installing fender on rear truck cont...



Using shears, cut off the front portion of the kick panels. There should be enough material left to tuck under fender flange. Reinstall kick panels inserting front under fender flange (ref. oval) and using pins to clipping in rest (ref. arrows).

Do this on both sides.





# INSTALLATION INSTRUCTIONS

## OPEN FENDER SYSTEM

Product Number: TF41XX

Application: 2017 FORD

F250/350



# CHAPTER 8

## INSTALLATION - FENDER (FLARE)



VIDEO: CH8 SEC-1

1

### Installing front fender flare.

**Note:** All parts are mirrors steps should be repeated on both sides of vehicle unless specified.



Use surrounding images as an example install seal on mounting edge.



# INSTALLATION INSTRUCTIONS OPEN FENDER SYSTEM

Product Number: TF41XX  
Application: 2017 FORD  
F250/350

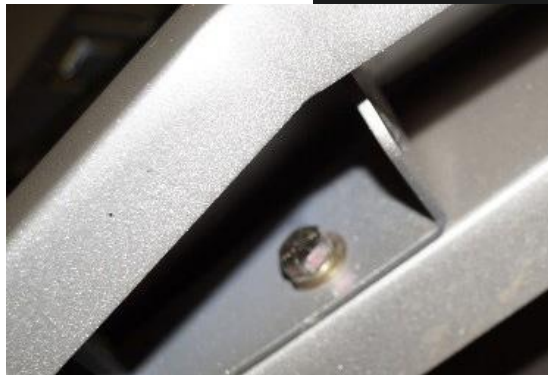

Using a 1/2" socket/  
ratcheting wrench,  
Install fender flare.  
Install all bolts hand  
tight.

Diagram below  
indicates installation  
order. Leave bolts  
extremely loose  
until all bolts have  
been installed.



The image to the  
left provides the  
preferred bolting  
order.



# CHAPTER 8

## INSTALLATION - FENDER (FLARE)



VIDEO: CH8 SEC-2

2

Installing rear fender flare.



Install seal around edge of fender flare. Using a 1/2" socket/ratcheting wrench, Install fender flare. Install all bolts hand tight. Surrounding images show bolt installation. Leave bolts extremely loose until all bolts have been installed.





# INSTALLATION INSTRUCTIONS

## OPEN FENDER SYSTEM

Product Number: TF41XX

Application: 2017 FORD

F250/350

The image below provides the preferred bolting order.



# CHAPTER 9

## MAINTENANCE & CARE



# INSTALLATION INSTRUCTIONS

## OPEN FENDER SYSTEM

Product Number: TF41XX

Application: 2017 FORD

F250/350

Periodically check and tighten all fasteners.

Stripped, fractured, or bent bolts or nuts need to be replaced.





# APPENDIX 1

## Rivet Nut Installation:

1. Using the 17/32" drill bit provided in the hardware kit, drill hole.
2. Build bolt and tool stack for rivet nut as seen below.
3. Insert rivet nut stack into hole and using a 1/2" socket and a 9/16" wrench to hold the tool. Tighten rivet nut down.

