



**INSTALLATION MANUAL**  
**GLADIATOR REAR BUMPER**  
**PRODUCT NUMBER: Y1950**  
**APPLICATION: 2020 JEEP GLADIATOR**



## **IMPORTANT SAFETY GUIDE** | Your safety and the safety of others is very important.

In order to help you make informed decisions about safety, we have provided the following warnings, safety precautions, installation instructions, and other important information to alert you to potential hazards that could hurt you or others.

Please do a job safety analysis before each task to identify potential hazards for your situation and remove/protect against them. Use own good judgment and take your time.

Check packaged materials immediately upon arrival to ensure that all listed parts are included and undamaged.

**Read and understand all warnings, safety precautions, and instructions before installing this product.**

SENSORS FIELD OF VIEW MAY BE ALTERED WITH USE OF THE REPLACEMENT BUMPER.

---

### **WARNINGS**

- Failure to observe the following warnings and instructions provided in this manual could lead to severe injury and/or death.
- For professional installation only. Careless installation and/or operation can result in serious injury, death, and/or equipment damage. All liability for installation and use rests with the user or consumer.
- Fab Fours, Inc. only approves installing this product according to these written instructions with the hardware provided. Failure to install according to these instructions will invalidate the warranty. This includes, but is not limited to, using alternative installation methods, hardware, or materials.
- This product is for off road use only.

---

### **SAFETY PRECAUTIONS**

- Always remove jewelry and wear eye protection.
- Always use extreme caution when jacking up a vehicle for work. Set emergency brake and use tire blocks. Locate and use the vehicle manufacturers designated lifting points. Use jack stands.
- Always use appropriate and adequate care in lifting components into place.
- Always ensure components will remain secure during installation and operation.
- Always wear safety glasses when installing this kit. A drilling operation will cause flying metal chips. Flying chips can cause serious eye injury.
- Always use extreme caution when drilling a vehicle. Always disconnect power before welding. Thoroughly inspect the area to be drilled (on both sides of material when possible) prior to drilling, and relocate any objects that may be damaged.
- Always use extreme caution when welding a vehicle. Thoroughly inspect the area to be welded (on both sides of material when possible) prior to welding, and relocate any objects that may be a fire hazard. When welding in a cab, make sure the interior surfaces are covered (e.g., welding blanket) and a fire extinguisher is at hand.
- Always use extreme caution when cutting and trimming during fitting.
- Always tighten all nuts and bolts securely per installation instructions.
- Always route electrical cables carefully. Avoid moving parts, components that become hot, and rough or sharp edges.
- Always insulate and protect all exposed wiring and electrical terminals.
- Perform regular inspections and maintenance on mounts and hardware.

# TABLE OF CONTENTS

- 2 SAFETY / DISCLAIMER
- 3 TABLE OF CONTENTS
- 4 A MESSAGE FROM THE OWNER
- 5 GETTING STARTED
- 6 PROVIDED MATERIAL
- 8 DISASSEMBLY
- 12 INSTALLATION
- 18 CONTACT

# A MESSAGE FROM THE OWNER

---



Fab Fours' was born out of a passion for customizing vehicles and a love of the outdoors. Our engineering team uses the latest 3D design software to turn new product ideas into reality. In our factory, designs come to life with the combination of cutting edge technology for metal cutting and forming and an American workforce that puts its' heart and pride into every product.

From design and manufacturing, to quality and delivery, Fab Fours' mission is to be the market leader for steel truck and jeep accessories. We make sure a quality product is delivered on time, more than expected, better than expected to our customers.

Enjoy your new Fab Fours product. Welcome to the family!

*Ereg Higgs*

**FOUNDER, FAB FOURS**

# GETTING STARTED

---

Before you begin the installation process of your new Fab Fours product, we suggest laying out all materials and parts on a pad or protective surface.

Failure to fully account for all components before beginning installation may leave vehicle immobile until part is acquired. Refer to the next pages as an inventory check.

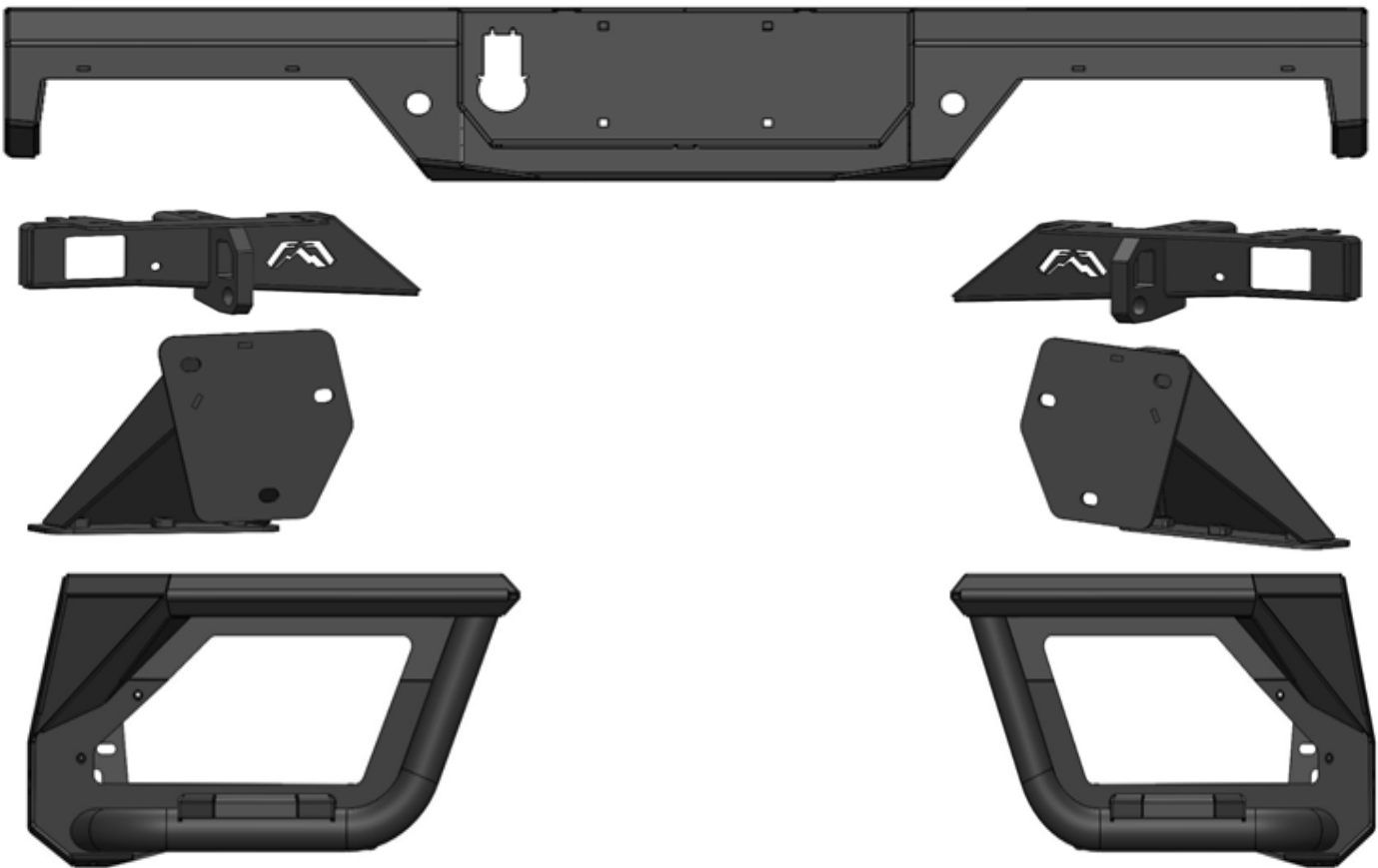

# PROVIDED MATERIALS

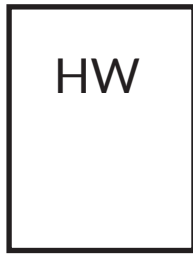

20296 x4

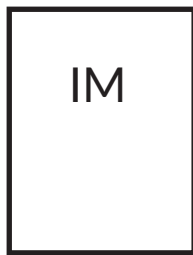

Y1950 IM



50199-HW

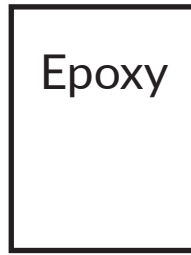

61632 x2



21989



21991



21990



21999



21998



22000



22001

## HARDWARE KIT | 50199

FAB FOURS IDENTIFICATION	COMPONENT DESCRIPTION	QTY
50199-HW	Plastic Nylon License Plate Nut	4
50199-HW	1/2"-13 x 1.25" Yellow Zinc Hex Bolt, Grade 8	4
50199-HW	1/2" Yellow Zinc Flat Washer, Grade 8	12
50199-HW	1/2" Yellow Zinc Lock Washer, Grade 8	12
50199-HW	1/2" Yellow Zinc Hex Nut, Grade 8	8
50199-HW	5/16"-18 x 3/4", Button Head Cap Bolt, Stainless Steel	6
50199-HW	5/16" Stainless Steel Flat Washers	6
50199-HW	5/16" Stainless Steel Lock Washers	6
50199-HW	M10-1.25 x 25 Zinc Hex Head Bolt	4
50199-HW	M10 Zinc Flat Washers	4
50199-HW	M10 Zinc Lock Washers	4
50199-HW	7/16"-14 x 4" Yellow Zinc Hex Bolt Grade 8	2
50199-HW	7/16" Yellow Zinc Flat Washers Grade 8	22

## TOOLS REQUIRED

- 1/2" Socket Wrench
- 3/4" Socket Wrench
- 11/16" Socket Wrench
- 5/8" Socket Wrench
- 15mm Socket Wrench
- 16mm Socket Wrench
- 21mm Socket Wrench
- 9mm Socket Wrench
- Body Pry Tool
- T47 Star Socket Wrench
- 3/32" Allen Wrench
- Scissor/Cutting Pliers
- 7/32" Allen Wrench
- 5/32" Allen Wrench

## ASSISTANCE

We recommend two people perform the installation as items are heavy and may need to be held in place while installing.

## ORGANIZATION

Disassemble the vehicle where you can catalog and store everything. We suggest labeling and bagging all the OEM bolts when removing from the vehicle. Failure to keep track of parts could lead to an inability to properly reinstall components.

## HARDWARE KIT | 50199

FAB FOURS IDENTIFICATION	COMPONENT DESCRIPTION	QTY
50199-HW	7/16" Yellow Zinc Lock Washer, Grade 8	14
50199-HW	7/16" Yellow Zinc Hex Nut, Grade 8	8
50199-HW	7/16"-14 x 1.5", Button Head Cap Bolt, Stainless Steel	2
50199-HW	7/16" Stainless Steel Flat Washers	4
50199-HW	7/16" Stainless Steel Lock Washers	2
50199-HW	7/16" Stainless Steel Hex Nut	2
50199-HW	7/16"-14 x 1", Yellow Zinc Hex Bolt, Grade 8	6
50199-HW	7/16"-14 x 1.5", Yellow Zinc Hex Bolt, Grade 8	6
50199-HW	#8-32 x 3/4" Button Head Bolt, Stainless Steel	4
50199-HW	#8-32 Nylock Hex Nut, Stainless Steel	4
50199-HW	#8-32 Flat Washer Stainless Steel	4

# DISASSEMBLY

*NOTE: Save all OEM parts until installation is complete!*

**1. Use a 16mm socket wrench to remove the two bolts located behind the license plate. (Figure-1)**

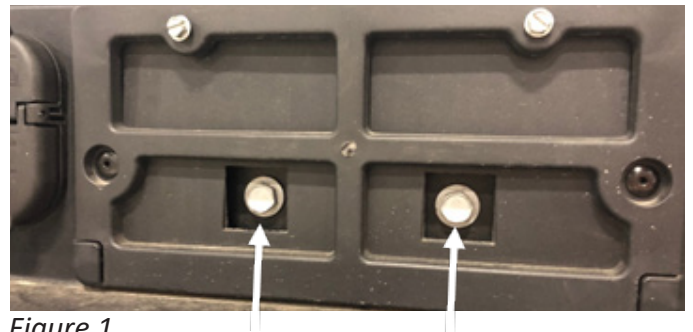

Figure 1

**2. Use a T47 star socket wrench to remove the two bolts located on either side of the tow hitch. (Figure-2)**

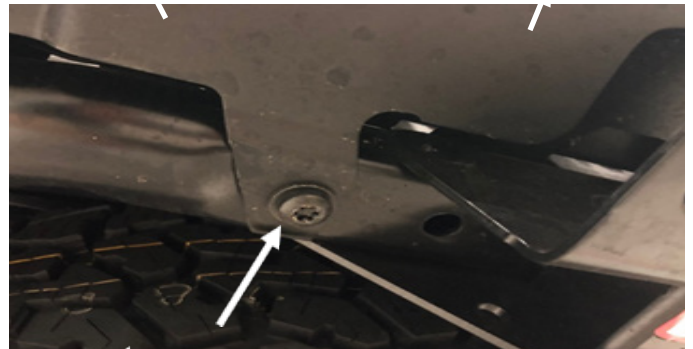

Figure 2

**3. Disconnect the sensor harness from the frame. (Figure-3).**



Figure 3



4. With assistance, hold the bumper and use a 16mm socket wrench to remove the four mount nuts holding the bumper onto the truck. Remove the bumper at this time. (Figure-4)



Figure 4

5. If truck is equipped with rear side sliders, remove them at this time using a 15mm socket wrench to remove the three bolts holding it to the mount. (Figure-5)

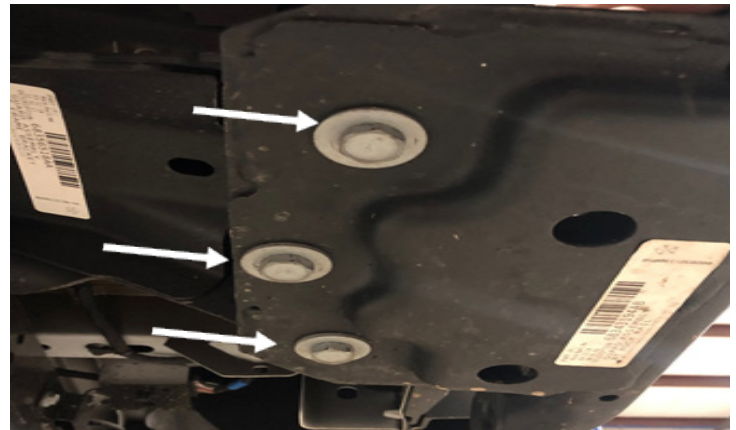

Figure 5

6. If truck is equipped, remove the OEM tow hooks with a 21mm socket wrench to remove the two bolts. (Figure-6)



Figure 6

---

7. If your truck is equipped, remove the four sensors by pushing the housing clips apart and pulling the sensor out. (Figure-7)

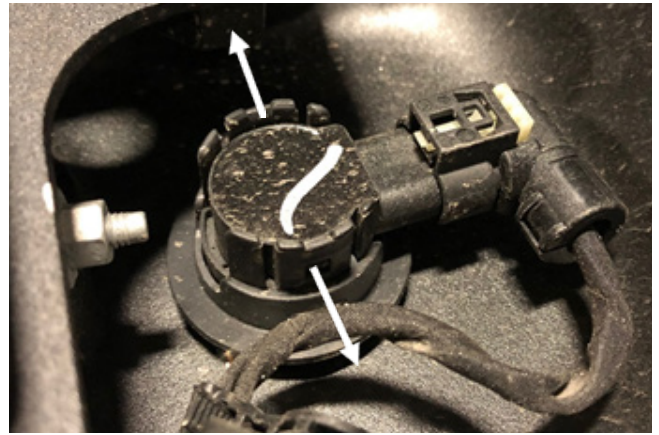

Figure 7

8. Remove the sensor housings by removing the inner circle clip and pulling the housings out of the bumper. (Figure-8)



Figure 8

**9. Push the metal clips in on the trailer plug to remove it from the OEM bumper. (Figure-9)**

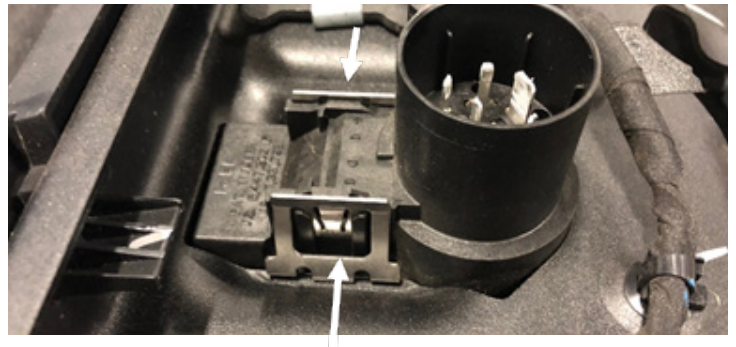

*Figure 9*

**10. Use a body pry tool to remove the clips holding the sensor harness in the OEM bumper.**

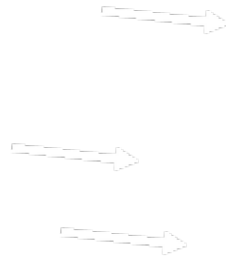

**11. Use a body pry tool to disconnect the license plate lights from the bumper. (Figure-10)**



*Figure 10*

# INSTALLATION

12. Using a 1/4" drill bit, drill out the four marked holes in the trailer plug for the #8 bolts. (Figure-11-12)



Figure 11

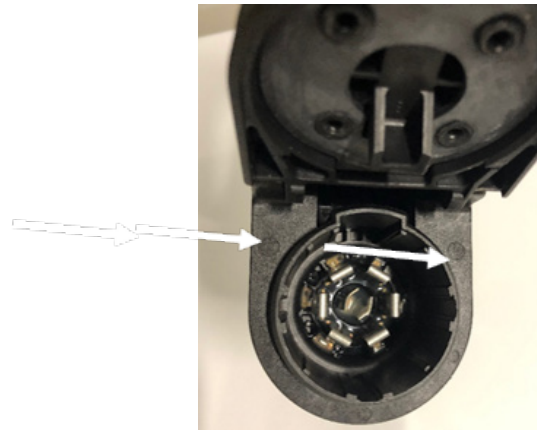

Figure 12

13. Using a 3/32" Allen Wrench and 9mm socket wrench, install the trailer plug into the bumper with the provided four (4) #8-32 Stainless steel bolts, nylock nuts and washers (50199-HW). (Figure-13)



Figure 13

**14. Use a pair of plyers or scissors to cut the tabs off the OEM sensor locking clips. (Figure-14)**



*Figure 14*

**15. Take the sensor housings from the OEM bumper and install them into the Fab Fours bumper (21989) and wings (22000 and 22001) by pressing the housing in and connecting the locking clip from the inside. Apply epoxy (61632) if needed. (Figure -15-16)**



*Figure 15*



*Figure 16*

16. Use a 3/4" socket wrench to attach the wings (22000 and 22001) to the bumper (21989) using the four provided bolt strips (20296) along with the 1/2" flat and lock washers, and nuts (50199-HW). Leave nuts hand tightened at this time for easier install. (Figure-17)



Figure 17

17. Install the OEM sensor harness into the bumper and connect the four sensors into their respective housings by pushing them into their clips. Make sure the harness plug is on the passenger side of the bumper. (Figure-18)



Figure 18

18. Use a pair of scissors or cutting pliers to remove the tabs on the face of the OEM license plate lights before install. (Figure-19)



Figure 19

19. Install the OEM license plate lights into the bumper by putting the face of the light on the outside and connecting it with the light and clip from the inside. Apply epoxy (61632) if needed. (Figure-20)



Figure 20

20. Use a 3/4" socket wrench to install the two D-ring brackets (21990 and 21991) with two 1/2" Hex head bolts flat washers and lock washers (50199-HW). Use a 11/16" socket wrench with a 7/32" Allen wrench to install the 7/16" stainless button head bolts with flat and lock washers and nut (50199-1W). Fully tighten all bolts. (Figure-21)



Figure 21

21. If truck is not equipped with rear side sliders, install the side mounting brackets (21998 and 21999) using two M10-1.5 bolts with flat and lock washers along with a 7/16"-4" zinc steel hex bolt with flat and lock washers and nut (50199-HW). Use a 16mm socket wrench to install the M10 hardware and a 11/16" and 5/8" socket wrenches to install the 7/16" hardware. (Figure -22)



Figure 22

22. With assistance, hold the bumper up to the mounts and use a 5/8" socket wrench to install the three 7/16"-1" zinc steel hex bolts with flat and lock washers to the wing mounts (50199-HW). Repeat step on the other side of the truck. (Figure-23)



Figure 23

23. Use a 5/8" and 11/16" socket wrench to install the three 7/16"-1.5" zinc steel hex bolts with flat and lock washers and nuts (50199-HW) repeat step on the other side of the truck. (Figure-24)

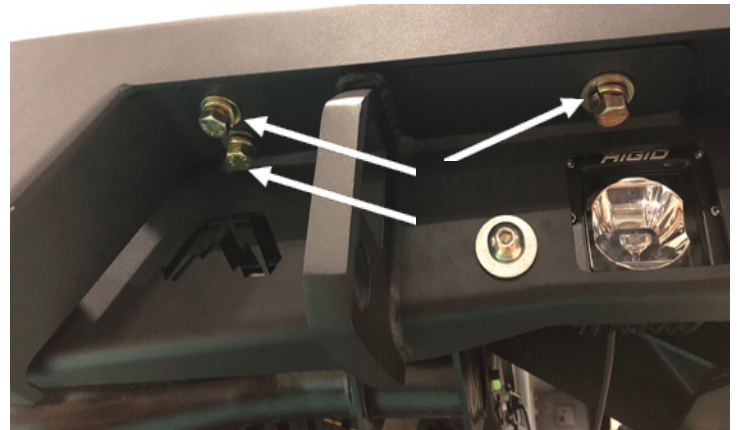
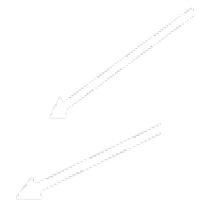

Figure 24

24. Adjust the bumper and wings to desired position then fully tighten all mounting bolts on the bumper and brackets. It is important to double check every bolt to make sure it is fully tightened.





25. Take the two cover plates (22010 and 22011) and attach them to the wings using a 5/32" Allen wrench with the three 5/16" Button head stainless steel bolts with flat and lock washers (50199-HW). (Figure-25)



Figure 25

26. Install the four plastic license plate nuts into the bumper by pressing them into the square holes (50199-HW). (Figure-26)

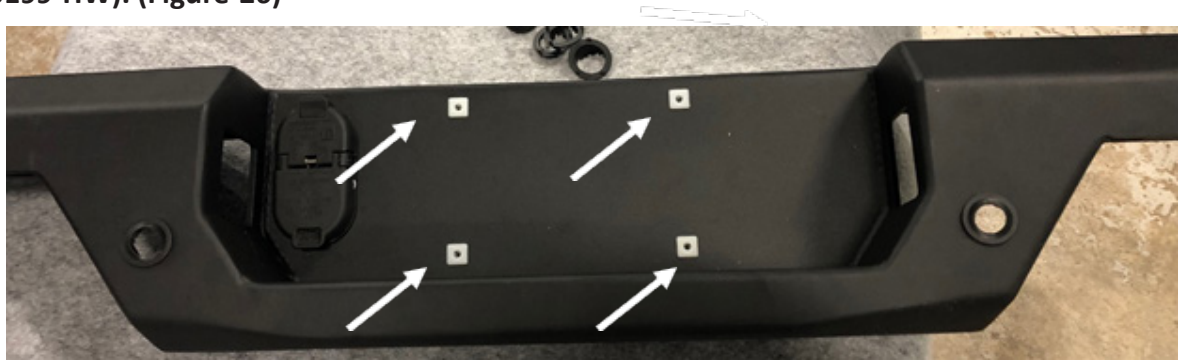

Figure 26

---

---

**“IF YOU’RE LOOKING FOR MORE OF THE SAME,  
THEN YOU’VE COME TO THE WRONG PLACE.”**

**- GREG HIGGS**

