



# Installation Instructions

## GMC 1500 BS Front Bumper

Product Number: K3160, K3161, K3162  
Application: '14 GMC 1500

## SAFETY

Your safety and the safety of others is very important.

- In order to help you make informed decisions about safety, we have provided installation instructions and other information.
- These instructions alert you to potential hazards that could hurt you or others.
- Please do a job safety analysis (JSA) before each task to identify potential hazards for your situation and remove/protect against them.
- You must use your own good judgment, and take your time.

Read and understand all safety precautions and instructions before installing this product.

**THIS PRODUCT IS FOR OFFROAD USE ONLY. ALL LIABILITY FOR INSTALLATION AND USE RESTS WITH THE OWNER.**

**CARELESS INSTALLATION AND OPERATION CAN RESULT IN SERIOUS INJURY OR EQUIPMENT DAMAGE.**

## INJURY & HAZARD

Failure to observe these instructions could lead to severe injury or death.

- Always remove jewelry and wear eye protection.
- Always use extreme caution when jacking up a vehicle for work. Set emergency brake and use tire blocks. Locate and use the vehicle manufacturers designated lifting points. Use jack stands.
- Always use appropriate and adequate care in lifting components into place.
- Always insure components will remain secure during installation and operation.
- Always wear safety glasses when installing this kit. A drilling operation will cause flying metal chips. Flying chips can cause serious eye injury.
- Always use extreme caution when drilling on a vehicle. Thoroughly inspect the area to be drilled (on both sides of material) prior to drilling, and relocate any objects that may be damaged.
- Always use extreme caution when cutting and trimming during fitting.
- Always tighten all nuts and bolts securely per installation instructions.
- Always route electrical cables carefully. Avoid moving parts, components that become hot and rough or sharp edges.
- Always insulate and protect all exposed wiring and electrical terminals.
- Always perform regular inspections and maintenance on mounts and related hardware.





# Installation Instructions

## GMC 1500 BS Front Bumper

Product Number: K3160, K3161, K3162  
Application: '14 GMC 1500

### I. Overview

Congratulations on your new purchase of the industries' best and most stylish Front Bumper available for the 2014 GMC 1500! This Bumper has been engineered for strength while keeping the weight down.

Your Front Bumper designed in 3-D from digitized data, CNC laser cut, fabricated, and powder coated... all in the U.S.A.

Enjoy the fit and finish of a quality GMC 1500 Front Bumper from Fab Fours Inc.



### Parts List

- K316X replacement bumper
- K316X-HW fastener kit
- Instruction Manual

### Tools Required

- Socket Wrench with Extension (Ratcheting wrenches may also be convenient)
- 7mm , 15mm , & 18mm Sockets and Box End Wrenches
- T15 torx
- Flat Head Screw Drivers
  - Floor Jack and wood block.





# Installation Instructions

## GMC 1500 BS Front Bumper

Product Number: K3160, K3161, K3162  
Application: '14 GMC 1500

## II. Removal of OEM Bumper

**Note: Save all OEM parts until installation is complete!**

- A. Open hood and locate push pins on radiator cover. Using a flat head screw driver, pull the head of the push pins up, remove push pin and lift radiator cover off. This will allow access to top Grille bolts (Ref. Figure 1).



Figure 1

- B. Remove the valence from the vehicle. Unfasten the screws located in the forward section of each wheel well connecting the wheel well liner and the trim to the vehicle (Ref. 2a). Carefully pull both the trim and liner away from the vehicle, this will grant access to the interior cavity (Ref. 2b).





# Installation Instructions

## GMC 1500 BS Front Bumper

Product Number: K3160, K3161, K3162  
Application: '14 GMC 1500



Figure 2a



Figure 2b

- C. At this point the corner of the valence may still be held in place by the black “backing support” secured to the frame by hex head screws, use a 7mm short socket or ratchet wrench to unscrew. The color coded arrows show the location and direction of screws (Ref. 2c-d). Corners of valence should easily pull away. Locate retaining clips at bottom of valence. Depress clips and begin to remove valence as each clip is released.

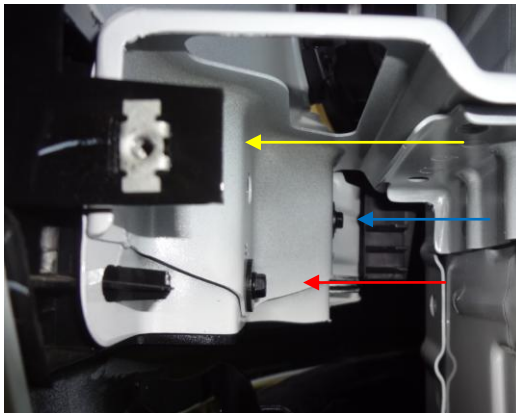

Figure 2c

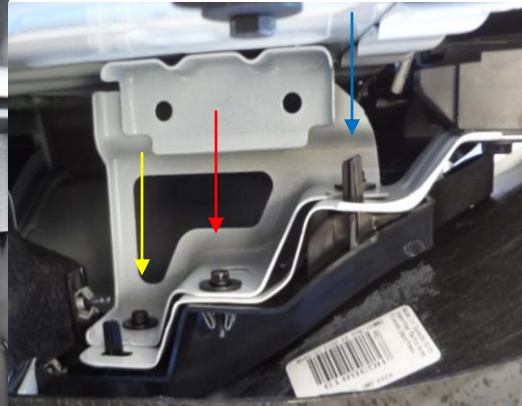

Figure 2d

- D. Disconnect electrical harness from vehicle.







# Installation Instructions

## GMC 1500 BS Front Bumper

Product Number: K3160, K3161, K3162  
Application: '14 GMC 1500



Figure 3(electrical harness disconnected)

- E. Remove the fasteners connecting the grille to the frame. Eight bolts, indicated by the red ovals, are located at the top and bottom of the grille and two bolts are located behind the grill.



Figure 4a



Figure 4b





# Installation Instructions

## GMC 1500 BS Front Bumper

Product Number: K3160, K3161, K3162  
Application: '14 GMC 1500



Figure 4c



Figure 4d

- F. Remove the fasteners connecting the Bumper to the frame. Using a socket/wrench remove bolts from the top and bottom of bracket connected to the bumper. Pull bumper away from vehicle and remove forward facing bolts holding bracket to frame. Repeat process on each side of vehicle.



Figure 5





# Installation Instructions

## GMC 1500 BS Front Bumper

Product Number: K3160, K3161, K3162  
Application: '14 GMC 1500

- G. Remove bolts securing tow hooks to frame. Location is indicated in image below by green rectangle (Ref. 6b).**



Figure 6a

Figure 6b

- H. Replace valence and grille by reversing the order of Removal steps A through E**
- I. Remove OEM electrical harness from bumper. Disconnect harness from fog lights and sensors. Pop out plastic clips holding harness to bumper on both sides and carefully pull away.**
- J. Remove OEM electrical harness from bumper. Disconnect harness from sensors. Pop out plastic clips holding harness to bumper. Remove fog lights from bumper by unbolting black support frame and unscrewing fog lamp housing from flanges on both sides.**





# Installation Instructions

## GMC 1500 BS Front Bumper

Product Number: K3160, K3161, K3162  
Application: '14 GMC 1500



Figure 7a



Figure 7b (Support Frame)







# Installation Instructions

## GMC 1500 BS Front Bumper

Product Number: K3160, K3161, K3162  
Application: '14 GMC 1500



Figure 7c (Flange)

### III. Front Bumper Installation

- A. Install Fog light housing in Fab Fours bumpers. Slide housing into position and using the OEM screws secure fog light in place (Ref. Figure 8). Attach OEM electrical harness to Fab Fours Bumper and connect fog light to harness.





# Installation Instructions

## GMC 1500 BS Front Bumper

Product Number: K3160, K3161, K3162  
Application: '14 GMC 1500

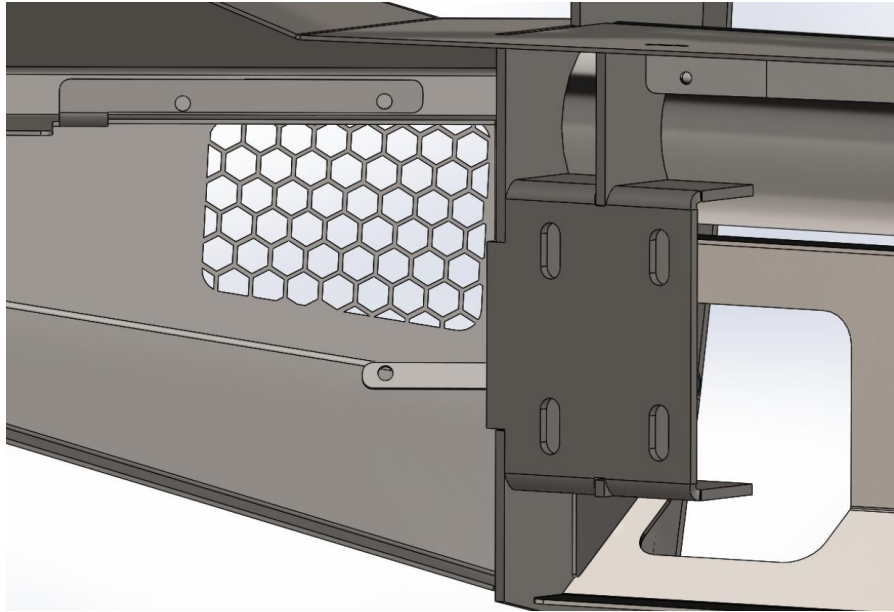

Figure 8

- B. Mount bracket to truck frame. Three bolts pass through the front of the frame and are indicated by the red boxes. One bolt passes through the side of the frame (i.e. cross bolt) and is indicated by the blue circles. All bolts should be hand tight to allow for adjustment (Ref. Figure 9a-c).**

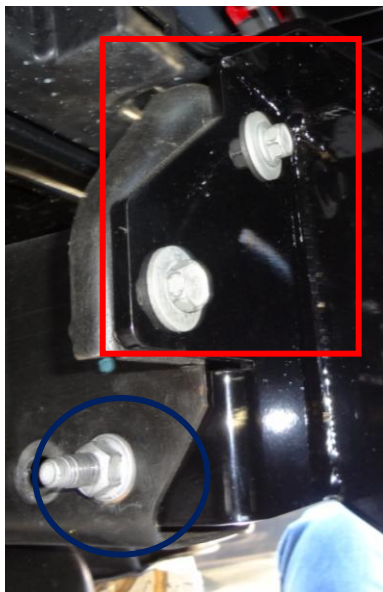

Figure 9a

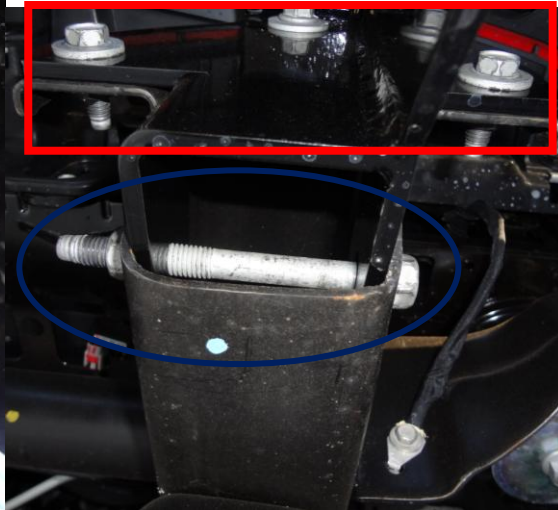

Figure 9b





# Installation Instructions

## GMC 1500 BS Front Bumper

Product Number: K3160, K3161, K3162  
Application: '14 GMC 1500



Figure 9c

- C. **Mount bracket to bumper. With the help of at least two others, and a floor jack, to support the center of the bumper, lift the Fab Fours bumper into place and insert ½ in. bolts (Ref. Figure 10).**

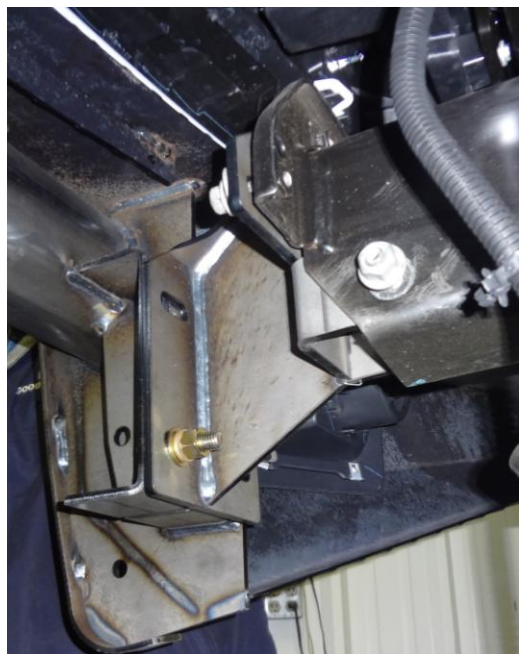

Figure 10





# Installation Instructions

## GMC 1500 BS Front Bumper

Product Number: K3160, K3161, K3162  
Application: '14 GMC 1500

- D. Align the bumper side to side and top to bottom to ensure a perfect fit to the truck. Allow at least 0.375" of clearance to all painted surfaces if possible. This is to allow for frame flex!
- E. Fully tighten all fasteners between bumper and brackets as well as brackets and frame.

**Note: Do Not Over Tighten "Cross Bolt". Frame Should Not Compress!**

- F. Mount lower guard. Align lower guard with top two holes and bolt in place. Bolt in preferred direction (Ref. Figure 11a-b).



Figure 11a

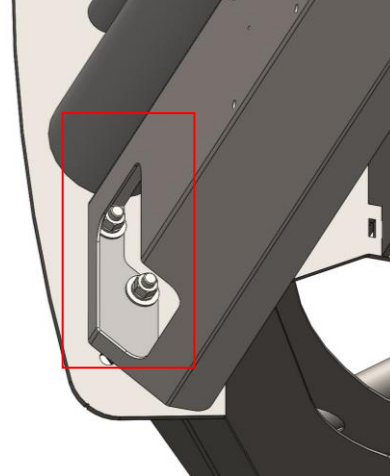

Figure 11b

- G. Reconnect OEM electrical harness to truck and test lights.
- H. Enjoy your New Rear Replacement Bumper from Fab Fours!







# Installation Instructions

## GMC 1500 BS Front Bumper

Product Number: K3160, K3161, K3162  
Application: '14 GMC 1500

### *Maintenance/Care*

- Periodically check and tighten all fasteners.
- Stripped, fractured, or bent bolts or nuts need to be replaced.
- After washing of the vehicle make sure to fully dry all surfaces



**More than expected... Better than expected**

Figure 8c

