



# Installation Instructions

## 2019 CHEVY 1500 Truck Grumper

Product Number: GR4000  
Application: '19 CHEVY 1500

---

## SAFETY

---

**Your safety and the safety of others is very important.**

- In order to help you make informed decisions about safety, we have provided installation instructions and other information.
- These instructions alert you to potential hazards that could hurt you or others.
- Please do a job safety analysis (JSA) before each task to identify potential hazards for your situation and remove/protect against them.
- You must use your own good judgment, and take your time.

**THIS PRODUCT IS FOR OFFROAD USE ONLY. ALL LIABILITY FOR  
INSTALLATION AND USE RESTS WITH THE OWNER.**

**CARELESS INSTALLATION AND OPERATION CAN RESULT IN SERIOUS INJURY  
OR EQUIPMENT DAMAGE.**

**SENSORS FIELD OF VIEW WILL BE ALTERED WITH USE OF THE  
REPLACEMENT BUMPER**

---

## Injury hazard

---

**Failure to observe these instructions could lead to severe injury or death.**

- Always remove jewelry and wear eye protection.
- Always use extreme caution when jacking up a vehicle for work. Set emergency brake and use tire blocks. Locate and use the vehicle manufacturers designated lifting points. Use jack stands.
- Always use appropriate and adequate care in lifting components into place.
- Always insure components will remain secure during installation and operation.
- Always wear safety glasses when installing this kit. A drilling operation will cause flying metal chips. Flying chips can cause serious eye injury.
- Always use extreme caution when drilling on a vehicle. Thoroughly inspect the area to be drilled (on both sides of material) prior to drilling, and relocate any objects that may be damaged.
- Always use extreme caution when cutting and trimming during fitting.
- Always tighten all nuts and bolts securely per installation instructions.
- Always route electrical cables carefully. Avoid moving parts, components that become hot and rough or sharp edges.
- Always insulate and protect all exposed wiring and electrical terminals.
- Always perform regular inspections and maintenance on mounts and related hardware.





# Installation Instructions

## 2019 CHEVY 1500 Truck Grumper

Product Number: GR4000

Application: '19 CHEVY 1500

### I. Overview

Congratulations on your new purchase of the industries' best and most stylish Truck Grumper available for the 19 Chevy 1500! This Truck Grumper has been engineered for strength while keeping the weight down.

Your Front Bumper designed in 3-D from digitized data, CNC laser cut, fabricated, and powder coated... all in the U.S.A.

Enjoy the fit and finish of a quality Chevy 1500 Grumper from Fab Fours Inc.





# Installation Instructions

## 2019 CHEVY 1500 Truck Grumper

Product Number: GR4000  
Application: '19 CHEVY 1500

### II. Removal of OEM Bumper

**Note: Save all OEM parts until installation is complete!**

- A. Open the hood and locate the hood latch release lever. Remove the plastic extension that is attached with (2) Torx screws as shown in (Figures 1a & 1b)



Figure 1a



Figure 1b

- B. Locate the push pins on radiator cover shown below with the triangles. Using a flat head screw driver or body panel tool, pull the head of the push pins up, remove push pin and lift radiator cover off. (Ref. Figure 2).

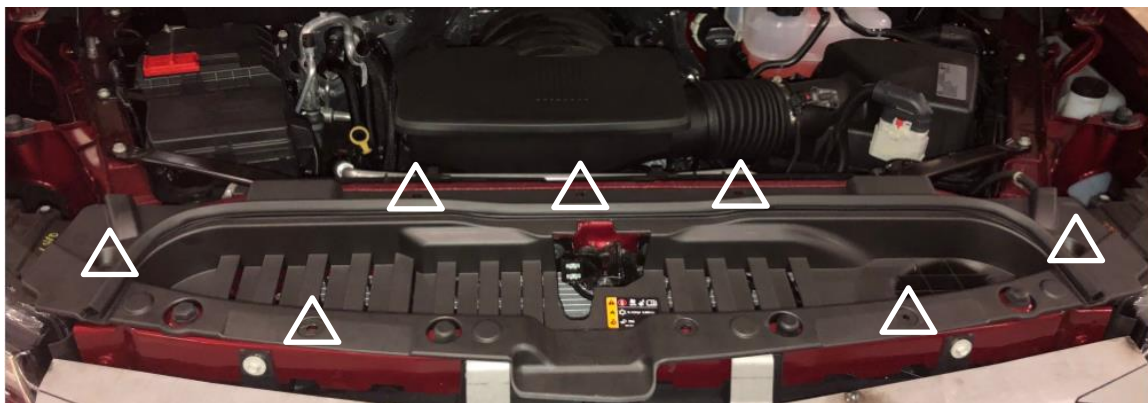

Figure 2





# Installation Instructions

## 2019 CHEVY 1500 Truck Grumper

Product Number: GR4000  
Application: '19 CHEVY 1500

- B. Disassemble the OEM grille by removing the (4) bolts across the top of the grille shell shown in (Figure 3) with the triangles. Then firmly pull outward on the front of the grille shell working from one side to the other.



Figure 3

- C. Disconnect the electrical connector on the passenger's side of the bumper (Ref. Figure 4) by pulling on the red tab and depressing the locking clip.



Figure 4





# Installation Instructions

## 2019 CHEVY 1500 Truck Grumper

Product Number: GR4000  
Application: '19 CHEVY 1500

- D. Locate and remove the (2) bolts per side holding the intermediate bumper brackets to the bumper as shown in (Figure 5a). Then remove the (2) bolts per side holding the outer bumper reinforcement bars to the frame (Ref. Figure 5b). With the bumper removed from the vehicle remove the intermediate brackets from the frame by removing the (3) bolts per side. (Ref. Figure 5c)



Figure 5a



Figure 5b

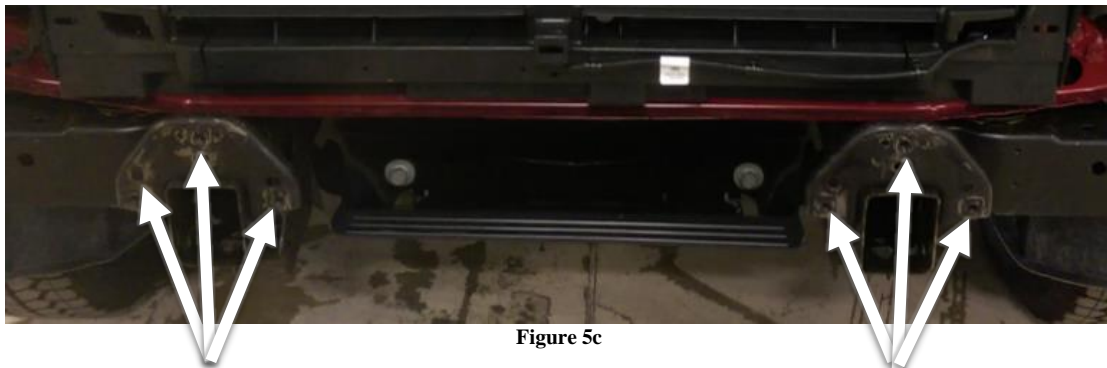

Figure 5c





# Installation Instructions

## 2019 CHEVY 1500 Truck Grumper

Product Number: GR4000  
Application: '19 CHEVY 1500

- E. Remove the (2) bolts attaching the lower portion of the bumper to the underside of the frame rails as shown in Figure 6.

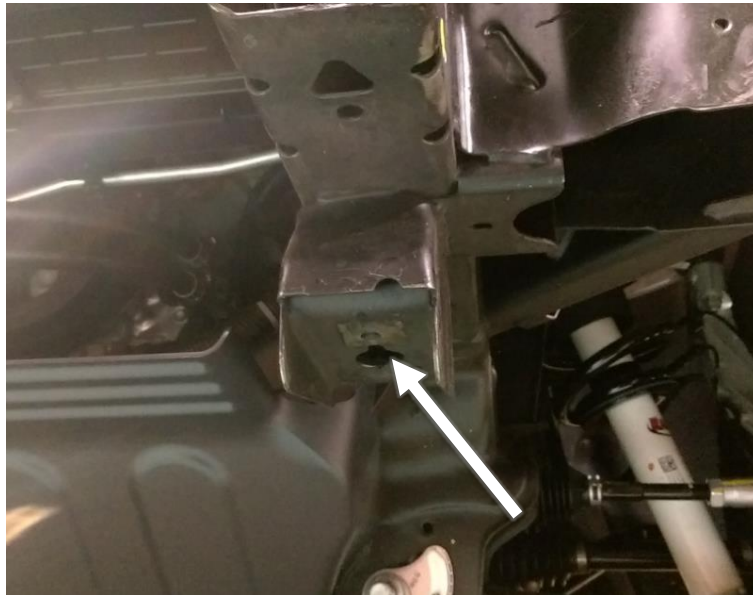

Figure 6

- F. Remove OEM electrical harness from bumper by removing the push pins. Disconnect harness from fog lights and sensors. Remove the sensor units from the bumper by removing the sensor from the insert, then the insert can be removed. (Ref. Figure 7a & 7b).

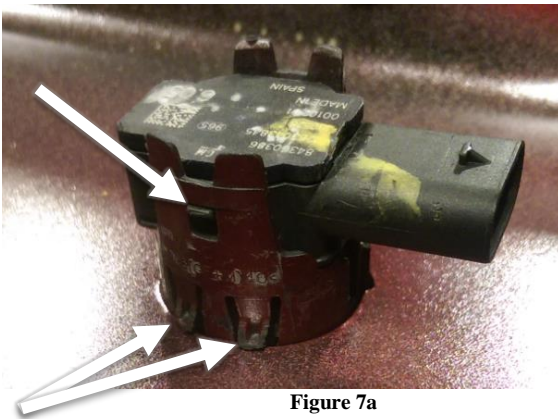

Figure 7a



Figure 7b

**PLEASE NOTE PARKING SENSORS ARE EXTREMELY DELICATE AND MUST BE HANDLED WITH CARE! DO NOT PUSH ON FACE OF SENSORS TO REMOVE!!!**





# Installation Instructions

## 2019 CHEVY 1500 Truck Grumper

Product Number: GR4000  
Application: '19 CHEVY 1500

- G. The OEM grille will need to be trimmed to fit the Grumper. First separate the two-bar outer grille section from the larger multi-slat inner structure of the grille. With the two parts separated protect and mark out the cuts to be made to the grille. Start by marking the centerline of the outer grille section and measuring out 22" in either direction and make a vertical line. When cutting the outer section, cut straight back from the front plane of the vehicle rather than perpendicular to the grille face to allow more clearance for installation. (Ref. Figure 8a) Next, mark and trim the inner structure at the ends as shown in Figure 8b. Only the outer most two tabs on each side need to be retained. The finished grille is shown in Figure 8c.



Figure 8a

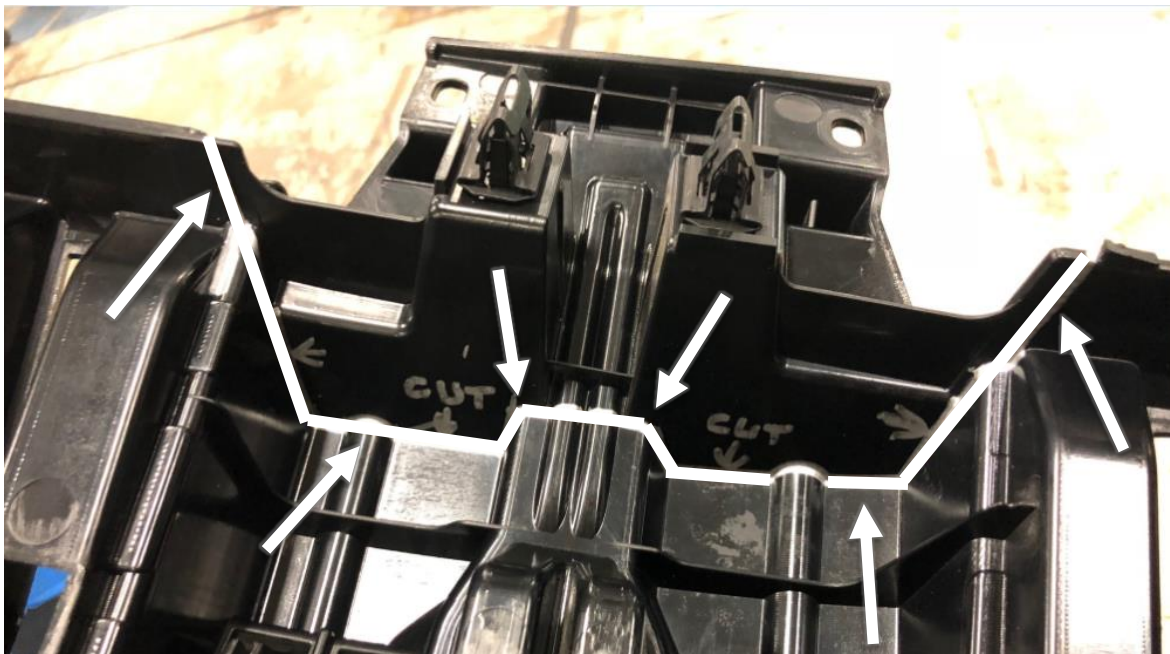

Figure 8b





# Installation Instructions

## 2019 CHEVY 1500 Truck Grumper

Product Number: GR4000

Application: '19 CHEVY 1500



Figure 8c

### III. Pre-Installation

**NOTE:** The Following Installation steps apply to the installation of the Grumper. **PLEASE READ THE ENTIRE MANUAL BEFORE ATEMPTING INSTALLATION!** Ignoring these steps will increase your probability of scratching the vehicle during product installation.

- A. Remove the Grumper Parts from the shipping carton. Lay all items out on a blanket to prevent damage to the powder coating.
  - **Optional:** If installing winch into Grumper, do it at this time. Follow the winch manufacturer's instructions for installation. The Fairlead can be installed when the center grill assembly is fastened to the winch tray.

**Note:** Use a tape designed to not damage painted surfaces such as painters' tape to protect any areas of the vehicle that may contact the Fab Fours product during installation.







# Installation Instructions

## 2019 CHEVY 1500 Truck Grumper

Product Number: GR4000  
Application: '19 CHEVY 1500

### IV. Grumper Installation

- A. Loosely install the winch tray to the frame rails using the (12) supplied 7/16"x1.25 bolts and flat washers. Then bolt the winch tray support brackets to the frame horns with the (2) supplied 7/16"x1.25 bolts, flat washers, and lock washers. (Ref Figure 9)



Figure 9



# Installation Instructions

## 2019 CHEVY 1500 Truck Grumper

Product Number: GR4000

Application: '19 CHEVY 1500

- B. Bolt inserts into the center grill section (Figure 10a-b). Place the color skin inside the grille shell, then put the grille box on the color skin and run the 5/16" hardware through the three layers. Use the rubber sealing washers on the exterior face of the grille shell. Stack a flat washer, lock washer, and nut on the inside. Also install (2) two of the 5/16" sets through the two holes on each side of the grille shell as shown with the arrows. (Figure 10b) Attach the mesh pieces to the rear of the grille boxes with the 3/8" Yellow Zinc hardware. Install the sensor housings in the provided holes. **DO NOT EPOXY AT THIS TIME!!!** Push the sensors into their housings and attach the wiring harness to each sensor.

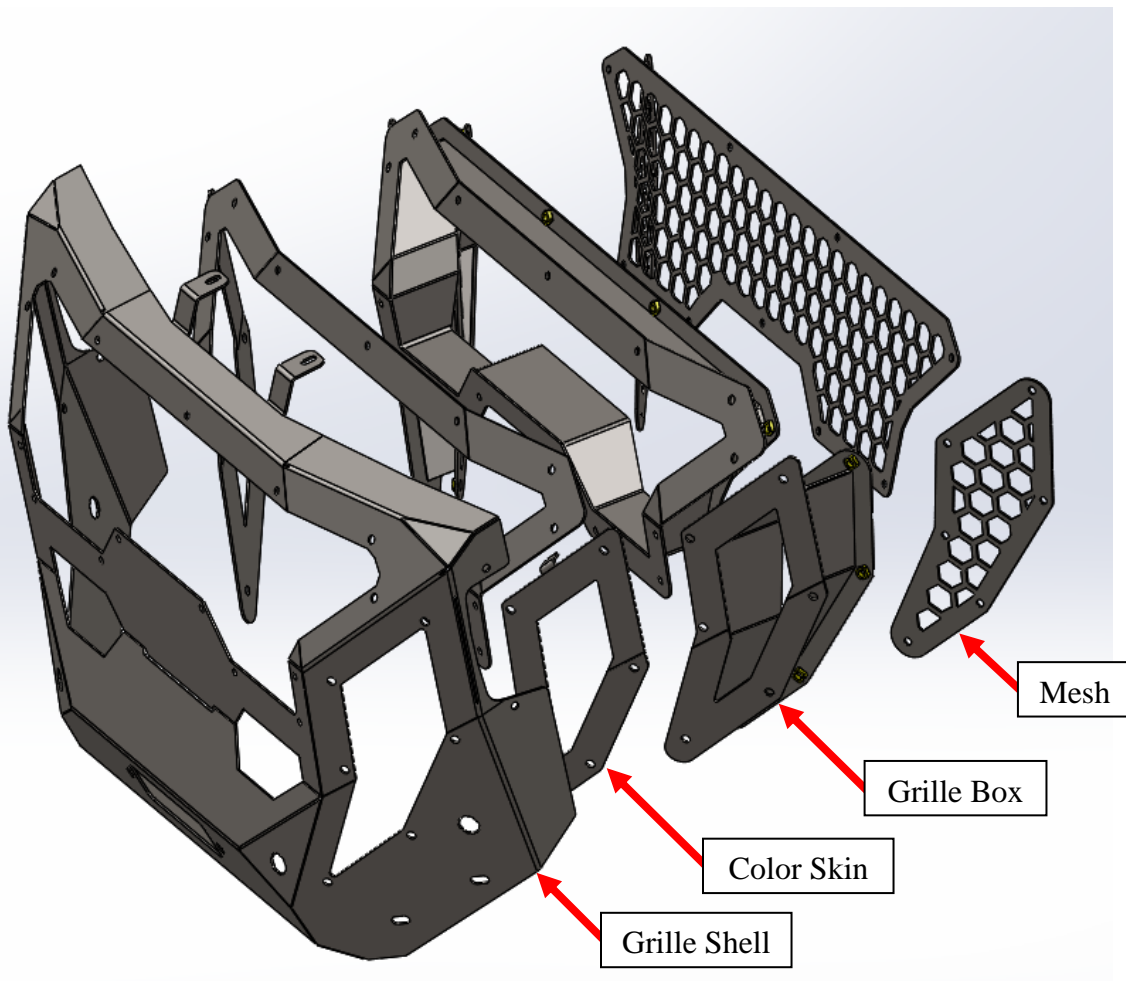

Figure 10a



# Installation Instructions

## 2019 CHEVY 1500 Truck Grumper

Product Number: GR4000

Application: '19 CHEVY 1500



Figure 10b

- C. Install the center grill section onto the truck (Figure 11a-b). Secure it to the two brackets to the core support with the OEM grille mounting hardware. Fasten the center section to the winch tray with the 7/16" stainless button head screws. If you have a winch, the fairlead should be attached at this time using the bolts provided with the winch. Adjust the center section so that it's centered on the truck and at the correct height and tighten all fasteners. Connect the sensor wiring harness to the harness to the truck.

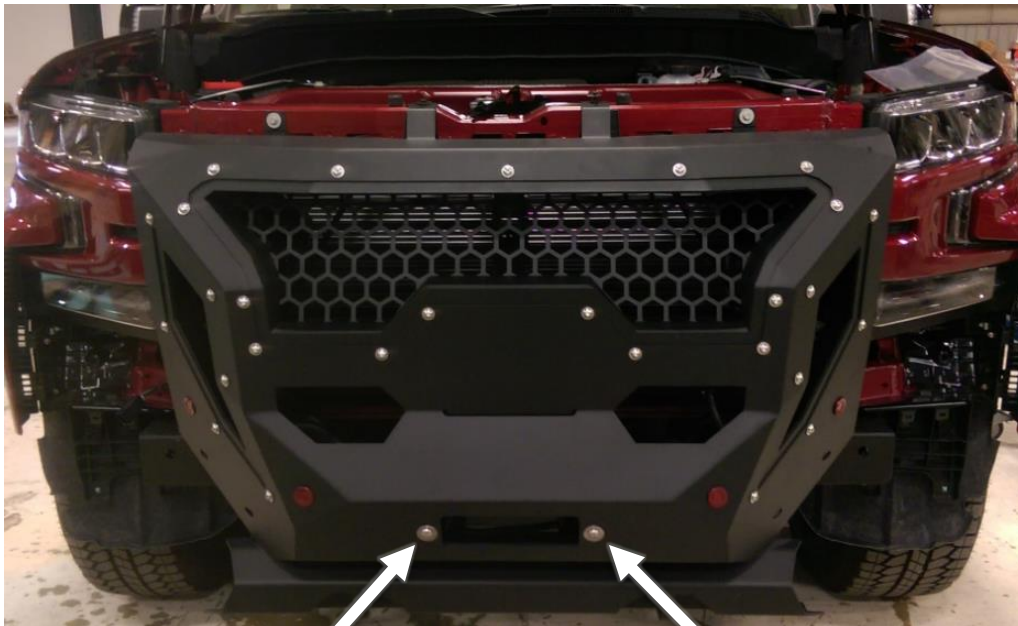

Figure 11a





# Installation Instructions

## 2019 CHEVY 1500 Truck Grumper

Product Number: GR4000

Application: '19 CHEVY 1500

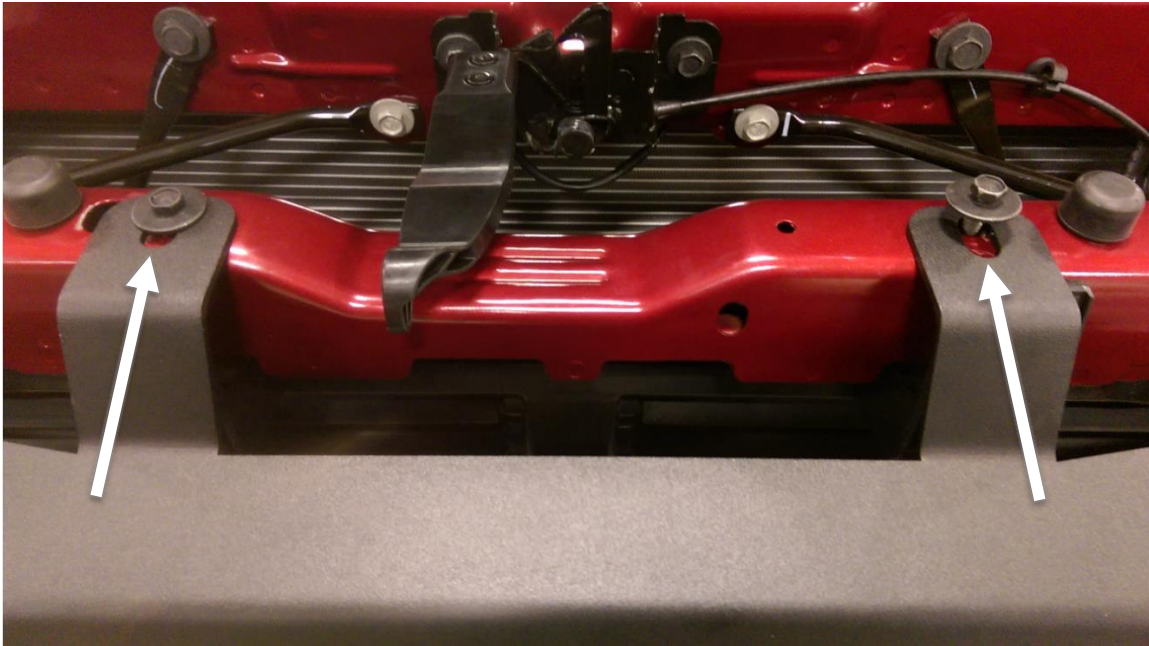

Figure 11b

- D. Install wings using the eight provided  $3/8"$  x  $1"$  bolts (Figure 12a-c). Each wing will attach to the center section with two bolts and to the winch tray with two bolts.

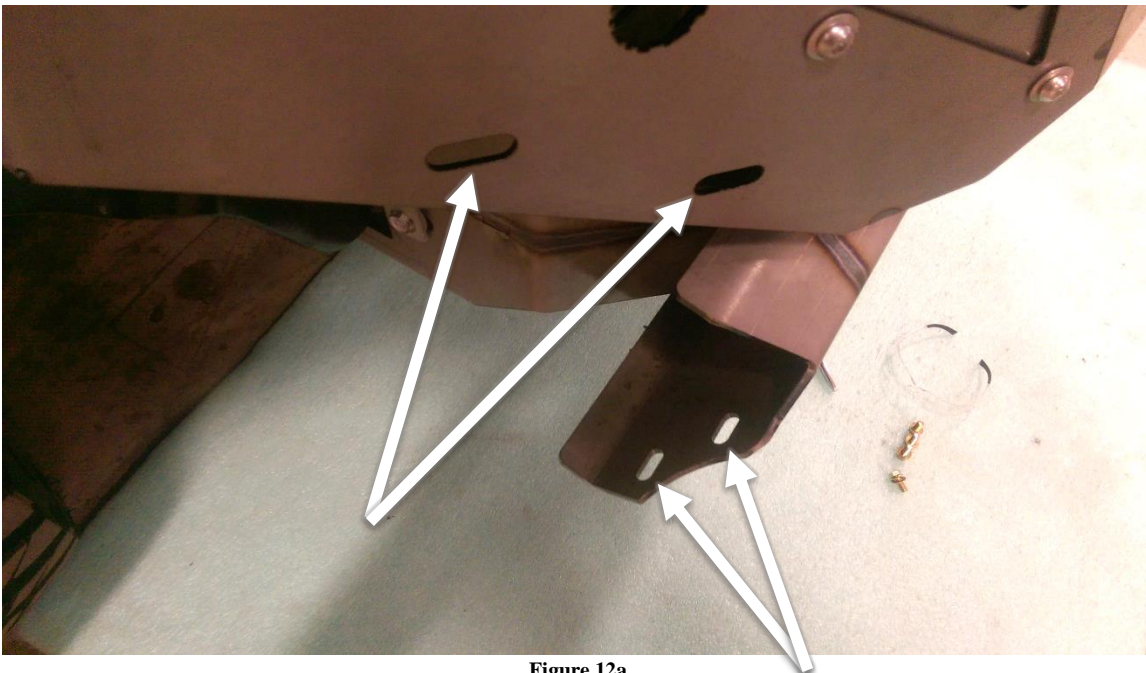

Figure 12a





# Installation Instructions

## 2019 CHEVY 1500 Truck Grumper

Product Number: GR4000

Application: '19 CHEVY 1500



Figure 12b

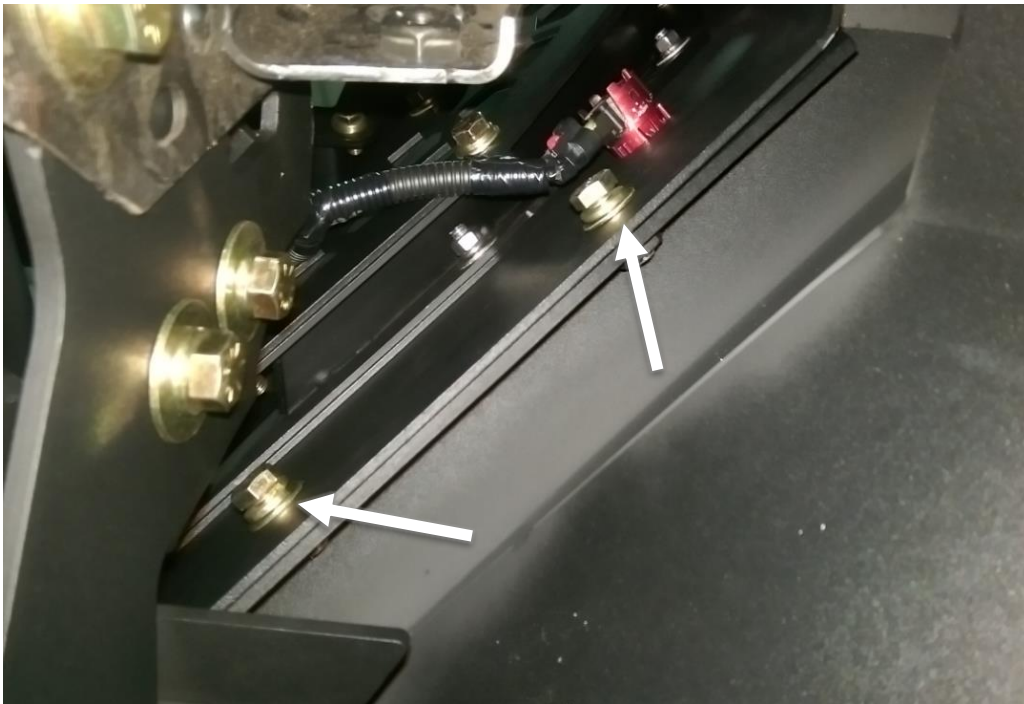

Figure 12c





## Installation Instructions 2019 CHEVY 1500 Truck Grumper

Product Number: GR4000  
Application: '19 CHEVY 1500

- E. Install Wing Stiffeners using the 3/8" x 1.25" hardware at the wing and the (2) OEM bumper support bolts at the frame. (Ref. Figure 13).



Figure 13

- F. *Reinstall the OEM hood latch extension.*
- G. *After ensuring sensors work in current orientation, epoxy should be applied to the housing on inside of bumper and allowed to dry.*
- H. *Align the bumper side to side and top to bottom to ensure a perfect fit to the truck. Allow greater than 1/4" of clearance to all painted surfaces if possible. This is to allow for frame flex!*
- I. *Fully tighten all fasteners between bumper and brackets as well as brackets and frame.*
- J. *Remove adhesive covering on Fab fours logo, center with grille, align with cutout in center of the grille and apply with firm pressure for 30 seconds.*

**Enjoy your new Grumper from Fab Fours!**





# Installation Instructions

## 2019 CHEVY 1500 Truck Grumper

Product Number: GR4000  
Application: '19 CHEVY 1500

### ***Maintenance/Care***

- Periodically check and tighten all fasteners.
- Stripped, fractured, or bent bolts or nuts need to be replaced.
- After washing of the vehicle make sure to fully dry all surfaces



**More than expected... Better than expected**



Discover other off-road bumpers on our website.