



# Installation Instructions

## '16-'18 Chevy HD Truck Grumper

Product Number: GR3000

Application: '16-'18 CHEVY HD

### SAFETY

**Your safety and the safety of others is very important.**

- In order to help you make informed decisions about safety, we have provided installation instructions and other information.
- These instructions alert you to potential hazards that could hurt you or others.
- Please do a job safety analysis (JSA) before each task to identify potential hazards for your situation and remove/protect against them.
- You must use your own good judgment, and take your time.

Read and understand all safety precautions and instructions before installing this product.

**THIS PRODUCT IS FOR OFFROAD USE ONLY. ALL LIABILITY FOR INSTALLATION AND USE RESTS WITH THE OWNER.**

**CARELESS INSTALLATION AND OPERATION CAN RESULT IN SERIOUS INJURY OR EQUIPMENT DAMAGE.**

### Injury hazard

**Failure to observe these instructions could lead to severe injury or death.**

- Always remove jewelry and wear eye protection.
- Always use extreme caution when jacking up a vehicle for work. Set emergency brake and use tire blocks. Locate and use the vehicle manufacturers designated lifting points. Use jack stands.
- Always use appropriate and adequate care in lifting components into place.
- Always insure components will remain secure during installation and operation.
- Always wear safety glasses when installing this kit. A drilling operation will cause flying metal chips. Flying chips can cause serious eye injury.
- Always use extreme caution when drilling on a vehicle. Thoroughly inspect the area to be drilled (on both sides of material) prior to drilling, and relocate any objects that may be damaged.
- Always use extreme caution when cutting and trimming during fitting.
- Always tighten all nuts and bolts securely per installation instructions.
- Always route electrical cables carefully. Avoid moving parts, components that become hot and rough or sharp edges.
- Always insulate and protect all exposed wiring and electrical terminals.
- Always perform regular inspections and maintenance on mounts and related hardware.





# Installation Instructions

## '16-'18 Chevy HD Truck Grumper

Product Number: GR3000

Application: '16-'18 CHEVY HD

### I. Overview

Congratulations on your new purchase of the industries' best and most stylish Truck Grumper available for the 2016-2018 Chevy Heavy Duty! This Truck Grumper has been engineered for strength while keeping the weight down.

Your Front Bumper designed in 3-D from digitized data, CNC laser cut, fabricated, and powder coated... all in the U.S.A.

Enjoy the fit and finish of a quality Chevy HD Grumper from Fab Fours Inc.





# Installation Instructions

## '16-'18 Chevy HD Truck Grumper

Product Number: GR3000

Application: '16-'18 CHEVY HD

### Parts List

- GR3000 Truck Grumper
- GR3000 Mounting Brackets (21465 qty. 2)
- 50124-HW fastener kit
- Installation Manual

## II. Removal of OEM Bumper

**Note: Save all OEM parts until installation is complete!**

- A. Open hood and locate push pins on radiator cover. Using a flat head screw driver, pull the head of the push pins up, remove push pin and lift radiator cover off. This will allow access to top Grille bolts (Ref. Figure 1).



Figure 1

- B. Remove the fasteners connecting the grille to the frame. Four bolts, are located at the top of the grille, two on each side (Ref. Figure 2a-b). Two bolts and two clips are located behind the grille and are indicated by the ovals and triangles respectively (Ref. Figure 2c).







# Installation Instructions

## '16-'18 Chevy HD Truck Grumper

Product Number: GR3000

Application: '16-'18 CHEVY HD



Figure 2a



Figure 2b

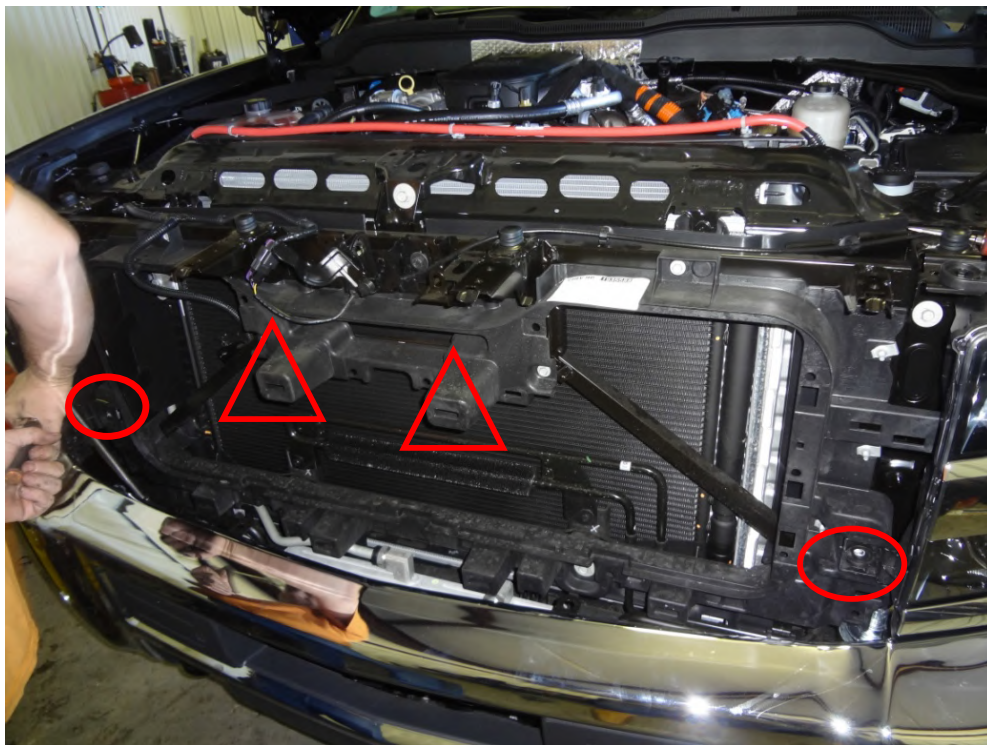

Figure 2c





# Installation Instructions

## '16-'18 Chevy HD Truck Grumper

Product Number: GR3000

Application: '16-'18 CHEVY HD

- C. Disconnect electrical harness (Ref. Figure 3a) from vehicle and remove tow hooks. Tow hooks are mounted with one cross bolt through the side and a bolt through the bottom of the frame (Ref. Figure 3b).



Figure 3a (ELECTRICAL HARNESS DISCONNECTED)



Figure 3b (TOW HOOK & OEM MOUNTING BRACKET)







# Installation Instructions

## '16-'18 Chevy HD Truck Grumper

Product Number: GR3000

Application: '16-'18 CHEVY HD

- D. Remove bolts connecting bumper to mounting bracket. There is one bolt on each side which requires a socket wrench with an extension to easily reach (Ref. Figure 4). Carefully pull bumper away from vehicle.



Figure 4

- E. Remove the fasteners connecting the OEM mounting bracket to the frame. Using a socket/wrench remove bolts from front of bracket connected to the bumper. Repeat process on each side of vehicle.



Figure 5





# Installation Instructions

## '16-'18 Chevy HD Truck Grumper

Product Number: GR3000

Application: '16-'18 CHEVY HD

- F. Remove OEM electrical harness from bumper. Disconnect harness from fog lights and sensors. Unbolt bumper support frames as necessary to more easily access sensors, start with the bottom bolts indicated by squares (Ref. Figure 6). Remove sensors and outer sensor housings for use on the Grumper

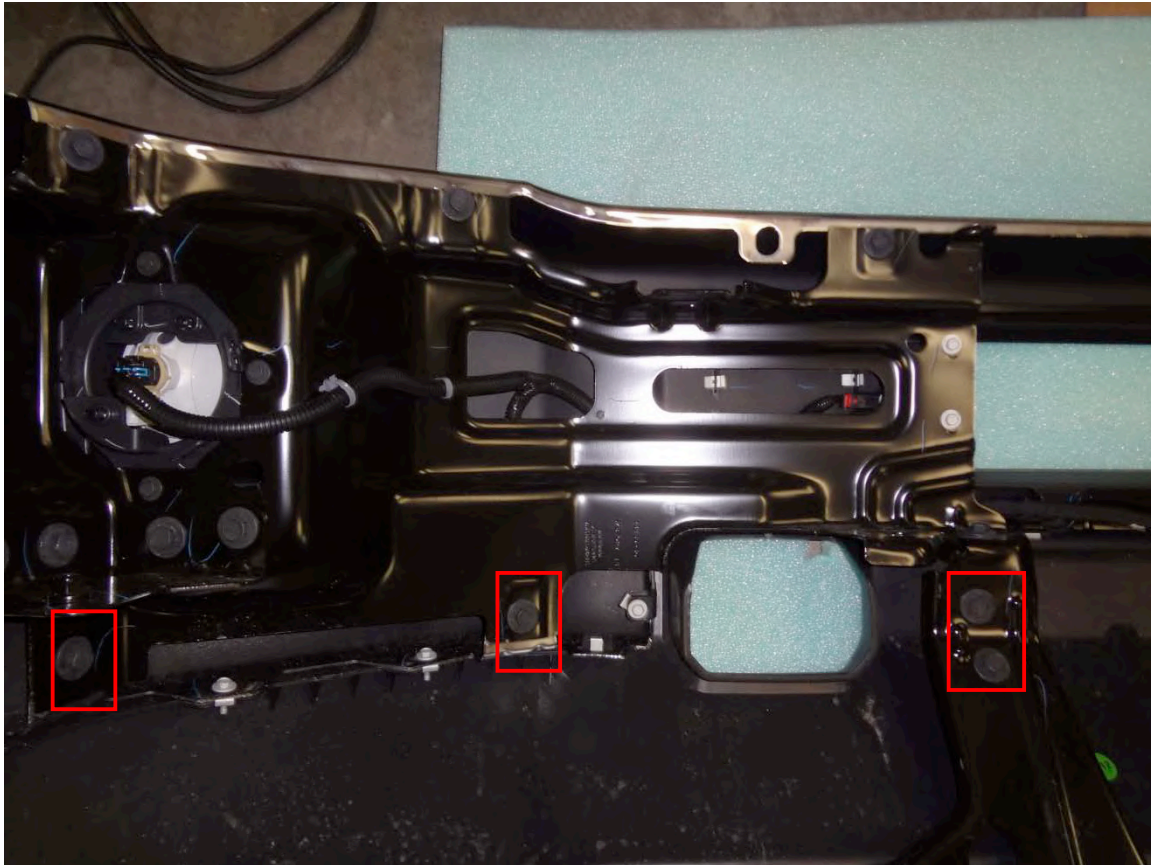

Figure 6

**PLEASE NOTE PARKING SENSORS ARE EXTREMELY DELICATE AND MUST BE HANDLED WITH CARE!**

*Do NOT touch or shift the clear rubber grommet that surrounds the sensor face. DO NOT glue housing into place until orientation and functionality is determined.*





# Installation Instructions

## '16-'18 Chevy HD Truck Grumper

Product Number: GR3000

Application: '16-'18 CHEVY HD

- G. Remove OEM electrical harness from bumper. Disconnect harnesses from fog lights and sensors. Sensors can be disconnected from housing by depressing the plastic clip indicated by the red square (ref. Figure 7).**

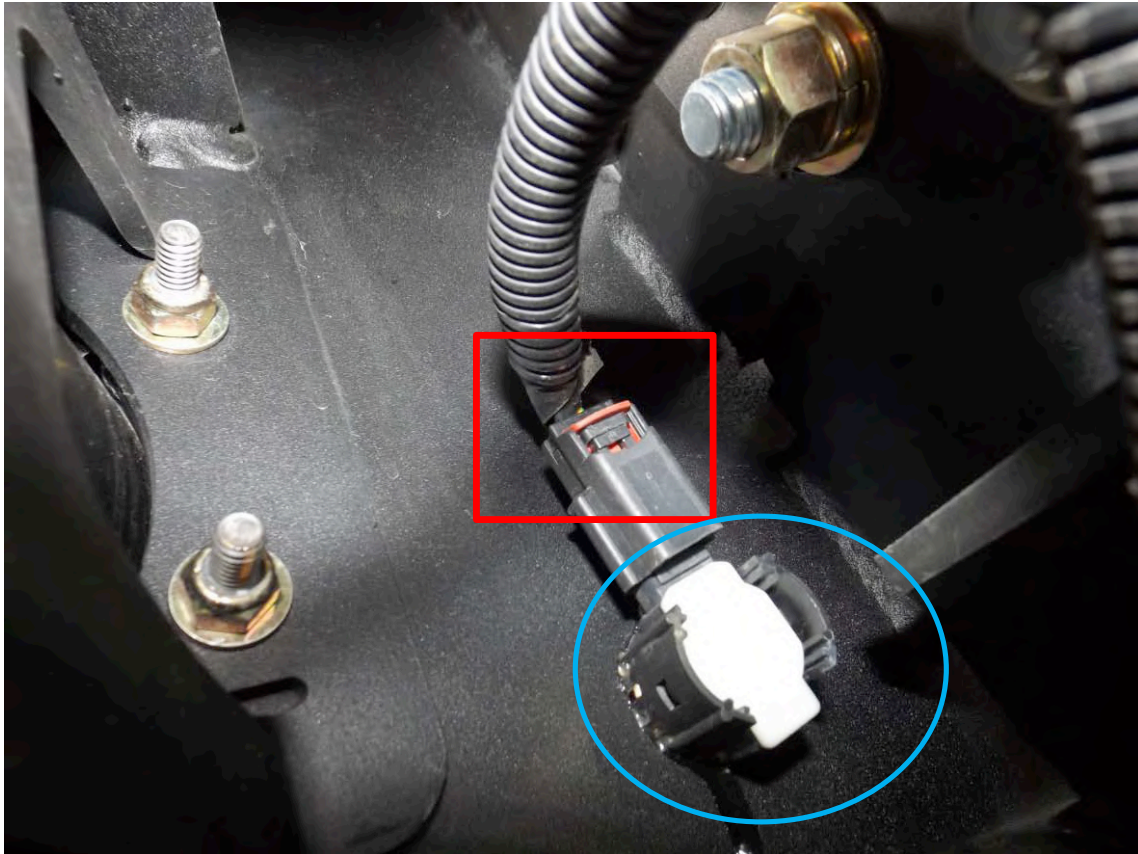

Figure 7

- H. Pop out plastic clips holding harnesses to bumper on both sides and carefully pull away.**
- I. CAREFULLY remove sensors from plastic housing by gently pulling top and bottom tabs, indicated by blue circles (Ref. Figure 7), away as sensor is pulled out. Do not push on front**







# Installation Instructions

## '16-'18 Chevy HD Truck Grumper

Product Number: GR3000

Application: '16-'18 CHEVY HD

of sensor as this will damage the membrane. Place sensors face up in safe location.

- J. Disconnect the hood release by removing 2 bolts (Ref Figure 8). Remove headlights by removing 4 bolts (Ref. Figure 9). One screw will be located under the headlight on the side of the vehicle. Disconnect the wiring harness from each light and lay them aside in a way that won't scratch the clear lens.**

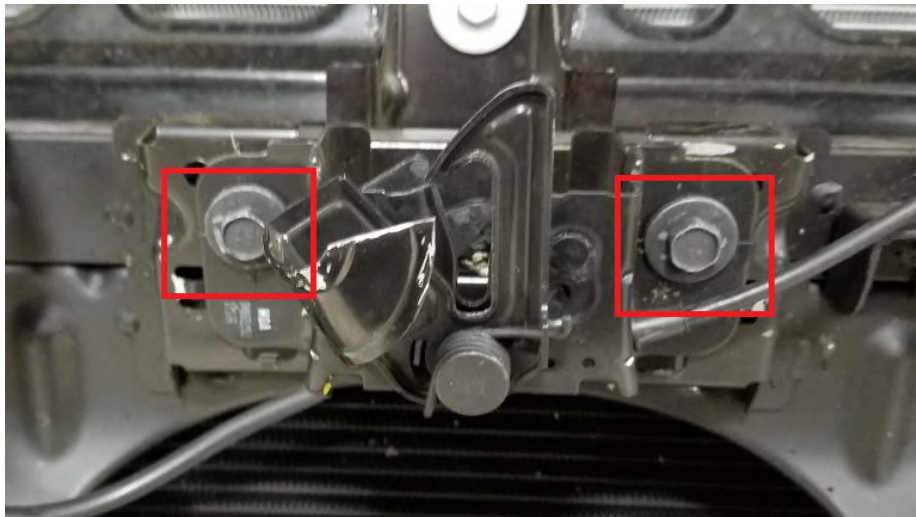

Figure 8



## Installation Instructions '16-'18 Chevy HD Truck Grumper

Product Number: GR3000

Application: '16-'18 CHEVY HD

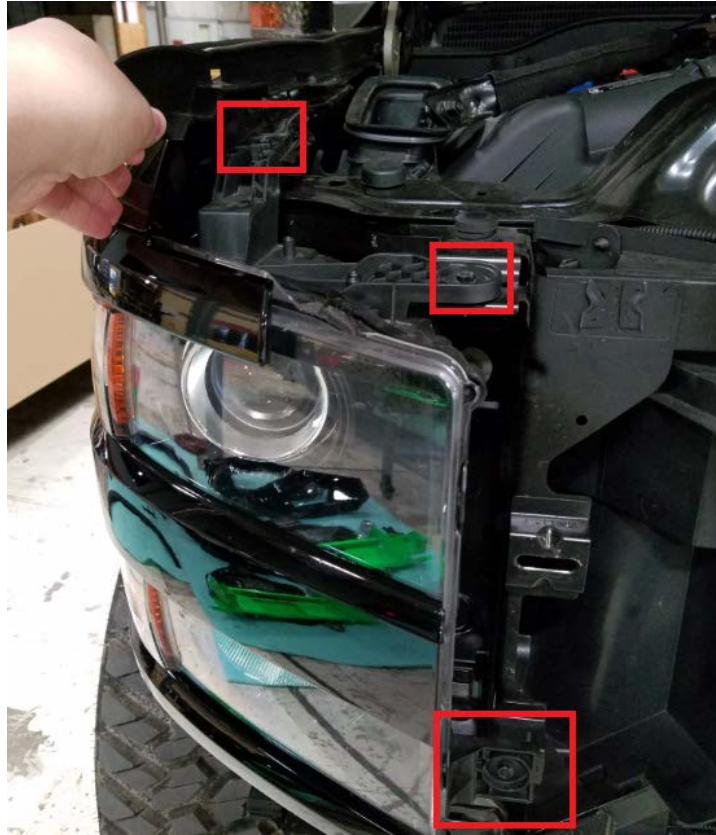

Figure 9

***K. Remove this metal frame from the truck and remove the plastic surround from the metal frame (Figure 10) and keep the hardware for reinstallation. Remove the plastic surround from the metal frame (Indicated by arrow in Figure 10). Cut off all the protrusions on the metal frame (Figure 11). Leave spots for hood stop adjusters. The***





# Installation Instructions

## '16-'18 Chevy HD Truck Grumper

Product Number: GR3000

Application: '16-'18 CHEVY HD

*photos below might appear slightly different between model year trucks.*



Figure 10

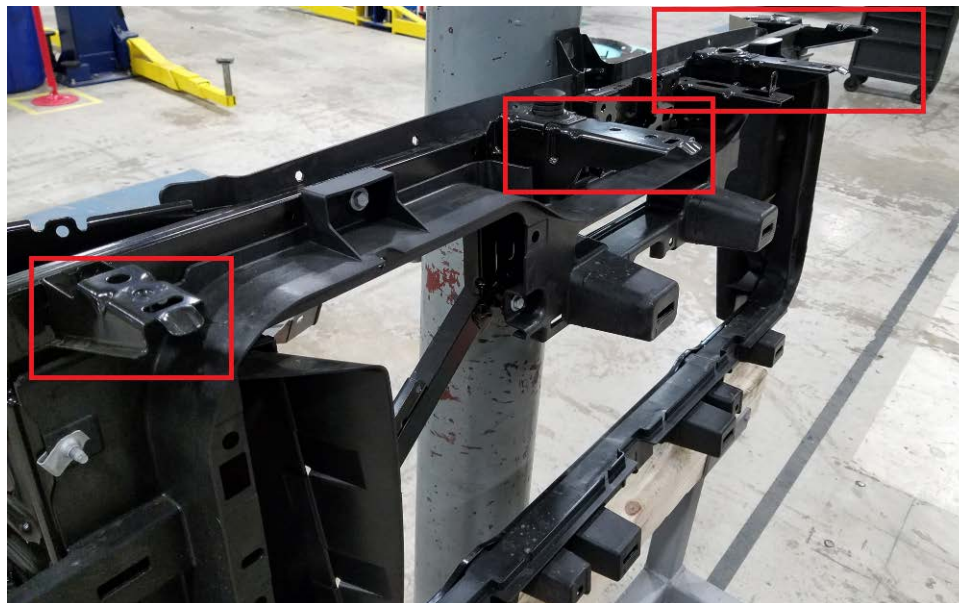

Figure 11

**L. Drill a hole through the hexagonal holes in the metal frame for a 1/4" bolt (figure 12). There may or may not be a**







## Installation Instructions '16-'18 Chevy HD Truck Grumper

Product Number: GR3000

Application: '16-'18 CHEVY HD

*nut embedded in the frame, go ahead and drill through the nut.*

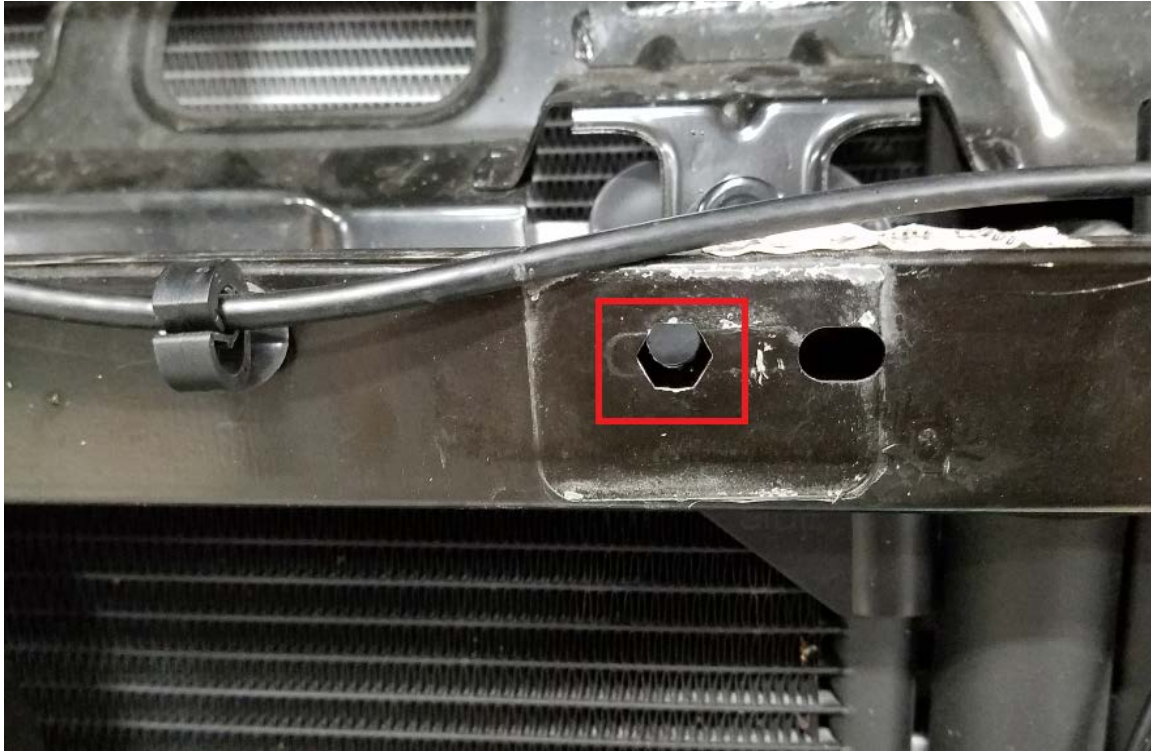

Figure 12

**M. Reattach modified metal frame on truck and reinstall headlights. Reattach the hood release and adjust so that it works properly. The hood release will need to be cut to be able to fit the Grumper on the truck (Figure 13). Cut the hood release about 1" from the surface the horizontal arrow is pointing at. The hood release can be accessed thru the *Grumper center mesh* to raise the hood.**





# Installation Instructions

## '16-'18 Chevy HD Truck Grumper

Product Number: GR3000

Application: '16-'18 CHEVY HD

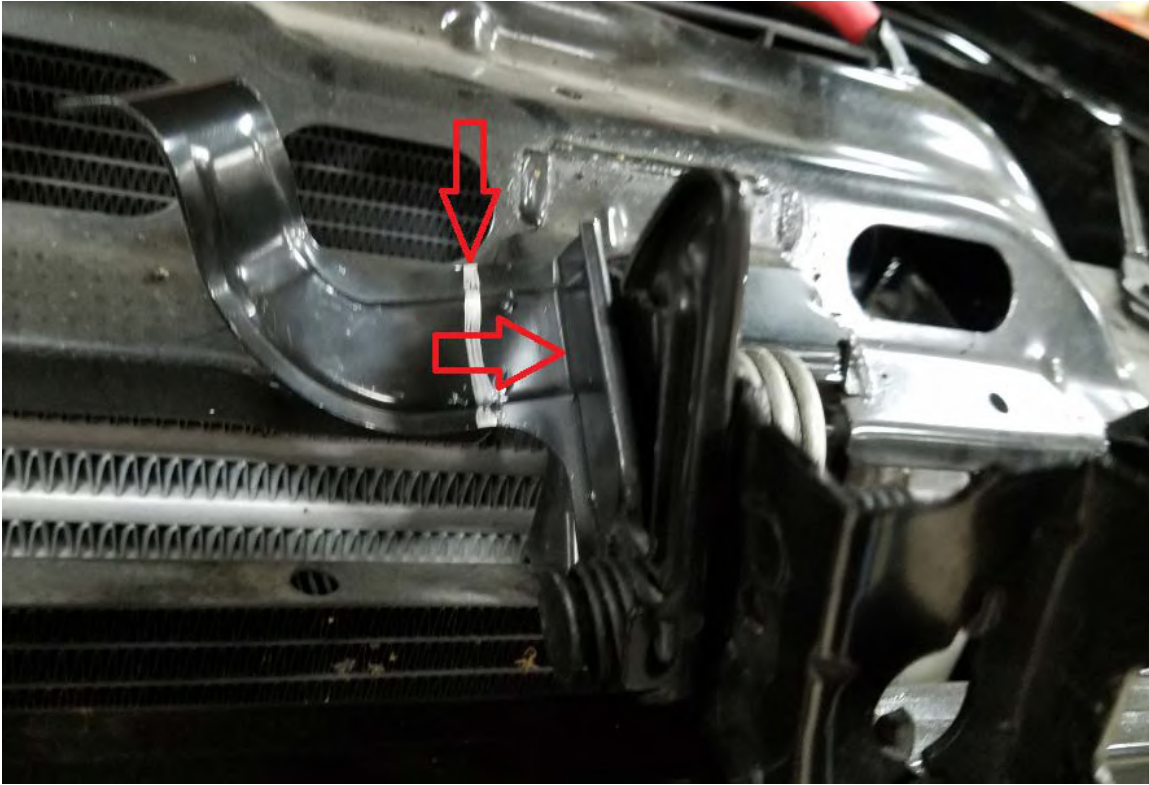

Figure 13

### III. Pre-Installation

**NOTE:** The Following Installation steps apply to the installation of the Front Bumper. **PLEASE READ THE ENTIRE MANUAL BEFORE ATEMPTING INSTALLATION!** Ignoring these steps will increase your probability of scratching the vehicle during product installation.

- A. Remove the Grumper Parts from the shipping carton. Lay all items out on a blanket to prevent damage to the powder coating.
- **Optional:** If installing winch into Grumper, do it at this time. Follow the winch manufacturer's instructions for installation. The Roller Fairlead can be installed when the center grill assembly is fastened to the winch tray.





# Installation Instructions

## '16-'18 Chevy HD Truck Grumper

Product Number: GR3000

Application: '16-'18 CHEVY HD

### IV. Grumper Installation

- A. Mount brackets to truck frame with 3 ½"-13 x 1" bolts. Two bolts pass through the sides of the frame (Figure 14). One bolt passes through the bottom of the frame. If holes on the side of frame are out of tolerance then enlarge hole with 9/16 drill as needed on side of frame.



Figure 14

- B. Center and Mount winch tray to frame of the truck. Use OEM Truck Bumper bolts to fasten winch tray to truck (Figure 15a & b).





# Installation Instructions

## '16-'18 Chevy HD Truck Grumper

Product Number: GR3000

Application: '16-'18 CHEVY HD

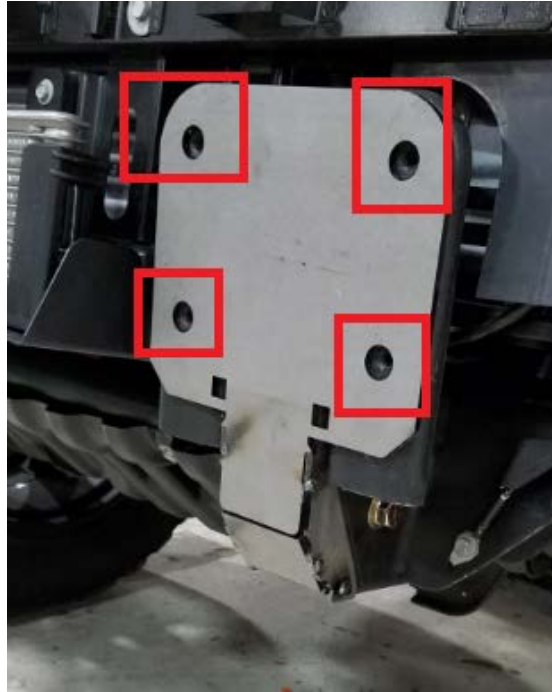

Figure 15a

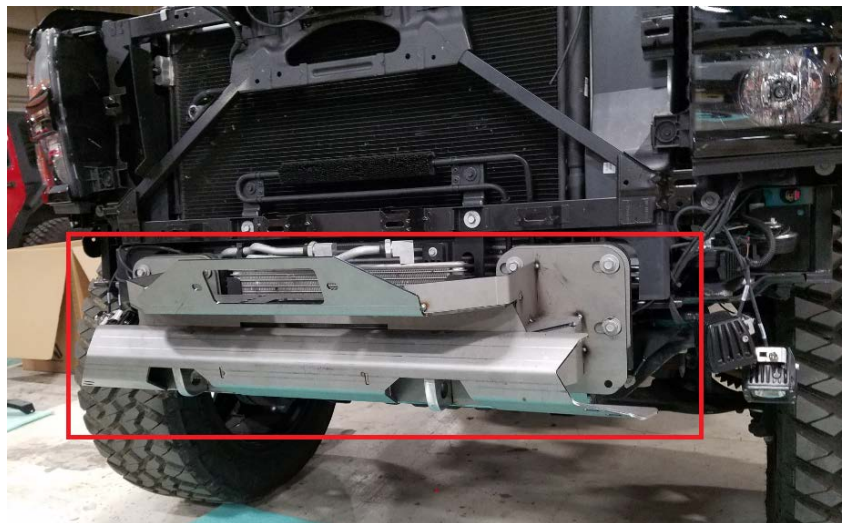

Figure 15b

- C. Install the 2 loose brackets to the metal frame under the hood (Figure 16). Use  $\frac{1}{4}$ " bolt in the hole you drilled out in Step L of the Bumper removal. Leave the bolt loosely tightened for mounting of the center grill section.





# Installation Instructions

## '16-'18 Chevy HD Truck Grumper

Product Number: GR3000

Application: '16-'18 CHEVY HD

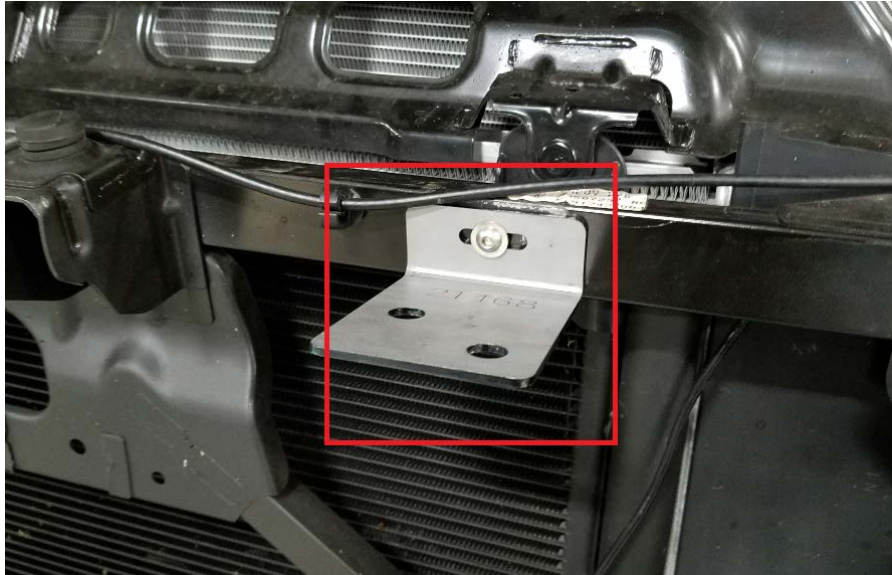

Figure 16

- D. Bolt inserts into the center grill section (Figure 17). Attach the inserts to the center grill using 5/16" Stainless Steel Button head screws, washers, and nuts. Attach the mesh pieces with 3/8" Yellow Zinc Hex Head bolts. Install the sensor housings in the provided holes. Do not Epoxy at this time. Use the OEM outer sensor housings and provided inner sensor housing in the same position as the OEM bumper. Push the sensors into the housings and attach the wiring harness to each sensor.

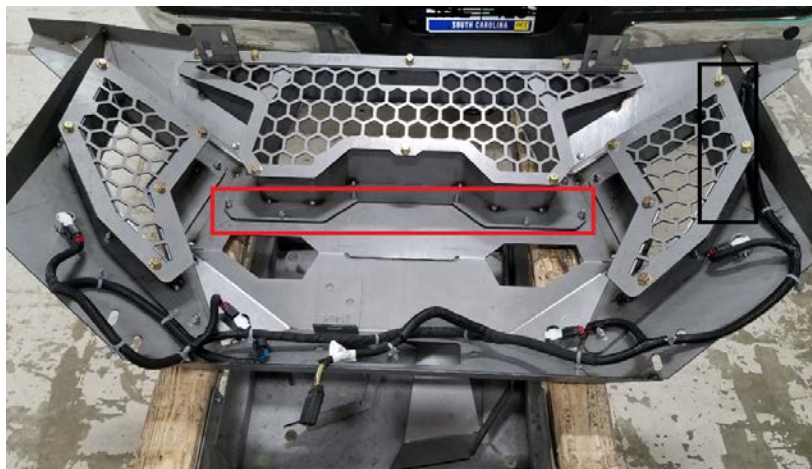

Figure 17





# Installation Instructions

## '16-'18 Chevy HD Truck Grumper

Product Number: GR3000

Application: '16-'18 CHEVY HD

**E. Install the center grill section onto the truck (Figure 18a & b). Secure it to the 2 brackets under the hood with 3/8" x .75" bolts. Fasten the center section to the winch tray with the 7/16" stainless button head screws. If you have a winch, the fairlead should be attached at this time using the bolts provided with the winch. Adjust the center section so that it's centered on the truck and at the correct height and tighten all fasteners. Connect the sensor wiring harness to the harness on the truck.**

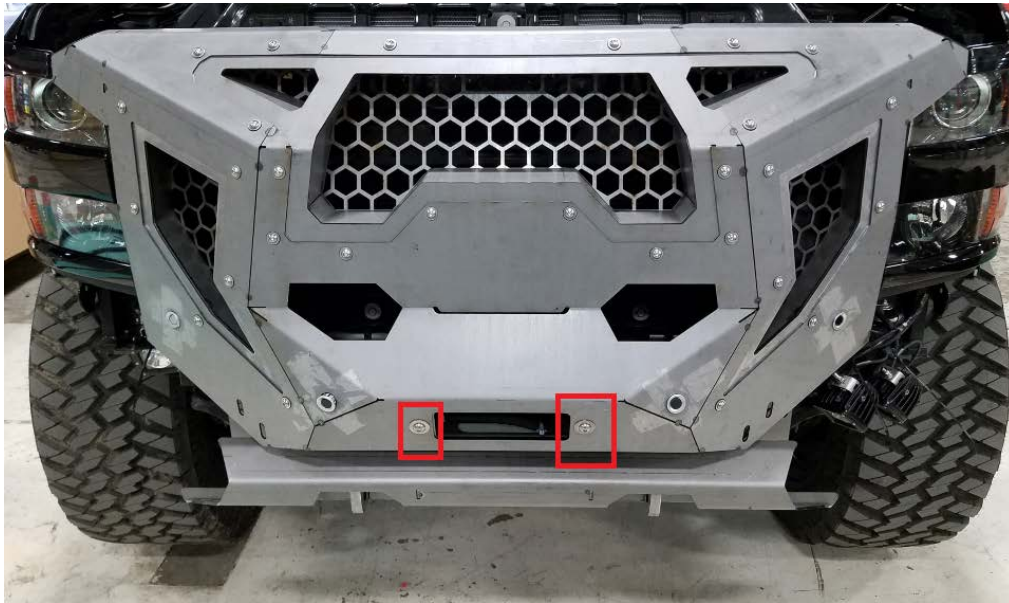

Figure 18a





# Installation Instructions

## '16-'18 Chevy HD Truck Grumper

Product Number: GR3000

Application: '16-'18 CHEVY HD

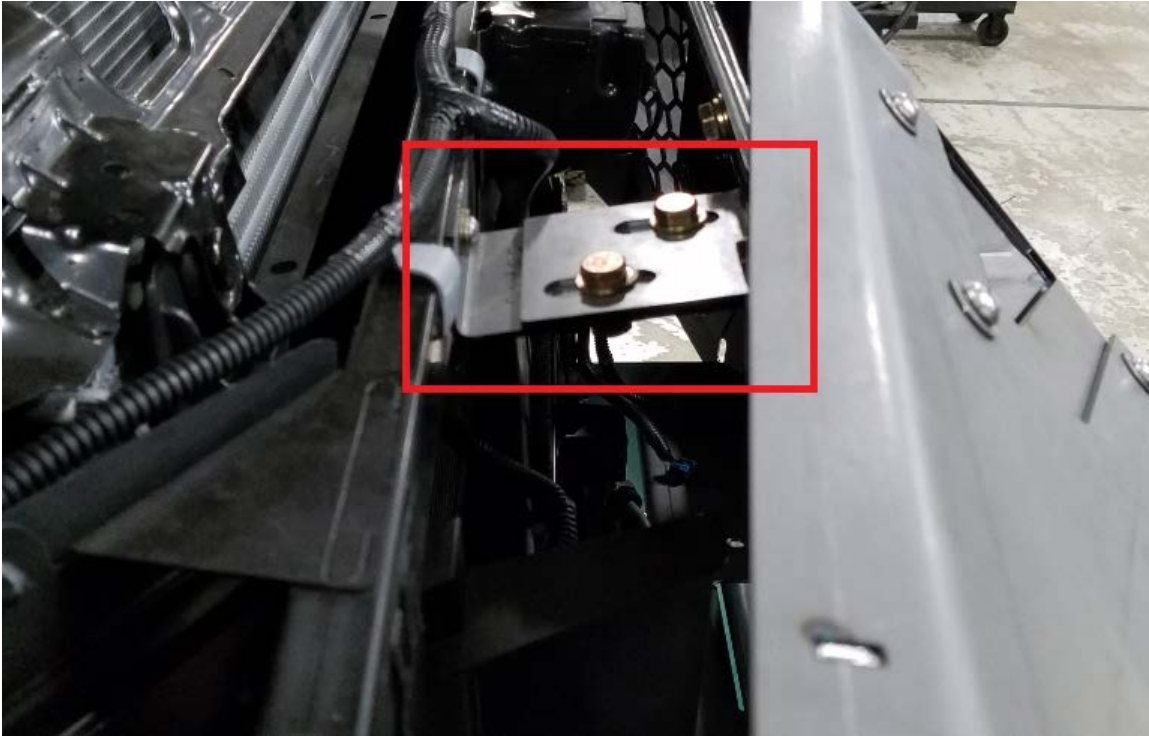

Figure 18b

- F. Install Wings using 3/8" x 1" (Qty 8) bolts (Figure 19a & b). Each wing will attach to the center section with 2 bolts and to the winch tray with 2 bolts

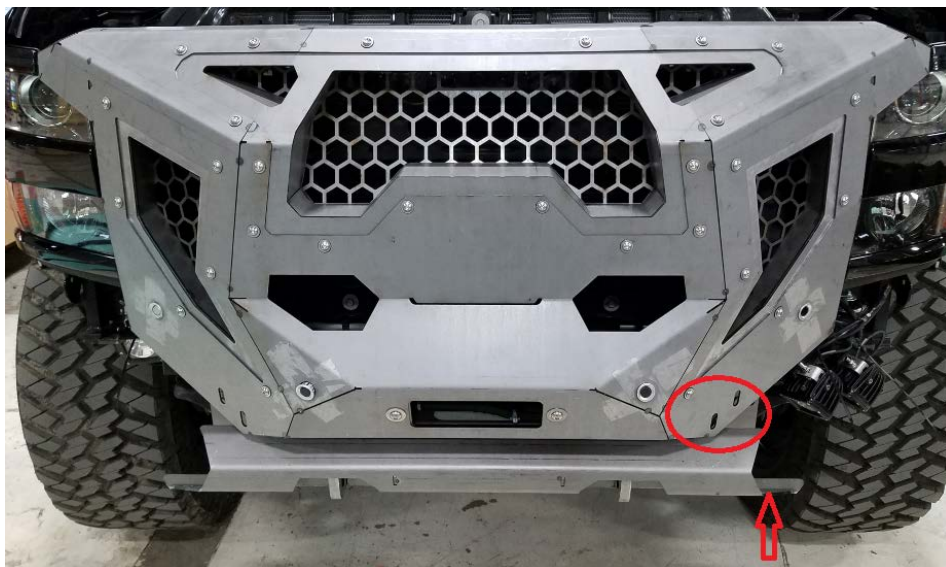

Figure 19a





# Installation Instructions

## '16-'18 Chevy HD Truck Grumper

Product Number: GR3000

Application: '16-'18 CHEVY HD



Figure 19b

- G. Install Wing Stiffeners using 3/8" x 1.25" (Qty 4) bolts and nuts (Figure 20a & b). The stiffener will attach to the winch tray mount with 1 bolt and to the back of the wing with 1 bolt.





# Installation Instructions

## '16-'18 Chevy HD Truck Grumper

Product Number: GR3000

Application: '16-'18 CHEVY HD



Figure 20a



Figure 20b

H. **After ensuring sensors work in current orientation, epoxy should be applied to the housing on inside of bumper and allowed to dry.**

I. **Align the bumper side to side and top to bottom to ensure a perfect fit to the truck. Allow greater than 1/4" of clearance to all painted surfaces if possible. This is to allow for frame flex!**







## Installation Instructions

### '16-'18 Chevy HD Truck Grumper

Product Number: GR3000

Application: '16-'18 CHEVY HD

- J. *Fully tighten all fasteners between bumper and brackets as well as brackets and frame.*
  
- K. **Enjoy your New Front Replacement Bumper from Fab Fours!**





# Installation Instructions

## '16-'18 Chevy HD Truck Grumper

Product Number: GR3000

Application: '16-'18 CHEVY HD

### ***Maintenance/Care***

- Periodically check and tighten all fasteners.
- Stripped, fractured, or bent bolts or nuts need to be replaced.
- After washing of the vehicle make sure to fully dry all surfaces



**More than expected... Better than expected**

