



INSTALLATION MANUAL
BLACK STEEL FRONT BUMPER
PRODUCT NUMBER: S506X & Q506X
APPLICATION: 2020 GMC HD



IMPORTANT SAFETY GUIDE | Your safety and the safety of others is very important.

In order to help you make informed decisions about safety, we have provided the following warnings, safety precautions, installation instructions, and other important information to alert you to potential hazards that could hurt you or others.

Please do a job safety analysis before each task to identify potential hazards for your situation and remove/protect against them. Use own good judgment and take your time.

Check packaged materials immediately upon arrival to ensure that all listed parts are included and undamaged.

Read and understand all warnings, safety precautions, and instructions before installing this product.

SENSORS FIELD OF VIEW MAY BE ALTERED WITH USE OF THE REPLACEMENT BUMPER.

WARNINGS

- Failure to observe the following warnings and instructions provided in this manual could lead to severe injury and/or death.
- For professional installation only. Careless installation and/or operation can result in serious injury, death, and/or equipment damage. All liability for installation and use rests with the user or consumer.
- Fab Fours, Inc. only approves installing this product according to these written instructions with the hardware provided. Failure to install according to these instructions will invalidate the warranty. This includes, but is not limited to, using alternative installation methods, hardware, or materials.
- This product is for off road use only.

SAFETY PRECAUTIONS

- Always remove jewelry and wear eye protection.
- Always use extreme caution when jacking up a vehicle for work. Set emergency brake and use tire blocks. Locate and use the vehicle manufacturers designated lifting points. Use jack stands.
- Always use appropriate and adequate care in lifting components into place.
- Always ensure components will remain secure during installation and operation.
- Always wear safety glasses when installing this kit. A drilling operation will cause flying metal chips. Flying chips can cause serious eye injury.
- Always use extreme caution when drilling a vehicle. Always disconnect power before welding. Thoroughly inspect the area to be drilled (on both sides of material when possible) prior to drilling, and relocate any objects that may be damaged.
- Always use extreme caution when welding a vehicle. Thoroughly inspect the area to be welded (on both sides of material when possible) prior to welding, and relocate any objects that may be a fire hazard. When welding in a cab, make sure the interior surfaces are covered (e.g., welding blanket) and a fire extinguisher is at hand.
- Always use extreme caution when cutting and trimming during fitting.
- Always tighten all nuts and bolts securely per installation instructions.
- Always route electrical cables carefully. Avoid moving parts, components that become hot, and rough or sharp edges.
- Always insulate and protect all exposed wiring and electrical terminals.
- Perform regular inspections and maintenance on mounts and hardware.

The background of the page features a faded, semi-transparent image of a large, treaded vehicle tire on the left side and a range of mountains in the distance on the right side. The overall background is a light gray color.

TABLE OF CONTENTS

- 2 SAFETY / DISCLAIMER
- 3 TABLE OF CONTENTS
- 4 A MESSAGE FROM THE OWNER
- 5 GETTING STARTED
- 6 PROVIDED MATERIAL
- 8 DISASSEMBLY
- 12 INSTALLATION

A MESSAGE FROM THE OWNER



Fab Fours' was born out of a passion for customizing vehicles and a love of the outdoors. Our engineering team uses the latest 3D design software to turn new product ideas into reality. In our factory, designs come to life with the combination of cutting edge technology for metal cutting and forming and an American workforce that puts its' heart and pride into every product.

From design and manufacturing, to quality and delivery, Fab Fours' mission is to be the market leader for steel truck and jeep accessories. We make sure a quality product is delivered on time, more than expected, better than expected to our customers.

Enjoy your new Fab Fours product. Welcome to the family!

Greg Higgs

FOUNDER, FAB FOURS

GETTING STARTED

Before you begin the installation process of your new Fab Fours product, we suggest laying out all materials and parts on a pad or protective surface.

Failure to fully account for all components before beginning installation may leave vehicle immobile until part is acquired. Refer to the next pages as an inventory check.

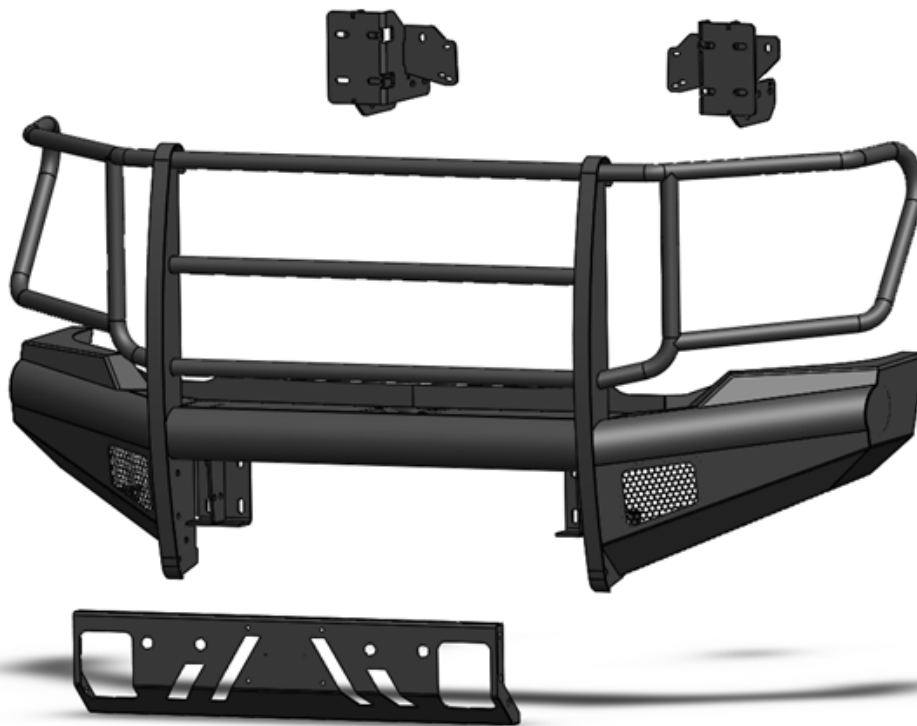

PROVIDED MATERIALS

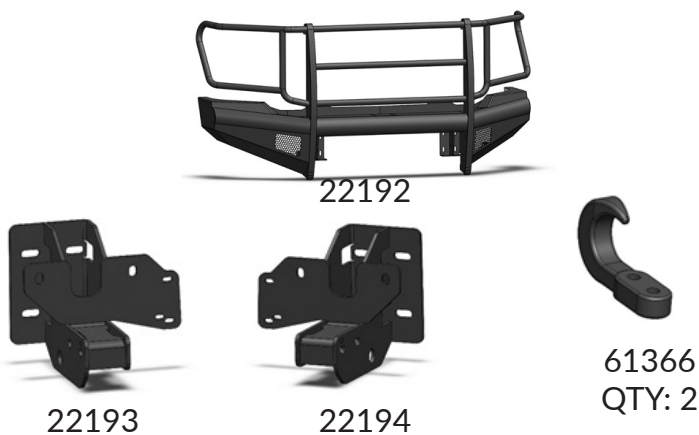
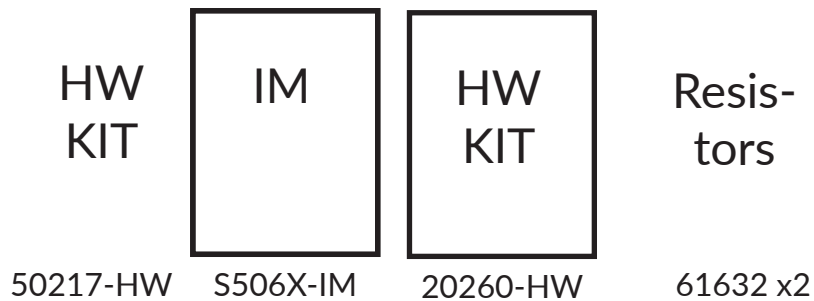

22196 or 22197

HARDWARE KIT | 50217 / 20260

| FAB FOURS IDENTIFICATION | COMPONENT DESCRIPTION | QTY |
|--------------------------|---|-----|
| 50217-HW | 1/4"-20 X 1", Yellow Zinc Hex Cap Bolt, Grade 8 | 10 |
| 50217-HW | 1/4"-20, Yellow Zinc Hex Nut, Grade 8 | 10 |
| 50217-HW | 1/4", Yellow Zinc Flat Washer, Grade 8 | 20 |
| 50217-HW | 1/4", Yellow Zinc Lock Washer, Grade 8 | 10 |
| 50217-HW | 1/2"-13 X 4.5", Yellow Zinc Hex Cap Bolt, Grade 8 | 4 |
| 50217-HW | 1/2"-13 X 1.5", Yellow Zinc Hex Cap Bolt, Grade 8 | 8 |
| 50217-HW | 1/2", Yellow Zinc Lock Washer, Grade 8 | 12 |
| 50217-HW | 1/2", Yellow Zinc Flat Washer, Grade 8 | 24 |
| 50217-HW | 1/2"-13, Yellow Zinc Hex Nut, Grade 8 | 12 |

TOOLS REQUIRED

- 5/16" Socket wrench
- 3/8" Socket wrench
- 3/4" Socket wrench
- 5/16" Open-end wrench
- 10mm Socket wrench
- 14mm Socket wrench
- 17mm Socket wrench
- Needle nose pliers
- Flat head screwdriver
- Plastic panel pry tool
- Silver sharpie
- Body saw
- Angle grinder w/ flat disk pad
- Painters tape
-

ASSISTANCE

We recommend two people perform the installation as items are heavy and may need to be held in place while installing.

ORGANIZATION

Disassemble the vehicle where you can catalog and store everything. We suggest labeling and bagging all the OEM bolts when removing from the vehicle. Failure to keep track of parts could lead to an inability to properly reinstall components.

PROVIDED MATERIALS

HARDWARE KIT | 50217 / 20260

| FAB FOURS IDENTIFICATION | COMPONENT DESCRIPTION | QTY |
|--------------------------|--|-----|
| 20260-HW | 1/2"-13 x 1", Yellow Zinc Hex Cap Bolt, Grade 8 | 6 |
| 20260-HW | 1/2"-13 x 2.25", Yellow Zinc Hex Cap Bolt, Grade 8 | 4 |
| 20260-HW | 1/2", Yellow Zinc Flat Washer, Grade 8 | 20 |
| 20260-HW | 1/2", Yellow Zinc Lock Washer, Grade 8 | 16 |
| 20260-HW | 1/2"-13, Yellow Zinc Hex Nut, Grade 8 | 10 |
| | | |
| | | |
| | | |
| | | |
| | | |

DISASSEMBLY

NOTE: Save all OEM parts until installation is complete!

1. Open the hood and remove the nine (9) push pins holding the grill cover on using a body pry tool. Use a T15H star socket wrench to remove the two (2) bolts holding the hood latch on and remove the hood latch. Remove the grill cover from the truck and set aside for later install. (Figure 1)



Figure 1

2. Use a 10mm socket wrench to remove the four (4) bolts holding the top of the grill to the truck. Carefully pull the grill off the truck by disengaging the body clips. (Figure 2)



Figure 2

3. Use a 15mm socket wrench underneath the bumper to remove the four (4) bumper support bracket bolts. (Figure 3)



Figure 3

4. Use an 18mm socket wrench to remove four (4) mounting bolts. (Figure 4)

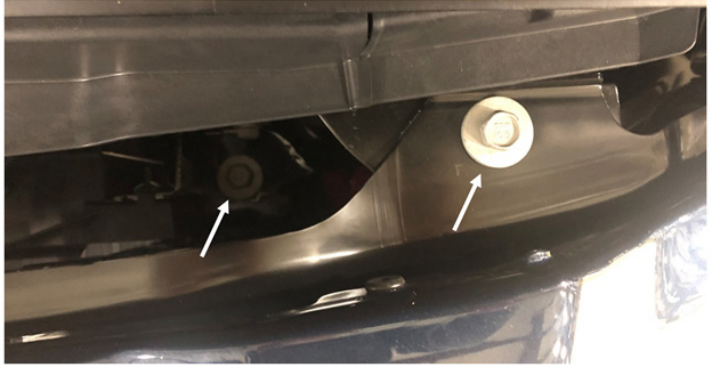

Figure 4

5. Unplug the four (4) bumper sensor harnesses before remove the bumper from the truck.

6. Use a 7mm socket wrench to remove the lower louvers from the mounting brackets. (Figure 5)

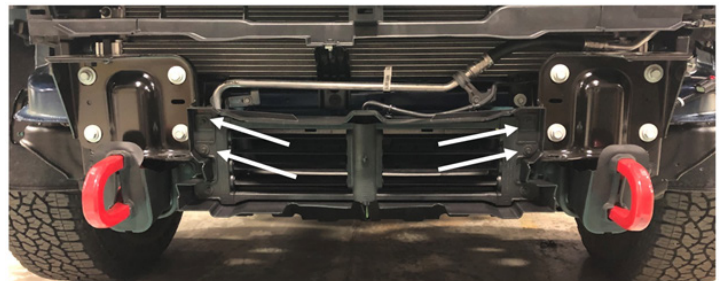

Figure 5

7. Use a 15mm socket wrench to remove the four (4) bolts holding the mounting brackets on. (Figure 6)

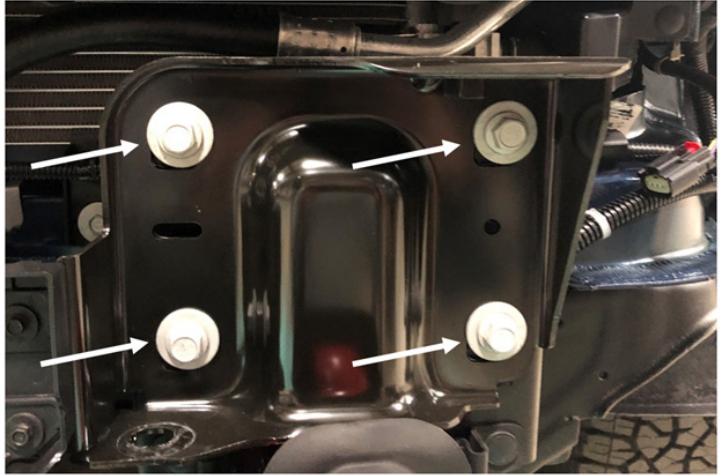

Figure 6

8. Use an 18mm socket wrench to remove the two (2) bolts holding the factory tow hooks onto the frame. (Figure 7)



Figure 7

9. Use a 15mm socket wrench to remove the nine (9) bolts holding the bumper structure on. Remove the metal structure from the bumper to access the sensor harness and Oem fog lights. (Figure 8)



Figure 8

10. Unclip all the plugs holding the sensor harness to the bumper using a body pry tool. Carefully remove the sensor from the housing by pushing the housing apart and removing the sensor by pushing up. (Figure 9)

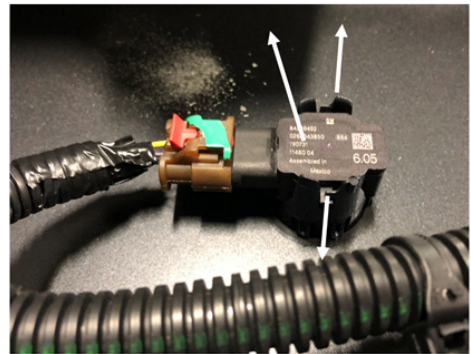

Figure 9

11. Remove the sensor housings from the bumper by pressing the four (4) clips in and pushing it out of the bumper. Make sure to mark what side of the bumper the housing came out of to install into the Fab Fours bumper. (Figure 10)

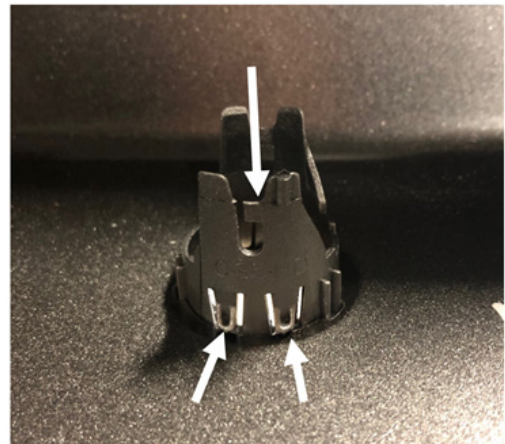

Figure 10

12. Remove the engine heater plug from the bumper by pressing in on the spring and turning clockwise. (Figure 11)

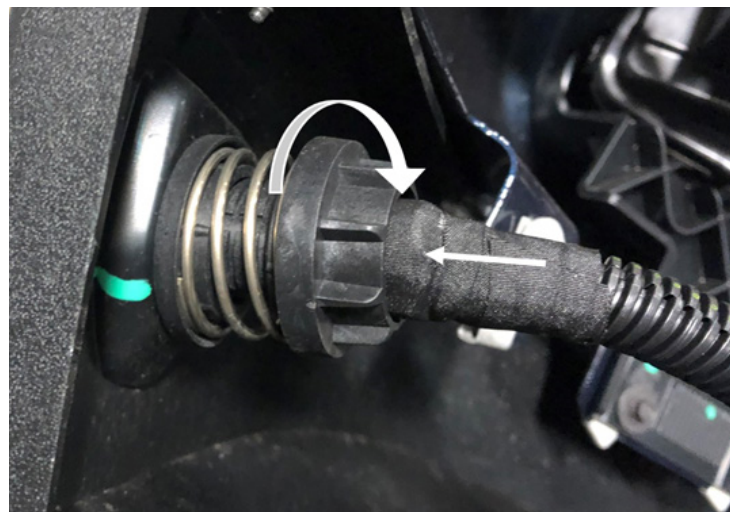

Figure 11

INSTALLATION

13. Use a 10mm socket wrench to remove the three (3) bolts holding the fog lights to the bumper. (Figure 12)

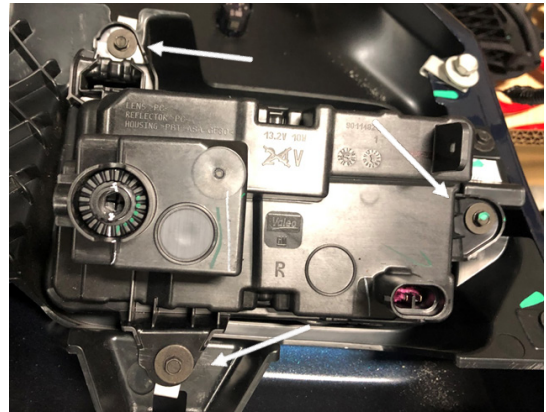

Figure 12

14. Insert both brackets (22193 & 22194) into the frame rail ends and very loosely install two (2) Oem bolts into the frame rail end flange just supporting both brackets. (Figure 13)

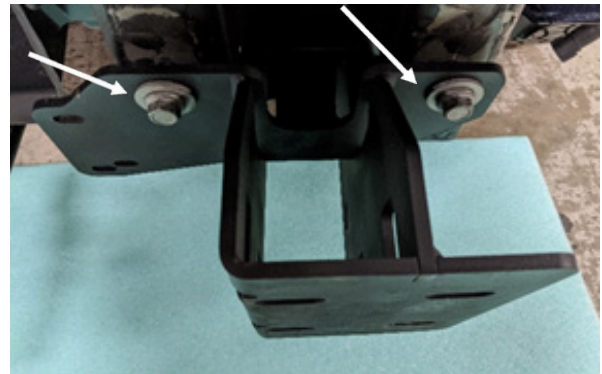

Figure 13

15. Using the provided four (4) bolt stacks f ¼"-20 yellow zinc hex bolt, flat washers, lock washer, and hex nut, loosely install the factory louver system with the bolts pointing forward. (Figure 14) (50217-HW)



Figure 14

16. Using the provided four (4) bolt stacks of 1/2"-13 x 4.5" yellow zinc hex bolt, flat washers, lock washer, and hex nut, loosely install them into each frame rail and bracket (22193 & 22194). (Figure 15) (50217-HW)

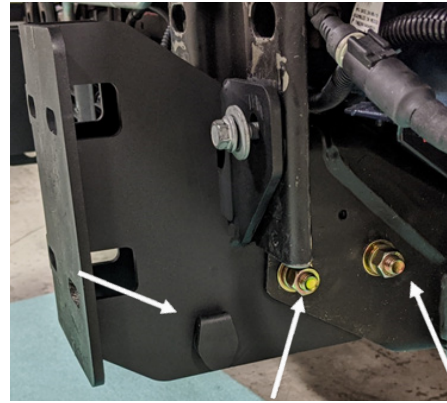

Figure 15

17. Using a 15mm socket wrench fully tighten down the four (4) Oem frame end bolts on both brackets (22193 & 22194). (Figure 13)

18. Using both a 3/4" socket wrench and 3/4" open end wrench, fully tighten down the four (4) 1/2"-13 hex bolts on both frame rails. (Figure 15)

19. If equipped, install the engine heater plug into the driver side bracket (22193) in a manner opposite of the removal. (Figure 15)

20. If equipped, route and reconnect the engine heater plug wiring harness around the back side of the driver side bracket (22193). (Figure 16)



Figure 16

21. Route and reconnect the two (2) Oem wiring harness plugs from the factory louver system behind the frame rail end of the driver side fame rail end. If equipped, route the engine heater plug wiring behind the fame rail also. Zip tie and secure the wiring bundles as desired. (Figure 17)

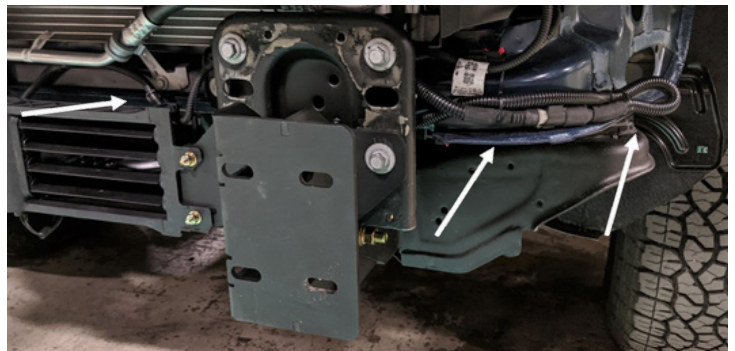

Figure 17

22. Using the provided epoxy, secure all four (4) Oem sensor housings in their appropriate sensor cutout in the lower guard (22196 or 22197). (Figure 18)



Figure 18

23. Use a pair of 7/16" wrenches and the provided six (6) bolt stacks of 1/4"-20 x 1", yellow zinc hex bolt, flat washers, lock washer, and hex nut, fully install the Oem fog lights into the bumper (22192). (Figure 19) (50217-HW)



Figure 19

24. Using a pair of wire snips, clip off all the push retainers from the factory wiring harness. (Figure 20)



Figure 20

25. After the epoxy has cured, fully seat all four (4) sensors into the sensor housings being mindful not to distort the rubber sensor isolator that sits around the sensor tip. Be sure both sides of the sensor housing are fully clipped on the sensor. (Figure 21)

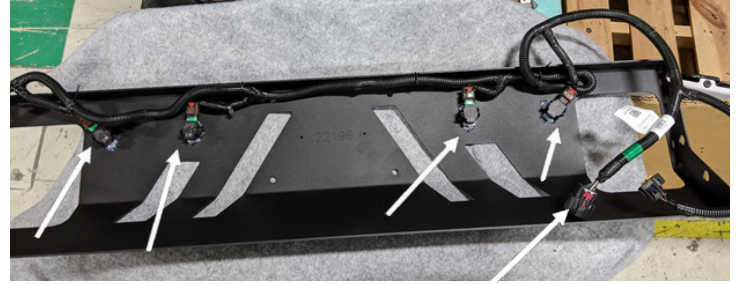

Figure 21

26. Route and zip tie the factory wiring harness to the lower guard (22196 or 22197) with the main factory connector being on the passenger side of the guard. (Figure 21)

27. Use a pair of 3/4" wrenches and the provided six (6) bolt stacks of 1/2"-13 x 1", yellow zinc hex bolt, flat washers, lock washer, and hex nut, fully install the bumper lower guard (22196 or 22197) into the bumper(22192). (Figure 22 & 23) (20260-HW)



Figure 22

28. With assistance, lift the bumper (22192) up to the brackets (22193 & 22194) and secure it loosely using the provided eight (8) bolt stacks of 1/2"-13 x 1.5", yellow zinc hex bolt, flat washers, lock washer, and hex nuts. (Figure 24) (50217-HW)



Figure 23

29. With assistance of two, lift and center the bumper to the vehicle and using a pair of 3/4" wrenches, fully tighten down the eight (8) 1/2"-13 bolts securing the bumper (22192) to the brackets (22193 & 22194).

30. Reconnect the factory wiring harness main connector and both fog lights.



Figure 24

**“IF YOU’RE LOOKING FOR MORE OF THE SAME,
THEN YOU’VE COME TO THE WRONG PLACE.”**

- GREG HIGGS

