



**INSTALLATION MANUAL**  
**MATRIX FRONT BUMPER**  
**PRODUCT NUMBER: X285X**  
**APPLICATION: 2019 GMC HD**



## **IMPORTANT SAFETY GUIDE** | Your safety and the safety of others is very important.

In order to help you make informed decisions about safety, we have provided the following warnings, safety precautions, installation instructions, and other important information to alert you to potential hazards that could hurt you or others.

Please do a job safety analysis before each task to identify potential hazards for your situation and remove/protect against them. Use own good judgment and take your time.

Check packaged materials immediately upon arrival to ensure that all listed parts are included and undamaged.

**Read and understand all warnings, safety precautions, and instructions before installing this product.**

SENSORS FIELD OF VIEW MAY BE ALTERED WITH USE OF THE REPLACEMENT BUMPER.

---

### **WARNINGS**

- Failure to observe the following warnings and instructions provided in this manual could lead to severe injury and/or death.
- For professional installation only. Careless installation and/or operation can result in serious injury, death, and/or equipment damage. All liability for installation and use rests with the user or consumer.
- Fab Fours, Inc. only approves installing this product according to these written instructions with the hardware provided. Failure to install according to these instructions will invalidate the warranty. This includes, but is not limited to, using alternative installation methods, hardware, or materials.
- This product is for off road use only.

---

### **SAFETY PRECAUTIONS**

- Always remove jewelry and wear eye protection.
- Always use extreme caution when jacking up a vehicle for work. Set emergency brake and use tire blocks. Locate and use the vehicle manufacturers designated lifting points. Use jack stands.
- Always use appropriate and adequate care in lifting components into place.
- Always ensure components will remain secure during installation and operation.
- Always wear safety glasses when installing this kit. A drilling operation will cause flying metal chips. Flying chips can cause serious eye injury.
- Always use extreme caution when drilling a vehicle. Always disconnect power before welding. Thoroughly inspect the area to be drilled (on both sides of material when possible) prior to drilling, and relocate any objects that may be damaged.
- Always use extreme caution when welding a vehicle. Thoroughly inspect the area to be welded (on both sides of material when possible) prior to welding, and relocate any objects that may be a fire hazard. When welding in a cab, make sure the interior surfaces are covered (e.g., welding blanket) and a fire extinguisher is at hand.
- Always use extreme caution when cutting and trimming during fitting.
- Always tighten all nuts and bolts securely per installation instructions.
- Always route electrical cables carefully. Avoid moving parts, components that become hot, and rough or sharp edges.
- Always insulate and protect all exposed wiring and electrical terminals.
- Perform regular inspections and maintenance on mounts and hardware.

# TABLE OF CONTENTS

- 2 SAFETY / DISCLAIMER
- 3 TABLE OF CONTENTS
- 4 A MESSAGE FROM THE OWNER
- 5 GETTING STARTED
- 6 PROVIDED MATERIAL
- 7 DISASSEMBLY
- 9 INSTALLATION
- 11 CONTACT

# A MESSAGE FROM THE OWNER

---



Fab Fours' was born out of a passion for customizing vehicles and a love of the outdoors. Our engineering team uses the latest 3D design software to turn new product ideas into reality. In our factory, designs come to life with the combination of cutting edge technology for metal cutting and forming and an American workforce that puts its' heart and pride into every product.

From design and manufacturing, to quality and delivery, Fab Fours' mission is to be the market leader for steel truck and jeep accessories. We make sure a quality product is delivered on time, more than expected, better than expected to our customers.

Enjoy your new Fab Fours product. Welcome to the family!

*Ereg Higgs*

**FOUNDER, FAB FOURS**

# GETTING STARTED

---

Before you begin the installation process of your new Fab Fours product, we suggest laying out all materials and parts on a pad or protective surface.

Failure to fully account for all components before beginning installation may leave vehicle immobile until part is acquired. Refer to the next pages as an inventory check.

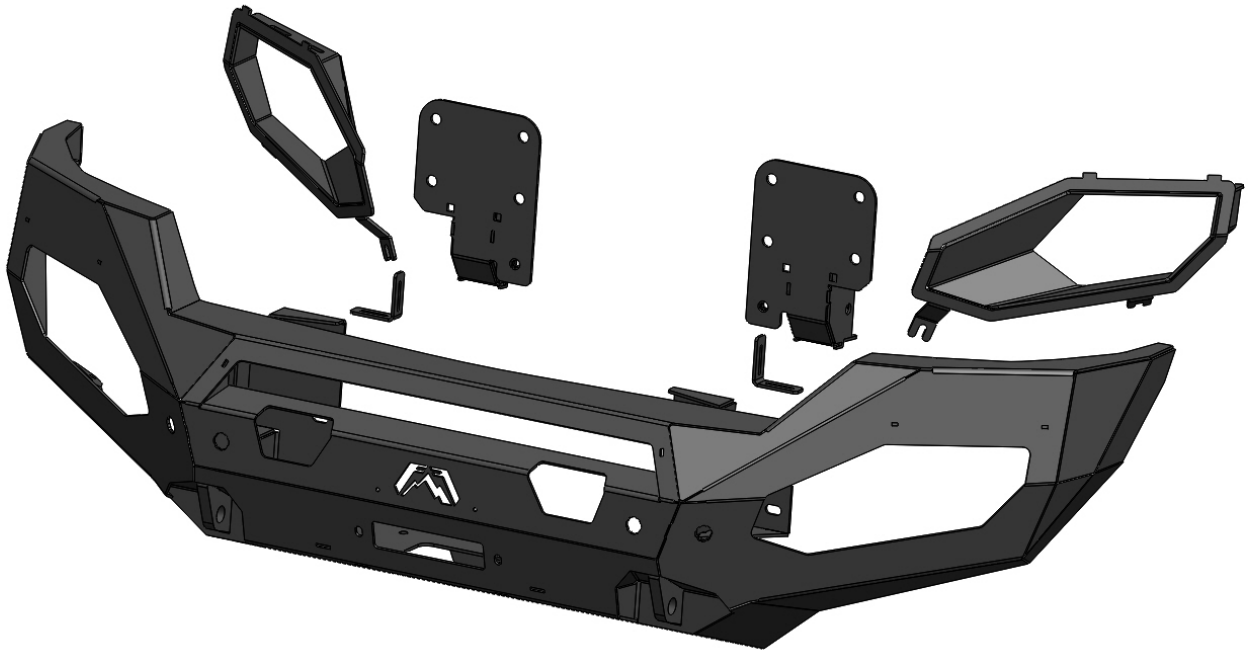

# PROVIDED MATERIALS

IM

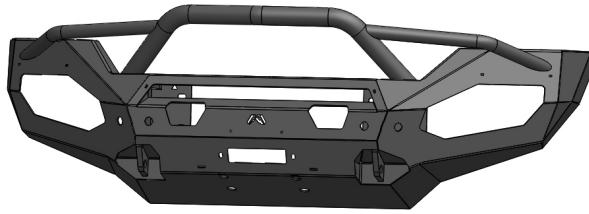

21895

D485X-IM

HW  
KIT

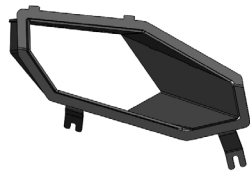

21897



21896

50182-HW

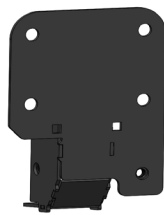

21095

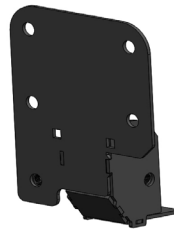

21904

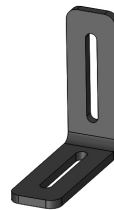

21871  
QTY: 2

## HARDWARE KIT | 50182

FAB FOURS IDENTIFICATION	COMPONENT DESCRIPTION	QTY
50180-HW	1/2" diameter nylon spacer, 3/8" long	2
50180-HW	#10-24 x 1 1/4", stainless steel, button head cap screw	2
50180-HW	#10, stainless steel, flat washer	4
50180-HW	10-24 Nyloc hex nut	2
50180-HW	7/16"-14 x 1.5", yellow zinc, hex head cap screw, grade 8	4
50180-HW	7/16", yellow zinc, flat washer, grade 8	8
50180-HW	7/16", yellow zinc, lock washer, grade 8	4
50180-HW	7/16"-14, yellow zinc, hex nut, grade 8	4
50180-HW	#8-32 x 3/4", stainless steel, button head cap screw	4
50180-HW	#8-32, yellow zinc, nyloc nut	4
50180-HW	#8, yellow zinc, flat washer	4

## TOOLS REQUIRED

- Plastic panel pry tool
- 10mm socket wrench
- 15mm socket wrench
- 18mm socket wrench
- 1/2" socket wrench
- 3/4" socket wrench
- 7/16" socket wrench

## ASSISTANCE

We recommend two people perform the installation as items are heavy and may need to be held in place while installing.

## ORGANIZATION

Disassemble the vehicle where you can catalog and store everything. We suggest labeling and bagging all the OEM bolts when removing from the vehicle. Failure to keep track of parts could lead to an inability to properly reinstall components.

# DISASSEMBLY

1. Using a plastic panel pry tool, remove the twelve (12) push pins from around the grill cover. Remove the cover from the truck. (Figure 1)



Figure 1

2. Using a 10mm socket wrench, remove the four (4) 10mm bolts from the top of the grill. Remove the grill by carefully pulling the bottom of the grill. (Figure 2)



Figure 2

3. With the grill removed, use a 1/2" socket wrench to remove the two (2) bolts from the top of the bumper on both the driver and passenger side. (Figure 3)



Figure 3

4. Using a 15mm socket wrench, remove the three (3) bolts holding the bumper support bracket on and remove it from the truck. Disconnect the wiring harness and remove the bumper from the truck. (Figure 4)



Figure 4

5. If truck is equipped, remove the factory tow hooks with a 18mm socket wrench. Remove the frame rail cover using a 15mm socket wrench to remove the four (4) bolts, set bolts aside for later use. (Figure 5)



Figure 5

6. Carefully remove the wiring harness from the OEM bumper by unplugging it from the fog lights and sensors. Carefully remove the sensors by bending the plastic housing clips by and pulling the sensor out. Remove the sensor housings by depressing the two (2) clip stops and pushing the housing through the bumper. (Figure 6)

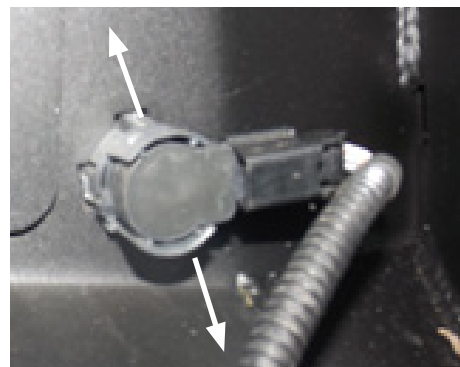

Figure 6



# INSTALLATION

7. Install the sensors housings into the Fab Fours bumper by pushing them into their respective holes. Install the sensors by holding the housing in place and pushing the sensor until it clips in the housing. (Figure 7)

*NOTE: Sensors are extremely delicate and must be handled with care! Do not push on face of sensors to remove!*



Figure 7

8. Using a 1/2" socket wrench, install the two light boxes (21896 and 21897) by inserting the two tabs into the slots and bolting the lower flanges with the provided 5/16" bolts, stainless steel flat and lock washers (50182-HW). (Figure 8)



Figure 8

9. If applicable: Install your 30" light bar at this time. Using a 7/16" socket wrench, install the provided L-brackets (21871) with the provided 1/4" bolts, 1/4" flat and lock washers, and 1/4" nuts (50182-HW). (Figure 9)

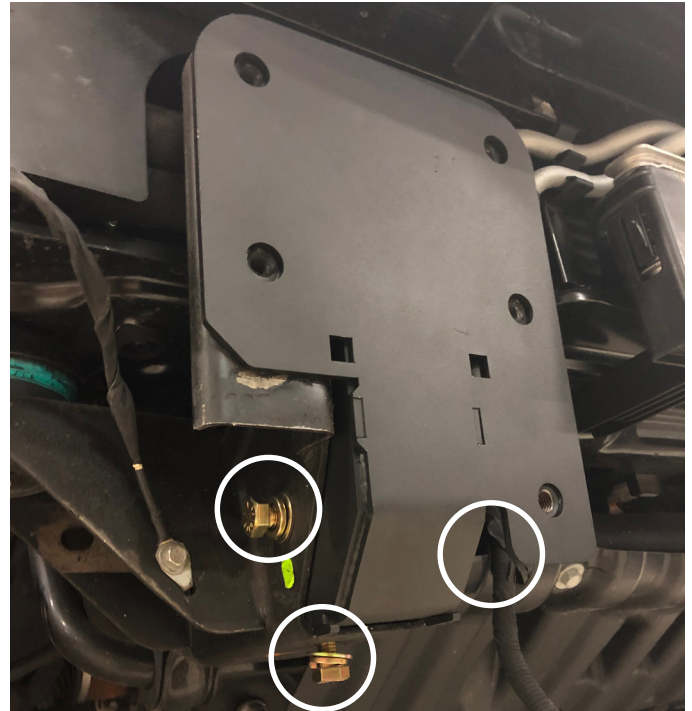

Figure 9

**10. Using a 3/4" socket wrench, install the two mounting brackets (21904 and 21905) by placing them in the frame and loosely installing three (3) 1/2" bolts, flat and lock washers (50182-HW). (Figure 10)**

**11. With assistance, hold the bumper up to the mounting place and use a 15mm socket wrench to install the four (4) OEM mounting bolts to mount the bumper.**

**12. Using a 3/4" socket wrench, install the 1/2" bolt, flat and lock washer into the bottom of the mounting plate (50182-HW). Tighten all mounting hardware. (Figure 11)**



*Figure 10*

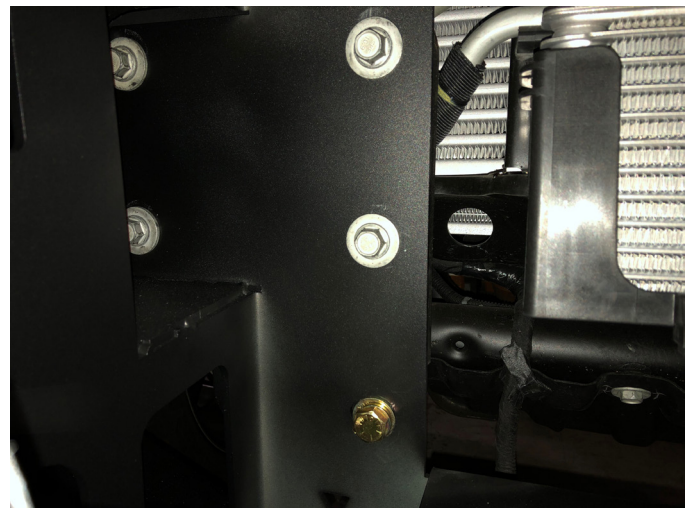

*Figure 11*

---

**“IF YOU’RE LOOKING FOR MORE OF THE SAME,  
THEN YOU’VE COME TO THE WRONG PLACE.”**

**- GREG HIGGS**

