



INSTALLATION MANUAL
RED STEEL REAR BUMPER
PRODUCT NUMBER: FS99-RT1350
APPLICATION: 1999-2004 FORD SD



IMPORTANT SAFETY GUIDE | Your safety and the safety of others is very important.

In order to help you make informed decisions about safety, we have provided the following warnings, safety precautions, installation instructions, and other important information to alert you to potential hazards that could hurt you or others.

Please do a job safety analysis before each task to identify potential hazards for your situation and remove/protect against them. Use own good judgment and take your time.

Check packaged materials immediately upon arrival to ensure that all listed parts are included and undamaged.

Read and understand all warnings, safety precautions, and instructions before installing this product.

SENSORS FIELD OF VIEW MAY BE ALTERED WITH USE OF THE REPLACEMENT BUMPER.

WARNINGS

- Failure to observe the following warnings and instructions provided in this manual could lead to severe injury and/or death.
- For professional installation only. Careless installation and/or operation can result in serious injury, death, and/or equipment damage. All liability for installation and use rests with the user or consumer.
- Fab Fours, Inc. only approves installing this product according to these written instructions with the hardware provided. Failure to install according to these instructions will invalidate the warranty. This includes, but is not limited to, using alternative installation methods, hardware, or materials.
- This product is for off road use only.

SAFETY PRECAUTIONS

- Always remove jewelry and wear eye protection.
- Always use extreme caution when jacking up a vehicle for work. Set emergency brake and use tire blocks. Locate and use the vehicle manufacturers designated lifting points. Use jack stands.
- Always use appropriate and adequate care in lifting components into place.
- Always ensure components will remain secure during installation and operation.
- Always wear safety glasses when installing this kit. A drilling operation will cause flying metal chips. Flying chips can cause serious eye injury.
- Always use extreme caution when drilling a vehicle. Always disconnect power before welding. Thoroughly inspect the area to be drilled (on both sides of material when possible) prior to drilling, and relocate any objects that may be damaged.
- Always use extreme caution when welding a vehicle. Thoroughly inspect the area to be welded (on both sides of material when possible) prior to welding, and relocate any objects that may be a fire hazard. When welding in a cab, make sure the interior surfaces are covered (e.g., welding blanket) and a fire extinguisher is at hand.
- Always use extreme caution when cutting and trimming during fitting.
- Always tighten all nuts and bolts securely per installation instructions.
- Always route electrical cables carefully. Avoid moving parts, components that become hot, and rough or sharp edges.
- Always insulate and protect all exposed wiring and electrical terminals.
- Perform regular inspections and maintenance on mounts and hardware.

TABLE OF CONTENTS

- 2 SAFETY / DISCLAIMER
- 3 TABLE OF CONTENTS
- 4 A MESSAGE FROM THE OWNER
- 5 GETTING STARTED
- 6 PROVIDED MATERIAL
- 7 DISASSEMBLY
- 8 INSTALLATION
- 10 CONTACT

A MESSAGE FROM THE OWNER



Fab Fours' was born out of a passion for customizing vehicles and a love of the outdoors. Our engineering team uses the latest 3D design software to turn new product ideas into reality. In our factory, designs come to life with the combination of cutting edge technology for metal cutting and forming and an American workforce that puts its' heart and pride into every product.

From design and manufacturing, to quality and delivery, Fab Fours' mission is to be the market leader for steel truck and jeep accessories. We make sure a quality product is delivered on time, more than expected, better than expected to our customers.

Enjoy your new Fab Fours product. Welcome to the family!

Ereg Higgs

FOUNDER, FAB FOURS

GETTING STARTED

Before you begin the installation process of your new Fab Fours product, we suggest laying out all materials and parts on a pad or protective surface.

Failure to fully account for all components before beginning installation may leave vehicle immobile until part is acquired. Refer to the next pages as an inventory check.

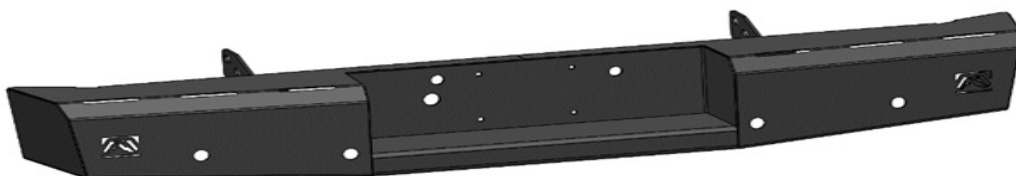

PROVIDED MATERIALS

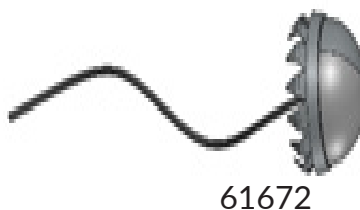
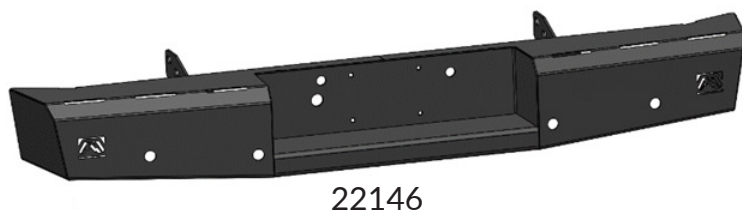
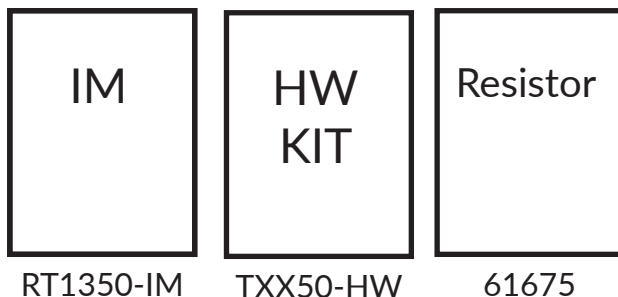

HARDWARE KIT | TXX50

FAB FOURS IDENTIFICATION	COMPONENT DESCRIPTION	QTY
TXX50-HW	½" License Plate Nut, Plastic	2
TXX50-HW	1-¾" Rubber Grommet	4
TXX50-HW	Plastic Plug	4

TOOLS REQUIRED

- 10mm Socket wrench
- 12mm Socket wrench
- 19mm Socket wrench
- 3/32" Socket wrench
- 3/4" Socket wrench
- 12mm Box end wrench
- 11/32" Box end wrench
- 3/4" Box end wrench
- 13/16" Box end wrench
- Phillips head screwdriver

ASSISTANCE

We recommend two people perform the installation as items are heavy and may need to be held in place while installing.

ORGANIZATION

Disassemble the vehicle where you can catalog and store everything. We suggest labeling and bagging all the OEM bolts when removing from the vehicle. Failure to keep track of parts could lead to an inability to properly reinstall components.

DISASSEMBLY

NOTE: Save all OEM parts until installation is complete!

1. Using a screwdriver, remove the license plate from your OEM bumper.
2. Disconnect the OEM wiring harness from the license plate lights, trailer plug receptacle, and back up sensors if applicable.
3. With assistance, support the bumper on both side in preparation for removal.
4. Using 19mm socket wrench and on the passenger side, remove the two (2) Oem bolts on the side of the frame rail end. (Figure 1)
5. Repeat step 4 on the driver side frame rail end.

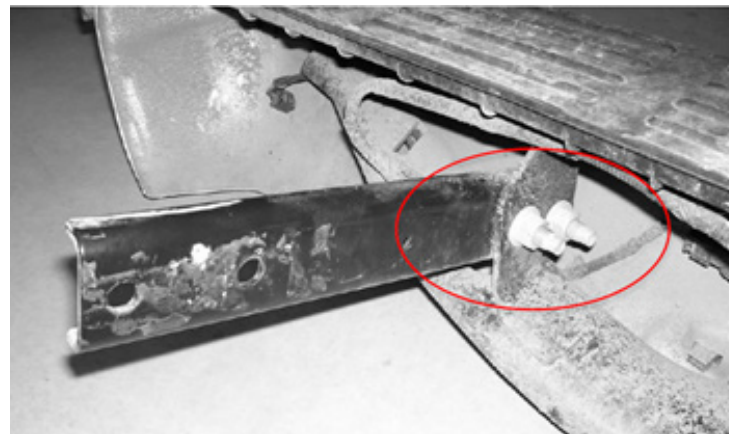

Figure 1

INSTALLATION

6. Replace OEM bumper with your new Fab Fours rear bumper assembly. Use the OEM fasteners to fasten the bumper to the frame rail in the OEM mounting locations. Do not fully tighten. (Figure 3)

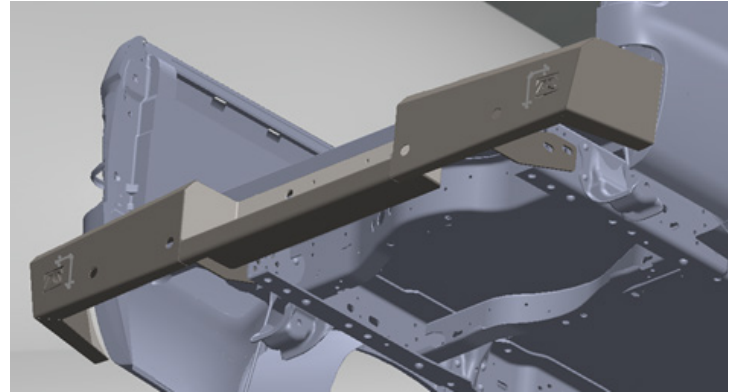

Figure 3

7. Slowly lower the tailgate to ensure there will be no interference. If required, loosen the frame bolts / hitch bolts and adjust alignment of the bumper.

8. Install the provided tag light (61672) into the 1 1/4" hole provided in the center section of the bumper (22146). The powder coating may need to be removed from the hole for proper grounding. Connect wire into the hot wire of OEM tag light circuit. Verify operation and use the provided resistor if needed. (Figure 4)



Figure 4

9. Reinstall license plate with provided plastic inserts. (TXX50-HW) (Figure 5)

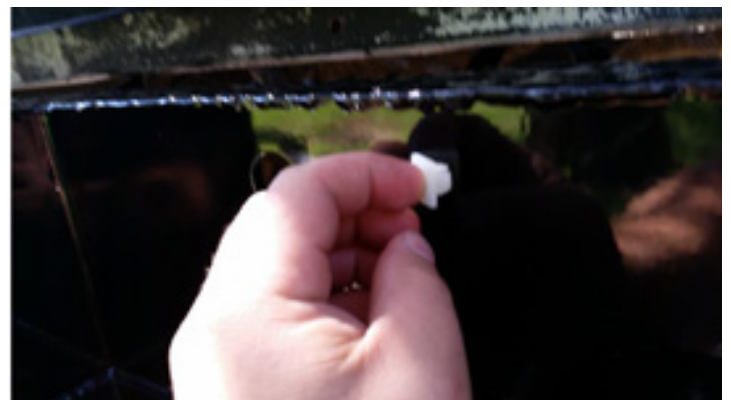

Figure 5

10. Install grommets into sensor holes of the bumper (22146). (TXX50-HW) If equipped, insert sensors from the back side. If not equipped, install provided plugs into the grommets. (TXX50-HW)

11. Reconnect the bumper wiring harness to the vehicle harness connector.

12. Secure all loose wiring and harnesses to the frame or bumper with zip ties.