



INSTALLATION MANUAL
VENGEANCE REAR BUMPER
PRODUCT NUMBER: E485X
APPLICATION: 2019 FORD RANGER



IMPORTANT SAFETY GUIDE | Your safety and the safety of others is very important.

In order to help you make informed decisions about safety, we have provided the following warnings, safety precautions, installation instructions, and other important information to alert you to potential hazards that could hurt you or others.

Please do a job safety analysis before each task to identify potential hazards for your situation and remove/protect against them. Use own good judgment and take your time.

Check packaged materials immediately upon arrival to ensure that all listed parts are included and undamaged.

Read and understand all warnings, safety precautions, and instructions before installing this product.

SENSORS FIELD OF VIEW MAY BE ALTERED WITH USE OF THE REPLACEMENT BUMPER.

WARNINGS

- Failure to observe the following warnings and instructions provided in this manual could lead to severe injury and/or death.
- For professional installation only. Careless installation and/or operation can result in serious injury, death, and/or equipment damage. All liability for installation and use rests with the user or consumer.
- Fab Fours, Inc. only approves installing this product according to these written instructions with the hardware provided. Failure to install according to these instructions will invalidate the warranty. This includes, but is not limited to, using alternative installation methods, hardware, or materials.
- This product is for off road use only.

SAFETY PRECAUTIONS

- Always remove jewelry and wear eye protection.
- Always use extreme caution when jacking up a vehicle for work. Set emergency brake and use tire blocks. Locate and use the vehicle manufacturers designated lifting points. Use jack stands.
- Always use appropriate and adequate care in lifting components into place.
- Always ensure components will remain secure during installation and operation.
- Always wear safety glasses when installing this kit. A drilling operation will cause flying metal chips. Flying chips can cause serious eye injury.
- Always use extreme caution when drilling a vehicle. Always disconnect power before welding. Thoroughly inspect the area to be drilled (on both sides of material when possible) prior to drilling, and relocate any objects that may be damaged.
- Always use extreme caution when welding a vehicle. Thoroughly inspect the area to be welded (on both sides of material when possible) prior to welding, and relocate any objects that may be a fire hazard. When welding in a cab, make sure the interior surfaces are covered (e.g., welding blanket) and a fire extinguisher is at hand.
- Always use extreme caution when cutting and trimming during fitting.
- Always tighten all nuts and bolts securely per installation instructions.
- Always route electrical cables carefully. Avoid moving parts, components that become hot, and rough or sharp edges.
- Always insulate and protect all exposed wiring and electrical terminals.
- Perform regular inspections and maintenance on mounts and hardware.

TABLE OF CONTENTS

- 2 SAFETY / DISCLAIMER
- 3 TABLE OF CONTENTS
- 4 A MESSAGE FROM THE OWNER
- 5 GETTING STARTED
- 6 PROVIDED MATERIAL
- 7 DISASSEMBLY
- 12 INSTALLATION

A MESSAGE FROM THE OWNER



Fab Fours' was born out of a passion for customizing vehicles and a love of the outdoors. Our engineering team uses the latest 3D design software to turn new product ideas into reality. In our factory, designs come to life with the combination of cutting edge technology for metal cutting and forming and an American workforce that puts its' heart and pride into every product.

From design and manufacturing, to quality and delivery, Fab Fours' mission is to be the market leader for steel truck and jeep accessories. We make sure a quality product is delivered on time, more than expected, better than expected to our customers.

Enjoy your new Fab Fours product. Welcome to the family!

Ereg Higgs

FOUNDER, FAB FOURS

GETTING STARTED

Before you begin the installation process of your new Fab Fours product, we suggest laying out all materials and parts on a pad or protective surface.

Failure to fully account for all components before beginning installation may leave vehicle immobile until part is acquired. Refer to the next pages as an inventory check.

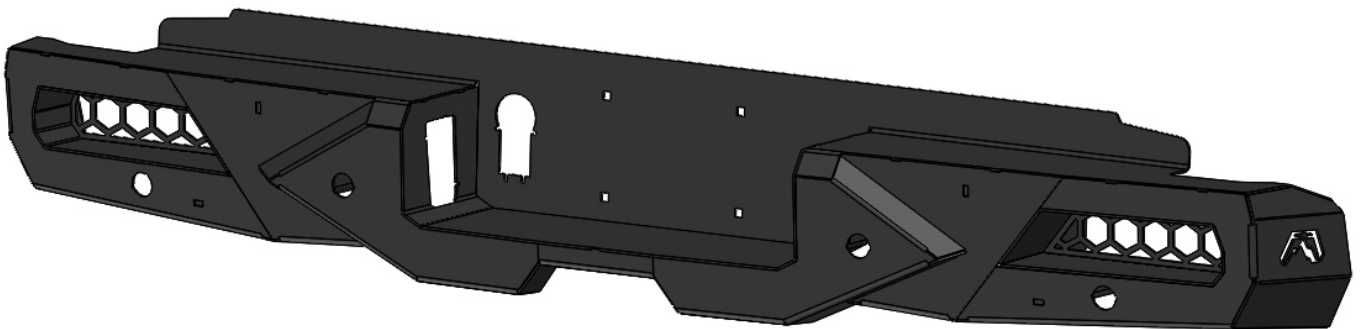

PROVIDED MATERIALS



61632
QTY: 4

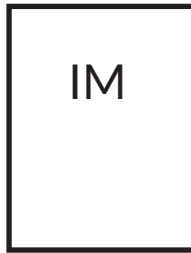

E485X-IM

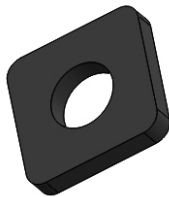

20184-13
QTY: 4

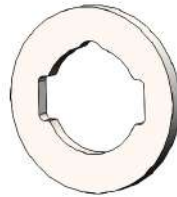

20217-15
QTY: 1

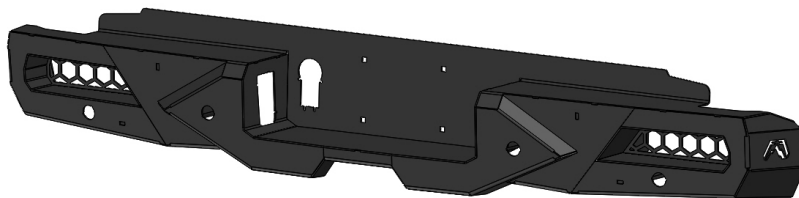

21891

TOOLS REQUIRED

- Plastic panel pry tool
- Star head T40H Socket
- 15mm socket wrench
- 7mm socket wrench
- 21mm socket wrench
- Grinder
- Scissors/snips

ASSISTANCE

We recommend two people perform the installation as items are heavy and may need to be held in place while installing.

ORGANIZATION

Disassemble the vehicle where you can catalog and store everything. We suggest labeling and bagging all the OEM bolts when removing from the vehicle. Failure to keep track of parts could lead to an inability to properly reinstall components.

DISASSEMBLY

1. Start by disconnecting the sensor and trailer plug harness from underneath the frame rails. (Figure 1-2)



Figure 1



Figure 2

2. Carefully disconnect the sensors from the harness and remove them from their housings by expanding both sides of the sensor housings and lifting up. To remove the sensor housing, depress the four (4) tabs while pushing outward from the inside of the bumper. (Figure 3-4)

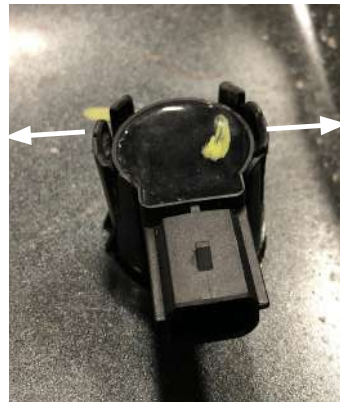

Figure 3



Figure 4

NOTE: Sensors are extremely delicate and must be handled with care! Do not push on face of sensors to remove!

3. Unplug the light bulbs from the light boxes by carefully turning them counterclockwise and pulling. (Figure 5)



Figure 5

4. Remove the trailer plug housing from the inside of the bumper by depressing the two metal clips on either side and pushing out. Remove the spare tire access lock by using the key inside the key fob to unlock it. (Figure 6-7)



Figure 6



Figure 7

5. Using a plastic panel pry tool, remove the four (4) push pins from the bumper. (Figure 8)



Figure 8

6. Using a plastic panel pry tool, start on the outside of the bumper and remove the plastic kick board from the bumper. (Figure 9)

NOTE: pinch the clips on the inside of the bumper while using the pry tool on the outside to remove.



Figure 9

7. With the kick board removed, use a star head T40H socket to remove the four (4) bolts holding the side pieces onto the frame. (Figure 10)

NOTE: the tailgate may need to be removed to access the rear two (2) bolts, to do this lift the tailgate up and out from its lower mounting.



Figure 10

8. Using a 15mm socket wrench, remove the two (2) bolts holding the outside pieces onto the frame and remove from the vehicle. (Figure 11)



Figure 11

9. Using a 7mm socket wrench, remove the six (6) 7mm bolts holding the plastic trim over the hitch. (Figure 12)



Figure 12

10. Using a plastic panel pry tool, remove the push pins holding the sensor harness to the frame and put aside to install in the new bumper. (Figure 13)



Figure 13

11. With the bumper and harness removed from the truck, remove the metal brackets from the hitch mount by grinding the welds away. (Figure 14-16)



Figure 14



Figure 15



Figure 16

INSTALLATION

NOTE: Use painters tape to protect any areas of the vehicle that may contact the Fab Fours product during installation.

NOTE: If installing any lights into the bumper, they can be installed prior to bumper installation. Follow the lighting manufacturer's instructions for installation.

1. Install the trailer plug into the bumper and pushing it into the opening. Make sure the metal clips click in place to secure it. (Figure 17)



Figure 17

2. Install the spare tire access lock by placing in into the bumper and placing the provided spacer (20217-15) over it to keep it in place. Apply the provided epoxy (61675) around the spacer to keep it in place. (Figure 18)



Figure 18

3. Take the sensor housing and carefully place them into their respective locations. Install the sensors into the housings by pressing them in until they click into place. (Figure 19)



Figure 19

4. Take the license plate lights from the OEM bumper and cut off 1/8" of the clips and then install them into the bumper. Once installed, apply the provide epoxy (61632) around the lights to keep them in place. (Figure 20)



Figure 20

5. Plug the sensor harness into the sensors, lights, and trailer plug. (Figure 21)



Figure 21

6. Using a 21mm socket wrench, remove the two (2) back bolts on the hitch brackets. Loosen the third bolt until the hitch is hanging down 1/2" from the frame. (Figure 22)



Figure 22

7. Place the provided spacers (20184-13) between the frame and hitch brackets, on both DS and PS, and then thread the two removed bolts back in place leaving them loose for the bumper install. (Figure 23)



Figure 23

8. With assistance, slide the bumper between the third bolts. Once you have it in the desired location, tighten all mounting bolts using a 21mm socket wrench and plug the harness in. (Figure 24)

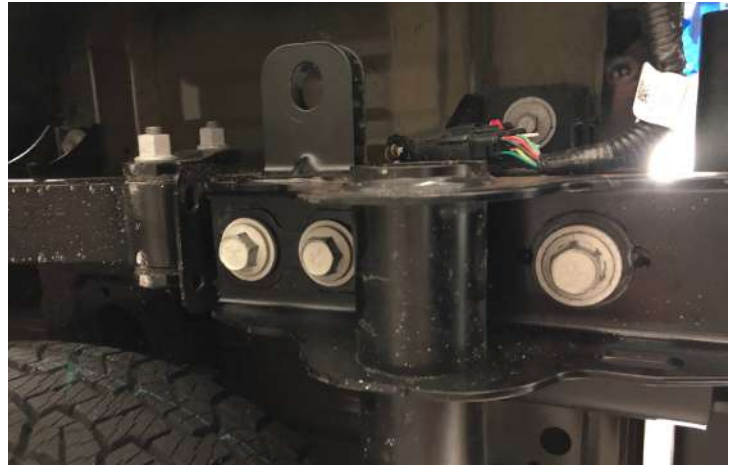

Figure 24

**“IF YOU’RE LOOKING FOR MORE OF THE SAME,
THEN YOU’VE COME TO THE WRONG PLACE.”**

- GREG HIGGS

