



Installation Instructions

Ford F150 Front Vengeance

SKU Number: D1951, D1952

Application: 2009-2014 Ford F150

SAFETY

Your safety and the safety of others is very important.

- In order to help you make informed decisions about safety, we have provided installation instructions and other information.
- These instructions alert you to potential hazards that could hurt you or others.
- Please do a job safety analysis (JSA) before each task to identify potential hazards for your situation and remove/protect against them.
- You must use your own good judgment, and take your time.

Read and understand all safety precautions and instructions before installing this product.

THIS PRODUCT IS FOR OFFROAD USE ONLY. ALL LIABILITY FOR INSTALLATION AND USE RESTS WITH THE OWNER.

CARELESS INSTALLATION AND OPERATION CAN RESULT IN SERIOUS INJURY OR EQUIPMENT DAMAGE.

Injury hazard

Failure to observe these instructions could lead to severe injury or death.

- Always** remove jewelry and wear eye protection.
- Always** use extreme caution when jacking up a vehicle for work. Set emergency brake and use tire blocks. Locate and use the vehicle manufacturers designated lifting points. Use jack stands.
- Always** use appropriate and adequate care in lifting components into place.
- Always** insure components will remain secure during installation and operation.
- Always** wear safety glasses when installing this kit. A drilling operation will cause flying metal chips. Flying chips can cause serious eye injury.
- Always** use extreme caution when drilling on a vehicle. Thoroughly inspect the area to be drilled (on both sides of material) prior to drilling, and relocate any objects that may be damaged.
- Always** use extreme caution when cutting and trimming during fitting.
- Always** tighten all nuts and bolts securely per installation instructions.
- Always** route electrical cables carefully. Avoid moving parts, components that become hot and rough or sharp edges.
- Always** insulate and protect all exposed wiring and electrical terminals.
- Always** perform regular inspections and maintenance on mounts and related hardware.



Installation Instructions

Ford F150 Front Vengeance

SKU Number: D1951, D1952

Application: 2009-2014 Ford F150

I. Overview

Congratulations on your new purchase of the industries' best and most stylish Front Vengeance Bumper available for the 2009 through 2014 Ford F150! This Bumper has been **engineered** for strength while keeping the weight down.

Your Front Bumper designed in 3-D from digitized data, CNC laser cut, fabricated, and powder coated... all in the U.S.A.

Enjoy the fit and finish of a quality Ford F150 Front Vengeance Bumper from Fab Fours Inc.

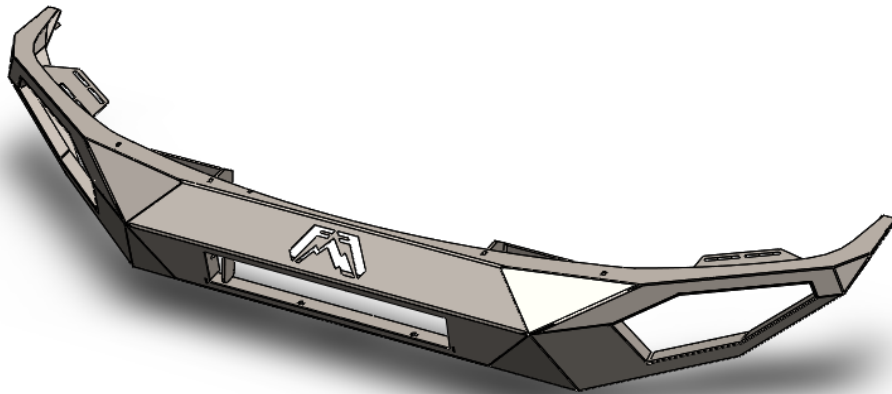



Installation Instructions

Ford F150 Front Vengeance

SKU Number: D1951, D1952

Application: 2009-2014 Ford F150

II. Tools Required

- Metric and Standard socket set
- Various socket extensions
- 3/4" box end wrench
- Philips head screwdriver
- Flat head screwdriver
- "Christmas tree" clip remover

III. Kit Contents

QTY	DESCRIPTION	FAB FOURS PART NUMBER
x 1	Ford F150 Front Bumper	D195X
x 1	D195X Hardware Kit	50039-HW
x 1	D195X Instruction Manual	D195X-IM

IV. Included Hardware

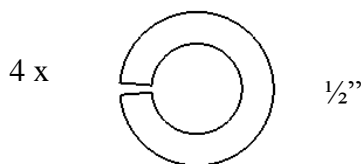
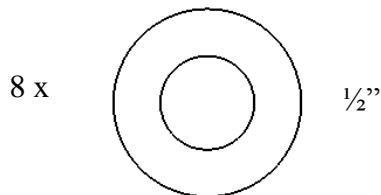
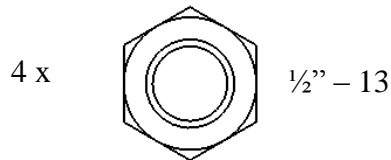
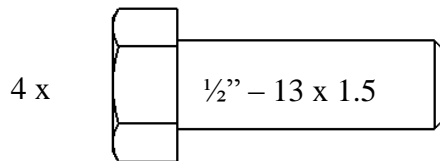



Installation Instructions

Ford F150 Front Vengeance

SKU Number: D1951, D1952

Application: 2009-2014 Ford F150

V. Removal of Stock Bumper

1. Remove the lower air dam by loosening the fastener (14mm socket) attaching it to each frame rail behind the tow hooks.
2. Remove the splash mat from the bumper by pulling out the plastic push clips.
3. If equipped, disconnect the fog lights and route the harness out of the way.
4. Open the hood and remove the lower safety latch bracket bolts that attach it to the steel portion of the OEM bumper with a 10mm socket.

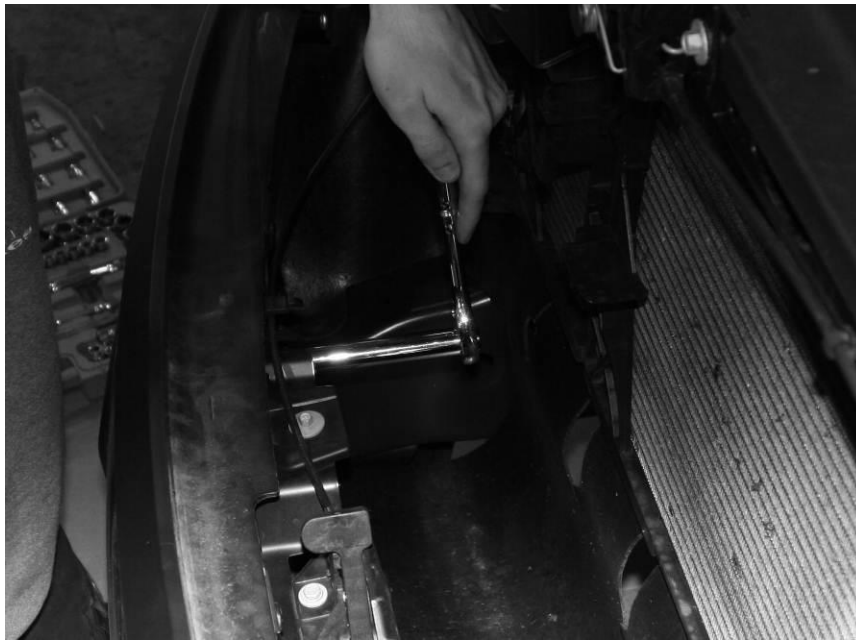

Figure 1 - HOOD LATCH BRACKET FASTENER LOCATION

5. Remove the (2) nuts from the main bumper mounting studs on each frame flange with a 21mm socket.

Installation Instructions

Ford F150 Front Vengeance

SKU Number: D1951, D1952

Application: 2009-2014 Ford F150



Figure 2 - BUMPER MOUNTING BOLTS (VIEW FROM TOP)

6. Center plastic valence reinforcement is held in place by several push pins underneath and behind valence. Remove push pins holding reinforcement without removing valence.

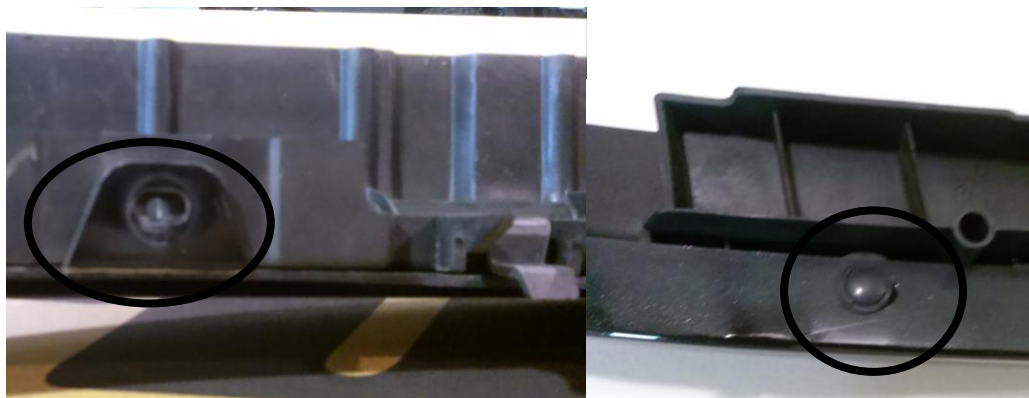

Figure 4- EXAMPLE OF BACK AND BOTTOM PUSH PIN LOCATIONS

7. Using two people, pull the bumper forward away from the truck. Be careful not to scratch the paint on the plastic above the bumper.
8. Remove the tow hooks using a 15mm socket.

Installation Instructions

Ford F150 Front Vengeance

SKU Number: D1951, D1952

Application: 2009-2014 Ford F150

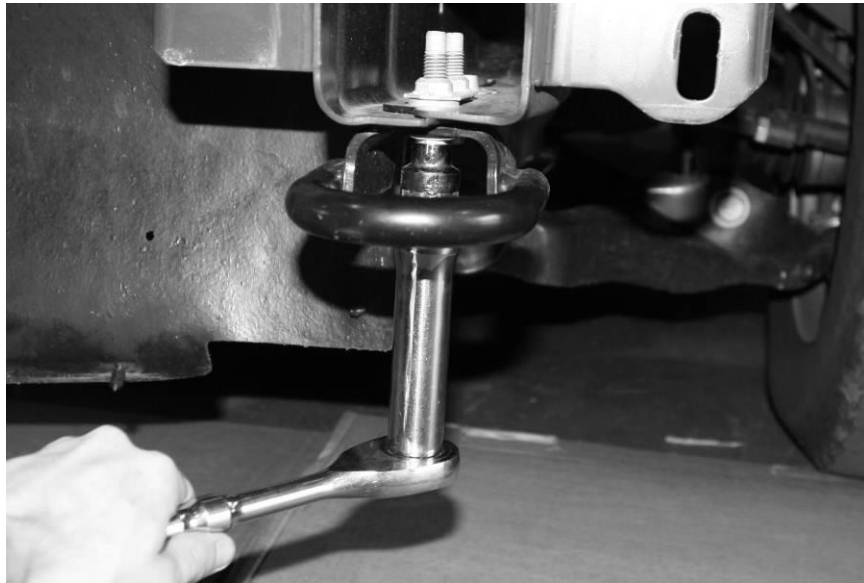

Your truck is now ready for the install of your new Fab Fours Front Bumper!

VI. Front Bumper Installation

1. With the help of a lifting device such as a floor jack, or with the help of multiple assistants, lift the bumper and align with the frame flanges.

Installation Instructions

Ford F150 Front Vengeance

SKU Number: D1951, D1952

Application: 2009-2014 Ford F150

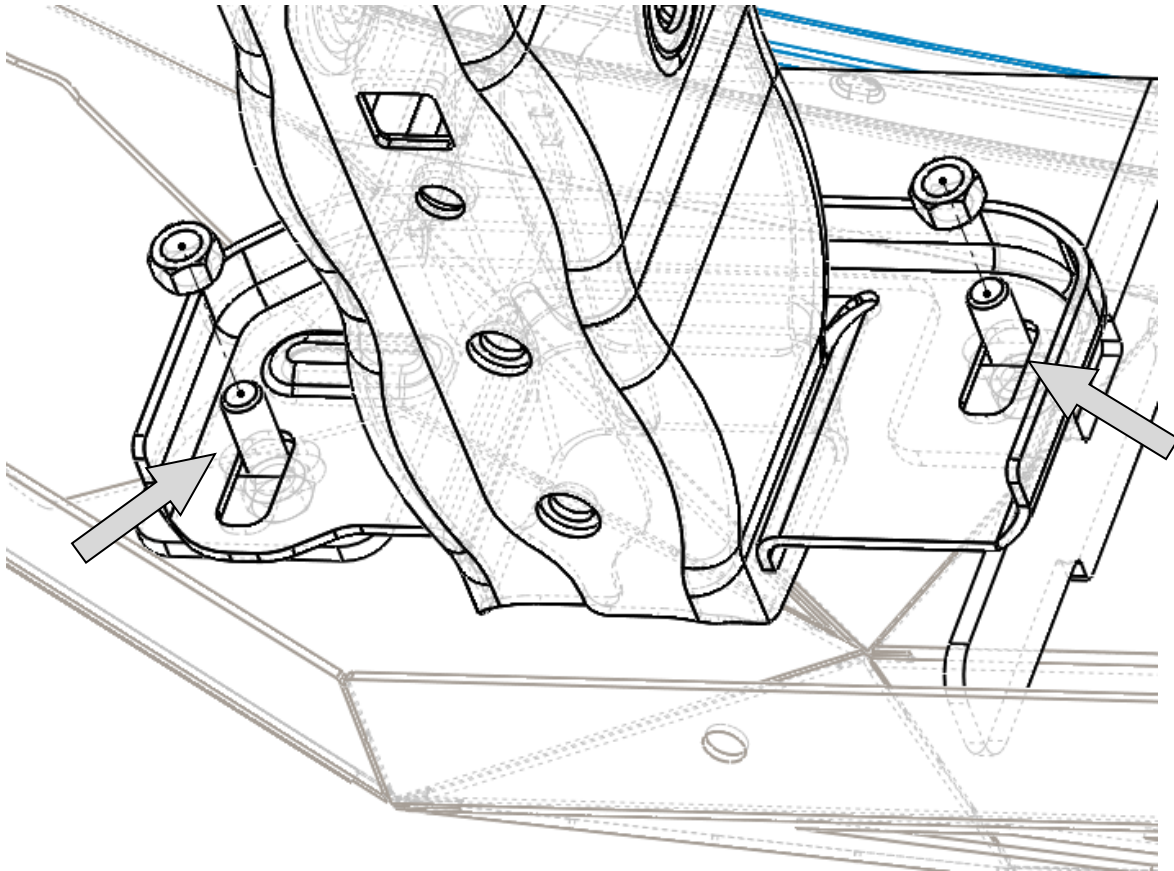

Figure 5 – FRAME FASTENER INSTALLATION LOCATION

2. Loosely install the provided $\frac{1}{2}$ "x1.5" bolts through the slots in the frame flange and mount plate.
3. Adjust the bumper to achieve good visual alignment side to side with equal gaps at each fender. Fully tighten the $\frac{1}{2}$ " bolts in the frame flanges with $\frac{3}{4}$ " socket and wrench.
4. Lift the bumper to achieve good visual alignment underneath the headlights and fenders. Once desired alignment is attained, fully tighten the bracket to bumper fasteners with a $\frac{3}{4}$ " socket.

NOTE: Fab Fours recommends a **MINIMUM** gap of a $\frac{1}{4}$ " or more at the outer fenders and headlights to prevent paint damage in normal operation.

5. Remove the spring nut from the OEM hood latch bracket and reinstall it on the Fab Fours bumper hood latch bracket. Use the OEM bolt to attach the hood latch lever to the bracket in the same orientation as the OEM installation.



Installation Instructions

Ford F150 Front Vengeance

SKU Number: D1951, D1952

Application: 2009-2014 Ford F150

VII. Maintenance/Care

- Periodically check and tighten all fasteners.
- Stripped, fractured, or bent bolts or nuts need to be replaced.
- After washing of the vehicle make sure to fully dry all surfaces



More than expected... Better than expected