



Installation Instructions

Vengeance Front Bumper

Product Number: D3551, D3552
Application: 2015-2016 Chevy Suburban

SAFETY

Your safety and the safety of others is very important.

- In order to help you make informed decisions about safety, we have provided installation instructions and other information.
- These instructions alert you to potential hazards that could hurt you or others.
- Please do a job safety analysis (JSA) before each task to identify potential hazards for your situation and remove/protect against them.
- You must use your own good judgment, and take your time.

Read and understand all safety precautions and instructions before installing this product.

**THIS PRODUCT IS FOR OFFROAD USE ONLY. ALL LIABILITY FOR
INSTALLATION AND USE RESTS WITH THE OWNER.**

**CARELESS INSTALLATION AND OPERATION CAN RESULT IN SERIOUS INJURY
OR EQUIPMENT DAMAGE.**

**SENSORS FIELD OF VIEW WILL BE ALTERED WITH USE OF THE
REPLACEMENT BUMPER.**

Injury hazard

Failure to observe these instructions could lead to severe injury or death.

- Always** remove jewelry and wear eye protection.
- Always** use extreme caution when jacking up a vehicle for work. Set emergency brake and use tire blocks. Locate and use the vehicle manufacturers designated lifting points. Use jack stands.
- Always** use appropriate and adequate care in lifting components into place.
- Always** insure components will remain secure during installation and operation.
- Always** wear safety glasses when installing this kit. A drilling operation will cause flying metal chips. Flying chips can cause serious eye injury.
- Always** use extreme caution when drilling on a vehicle. Thoroughly inspect the area to be drilled (on both sides of material) prior to drilling, and relocate any objects that may be damaged.
- Always** use extreme caution when cutting and trimming during fitting.
- Always** tighten all nuts and bolts securely per installation instructions.
- Always** route electrical cables carefully. Avoid moving parts, components that become hot and rough or sharp edges.
- Always** insulate and protect all exposed wiring and electrical terminals.
- Always** perform regular inspections and maintenance on mounts and related hardware.



Installation Instructions

Vengeance Front Bumper

Product Number: D3551, D3552
Application: 2015-2016 Chevy Suburban

I. Overview

Congratulations on your purchase of the industries' best and most stylish Chevy Suburban Bumper! This bumper has been **engineered** for strength while keeping the weight down.

Your bumper was designed in 3-D, fabricated, and powder coated... all in the U.S.A.

Enjoy the fit and finish of a quality Chevy Suburban Vengeance Bumper from Fab Fours Inc.



Installation Instructions

Vengeance Front Bumper

Product Number: D3551, D3552
Application: 2015-2016 Chevy Suburban

II. Parts List

- D355X replacement bumper
- 50089-HW fastener kit
- Instruction manual

III. Tools Required

- Socket wrench with extension (ratcheting wrenches may also be convenient)
- 7mm, 8mm, 9mm, 10mm, 15mm sockets and box end wrenches
- 7/16" wrench and 7/16" ratchet wrench
- T15 torx
- Hex key sets
- Flat head screw drivers
- Floor jack and wood block



Installation Instructions

Vengeance Front Bumper

Product Number: D3551, D3552
Application: 2015-2016 Chevy Suburban

IV. Vehicle Preparation

1. Open hood and remove the 12 plastic push clips securing the plastic radiator shroud. Using a small screwdriver or pick, carefully pull the centers of the clips up. Once centers are up, the clips are safe to remove. Once the clips are out, shroud will be able to be removed. See Figure 1.

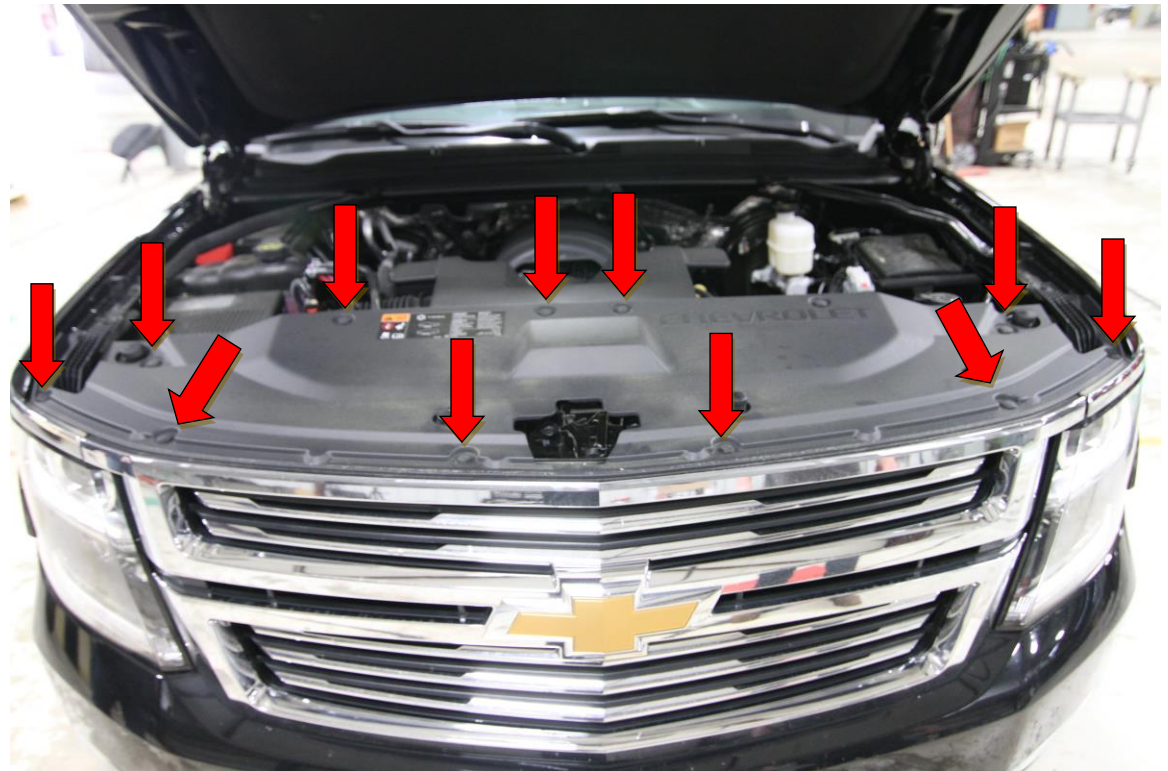

Figure 1

2. Using a 10mm socket and ratchet remove the six 10mm bolts securing the upper grille assembly to the radiator support. See Figure 2



Installation Instructions

Vengeance Front Bumper

Product Number: D3551, D3552
Application: 2015-2016 Chevy Suburban

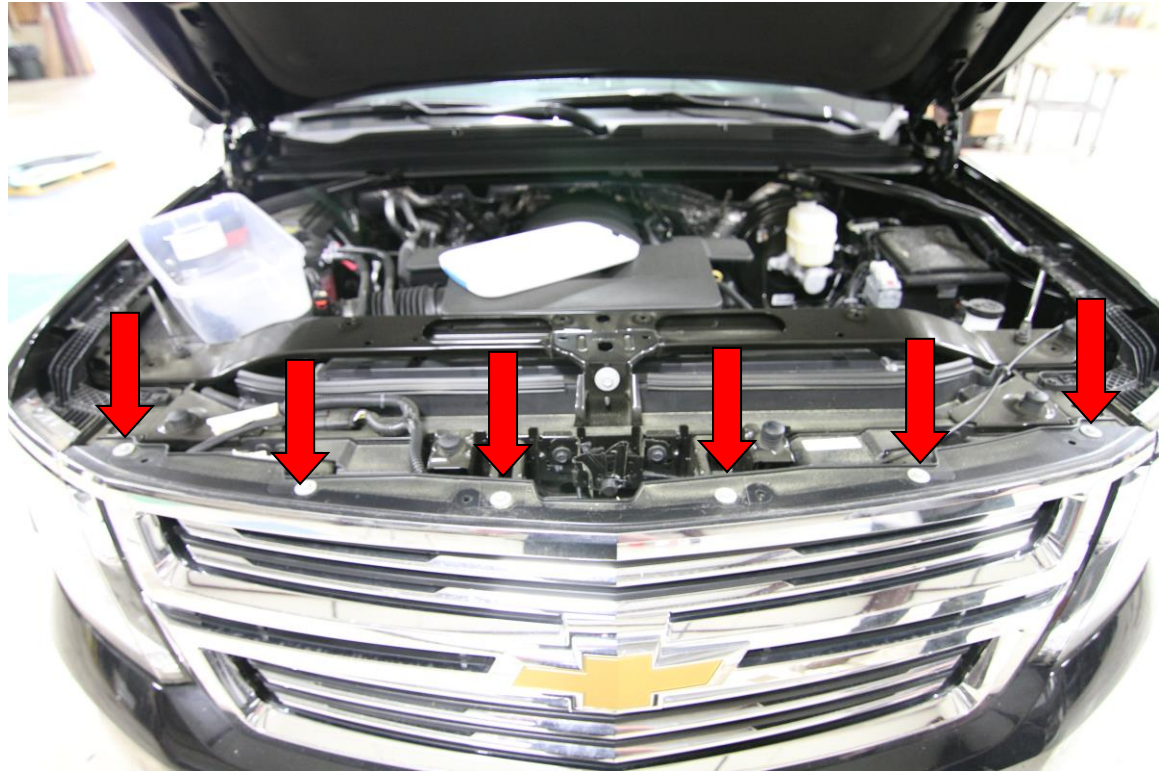

Figure 2

3. Next remove the six 7mm bolts securing the inner fender to the bumper cover. See Figure 3. You can turn the wheels while doing this to allow more room to work.



Installation Instructions

Vengeance Front Bumper

Product Number: D3551, D3552

Application: 2015-2016 Chevy Suburban



Figure 3



Installation Instructions

Vengeance Front Bumper

Product Number: D3551, D3552

Application: 2015-2016 Chevy Suburban

4. Next under the front bumper remove the eight 10mm bolts securing the bottom of the bumper to the chassis. Two in the center and three on each side. Finally remove the clips securing the wiring harness to the bumper.
5. Next gently pull back on the grille assembly allowing access to the rear of grille. Then remove the two 10mm bolts securing the grille to the chassis. Next disconnect the fog light wiring harness, finally using a flathead screwdriver depress the lower tabs securing bumper to chassis. See Figure 5.

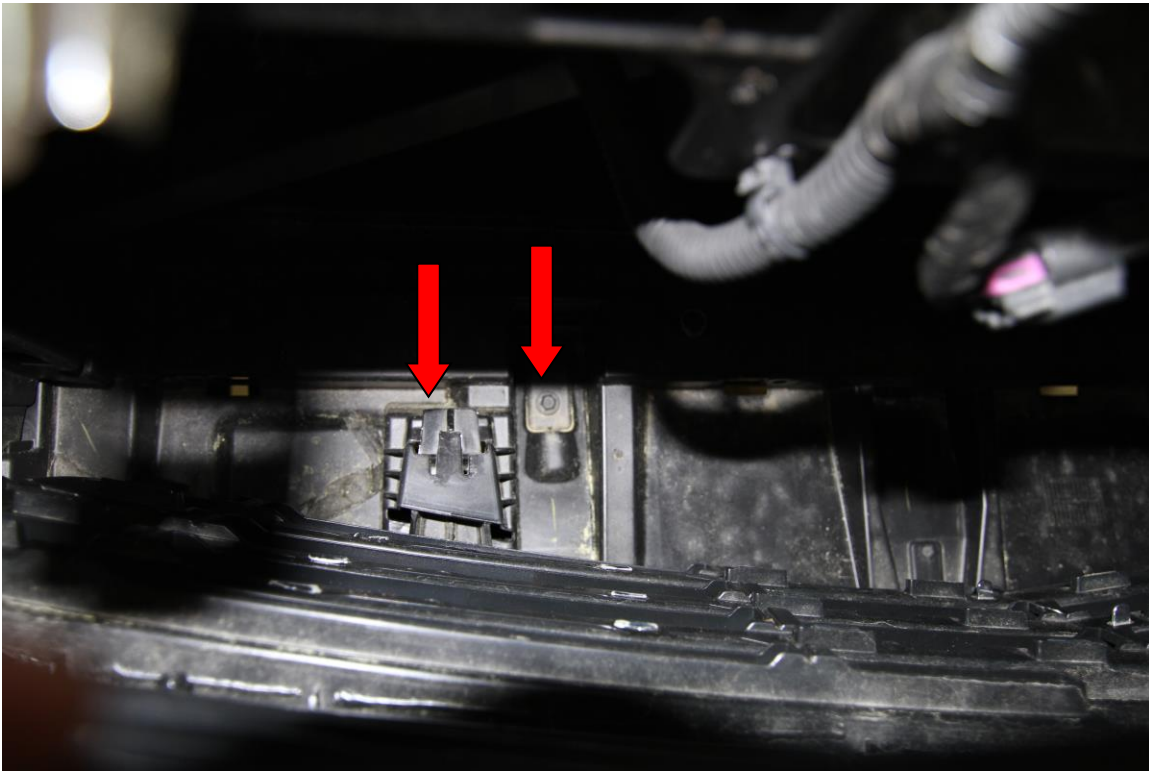

Figure 5

6. Next starting at rear of bumper, gently pull the bumper cover away from vehicle. This may require a good amount of force. Repeat on other side.



Installation Instructions

Vengeance Front Bumper

Product Number: D3551, D3552
Application: 2015-2016 Chevy Suburban



7. Bumper is now safe to remove. Using two people pull bumper cover and grille off vehicle in one piece.
8. Lay bumper face down on a soft surface being careful not to scratch grille as it will be reused. Unclip the wiring harness from grille and bumper, you can also remove park assist sensors at this time. Remove the five 10mm bolts from each side of grille securing it to the bumper cover. (Set grille, wiring harness and sensors aside as they will be reused later.)
9. Next remove the crash bar by removing the six (three on each side of crash bar) 15mm bolts shown in Figure 7. Save 15mm bolts as they will be reused in the installation of Fab Fours bumper. If applicable you may also remove tow hooks at this time.



Installation Instructions

Vengeance Front Bumper

Product Number: D3551, D3552

Application: 2015-2016 Chevy Suburban

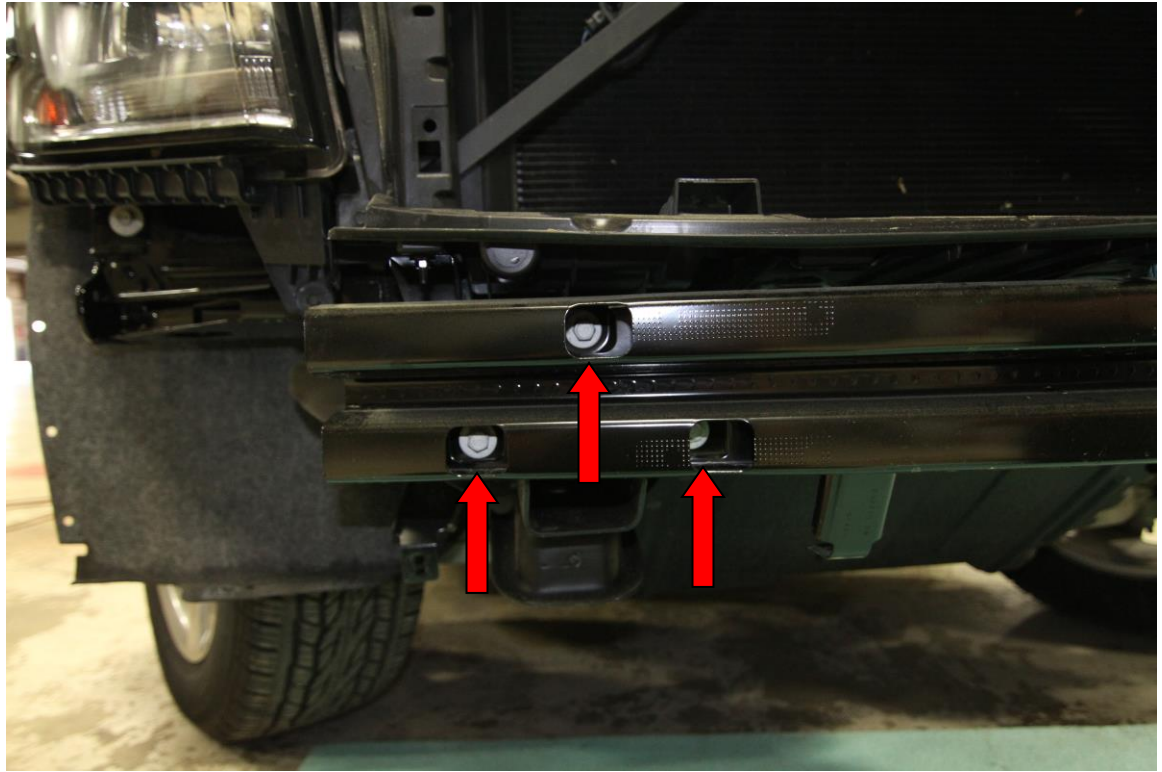

Figure 7

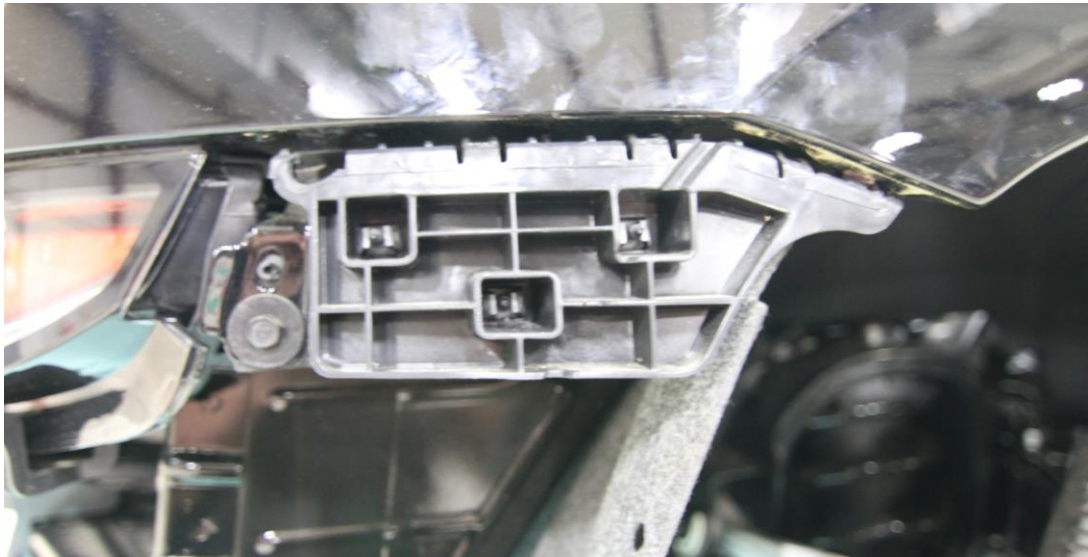

Figure 8

10. Next remove the black bumper cover mounts located on each fender (see Figure 8). Remove the three 10mm bolts shown in Figure 9.



Installation Instructions

Vengeance Front Bumper

Product Number: D3551, D3552
Application: 2015-2016 Chevy Suburban

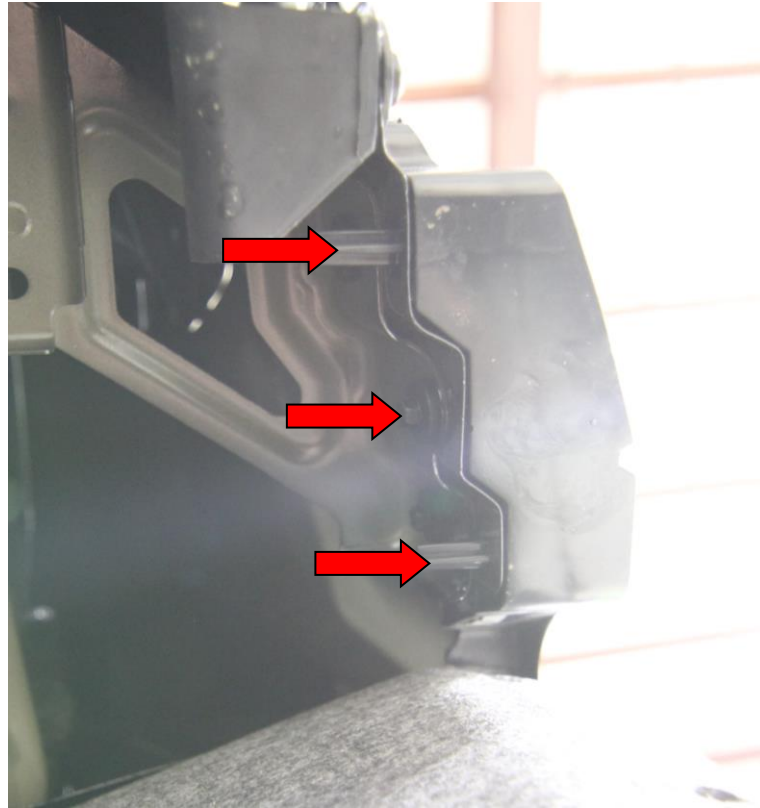

Figure 9



Figure 10



Installation Instructions

Vengeance Front Bumper

Product Number: D3551, D3552

Application: 2015-2016 Chevy Suburban

11. Next remove the bumper mount located under each headlight shown in Figure 10. Do so by removing the three torx screws shown in Figure 11.

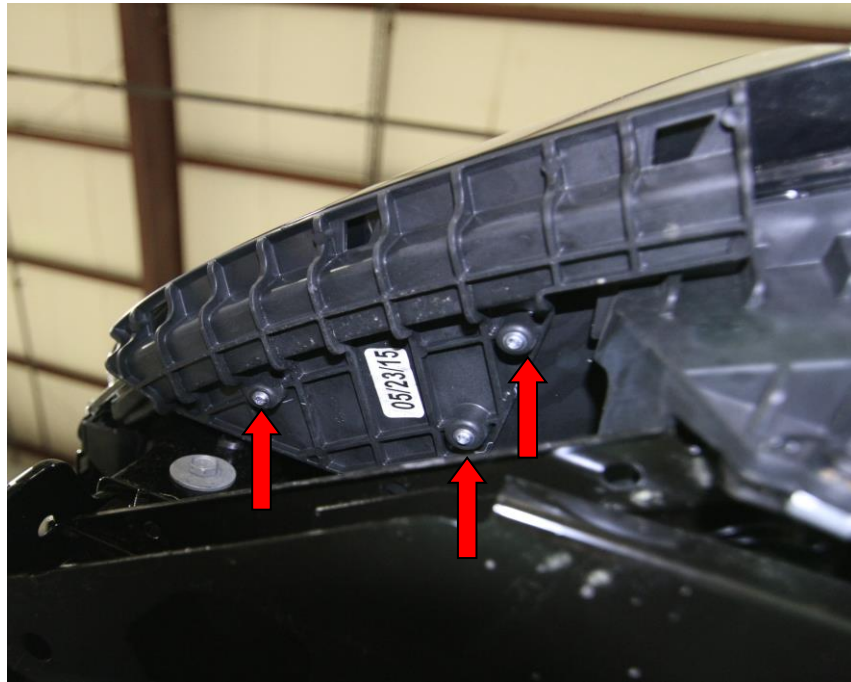

Figure 11

12. Lastly, remove bumper support brackets from back of body mounts (ref image below). Using a 15mm socket remove two bolts from each side.

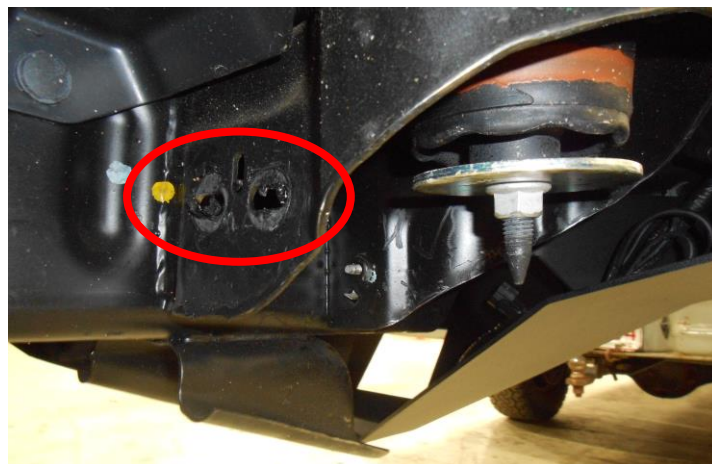

Figure 12a (passenger side body mount)



Installation Instructions

Vengeance Front Bumper

Product Number: D3551, D3552
Application: 2015-2016 Chevy Suburban



Figure 12b (support brackets)



Installation Instructions

Vengeance Front Bumper

Product Number: D3551, D3552
Application: 2015-2016 Chevy Suburban

V. Sensor Installation

1. Feed sensor harness through the cutouts in brackets. Make sure that the plug for the OEM harness is on the passenger side of bumper. Zip-tie holes for harness indicated by arrows.

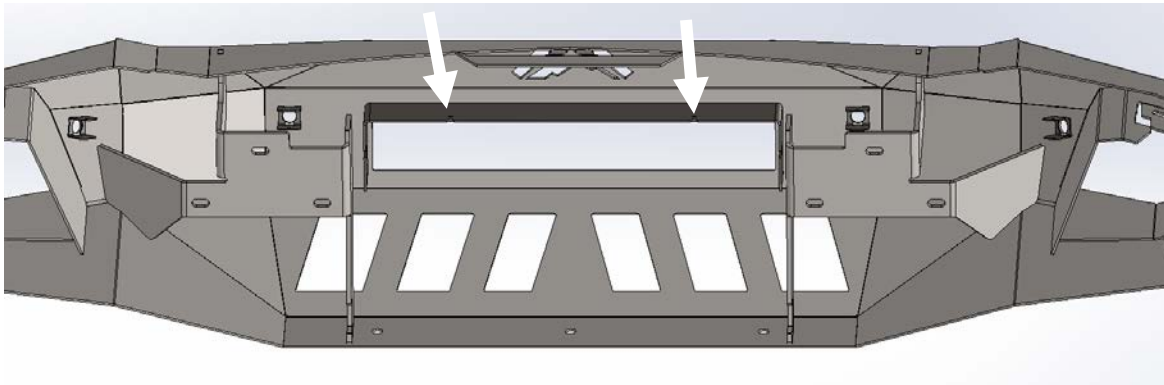

Figure 13

2. Sensor housings should all point toward center of bumper, and will clip directly to mounts that are welded in the bumper. See below.

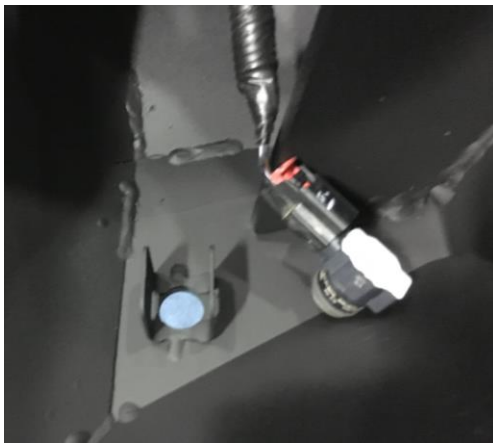

Figure 14

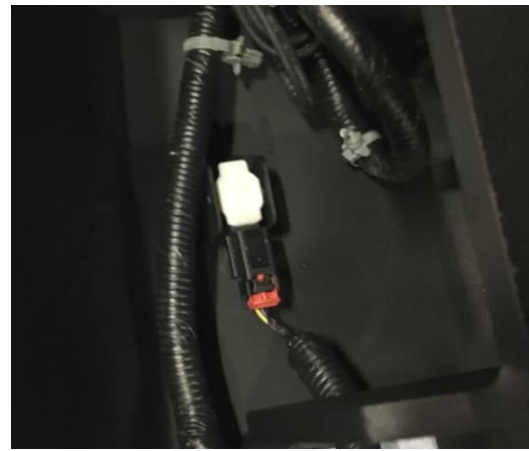

Figure 15



Installation Instructions

Vengeance Front Bumper

Product Number: D3551, D3552

Application: 2015-2016 Chevy Suburban

3. Sensor harness plug should be fed back through hole so it can be accessed via the grille after bumper is mounted. Refer to **bumper installation step 2**.

VI. Bumper Installation

1. Using Fab Fours provided grille mounting braces and ¼" hardware, place them onto the top of the plastic core support shell housing. Install bracing into plastic support by lining up the back edge of the brace with the edge of cutout on both sides. See Figure 16a. Refit the grille to the vehicle by locating the lower plastic clips on the shell of the grille and sliding the clips under the bracket such that engages the slots. See Figure 16b. **Do not bolt in the top of the grille** until the sensor harness plug has been fished back through the hole and plugged in **after bumper installation step 2**. See Figure 16c.

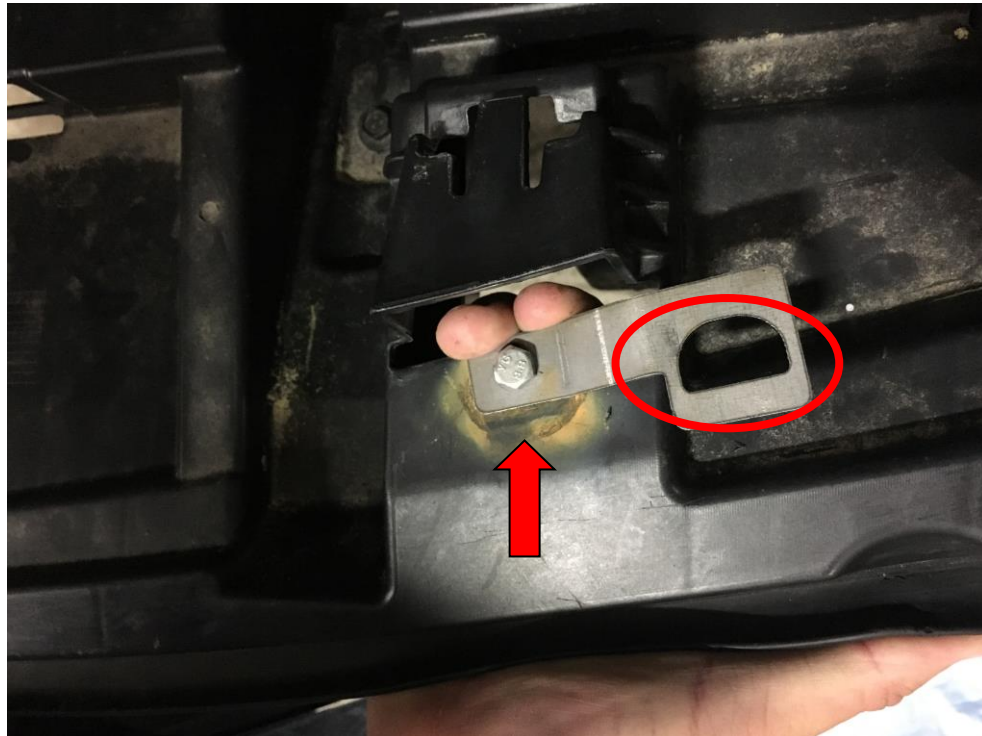

Figure 16a



Installation Instructions
Vengeance Front Bumper
Product Number: D3551, D3552
Application: 2015-2016 Chevy Suburban

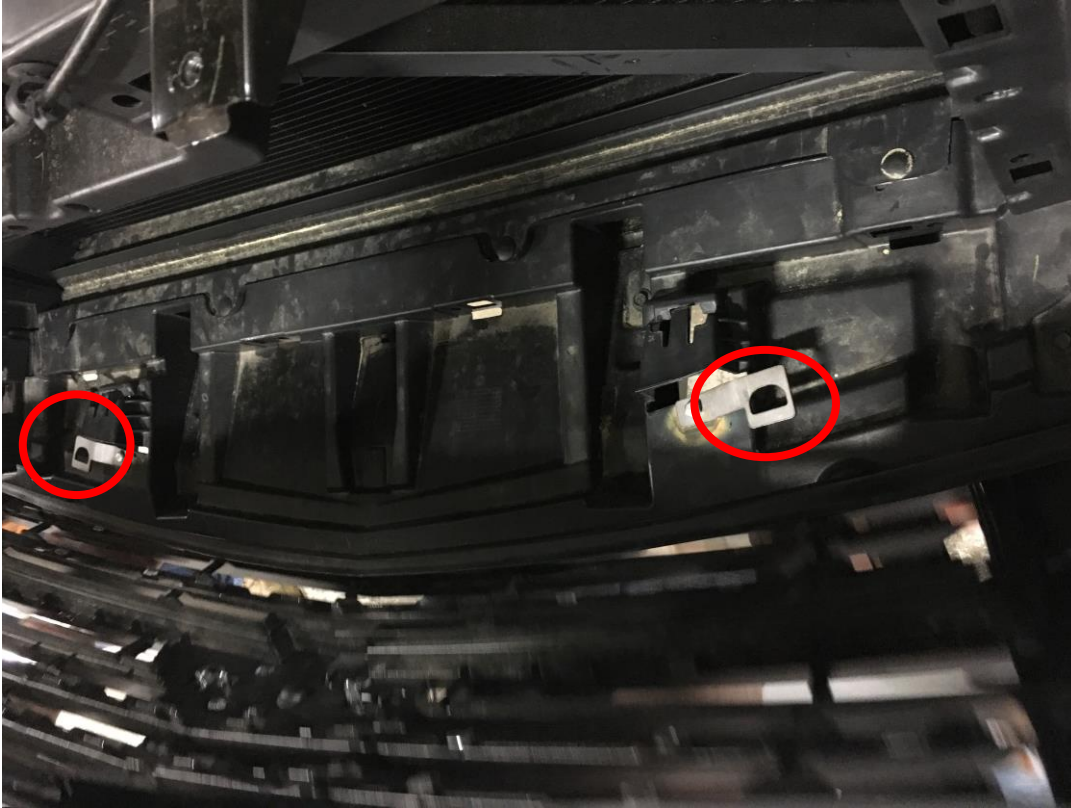

Figure 16b



Installation Instructions
Vengeance Front Bumper
Product Number: D3551, D3552
Application: 2015-2016 Chevy Suburban



Figure 16c



Installation Instructions

Vengeance Front Bumper

Product Number: D3551, D3552

Application: 2015-2016 Chevy Suburban

2. With the help of at least two others or a lifting device, lift and align the bumper mounts with the frame mounts. At this time it is easiest to run the wiring harness back up into the hole and behind the grill (ref. figure 17a). With the bumper fully supported install the bumper using the 6 OEM bolts, removed in figure 7, and a 15mm socket. **DO NOT FULLY TIGHTEN.**



Figure 17a

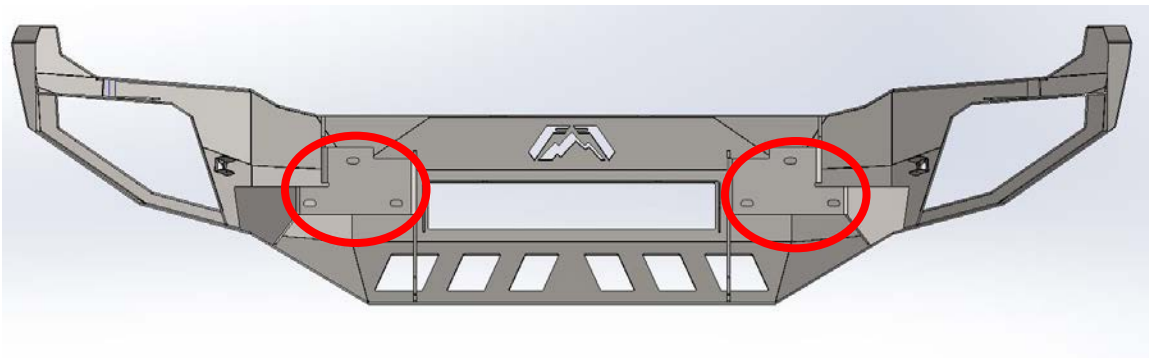

Figure 17b



Installation Instructions

Vengeance Front Bumper

Product Number: D3551, D3552
Application: 2015-2016 Chevy Suburban

3. Adjust left and right as needed.
4. Tighten all fasteners fully.
5. **OPTIONAL:** Trim the inner fender liners to match the higher clearance of your Fab Fours bumper. This can be done with a body saw, rotary tool, or sharp utility knife (New blade strongly recommended). **USE CAUTION WHEN PERFORMING ANY CUTTING OPERATION TO PREVENT VEHICLE DAMAGE OR PERSONAL INJURY.**