



# Installation Instructions

'15 Chevy HD Black Steel Front Bumper

Product Number: S3060, S3061, S3062, Q3060, Q3061, Q3062

Application: '15 CHEVY HD

## SAFETY

Your safety and the safety of others is very important.

- In order to help you make informed decisions about safety, we have provided installation instructions and other information.
- These instructions alert you to potential hazards that could hurt you or others.
- Please do a job safety analysis (JSA) before each task to identify potential hazards for your situation and remove/protect against them.
- You must use your own good judgment, and take your time.

Read and understand all safety precautions and instructions before installing this product.

**THIS PRODUCT IS FOR OFFROAD USE ONLY. ALL LIABILITY FOR INSTALLATION AND USE RESTS WITH THE OWNER.**

**CARELESS INSTALLATION AND OPERATION CAN RESULT IN SERIOUS INJURY OR EQUIPMENT DAMAGE.**

## Injury hazard

Failure to observe these instructions could lead to severe injury or death.

- Always remove jewelry and wear eye protection.
- Always use extreme caution when jacking up a vehicle for work. Set emergency brake and use tire blocks. Locate and use the vehicle manufacturers designated lifting points. Use jack stands.
- Always use appropriate and adequate care in lifting components into place.
- Always insure components will remain secure during installation and operation.
- Always wear safety glasses when installing this kit. A drilling operation will cause flying metal chips. Flying chips can cause serious eye injury.
- Always use extreme caution when drilling on a vehicle. Thoroughly inspect the area to be drilled (on both sides of material) prior to drilling, and relocate any objects that may be damaged.
- Always use extreme caution when cutting and trimming during fitting.
- Always tighten all nuts and bolts securely per installation instructions.
- Always route electrical cables carefully. Avoid moving parts, components that become hot and rough or sharp edges.
- Always insulate and protect all exposed wiring and electrical terminals.
- Always perform regular inspections and maintenance on mounts and related hardware.





# Installation Instructions

## '15 Chevy HD Black Steel Front Bumper

Product Number: S3060, S3061, S3062, Q3060, Q3061, Q3062

Application: '15 CHEVY HD

### I. Overview

Congratulations on your new purchase of the industries' best and most stylish Front Bumper available for the 2015 Chevy Heavy Duty! This Bumper has been engineered for strength while keeping the weight down.

Your Front Bumper designed in 3-D from digitized data, CNC laser cut, fabricated, and powder coated... all in the U.S.A.

Enjoy the fit and finish of a quality CHEVY HD Front Bumper from FabFours Inc.





# Installation Instructions

## '15 Chevy HD Black Steel Front Bumper

Product Number: S3060, S3061, S3062, Q3060, Q3061, Q3062

Application: '15 CHEVY HD

### Parts List

- S306X replacement bumper
- S306X-HW fastener kit
- 20260 lower guard
- 20260-HW fastener kit
- 2x tow hooks
- Instruction Manual

### Tools Required

- Socket Wrench with Extension (Ratcheting wrenches may also be convenient)
- 7mm , 15mm , 18mm, 19mm, 3/4 Sockets and Box End Wrenches
- Flat Head Screw Drivers
- Floor Jack and wood block.
- 9/16 drill bit w/ drill

## II. Removal of OEM Bumper

**Note: Save all OEM parts until installation is complete!**

- A. Open hood and locate push pins on radiator cover. Using a flat head screw driver, pull the head of the push pins up, remove push pin and lift radiator cover off. This will allow access to top Grille bolts (Ref. Figure 1).



Figure 1

- B. Remove the fasteners connecting the grille to the frame. Four bolts, are located at the top of the grille, two on each side (Ref. Figure 2a-b). Two bolts and two clips are located behind the grille and are indicated by the ovals and triangles respectively (Ref. Figure 2c).





# Installation Instructions

## '15 Chevy HD Black Steel Front Bumper

Product Number: S3060, S3061, S3062, Q3060, Q3061, Q3062

Application: '15 CHEVY HD



Figure 2a



Figure 2b

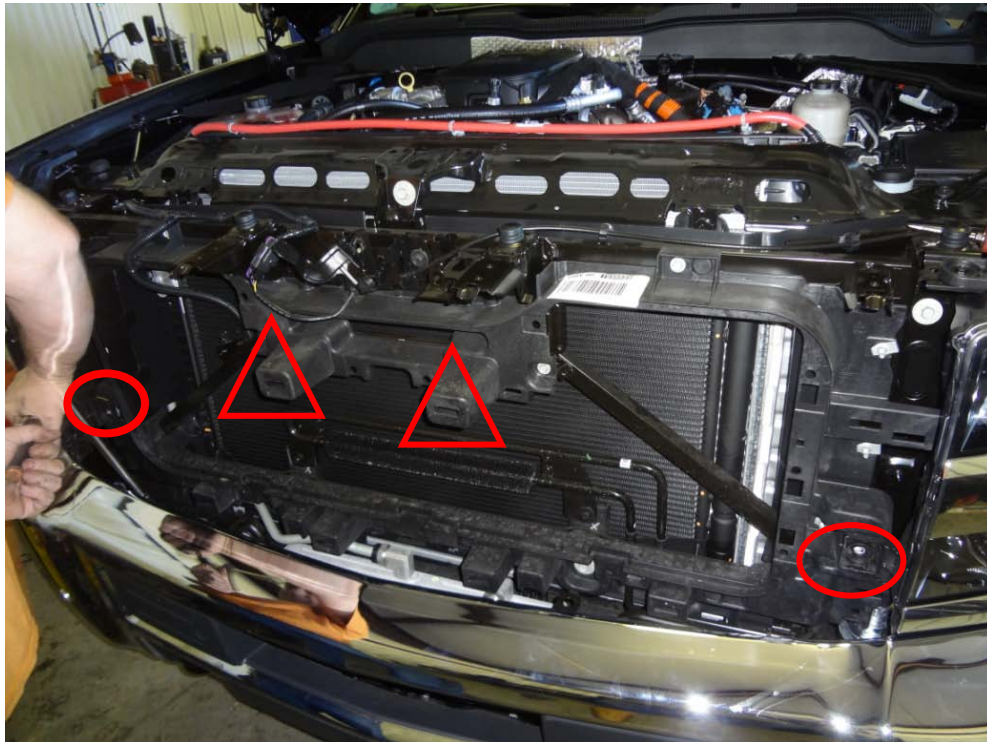

Figure 2c





## Installation Instructions

### '15 Chevy HD Black Steel Front Bumper

Product Number: S3060, S3061, S3062, Q3060, Q3061, Q3062

Application: '15 CHEVY HD

- C. Disconnect electrical harness (Ref. Figure 3a) from vehicle and remove tow hooks. Tow hooks are mounted with one cross bolt through the side and a bolt through the bottom of the frame (Ref. Figure 3b).

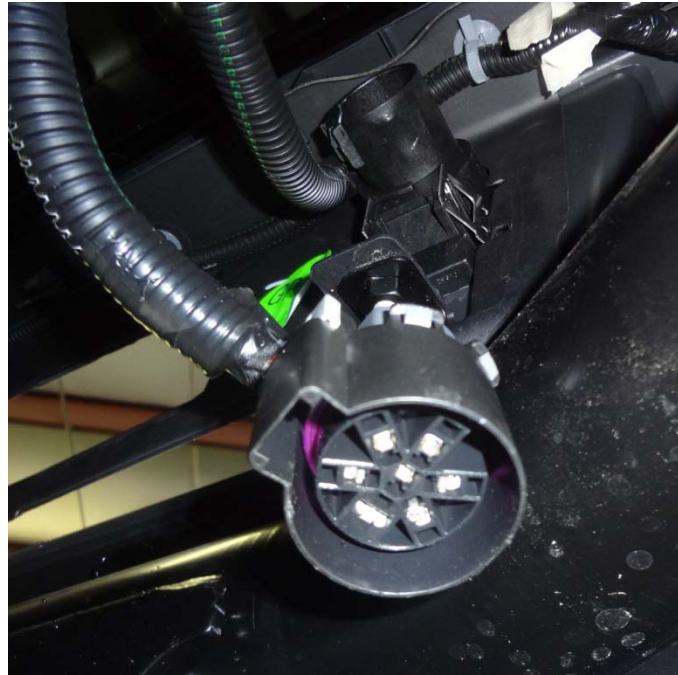

Figure 3a (ELECTRICAL HARNESS DISCONNECTED)



Figure 3b (TOW HOOK & OEM MOUNTING BRACKET)





## Installation Instructions

### '15 Chevy HD Black Steel Front Bumper

Product Number: S3060, S3061, S3062, Q3060, Q3061, Q3062

Application: '15 CHEVY HD

- D. Remove bolts connecting bumper to mounting bracket. There is one bolt on each side which requires a socket wrench with an extension to easily reach (Ref. Figure 4). Carefully Pull bumper away from vehicle.



Figure 4

- E. Remove the fasteners connecting the OEM mounting bracket to the frame. Using a socket/wrench remove bolts from front of bracket connected to the bumper. Repeat process on each side of vehicle.

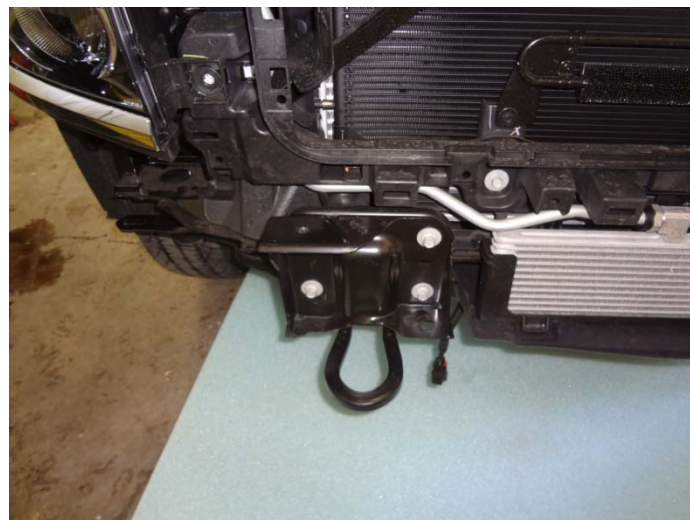

Figure 5





## Installation Instructions

### '15 Chevy HD Black Steel Front Bumper

Product Number: S3060, S3061, S3062, Q3060, Q3061, Q3062

Application: '15 CHEVY HD

- F. Remove OEM electrical harness from bumper. Disconnect harness from fog lights and sensors. Pop out the three plastic clips holding fog lights to fog light housing and carefully pull away, the plastic clips are indicated by a circle. Unbolt bumper support frames as necessary to more easily access sensors, start with the bottom bolts indicated by squares (Ref. Figure 6).

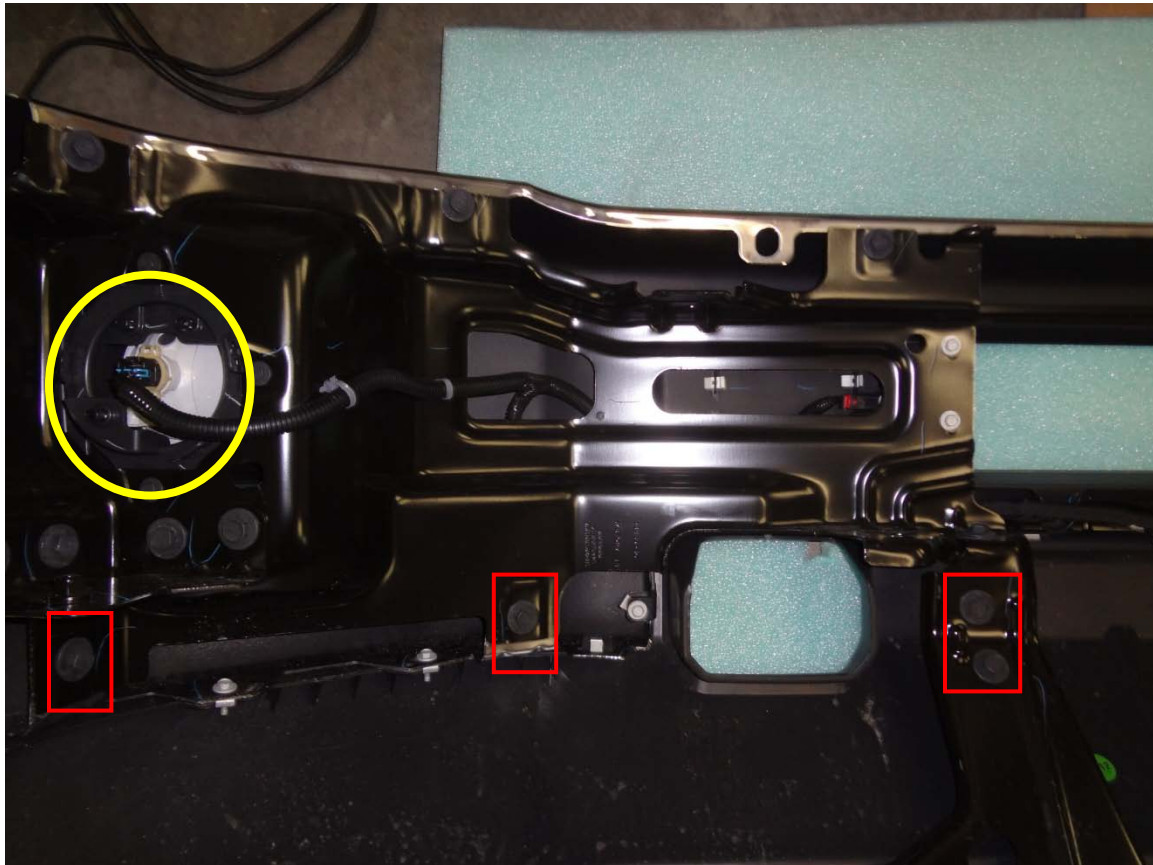

Figure 6

### III. Pre-Installation

**NOTE: The Following Installation steps apply to the installation of the Front Bumper. PLEASE READ THE ENTIRE MANUAL BEFORE ATEMPTING INSTALLATION! Ignoring these steps will increase your probability of scratching the vehicle during product**





## Installation Instructions

### '15 Chevy HD Black Steel Front Bumper

Product Number: S3060, S3061, S3062, Q3060, Q3061, Q3062

Application: '15 CHEVY HD

- A. Remove the Bumper from the shipping carton. Lay all items out on a blanket to prevent damage to the powder coating.
- B. Install the OEM fog lights onto the mounting brackets as shown below.

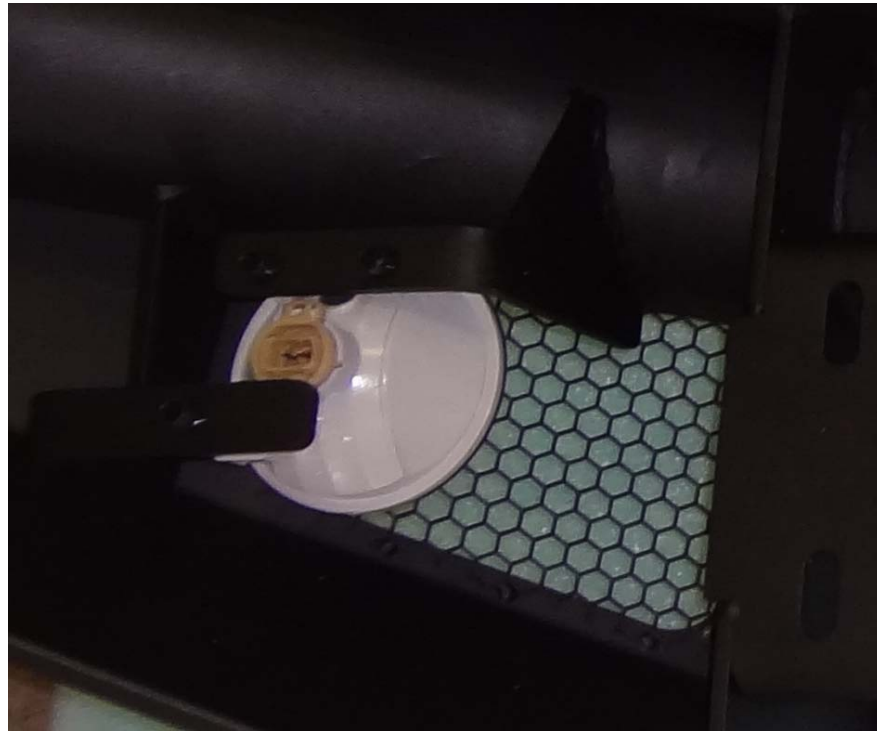

Figure 7

- **Optional:** If installing winch and roller fairlead into bumper, do it at this time. Follow the winch manufacturer's instructions for installation.

If not installing a winch, the lower guard may be installed at this time.

#### IV. Front Bumper Installation

- A. Mount bracket to truck frame. Two bolts pass through the side of the frame. One bolt passes through the bottom of the frame (Ref. 8a-b). Mount on both sides. If holes on the side of frame are out of tolerance then enlarge hole with 9/16 drill as needed on side of frame.







## Installation Instructions

### '15 Chevy HD Black Steel Front Bumper

Product Number: S3060, S3061, S3062, Q3060, Q3061, Q3062

Application: '15 CHEVY HD



Figure 8a



Figure 8b

- B. Mount bracket to bumper. With the help of at least two others, and possibly a floor jack, to support the center of the bumper, lift the Fab Fours bumper into place (Ref. 9a-c).**



Figure 9a



Figure 9b



Figure 9c

- C. Insert the bolts from the outside facing in and tighten (Ref. 9a-c). Do Not Fully Tighten, Hand Tighten Only!**





## Installation Instructions

### '15 Chevy HD Black Steel Front Bumper

Product Number: S3060, S3061, S3062, Q3060, Q3061, Q3062

Application: '15 CHEVY HD

- D. **Align the bumper side to side and top to bottom to ensure a perfect fit to the truck. Allow clearance to all painted surfaces, this is to allow for frame flex.**
- E. **Fully tighten all fasteners between bumper and bracket.**
  
- F. **Install the lower guard and tow hooks. Two bolts on each side for each item are required (Ref. 10a-b).**

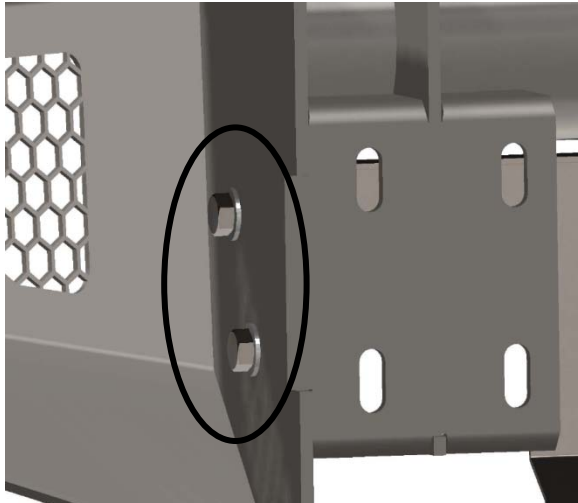

Figure 10a (bolt location for lower guard)

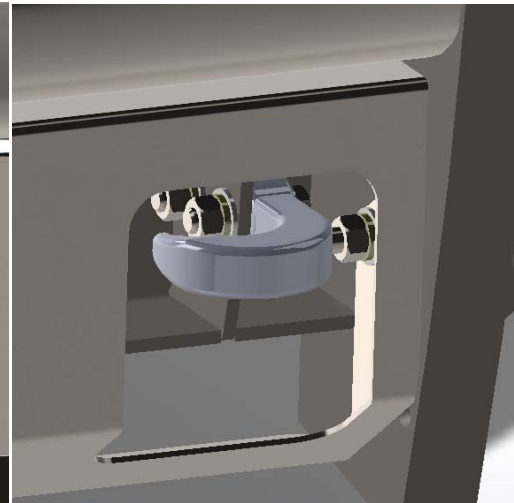

Figure 10b (tow hook mounting location)

- G. **The fog light may be connected at this time. To do so, connect OEM Harness back to OEM fog lights and secure excess wiring to bumper.**
- H. **Enjoy your New Front Replacement Bumper from Fab Fours!**





## Installation Instructions

### '15 Chevy HD Black Steel Front Bumper

Product Number: S3060, S3061, S3062, Q3060, Q3061, Q3062

Application: '15 CHEVY HD

#### *Maintenance/Care*

- Periodically check and tighten all fasteners.
- Stripped, fractured, or bent bolts or nuts need to be replaced.
- After washing of the vehicle make sure to fully dry all surfaces



More than expected... Better than expected

