

Installation Instructions

Tape-on Wind Deflectors

Safety Precautions



- **WARNING** – Before driving, make sure your wind deflector is firmly attached to your vehicle.
- Avoid using automatic brush-style car washes.
- Avoid using any cleaning solvents.
- Regularly inspect all components for tightness.

2-Piece Kit Includes:

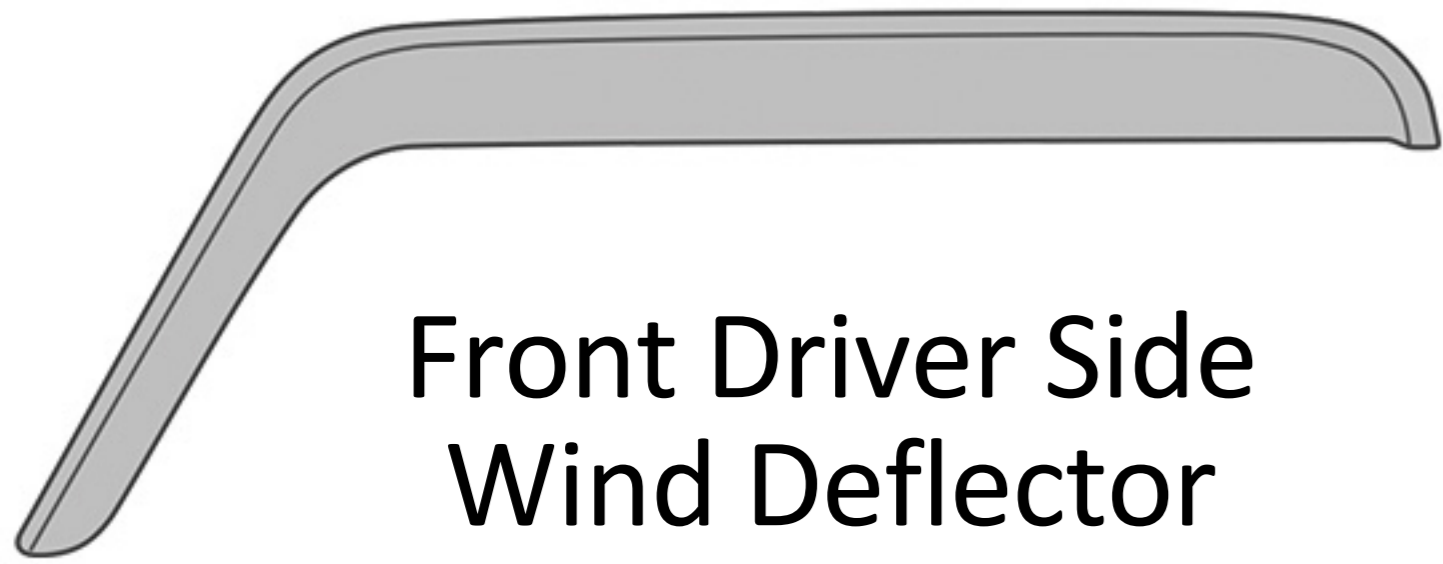

Front Driver Side
Wind Deflector

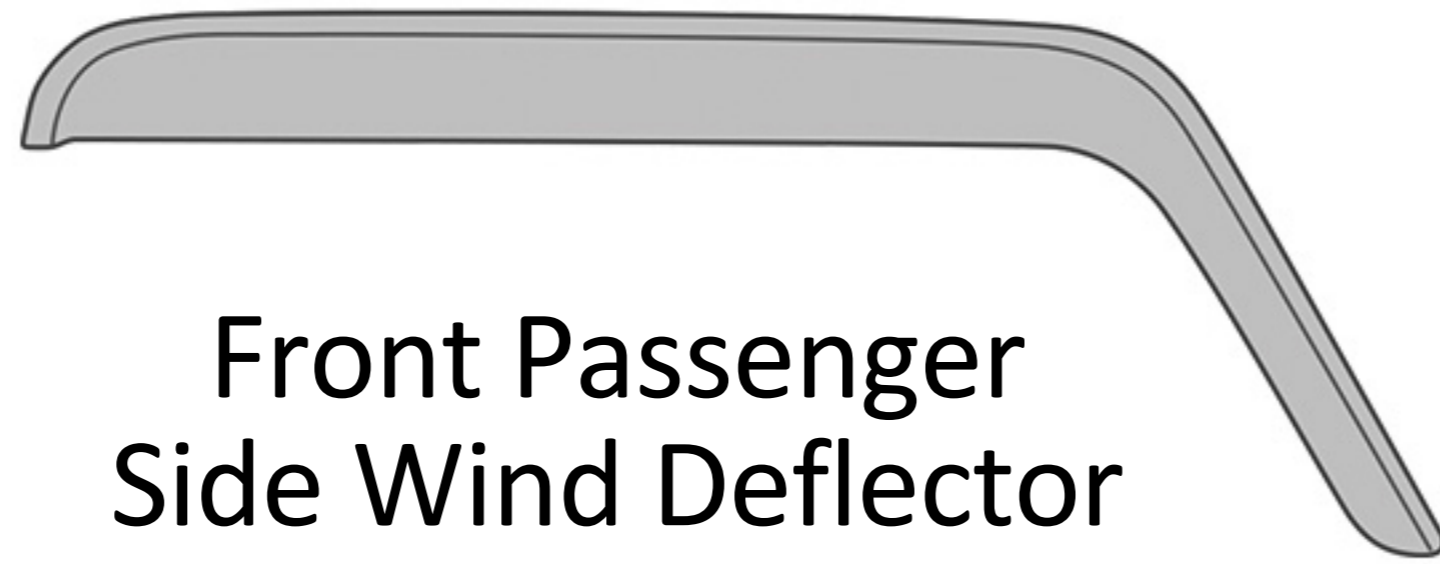

Front Passenger
Side Wind Deflector



2 Alcohol Pads

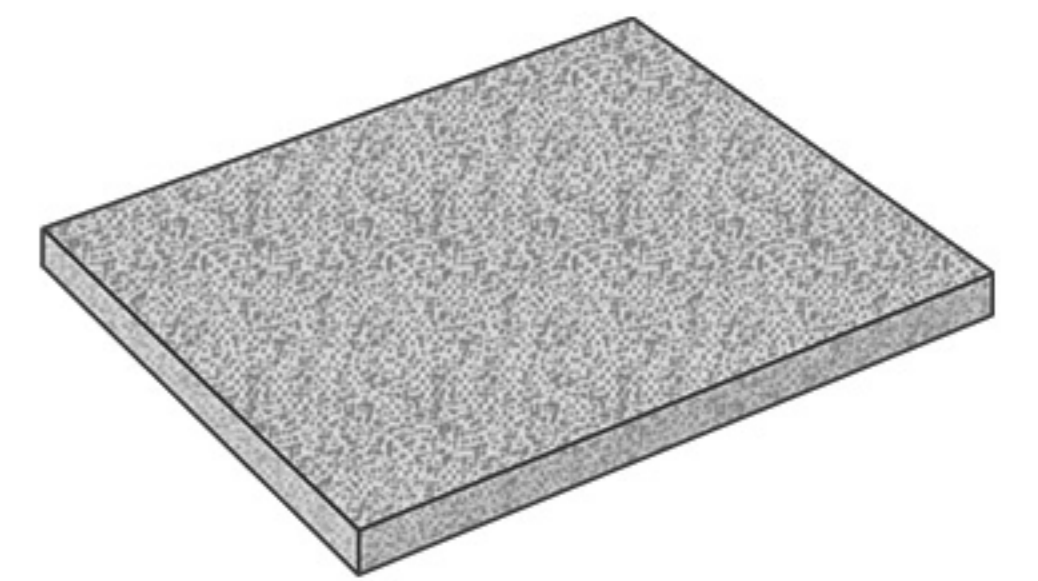

Scotch Brite Pad

4-Piece Kit Includes:

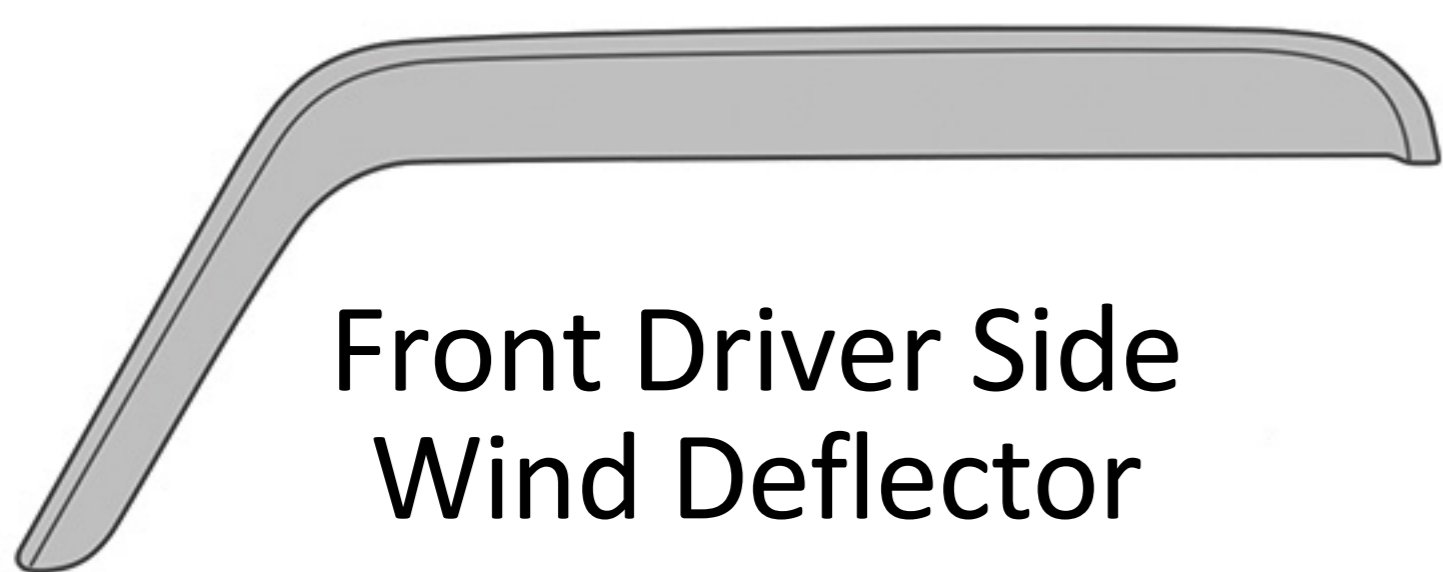

Front Driver Side
Wind Deflector

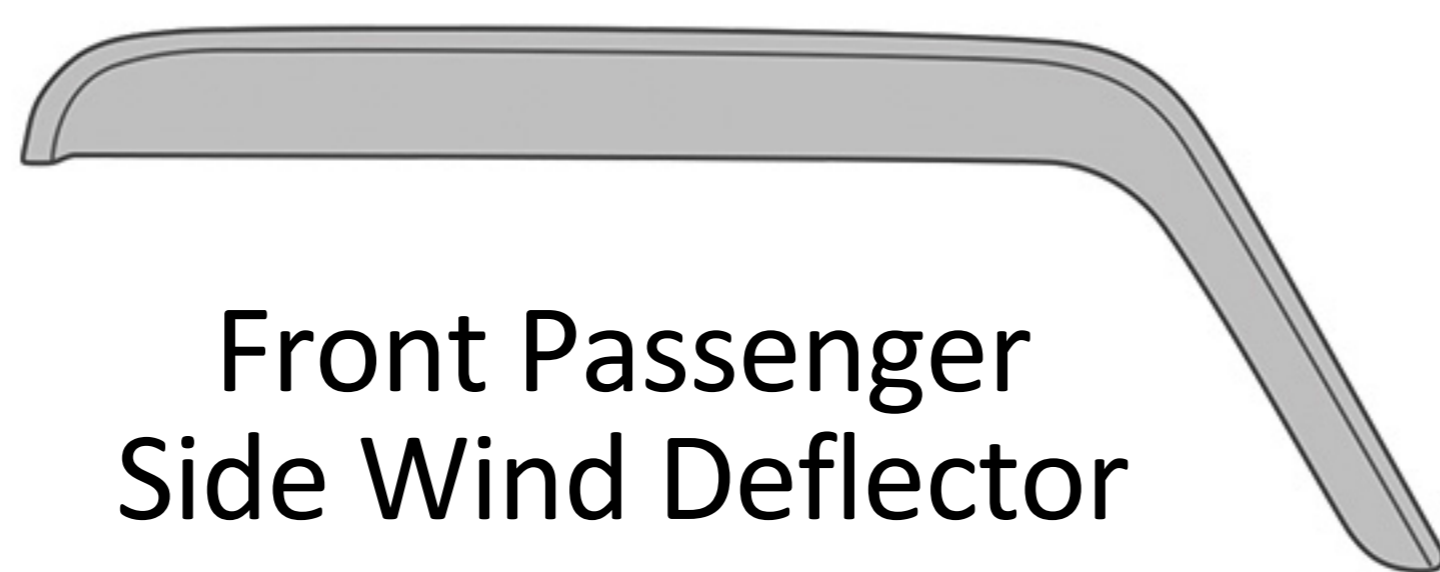

Front Passenger
Side Wind Deflector

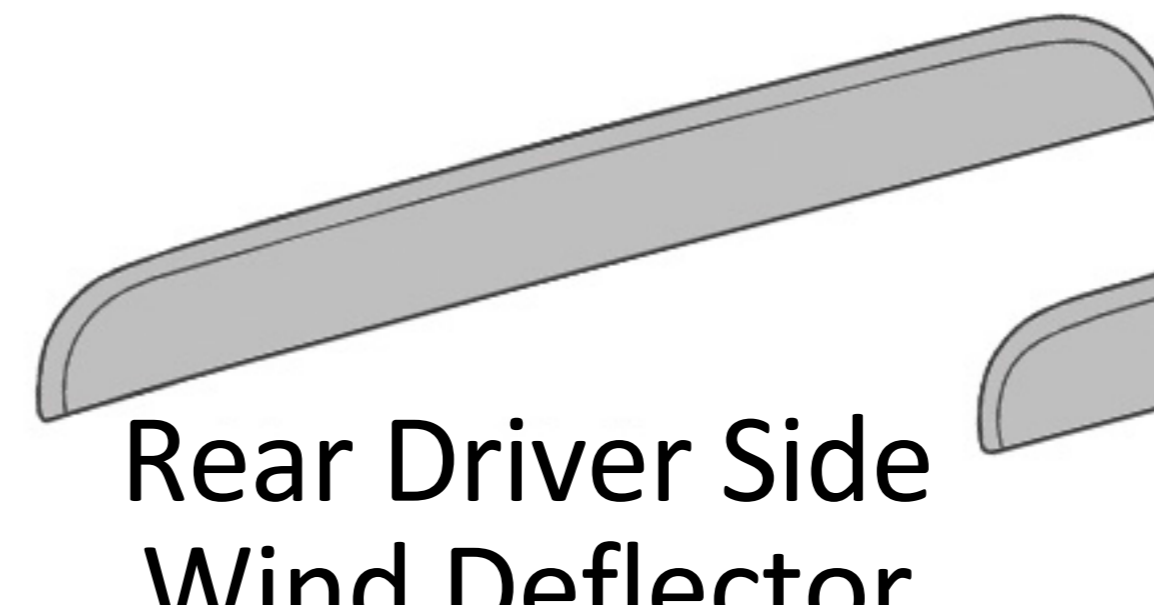

Rear Driver Side
Wind Deflector

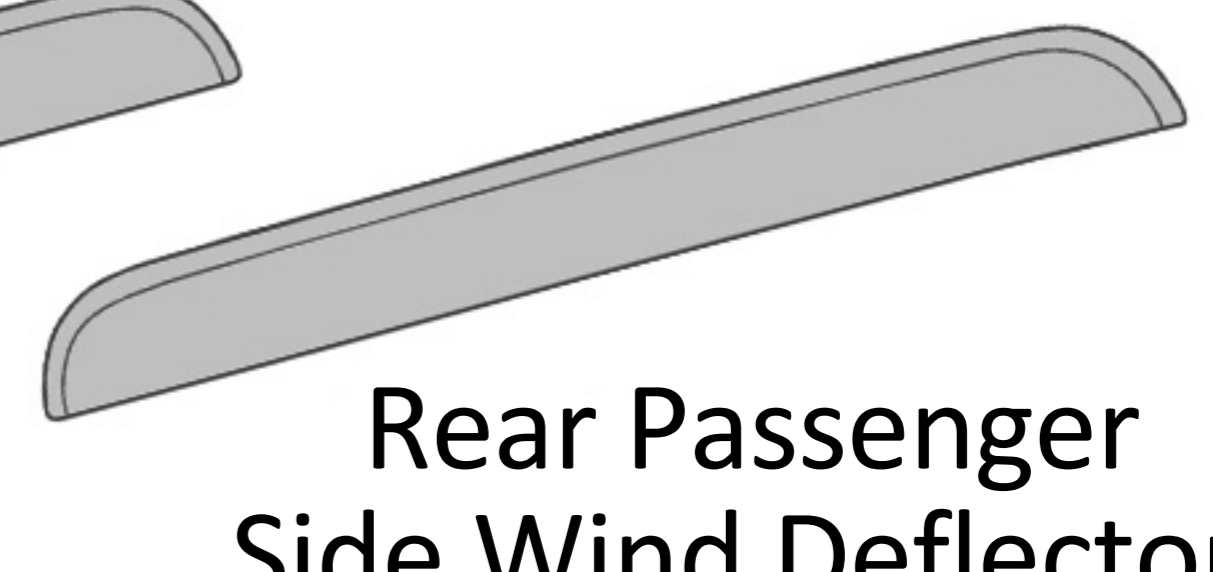

Rear Passenger
Side Wind Deflector



4 Alcohol Pads

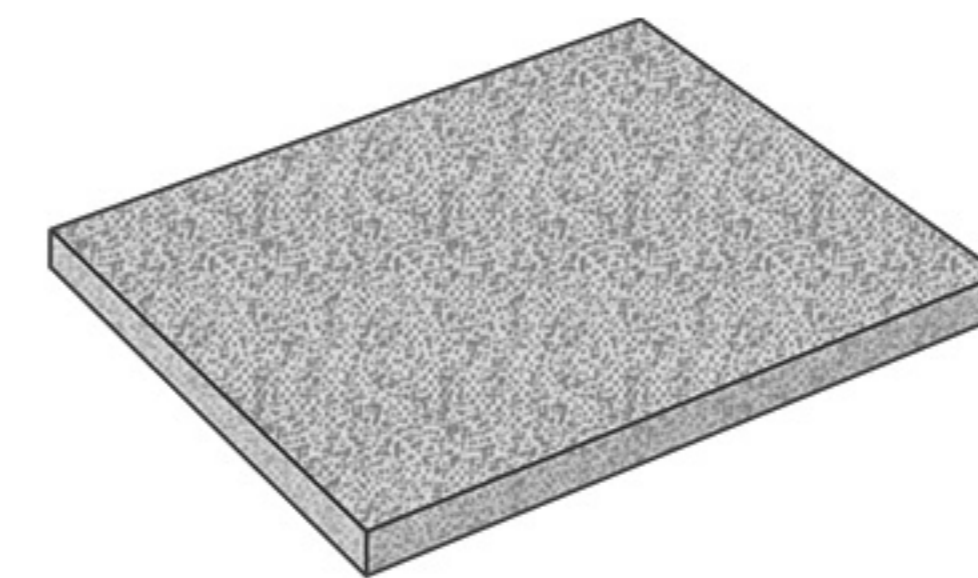

Scotch Brite Pad

Necessary Tools



Car Wash Supplies

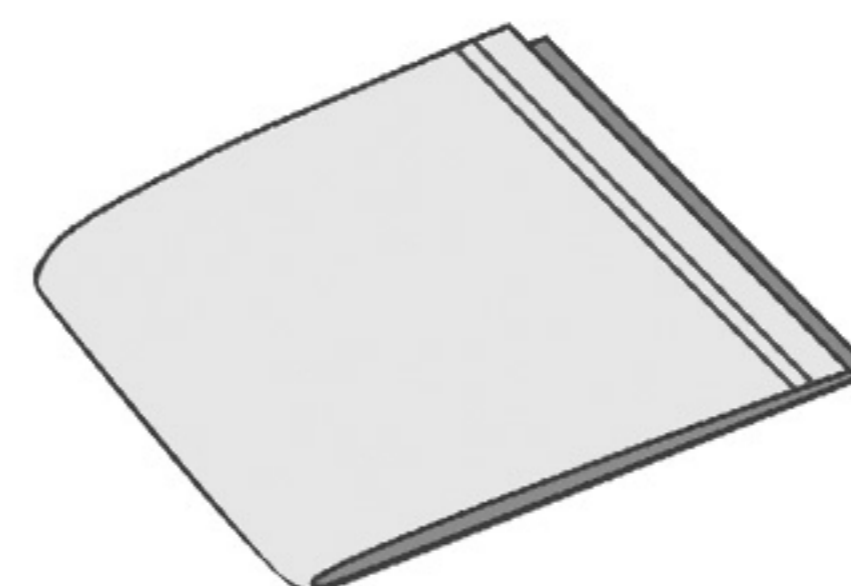

Clean Towel

Installation / Painting Preparation

- ▽ u
 - ▽ "
 - ▽ u
 - ▽ y
- h

Installation Procedure

NOTE: Pictures below may differ slightly from actual application.



Use Scotch Brite pad to scrub the rubber window trim. Wipe the rubber window trim / mirror cap with alcohol pad to dissolve remaining grease.

1

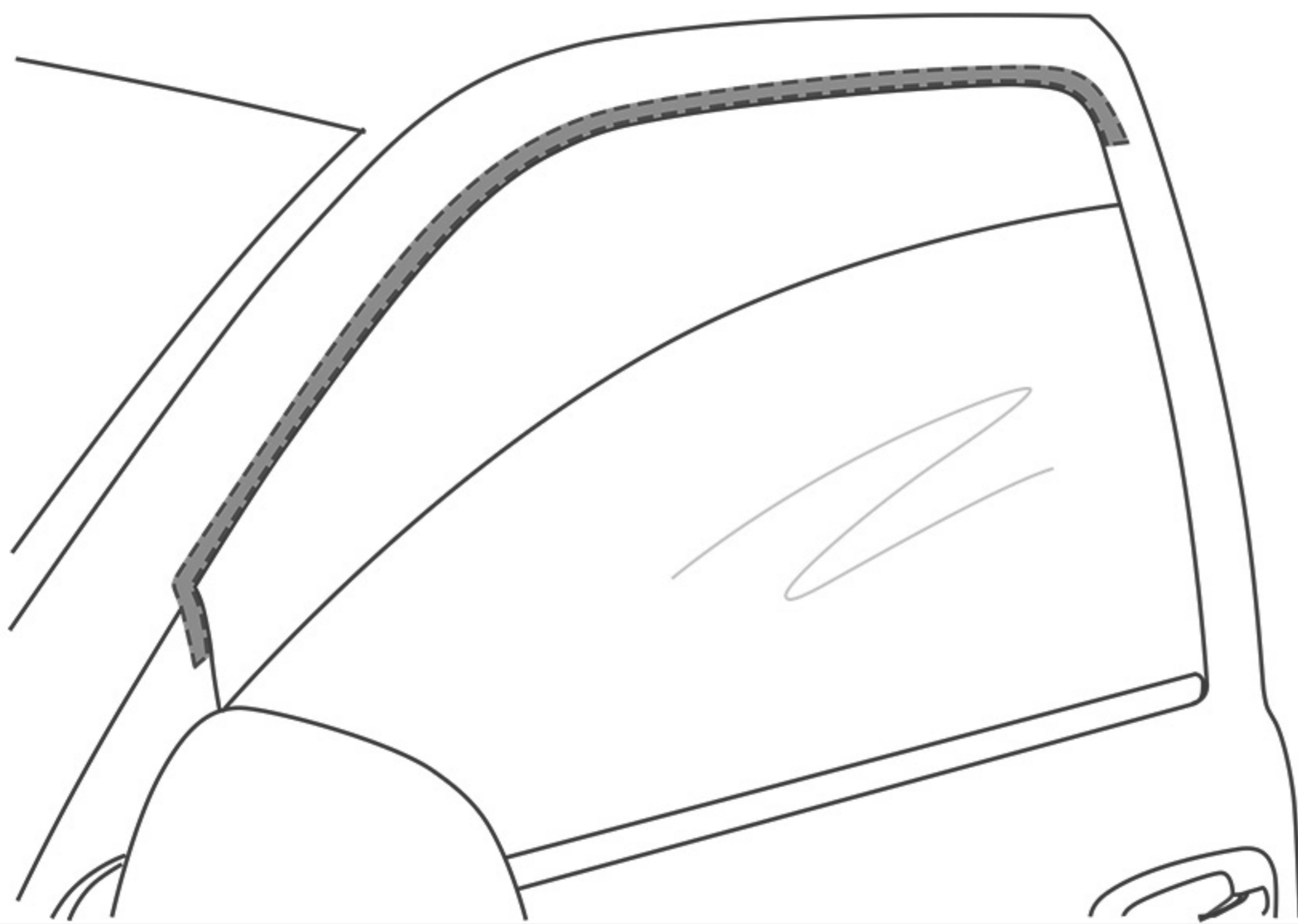

2

Peel back 2" of the backing from the adhesive tape on both sides of the tape.

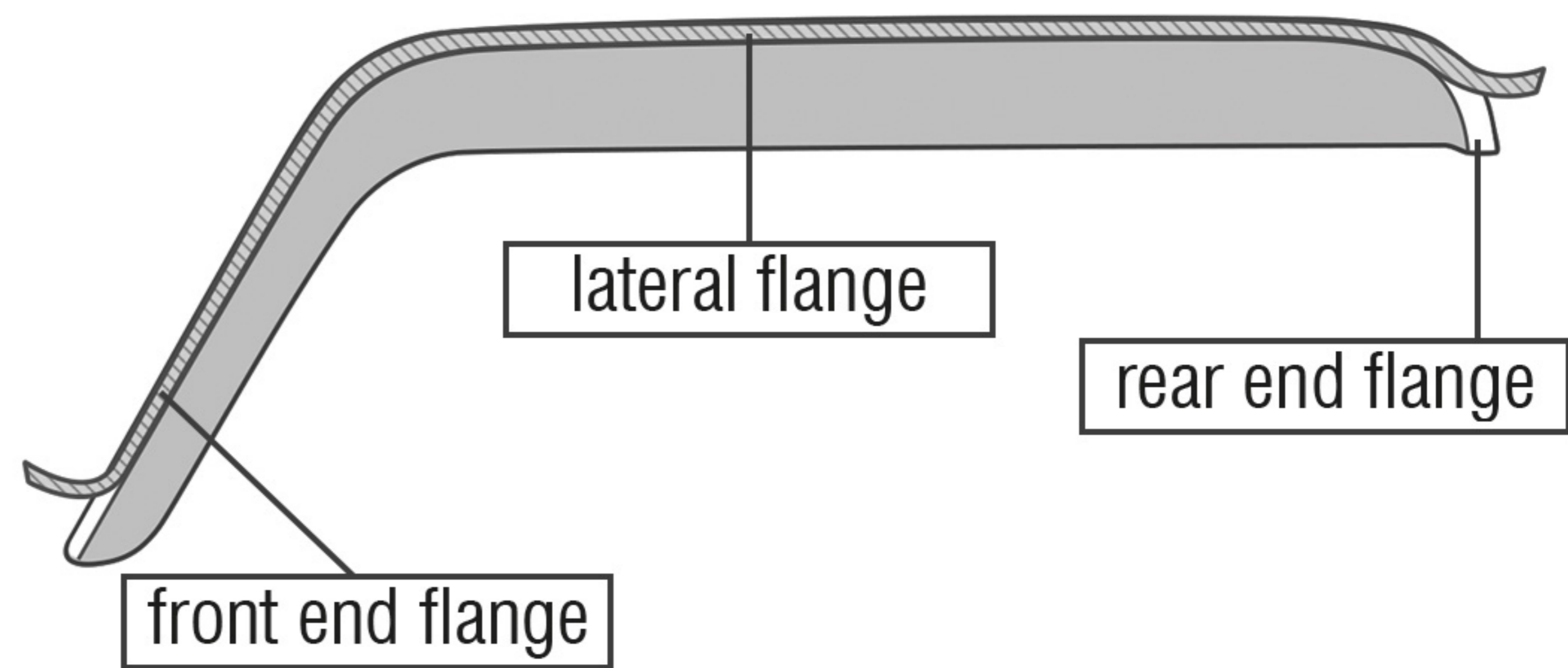

Place the driver side wind deflector on the previously cleaned area and make sure it is properly aligned. Stick the ends of the tape to the vehicle applying pressure.

3

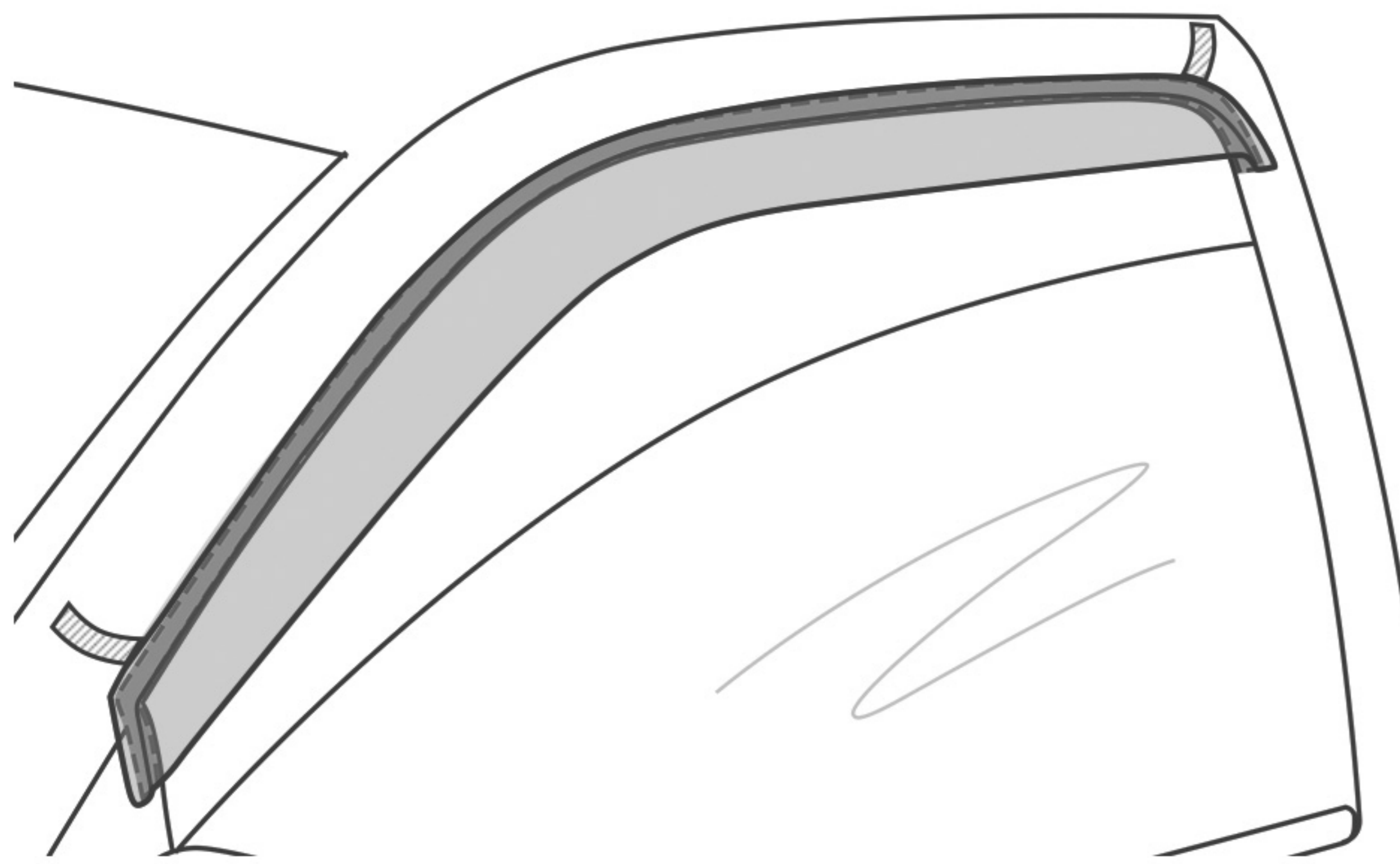

4

Peel off the remaining backing from the adhesive tape.

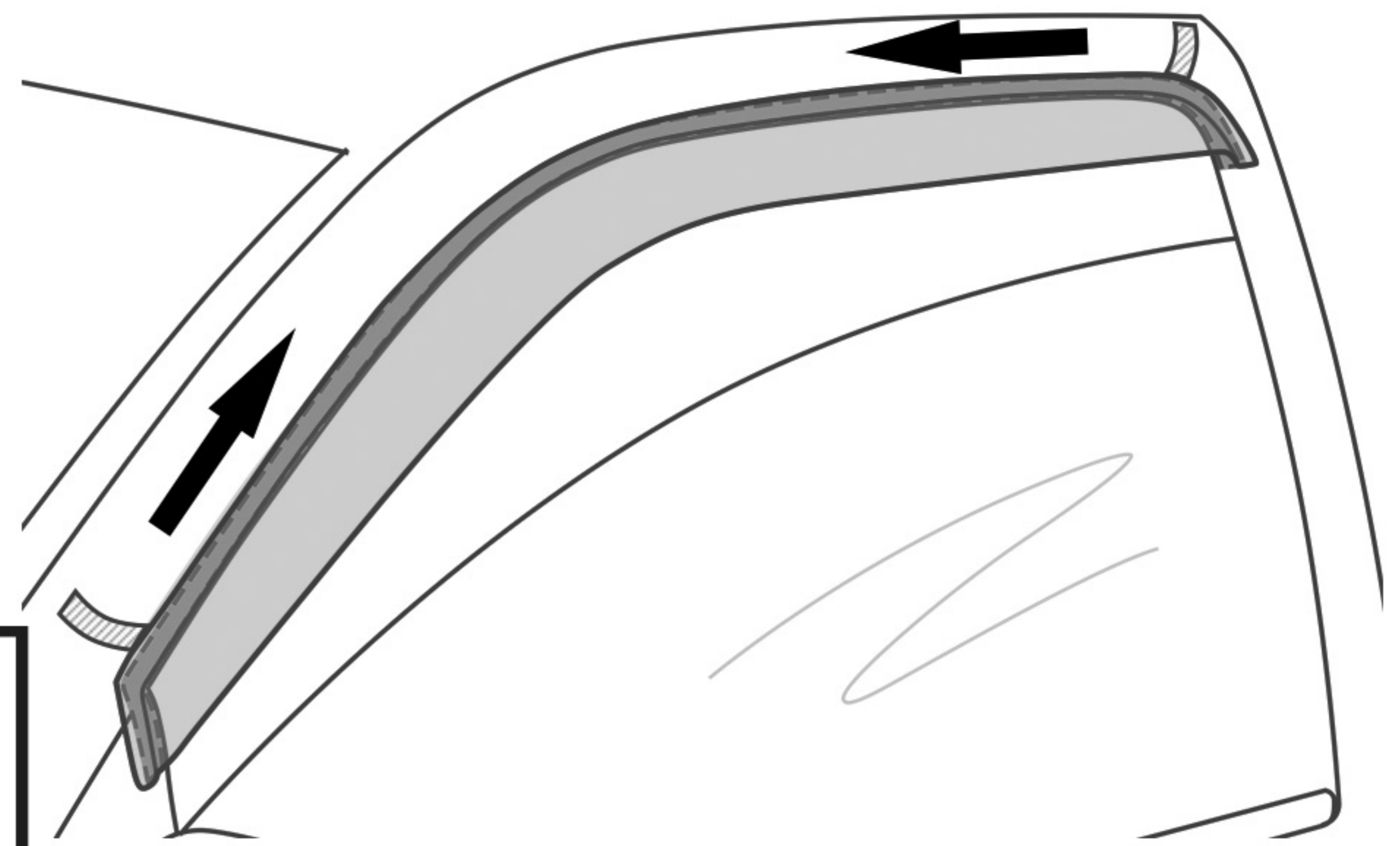

Secure your wind deflector by applying pressure along its entire length.

5

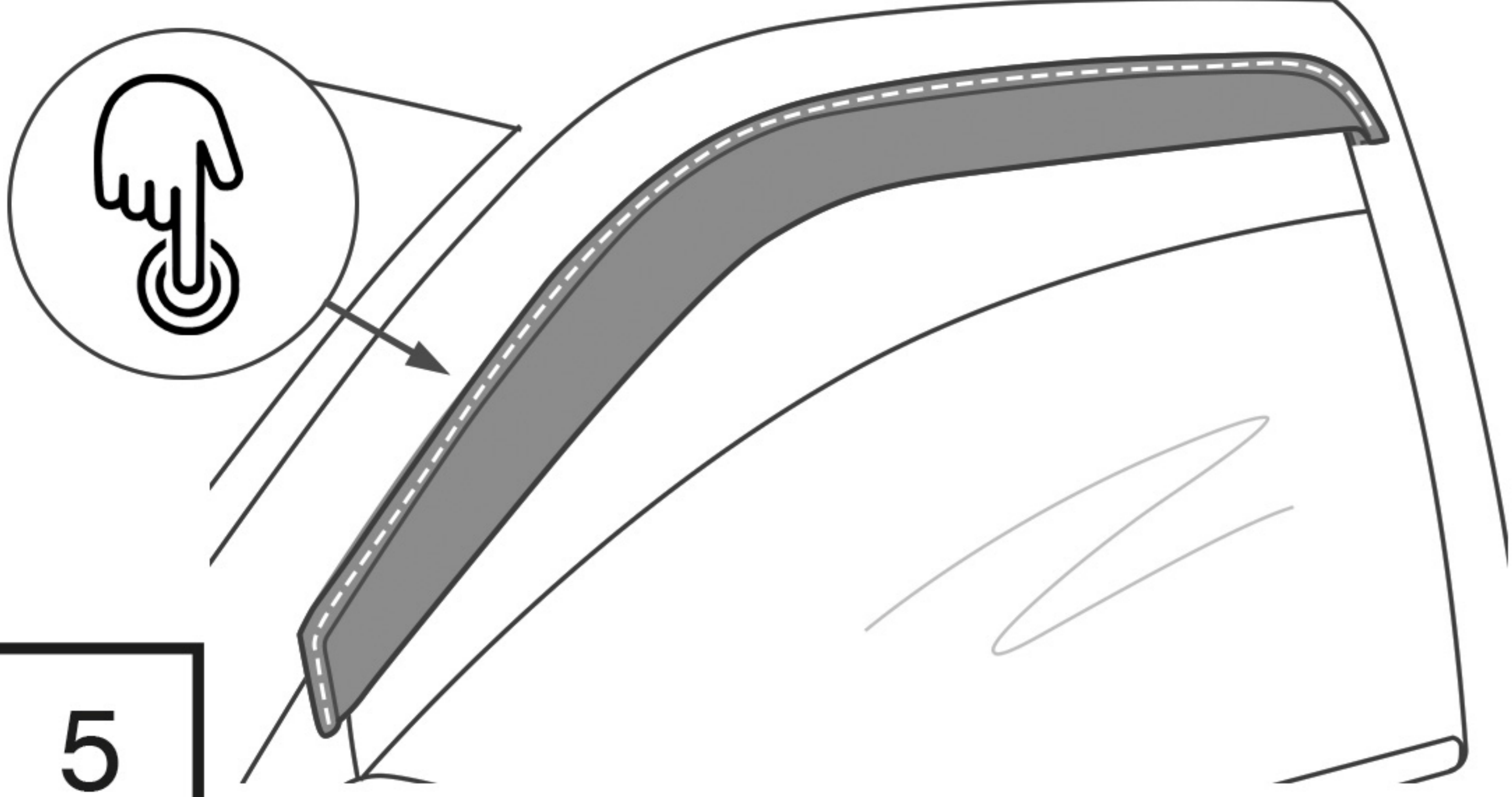

Repeat these installation steps for the passenger side front wind deflector.

4-Piece Kit

NOTE: Pictures below may differ slightly from actual application.

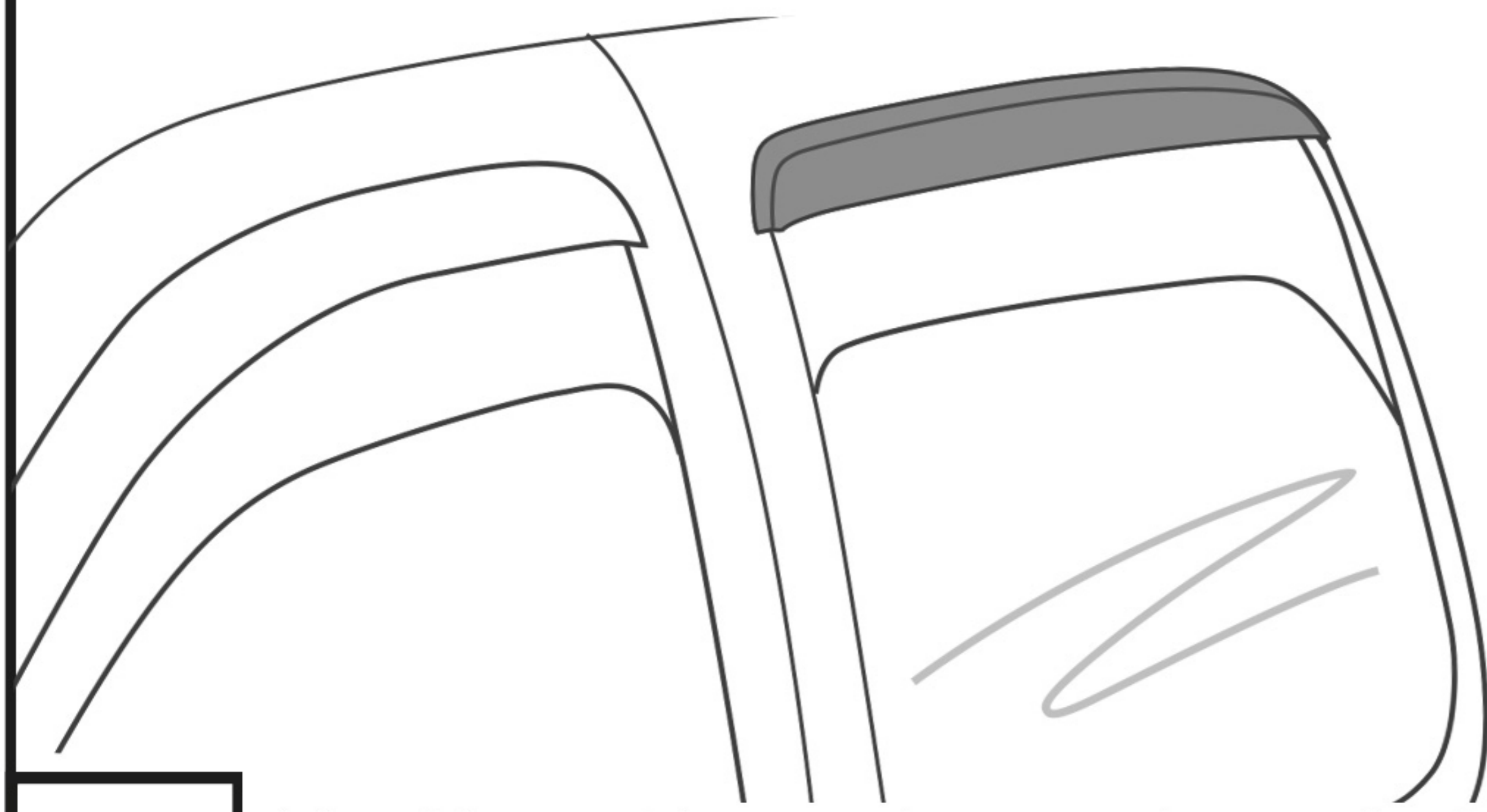

Use Scotch Brite pad to scrub the rubber window trim. Wipe the rubber window trim/ mirror cap with alcohol pad to dissolve remaining grease.

Remove the adhesive tape backing from both ends of the tape. Peel back 2" of the adhesive tape backing from the front and rear flanges.

Place the driver side wind deflector on the previously cleaned area and make sure it is properly aligned. Stick the ends of the tape to the vehicle applying pressure. Peel off the remaining backing from the adhesive tape.

Secure your wind deflector by applying pressure along its entire length.

6

Repeat **Steps 1-5** for passenger side.

Washing and Care

- Use only mild soap for cleaning. Wipe dry using a clean cloth.

Congratulations!