

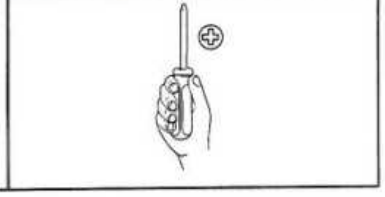

INSTALLATION INSTRUCTIONS

Tools Required

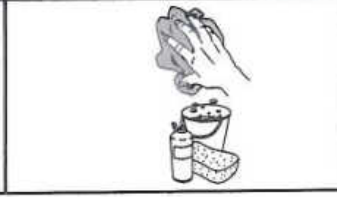
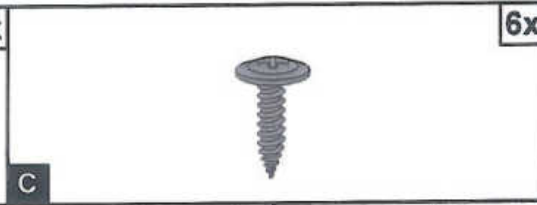
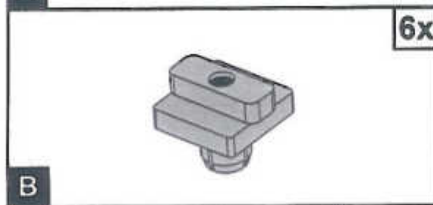
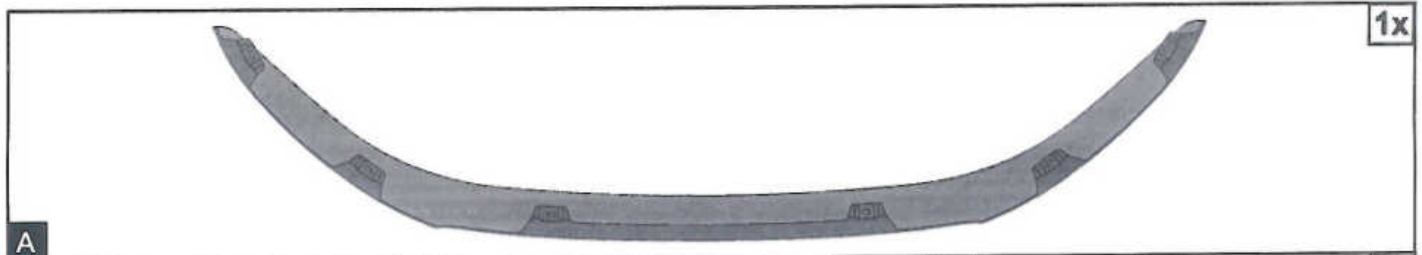
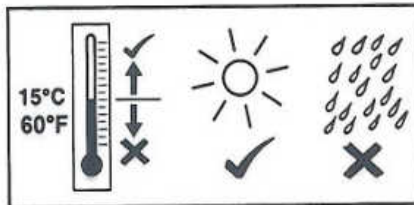
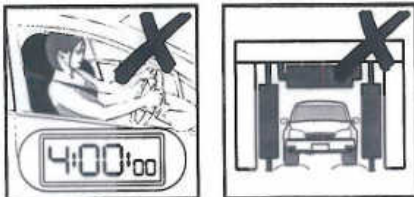

1

Open the hood.
Thoroughly clean the hood and surrounding areas.
Wipe away any residue and allow to completely dry.

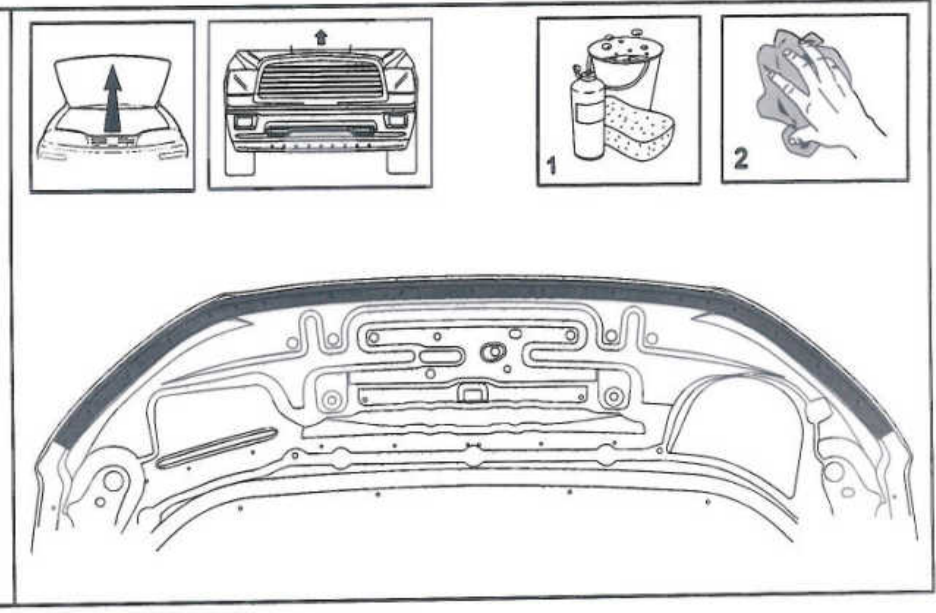

EGR

INSTALLATION INSTRUCTIONS

2

Trial fit the Hood Deflector centrally onto the hood, align the front edge of the Hood Deflector with the hood lip.

Note where the six slots on the tags correspond to the scrivenets on the underside of the hood.

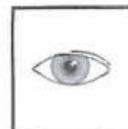
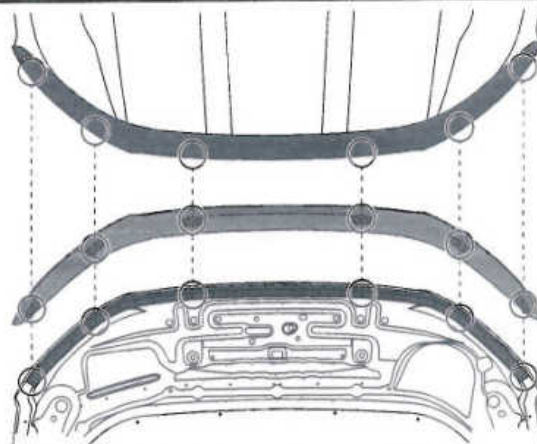
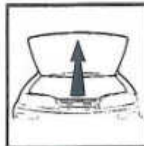

3

At the previously noted scrivenet locations carefully remove the scrivenets attaching the hood seal and discard.

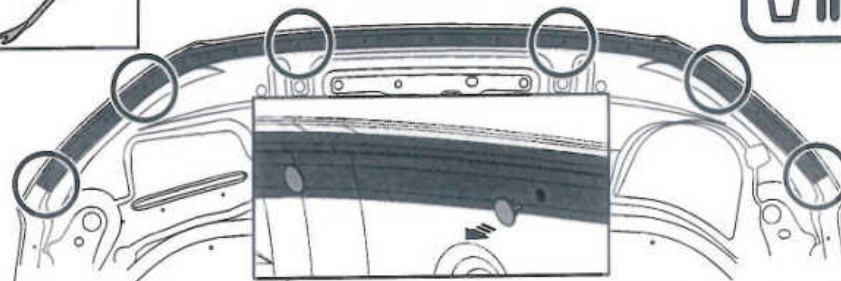

4

Gently peel back the rubber seal and insert a screw plug into the vacant holes in the underside of the hood.

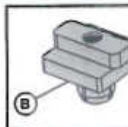
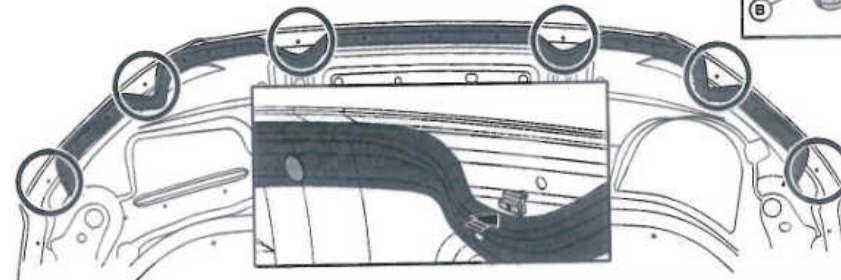

EGR

INSTALLATION INSTRUCTIONS

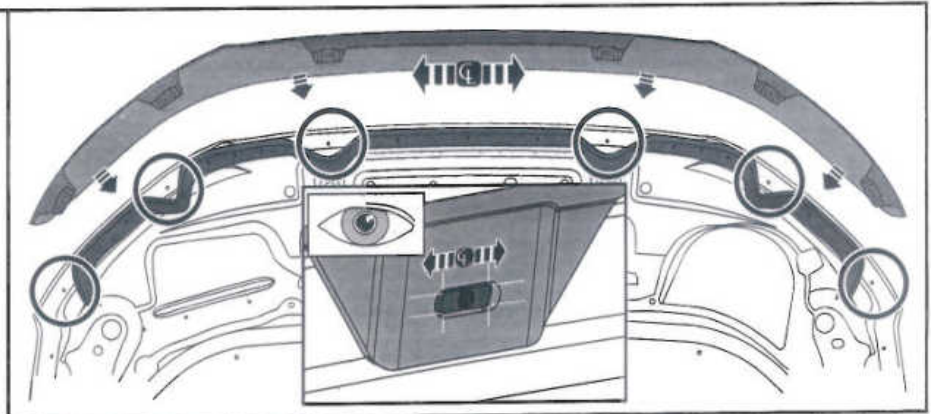
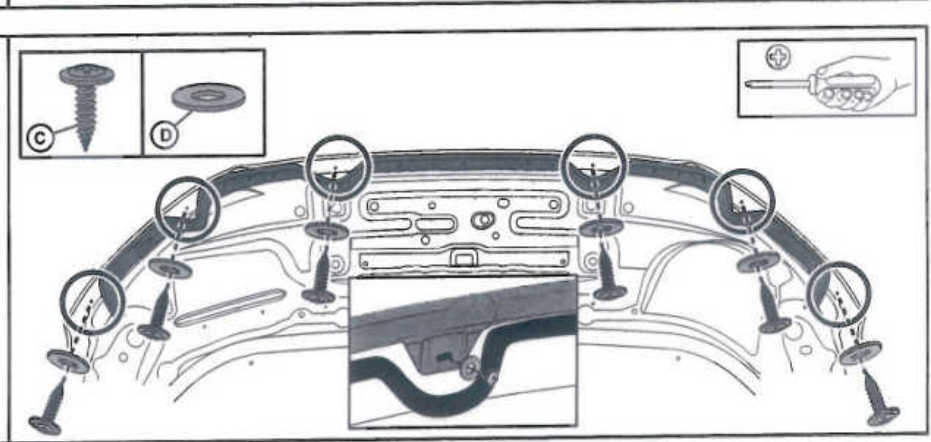
<p>5</p> <p>Fit the Hood Deflector and align the slots in the tags with the plugs in the hood.</p> <p>Ensure the rectangular boss on the plug is nested into the slot.</p>	
<p>6</p> <p>Insert the six self tapping screws and washers into the plugs and secure the Hood Protector to the hood.</p> <p>Return the rubber seal back to its original position over the hood protector tags.</p>	
<p>7</p> <p>Re-check and ensure that the Hood Deflector is centered on the hood.</p> <p>Wash the Hood Deflector and surrounding areas.</p>	