

# EGR

## INSTALLATION INSTRUCTIONS

### Tools Required

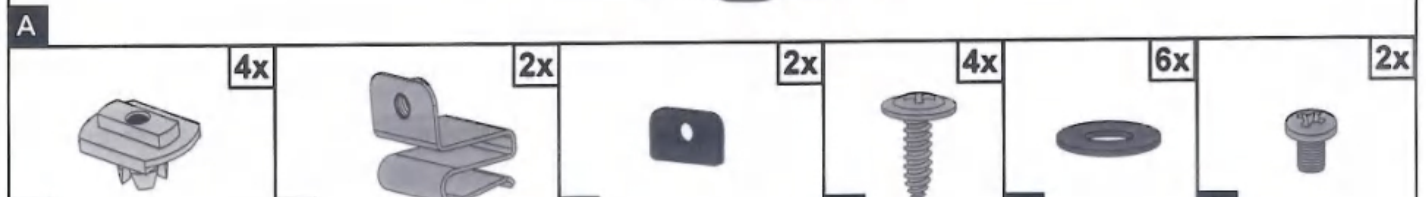
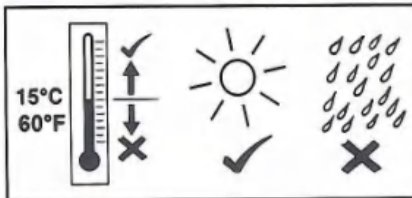
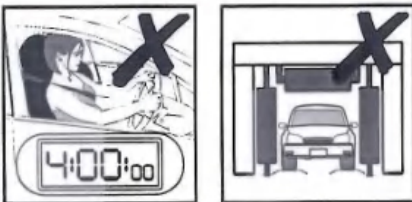

**1**

Open the hood.  
Thoroughly clean the hood and surrounding areas.  
Wipe away any residue and allow to completely dry.

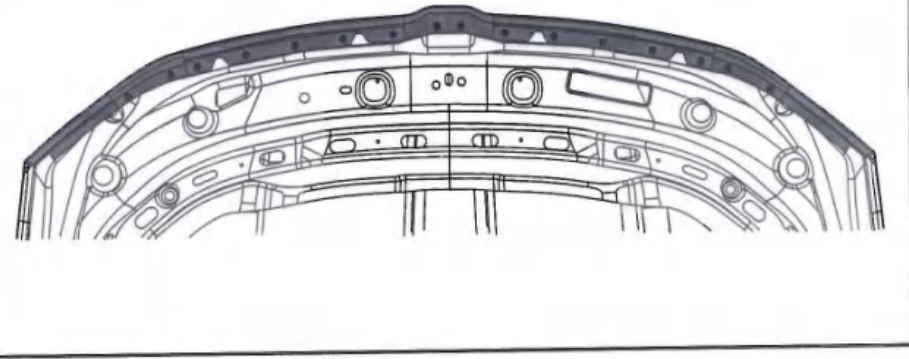
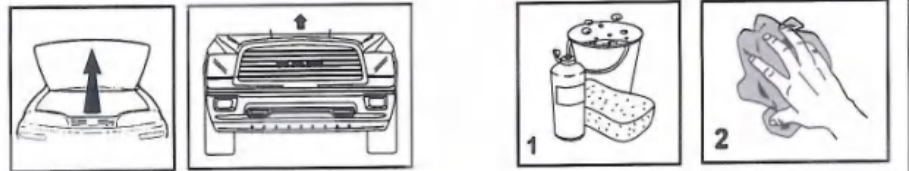

# EGR

## INSTALLATION INSTRUCTIONS

2

Trial fit the Hood Deflector centrally onto the hood, align the front edge of the Hood Deflector with the hood lip.

Note where the two outer holes align with the lip of the hood and note where the four centre slots on the tags correspond to the scrivenets on the underside of the hood.

Note where the six bump-on location stickers correspond to the top of the hood.

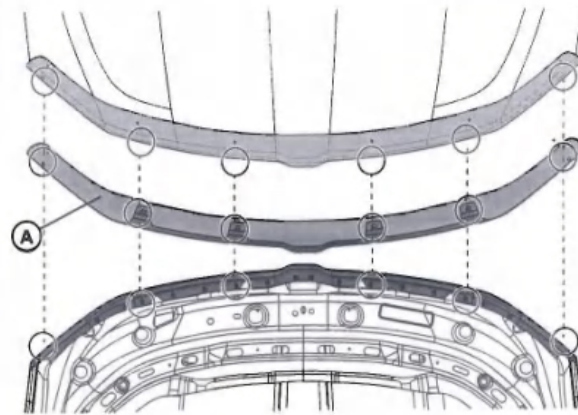

3

Clean the previously marked hole positions with the alcohol wipe provided. Allow to dry.

At these two locations gently pull the seal back and adhere the abrasion resistant tapes over the hood lip.

Apply the tape so that approximately two thirds of each strip is on the front surface of the fascia and one third folds over the inside edge.

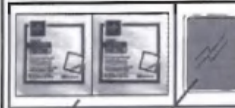

J

H

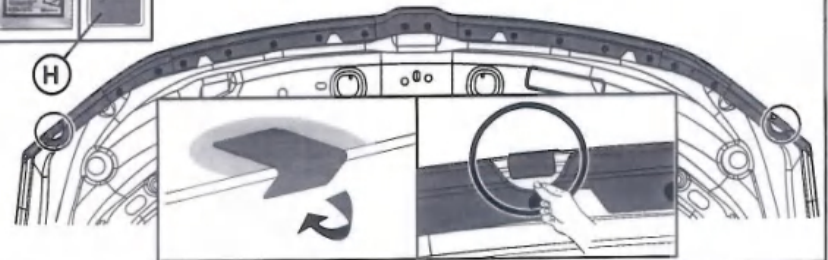

4

Peel back the adhesive backing from the foam pads and adhere to the push-on clips.

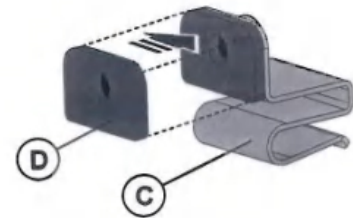

# EGR

## INSTALLATION INSTRUCTIONS

5

Slide a push-on clip over the hood lip underneath the seal at each clip location.

Ensure the clips rest over the abrasive resistant tape and do not come in contact with the hood. Failure to do this may result in permanent damage.

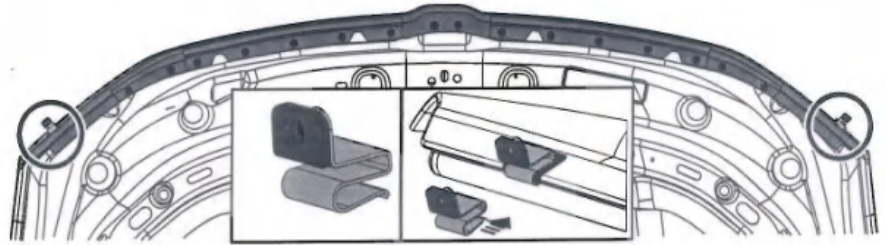

6

At the previously noted scrivet locations carefully remove the scrivetts attaching the hood seal and discard.

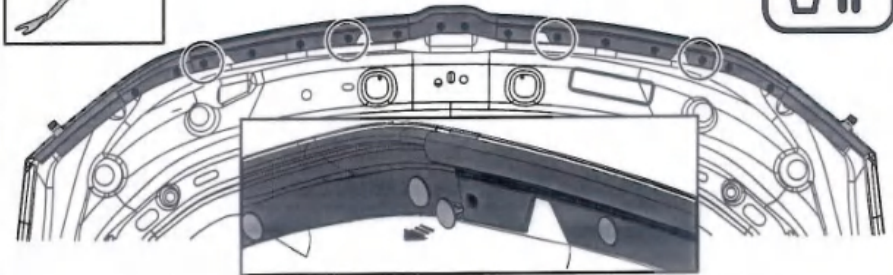

7

Gently peel back the rubber seal and insert a plug into the vacant holes in the underside of the hood.

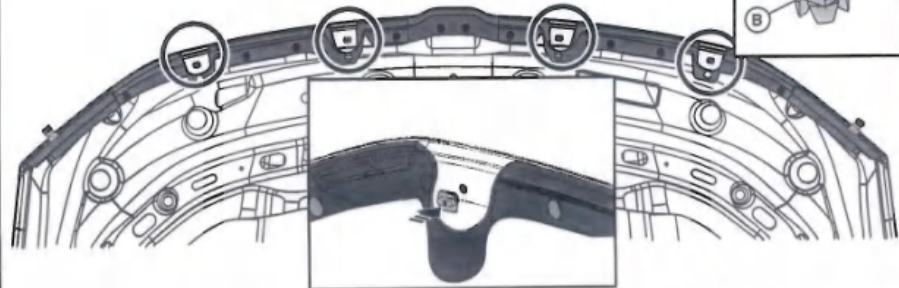
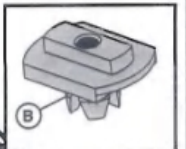



# EGR

## INSTALLATION INSTRUCTIONS

8

Fit the Hood Deflector and align the slots in the tags with the plugs in the hood.

Ensure the rectangular boss on the plug is nested into the slot.

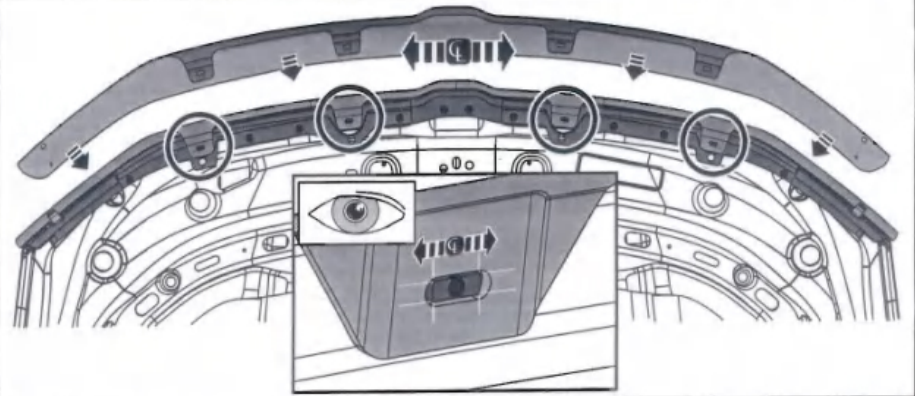

9

Insert the four self tapping screws and washers into the plugs and secure the Hood Protector to the hood.

Return the rubber seal back to its original position over the hood protector tags.

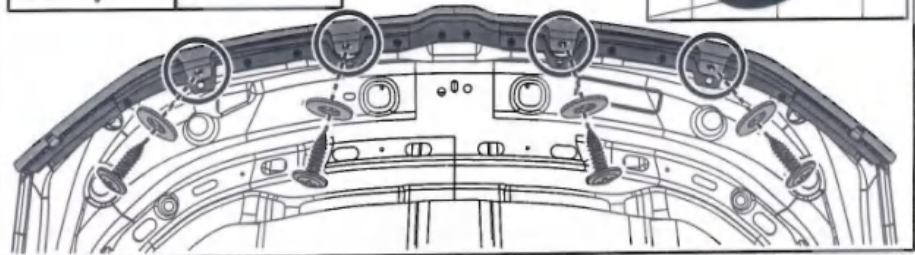
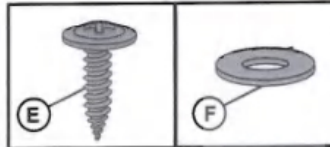

10

Fasten the Hood Protector to the two top metal outer clips using the screws and washers provided.

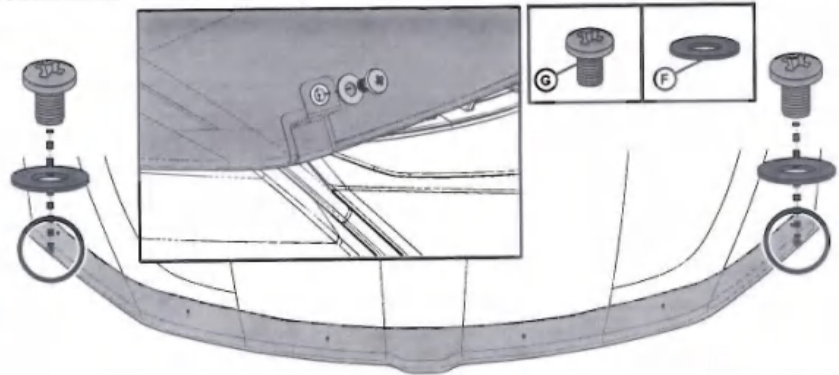

# EGR

## INSTALLATION INSTRUCTIONS

11

Clean and dry the hood underneath each bumpon location sticker.

Peel the adhesive backing from the bumpons and adhere a bumpon to the hood directly underneath each bumpon location sticker.

Peel off and discard the bumpon location stickers when complete.

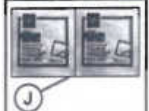
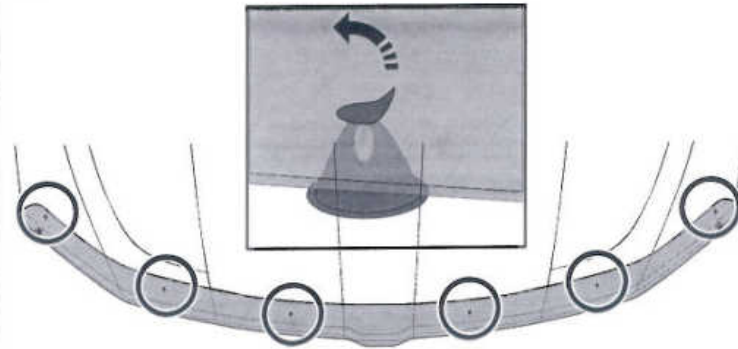

12

Re-check and ensure that the Hood Deflector is centered on the hood.

Wash the Hood Deflector and surrounding areas.

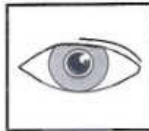
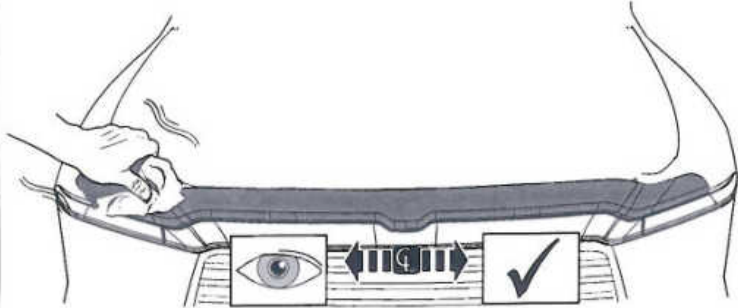

MADE IN USA

Learn more about stone and bug deflectors we have.