

FENDER FLARES INSTALLATION INSTRUCTIONS FRONT FENDERS

FIT-FF040a
1/2

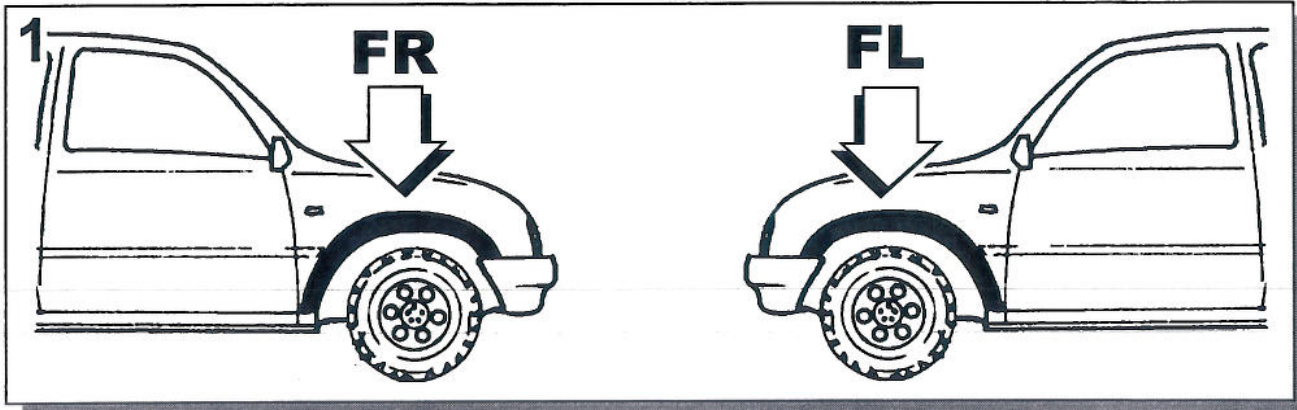

Ensure that both Left and Right hand Fender Flares suit the profile of the vehicle. Note the areas where the Fender Flares come in contact with the vehicle. NOTE: Before fitting Fender Flares remove any moldings, strips or existing flares from the wheel arch. If there is a body side moulding, mark where the moulding is to be cut. Alternatively, the Fender Flare can be cut to go around the moulding. Be sure to allow enough room for the extrusion.

PAINTING INSTRUCTION - If Fender Flares are being painted, do not install edge extrusion until painting is complete
Prior to painting, clean all surfaces to be painted using clean water and a mild detergent, do not use lacquer thinner or any solvent based products. Wipe completely dry. Best results will be achieved by wiping the areas to be painted with a tack rag just prior to painting. Most automotive paints can be applied directly to the Fender Flare, however, some may require a primer (check paint manufacturer specifications). Good adhesion will be achieved without sanding, however, if a smoother surface finish is desired, sanding can be performed. Select a paint (and primer if necessary) that is suitable for rigid plastics. If using a paint system which requires baking, do not expose the product to temperatures above 70° C (158° F). Do not fit the extrusion or any of the hardware to the Fender Flares until the paint is completely dry.

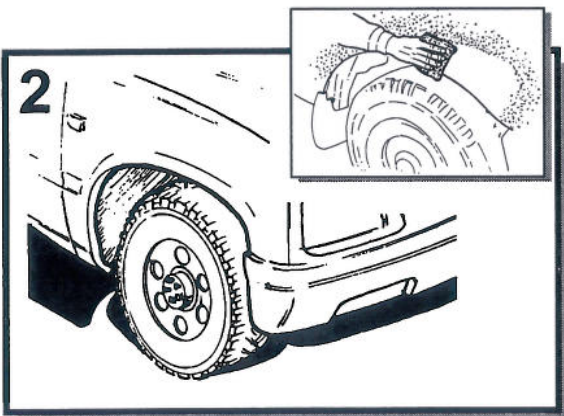

Wash the areas of contact on the vehicle and wipe dry both the vehicle and the Fender Flare with a clean cloth. Ensure inside of Fender Flare where extrusion is attached, is clean.

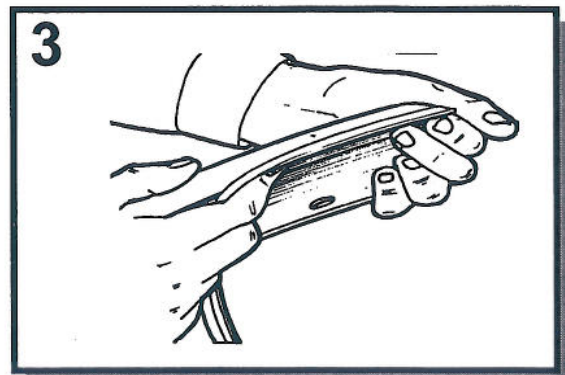

Remove approximately 50mm of the protective liner from the extrusion. Fit the extrusion to the Fender Flare along the edge that comes in contact with the vehicles body panel.

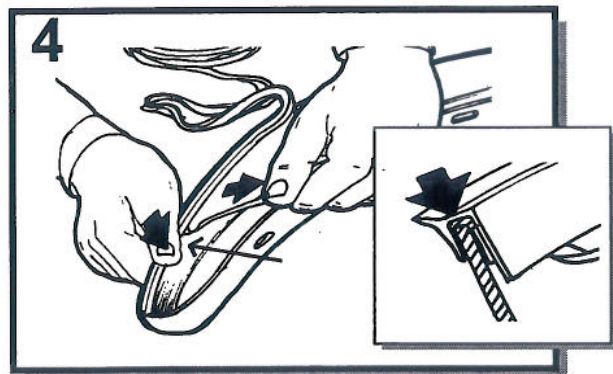

Pulling at right angles from the extrusion remove the liner from the extrusion in small portions and apply thumb pressure to ensure that it adheres to the Fender Flare.

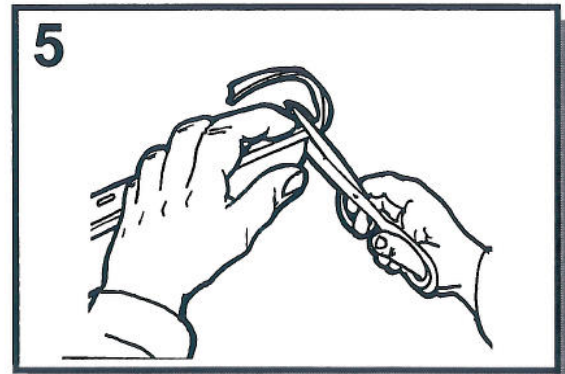

Trim excess extrusion and discard.

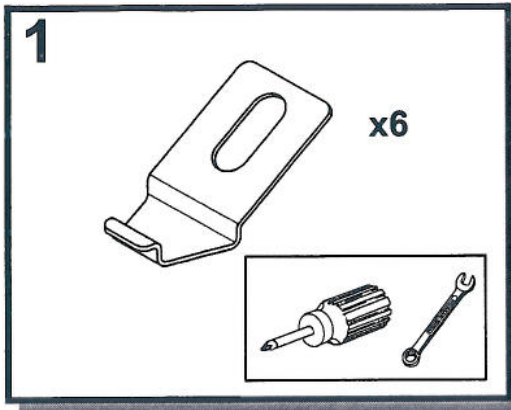

Ensure that all of the necessary hardware is in the hardware kit (screwdriver and spanner not supplied).

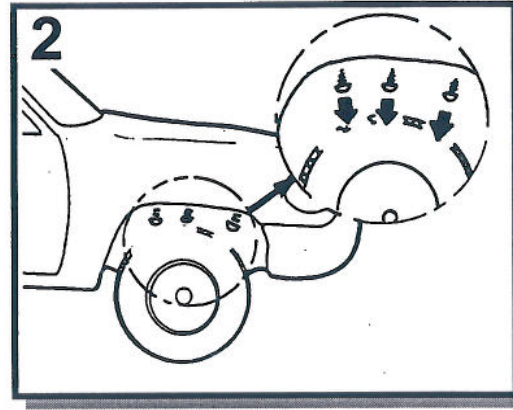

Remove the three existing screws as shown

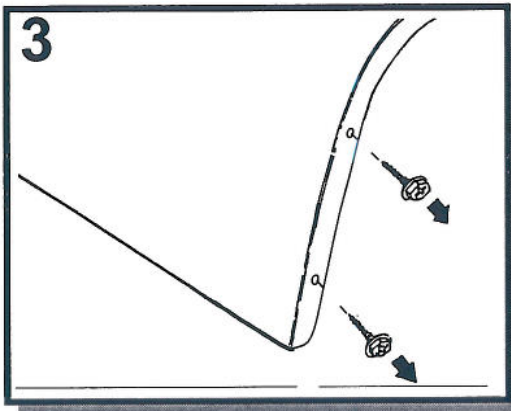

Remove the two mudflap screws as shown.

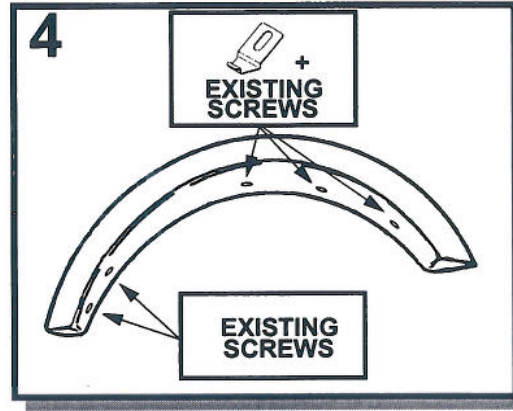

Correct hardware positions.

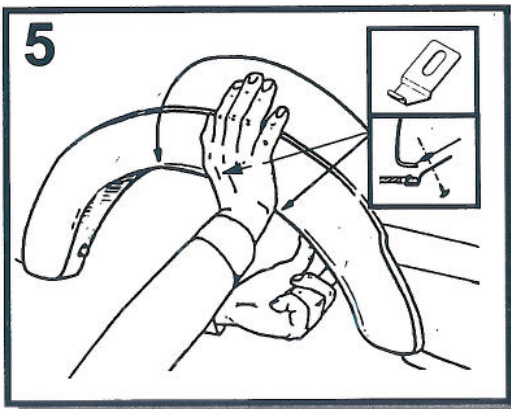

Place the Fender Flare into the position of best fit. Take three of the supplied lever clips and install them in the positions shown. Installation of these clips is achieved by removing existing screws and replacing them after the clips are positioned.

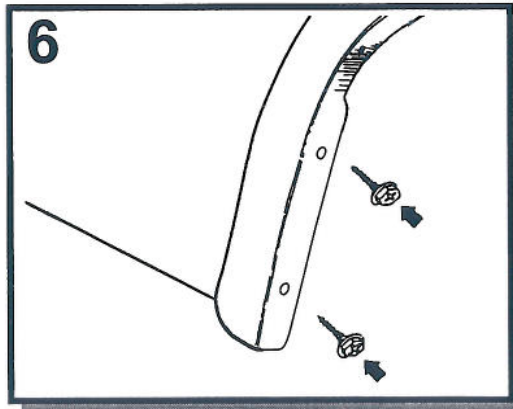

Replace the mudflap and the mudflap screws.