

JUICE ATTITUDE

CS2



USER MANUAL

Read Me

Safety Warning & Caution

Throughout this User Manual you will see important messages regarding your safety or the protection of your vehicle. These messages are designated by the words **WARNING** or **CAUTION**.

▲ WARNING indicates a condition that may cause serious injury or death to you, your passengers or others nearby. Pay careful attention to these Warning messages, and always comply with them. They could save a life.

CAUTION indicates a condition that could cause damage to your vehicle. It is important to install and operate your product in conformance with instructions in this Manual. Caution alerts you to particularly important things that will keep your vehicle operating properly.

The Edge Product you have purchased is a high-performance product. As such, it does present some risks of which you should be fully aware. Do not use this product until you have carefully read the following safety information and the Owner Agreement.

NOTE: After the display has been installed, a warning screen will appear (3) different times.

▲ WARNING: Misuse of this device could lead to a serious accident. Do not use to break legal speed limits. Before installing, read and comply with all information in the User Guide. Do you agree?

If you agree with the agreement, select Yes to continue.

Safety Guidelines

1. Do not exceed legal speed limits on public roadways. Use any enhanced speed capabilities of this product only in closed circuit, legally sanctioned racing environments expressly for this purpose. Loss of control from speeding on a public road could seriously injure you, your passengers, or others on the roadway.
2. Do not operate the device while driving. Perform all adjustments or changes while stopped. Changing a setting while under way can interfere with your attention to roadway conditions.
3. “Stacking” performance-enhancing devices or other improper installation can cause power train failure on the road. Other products may have features incompatible with your Edge device. Follow all installation and operating instructions, and do not stack products.
4. Some modifications may affect other parts of your vehicle. For example, if you remove/adjust the speed limiter in your vehicle, be sure your tires and other components are rated for the increased speeds they will have to withstand. Not doing so can lead to loss of vehicle control. Modify the speed limiter only for use in closed circuit, legally sanctioned racing environments, not for use on public roadways.

▲ WARNING - Misapplication or misuse of this product could lead to a serious or fatal accident. Comply with all safety information in this manual, and your vehicle owner’s manual. Follow safety, installation and operating instructions in this User Manual to assure proper use.

At a Glance

Physical Overview - The Display

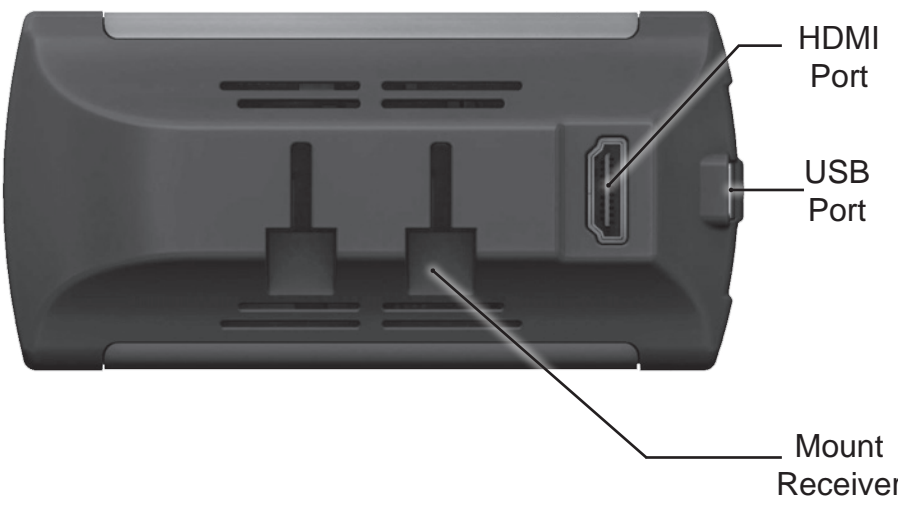
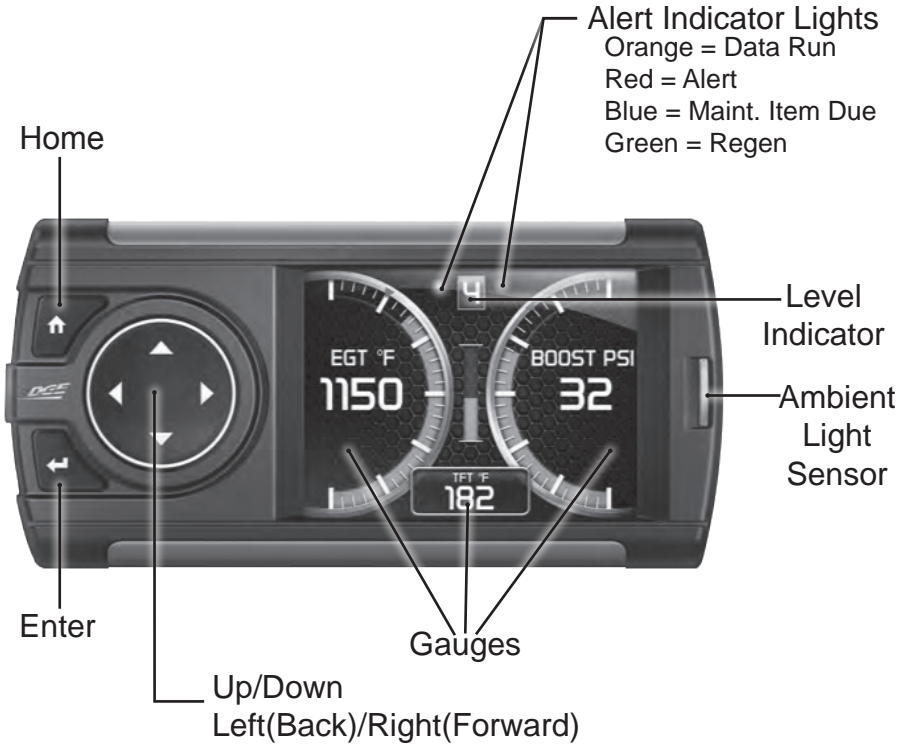

Accessories

Windshield Mount

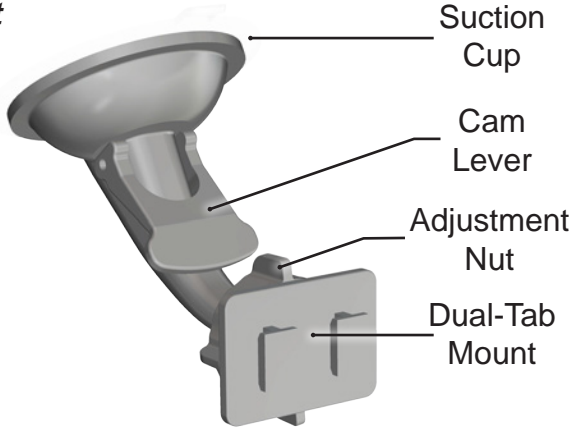

Alcohol Wipe



OBDII to HDMI cable

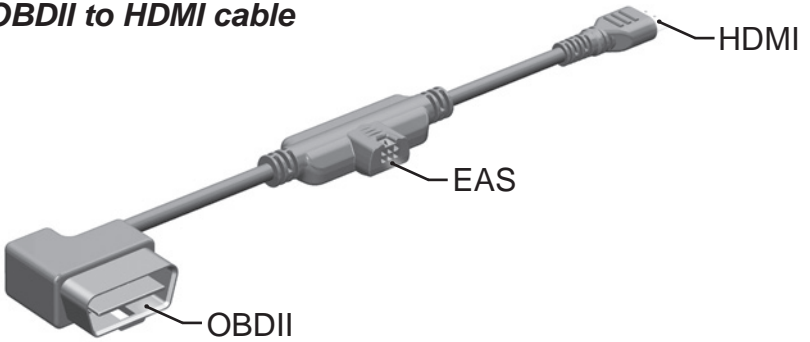



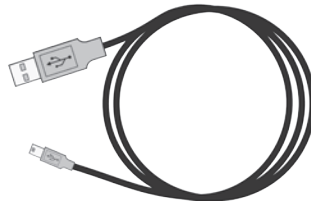



Mini USB Cable



Zip-Ties



Button Icons

Icon		What it does
	Home	Gauge Screens - Enters Main Menu Menus - Brings you back to the home screen
	Enter	Gauge Screens - Highlights PID locations Menus - Selects menu options & closes text boxes
	Up	Gauge Screens - PID location navigation Menus - Scrolling up
	Down	Gauge Screens - PID location navigation Menus - Scrolling down
	Left	Gauge Screens - PID location navigation Menus - Back to previous menu or option
	Right	Gauge Screens - PID location navigation Menus - Brings you to next menu

Common Terms

Term	What it is
PID - <u>P</u> arameter <u>I</u> Ds	Data taken from a vehicle & viewed in a gauge
DPF - <u>D</u> iesel <u>P</u> articulate <u>F</u> ilter	Required on new diesels to filter out soot
EAS - <u>E</u> xpandable <u>A</u> ccessory <u>S</u> ystem	Allows you to connect aftermarket sensors and other devices such as turbo timers
ECM - <u>E</u> ngine <u>C</u> ontrol <u>M</u> odule	(aka ECU) A computer that controls various sensors and engine components
TCM - <u>T</u> ransmission <u>C</u> ontrol <u>M</u> odule	(aka TCU) A computer that controls automatic transmissions
PCM - <u>P</u> ower <u>C</u> ontrol <u>M</u> odule	(aka PCU) Combines and provides power for the ECM and TCM

Navigating Menu

STEP 1 - Enter the Main Menu by pressing the Home button.



STEP 2 - Use the Up/Down arrows to scroll through the menu items.

STEP 3 - Press the Enter button to select a sub menu.



STEP 4 - Press the left arrow to return to the previous screen.

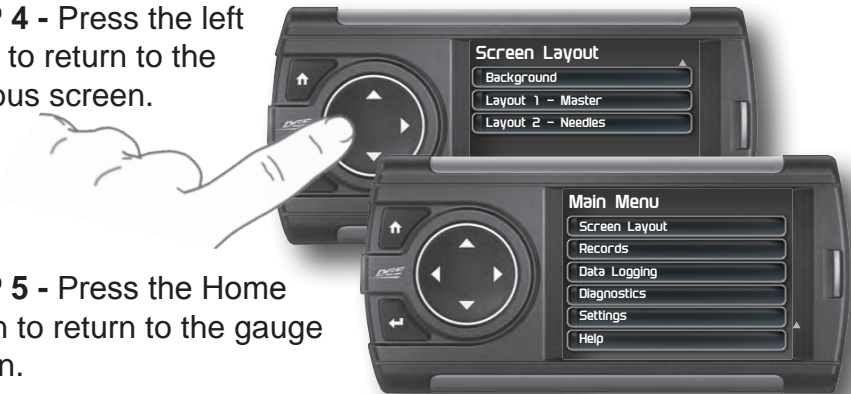

STEP 5 - Press the Home button to return to the gauge screen.

Getting Started

Download the Fusion Update Software

A computer with internet access is required:

STEP 1 - Go to **edgeproducts**.

STEP 2 - Click the **UPDATES** tab, then **DOWNLOAD**.

STEP 3 - Open the **FusionClientSetup.exe** file, then click **Run**.

STEP 4 - Click **Next** to begin.

STEP 5 - Choose a folder location, then click **Next** to continue.

STEP 6 - Click **Next** to confirm the installation.

STEP 7 - Click the **OK** button if during the installation, the following message appears:

“These drivers are not Windows Logo or WHQL verified. If you are asked, please choose to install them anyway.”

STEP 8 - Click **Close** to exit once the installation is complete.

STEP 9 - Double click the **Fusion Icon** on your desktop.

STEP 10 - Click on the **Create a New User** option.

STEP 11 - Fill in the required information and click **Save**.

An e-mail containing your fusion password will be sent to the e-mail you used in the form. Use this password to login into Fusion. (NOTE: The password is case sensitive)

STEP 12 - Double click the **Fusion Icon** on your desktop.

STEP 13 - Plug the display into the computer using the USB cable.

STEP 14 - *If asked, choose “Yes, this time only”, then click Next.*

STEP 15 - *Select Install the software automatically then Next.*

STEP 16 - If you're asked to “Continue Anyway” or “STOP installation” click **Continue Anyway** then click **Next** to complete the hardware wizard.

Using the Fusion Update Software

A computer with internet access is required:

STEP 1 - Double click the **Fusion Icon** on your desktop.

STEP 2 - When asked, plug the display into the computer using the supplied USB cable.



STEP 3a - If an update is available, click **YES** to continue.

DO NOT unplug the display from the computer during an update.

STEP 3b - If an update is not available, click the **OK** button.

STEP 4 - Once the update is complete, click **Close**.

Cable Installation

STEP 1 - Locate the On Board Diagnostics II (OBDII) port.
(This connector is typically found directly below the driver side dash console.)

STEP 2 - Plug the OBDII connector into the vehicle port.

STEP 3 - Route the HDMI end up the driver side dash.
(On most vehicles, the side panel may be removed to expose the underside of the dash for easier routing. Leave exposed until after the display is installed.)

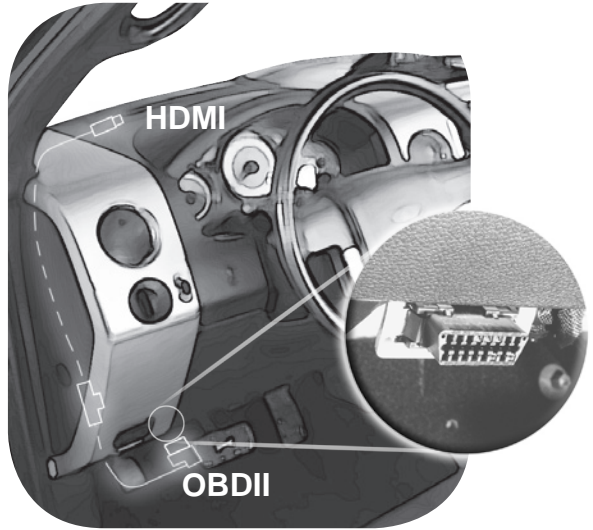

Windshield Mount Installation

STEP 1 - Use the Alcohol Wipe to liberally clean the windshield in the area you plan to place the suction cup. Allow the glass to fully dry.

STEP 2 - Firmly press and hold the suction mount against the glass.

STEP 3 - Rotate the Cam Lever towards the glass to create the suction.



Installing the Display

STEP 1 - Plug the HDMI connector into the HDMI receptacle located on the back side of the display.

STEP 2 - Align the Dual Tabs on the Mount with the mount receiver on the back side of the display, then slide it into place.

STEP 3 - Adjust the viewing angle using the adjustment nut on the mount's swivel head.

STEP 4 - Pull any extra cable back behind the pillar and dash. (Re-install any panels removed during the Cable Installation.)

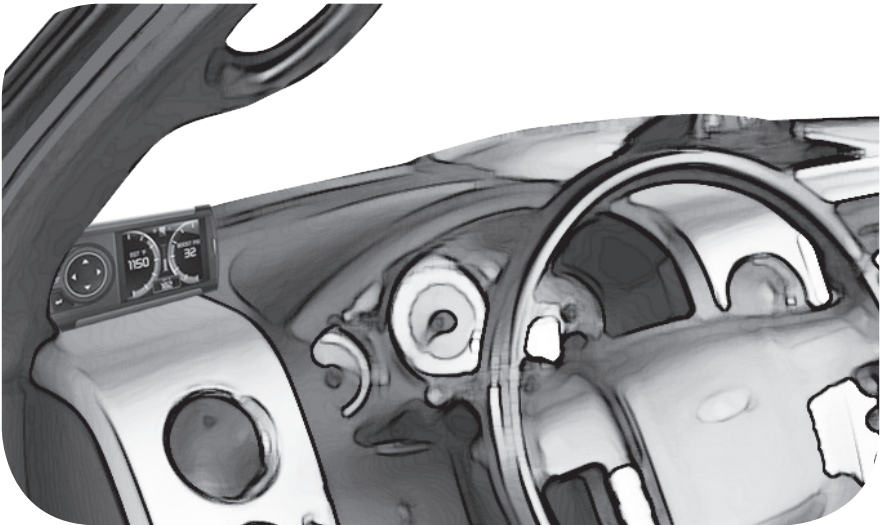

Display Set Up

OEM Selection Menu

Once the installation is complete, and you first plug the device into the OBDII port, the OEM selection menu will appear.

STEP 1 - Turn the vehicle to the ON or RUN key position.

STEP 2 - Select one of the available options that applies:

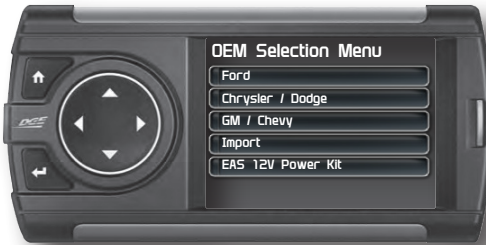

Ford
Chrysler/Dodge
GM/Chevy
Import
EAS 12V Power Kit

STEP 3 - Follow the on screen instructions. The Main Gauge screen will appear.



Changing the Default Background Image

STEP 1 - While viewing the gauge screen, press the Home button.



STEP 2 - On the Main Menu, select the Screen Layout option.



STEP 3 - Select the Background option.



STEP 4 - Use the Left/Right buttons to scroll through the available background images.



Refer to the "Adding Custom Background Images" section of this manual for information on how to add your own images to the display.

Configuring the Home Screens

STEP 1 - While viewing the gauge screen, press the Home button.



STEP 2 - On the Main Menu, select the Screen Layout option.



STEP 3 - Select either of the Layout options.



STEP 4 - Use the Up/Down buttons to scroll through the available screen layouts. Press Enter to select an option.



Layout Options

Master Gauge

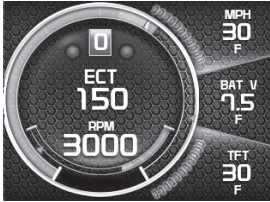

Retro Gauge



Digital Gauges



Needle Gauges

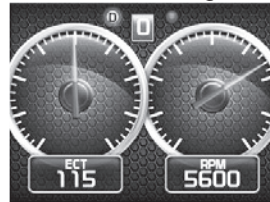

STEP 5 - Once you have highlighted a screen layout, press the Home button to return to the main gauge screen.

STEP 6 - While on the main gauge screen, press the Left or Right arrows to change between screen Layouts 1 and 2.



Individual Gauge Setup

STEP 1 - While viewing a gauge layout screen, press the Enter button. A gauge location will be highlighted.



STEP 2 - Use the arrow buttons to highlight the gauge location that you would like to modify.

STEP 3 - Highlight the Select New PID option. Then press Enter.

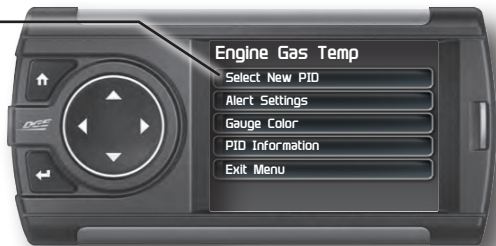

STEP 4 - Use the Up/Down arrow buttons to highlight a new PID, then press Enter.

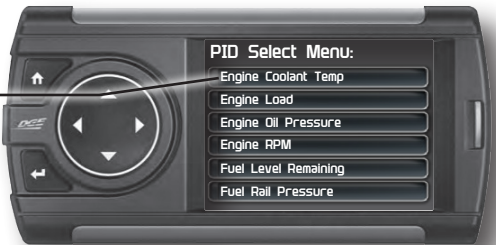

STEP 5 - Select each of the remaining options to further customize your gauge.

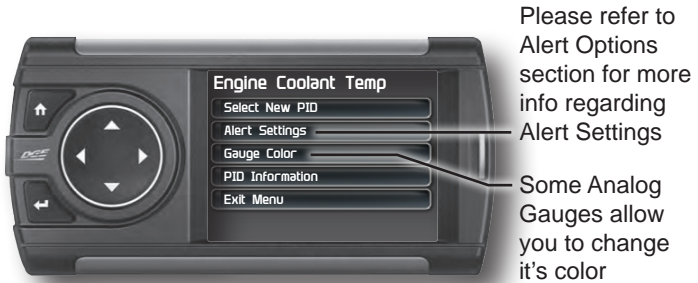

STEP 6 - Return to the main gauge screen. The new PID will be displayed along with any customized options you may have changed.



Download and Install MyStyle Software

MyStyle is software that allows you to customize your display background image and manage your EAS devices.

A computer with internet access is required:

STEP 1 - Go to **edgeproducts**.

STEP 2 - Click the **UPDATES** tab, then Mystyle **DOWNLOAD**.

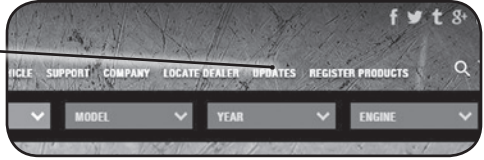

STEP 3 - Open the **MyStyleSetup.exe** file, then click **Run**.

STEP 4 - Click **Next** to begin.

STEP 5 - Choose a folder location, then click **Next** to continue.



STEP 6 - Click **Next** to confirm the installation.

STEP 7 - Click the **OK** button if during the installation, the following message appears:

"These drivers are not Windows Logo or WHQL verified. If you are asked, please choose to install them anyway."

STEP 8 - Click **Close** to exit once the installation is complete.

Adding Custom Background Images

This section describes how to add personalized photos or pictures to your display using a computer.

STEP 1 - Double-click the MyStyle  icon on your desktop.

STEP 2 - Connect the display using the supplied USB cable.
When a display is plugged in, an image of the display will appear with a 9 digit number.

STEP 3 - Click the image of your display. 

STEP 4 - Choose to Customize the Display. 

STEP 5 - Select an Image to replace. 

STEP 6 - Select the Open Image button. 

STEP 7 - Use the available tools to size and align your image. 

STEP 8 - Click the Save Background button to save your progress. This will also save the new background image to you display. 

Settings

Accessory Settings - Turbo Cool Down Setup

This feature is only available and listed if an EAS Turbo Timer display has been installed. The Turbo Cool Down feature allows the engine to continue running (after the key is in the off position) until one of four conditions have been met:

1. If the EGT value falls below the target set point.
2. The time set expires.
3. Pressing either the brake or gas pedal.
4. Pressing a button on the CS2.

STEP 1 - Press the Home button to enter the Main Menu

STEP 2 - Use the Up/Down arrow buttons to scroll down to the Settings option.

STEP 3 - Press Enter.

STEP 4 - Next, select Accessory Settings from the Settings menu.

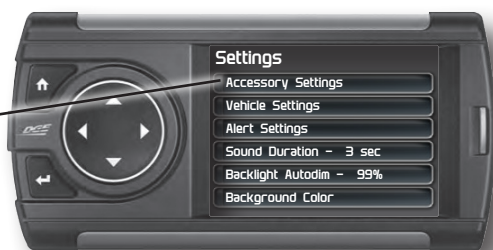

STEP 5 - Select Turbo Cool Down Setup.

STEP 6 - Choose one of the available options.

! WARNING: Do not use this feature in an enclosed area.



Select this option if you would like the turbo timer feature to use a pre-determined EGT value.

Select this option if you would like the turbo timer feature to use a pre-determined time setting (seconds).

This option will disable the turbo timer feature and take you back to the previous menu.

NOTE: 2007-09 Dodge trucks can be turned off using the key's panic button. 2010 Dodge trucks can be turned off if the lock and panic buttons are pressed at the same time.

Vehicle Settings - Tire Size

The display is capable of re-calibrating the vehicle's speedometer and the MPH PID. In order for this to happen, you will need to enter a tire size.

STEP 1 - Press the Home button to enter the Main Menu

STEP 2 - Use the Up/Down arrow buttons to scroll down to the Settings option.

STEP 3 - Press Enter.

STEP 4 - Select Vehicle Settings, then select the Tire Size option.

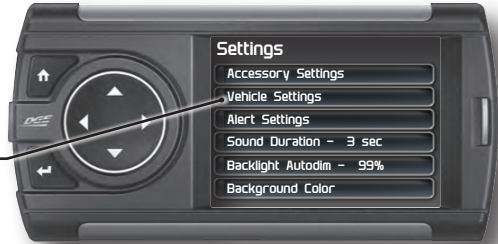

STEP 5 - Select the size option that best fits your application:
Stock Size = Stock Tires
Modified Size = Non-Stock Tires

STEP 6 - Choose the tire format that best fits your application.
(NOTE: You must enter the Stock Size as well if a modified Size is being entered)

English = Height(XX) / width(XX X) / wheel size (RXX)

P-Metric = Width(XXX) / aspect ratio(XX) / diameter (RXX)

Circumference = The outer circumference of the tire (mm)

Height = The height of the tire (from ground to top of tire)

Return to Stock = Erases any tire info you have entered, and returns the tire size to the original default setting.



STEP 6 - Use the arrow buttons to highlight a number, then press enter to select it. When done select Done or press Enter.



OR



Alert Settings

STEP 1 - Press the Home button to enter the Main Menu.

STEP 2 - Use the Up/Down arrow buttons to scroll down to the Settings option.

STEP 3 - Press Enter

STEP 4 - Select Alert Settings from the list.

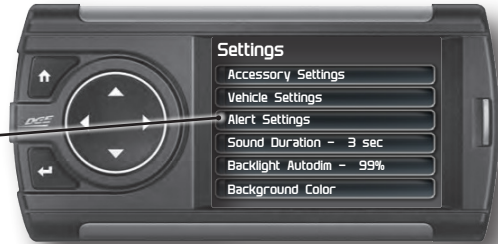

STEP 5 - Select a PID from the list.

STEP 6 - Make your adjustments.

In the example below, battery voltage is being modified.

Turn On or Off the alert system for all PIDs.

Turn On or Off this specific PID's alerts.

Turn On or Off the alert sound for this PID only.

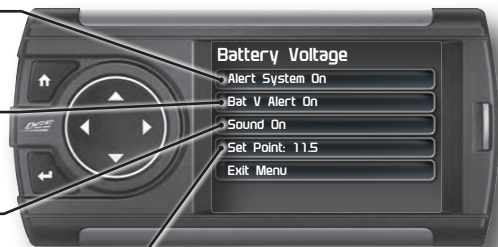

This is the point at which you want the alert to be triggered for this PID.
The example above shows 11.5 as the value. If the display detects a battery voltage of 11.5 volts or less, the alert will be triggered.

During an alert:

- 1) One of these lights will light up red and have an A inside it.
- 2) An alert message will be displayed
- 3) The gauge will flash red



Sound Duration - Alerts

STEP 1 - Press the Home button to enter the Main Menu.

STEP 2 - Use the Up/Down arrow buttons to scroll down to the Settings option.

STEP 3 - Press Enter

STEP 4 - Select Sound Duration from the list.

STEP 5 - Adjust the time (in seconds) to the length of time an alert should sound.

STEP 6 - Press Enter



Backlight Autodim

Each display is equipped with a light sensor that detects how much light is entering the vehicle cab. During the day, the display will be at its maximum brightness. As it gets darker outside, the display will automatically dim according to the amount of sunlight. If the value is kept at 99%, the display will be as dim as possible. If the value is set to 50%, the display will only be half as dim at night.

STEP 1 - Press the Home button to enter the Main Menu.

STEP 2 - Use the Up/Down arrow buttons to scroll down to the Settings option.

STEP 3 - Press Enter

STEP 4 - Select Backlight Autodim from the list.

STEP 5 - Adjust the percent value.

STEP 6 - Press Enter.

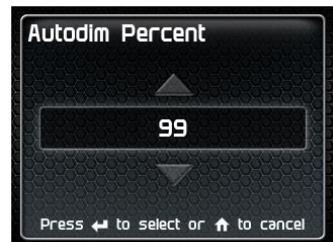

Background Color

STEP 1 - Press the Home button to enter the Main Menu.

STEP 2 - Use the Up/Down arrow buttons to scroll down to the Settings option.

STEP 3 - Press Enter

STEP 4 - Select Background Color from the list.

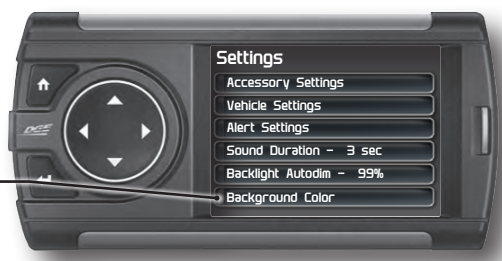

STEP 5 - Use the Up/Down arrow buttons to toggle between the options on the Color Mixer screen. Use the Left/Right arrow buttons to adjust their values.

STEP 6 - Make your adjustments.

The viewing window allows you to see the changes you are making real time



Red Values
Green Values
Blue Values
Opacity Value: If this value is above 80%, you may no longer see the background

Use the Color selector to quickly choose default colors, or a mixed color you have saved previously

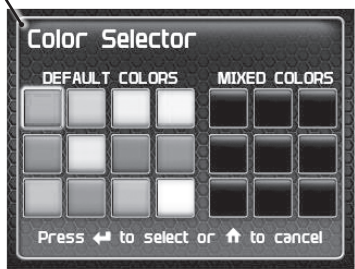

Menu Time out

This feature prevents the display from staying on for excess amounts of time. Once the time runs out, the display will return to the main gauge screen, then shut off.

STEP 1 - Press the Home button to enter the Main Menu.

STEP 2 - Use the Up/Down arrow buttons to scroll down to the Settings option.

STEP 3 - Press Enter

STEP 4 - Select Menu Timeout from the list.

STEP 5 - Adjust the time (in seconds).

STEP 6 - Press Enter.



Units

Changing the unit option allows you to view PIDs in either Metric or English. Vehicle Speed, for example, may be viewed as either MPH or KPH. Temperature PIDs such as Engine Coolant Temperature may be viewed as either Fahrenheit or Celsius, etc.

CAUTION: *If you set up your display while the units are in English, and then switch to Metric, the values will remain the same, and not be converted.*

Factory Reset

This feature will return the display to the factory default settings. All records and input data will be deleted and not recoverable.

STEP 1 - Press the Home button to enter the Main Menu.

STEP 2 - Use the Up/Down arrow buttons to scroll down to the Settings option.

STEP 3 - Press Enter

STEP 4 - Select Factory Reset from the list. Press Enter.

Juice Control

Installing the Juice Hardware

Refer to the Juice Installation Guide for detailed information on how to install the Juice specific hardware (harness, sensors, etc.)

Adjusting Power Levels

STEP 1 - While on the Main Gauge screen Press the Up or Down arrows until the power level you want is shown in the Level Indicator box.



Power levels Explained

MILEAGE (LEVEL 1) - Recommended for daily driving. The mileage tuning was created for optimal fuel economy under normal driving.

TOW (LEVEL 2) - Recommended when pulling a load. The tow tuning was created to provide power where it is needed most when pulling a load.

DRIVE (LEVEL 3) - Recommended for all around daily driving and performance.

RACE (LEVEL 4) - Recommended for sanctioned racing events. The fuel injection and timing strategies are aggressively tuned to pull substantial power gains from the vehicle without sacrificing drive-ability or durability.

EXTREME (LEVEL 5) - Recommended for sanctioned racing events. The fuel injection and timing strategies are aggressively tuned to pull the highest level of power and performance from your vehicle.

HOT UNLOCKER (LEVEL 6 OPTIONAL) - This level should only be used when the vehicle power and drive-train have been upgraded. To unlock this level you will need to:

1. Visit edgeproducts.
2. Click the support tab.
3. Click the “Hot Unlock Codes” option.
4. On the Hot Unlock web page, scroll down to the bottom and choose to either purchase a code online, or download a form for mail in.

NOTE: The Hot Unlocker level is available only on specific trucks.

Adjusting the Juice Control Settings

This menu allows you to regulate engine power delivery and drive-train performance by enhancing the Engine Control Module (ECM) factory settings through the Juice Module.

STEP 1 - Press the Home button to enter the Main Menu

STEP 2 - Use the Up/Down arrow buttons to scroll down to the Juice Control option.

STEP 3 - Press Enter.

STEP 4 - Select an option to adjust it's settings.



STEP 5 - Refer to the following sections for more information on each setting and how it is used.

NOTE: *The following settings may or may not be available depending on your make of vehicle and/or your Edge Product.*

Backdown Settings

NOTE: Depending on your make and model the following backdown features may or may not be available for your vehicle.

Based on certain parameters, the Attitude will automatically defuel the vehicle at a specified set point. As the value approaches the set point, a percentage of de-fueling occurs. This percentage is shown as the back-down value. When 100% is reached, the Juice module is no longer controlling the vehicle.

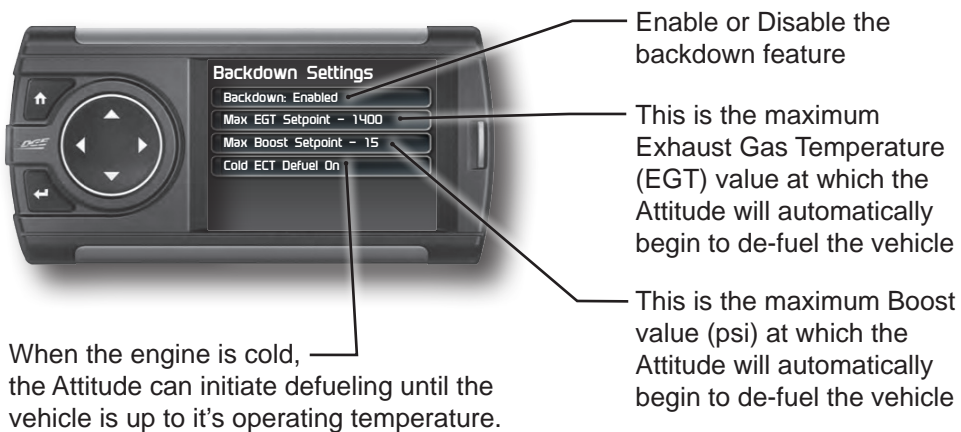

CAUTION: Other high performance modifications in addition to the Juice can allow the fueling to exceed the max set point and stock EGT levels, even after 100% de-fueling by the Attitude. This may result in detrimental EGT levels and potential power-train damage.

CAUTION: On the 1999-2003 Ford 7.3L, EGT Back-down will remove even the stock power in order to limit EGT.

Low Boost Response

These settings are used to determine the percentage of the extra fuel that will be added as Turbo Boost increases.

There are 5 settings for each Power Level. If you want the extra fuel to be distributed across a larger range (such as 0-20psi), you would pick a small number such as 1 or 2. If you want the extra fuel to be added across a smaller range (such as 0-5psi), you would choose a more aggressive setting such as 4 or 5.

STEP 1 - Select an individual power level.

STEP 2 - Adjust the settings.

STEP 3 - Press the Home button to return to the gauges.

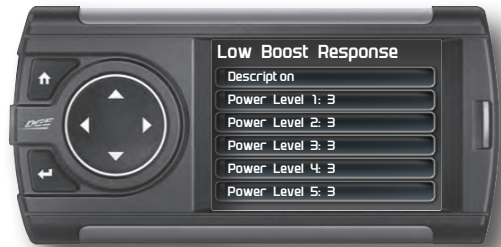

Torque Management

NOTE: Available on on 2013-15 Dodge Diesel Trucks

These settings are used to determine how much fuel will be added during low Turbo Boost conditions.

STEP 1 - Select an individual power level.

STEP 2 - Adjust the settings.

STEP 3 - Press the Home button to return to the gauges.



Transmission Setup

NOTE: Depending on your make and model the following features may or may not be available for your vehicle.

These settings allow for de-fueling during shift & torque converter lock.

CAUTION: We recommend choosing de-fueling (Yes) during torque converter or clutch slip for stock transmissions. Selecting (No) will allow the Juice to fuel when the transmission slips. (Yes) eases the transmission strain because the Juice lowers its power output when the torque converter or clutch is slipping.

STEP 1 - Select an individual feature.

STEP 2 - Adjust the settings.

STEP 3 - Press the Home button to return to the gauges.

After selecting this feature, you will be given 3 options:

1. Defuel all shifts
2. Defuel 5-6 (or 4-5) shift
3. No defuel on shifts

Protects your transmission from slipping. This feature may also be available directly under the Juice Control menu for some vehicles

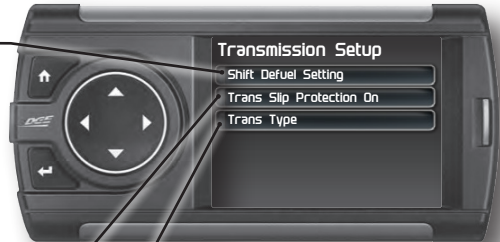

On specific Dodge trucks, after selecting this feature, you will be given 3 transmission options:

1. Automatic
2. 6spd Right Up
3. 6spd Left Down

NOTE: The right/up & left/down refer to the location of your reverse gear.

Defuel WOT Shifts

NOTE: Depending on your make and model the following features may or may not be available for your vehicle.

This option allows you to defuel during a shift that takes place at Wide Open Throttle (WOT).

Press the Enter button to toggle this feature On or Off



Timing Options

NOTE: This option is only available on specific Dodge diesel trucks.

Juice Timing will allow the timing to be matched with the Juice Power options.



Stock Timing will allow the engine to run according to stock settings.

Truck Model Year

NOTE: This option is only available on specific Dodge diesel trucks.

Select the year in which your truck was built.

This allows the Juice and Attitude to adjust settings based on your vehicle.

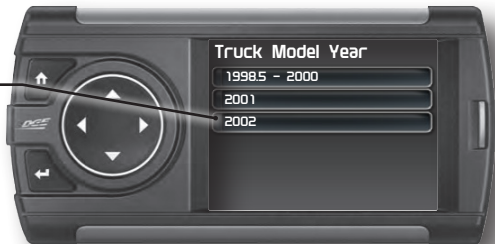

Axle Ratio

Caution: *This feature should only be used if you have replaced the stock Axle.*

This option allows you to adjust the calculated output shaft speed.

Use the UP/DOWN arrow buttons to adjust the ratio, then press Enter.



Performance Tuning

Trans Only Tuning

For 99-07' Ford trucks, your Attitude will allow you to program and configure the vehicle's transmission settings. It will provide firmer transmission shifts which may help increase transmission life and shift performance.

CAUTION: Programming requires that the vehicle be parked and not moving. As such, make sure to park away from traffic or areas where the vehicle may impede access or exit. Programming will take several minutes and the vehicle can't be started during this process.

STEP 1 - Unplug all power consuming devices plugged into the cigarette lighter or other power ports. (NOTE: Some vehicles require that the radio fuse be removed prior to programming.)

STEP 2 - Press the Home button to enter the Main Menu.



STEP 3 - Use the Up/Down arrow buttons to scroll down to the Performance Tuning option. Press Enter.

STEP 4 - Select the Trans Only option. (Selecting Stock will return your vehicle back to it's stock settings)

⚠ WARNING: Do Not combine or "Stack" chips (modules) to gain more horsepower. The chips could be incompatible and result in power-train failure or create dangerous conditions leading to a serious or fatal accident.



STEP 5 - Press Enter to continue.

STEP 6 - When asked if you would like to create a custom program, select Yes.

STEP 7 - Scroll through the available options and modify each accordingly.

STEP 8 - Select Continue Programming.

STEP 9 - When asked, follow the Key-ON / Key-OFF instructions.



(NOTE: After the programming is complete, you will be taken back to the Levels screen. At the top it will say: "Current Lvl - the tune you picked") Levels screen. At the top it will say: "Current Lvl - the tune you picked")

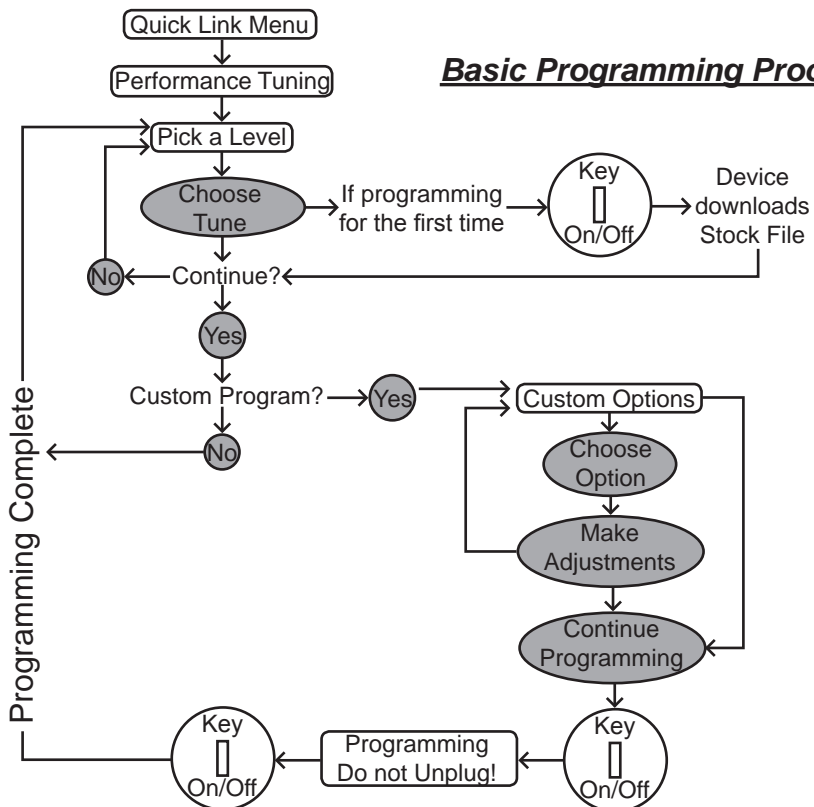

Custom Options Explained

SPEED LIMITER

This option allows you to set the maximum speed of your vehicle.

Use the UP/DOWN arrow buttons to adjust the speed, then press Enter.



⚠ WARNING: *Removal/adjustment of the factory speed limiter is intended for use at a closed circuit, legally sanctioned racing environment. If you drive on public roads after removal or adjustment of the speed limiter, you must still obey all driving laws, including adhering to posted speed limits. To drive at racing speeds on public roads seriously endangers you, your passengers, and others nearby. Also it is your responsibility to ensure your tires and other vehicle components are rated to travel at increased speeds. Driving at high speeds with inadequate tires or other components can lead to serious or fatal injury.*

Caution: *Removing/adjusting the speed limiter for purposes inconsistent with the product's intended function violates the product's intended use and will invalidate the product's warranty. Edge Products is not responsible for, or liable for the consequences of improper product use.*

REV LIMITER

This option allows you to set the maximum RPM of your vehicle.

Use the UP/DOWN arrow buttons to adjust the RPM, then press Enter.



TIRE SIZE

If you've changed the factory tires, this option allows you to input the new size.

Use the UP/DOWN arrow buttons to adjust the size, then press Enter.



IDLE RPM

This feature allows you to set the RPM at idle.

Use the UP/DOWN arrow buttons to adjust the RPM, then press Enter.



SHIFT POINTS

This option allows you to adjust when (in MPH) each gear shift takes place.

Use the UP/DOWN arrow buttons to adjust the MPH, then press Enter.



SHIFT FIRMNESS

This option allows you to adjust how firm each gear shifts. The higher the percentage, the more firm the shift.

Use the UP/DOWN arrow buttons to adjust the %, then press Enter.



Diagnostics

Read DTCs

When your PCM detects a problem with your vehicle it sets a trouble code, and most times a “Check Engine” light on your dash is activated. These codes can be retrieved and used to help diagnose specific issues.

STEP 1 - Press the Home button to enter the Main Menu.



STEP 2 - Use the Up/Down arrow buttons to scroll down to the Diagnostics option.

STEP 3 - Press Enter.

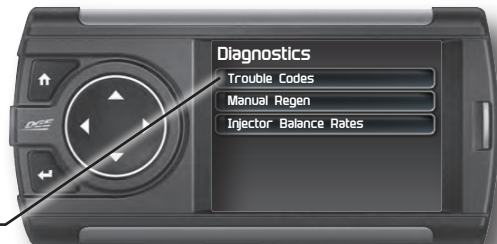

STEP 4 - Select Trouble Codes. Press Enter.

STEP 5 - Select Read DTCs. Press Enter.



STEP 6 - If a code is listed, select the code to see a brief explanation of the issue.

If a code is shown, write down the information given. You can use this code number to research the particular issue. The internet is a good resource for looking up most codes.



Clear DTCs

This feature allows you to clear most DTCs. This will erase any codes currently set. If the codes come back we recommend you see a qualified mechanic who can accurately diagnose and repair the problem.

STEP 1 - Press the Home button to enter the Main Menu.

STEP 2 - Use the Up/Down arrow buttons to scroll down to the Diagnostics option. Press Enter.

STEP 3 - Select Trouble Codes. Press Enter.

STEP 4 - Select Clear DTCs. Press Enter.



Clear On Start

This feature is not available on all products.

In some instances, DTCs may need to be cleared every time the truck starts or the truck will go into "limp" mode.

NOTE: *Fords and Chevy's are able to clear codes while the truck is running. Dodge Trucks however may require you to clear only when the key is on and the engine is not running.*

STEP 1 - Press the Home button to enter the Main Menu.

STEP 2 - Use the Up/Down arrow buttons to scroll down to the Diagnostics option. Press Enter.

STEP 3 - Select Trouble Codes. Press Enter.

STEP 4 - Select Clear On Start. Press Enter to toggle between Yes and No.

Manual DPF Regeneration

Available only on specific Diesel Trucks

Manual regeneration allows you to manually clear out the Diesel Particulate Filter (DPF). Completing a manual regeneration cycle will clear the soot mass in the filter, and lower exhaust back pressure to improve exhaust flow.

STEP 1 - Press the Home button to enter the Main Menu.



STEP 2 - Use the Up/Down arrow buttons to scroll down to the Diagnostics option.

STEP 3 - Press Enter.

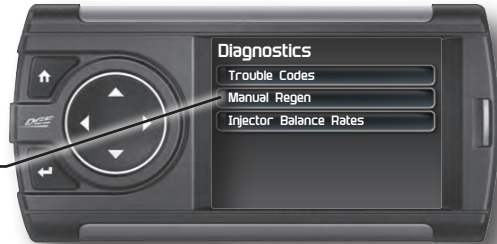

STEP 4 - Select Manual Regen. Press Enter.

STEP 5 - Press Enter to continue with the regen.

NOTE: When manually initiating a regeneration cycle, some vehicles will require a drive cycle (i.e. you have to drive the vehicle some distance) while others may allow you to initiate a Service Regeneration where you can leave the vehicle parked and the engine running. If the latter is the case, be sure to use the following guidelines.

- 1. Park the vehicle outdoors and keep people, other vehicles, and combustible materials away from it.*
- 2. Do not leave the vehicle unattended.*
- 3. Do not connect any shop exhaust hoses or vents to the tail pipe.*

DPF Regeneration Explained

CAUTION: Exhaust temperatures may be greater than 300C (572 F) during service regeneration.

CAUTION: Due to the elevated temperatures during this procedure, open the hood and keep the front of the vehicle away from anything impeding air flow to the radiator.

DPF REGENERATION

If you own a newer diesel powered vehicle, your vehicle is equipped with a diesel particulate filter (DPF). This filter is used in conjunction with a diesel oxidation catalyst. Together they work to reduce the amount of soot and emissions emitted from the tailpipe. As soot builds up in the DPF it will begin restricting flow. The soot that gathers is automatically purged in one of two ways: Passive Regeneration & Active Regeneration. Both methods occur automatically and require no action on your part. During either of these regeneration methods, you may notice an increase or change in the exhaust noise & increased Exhaust Gas Temperature (EGT).

PASSIVE REGENERATION

Passive regeneration occurs when the exhaust gas temperature (EGT) reaches an appropriate level in order to oxidize or burn soot to clean the DPF. This method can happen as a result of normal engine operating conditions, typically when the engine reaches an (EGT) high enough to burn off the soot (i.e. heavy towing, high load conditions, etc). If EGTs do not get hot enough to cause passive regeneration, your truck's engine-control system automatically initiates an active regeneration.

ACTIVE REGENERATION

During active regeneration, the truck computer cleans the DPF by raising the exhaust temp to a point where the soot is burned away. This is accomplished through various engine actions which raise the EGTs in the oxidation catalyst/DPF system to a level where the soot is burned off. After the soot is burned off, the EGTs and back pressure (restriction) fall back to normal levels. In order to help you know the status of DPF Regeneration, the device will show in the alerts section of the drop down menu anytime active regeneration is happening.

Injector Balance Rates

Available only on specific GM/Chevy Trucks

Injector Balance Rates are used to determine if all injectors are operating within the correct tolerances. If you are experiencing a misfire, knock, excessive smoke, or rough running conditions with no DTCs, this option can help identify faulty injectors. The balance rates are the fuel adjustments for each individual cylinder based on the variations in engine crankshaft speed. These will change depending on if the transmission is in Neutral or Drive. Injectors that read outside of the +/- 4.0 in park/neutral or +/- 6.0 in drive may be faulty.

STEP 1 - Press the Home button to enter the Main Menu.

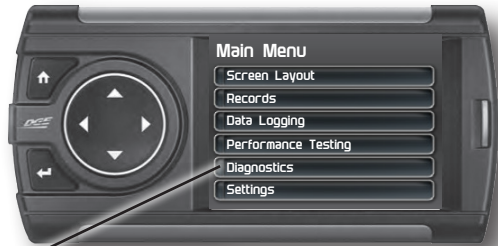

STEP 2 - Use the Up/Down arrow buttons to scroll down to the Diagnostics option.

STEP 3 - Press Enter.

STEP 4 - Select Injector Balance Rates.



STEP 5 - Press Enter to continue.

STEP 5 - Watch each injector value while in Park/Neutral, and then while in Drive.

STEP 6 - Press the Enter button to return to the gauge screen.



If you suspect a faulty injector, we recommend consulting a professional diesel mechanic who can verify the issue and also perform a cylinder power balance test to further diagnose.

Transmission Relearn

For 2001-2013 GM diesel trucks only

The vehicles listed above are equipped with transmissions that “learn” while you drive. Sometimes when these vehicles are programmed with an aggressive tune, the transmissions act differently. This feature forces the transmission to relearn and accommodate the new tune.

STEP 1 - Press the Home button to enter the Main Menu.

STEP 2 - Scroll down to the Diagnostics option. Press Enter.

STEP 3 - Scroll through the list and select Trans Relearn.

STEP 4 - When asked, select Yes to continue.

STEP 5 - Drive the vehicle as you normally would.
The transmission will relearn as you drive.

NOTE: After the relearn commands are sent there might be some clunks, bumps, and/or short flares, especially during the 3-4 shift (3rd gear to 4th gear). This is normal. Completion of this feature will require a minimum of 3 upshifts at a steady throttle angle.

Performance Testing

0-60 & Quarter Mile

Performance tests can be helpful for measuring performance gains after vehicle modifications have been made. The results recorded during these test will likely differ from what you'll see on a drag-strip or other racing venues. Incorrect speedometer calibration, data sample rate, and tire slippage can cause miscalculations in the displayed results.

STEP 1 - Press the Home button to enter the Main Menu.

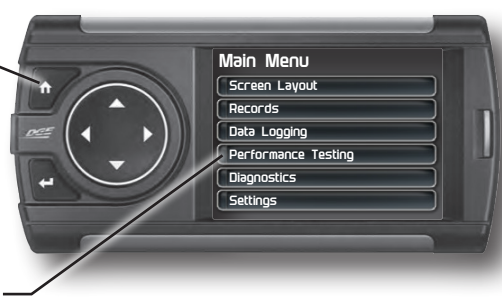

STEP 2 - Use the Up/Down arrow buttons to scroll down to the Performance Testing option.

STEP 3 - Press Enter.

STEP 4 - Select either the 0-60 or Quarter Mile option.



STEP 5 - Bring the vehicle to a complete stop.

STEP 6 - Use the drag strip style light tree on the left of the screen to know when to begin accelerating. Once you have reached 60 mph (or a quarter mile), the test will show as completed.



STEP 7 - Press any button to exit the test.

⚠ WARNING: Do not use the Performance Tests feature to break any traffic laws.

Horsepower

NOTE: Before using the Horsepower test, the vehicle weight (aka curb weight) must be entered first. The curb weight is the total weight of a vehicle with standard equipment, all necessary operating consumables (e.g., motor oil, coolant), a full tank of fuel, with no passengers or cargo.

STEP 1 - Press the Home button to enter the Main Menu.

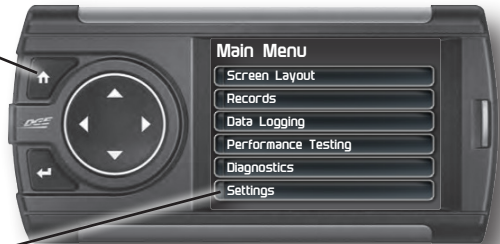

STEP 2 - Use the Up/Down arrow buttons to scroll down to the Settings option.

STEP 3 - Press Enter.

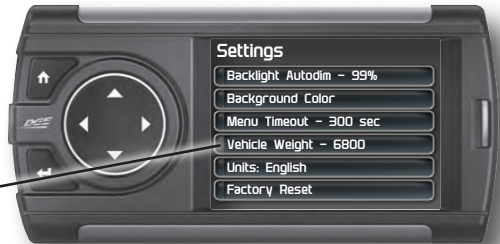

STEP 4 - Scroll down and select the Vehicle Weight option.

STEP 5 - Use the Up/Down buttons to enter the correct weight. Press Enter.



STEP 6 - Press the back button to return to the main menu. Select the Performance Tests option. Press Enter.

STEP 7 - Select the Horsepower option. Bring the vehicle to a complete stop.

STEP 8 - Follow the on-screen instructions. Press any button to stop the test.

Data Logging

Data Logging Explained

The data logging feature allows you to record all of the available PID data on your display. This information can be retrieved and viewed using the MyStyle software package.

NOTE: *The display also runs background tasks which are also recorded. This information can be ignored.*

STEP 1 - Press the Home button to enter the Main Menu.



STEP 2 - Use the Up/Down arrow buttons to scroll down to the Data Logging option. Press Enter.

STEP 3 - Select one of the (5) Data Run options. This will turn the run On or Off.



NOTE: *Only one run can be turned on at a time.*

STEP 4 - Select the Home button to return to the main gauge screen. The display is now in recording mode.

STEP 5 - Once you have recorded for a specific amount of time, return to the Data Logging menu and turn Off the run.

NOTE: *The maximum amount of Data Logging time depends on how many items you are logging at once. This may be anywhere from 15 to 20 minutes total. Once the limit is reached, the Data Logging feature will be automatically shut off.*

NOTE: *If you turn the same Data Run back On, the previous data will be erased and a new recording session will begin. If the indicator light is red, there is currently a recorded file associated with that run.*

Retrieving Data Using MyStyle

This section describes how to retrieve the data recorded during a Data Logging recording session. If you have not yet installed MyStyle refer to the Display Set Up section of this manual.

STEP 1 - Double-click the MyStyle  icon on your desktop.

STEP 2 - Connect the display using the supplied USB cable. *When a display is plugged in, an image of the display will appear with a 9 digit number.*



STEP 3 - Click the image of your display.

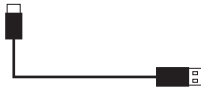

STEP 4 - Select Data Logs.



STEP 5 - Click the Save File As button and save the file.

STEP 6 - Locate the saved file on your computer and open it. The file will be saved as a .CSV file and can be opened using Microsoft Excel or similar.

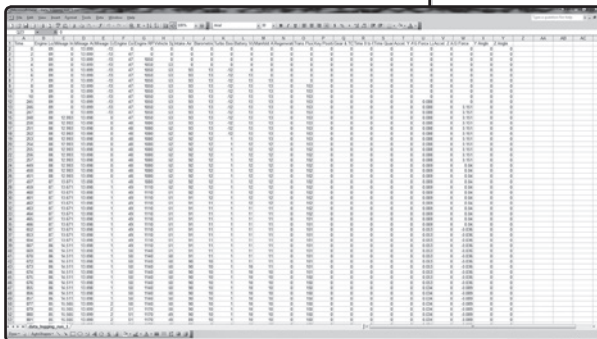

Time	EST F	BOOST PSI	...
11:00:00	1150	32	...
11:00:01	1150	32	...
11:00:02	1150	32	...
11:00:03	1150	32	...
11:00:04	1150	32	...
11:00:05	1150	32	...
11:00:06	1150	32	...
11:00:07	1150	32	...
11:00:08	1150	32	...
11:00:09	1150	32	...
11:00:10	1150	32	...
11:00:11	1150	32	...
11:00:12	1150	32	...
11:00:13	1150	32	...
11:00:14	1150	32	...
11:00:15	1150	32	...
11:00:16	1150	32	...
11:00:17	1150	32	...
11:00:18	1150	32	...
11:00:19	1150	32	...
11:00:20	1150	32	...
11:00:21	1150	32	...
11:00:22	1150	32	...
11:00:23	1150	32	...
11:00:24	1150	32	...
11:00:25	1150	32	...
11:00:26	1150	32	...
11:00:27	1150	32	...
11:00:28	1150	32	...
11:00:29	1150	32	...
11:00:30	1150	32	...
11:00:31	1150	32	...
11:00:32	1150	32	...
11:00:33	1150	32	...
11:00:34	1150	32	...
11:00:35	1150	32	...
11:00:36	1150	32	...
11:00:37	1150	32	...
11:00:38	1150	32	...
11:00:39	1150	32	...
11:00:40	1150	32	...
11:00:41	1150	32	...
11:00:42	1150	32	...
11:00:43	1150	32	...
11:00:44	1150	32	...
11:00:45	1150	32	...
11:00:46	1150	32	...
11:00:47	1150	32	...
11:00:48	1150	32	...
11:00:49	1150	32	...
11:00:50	1150	32	...
11:00:51	1150	32	...
11:00:52	1150	32	...
11:00:53	1150	32	...
11:00:54	1150	32	...
11:00:55	1150	32	...
11:00:56	1150	32	...
11:00:57	1150	32	...
11:00:58	1150	32	...
11:00:59	1150	32	...
11:01:00	1150	32	...

Records

Records Explained

Records contain certain parameters for later review. This is useful after completing a performance test on the drag strip, at a sled pull, or when you are trying to trouble shoot a particular issue.

STEP 1 - Press the Home button to enter the Main Menu.

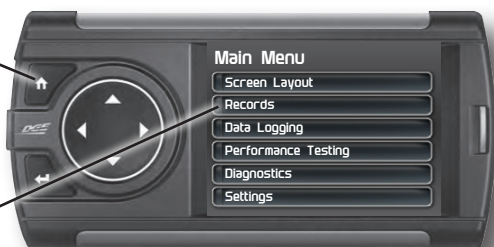

STEP 2 - Use the Up/Down arrow buttons to scroll down to the Records option. Press Enter.

STEP 3 - Scroll through the list to view all records.



STEP 4 - While an individual record is highlighted, you can clear it by pressing the Enter button.

STEP 5 - If you want to clear all records at the same time, highlight the Clear All option and press the Enter button.

Help

Help Menu Explained

The Help Menu contains useful information about your display, and the vehicle it is currently plugged into. It also contains Edge Products contact information and Technical Support tools.

STEP 1 - Press the Home button to enter the Main Menu.

STEP 2 - Use the Up/Down arrow buttons to scroll down to the Help option. Press Enter.



STEP 3 - Select the option that best describes your need:

Product Info (Display)

- Version
- Application Version
- Calibration Version
- Firmware (BC) Version
- FPGA Version
- MSP430 Version
- Serial Number (used to identify your display in the software update process and during Technical Support calls)

Product Info (EAS)

If you have an EAS device installed on your vehicle and plugged into your display, another Product Info screen will be available. It will list your EAS device's Firmware Version as well as its serial number.

Vehicle Info

Displays important information about your vehicle that is used by technical support to trouble shoot issues.

Contact Info

Shows our website, company address, the technical support email address, and the technical support phone number.

Tech Support Tools

This menu should only be used when requested by Edge Products Technical Support personnel.

Maintenance Manager

Turn on Maintenance Manager

The Maintenance Manager calculates the odometer value of your vehicle using the vehicle speed and time. Since this option is not going to always match your real dash odometer reading, you will need to periodically update the Maintenance Manager's odometer value. We will automatically adjust it based on the changes you make to the Maintenance Manager.

STEP 1 - Press the Home button to enter the Main Menu.



STEP 2 - Use the Up/Down arrow buttons to scroll down to the Maintenance Manager option.

STEP 3 - Press Enter.

STEP 4 - Press the Enter button to turn on the Maintenance Manager.



(Press Enter to toggle the feature On and Off.)

Entering the Odometer Value

STEP 1 - Press the Home button to enter the Main Menu.



STEP 2 - Use the Up/Down arrow buttons to scroll down to the Maintenance Manager option.

STEP 3 - Press Enter.

STEP 4 - Use the Up/Down arrow buttons to scroll down to the Odometer option.



STEP 5 - Press Enter.

STEP 6 - Use the arrow buttons to highlight each number, then press Enter to select it.



STEP 7 - Once the correct Odometer value has been entered, highlight the Done button and press Enter.

Setting the Alert Threshold

The alert threshold is the number of miles you would like to be alerted before a specific maintenance item is due. In the example below, you would be alerted 100 miles before the actual mileage it is due.

STEP 1 - Press the Home button to enter the Main Menu.



STEP 2 - Use the Up/Down arrow buttons to scroll down to the Maintenance Manager option.

STEP 3 - Press Enter.

STEP 4 - Use the Up/Down arrows to highlight the Alert Threshold option.



STEP 5 - Press Enter.

STEP 6 - Use the Up/Down arrow buttons to adjust the threshold value.

STEP 7 - Press the Enter button to save the value and return to the Maintenance Manager screen.



Customizing Maintenance Items

Once the odometer has been updated, you may begin to modify each of the specific maintenance items.

STEP 1 - While in the Maintenance Manager menu, select the Maintenance Items option. Press Enter.



STEP 2 - Scroll through and select an item from the list.



Enter the interval (in miles) in which you would like the item to alert you. In this example, you will be Alerted every 3000 miles to change your Air Filter.

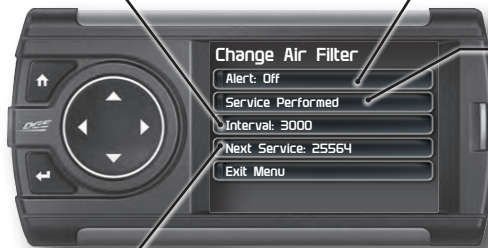

Turning On an alert means the item is now being managed

Press the Service Performed button each time the item is serviced. This will reset the mileage for the Next Service.

NOTE: Refer to your vehicle user manual to determine what interval is recommended for each Maintenance Item.

Based on the Odometer value you previously input, and the Interval value above, the Service Mileage that will read on the vehicle odometer at the time of required service will be calculated and displayed.

Mileage Coach

Mileage Coach Set Up

The Mileage Coach feature provides useful tips and tools that help you learn ways to improve your fuel mileage.

STEP 1 - Press the Home button to enter the Main Menu.

STEP 2 - Use the Up/Down arrow buttons to scroll down to the Mileage Coach option.

STEP 3 - Press Enter.



The Clear Fuel Average option clears the calculated average displayed in the Mileage Average PID.

The Last Fuel Economy option allows you to enter your actual Fuel Economy value. This value is important and should be calculated and entered regularly. This can be manually calculated by dividing the distance travelled by how much fuel you have used ($\text{Distance}/\text{Fuel} = \text{Fuel Economy}$). Some vehicles have their own Fuel Economy average that is displayed in cab and may be used instead of a manual calculation.



The Trip Odometer is used to calculate the Trip Cost and Fuel Average.

The Mileage Cost is a calculated average based on how many miles you have traveled and the Fuel Price you entered.

The Trip Cost is calculated from the Fuel Price and the Trip Odometer values.

There are two ways to display the Mileage Coach PID:

Show Difference

Displays the difference between Instantaneous and Average fuel mileage.

Show Values

Displays as: Instantaneous | Average.

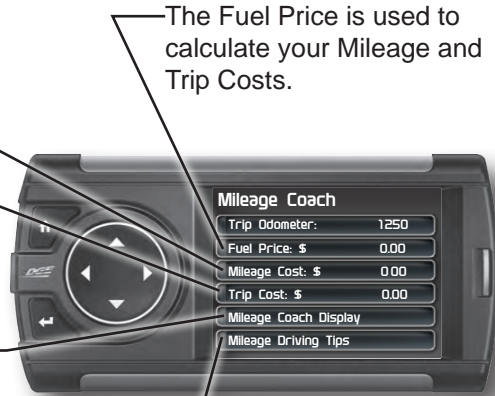

The Fuel Price is used to calculate your Mileage and Trip Costs.

Mileage Driving Tips are intended to give you general information regarding driving habits or anything that will help maximize your fuel economy and overall driving experience.

STEP 4 - Refer to the Individual Gauge Set Up section of this manual to display one or both Mileage Coach PIDs on the main gauge screen.

Mileage Average displays the calculated average MPG or L/100km and is updated continuously while driving. The average is calculated only when the PID is being displayed on the main Gauge Screen. This value will typically change more during start/stop driving, and less on the highway.

Mileage Instantaneous - shows a conscientious driver how to vary the pressure on the gas pedal to save fuel every second. The value is displayed in either MPG or L/100km.

Mileage Coach - takes the Average and Instantaneous values mentioned above and creates a visual tool to help maximize your fuel economy. This PID is best viewed using one of the Analog Gauge locations.

Trouble Shooting Guide

SYMPTOM	POSSIBLE CAUSE	SOLUTION
Display beeps for two seconds	The unit is too hot due to direct sunlight	Once cooled, the display will turn on
No display when the key is "on"	The screen has not yet been activated	Touch the screen or start the vehicle
Fusion drivers will not install correctly	The drivers were not successfully installed	Manually install the drivers
Camera picture is frozen	Bad connections	Double check your fuse and connections
Display beeps quickly	Possible device malfunction	Update the device using Fusion software
Unit will not power on after vehicle is started or after screen or buttons are pressed	Typically this issue is caused by a blown OBDii/Cigarette Lighter Fuse	Replace fuse and test unit again
On Star@: Unable to receive monthly On Star@ e-mail reports	Having the display plugged into your OBDii port may disturb On Star while gathering information for their reports	Unfortunately, there is no real solution for this issue. You could try and call On Star to see when they gather their reports, and unplug your device during that time. This may or may not work for you.
Vehicle does not start after programming	The calibration may not have written properly	Select "Return to Stock" from the programming menu. Then program back to stock. Next, start the vehicle. If the problem continues, contact customer support.
Error 16 when programming	There was a communication error	Try to program the level again
<p>Evolution Programming Errors:</p> <ol style="list-style-type: none"> 1 Your device gets stuck on the "Uploading Boatloader" screen 2 An error is displayed: "ERROR-we could not upload the bootloader to the vehicle." 3 If you are constantly asked to make sure your key is on 4 Error displayed after you device shows blank gauges and says that it is loading. The error will be displayed as "Cannot communicate with vehicle, ensure the key is in the on position." 	<p>Sometimes programming can be disrupted by installed aftermarket devices that are tapped into the trucks communication lines (J1850). These may include but are not limited to aftermarket radios, chime boxes, remote starters, etc.</p> <p>Also, any power consuming devices should not be plugged into the cigarette adapter during the programming process. Fluctuations in power may disrupt the programming process.</p>	<p>The following solutions are good first steps to getting around these programming errors. If these steps do not solve your problem, please contact customer support.</p> <p>FUSES: (CAUTION: Always turn the key off while unplugging fuses).</p> <ol style="list-style-type: none"> 1 Remove fuses connecting radio, radio amplifier, satellite radio, remote starter, or any other aftermarket device you have installed on your vehicle <p>POWER:</p> <ol style="list-style-type: none"> 1 Close all doors during programming 2 Do not operate electrical accessories (radio, windows, wipers, etc.) 3 Remove any devices plugged into the cigarette lighter or any other auxiliary power port

OEM EGT Locations - Diesel Trucks Only

