

JUICE

ATTITUDE



Dodge Juice

Installation Instructions

Safety Terms

Throughout this User Guide (hereafter noted as User Manual or Manual) you will see important messages regarding your safety or the protection of your vehicle. These messages are designated by the words WARNING or CAUTION.



WARNING indicates a condition that may cause serious injury or death to you, your passengers or others nearby. Pay careful attention to these Warning messages, and always comply with them. They could save a life.

CAUTION indicates a condition that could cause damage to your vehicle. It is important to install and operate your EDGE product in conformance with instructions in this Manual. Caution alerts you to particularly important things that will keep your vehicle operating properly.

Product Registration

BENEFITS OF PRODUCT REGISTRATION

- Your Safety** - Registering your product allows us to know exactly which product you have and provide important product updates to you that improve the quality and/or safety of the product.
 - Enhanced Features** - Almost all Edge products are easily updated via the internet. We are constantly adding new features and improvements to our product that we know you will want to enjoy.
 - Confirmation of Ownership** - Provides a record in case of product loss, theft, or required warranty work. When you call us for support our team will already have much of the information they need to help you.
 - Improved Product Development** - Helps us better understand you (our customer) and design products that meet your needs.
 - Special Offers** - Allows us to inform you about special offers on accessories and/or new products that fit your vehicle and enhance your driving experience.
-

Important Notes

1. If you have used another tuner/programmer on your truck, you will need to program your truck back to stock before using the Attitude or Juice.

Failure to return to stock may result in PCM failure or engine damage.

2. Do not program your vehicle in remote location in case of vehicle failure.

3. All Edge modules and programmers are built to operate with OEM calibrations. When you take your vehicle to a service center they may, by your request or otherwise, update your vehicle's calibrations. It is important that you return your vehicle to stock before taking it in for service. Edge updates its products to work effectively with updated OEM calibrations. However, Edge is not always made aware of calibration changes made by the OEM. In the case of discontinued products, Edge cannot ensure that your unit will work effectively if you take your vehicle to a dealership and you are given, by your request or otherwise, a new calibration.

Truck Orientation

The following view is a top view of the vehicle (looking down from above the vehicle). References in the text to “looking down”, means looking toward the ground. Looking up, means looking towards the sky from below the vehicle. Front, rear, left and right are as noted below. See Figure below.

Front of Truck

Driver side of truck—
Usually referred to as
the left side.

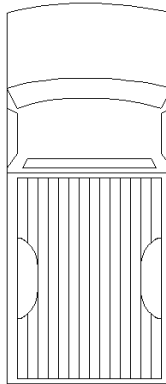

Passenger side of truck –
Usually referred to as the
right side.

Back of Truck

Juice Installation 1998.5-2002 5.9L (24V)

Supplied Items

Note: Depending on your year of truck, you may not need everything provided.

① Quick Install Guide - 1 each



② EGT Probe - 1 each

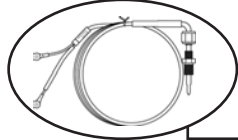

③ Brass Fitting - 1 each



④ Hose Clamp - 1 each



⑤ Zip Ties - 10 each



⑦ Fuel Pressure Sensor - 1 each



⑧ Banjo Bolt - 1 each



⑨ Washers - 2 each

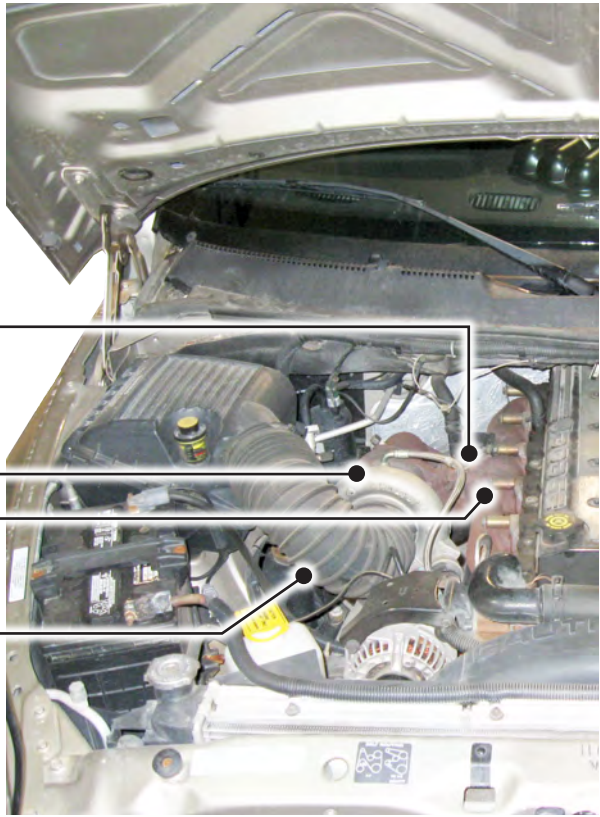

Turbo

Exhaust Manifold

⑥ Transmission Temperature Sensor - 1 each



⑩ Main Wiring Harness - 1 each

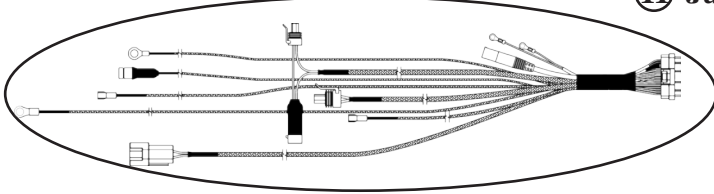

⑪ Juice Module - 1 Each

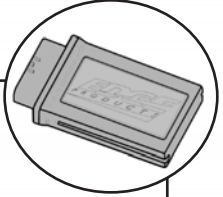

Fuel Filter Location

VP44 Pump Location

Fire wall Grommets

EAS Install Location

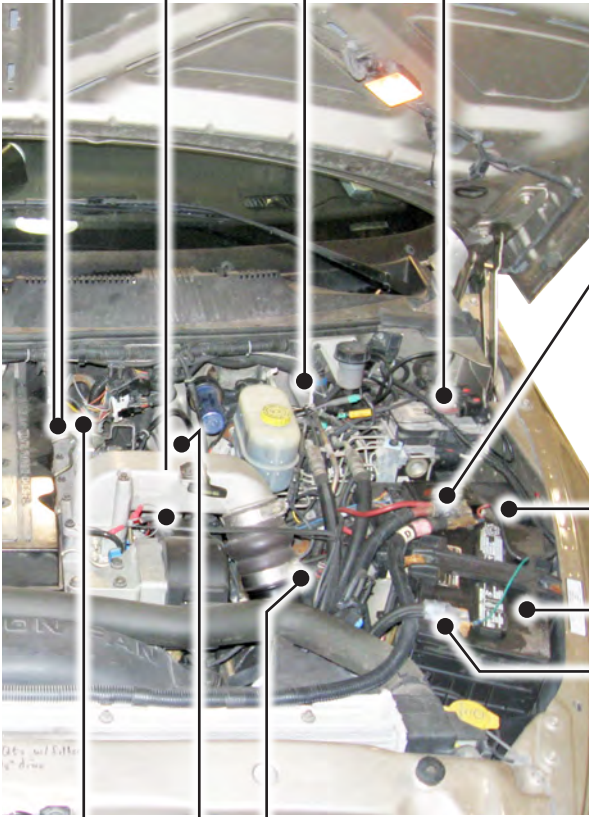

⑫ Velcro - 2 each

⑬ Fuse Link - 2 each

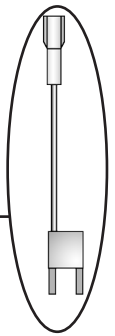

Fuse Box

Battery

Ground Connector Location

98.5-99 Data Link

00-02 Data Link

98.5-02 MAP Sensor

⑭ 2000 (Data Link Adapter)

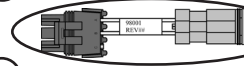

1 each

⑮ 2001-2002 (MAP Adapter)

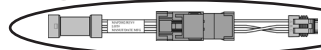

1 each

Required Tools

- Knife
- 2 to 3 ft of wire (fishing)
- Needle nose pliers
- Phillips screwdriver
- Flat tip screwdriver
- 3/8" Drive Torque Wrench
- 1/2" Wrench
- 3/8" Drive Ratchet
- 1/4" Socket
- 5/16" Socket
- 7/16" Deep Well Socket
- 10mm Socket
- 13mm Socket
- 1/8" NPT Tap
- 5/16" or 21/64" Drill Bit
- RTV Silicone Sealer
- Teflon Tape
- Pipe Thread Sealant

Harness Connection Guide

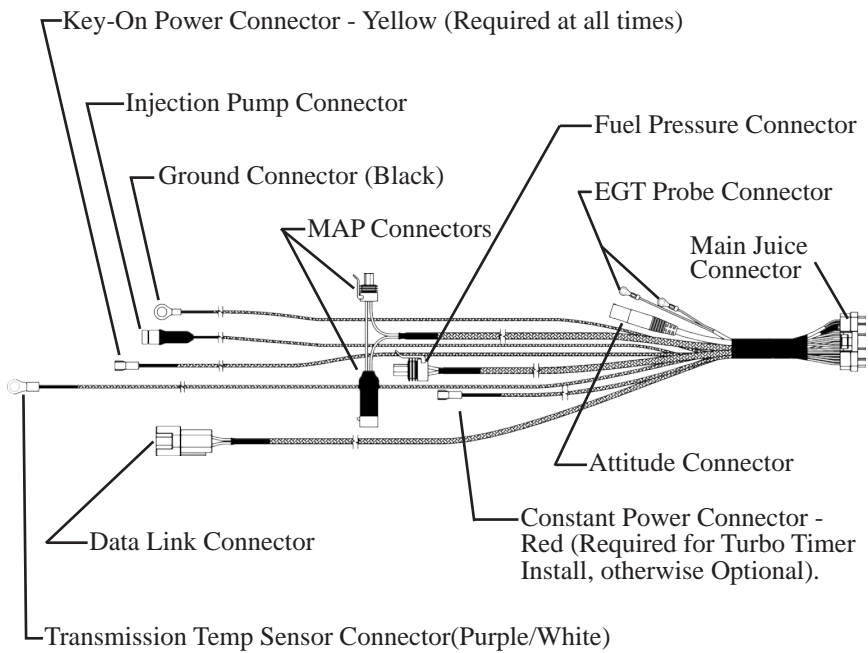

NOTE: Data Link and MAP connectors may vary from this view depending on your vehicle year. If this is the case, you will need to use the supplied adapters.)

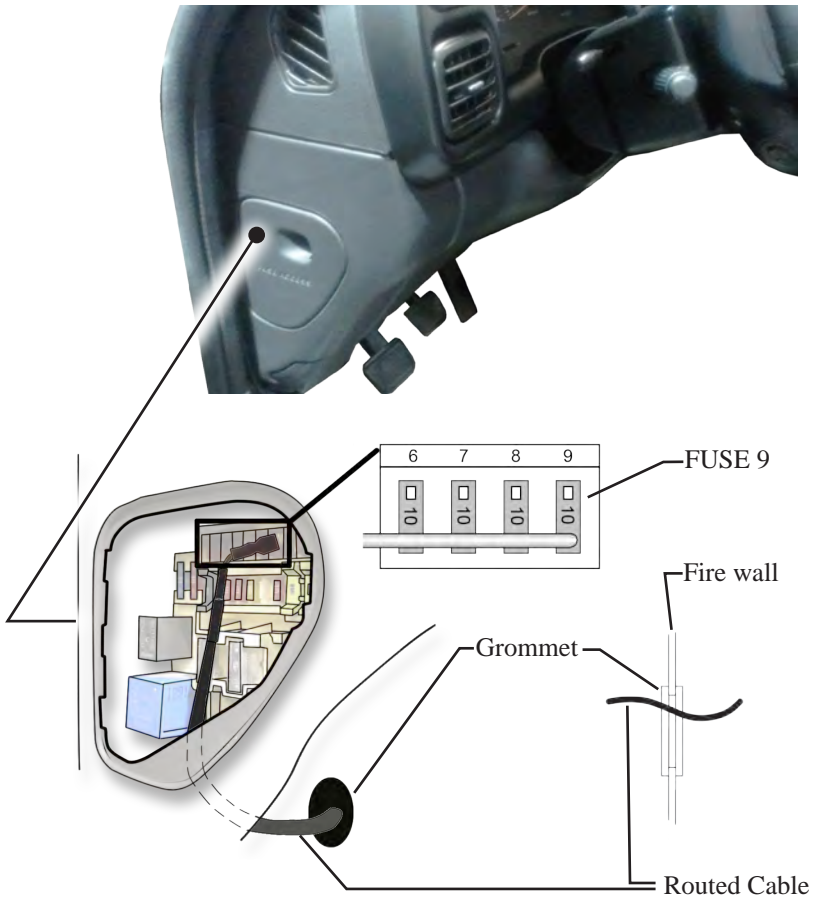

6. Cut a 1/2" slit in the fire wall grommet.

NOTE: Automatics - easy access is the clutch hole grommet located to the left of the fire wall brake hole. Manuals or Automatics- Use the large vehicle wiring harness grommet on the fire wall.

7. Route the Yellow Key-On Connection from the engine compartment to inside the cab through the cut hole from step 6.

8. Locate and remove Fuse 9 (10 Amp) from inside the driver side fuse panel.

9. Insert the Leaded Fuse link. The leg with the wire soldered to it needs to plug into the "HOT" side of the fuse location. Orient the fuse exactly as shown.

10. Connect the Yellow Key-On (routed in step 7) to the installed Fuse Link.



11. Disconnect the stock wiring harness from the boost sensor located at the rear of the fuel filter housing.

12. Plug the Edge harness MAP connectors in between the truck MAP sensor and the truck MAP sensor cable. For 01-02 year trucks, the MAP adapter is needed.

98.5-00 Trucks

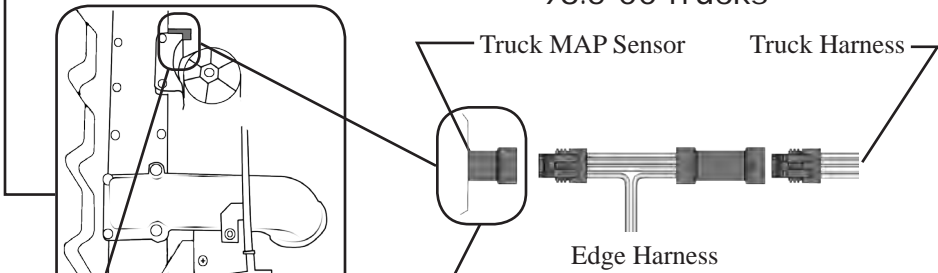

OR

01-02 Trucks

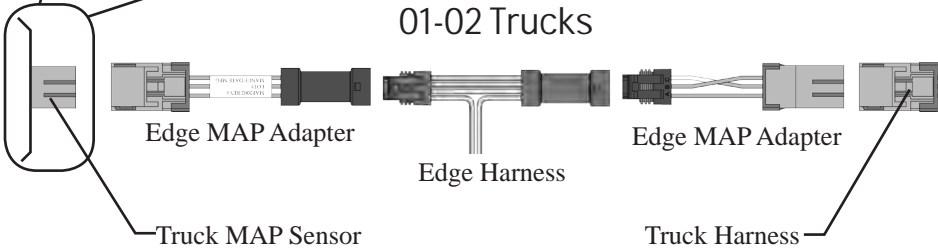

13. Locate the Data link connectors:

1998.5 - 1999: The triangle shaped connector is located on the driver's side of the engine in the wiring harness near the power steering pump.

2000 - 2002: The three pronged flat connector is located on top of the fuel lift pump that is located on the driver's side of the engine directly below the MAP sensor.

NOTE: *On some 2001 trucks the Data Link connector can be located on the driver's side of the engine in the wiring harness near the power steering pump.*

14. Replace the protective plug on the truck Data Link with the Juice harness Data Link Connector as shown below

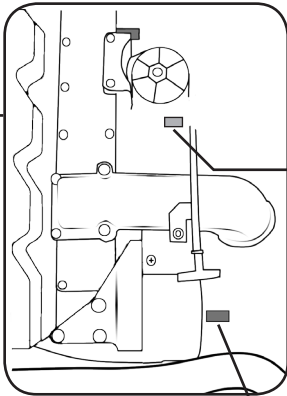

00-02 Trucks

Truck's
Data
Link

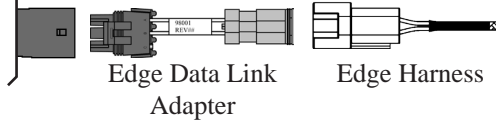

98.5-99 Trucks

Truck's
Data
Link

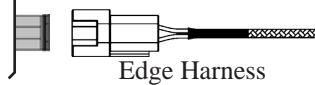



15. Unbolt and remove the casting that attaches to the Throttle Position Sensor (TPS) housing.

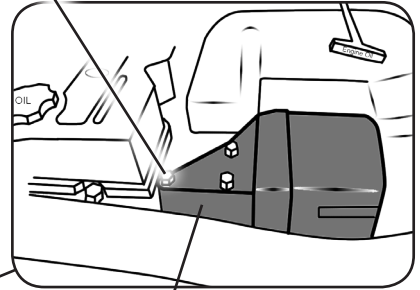

TPS Housing

16. On the Fuel Pump, partially remove the insulation that covers both pump wires.

VP44 Fuel Pump

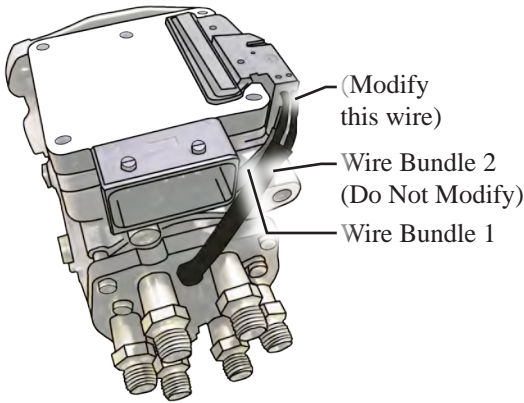

17. Locate the TOP injection pump wire. **NOTE: This will be the wire on the top, closest to the engine block.**

18. Unscrew the Posi-Tap®. Place the wire in the slot cap's slot.

19. Place a single drop of RTV Silicone Sealer into the cap. The sealer provides a water tight seal in and around the connection.

20. Pre-twist the body of the Posi-Tap® counter clockwise with about seven full turns before twisting on to cap.

NOTE: This will pre-load the wire so that when the body of the Posi-Tap® is installed on the cap, the wire will not remain twisted in the wire harness.

21. Twist harness onto cap until tight.

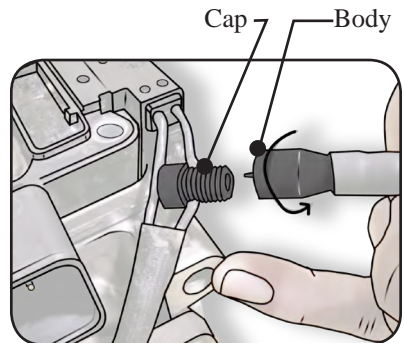

22. Remove the nut on the NEGATIVE battery terminal/ cable.

23. Slide the ring terminal onto the bolt, then replace the nut. This will tightly hold the ring terminal in place.

24. Tighten the nut accordingly.



NOTE: On some vehicles, there is a solid line and cannot be replaced with a brass elbow.

25. Using the 5/16" socket, loosen the two clamps securing the air induction hose to the air filter housing and the turbo inlet.

26. Remove the hose and set it aside.

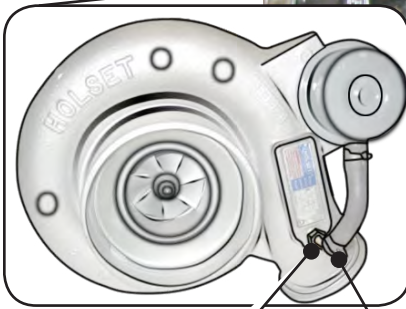
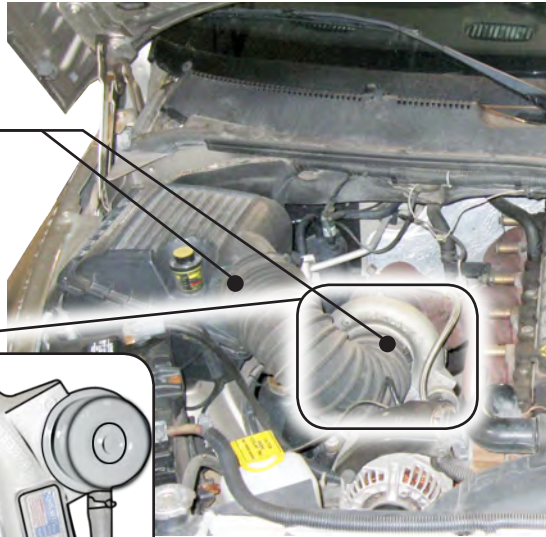

OEM brass fitting

Edge Supplied Elbow

Hose Clamp

Hose

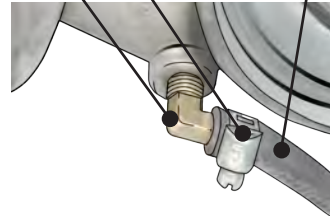

27. Using the pliers, remove the crimp style clamp from the hose on the brass fitting located on the now exposed lower front side of the turbocharger.

28. Remove the hose from the brass fitting and dispose of the crimp style clamp.

29. Using the 7/16" wrench, unscrew the stock brass fitting.

30. Install the supplied brass fitting. Tighten while being careful not to over-tighten.

31. Slip the supplied hose clamp onto the stock hose then the stock hose onto the new brass fitting. Tighten the hose clamp with the 1/4" socket.

32. Re-connect the air induction hose to the air filter housing and turbocharger inlet.

33. Using the 5/16" socket, tighten both clamps securely.

CAUTION: If you lack experience or tools to bleed the fuel system take the truck to an experienced mechanic for installation of the fuel pressure sensor!

CAUTION: The fuel that is pumped to the injectors also acts as a lubricant for the Bosch VP-44 high pressure pump. A loss of fuel pressure to the high pressure pump may result in permanent damage to the high pressure pump.

NOTE: Fuel Filter Housing (Optional placement of Banjo bolt for 1999 Trucks only).

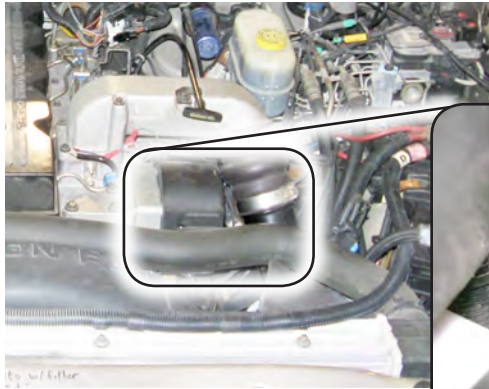

34. Locate the fuel pump.



35. Thread the fuel pressure sensor into the supplied banjo bolt.

Fuel Pressure Sensor



Edge Banjo Bolt

36. Remove the stock banjo bolt from the injector pump supply line located on the VP44 with the pre-installed neoprene washer and fuel pressure sensor.

37. Tighten bolt to the appropriate torque specifications (18 ft-lbs)

VP44 Fuel Pump Method

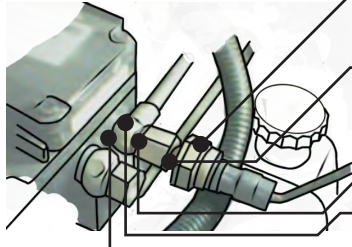

Fuel Supply Line

Fuel Filter Method
(1999 Only)

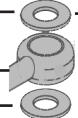
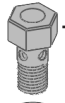
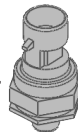

CAUTION: *When the Fuel Supply Line is removed, fuel can drain out of the VP 44 pump, and air can enter the line and/or pump. In order to minimize the amount of air that is let into the fuel system, pre-install the fuel pressure sensor onto the supplied banjo bolt before removing the stock banjo bolt from the pump. Tighten the sensor into the banjo bolt until it is snug.*

CAUTION: *IT IS CRITICAL THAT THE AIR INTRODUCED INTO THE FUEL LINE BE REMOVED FOR THE FUEL SYSTEM TO OPERATE PROPERLY.*

NOTE: *Use this bleeding procedure at the end of the installation. Trying to bleed the fuel system half way through the installation could cause a check engine light.*

38. In order to remove the air from the system, loosen BUT DO NOT REMOVE the overflow valve banjo fitting that connects to the return line.

39. Place a shop rag or towel around the banjo fitting to catch excess fuel.

40. Turn the ignition key to CRANK position and quickly release the key to the ON position.

CAUTION: *DO NOT START THE ENGINE! The fuel lift pump will operate for up to 25 seconds.*

41. Once this procedure is complete, tighten the return line banjo fitting and torque to 24 Nm (18 ft-lbs).

42. Attempt to start the engine.

NOTE: *The engine may be very noisy or run erratic for a few minutes. Keep an eye on the fuel pressure as displayed on the Attitude. If the pressure drops below 4 psi, or the engine quits running, re-bleed the fuel system. If the engine still does not start, remove and check the fuel filter. If the filter is dirty or damaged, replace the filter.*

CAUTION:

•Do not engage the starter motor for more than 30 seconds – Allow two minutes between cranking intervals.

•Although it is rare, on occasions the LIFT pump may fail to prime after the banjo bolt has been replaced signifying a possibility of a worn pump. In this rare instance the LIFT pump should be replaced.

43. Reinstall the throttle bracket onto the fuel injection pump using the three bolts. Torque these bolt to 18 ft-lbs using a torque wrench and 13mm socket.

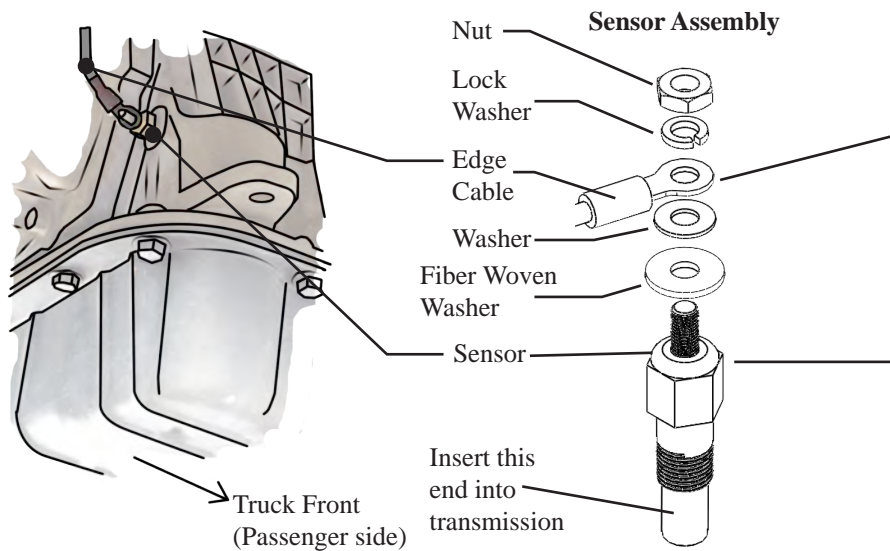

44. Unbolt the stock plug from the rear passenger side of the transmission using a 7/16 inch (11mm) wrench.

NOTE: A small amount of transmission fluid will leak from the outlet.

45. Apply Teflon tape to the threads of the transmission temperature sensor.

46. Using a ½ inch wrench, thread the Edge supplied transmission oil temp sensor (shown above) and connect the cable using the supplied nut.

47. From the top of the engine, route the edge cable along the factory wiring harness and over the top of the transmission and secure with supplied wire ties.

NOTE: ONCE YOUR TRANSMISSION SENSOR IS IN PLACE, REFER TO THE “EGT PROBE INSTALLATION” SECTION TO CONTINUE.

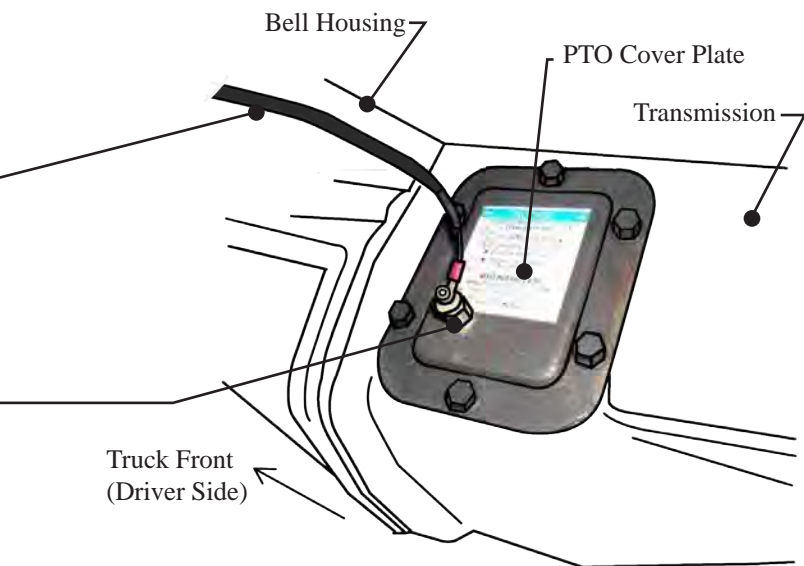

NOTE: When the Power Take-Off (PTO) plate is removed ALL of the gear lube from the transmission will drain out – Ensure that you have the CORRECT replacement oil prior to removing the PTO plate. See the Dodge service manual for replacement gear lube type.

48. Using a 14 mm wrench, remove the lowest bolt on the PTO cover plate and drain the transmission fluid.
49. Unbolt the remaining five bolts to the PTO cover plate and remove it completely.
50. Using a 5/16" or 21/64" drill bit, drill a hole in the PTO cover plate in the location shown above.
51. Using a 1/8" NPT tap, thread the hole in the PTO cover plate.
52. Apply Teflon tape or pipe thread sealant to the sensor threads and screw it into the PTO cover plate.
53. Clean the surface of the PTO cover plate and transmission . The plate will need to be resealed. Apply an automotive gasket silicone to the clean plate and install.
54. Connect the edge cable to the sensor using the supplied hardware.
55. Refill the transmission with fluid according to OEM specifications.

Juice Installation 2003-2004 5.9L (CR)

Supplied Items

Note: Depending on your year of truck, you may not need everything provided.

① Quick Install Guide - 1 each



⑤ Zip Ties - 10 Each

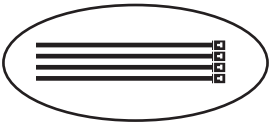

② EGT Probe - 1 Each

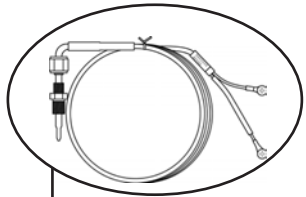

EGT Probe Location

Battery

Exhaust Manifold

Turbo

③ Brass Elbow - 1 Each



④ Hose Clamp - 1 each

⑥ Juice Harness - 1 Each

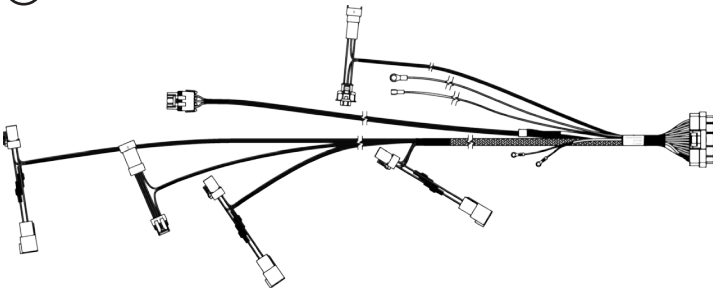

⑦ Juice Module 1 Each

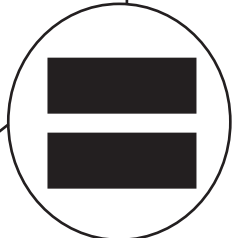
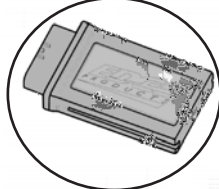

⑧ Velcro Strips 2 each

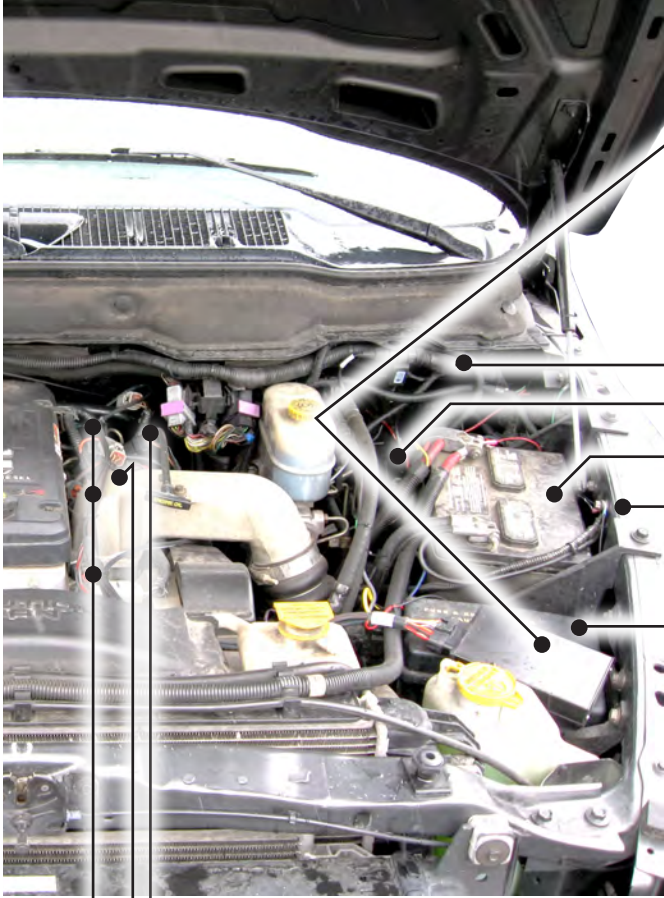

- EAS Install Location
- Fire wall Grommets
- Battery
- Ground Connector Location

— Fuse Box

⑨ Fuse Link 1 each



- MAP Sensor
- Fuel Pressure Sensor
- Injectors

Required Tools

- 3/8" Drive Ratchet
- 10mm Socket
- 5/16" Socket
- 1/2" Wrench
- 7/16" Wrench

Harness Connection Guide

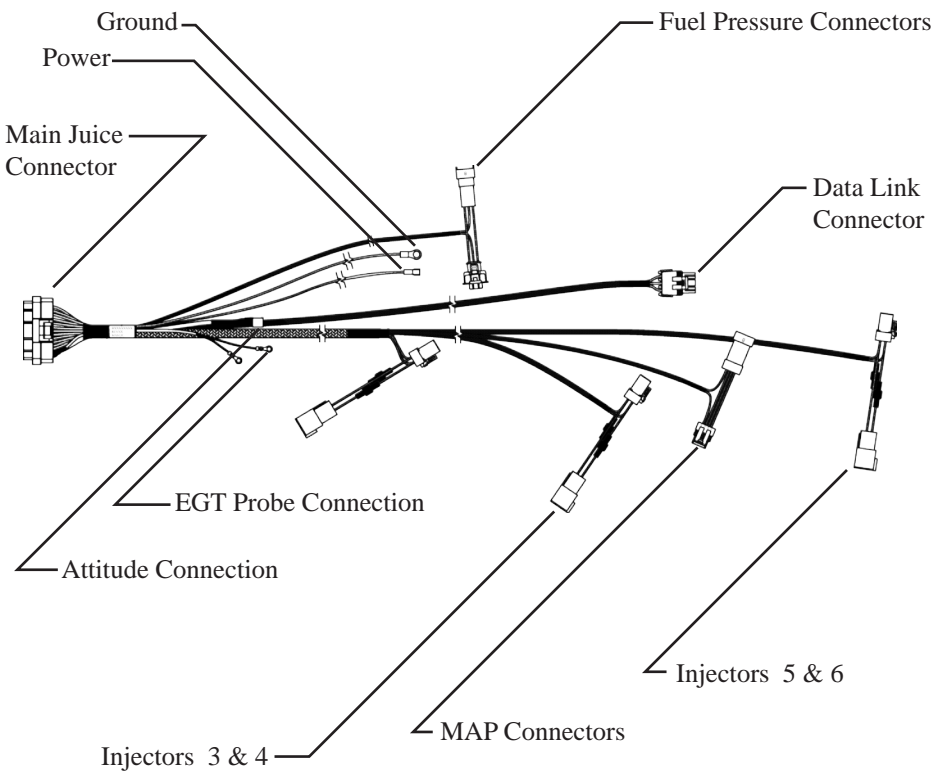

Installing the Juice Harness



1. Using the ½" wrench, loosen both negative battery cables.
2. Remove cables from the battery posts and set aside.

NOTE: DO NOT reconnect until installation is complete. Connecting power may cause fault code in the ECM.

3. Locate and remove Fuse 50 (10 Amp) from inside the engine compartment fuse panel.
4. Insert the Leaded Fuse Link. The leg with the wire soldered to it needs to plug into the "HOT" side of the fuse location. Orient the fuse exactly as shown below.
5. From the main harness, connect the Red Power Connector to the installed Fuse Link.

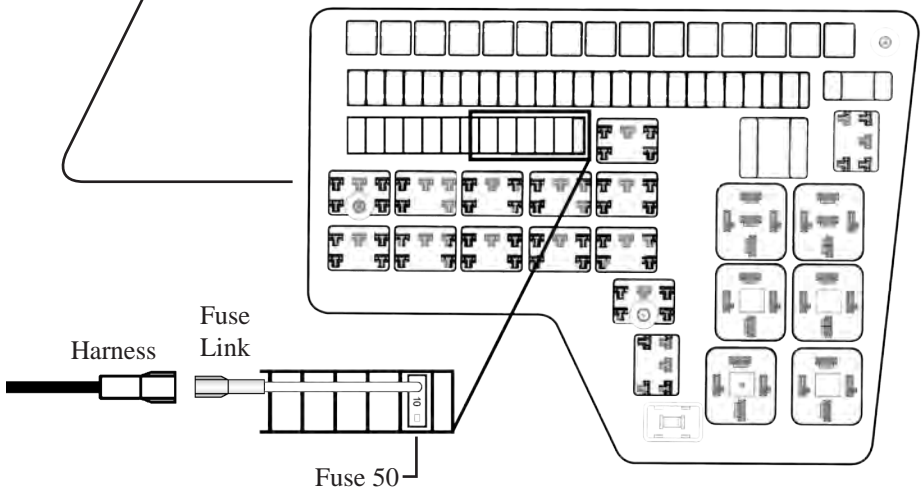

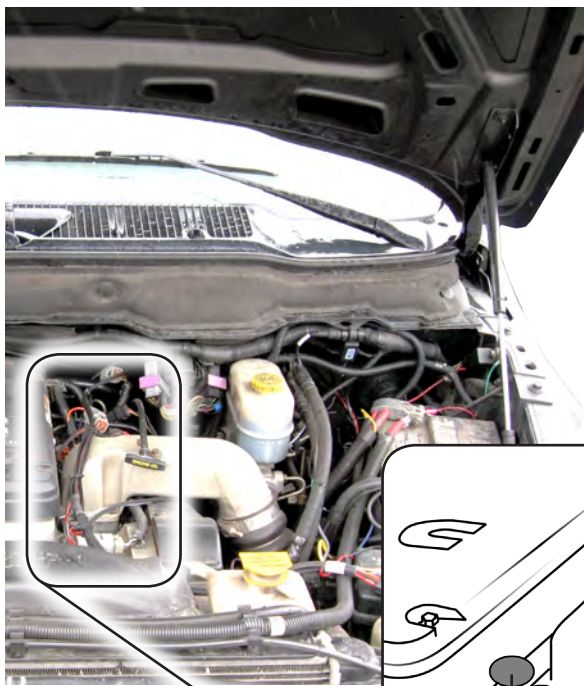

CAUTION: Do not force the connection. If the connectors do not easily go together, inspect the pins, and retry installation.

6. Disconnect all 3 stock injector connectors by squeezing the tab on the top of each connector.

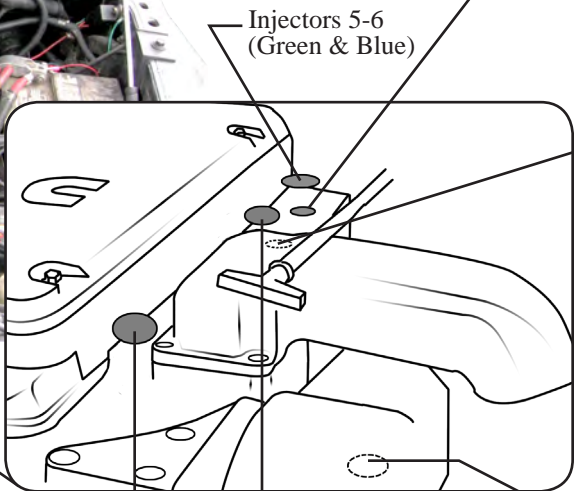

Injectors 1-2
(Red & Brown)

Injectors 3-4
(Orange & Tan)

7. Insert the Edge Injector Connectors between the stock connectors, and lock in place.

NOTE: Match Edge Harness connectors to the proper injector set according to the wire colors described above.

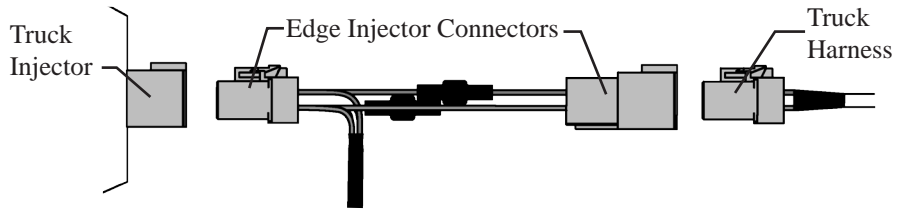

8. Locate the MAP connector.

9. Remove the vehicle MAP sensor connector and connect the Edge Harness MAP connectors in between the vehicle harness and the sensor itself.

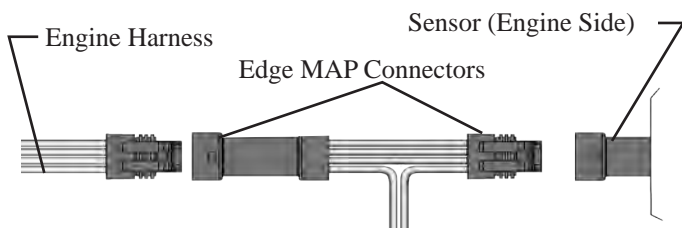

10. Locate the Fuel Pressure sensor connector.

11. Remove vehicle Fuel Pressure Sensor connector and connect the Edge Harness Fuel pressure sensor connector "T" in between the vehicle harness and the sensor itself.

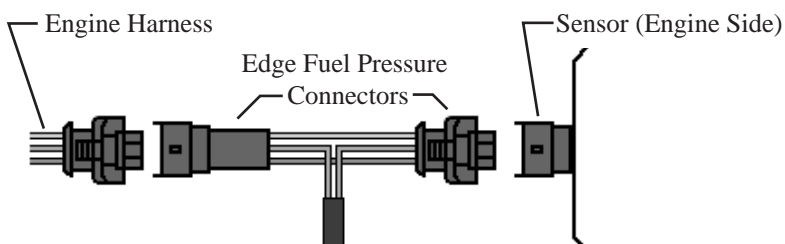

12. Locate the vehicle Data Link connector. (Towards bottom of Engine)

13. Unplug the existing Data Link connector and re-connect using the Edge Harness Data Link connector.

NOTE: The data link may come from the factory with a dummy plug in it. If so, remove the dummy plug, and connect the Edge data link connector into the socket. Save the dummy plug for use if the Juice must be removed for vehicle service.

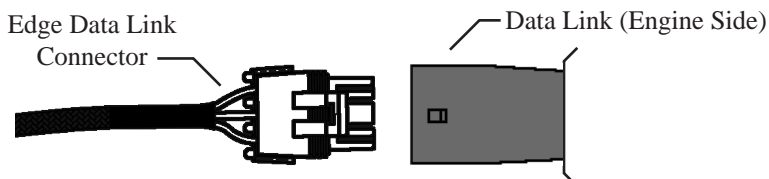

NOTE: On some vehicles, there is a solid line and cannot be replaced with a brass elbow.

14. Using the 5/16" socket, loosen the two clamps securing the air induction hose to the air filter housing and the turbo inlet.

15. Remove the hose and set it aside.

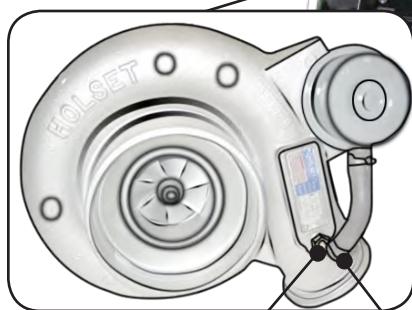

OEM brass fitting

16. Using the pliers, remove the crimp style clamp from the hose on the brass fitting located on the now exposed lower front side of the turbocharger.

17. Remove the hose from the brass fitting and dispose of the crimp style clamp.

18. Using the 7/16" wrench, unscrew the stock brass fitting.

19. Install the supplied brass fitting. Tighten while being careful not to over-tighten.

20. Slip the supplied hose clamp onto the stock hose then the stock hose onto the new brass fitting. Tighten the hose clamp with the 1/4" socket.

21. Re-connect the air induction hose to the air filter housing and turbocharger inlet.

22. Using the 5/16" socket, tighten both clamps securely.

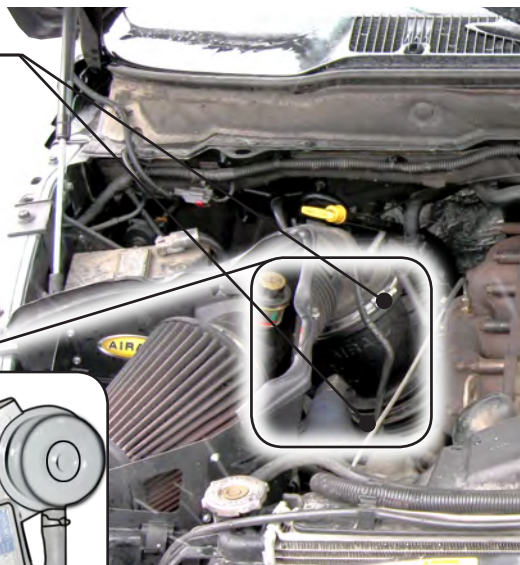

Edge Supplied Elbow

Hose Clamp

Hose

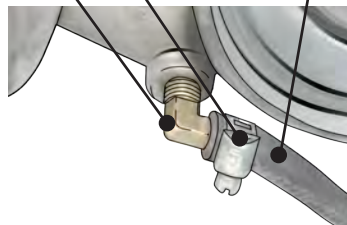

1. Remove the 10mm bolt from the driver side fender. (above the battery)

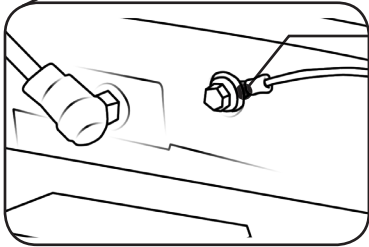
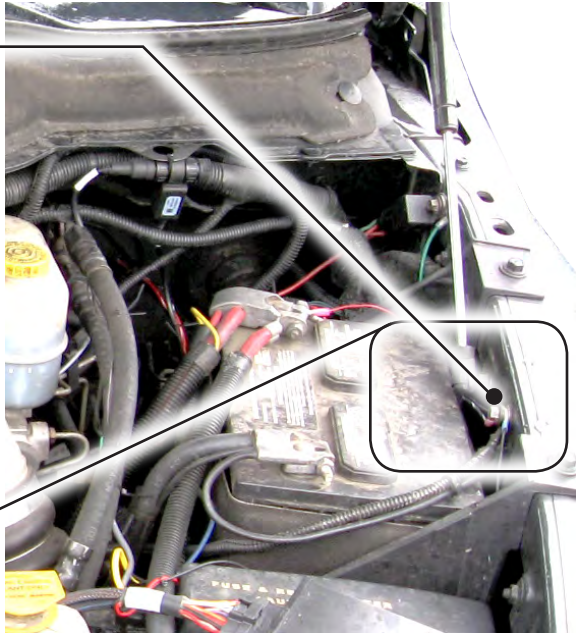

2. Add the black ground connector with the round terminal to the wire bundle already being fastened by the bolt.

3. Tighten the bolt.

NOTE: YOUR JUICE MODULE INSTALLATION IS NOT COMPLETE. REFER TO THE "EGT PROBE INSTALLATION" SECTION TO CONTINUE.

Juice Installation 2004-5-2005 5.9L (600)

Supplied Items

Note: Depending on your year of truck, you may not need everything provided.

① Quick Install Guide - 1 each



③ Zip Ties - 10 Each



② EGT Probe - 1 Each

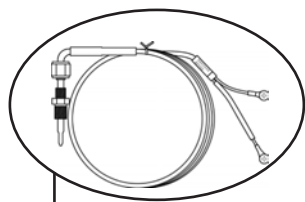

→ EGT Probe Location

Battery

Exhaust Manifold



④ Juice Harness - 1 Each

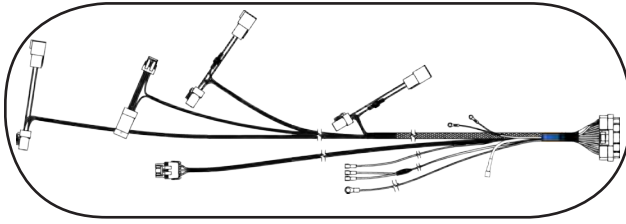

⑤ Juice Module 1 Each

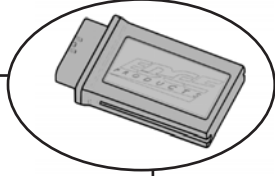

⑥ Velcro Strips 2 each

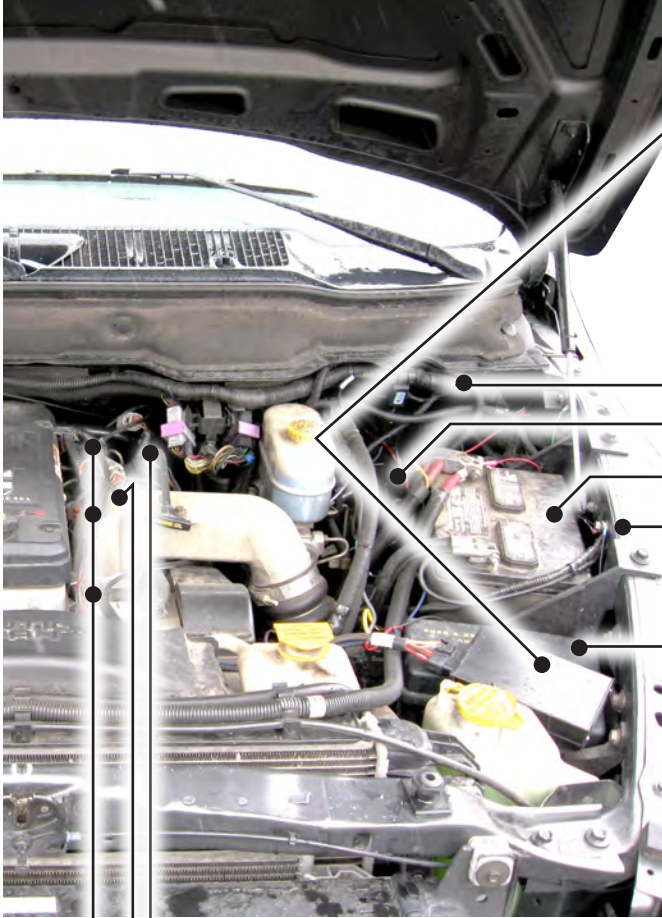
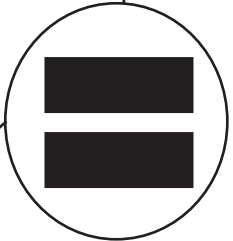

EAS Install Location

Fire wall Grommets

Battery

Ground Connector Location

Fuse Box

⑦ Fuse Link 3 each

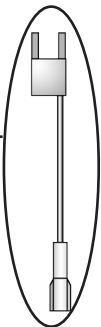

MAP Sensor

Fuel Pressure Sensor

Injectors

Required Tools

- 3/8" Drive Ratchet
- 10mm Socket
- 5/16" Socket
- 1/2" Wrench
- 7/16" Wrench

Harness Connection Guide

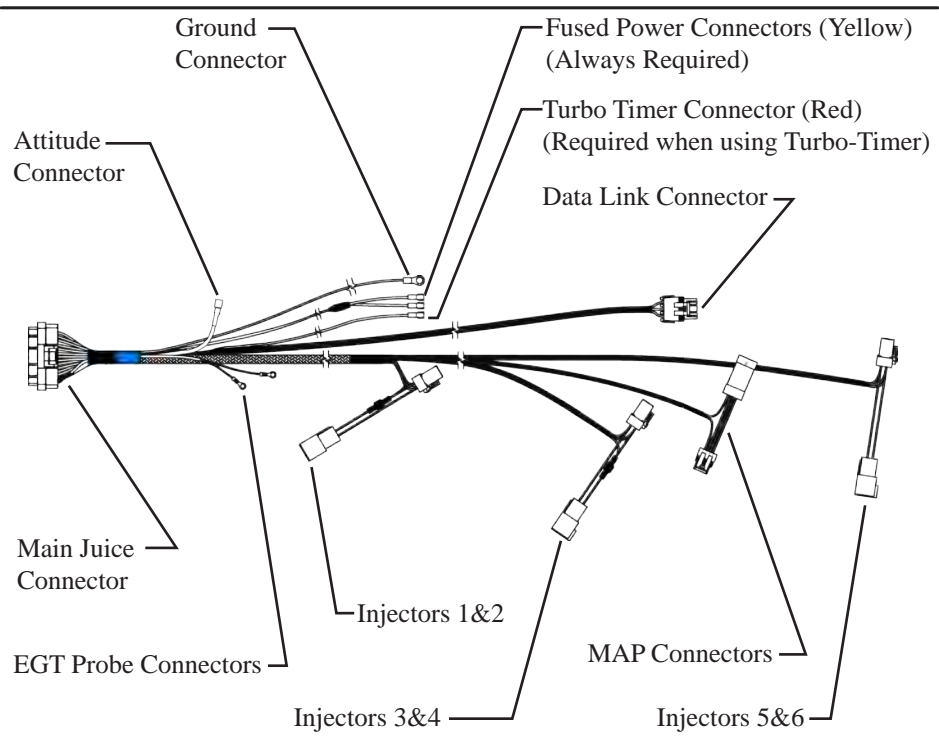

Turbo Timer (Optional)

1. Locate and remove Fuse 16 (10 Amp) from inside the engine compartment fuse panel.
2. Insert the Ledged Fuse Link. The leg with the wire soldered to it needs to plug into the "HOT" side of the fuse location. Orient the fuse exactly as shown.
3. From the main harness, connect the Red Turbo Timer Connector to the installed Fuse Link.

Installing the Juice Harness



1. Using the ½" wrench, loosen both negative battery cables.

2. Remove cables from the battery posts and set aside.

NOTE: DO NOT reconnect until installation is complete. Connecting power may cause fault code in the ECM.

3. Locate and remove Fuses 28 and 35 (10 Amp) from inside the engine compartment fuse panel.

4. Insert the Leaded Fuse Link. The leg with the wire soldered to it needs to plug into the "HOT" side of the fuse location. Orient the fuse as shown below.

5. From the main harness, connect the yellow Power Connectors to the installed Fuse Links.

NOTE: DO NOT reconnect battery until installation is complete. Connecting power may cause fault code in the ECM.

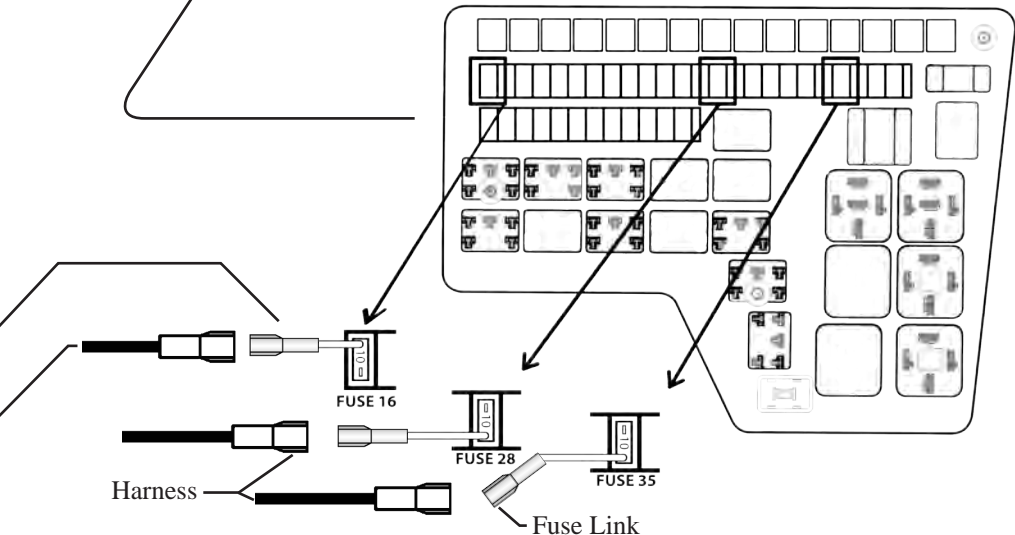

CAUTION: Do not force the connection. If the connectors do not easily go together, inspect the pins, and retry installation.

6. Disconnect all 3 stock injector connectors by squeezing the tab on the top of each connector.

Injectors 5-6
(Green & Blue)

Injectors 1-2
(Red & Brown)

Injectors 3-4
(Orange & Tan)

7. Insert the Edge Injector Connectors between the stock connectors, and lock in place.

NOTE: Match Edge Harness connectors to the proper injector set according to the wire colors described above.

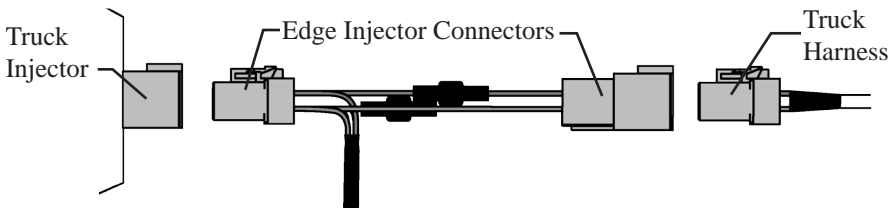

8. Locate the MAP connector.

9. Remove the vehicle MAP sensor connector and connect the Edge Harness MAP connectors in between the vehicle harness and the sensor itself.

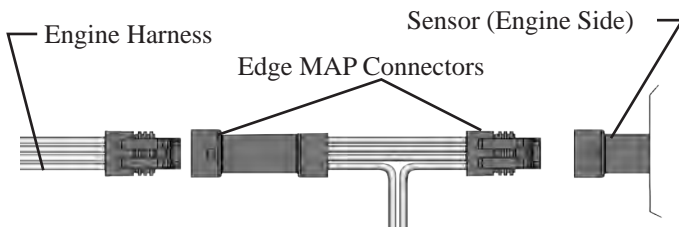

10. Locate the vehicle Data Link connector. (Towards bottom of Engine)

11. Unplug the existing Data Link connector and re-connect using the Edge Harness Data Link connector.

NOTE: The data link may come from the factory with a dummy plug in it. If so, remove the dummy plug, and connect the Edge data link connector into the socket. Save the dummy plug for use if the Juice must be removed for vehicle service.

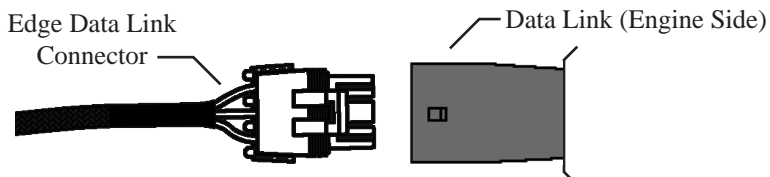

12. Remove the 10mm bolt from the driver side fender. (above the battery)

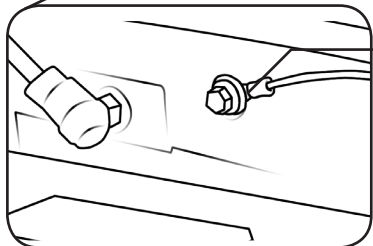

13. Add the black ground connector with the round terminal to the wire bundle already being fastened by the bolt.

14. Tighten the bolt.

NOTE: YOUR JUICE MODULE INSTALLATION IS NOT COMPLETE. REFER TO THE "EGT PROBE INSTALLATION" SECTION TO CONTINUE.

Juice Installation 2006-2015 5.9L & 6.7L

Supplied Items

Note: Depending on your year of truck, you may not need everything provided.

① Quick Install Guide - 1 each



③ Zip Ties - 10 Each

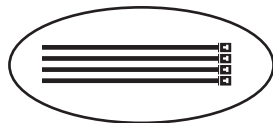

② EGT Probe - 1 Each

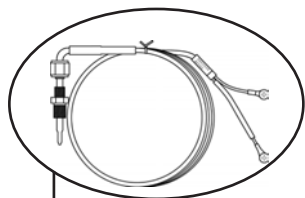

Exhaust Manifold

Battery

Turbo



⑨ DATA/OBDII Cable
1 each

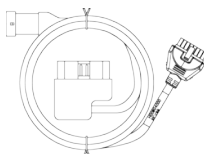

④ Juice Harness - 1 Each

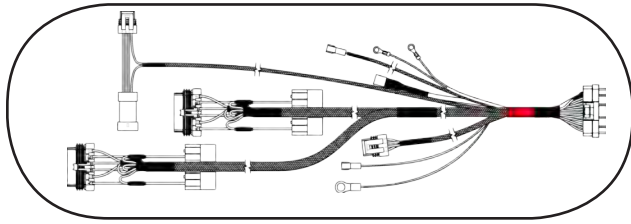

⑤ Juice Module 1 Each

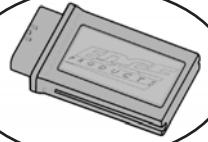

⑥ Velcro Strips 2 each



EAS Install Location

Battery

Ground Connector

Fire wall Grommets

Fuse Box

⑦ Fuse Link 3 each

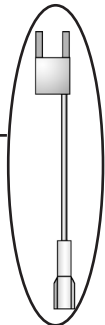

⑧ Turbo Timer Adapters 1 each

2006-2009



Or

2010-2012



Sensor Locations

Injector Locations

Required Tools

- 3/8" Drive Ratchet
- 10mm Socket
- 1/2" Socket

Harness Connection Guide

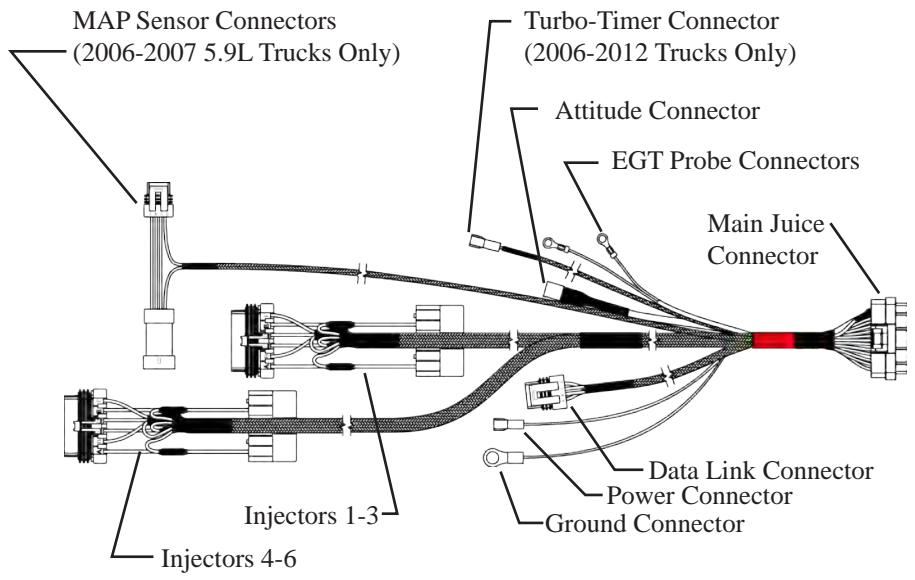

Installing the Juice Harness

1. Using the 1/2" wrench, loosen both negative battery cables.
2. Remove cables from the battery posts and set aside.

NOTE: DO NOT reconnect until installation is complete. Connecting power may cause fault code in the ECM.

3. Locate and remove Fuses from inside the engine compartment fuse panel.



4. Insert the Leaded Fuse Link. The leg with the wire soldered to it needs to plug into the "HOT" side of the fuse location. Orient the fuse as shown.

5. From the main harness, connect the Red Power Connectors to the installed Fuse Links.



2006-2009

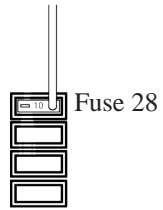
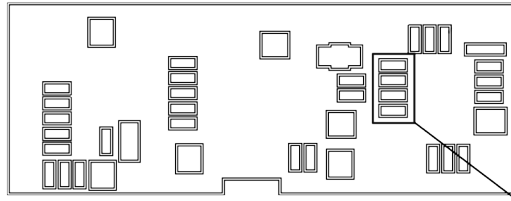

2010

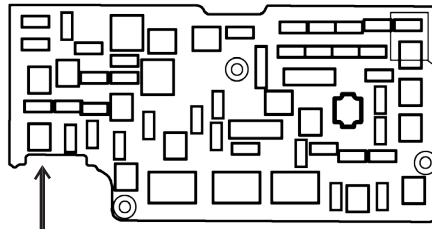

Use Rubber Seal for wire exit

2011-2012

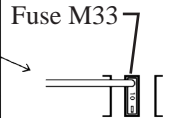
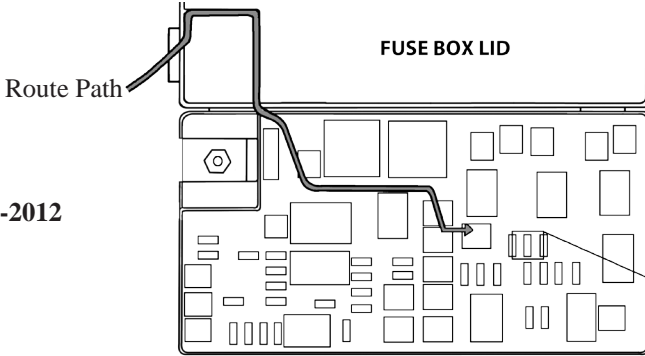

NOTE: For 2011-2012 trucks, route the wire along lid feature as shown. This will reduce the chance of the wire being crushed when the lid is closed.

2013-2015

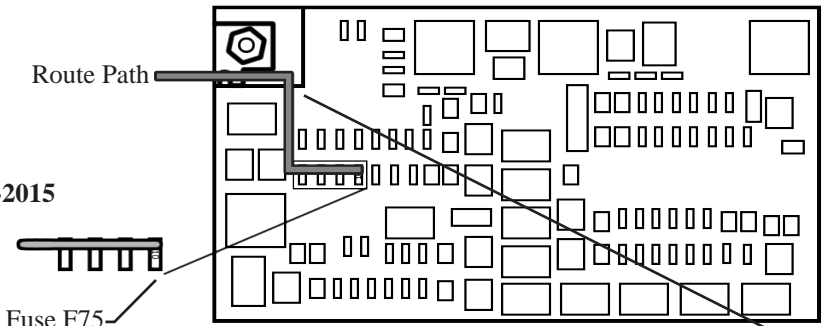

NOTE: Lightly trim the plastic to allow the wire to exit. When the lid is closed, the wire should not interfere.

CAUTION: Do not force the connection. If the connectors do not easily go together, inspect the pins, and retry installation.

6. Locate the two stock injector connectors.

7. Remove vehicle Injector Connectors and connect the Edge Harness Injector connector "T" in between the vehicle harness and the sensor itself.

NOTE: Injector Connectors with injectors 1, 2, & 3 has Orange/White, Red/White and Brown/White wires and a shorter cable length. The connector for injectors 4, 5, & 6 has Blue/White, Green/White, and Tan/White wires and a longer cable length.

Injectors (1-3)
(Org/wht, red/wht, brn/wht)

Injectors (4-6)
(blu/wht, grn/wht, tan/wht)

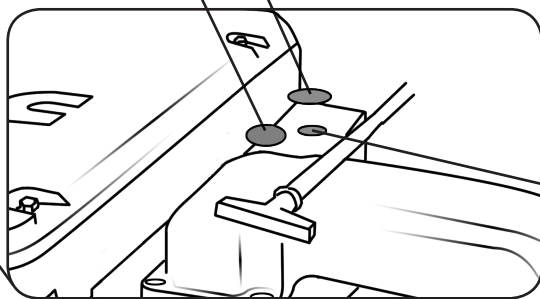

Injector
(Engine Side)

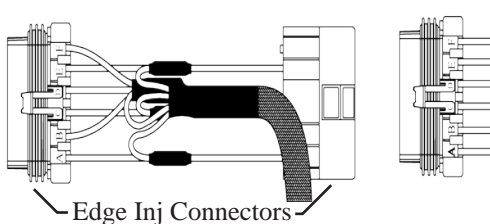

Engine
Harness

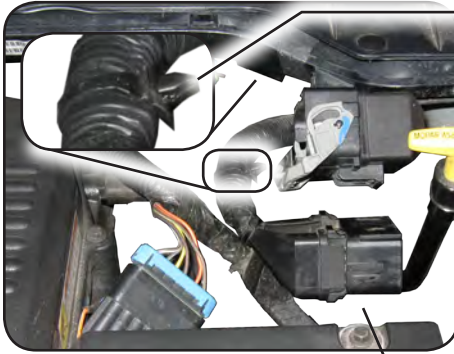

8. Pull the large engine harness away from the fire wall by carefully releasing the cable retention tab out of its mount.

9. Next, press in the connector lock using your right thumb, then disengage the lever by rotating it in the direction shown.

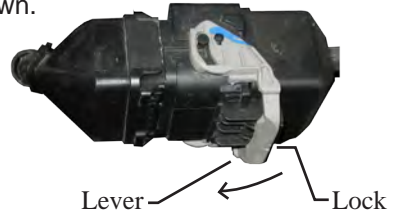

10. Remove the connector and set aside.



11. Lift the foam insulation in the direction shown to fully expose the injector connectors.

12. Unplug each injector set and install the edge harness according to the previous page.

13. Reconnect all connections, and continue the install by referring to the next section.

14. Locate MAP connector.

15. Remove vehicle MAP sensor connector and connect the Edge Harness MAP connector "T" in between the vehicle harness and the sensor itself.

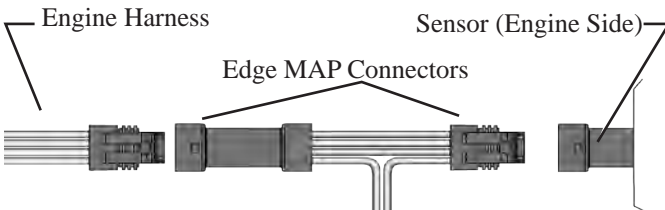

16. Locate the provided Turbo Timer cable. (not applicable to 2013-15 trucks)

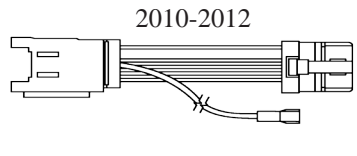
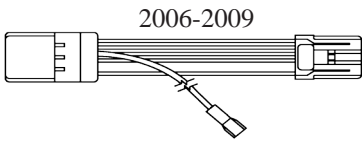

NOTE: There may be 2 different Turbo Timer adapters included in your kit. Once you have determined the connector is correctly installed, you may discard the remaining adapter as you will not need it.

17. Remove the panel under the steering column.

18. Locate the key position connectors. **The 2006-2009 are up and inside the steering column. The 2010-2012 are behind the key/ignition.**

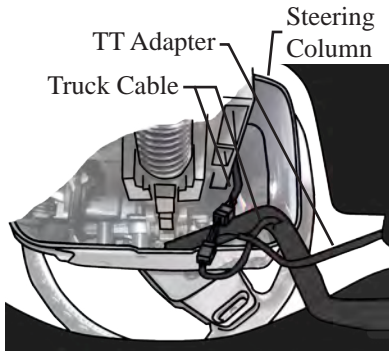

Looking up from brake pedal (2006-2009)

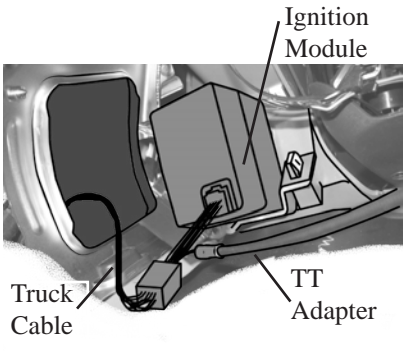

Looking up from brake pedal (2010-2012)

19. Connect the Turbo Timer (TT) adapter in between the truck connectors.

20. Route the Turbo Timer (Main Harness) connector through the fire wall.

21. Connect the Turbo Timer connector into the Turbo Timer adapter.

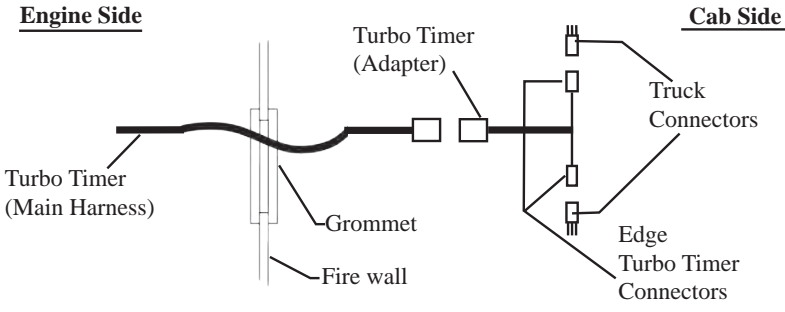

22. Locate the supplied "DATA/OBDII" cable.

23. Locate the vehicle's OBDII port. This connector is located below the steering wheel under the dash.

24. Plug the OBDII connector into the OBDII port.

25. Route the Data Link Connector out the rubber grommet and plug it into the Data Link connector located on the Main Edge Harness.

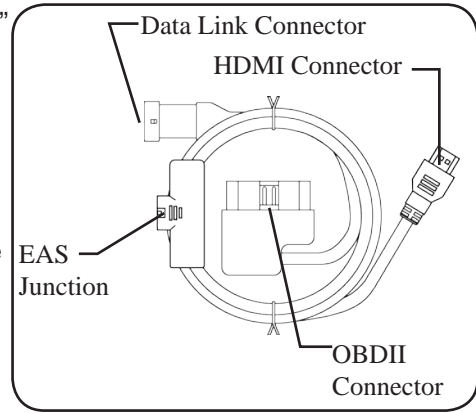

NOTE: The Attitude cable will later be routed and installed.

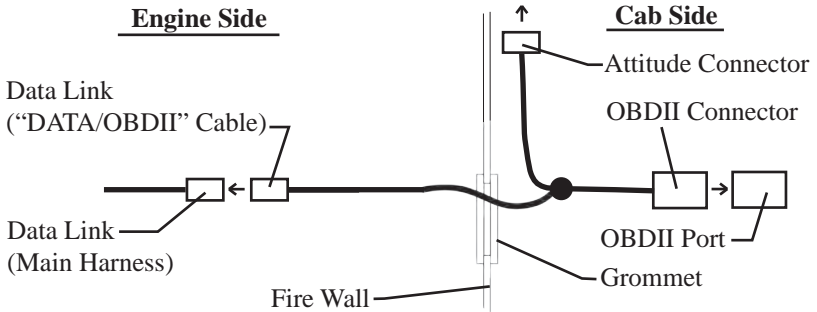

26. Remove the 10mm bolt from the driver side fender. (above the battery)

27. Add the black ground connector with the round terminal to the wire bundle already being fastened by the bolt.

28. Tighten the bolt.

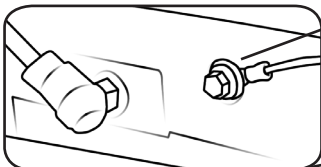
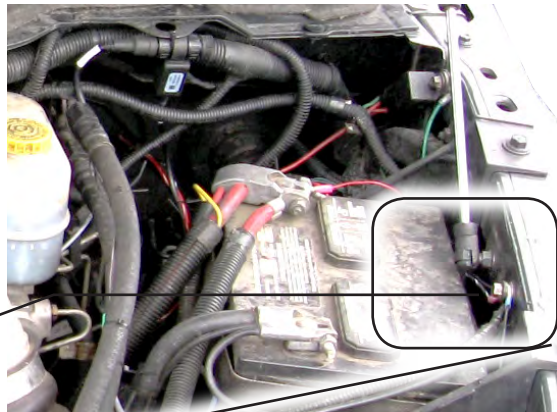

EGT Probe Installation

Supplied Items & Required Tools

WARNING When installing the EGT (Exhaust Gas Temperature) Thermocouple, wear eye protection and protective clothing to protect from getting metal chips in your eyes. Also, since exhaust manifolds can be very hot, allow the engine to cool before drilling. When working under the vehicle, make sure the park brake is set.

<u>Supplied Items</u>	<u>Qty</u>
① EGT Probe.....	(1)
② Shrink Tube.....	(2)

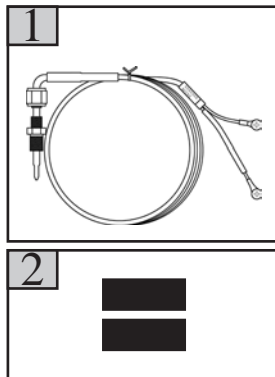

Required Tools

- Electric/Cordless Drill
- 1/8" drill bit or similar size (for pilot hole)
- 21/64" (best size) or 5/16" drill bit (for final hole)
- 9/16" wrench or socket
- 5/8" open end wrench
- 1/8"-27 NPT Thread Tap
- Phillips screwdriver
- 5/16" or 8mm wrench

CAUTION: One effective way to avoid metal fragment contamination in your engine manifold is to apply grease in the tip of the drill bit and threads of your tap tool when drilling/tapping the hole in your manifold. Reduce pressure on the drill when the drill breaks through the manifold wall to reduce risk of pushing metal chips into the manifold.

EGT Probe Installation Locations

NOTE: All 3 views are looking from the passenger side.

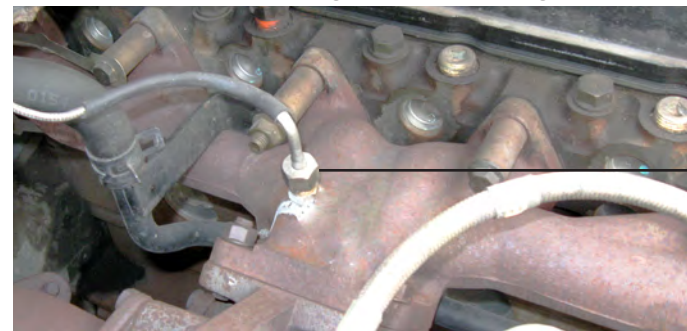

1998.5 - 2002

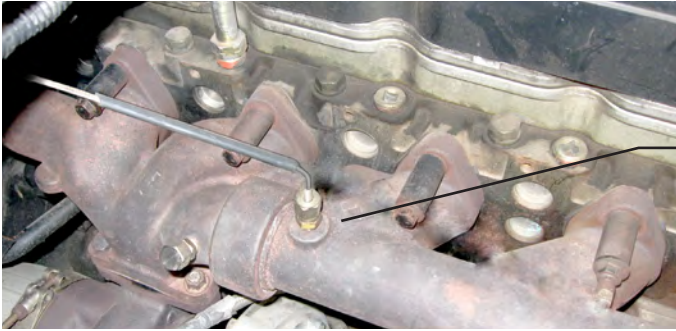

2003-2007



2007.5-2015

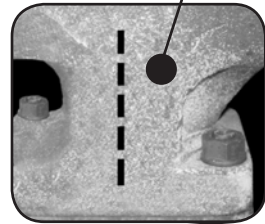

NOTE: Drill the hole to the right of the dashed line shown. The dash depicts an internal wall feature that should be avoided.

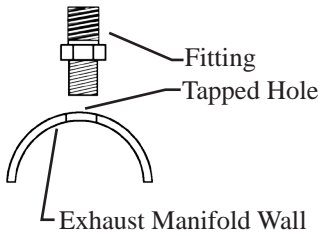

1. Obtain a 1/8"-27 NPT Thread Tap.

2. Drill a 21/64" (5/16" optional) hole through the manifold wall.

3. Use the pipe tap to cut the threads in accordance to the pipe tap manufacturer's instructions and recommendations.

4. Remove the fitting from the Thermocouple and install by tightening the tapered thread end into the manifold.

5. Tighten the fitting so that it is securely seated.

6. Install the probe into the fitting, and tighten the top nut of the fitting just tight enough to keep the probe firmly mounted.

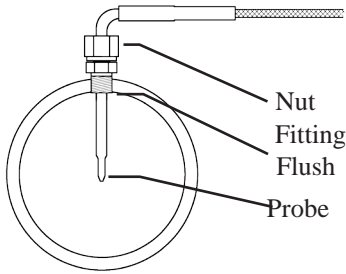

NOTE: Ideally the tip of the fitting would be less than or flush with the inside of the exhaust flow path.

7. Make sure that the probe cable is positioned to allow best path and minimal bending for routing to the fire wall.

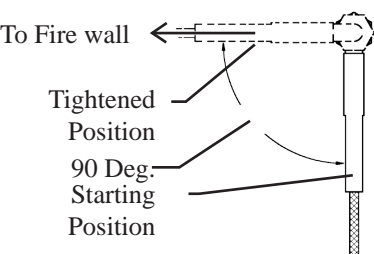

NOTE: The probe will move approximately 90 Deg. clockwise in the direction the nut is tightened. Before fully tightening the nut, make sure the cable starts 90 Degrees from the final resting position. When tightened, the cable will be correctly positioned.

CAUTION: Do not bend the probe after installed. If needed, loosen the probe nut, adjust the probe, and re-tighten. Bending the probe tubing will result in a faulty probe.

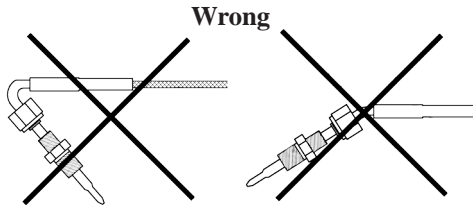
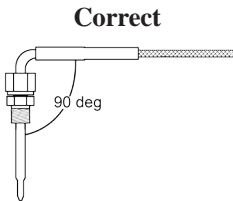

8. Slide the shrink tube pieces over the two wires. Later you will slide them over the bolted connections.

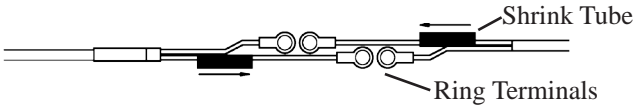

9. Connect the (2) ring terminals to the mating Juice harness terminals using the supplied hardware. Yellow to Yellow. Red to Red.

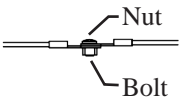

10. Tighten the nuts so that each wire is in line with its mating wire.

11. Position the supplied shrink tube over the secure fasteners.

12. Center the connection within the shrink tube. Heat and shrink the tubing over the connections.



13. Secure the excess cable to the existing engine wire harnesses with supplied zip ties.

JAB Installation

1998.5-2015 Trucks

NOTE: The Attitude will not function unless the JAB is properly installed and plugged into both the Juice Module and Attitude Monitor.

1. Locate the green connector on the Juice Harness and plug it into the Green connector on the JAB.
2. Under the hood, connect the 3 EAS components to one another. A "click" will be felt and heard indicating that the connectors are correctly fastened.

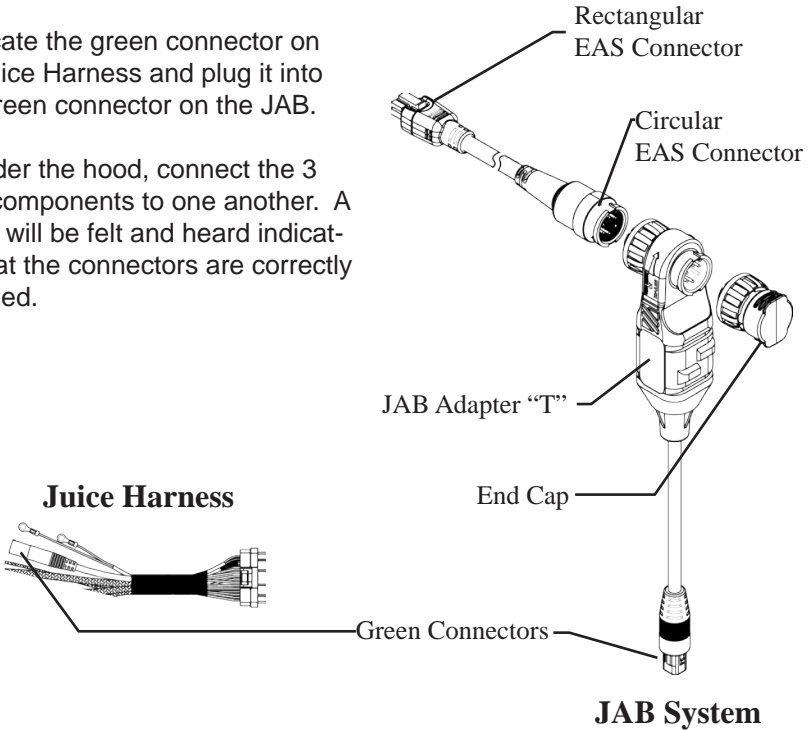

3. Route the Rectangular EAS Connector and cable through the fire wall grommet. The JAB and Juice Module will remain under the hood.

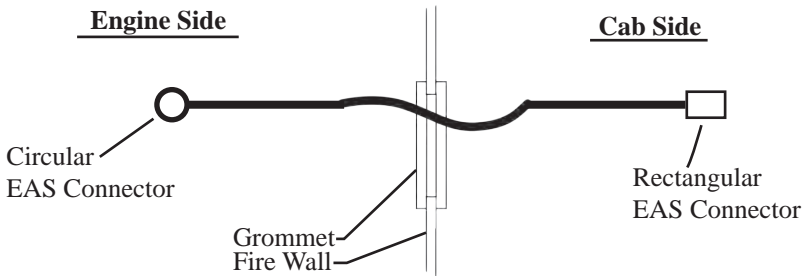

4. Route the cable from below the dash up to the HDMI cable's EAS Junction. Refer to the Quick Install Guide for instructions on how to route the HDMI Cable.

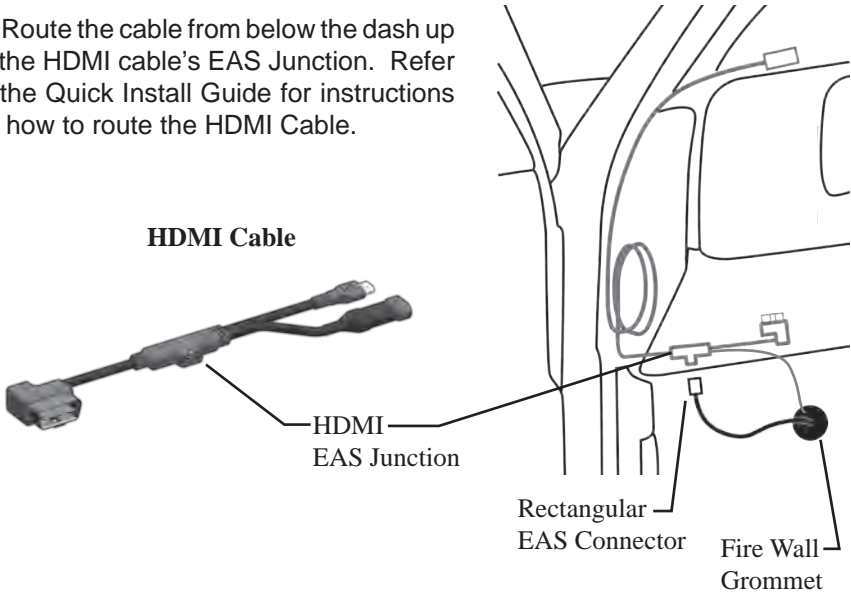

5. Using the supplied zip ties, fasten the JAB connectors underneath the overhang which runs across the top of the fire wall.
6. Keep the JAB assembly close to the driver side.

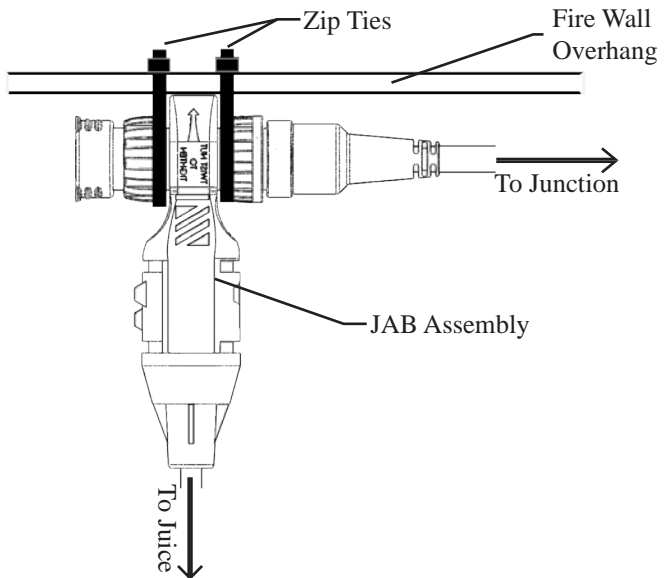

Final Installation

Connecting the Juice Module

1. Plug the “Main Juice Connector” into the “Juice Module” receptacle.

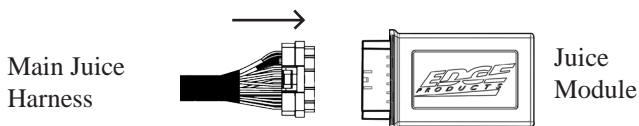

Mount and Secure the Juice Module

1. Attach one side of each Velcro strip to the back side of the Module and to the top side of a flat surface under the hood.

NOTE: The best place is the top of the fuse box on the driver side. This will secure the Juice module and help keep it away from any moving or hot components under the hood.

Final Check

1. Recheck all connections for a properly secure installation.
 2. Using the supplied wire ties, secure the wiring harness and cable to prevent possible heat damage from hot engine surfaces.
 3. Reconnect the battery cables.
 4. Start the engine. The engine should start and idle like a stock truck. If the engine does not start or run properly, turn off the engine. Remove the keys from the ignition, and check the Juice module connections. Make sure all connectors are fastened tightly.
-

Appendix

Operating the Attitude Module

Refer to the Attitude User Manual for detailed descriptions on how to operate the Attitude Monitor.

Additional Information

EGT's

EGT stands for exhaust gas temperature, and is the single most important indicator of how a diesel engine is performing. Unlike a gasoline motor, a diesel motor will continue to make power as more fuel is added. As more fuel is added, the engine heat will also increase. Please be aware of the limitations of a stock engine.

ENGINE CODES

Engine codes are generally set during heavy acceleration. Although the codes will remain "set" in the PCM, the dash board indicator light should turn off within 15 minutes. Most codes that are set under hard acceleration are called "soft codes". These soft codes are retained in the PCM and can be erased by using the Attitude to clear the codes.

Codes that may be set:

- P1211 – Injector control pressure is different than expected
 - P1209 – Peak injection pressure fault
-