

JUICE

ATTITUDE



Chevy Juice

Installation Instructions

Getting Started

About the Juice

Congratulations on purchasing the Edge Juice/Attitude system for the Duramax Diesel®.

The Juice/Attitude system features an intelligent module (Juice) that acts as an add-on Engine Control Module (ECM) for the Duramax® Engine. This module is controlled and customized in the cab of your truck by the Attitude monitor/controller.

This system offers many cutting-edge, additional features not available with the factory setup. Since the Juice Module is an add-on ECM, it uses data from your truck's computer or engine control module (ECM), and then enhances the factory settings to optimize your truck's performance. This product offers a wide variety of amazing performance and safety features that can ensure you get the driving experience you desire without damaging your valuable truck.

Safety Terms

Throughout this User Guide (hereafter noted as User Manual or Manual) you will see important messages regarding your safety or the protection of your vehicle. These messages are designated by the words WARNING or CAUTION.



WARNING indicates a condition that may cause serious injury or death to you, your passengers or others nearby. Pay careful attention to these Warning messages, and always comply with them. They could save a life.

CAUTION indicates a condition that could cause damage to your vehicle. It is important to install and operate your EDGE product in conformance with instructions in this Manual. Caution alerts you to particularly important things that will keep your vehicle operating properly.

Product Registration

BENEFITS OF PRODUCT REGISTRATION

- Your Safety** - Registering your product allows us to know exactly which product you have and provide important product updates to you that improve the quality and/or safety of the product.
 - Enhanced Features** - Almost all Edge products are easily updated via the internet. We are constantly adding new features and improvements to our product that we know you will want to enjoy.
 - Confirmation of Ownership** - Provides a record in case of product loss, theft, or required warranty work. When you call us for support our team will already have much of the information they need to help you.
 - Improved Product Development** - Helps us better understand you (our customer) and design products that meet your needs.
 - Special Offers** - Allows us to inform you about special offers on accessories and/or new products that fit your vehicle and enhance your driving experience.
-

Important Notes

1. If you have used another tuner/programmer on your truck, you will need to program your truck back to stock before using the Attitude or Juice.

Failure to return to stock may result in PCM failure or engine damage.

2. Do not program your vehicle in remote location in case of vehicle failure.

3. All Edge modules and programmers are built to operate with OEM calibrations. When you take your vehicle to a service center they may, by your request or otherwise, update your vehicle's calibrations. It is important that you return your vehicle to stock before taking it in for service. Edge updates its products to work effectively with updated OEM calibrations. However, Edge is not always made aware of calibration changes made by the OEM. In the case of discontinued products, Edge cannot ensure that your unit will work effectively if you take your vehicle to a dealership and you are given, by your request or otherwise, a new calibration.

NOTE: This product will not work on E-Series Vans, as some of the connectors are different from the F-Series pickups for which this product was designed for.

Truck Orientation

The following view is a top view of the vehicle (looking down from above the vehicle). References in the text to “looking down”, means looking toward the ground. Looking up, means looking towards the sky from below the vehicle. Front, rear, left and right are as noted below. See Figure below.

Front of Truck

Driver side of truck—
Usually referred to as
the left side.

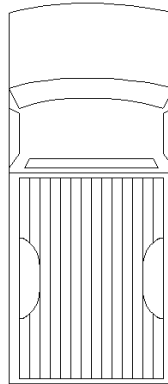

Passenger side of truck –
Usually referred to as the
right side.

Back of Truck

Juice Installation 2001-2005 6.6L (LB7 & LLY)

Supplied Items & Required Tools

- ① Main Harness
- ② Juice Module
- ③ Velcro Strips
- ④ Zip Ties
- ⑤ EGT Sensor Probe
- ⑥ Juice Attitude Bridge (JAB)
- ⑦ Quick Install Guide

- Electric/Cordless Drill
- 1/8" drill bit or similar size
- 21/64" or 5/16" drill bit
- 9/16" wrench or socket
- 5/8" open end wrench
- 1/8"-27 NPT Thread Tap
- Phillips screwdriver
- 5/16" or 8mm wrench

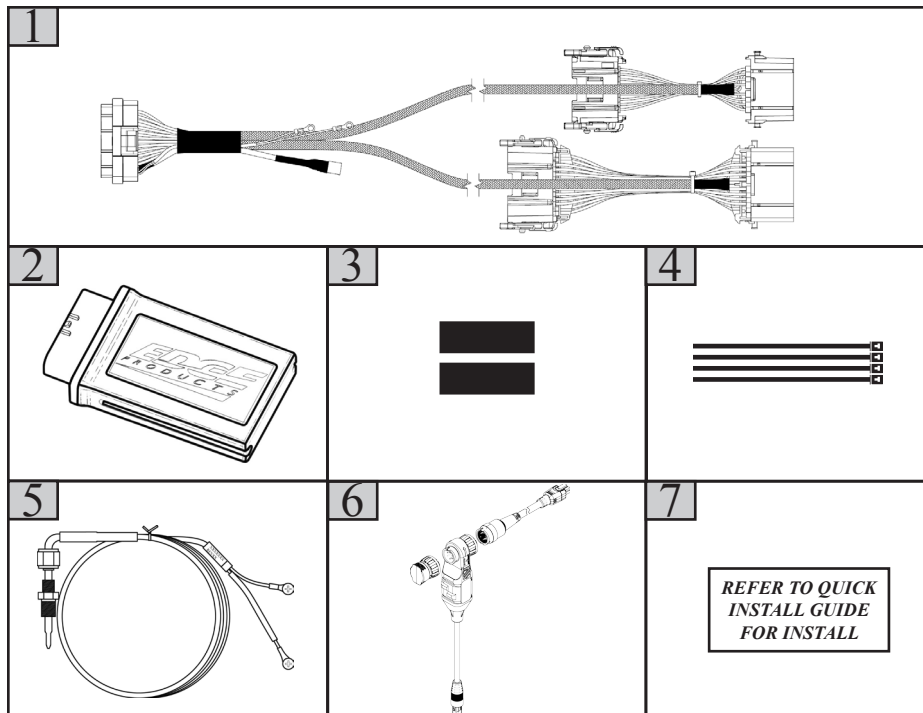

Note: Depending on your year of truck, you may not need everything provided.

Harness Connection Guide

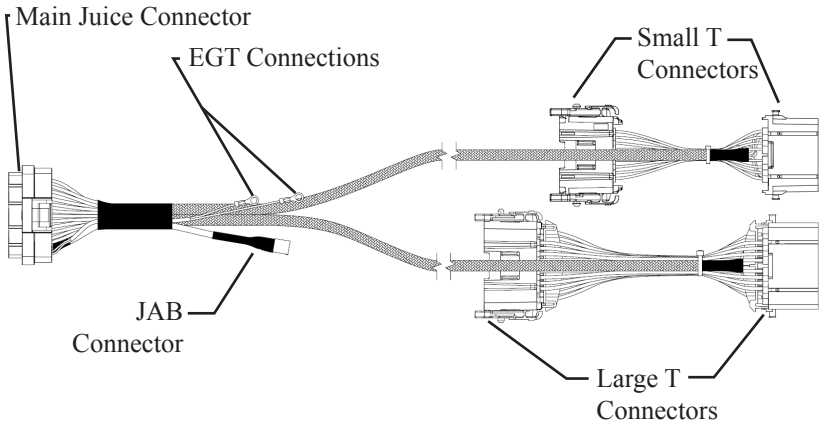

Installing the Juice Harness

1. Locate the engine harness connectors shown.
2. Disconnect both connectors by rotating the gray lever toward the passenger side.
3. Carefully insert each "T" connector between the stock engine harness connectors.
4. Carefully lock the connectors by rotating the gray levers.
5. Continue to the EGT Installation section.

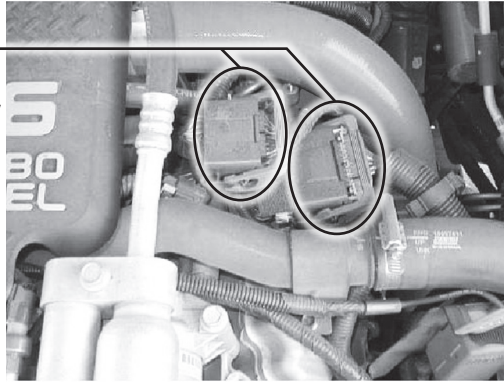

CAUTION: Be carefull not to damage any of the connector electrical contacts during install. If the connectors do no connect and/or lock together easily, there may be a contact that is out of alignment.

Juice Installation 2006-2007 6.6L (LLY & LBZ)

Supplied Items & Required Tools

- ① Main Harness
- ② Juice Module
- ③ Velcro Strips
- ④ Zip Ties
- ⑤ EGT Sensor Probe
- ⑥ Juice Attitude Bridge (JAB)
- ⑦ Fuse Link
- ⑧ Quick Install Guide

- Electric/Cordless Drill
- 1/8" drill bit or similar size
- 21/64" or 5/16" drill bit
- 9/16" wrench or socket
- 5/8" open end wrench
- 1/8"-27 NPT Thread Tap
- Phillips screwdriver
- 5/16" or 8mm wrench

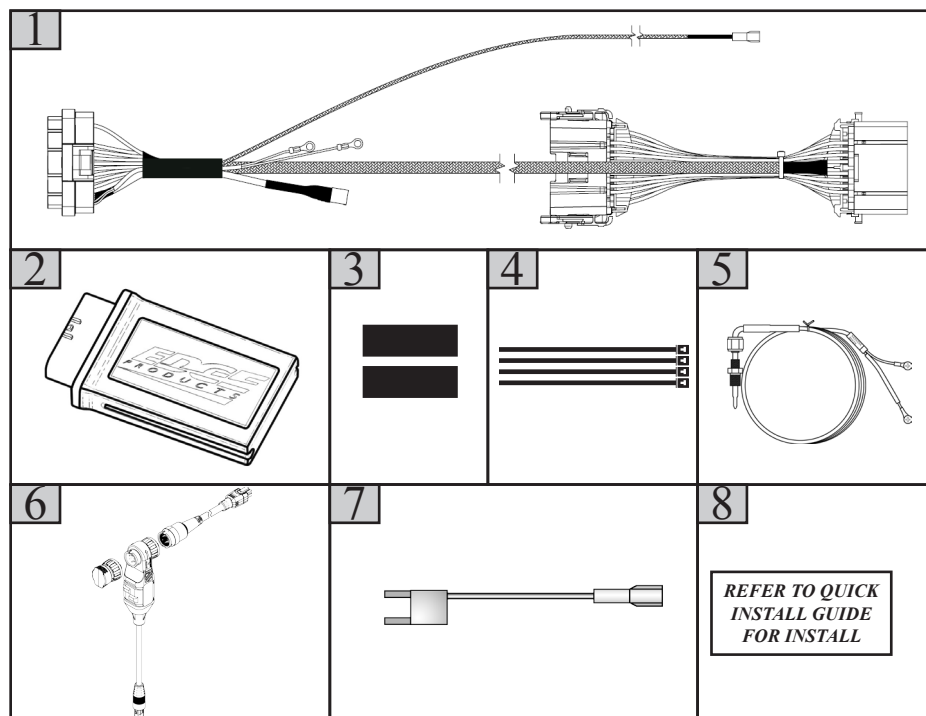

Note: Depending on your year of truck, you may not need everything provided.

CAUTION: Be careful not to damage any of the connector electrical contacts during install. If the connectors do not connect and/or lock together easily, there may be a contact that is out of alignment.

Harness Connection Guide

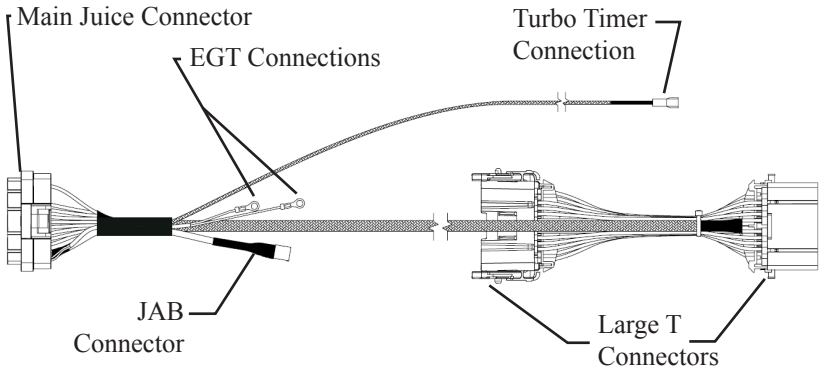

Installing the Juice Harness

1. Locate the engine harness connectors shown.
2. Disconnect the connector by rotating the gray lever toward the passenger side.
3. Carefully insert the "T" connector between the stock engine harness connectors.

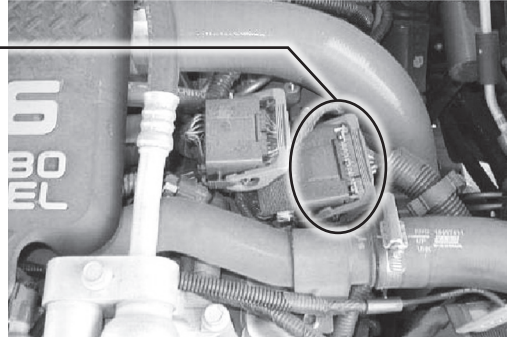

4. Carefully lock the connector by rotating the gray lever.
5. Route the turbo timer wire to the engine compartment fuse box.
6. Locate and remove the 10 amp fuse labeled "TBC BATT" and insert the fuse link in its place as shown.

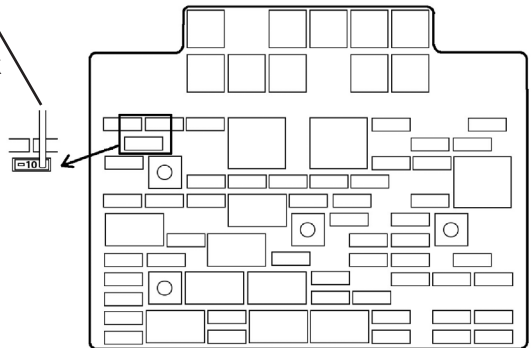

7. Connect the end of the Turbo Timer wire to the end of the Fuse Tap wire.
8. Continue to the EGT Installation section.

Juice Installation 2007.5-2010 (LMM)

Supplied Items & Required Tools

- ① Main Harness
- ② Juice Module
- ③ Velcro Strips
- ④ Zip Ties
- ⑤ EGT Sensor Probe
- ⑥ Juice Attitude Bridge (JAB)
- ⑦ Fuse Link
- ⑧ Quick Install Guide

- Electric/Cordless Drill
- 1/8" drill bit or similar size
- 21/64" or 5/16" drill bit
- 9/16" wrench or socket
- 5/8" open end wrench
- 1/8"-27 NPT Thread Tap
- Phillips screwdriver
- 5/16" or 8mm wrench

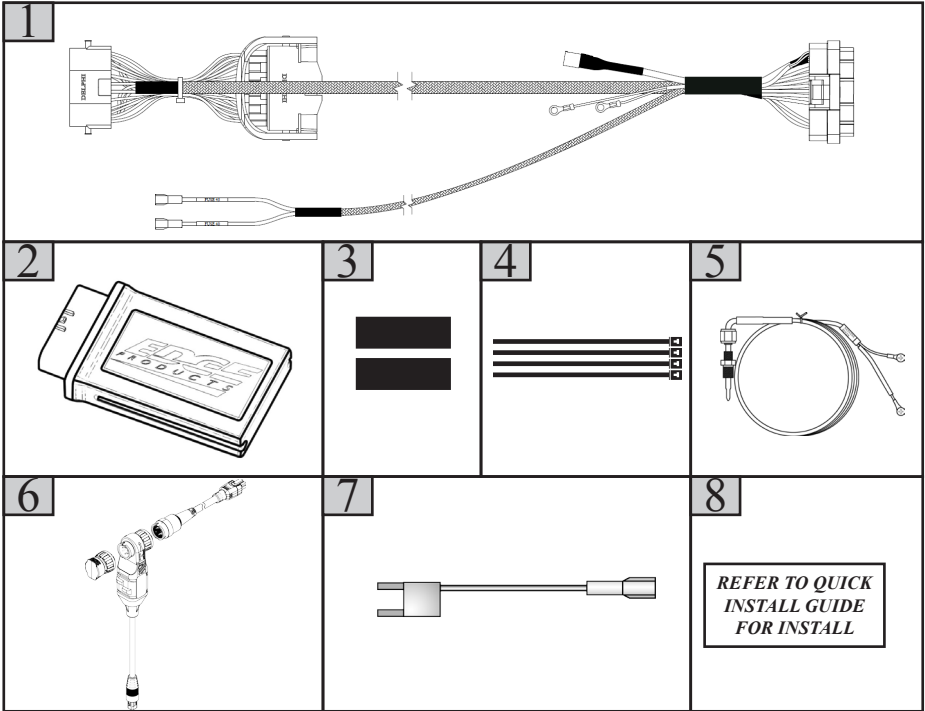

Note: Depending on your year of truck, you may not need everything provided.

CAUTION: Be carefull not to damage any of the connector electrical contacts during install. If the connectors do no connect and/or lock together easily, there may be a contact that is out of alignment.

Harness Connection Guide

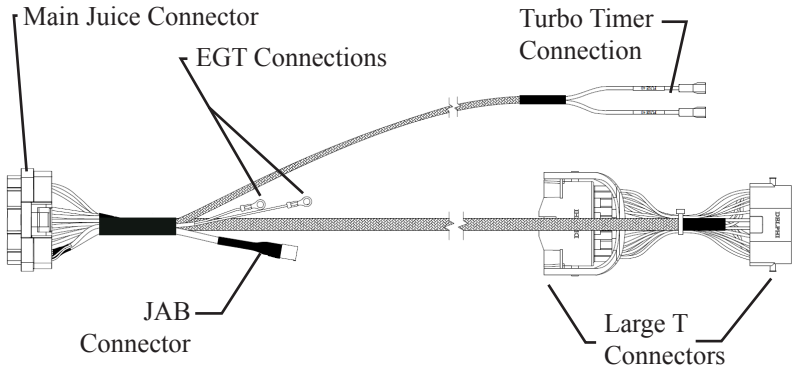

Installing the Juice Harness

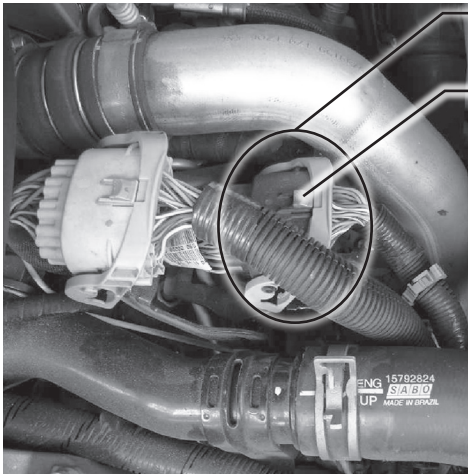

1. Locate the black engine harness connectors shown.
2. Slide the green lock away from the blue lever.
3. Rotate the blue lever towards the passenger side and disconnect the connector.
3. Carefully insert the "T" connectors between the stock engine harness connectors.
4. Carefully lock the connector by rotating the blue lever and sliding the green lock back into place.

5. Route the turbo timer wires to the engine compartment fuse box.

6. Remove fuse 43 (IPC) & 40 fuse (MISC IGN). Replace them with the fuse links as shown below



7. Connect the Turbo Timer connectors to the Fuse Tap connectors according to the wire labels.

8. Continue to the EGT Installation section.

EGT Probe Installation

Supplied Items & Required Tools

WARNING When installing the EGT (Exhaust Gas Temperature) Thermocouple, wear eye protection and protective clothing to protect from getting metal chips in your eyes. Also, since exhaust manifolds can be very hot, allow the engine to cool before drilling. When working under the vehicle, make sure the park brake is set.

<u>Supplied Items</u>	<u>Qty</u>
① EGT Probe.....	(1)
② Shrink Tube.....	(2)

Required Tools

- Electric/Cordless Drill
- 1/8" drill bit or similar size (for pilot hole)
- 21/64" (best size) or 5/16" drill bit (for final hole)
- 9/16" wrench or socket
- 5/8" open end wrench
- 1/8"-27 NPT Thread Tap
- Phillips screwdriver
- 5/16" or 8mm wrench

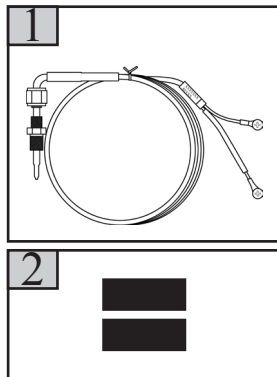

CAUTION: One effective way to avoid metal fragment contamination in your engine manifold is to apply grease in the tip of the drill bit and threads of your tap tool when drilling/tapping the hole in your manifold. Reduce pressure on the drill when the drill breaks through the manifold wall to reduce risk of pushing metal chips into the manifold.

Tapping and Probe Installation

1. Obtain a 1/8"-27 NPT Thread Tap.
2. Drill a 21/64" (5/16" optional) hole through the manifold wall.
3. Use the pipe tap to cut the threads in accordance to the pipe tap manufacturer's instructions and recommendations.

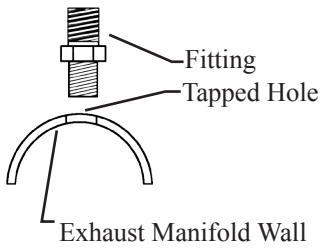

4. Remove the fitting from the Thermocouple and install by tightening the tapered thread end into the manifold.
5. Tighten the fitting so that it is securely seated.

6. Install the probe into the fitting, and tighten the top nut of the fitting just tight enough to keep the probe firmly mounted.

NOTE: Ideally the tip of the fitting would be less than or flush with the inside of the exhaust flow path.

7. Make sure that the probe cable is positioned to allow best path and minimal bending for routing to the fire wall.

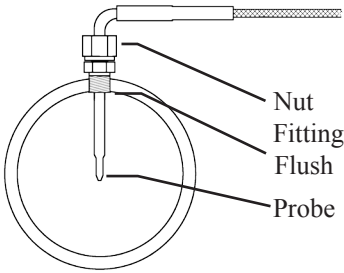

NOTE: The probe will move approximately 90 Deg. clockwise in the direction the nut is tightened. Before fully tightening the nut, make sure the cable starts 90 Degrees from the final resting position. When tightened, the cable will be correctly positioned.

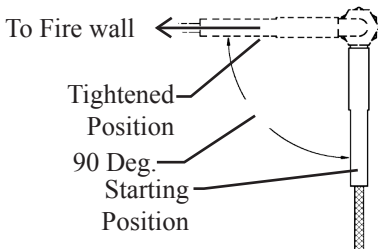

CAUTION: Do not bend the probe after installed. If needed, loosen the probe nut, adjust the probe, and re-tighten. Bending the probe tubing will result in a faulty probe.

Correct

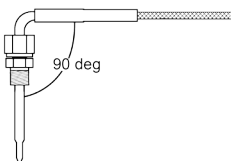

Wrong

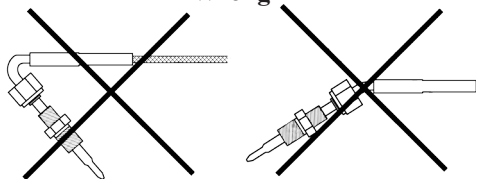

EGT Locations



Pull back the wheel splash guard to provide easier access

2007.5-2010

2001-2005

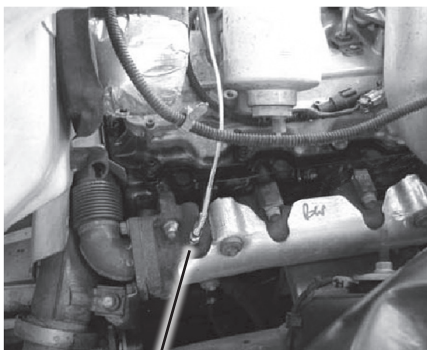
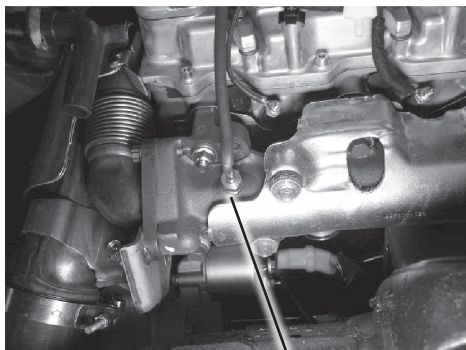

Thermocouple Location

EGT probe to the Juice Module

1. Slide the shrink tube pieces over the two wires. Later you will slide them over the bolted connections.

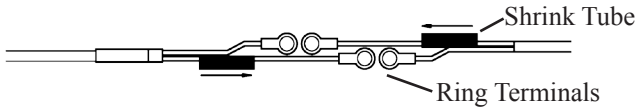

2. Connect the (2) ring terminals to the mating Juice harness terminals using the supplied hardware. Yellow to Yellow. Red to Red. Tighten the nuts so that each wire is in line with its mating wire.

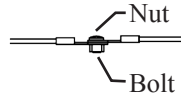

3. Position the supplied shrink tube over the secure fasteners. Center the connection within the shrink tube. Heat and shrink the tubing over the connections.



6. Secure the excess cable to the existing engine wire harnesses with supplied zip ties.

JAB Installation

2001-2010 Trucks

NOTE: The Attitude will not function unless the JAB is properly installed and plugged into both the Juice Module and Attitude Monitor.

1. Locate the green connector on the Juice Harness and plug it into the Green connector on the JAB.

2. Under the hood, connect the 3 EAS components to one another. A “click” will be felt and heard indicating that the connectors are correctly fastened.

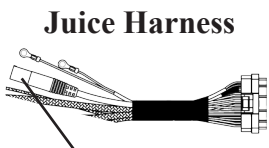
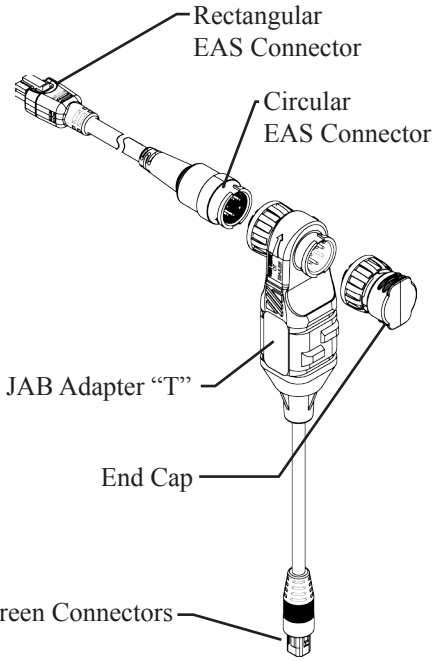

JAB System

3. Route the Rectangular EAS Connector and cable through the fire wall grommet. The JAB and Juice Module will remain under the hood.

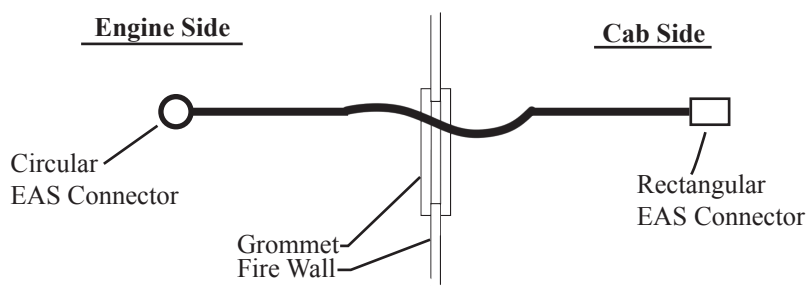

4. Route the cable from below the dash up to the HDMI cable's EAS Junction. Refer to the Quick Install Guide for instructions on how to route the HDMI Cable.

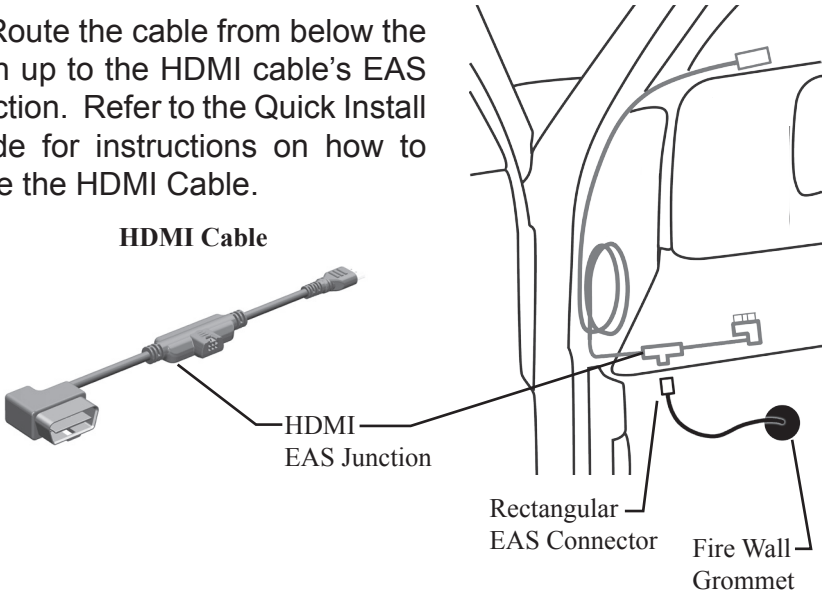

5. Using the supplied zip ties, fasten the JAB connectors underneath the overhang which runs across the top of the fire wall.

6. Keep the JAB assembly close to the driver side.

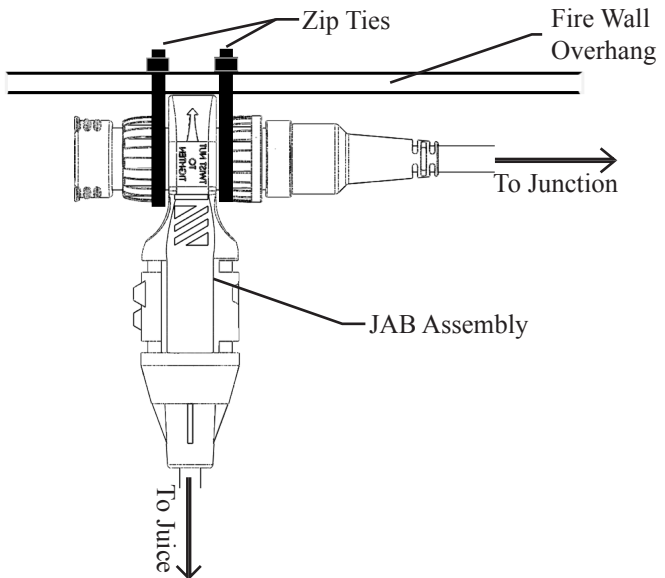

Final Installation

Connecting the Juice Module

1. Plug the “Main Juice Connector” into the “Juice Module” receptacle.

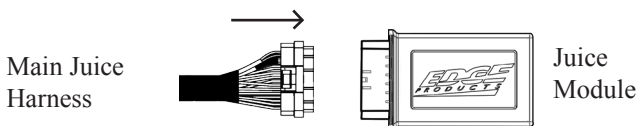

Mount and Secure the Juice Module

1. Attach one side of each Velcro strip to the back side of the Module and to the top side of a flat surface under the hood.

NOTE: *The best place is the top of the fuse box on the driver side. This will secure the Juice module and help keep it away from any moving or hot components under the hood.*

Mount and Secure the Juice Module

1. Recheck all connections for a properly secure installation.
2. Using the supplied wire ties, secure the wiring harness and cable to prevent possible heat damage from hot engine surfaces.
3. Start the engine. The engine should start and idle like a stock truck. If the engine does not start or run properly, turn off the engine. Remove the keys from the ignition, and check the Juice module connections. Make sure all connectors are fastened tightly.

Appendix

Operating the Attitude Module

Refer to the Attitude User Manual for detailed descriptions on how to operate the Attitude Monitor.

Additional Information

EGT's

EGT stands for exhaust gas temperature, and is the single most important indicator of how a diesel engine is performing. Unlike a gasoline motor, a diesel motor will continue to make power as more fuel is added. As more fuel is added, the engine heat will also increase. Please be aware of the limitations of a stock engine.

ENGINE CODES

The engine codes are generally set during heavy acceleration. Although the codes will remain "set" in the PCM, the dash board indicator light should turn off within 15 minutes. Most codes that are set under hard acceleration are called "soft codes". These soft codes are retained in the PCM and can be erased by using the Attitude to clear the codes.

Codes that may be set:

- P1211 – Injector control pressure is different than expected
- P1209 – Peak injection pressure fault