

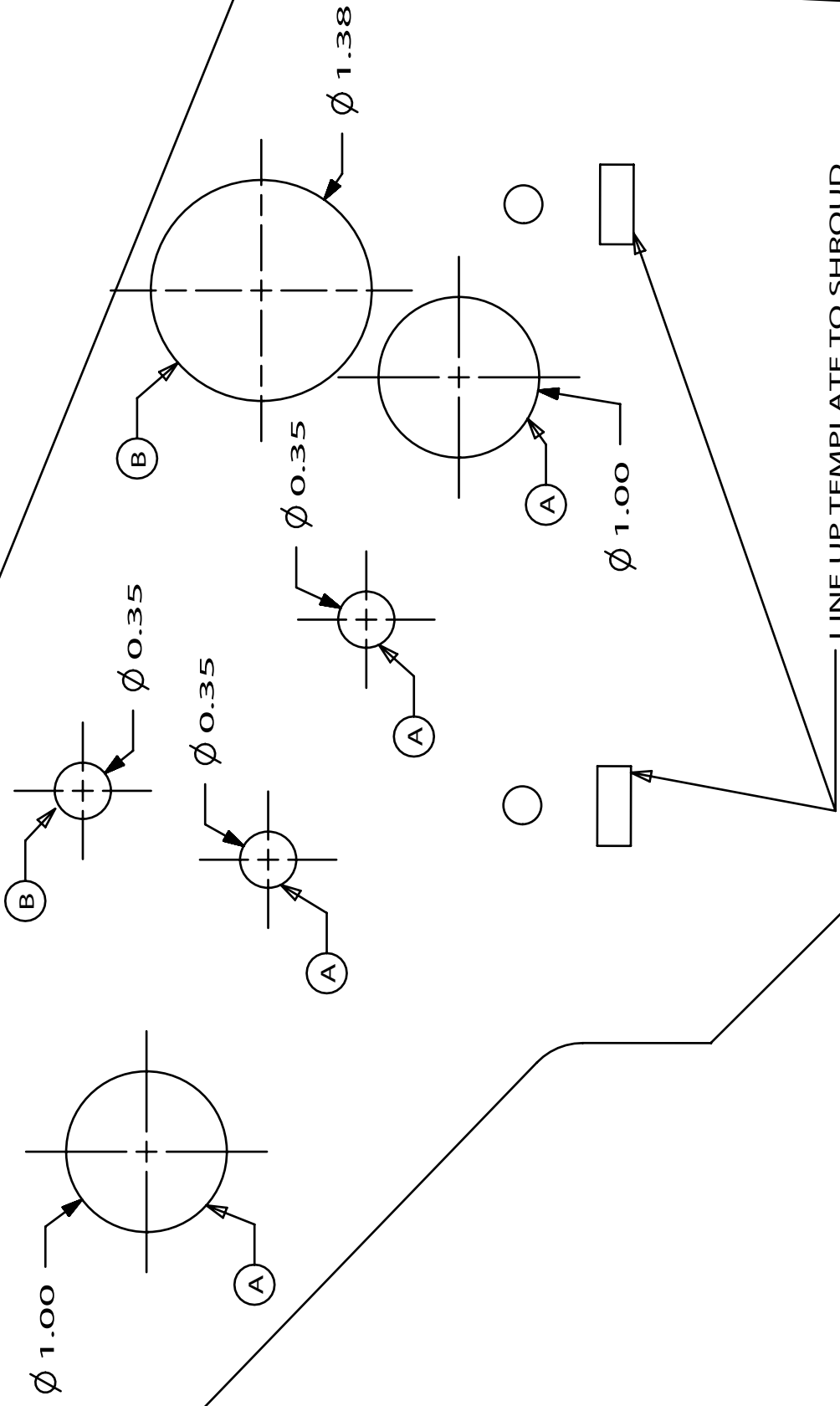

# **Edelbrock LS3 Corvette Supercharger**

**Part #1590, 1591 & 1592**

TEMPLATE, FAN SHROUD,  
C6 CORVETTE, LH



**LH**

LINE UP TEMPLATE TO SHROUD  
USING THESE FEATURES

FOR VEHICLES EQUIPPED WITH AUX. OIL COOLER,  
DRILL HOLES MARKED A.

FOR VEHICLES NOT EQUIPPED WITH AUX. OIL COOLER,  
DRILL HOLES MARKED B

TEMPLATE, FAN SHROUD,  
C6 CORVETTE, RH

**RH**

LINE UP TEMPLATE TO SHROUD  
USING THESE FEATURES

DRILL HOLES MARKED A FOR ALL VEHICLES

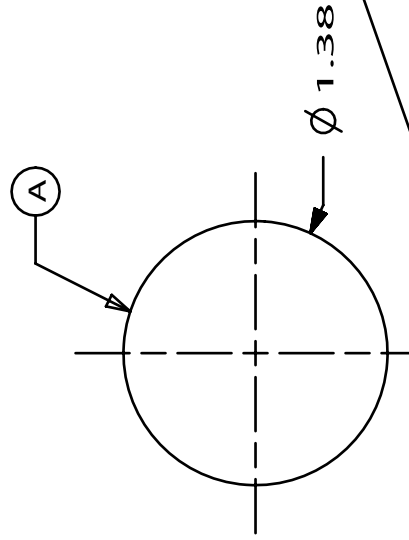
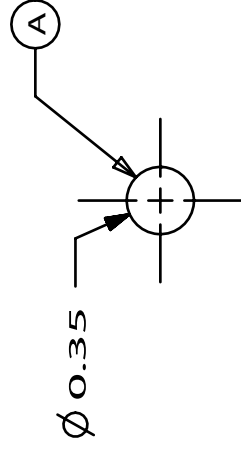

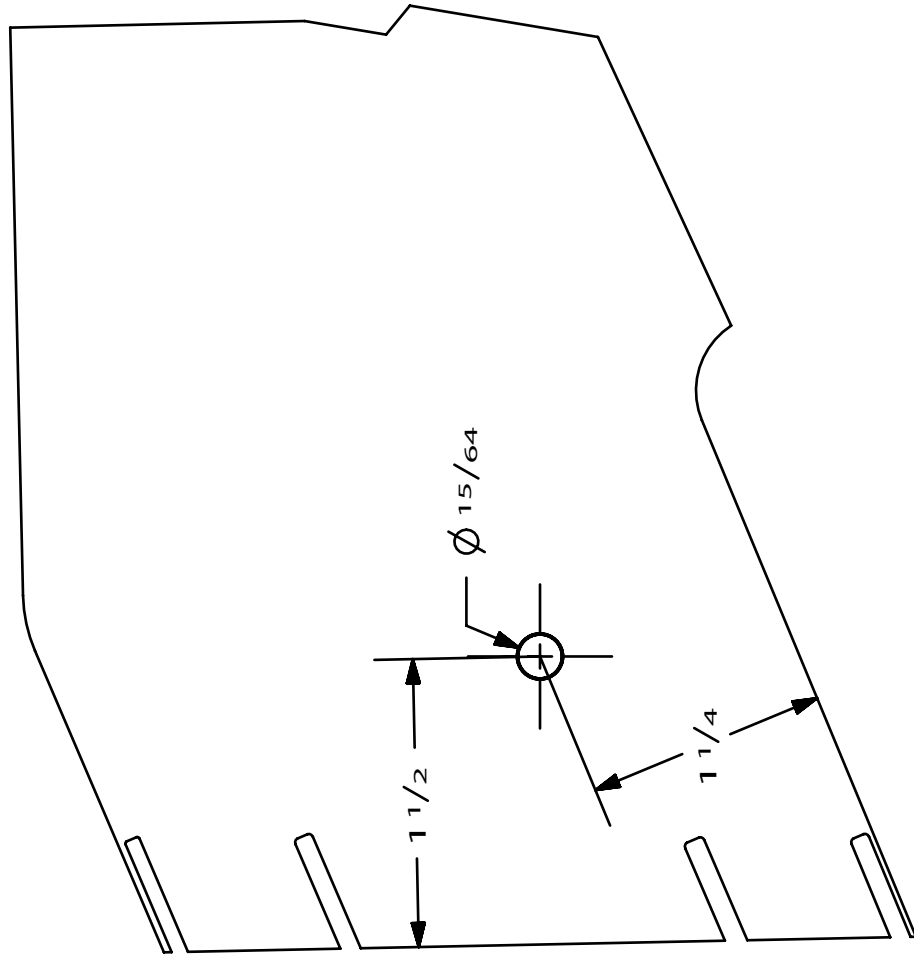



## Edelbrock GM LS3 Supercharger System for 2008 and later Base Model Corvettes

### Installation Instructions

## INTRODUCTION

Thank you for purchasing the Edelbrock 6.2L GM Supercharger System for the Chevy Corvette. The Edelbrock E-Force Supercharger System for the 2008 and later base model Corvette (not compatible with Z06 or ZR1 models) utilizes Eaton's new Gen VI TVS Supercharger rotors, featuring a four lobe design with a full 160 deg. of twist for maximum flow, minimum temperature rise, quiet operation, and the reliability for which Eaton is known. The Edelbrock Supercharger is a complete system that maximizes efficiency and performance by minimizing air restriction into, and out of, the supercharger. This results in maximum airflow, with minimal temperature rise and power consumption. The supercharger housing itself is integrated into the intake manifold for a seamless design with minimal components, eliminating the possibility of vacuum leaks between gasket surfaces. The system also utilizes a front drive, front inlet configuration giving it the shortest, least restrictive inlet path on the market. The supercharger is inverted, expelling the air upward. Air pressure then builds in the plenum, before being drawn down through each of two intercooler cores, oriented horizontally, next to, and below the supercharger outlet. After passing through the intercooler cores, the air travels through the long 12" runners, which route underneath the supercharger housing to the cylinder head ports, in a horizontal, nested configuration. The upper plenum area is enclosed by a top cover that has been designed to provide an appealing and distinctive under-hood appearance. This configuration allows for a compact package that can fit under the stock hood and cowl of the C6 Corvette, without sacrificing runner length, or intercooler area. The E-Force supercharger features a uniquely styled plenum, and includes matching side covers. The Edelbrock supercharger provides neck snapping performance that is safe to operate on a completely stock engine. It is 50-state emissions legal, and can be had with an optional 5-year 100,000 mile warranty so that there are no worries when installing it on a brand new car.

## TOOLS AND SUPPLIES REQUIRED

- Jack and Jack Stands
- **OR** Service Lift
- Panel Puller
- Ratchet and Socket Set including: 7mm, 8mm, 10mm (standard, deep and universal), 11mm, 12mm (deep), 13mm, 15mm, 18mm, 21mm (deep), 24mm
- Wrenches including: 8mm, 18mm, 27mm
- 18mm Line Wrench
- 12" Ratchet Extension Bar
- 1/2" Breaker Bar
- Flat Blade & Philips Screwdrivers
- Compressed Air
- Torx-20 Driver
- Allen Wrenches including: 5mm, 6mm, 8mm
- 5/8" Fuel Line Removal Tool
- Torque Wrench
- Needle Nose Pliers
- Pliers
- **OR** Hose Clamp Removal Tool
- Pneumatic or Power Drill
- Impact Wrench
- Loctite 609 Retaining Compound or equivalent
- O-ring Lube
- Anti-sieze
- Masking Tape
- DT-47731 Transmission Cooler Quick Disconnect Tool
- J-42188 Ball Joint Separator
- J-42386-A Flywheel Holding Tool



## Edelbrock GM LS3 Supercharger System for 2008 and later Base Model Corvettes

### Installation Instructions

## IMPORTANT WARNINGS

### ***SPECIAL NOTE FOR OWNERS OF THE 1591 599HP KIT***

If you have purchased the 599HP Complete supercharger kit P/N: 1591, then your system includes an upgraded in-tank Z06 fuel pump, to support the additional horsepower that this system provides over the standard, 554HP, kit P/N: 1590. Installation of this pump is complex, and not something we recommend for the do it yourselfer. Edelbrock strongly recommends that before beginning the install of your 1591 supercharger kit, you take the vehicle to a Chevrolet dealership, or experienced Corvette repair facility, for installation of this pump, per the specified GM workshop manual procedure. Once installed, you can follow these instructions to fully install the Edelbrock system.

**NOTE:** Competing systems often recommend, or utilize, voltage amplifiers for the purpose of increasing the output of the stock fuel pump. While these systems do work, and will work in conjunction with the E-Force superchargers as well, Edelbrock does not endorse their use, as they can significantly reduce the life of the stock fuel pump, resulting in possible engine damage. Edelbrock strongly feels that the increased effort to install the upgraded, in-tank, Z06 fuel pump assembly, included in the 1591 kit, is the proper way to address the need for increased fuel volume.



**WARNING:** *Installation of this supercharger will result in a significant change to the performance characteristics of your vehicle. It is highly recommended that you take some time to familiarize yourself with the added power, and how it is delivered, in a controlled environment. Take extra care on wet and slippery roads, as the rear tires will be more likely to lose traction, with the added power. It is never recommended to turn off your vehicles traction control system.*

***Proper installation is the responsibility of the installer. Improper installation will void all manufacture's standard warranties and may result in poor performance and engine or vehicle damage.***

Due to the complexity of the Edelbrock E-Force Supercharging system, it is recommended that this system only be installed by a qualified professional with access to a service lift, pneumatic tools, and a strong familiarity with automotive service procedures. To qualify for the optional supplemental warranty, it is necessary to have this system installed by a Certified ASE Technician, GM Dealership, or an Authorized Edelbrock Installer. Failure to do so will void and/or disqualify any and all optional supplemental warranties offered with this system. Please contact the Edelbrock Technical Support department if you have any questions regarding this system and/or how your installer of choice will affect any warranty coverage for which your vehicle may qualify.



## Edelbrock GM LS3 Supercharger System for 2008 and later Base Model Corvettes

### Installation Instructions

#### IMPORTANT WARNINGS (CONTINUE)

***Edelbrock periodically releases improved versions of the calibration file found on the supplied handheld programmer. Check the website to ensure you have the latest version, as described in step #209.***

***Any previously installed aftermarket tuning equipment must be removed and the vehicle returned to an as stock condition before installing the supercharger.***

Any equipment that directly modifies the fuel mixture or ignition timing of the engine can cause severe engine damage if used in conjunction with the Edelbrock E-Force Supercharger System. This includes, but is not limited to: ignition boxes, air/fuel controllers, OBDII programmers, and any other device that modifies signals to and/or from the ECU. The ECU must be running the stock tune before uploading the Edelbrock tune. Aftermarket bolt-on equipment such as underdrive pulleys or air intake kits will also conflict with the operation of the supercharger and must be removed prior to installation. Use of any of these products with the E-Force Supercharger could result in severe engine damage.



***91 octane or higher gasoline is required at all times. If your vehicle has been filled with anything less, it must be run until almost dry and refilled with 91 or higher octane gasoline twice prior to installation.***

***Failure to use the required 91 octane gasoline or higher could permanently damage your engine. Any failures associated with not using premium 91 octane gasoline or higher, will be ineligible for warranty repairs.***



**Edelbrock GM LS3 Supercharger System for  
2008 and later Base Model Corvettes**

**Installation Instructions**

**INSTALLATION HARDWARE IDENTIFICATION GUIDE**

**Bag #1**



(2x) - M8 Washer

(3x) - M8 x 1.25 x 20mm  
Hex Flange Bolt



(1x) - M10 x 1.5 x 75mm  
Hex Flange Bolt



(1x) - M10 x 1.5 x 45mm Socket Head Bolt



(3x) - M8 x 1.25 x 90mm Hex Flange Bolt

**Bag #2**



(1x) - M8 x 1.25 x 30mm  
Hex Flange Bolt

(3x) - M6 x 1 x 16mm  
Hex Flange Bolt



(2x) - M6 x 1 x 20mm  
Hex Flange Bolt

(1x) - Nylon Body Pin



(1x) - Lower Intercooler Reservoir Bracket



(2x) - 1/2" Hose Clamp



(1x) - Upper Intercooler Reservoir Bracket



(6x) - 3/4" Hose Clamp





# Edelbrock GM LS3 Supercharger System for 2008 and later Base Model Corvettes

## Installation Instructions

### Bag #3



(11x) - M8 x 1.25 x 25mm  
Countersunk Socket Head Bolt



(8x) - M6 x 1 x 45mm  
Hex Flange Bolt



(4x) - M6 x 1 x 12mm  
Socket Head Bolt



(2x) - M6 x 1 x 16mm  
Button Head Bolt

### Bag #4

(1x) - GM Factory Harmonic Balancer Bolt



(1x) - M16 x 2 x 120mm Hex Bolt



(1x) - Crank Pinning Drill Guide

(1x) - 1/4" x 3/4" Steel Dowel



(1x) - 15/64" High Speed Steel Drill Bit



(1x) - .2500" Reamer





**Edelbrock GM LS3 Supercharger System for  
2008 and later Base Model Corvettes**

**Installation Instructions**

**Bag #5**



(1x) - Barbed Quick Connect Fitting



(2x) - Air Inlet Tube Retainer Grommet



(1x) - Air Inlet Tube PCV Grommet

**Bag #6**

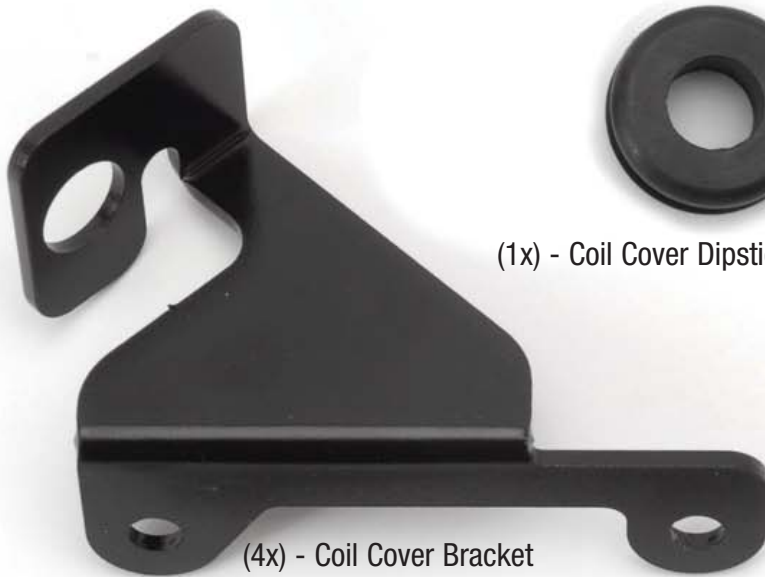

(4x) - Coil Cover Bracket



(1x) - Coil Cover Dipstick Grommet



(4x) - Coil Cover Retainer Stud



(4x) - Coil Cover Standoff



# Edelbrock GM LS3 Supercharger System for 2008 and later Base Model Corvettes

## Installation Instructions

### HOSE IDENTIFICATION GUIDE

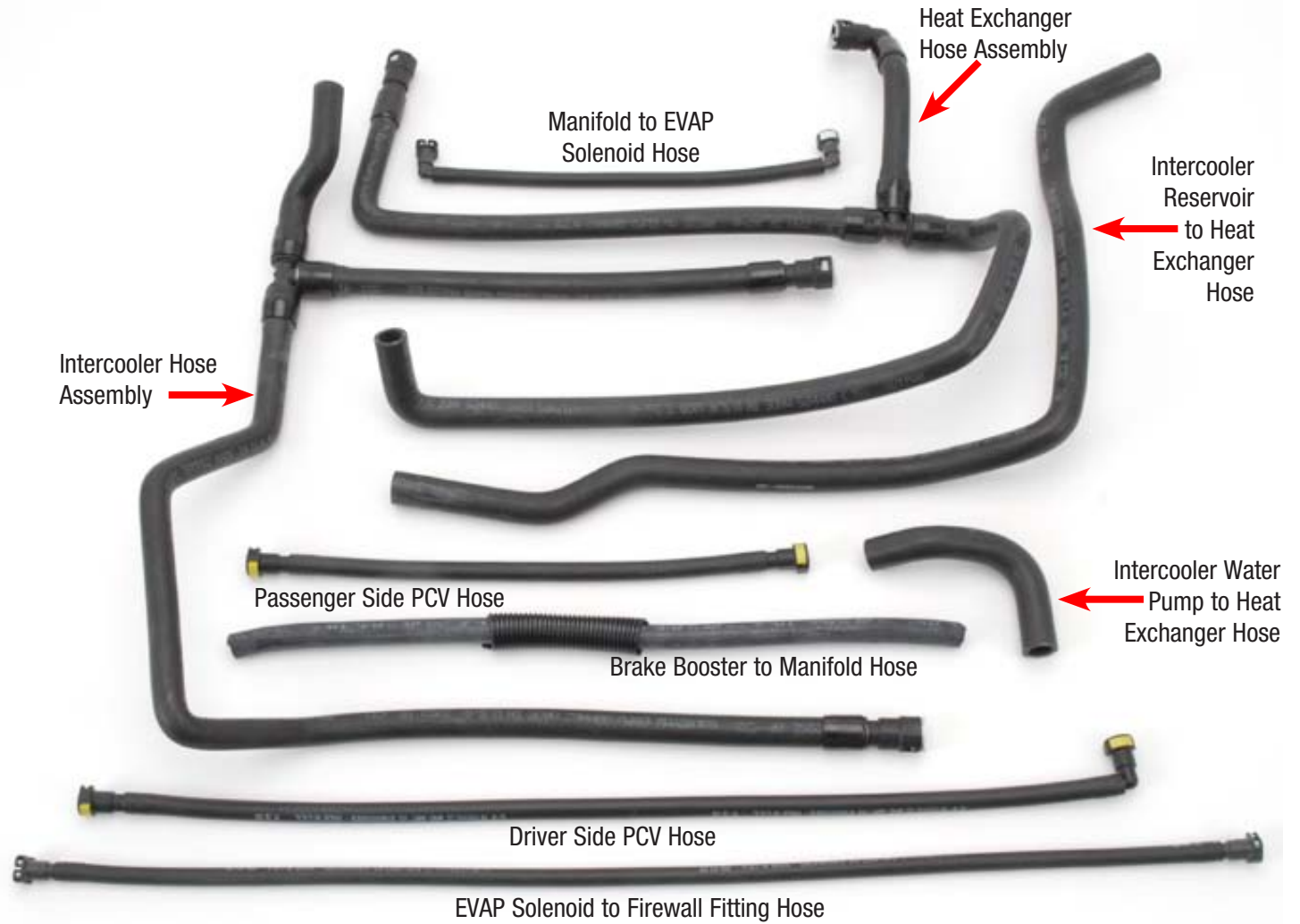



## Edelbrock GM LS3 Supercharger System for 2008 and later Base Model Corvettes

### Installation Instructions

#### Test Flash Procedure

Use the supplied programmer to flash the ECU and verify its compatibility.

- Original Equipment Manufacturers often release updates to the computer programming for your vehicle. Edelbrock highly recommends that you verify, with your new car dealer, that your vehicle is equipped with the latest software version from your vehicle manufacturer, before attempting to load the Edelbrock tune.
- Confirm that you have the latest calibration by checking the Edelbrock website
- Put the car into Acc mode, but don't start the vehicle.
- Connect the supplied PCM cable to the OBD-II connector.
- Use directional pad to highlight Program Vehicle option and press Select button.
- Use directional pad to highlight Preprogrammed Tune option and press Select button.
- Read disclaimer then press Select to continue.
- Verify ignition is in the 'Key On' position but that the engine is not running then press Select.
- Use directional pad to highlight your vehicle and transmission combination then press Select.

- Use directional pad to highlight Begin Program then press Select.

- Depending on your specific drivetrain configuration, several separate operations may take place during this step. Completion of each operation will cause the progress bar to reset to zero.

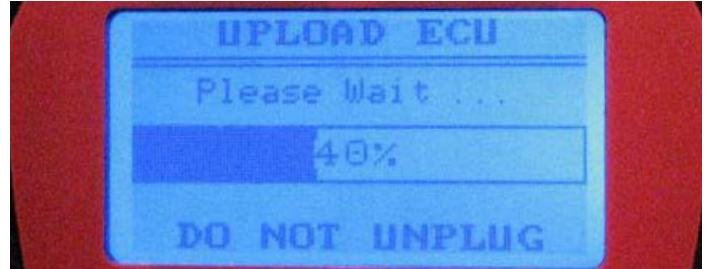

**DO NOT unplug the programmer until prompted.**

- Turn the car off when prompted to do so by the handheld programmer.
- Read parting message from programmer then press Select to continue.
- Unplug the programmer cable from the OBD-II port.

*In the rare occurrence that you encounter an error message during the test flash procedure, please refer to pg.33, titled E-mail Edelbrock Your Stock PCM Calibration.*

---

#### Post Successful Test Flash

If you are ready to install the supercharger, proceed to Step 1 of the Supercharger Installation

OR

If you wish to return the ECU back to the factory calibration, such that the vehicle can still be driven until you are ready to begin the installation, then:

- Put the car into Acc mode, but don't start the vehicle.



## Edelbrock GM LS3 Supercharger System for 2008 and later Base Model Corvettes

### Installation Instructions

- Connect the supplied PCM cable to the OBD-II connector.
- Use directional pad to highlight Program Vehicle option and press Select button.
- Use directional pad to highlight Return To Stock option and press Select button.
- Follow the on screen instructions. Turn the car off when prompted to do so by the handheld programmer.
- Read parting message from programmer then press Select to continue.
- Unplug the programmer cable from the OBD-II port.
- When you are ready to Install the supercharger, proceed with Step 1 and you will be prompted to re-flash the ECU towards the end of the installation procedure.

### Supercharger Installation

2. Use a 10mm socket to loosen and remove the negative and positive battery terminals.



3. Use a 13mm socket and an extension bar to loosen and remove the battery hold down.



4. Remove the battery and set it to one side.

5. Use a 7mm wrench to remove the four bolts retaining fascia center.

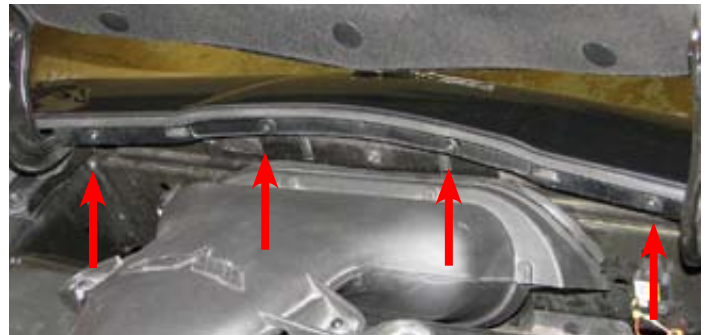

6. Lift and support the front end of the vehicle using a jack and appropriately load rated jack stands then loosen and remove the lug nuts from both front wheels. Remove the wheels and set them aside.





## Edelbrock GM LS3 Supercharger System for 2008 and later Base Model Corvettes

### Installation Instructions

7. Use a panel puller to remove the 7 body pins on each side that retain the inner fender wells. (Note: Some trim packages use screws in place of pins along outer edge.)

8. Pull back the inner fender well to access the two bumper studs on each side. Use a 10mm deep socket to remove the nuts.

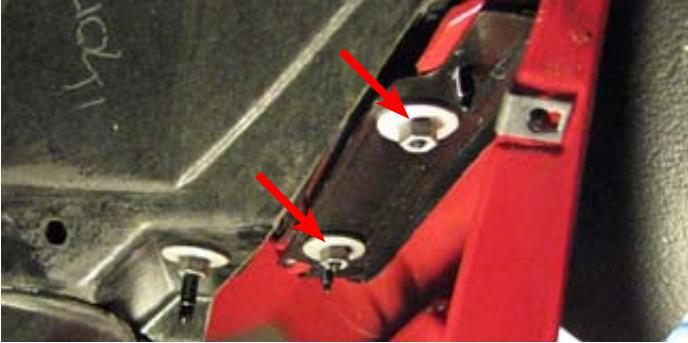

9. Disconnect the indicator and fog lamp electrical connectors.



10. Remove the three screws and one body pin that retain each front valance.



11. Remove the five 7mm and two 10mm nuts retaining the fascia from below.



12. Remove four body pins (two on each side) by reaching up through the bottom of the fascia.

13. Place multiple layers of masking tape on the nose of the hood as well as the portion of the front fascia directly below the hood to protect from damage during removal.



14. The sides of the fascia can be pulled away from the clips holding it in place, then down off the studs. The center section must be pulled up and over the nose section, and the whole assembly pulled straight off and set aside.





## Edelbrock GM LS3 Supercharger System for 2008 and later Base Model Corvettes

### Installation Instructions

15. Disconnect the Mass Airflow Sensor connector.



16. Use a flat head screwdriver to loosen the Throttle Body to inlet tube worm clamp.

17. Disconnect the PCV tube from the air inlet tube.



18. Lift the airbox and resonator tube off the locator pins and remove it and the air inlet tube as an assembly.

19. Use a 16mm socket and a breaker bar to turn the tensioner until the serpentine belt has enough slack to remove.



20. Remove coil covers from valve covers by lifting up and working fuel line through slot on driver side.

21. Disconnect the Electronic Throttle Control connector on the passenger side of the throttle body.

22. Use a 10mm socket to remove the four bolts holding in the throttle body and set it aside.



23. Disconnect the ignition coil harness and O2 sensor connectors then disconnect the spark plug wires from the ignition coils.

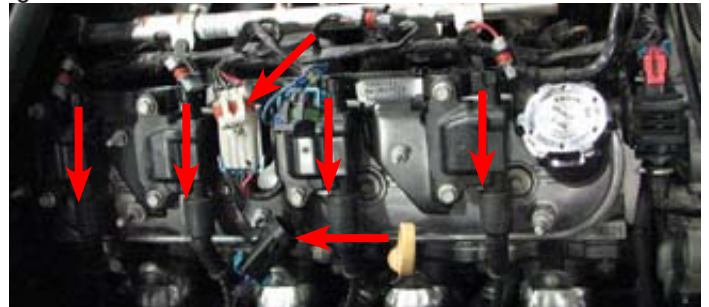

24. Use a 10mm socket to remove the five bolts retaining the coil bracket on each valve cover then remove both coil bracket assemblies.

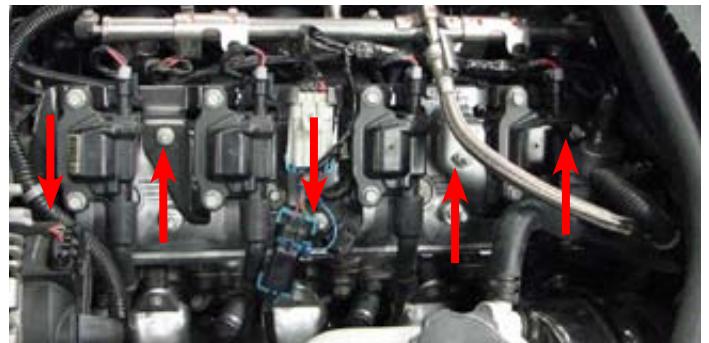



## Edelbrock GM LS3 Supercharger System for 2008 and later Base Model Corvettes

### Installation Instructions

25. Use a fuel line removal tool to disconnect the fuel line from the rails using a shop rag to absorb excess fuel.

26. Disconnect and remove passenger side PCV tube.

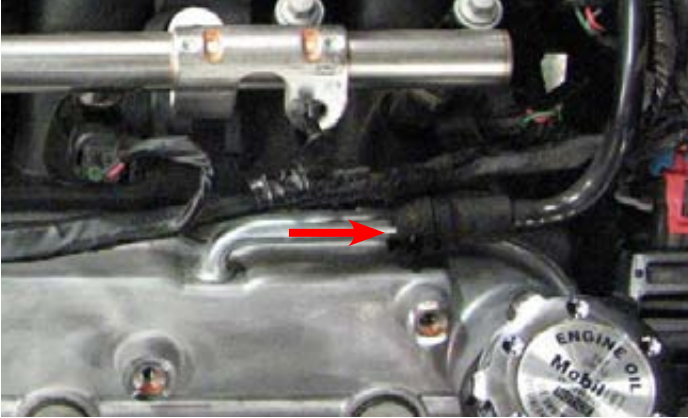

27. Disconnect all eight fuel injector connectors.

28. Use a 10mm socket to remove the four fuel rail bolts. **NOTE:** You will also need to remove one 8mm manifold bolt and bracket before removing the fuel rails.

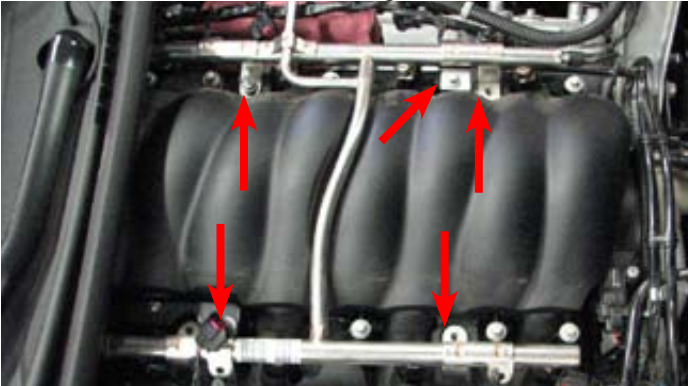

29. Lift the injectors out of the manifold and work the rails forward until they can be set aside.

30. Use an 8mm socket to loosen the two rear passenger side manifold bolts. Slide the manifold cover out from under the bracket those bolts retain and remove it.



31. Use a 10mm socket to remove the seven remaining manifold bolts (out of ten).

32. Disconnect the EVAP solenoid electrical connector.



33. Disconnect MAP sensor electrical connector.



34. Disconnect the vacuum hose from the brake booster fitting; it will be removed with the manifold.







## Edelbrock GM LS3 Supercharger System for 2008 and later Base Model Corvettes

### Installation Instructions

35. Disconnect and remove the two EVAP tubes located at the front of the manifold.



36. Disconnect passenger side PCV tube from valley plate.



37. Remove the intake manifold and disconnect the small vacuum hose at the rear of the manifold next to the larger brake booster hose. Leave this hose connected to the firewall as it will be reused later.

38. Use masking tape to cover the exposed intake ports on the cylinder head.

39. Remove the O-ring port gaskets from the stock intake manifold and set them aside for reuse later.

40. Use a 15mm socket to remove the two bolts retaining the belt tensioner.



41. Disconnect the oil pressure sensor electrical connector at the rear of the valley plate.

42. Use a 27mm wrench to remove the oil pressure sensor from the rear of the valley plate.

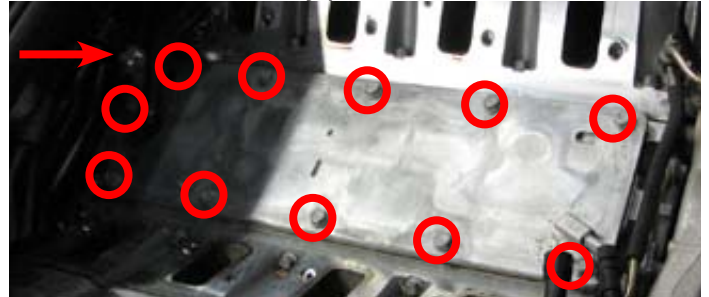

43. Clear engine valley of all debris then use a 13mm socket to remove the 11 bolts retaining the valley plate and remove it.

44. Use a small flathead screwdriver to remove the eight O-ring seals from the stock valley plate and install them in the new valley plate.



45. Apply anti-seize to the tapered surface beneath the heads of the countersunk bolts supplied in Bag #3 and install the valley plate with the stock perimeter gasket. Tighten the bolts from the center out with a 5mm allen tool then torque them to 18 ft-lbs in the same sequence.

46. Install the oil pressure sensor into the supplied valley plate with thread sealant and a 27mm wrench. Torque the sensor to 15 ft-lbs.

47. Reconnect the oil pressure sensor electrical connector at the rear of the valley plate.



## Edelbrock GM LS3 Supercharger System for 2008 and later Base Model Corvettes

### Installation Instructions

48. Use a 15mm socket to remove the bolt retaining the EVAP solenoid.



49. Use a 10mm socket to remove the four bolts (two on each side) retaining upper radiator shroud and remove it.



**NOTE:** If your vehicle is equipped with an oil cooler follow steps, otherwise skip ahead to step #50.

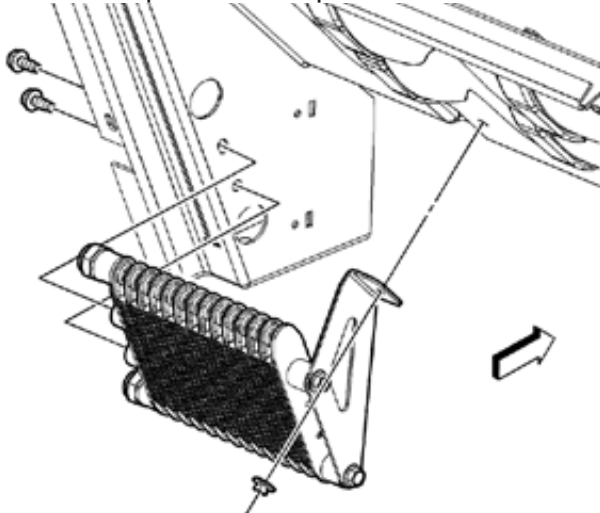

#### Z51 Oil Cooler Shown

i. Drain the engine oil.

ii. Use the DT-47731 Transmission Cooler Quick Disconnect Tool to detach two oil lines from the oil cooler.

iii. Remove the two bolts on the driver side holding the oil cooler to the shroud.

iv. Remove the nut holding the oil cooler bracket to the shroud and remove the cooler.

v. Remove two bolts attaching the bracket to the cooler.

vi. Use the stock bolts to attach the supplied bracket to the oil cooler then set it aside for the time being.

50. Remove the retaining body pin located on each side of the radiator shroud. (Passenger side shown).



51. Disconnect the ambient air temperature sensor and remove the sensor clipped to passenger side of shroud.



52. Reach up from below the car to remove the two remaining body pins retaining the front radiator shroud then remove the shroud by pulling it down and out.

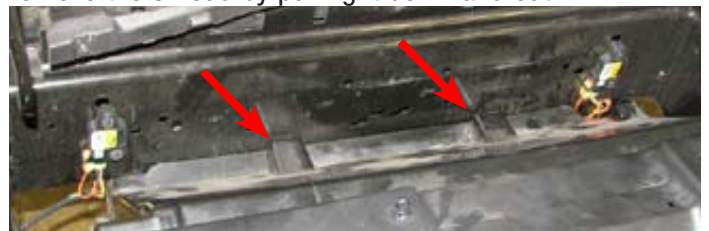



## Edelbrock GM LS3 Supercharger System for 2008 and later Base Model Corvettes

### Installation Instructions

53. Disconnect the radiator fan electrical connector then use a 10mm socket to remove the two bolts retaining the fan assembly. Pull the hoses from the six clips holding them to the assembly and remove the fan from below.



**NOTE:** The following steps, while not strictly related to installing the supercharger, detail the process required for installing a lock pin between the harmonic balancer and the crankshaft nose. The factory design uses a press-on balancer that does not include an anti-rotation mechanism to prevent the balancer from loosening. The additional torque of the E-Force system increases the likelihood of this occurring. Any damage caused by failure to follow this procedure will not be covered by the optional warranty. If you have already had this procedure performed on your vehicle, skip ahead to step #106.

54. Use a hand siphon to drain the power steering fluid reservoir.



55. Disconnect the alternator electrical connector.

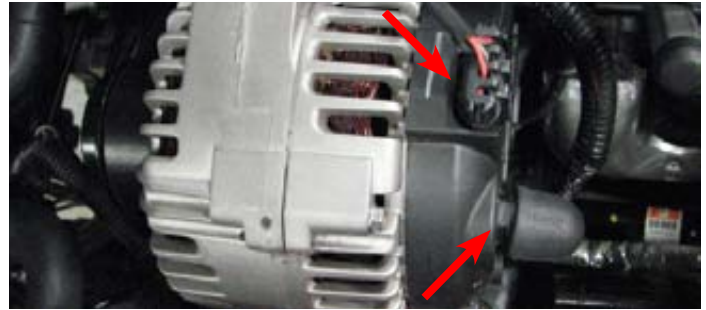

56. Use a 13mm socket to remove alternator power wire.

57. Use a 15mm socket to remove the two alternator support bolts, and then remove the alternator.

**WARNING:** With the wheels of the vehicle facing straight ahead, secure the steering wheel with a steering column anti-rotation pin, steering column lock or strap. Failure to do so may result in damage to or a malfunction of the airbag deployment system.

58. Use an 11mm socket and an extension bar to remove the bolt securing the steering column to the rack then pull the intermediate shaft off the gear. Do not attempt to turn the steering wheel until this bolt has been reinstalled.





## Edelbrock GM LS3 Supercharger System for 2008 and later Base Model Corvettes

### Installation Instructions

59. Use a 6mm Allen tool to hold the tie rod ball stud stationary while using an 18mm wrench to loosen the nut.

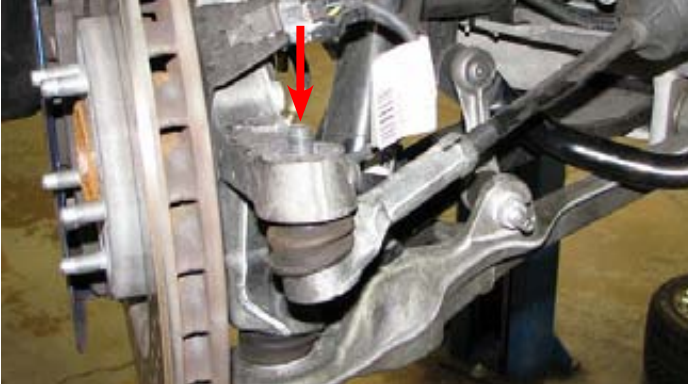

60. Use GM Ball Joint Separator #J 42188 to separate the steering knuckle from the tie rod ball stud then remove the tool and the nut. Use this procedure for both sides.

61. On 2009 and later vehicles, remove the lower nut from the endlink by placing an 8mm wrench on the end of the stud while using an 18mm wrench on the nut. 2008 vehicles will require a T40 Torx bit to hold the end of the stud while using an 18mm wrench to remove the nut. Repeat the appropriate procedure for both sides.



62. Use a 13mm socket to remove the four bolts retaining the stabilizer brackets.



63. Use a 10mm socket to remove the two nuts retaining the brake pressure modulator valve.

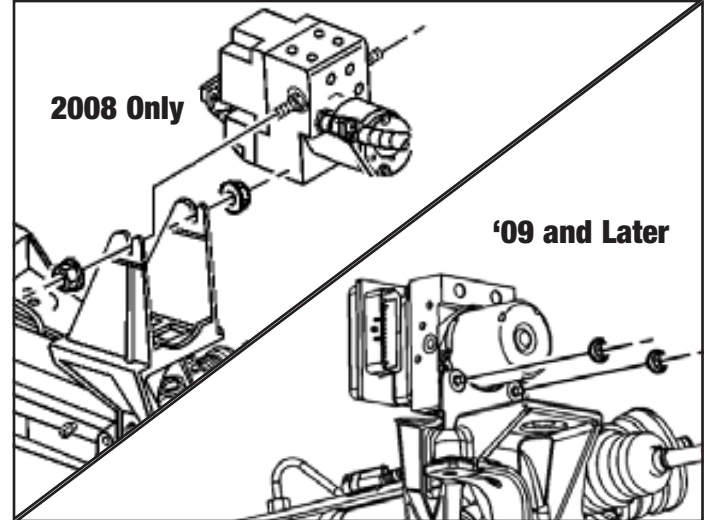

64. Place a catch pan below the steering gear then use an 18mm line wrench to disconnect the two power steering lines from the steering gear.

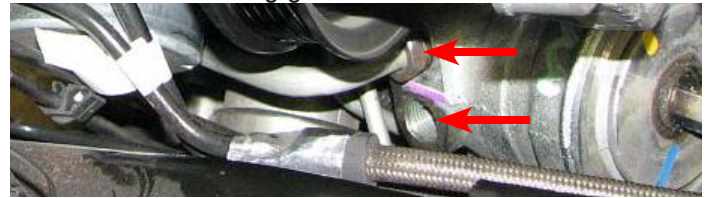

65. Use a 10mm socket to remove the bolts retaining the power steering line brackets or fluid cooler, if equipped.



66. Use a floor jack to support the oil pan.



## Edelbrock GM LS3 Supercharger System for 2008 and later Base Model Corvettes

### Installation Instructions

67. Use a 21mm deep socket to remove the two front engine cradle bolts.



68. Disconnect the ride height sensor electrical connector from each side, if equipped.



69. Use a 10mm socket to remove the driver side brake line bracket bolt.

70. Use a 10mm socket to remove driver side ride height sensor bolt.

71. Use a 13mm socket to remove the lower brake modulator bracket bolts.



72. Use an 18mm socket to remove the two steering rack nuts and bolts.

73. Remove the plastic clamp holding the power steering lines to the steering rack.



74. Loosen the rear engine cradle nuts with a 21mm deep socket and lower them until there is a gap of 10mm from the cradle to the top of the nut.



75. Insert a pry bar between the frame and front driver side cradle mount.

76. Work the power steering rack out through the driver side wheel well. Use the pry bar to widen the gap when needed and push the brake lines out of the way to clear the gearbox.

**NOTE:** The following six steps detail the process needed to loosen and remove the crank bolt. Manual vehicles have the option of placing a passenger in the car to put the car in first gear and apply firm brake pressure while turning the crank bolt in steps #84, 86, 87 & 89. Do not attempt this optional procedure if the rear wheels are on the ground or vehicle damage and/or injury could result.



## Edelbrock GM LS3 Supercharger System for 2008 and later Base Model Corvettes

### Installation Instructions

77. Disconnect the oil level sensor electrical connector from the passenger side of the oil pan.



78. Use a 10mm socket to remove the starter support bracket bolt.



79. Use a 13mm socket to remove the two starter bolts.



80. Disconnect electrical connector at top of starter.



81. Use a 13mm socket to remove the nut retaining the power wire to the starter.

82. Remove and set aside the starter and bracket.

83. Install GM Flywheel Holding Tool #J-42386-A to prevent the crank from rotating while loosening the balancer bolt and torque the bolts holding it to 37 ft-lbs.

84. Use a breaker bar and a 24mm socket to loosen and remove the crank bolt. A long pipe slid over the breaker bar can be helpful for increasing leverage.



85. Mark off with a piece of masking tape 1.5" from the tip of the supplied drill bit.



86. Use a 24 mm socket to install the supplied bolt and reamer guide to the end of the crank.



## Edelbrock GM LS3 Supercharger System for 2008 and later Base Model Corvettes

### Installation Instructions

87. Lubricate the 15/64" bit supplied in Bag #4 with a small amount of engine oil, then drill into the guide hole with a bushing until the tape mark on the bit meets the guide. Loosen the bolt and blow out any chips with compressed air then turn the guide until the ream hole lines up with the one just drilled in the crank and balancer. Use the back side of the ream tool to verify that the holes line up then tighten the bolt and use the .2500" reamer to ream the hole.

88. Use compressed air to clear out any metal shards in the hole. Apply Loctite 609 retaining compound or equivalent to the supplied crank pin then tap it into the drilled hole until it is flush.



89. Install the supplied GM crank bolt into the crank and torque it to 37 ft-lbs, then rotate it an additional 140°.

90. Slide the steering rack back into place and reconnect the electrical connector.

91. Use an 18mm socket to reinstall the steering rack nuts and bolts then torque them to 74 ft-lbs.

92. Reinstall the front crossmember nuts then use a utility jack to lift the crossmember. Torque all four crossmember nuts to 81 ft-lbs.

93. Use a 13mm socket and the stock bolts to reinstall the brake modulator bracket then torque them to 20 ft-lbs.

94. Use a 10mm socket and the stock bolts to mount the brake pressure modulator to the bracket and torque them to 106 in-lbs.

95. Use a 10mm socket and the stock bolts to reinstall the power steering line brackets.

96. Use an 18mm line wrench to reinstall the power steering pressure and return hoses to the steering gear then torque the fittings to 20 ft-lbs.

97. Use a 10mm socket to reinstall the driver side ride height sensor then plug in the electrical connector.

98. Use a 13mm socket and the four stock bolts to reinstall the stabilizer and the brackets supporting it then torque the bracket bolts to 43 ft-lbs.

99. Use an 8mm and an 18mm wrench to reattach the stabilizer bar end links to the control arms then torque the nuts to 56 ft-lbs.

100. Use a 6mm Allen tool and an 18mm wrench to reattach the tie rod ends to the control arm. Tighten the nut to 22 ft-lbs. then rotate it an additional 120°.

101. Reattach the steering column to the rack then use an 11mm socket to torque the stock bolt to 20 ft-lbs.

102. Reinstall the locating clamp around steering rack.

103. Reinstall the alternator, attaching the power wire and electrical connector then torque bolts to 37 ft-lbs.

104. Insert starter support bracket and bolt it in place.

105. Reattach the starter electrical connector and the power wires. Torque the power wire nuts to 71 in-lbs. Reinstall the starter then use a 13mm socket to torque the two bolts that hold it in place to 37 ft-lbs.

**This concludes the crank pinning procedure.**



## Edelbrock GM LS3 Supercharger System for 2008 and later Base Model Corvettes

### Installation Instructions

106. Apply blue loctite to the threads of a 20mm bolt supplied in Bag #1, then use a 12mm socket and the supplied washer to mount the pulley on the new lower idler bracket and torque it to 18 ft-lbs.



107. Use a 10mm socket to remove the three bolts on the passenger side of the water pump.

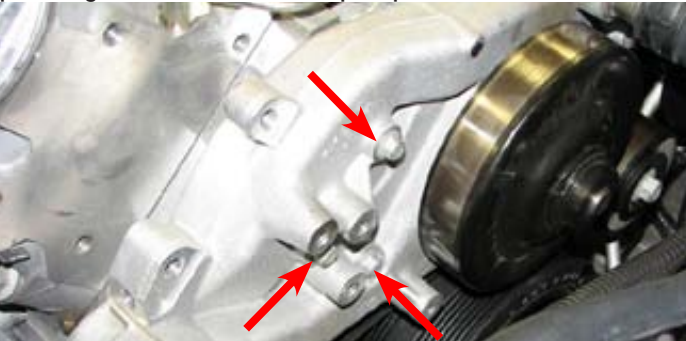

108. Use a 6mm Allen tool and the three 90mm bolts supplied in Bag #1 to install the lower idler bracket on the water pump then torque them to 18 ft-lbs.



109. Use a 15mm socket and the two stock bolts to mount the new tensioner bracket onto the water pump then torque them to 37 ft-lbs.

110. Use an 8mm allen tool to install the 45mm bolt supplied in Bag #1 that retains the tensioner bracket to the cylinder head and torque it to 37 ft-lbs.



111. Apply blue loctite to the threads of a 20mm bolt supplied in Bag #1, then use a 12mm socket and the supplied washer to mount the pulley on the tensioner bracket and torque it to 18 ft-lbs.

112. Use a 15mm socket and the 75mm bolt supplied in Bag #1 to install supplied tensioner on new bracket and torque it to 37 ft-lbs.



113. Use a 12mm socket and a 20mm bolt supplied in Bag #1 to mount the EVAP purge solenoid on the back of the new tensioner bracket.







## Edelbrock GM LS3 Supercharger System for 2008 and later Base Model Corvettes

### Installation Instructions

114. Use a 15mm wrench to remove two bolts retaining the power steering reservoir bracket. Use a pair of pliers or hose clamp tools to disconnect the lower reservoir-to-pump hose. Note that it is not necessary to fully remove the reservoir from the engine.



115. Slide the old bracket off the reservoir then install the supplied bracket using a 15mm socket and the stock bolts. Slide the power steering reservoir onto the new bracket and reattach the lower reservoir to pump hose.

116. Line up the supplied templates on the radiator shroud and drill the appropriate holes, depending on the presence, or absence, of the factory oil cooler.



117. Reinstall the radiator shroud by sliding it into place from below then hold it in place using the four stock body pins (two up front, and one on each side).

118. Clip the passenger side sensor back into place and reattach the ambient air temperature sensor connector.

119. Use a 10mm socket to remove center air dam bolt.



120. Disconnect horn electrical connector then use a 10mm socket to remove the bolt holding the horn bracket in place. Remove and set aside horn assembly.

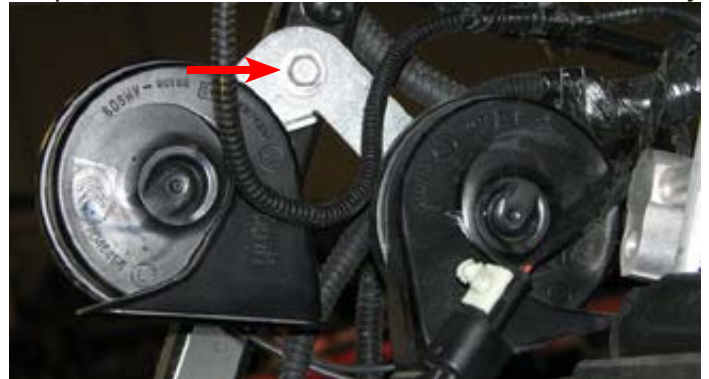

121. Use a 10mm socket to install the heat exchanger, using the 20mm bolts supplied in Bag #2 on the side, and the stock air dam bolt on the bottom.





## Edelbrock GM LS3 Supercharger System for 2008 and later Base Model Corvettes

### Installation Instructions

122. Use a 10mm socket to remove the nuts holding the horns to the bracket. Then use a small flat blade screwdriver to remove the wire harness connecting the horns and swap the connectors from horn to horn.



123. Use a 12mm socket to install the water pump in its bracket and secure it with the supplied strap.



124. Remove the passenger side lower body pin.



125. Use a 10mm socket to install the water pump bracket using the stock horn bracket bolt on top and the bolt supplied in Bag #3 on the bottom.



NOTE: There are two different water pump brackets: Version (1) requires the use of your OE horn bracket. Version (2) has an integrated horn bracket. You should have received one of the two brackets; If your supercharger kit includes bracket version (2), you may disregard Step 126.



126. NOTE: This step only applies to customers who received version (1) of the water pump brackets. Install the supplied stand-off and lock nut onto the OE horn bracket. Proceed by mounting that assembly, with the supplied M6 x 10mm bolt, to the water pump bracket as shown below.





## Edelbrock GM LS3 Supercharger System for 2008 and later Base Model Corvettes

### Installation Instructions

127. Re-install the horns using the OE nuts. Be sure to orient the horns so that there is slack in the horn's wiring harness. **Warning:** Do not mount the horns with the openings facing up, as they may accumulate condensation and cease working.



128. Use the supplied bit to drill a 15/64" hole in the passenger side of the upper radiator shroud according to the supplied template.



129. Use a 10mm socket and the four stock bolts to reinstall the upper radiator shroud then attach the relay using the supplied water pump wire harness to the upper radiator shroud using the supplied body pin. Open and close the hood to verify the relay clears the hood strut.



130. Route the intercooler water pump wire harness extending from the relay down to the intercooler water pump and plug in the connector.



131. Plug the male connector on the T-segment of the harness into the EVAP solenoid then plug the factory EVAP connector into the female connector on the T-segment.



132. Use a 10mm socket and the two stock bolts to reinstall the radiator fan.

133. Attach the radiator fan electrical connector then push the stock hoses back into the factory clips.

134. Install the short molded hose from the outlet of the intercooler water pump to the heat exchanger inlet. Secure the fittings with the supplied hose clamps.

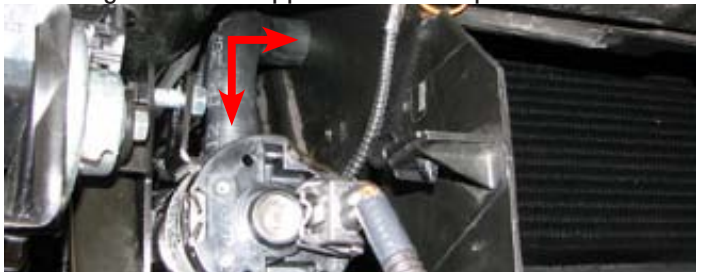



## Edelbrock GM LS3 Supercharger System for 2008 and later Base Model Corvettes

### Installation Instructions

135. Lower the heat exchanger hose assembly along the driver side of the radiator shroud.



136. Connect the heat exchanger hose assembly to the heat exchanger through the hole drilled in the shroud. Secure the fitting with a hose clamp supplied in Bag #2.



**NOTE:** Z51 oil cooler equipped vehicles must follow the steps below, others can skip ahead to step #137.

*i. Reinstall the oil cooler in the factory location using the stock nut to secure the new cooler bracket to the shroud.*

*ii. Reinstall the two stock bolts on the driver side that fasten the oil cooler to the radiator shroud.*

*iii. Reconnect the two oil lines to the oil cooler through the holes drilled in the shroud then refill the engine oil.*

137. Connect TMAP harness to TMAP sensor near rear of manifold.



138. Reinstall the battery and secure it with the stock hold down but DO NOT reconnect electrical terminals.

139. Use a 10mm socket and an extension bar to loosen the two nuts securing the fuse box.



140. Use a 7mm socket to remove the fuse box bolt located in the passenger side fender well.



141. Install long end of molded hose on intercooler reservoir outlet so that the hose will extend out and then turn down when the reservoir is held upright. Secure the hose with a hose clamp supplied in Bag #2.



142. Use a 10mm socket to install the brackets supplied in Bag #2 on the reservoir. The image above shows the installed orientation.



## Edelbrock GM LS3 Supercharger System for 2008 and later Base Model Corvettes

### Installation Instructions

143. Use a 10mm socket to loosen rear hood hold down latch bolt on passenger side fender.



144. Install intercooler reservoir by working molded hose down along the passenger side of the radiator to the water pump inlet and secure the hose on the pump fitting with a hose clamp supplied in Bag #2.

145. Slide intercooler reservoir brackets behind loosened fuse box nut and hood hold down latch bolt. Use a 10mm socket to torque them to 89 in-lbs.

146. Use a 10mm socket to mount fuse on fuse box stud.



147. Use a 13mm socket to attach the harness power wire to the main positive terminal.

148. Use a 10mm socket to attach the ground wire to the ground stud near the relay.



149. Reinstall the fender well fuse box bolt.

150. Install supplied 15/32" hose on brake booster and secure fitting with a hose clamp supplied in Bag #2.

151. Install the stock O-ring port gaskets in the supercharger manifold.



152. Install the supplied Manifold to EVAP Solenoid Hose on the manifold fitting below the hub snout.



153. Clear engine valley of any hoses, wires, tools, etc. Lay the intercooler-to-reservoir tank hose in the engine bay, routed along the firewall behind the oil pressure sensor, and connect it to the intercooler reservoir inlet, securing the fitting with a hose clamp supplied in Bag #2.





## Edelbrock GM LS3 Supercharger System for 2008 and later Base Model Corvettes

### Installation Instructions

**NOTE:** On 2008 model year vehicles, remove the water passage block-off located at the rear of the driver side cylinder head. Grind a 1/4" of material off the inside corner of the block-off at a 45° angle, then reinstall it. This will allow it to clear the supercharger.

154. Remove the tape covering the intake ports. Since two of the stock manifold bolt hole provisions in the cylinder heads break into the crankcase and are not used with this supercharger, install the two button head bolts supplied in Bag #3 in the front passenger side and rear driver side bolt holes to ensure a good seal. With the assistance of one or more people, lift the supercharger assembly onto the engine.

155. Tilt the manifold back slightly to install the small factory vacuum hose running from the driver side firewall fitting on the small fitting on the driver side of the air inlet and the brake booster hose onto the larger fitting then secure the brake hose with a clamp supplied in Bag #2.



156. Use a 10mm universal socket with an extension bar to install the eight intake manifold bolts following the torque sequence below. Torque the bolts to 4 ft-lbs in the first pass, then to 7.5 ft-lbs in the second.

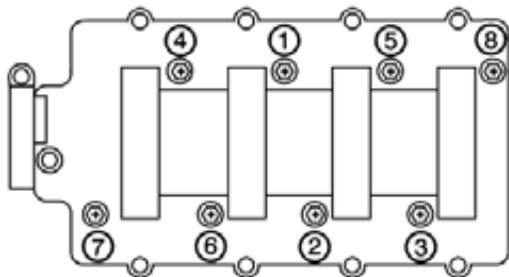

157. Use a 3/8" Fuel Line Removal Tool to remove the fuel input line from the firewall fitting.

158. Take the fuel injectors out of their boxes and remove their protective covers.

159. Apply O-ring lube to the upper injector seals, then slide the injectors into the rails so that the electrical connectors face away from the mounting flange.



160. Apply O-ring lube to the sealing ring of the four supplied fuel rail fittings. Use a 3/4" wrench to install the two straight hose fittings on the radiator side of each fuel rail then install the plug in the firewall end of the passenger side fuel rail and the U-shaped fitting on the firewall end of the driver side rail. Orient the fitting close to the injector, leaving room for the injector connector.

161. Connect Manifold to EVAP Solenoid hose to outer, green EVAP solenoid fitting and EVAP Solenoid to Firewall Hose to the inner black EVAP solenoid fitting. Route Solenoid to Firewall hose beneath hub snout and along driver side valve cover to firewall fitting and connect it.



162. Apply O-ring lube to the lower seals of each of the fuel injectors.

163. Attach the supplied fuel rail crossover line to the fitting on the passenger side fuel rail.



## Edelbrock GM LS3 Supercharger System for 2008 and later Base Model Corvettes

### Installation Instructions

164. Install the fuel rails by sliding the injectors down into the manifold provisions and applying pressure until the mounting holes in the rails line up with the manifold. Slide the crossover hose under the snout and air inlet of the supercharger as you install the passenger side rail then connect it to the driver side fuel rail fitting.

165. Use a 5mm Allen tool to install four 12mm fuel rail bolts supplied in Bag # 3 and torque them to 91 in-lbs.

166. Clip the heat exchanger hose assembly to both lower fittings at the front of the supercharger manifold.



167. Install the passenger side PCV hose on the valve cover fitting by clipping it on. 2008 vehicle owners will need to pull the quick connect fitting out of the supplied hose then slide the hose on the valve cover fitting.



168. Install the supplied driver side PCV hose to the 90° fitting below the air inlet on the supercharger.



169. Install the supplied fuel line from the firewall fitting to the U-shaped fitting on the driver side fuel rail.



170. Connect fuel injector electrical connectors.

171. Remove the driver side valve cover vacuum cap.





## Edelbrock GM LS3 Supercharger System for 2008 and later Base Model Corvettes

### Installation Instructions

172. Use a small flathead screwdriver to remove the wire covers at the back of the coil brackets. Note that you will need to separate the covers from the bracket, then split the two halves of the cover.



173. Tuck the fuel injector wiring harness and the EVAP Solenoid to Firewall Fitting Hose under driver side coil bracket then use a 10mm socket and the ten stock bolts to install both coil brackets on to the valve covers.

174. Attach the ignition coil connectors and spark plug wires to the coils.

175. Use a 10mm deep socket to remove the four stock coil cover ball studs from the valve covers.

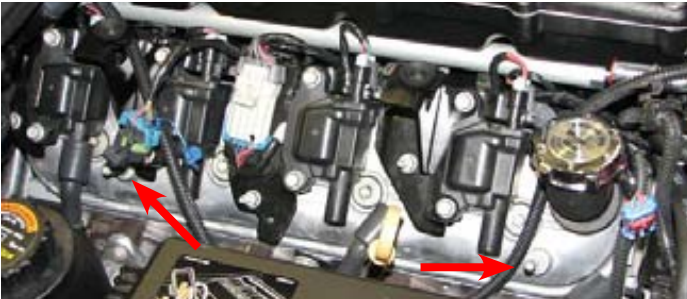

176. Remove the grommets from the stock coil covers.

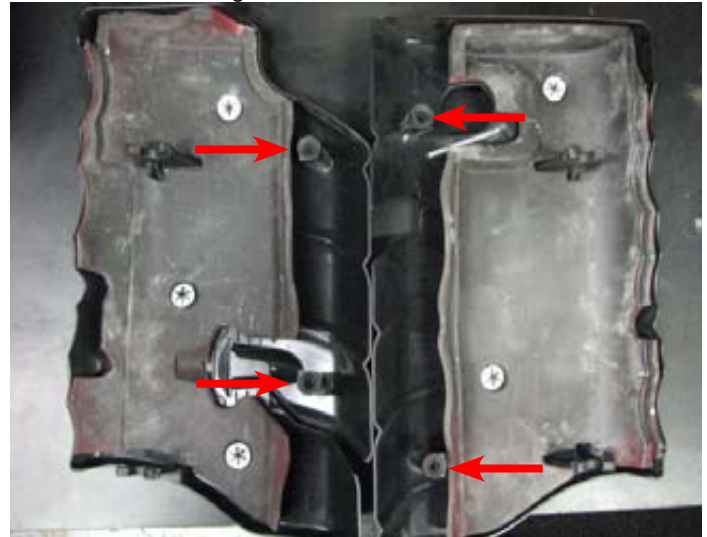

177. Install the stock grommets into the coil cover brackets supplied in Bag #6.



178. Use a 10mm socket to remove the bolts securing the #2, #3, #6 and #7 ignition coils.





## Edelbrock GM LS3 Supercharger System for 2008 and later Base Model Corvettes

### Installation Instructions

179. Install the coil cover brackets on top of the ignition coils, then use a 10mm socket to secure them with the stock bolts.

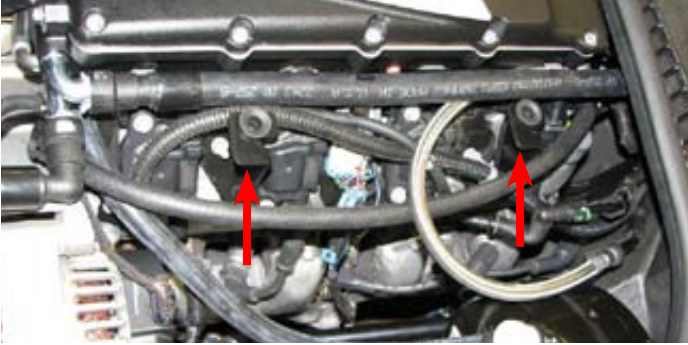

180. Tuck the wire harness tight against the fuel rails and route the driver side PCV hose on top of the driver side coil bracket and connect it to the valve cover fitting. 2008 vehicle owners will need to pull the quick connect fitting out of the supplied hose before attaching it to the valve cover fitting. Verify nothing will be pinched or damaged when the coil covers are installed.

181. Use a 7/16" deep socket to install the four ball studs supplied in Bag #6 onto the supplied coil covers.

182. Plug the OEM engine harness MAP sensor connector into the supplied MAP harness then route the harness to the vicinity of the air intake.



**NOTE:** 2008 model year Corvette owners will need to drain the engine coolant and remove the upper radiator hose to install the serpentine belt. Reattach the upper radiator hose and refill the coolant system once the belt has been installed.

183. Route the serpentine belt according to the diagram. Note that you must slide the belt around the bottom of the bracket to get the belt on the lower passenger side idler pulley.

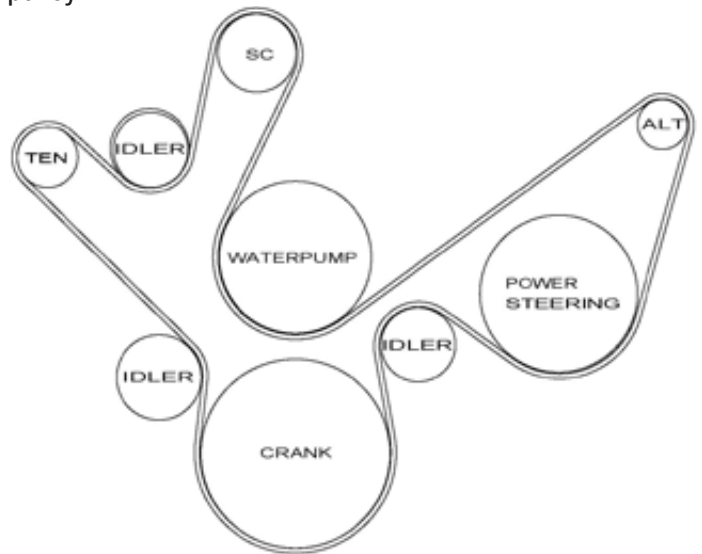

184. Use a breaker bar and a 16mm socket to push the tensioner enough to get the belt on, then double check the routing.

185. Use a 10mm socket, an extension bar, the four stock bolts and OEM seal to install the throttle body. Torque the bolts to 91 in-lbs.





## Edelbrock GM LS3 Supercharger System for 2008 and later Base Model Corvettes

### Installation Instructions

186. Connect ETC harness to the throttle body motor.

187. Connect the intercooler hose assembly to the two upper hose fittings at the front of the manifold.



188. Install the silicone inlet tube to the throttle body and secure it with a supplied worm clamp.



189. Install the grommet supplied in Bag #5 into the new air inlet tube.



190. Install the hose barb supplied in Bag #5 into the new air inlet tube.

191. Lower supplied air filter onto the radiator shroud.

192. Use a T20 Torx driver to remove the MAF sensor from the stock airbox.

193. Use a 3/32" Allen tool and bolts supplied in Bag #5 to install the stock MAF sensor in the new air inlet tube.



194. Route the supplied MAF wire harness near the driver side of the throttle body.

195. Install the two supplied grommets into the ears of the new air inlet tube.



196. Slide the nose of the air inlet tube into the air filter then hold the grommets in place with a socket as you tilt the air inlet tube down into the silicone tube and onto the locator pins.

197. Connect passenger side PCV hose to air inlet tube fitting and connect MAF harness to MAF sensor then connect OEM MAF connector to supplied MAF harness.





## Edelbrock GM LS3 Supercharger System for 2008 and later Base Model Corvettes

### Installation Instructions

198. Rotate the worm clamps so that the gears are on the driver side then secure the air inlet tube by tightening the worm clamps on the air filter and the silicone hose.

199. Use a 5/8" wrench to install the coil cover stands supplied in Bag #6 onto the valve covers.



200. Use a 10mm socket to reconnect the positive battery terminal.

201. Use a 10mm socket to reconnect the negative battery terminal.

202. Remove intercooler reservoir cap and fill intercooler system with a 50/50 blend of water and coolant.

203. Refill the power steering reservoir with power steering fluid.

204. Reinstall the front fascia and reconnect the fog lamp and indicator light electrical connectors.

205. Secure the front fascia with the stock hardware, including the four bolts under the hood, the two nuts on each fender, the five bolts and two nuts on the underside and the four body pins that clip into the radiator shroud. Refer to steps #5 - #11 for fastener locations.

206. Reattach the front valances using the three stock screws and one body pin on each side.

207. Secure the front inner fender wells with the stock fasteners.

208. Reinstall the front wheels and torque the lug nuts in a crossing pattern to 100 ft-lbs.

---

**If you have yet to flash your ECU, then proceed with steps 209 - 222, otherwise disregard them.**

209. Confirm that you have the latest calibration by checking the Edelbrock website

210. Put the car into Acc mode by pressing and holding the start button on the steering column.

211. Connect the supplied PCM cable to the OBD-II connector located below the steering wheel in the passenger compartment.

212. Use directional pad to highlight Program Vehicle option and press Select button.

213. Use directional pad to highlight Preprogrammed Tune option and press Select button.

214. Read disclaimer then press Select to continue.

215. Verify ignition is in the 'Key On' position but that the engine is not running then press Select.



## Edelbrock GM LS3 Supercharger System for 2008 and later Base Model Corvettes

### Installation Instructions

216. Use directional pad to highlight your vehicle and transmission combination then press Select.

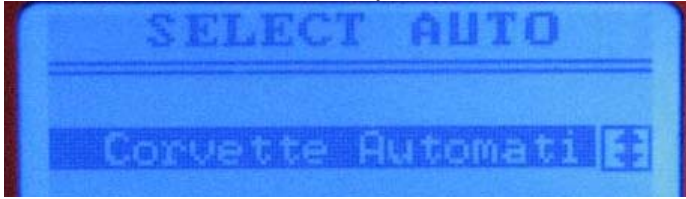

217. Use directional pad to highlight your vehicle and transmission combination then press Select, again.

218. Use directional pad to highlight Begin Program then press Select.

219. Vehicles equipped with a manual transmission will have three separate operations take place during this step, while vehicles with an automatic transmission will have five. Completion of each operation will cause the progress bar to reset to zero.

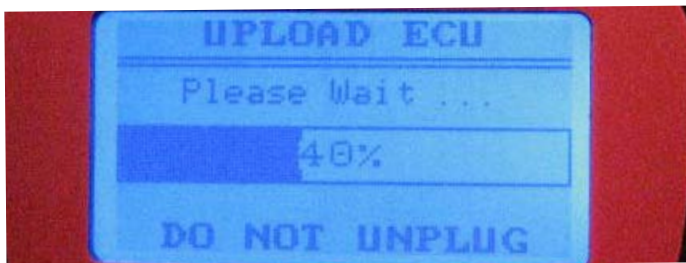

**DO NOT unplug the programmer until prompted.**

220. Turn the car off when prompted to do so by the handheld programmer.

221. Read parting message from programmer then press Select to continue.

222. Unplug the programmer cable from the OBD-II port.

223. Start the car and allow it to idle while closely inspecting the engine bay for any fuel or coolant leaks.

224. Remove the engine oil dipstick.

225. Slide the supplied grommet into the passenger side coil cover hole and lubricate it with silicone spray. Install the passenger side coil cover by sliding the grommet down and around the dipstick tube and pressing the ball studs into the bracket grommets.



226. Return the dipstick to the dipstick tube.

227. Install the driver side coil cover by sliding it into place and pressing the ball studs into bracket grommets.

Congratulations on the installation of your new Edelbrock E-Force Supercharger System. If you have any questions, please call our Technical Support hotline and one of our technicians will be happy to assist you.